

Action Figure Model Kit Figurine prête à monter Figura para armar

AGE:
EDAD: **8+**
83178 Asst.

ZOIDS

Matrix Dragon™

Dragon Type Type dragon Tipo dragón

ZOIDS® Leoblaze™, Nightwise™, Mosasledge™, and Unenlagia™ units (each sold separately) are needed to build Matrix Dragon™.

Les prêts-à-monter ZOIDS Leoblaze, Nightwise, Mosasledge et Unenlagia (vendus séparément) sont requis pour construire Matrix Dragon.

Se necesitan las figuras para armar ZOIDS Leoblaze, Nightwise, Mosasledge y Unenlagia (vendidas por separado) para construir Matrix Dragon.

Assembly required. No glue or paint needed.
Assemblage requis, sans colle ni peinture.
Requiere armado, sin pegamento ni pintura.

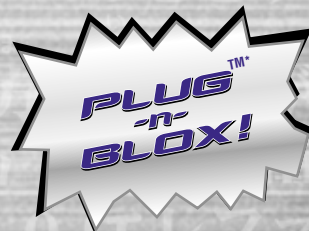

ゾイド

ZBuilders™

LEOBLAZE™

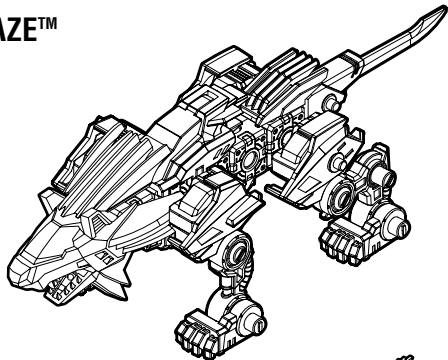

NIGHTWISE™

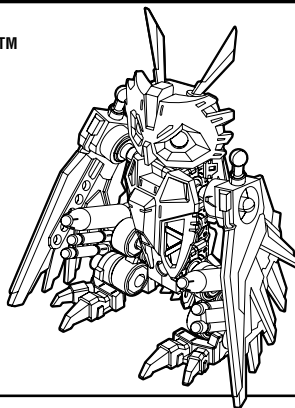

MOSASLEDGE™

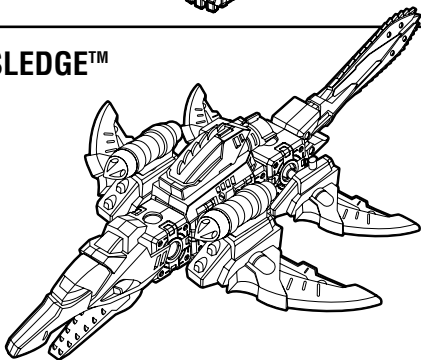

UNENLAGIA™

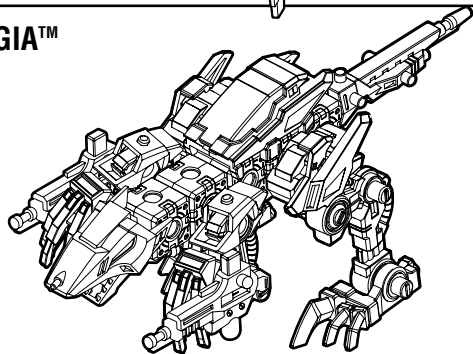

ZOIDS® Leoblaze™, Nightwise™, Mosasledge™, and Unenlagia™ units (each sold separately) are needed to build Matrix Dragon™.
Les prêts-à-monter ZOIDS Leoblaze, Nightwise, Mosasledge et Unenlagia (vendus séparément) sont requis pour construire Matrix Dragon.
Se necesitan las figuras para armar ZOIDS Leoblaze, Nightwise, Mosasledge y Unenlagia (vendidas por separado) para construir Matrix Dragon.

NOTES:

- Please read instructions completely before assembling kit. Save instructions for future reference.
- Easy snap-together fit! No glue is needed to assemble this kit.
- Remove plastic parts from frames according to the instructions. When removing parts, trim off any excess plastic using scissors or other suitable tool.
- Each frame is lettered, and each individual part is also marked with its part number and letter. Please follow the letters and numbers carefully and make sure you are assembling the right parts.
- Runner Frame J parts are identical in all Z-Builders™ kits.
- Discard plastic bags immediately.
- This kit can be disassembled if necessary.
- When kit is completed, apply the labels anywhere you like.

REMARQUES:

- Lis la totalité des instructions avant d'assembler le prêt-à-monter et garde-les pour référence ultérieure.
- Les pièces s'emboîtent très facilement et l'assemblage ne nécessite pas de colle.
- Retire les pièces de plastique de leurs cadres, selon les directives. Ébarbe les pièces à l'aide de ciseaux ou de tout autre outil approprié.
- Chacun des cadres est identifié par une lettre et chaque pièce comporte une lettre et un chiffre. Apparie soigneusement lettres et chiffres pour un assemblage adéquat.
- Les pièces J des cadres sont identiques pour tous les prêts-à-monter Z-Builders.
- Jette les sacs de plastique.
- Le prêt-à-monter peut être démonté si nécessaire.
- L'assemblage une fois terminé, applique les autocollants là où tu le veux.

NOTAS:

- Lee las instrucciones en su totalidad antes de armar la figura y guárdalas para referencia futura.
- Las piezas encajan muy fácilmente y no se necesita pegamento para armar el juguete.
- Retira las piezas de plástico de sus marcos siguiendo las indicaciones. Recorta el exceso de plástico de las piezas usando tijeras u otra herramienta apropiada.
- Cada marco está identificado con una letra y cada pieza viene marcada con una letra y un número. Combina con cuidado las letras con los números para armar correctamente las piezas.
- Las piezas J de los marcos son idénticas para todas las figuras para armar Z-Builders.
- Deshazte de las bolsas plásticas.
- La figura para armar puede ser desarmada si fuera necesario.
- Una vez armada la figura, coloca las etiquetas a donde quieras.



Be sure to assemble ring caps as shown.
Les capuchons de l'anneau doivent être insérés comme indiqué.
Las tapitas del anillo deben insertarse tal como se indica.



Align octagonal piece as shown.
Aligner les sections octogonales, comme indiqué.
Alinea la pieza octagonal tal como se indica.

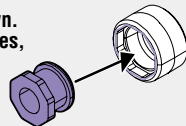

Using the Extractor Tool:
Pour utiliser l'extracteur:
Para usar el extractor:

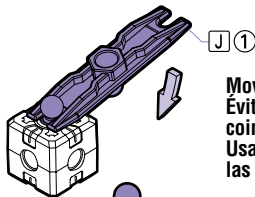

Move tool gently to loosen tight joint parts.
Éviter de forcer pour extraire les chevilles coincées.
Usa la herramienta sin forzar para aflojar las clavijas apretadas.

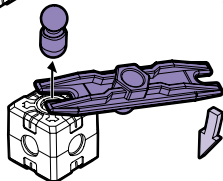

Extractor may not loosen some joints.
L'extracteur peut ne pas extraire toutes les chevilles.
Es posible que el extractor no pueda aflojar todas las clavijas.

LEOBLAZE™

Some parts may not be necessary for assembly.
 Certaines des pièces ne servent pas à l'assemblage.
 Algunas piezas no son necesarias para el armado.

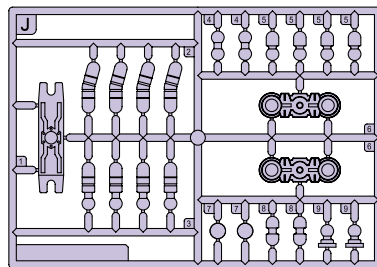
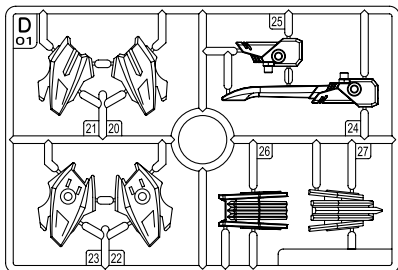
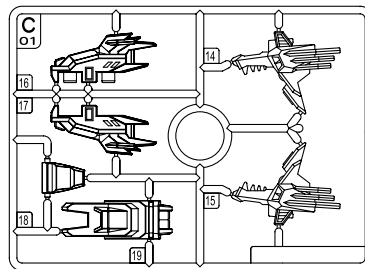
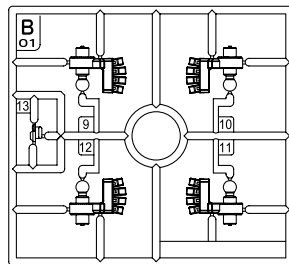
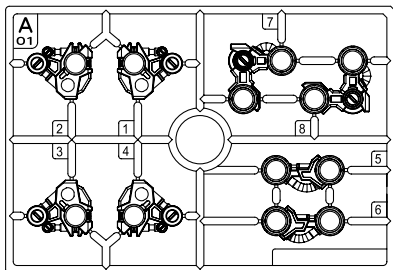

Cover B
 Couverture B
 Cubierta B



Cover A
 Couverture A
 Cubierta A



Blocks (4)
 4 blocs
 4 bloques



Core block
 Bloc central
 Bloque central



Ring Caps (12)
 12 capuchons d'anneaux
 12 tapitas de anillos



Pilot
 Pilote
 Piloto

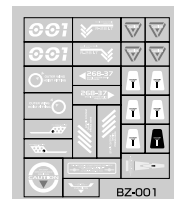

Label sheet
 Feuille d'autocollants
 Hoja de etiquetas

UNENLAGIA™

Some parts may not be necessary for assembly.
 Certaines des pièces ne servent pas à l'assemblage.
 Algunas piezas no son necesarias para el armado.

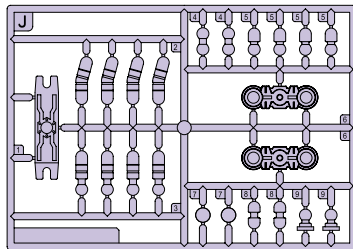
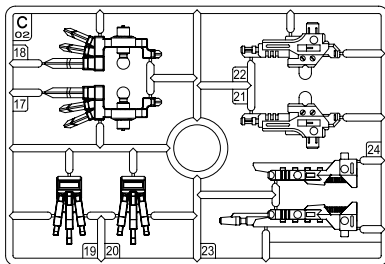
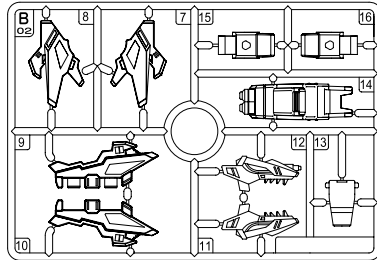
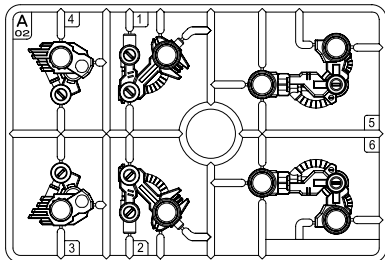

Cover A
 Couvercle A
 Cubierta A



Cover B
 Couvercle B
 Cubierta B



Pilot
 Pilote
 Piloto

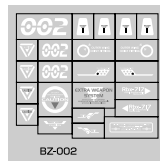

Label sheet
 Feuille d'autocollants
 Hoja de etiquetas



Blocks (4)
 4 blocs
 4 bloques



Core block
 Bloc central
 Bloque central



Ring Caps (8)
 8 capuchons d'anneaux
 8 tapitas de anillos

MOSASLEDGE™

Some parts may not be necessary for assembly.
 Certaines des pièces ne servent pas à l'assemblage.
 Algunas piezas no son necesarias para el armado.

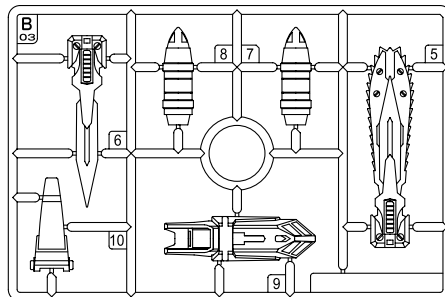
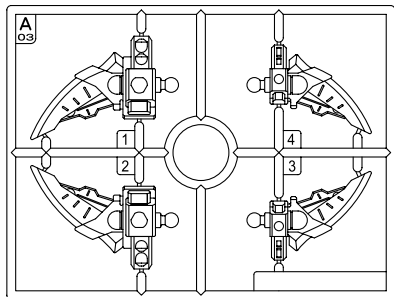

Cover B
 Couverture B
 Cubierta B



Cover A
 Couverture A
 Cubierta A

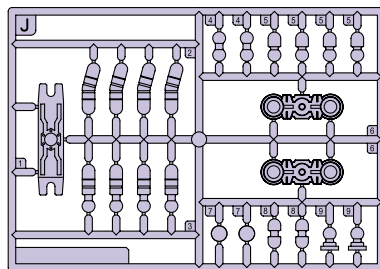
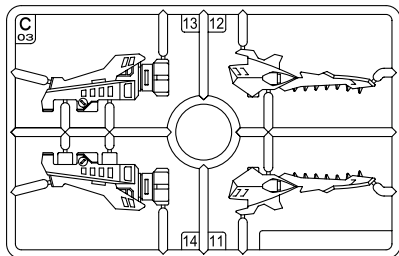

Pilot
 Pilote
 Piloto



Ring Caps (3)
 3 capuchons d'anneaux
 3 tapitas de anillos



Core block
 Bloc central
 Bloque central

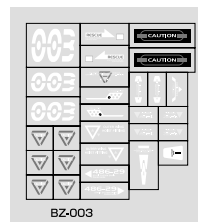

Label sheet
 Feuille d'autocollants
 Hoja de etiquetas

NIGHTWISE™

Some parts may not be necessary for assembly.
 Certaines des pièces ne servent pas à l'assemblage.
 Algunas piezas no son necesarias para el armado.

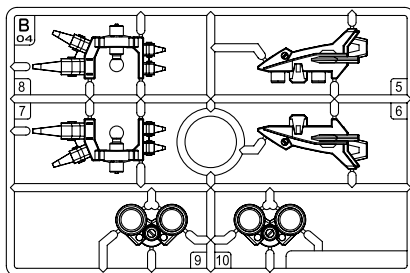
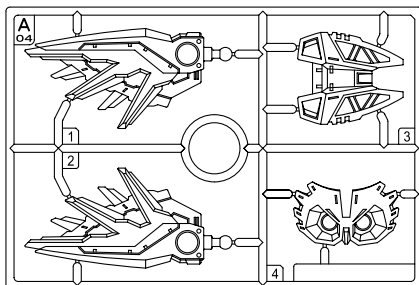

Cover
 Couverture
 Cubierta



Lens
 Lentille
 Lente



Pilot
 Pilote
 Piloto

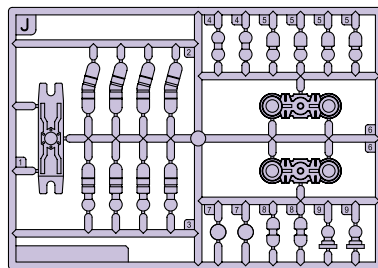
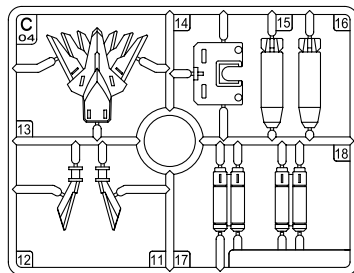

Blocks (3)
 3 blocs
 3 bloques



Core block
 Bloc central
 Bloque central



Ring Caps (6)
 6 capuchons d'anneaux
 6 tapitas de anillos

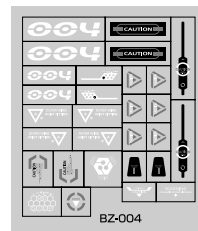

Label sheet
 Feuille d'autocollants
 Hoja de etiquetas



Assembling the head.
Assemblage de la tête.
Armado de la cabeza.

Unenlagia™ Cover A
Couvercle A d'Unenlagia
Cubierta A de Unenlagia

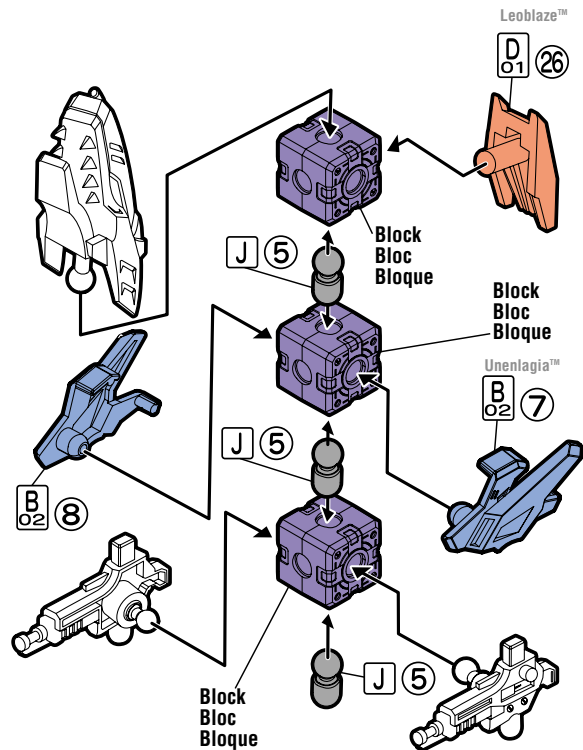
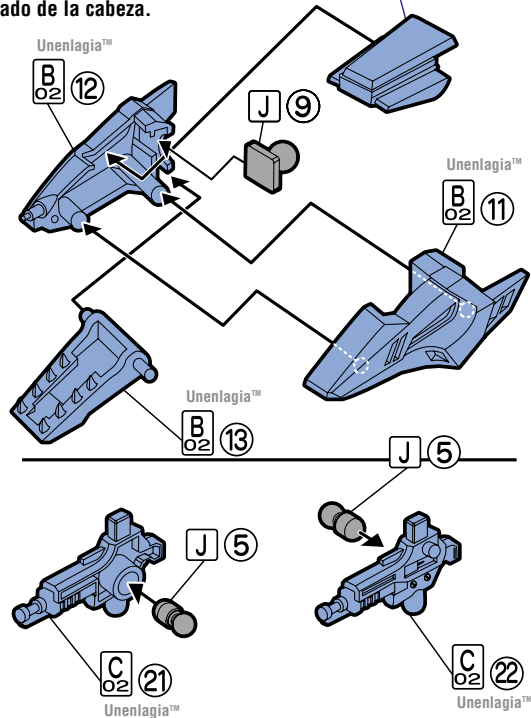

2

Assembling the right arm.
 Assemblage du bras droit.
 Armado del brazo derecho.

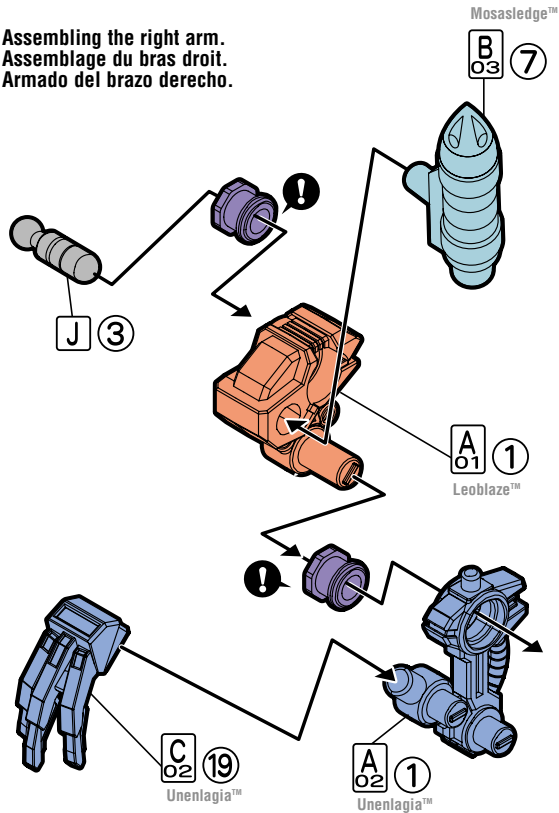

Assembling the left arm.
 Assemblage du bras gauche.
 Armado del brazo izquierdo.

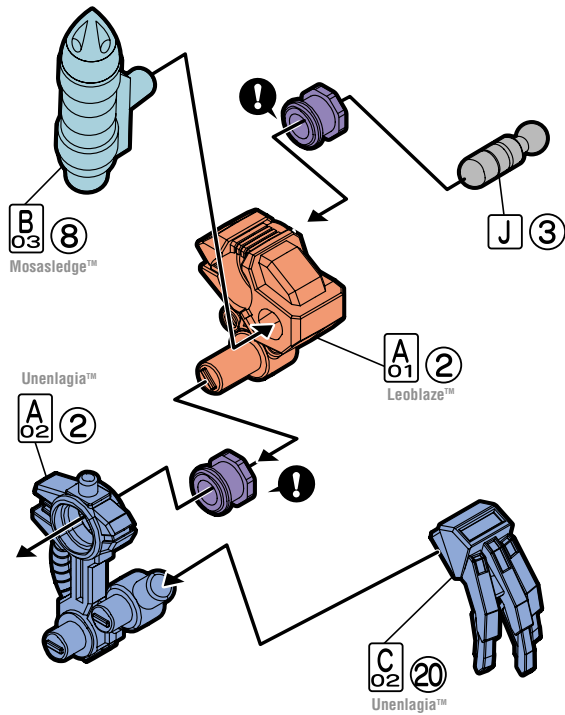

3

Assembling the left leg: Step 1.
Assemblage de la patte gauche: Étape 1.
Armado de la pata izquierda: Paso 1.

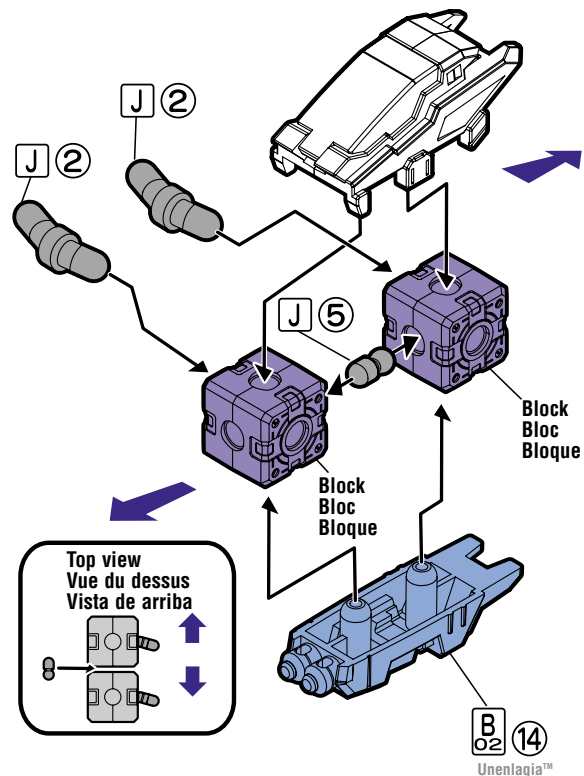
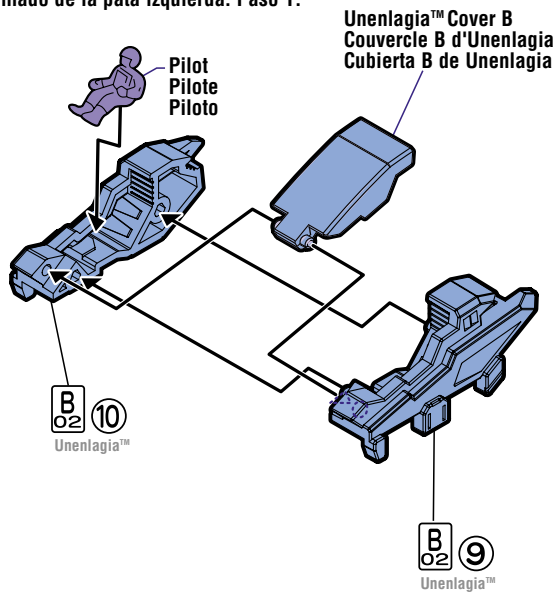

Q

Assembling the left leg: Step 2.
 Assemblage de la patte gauche: Étape 2.
 Armado de la pata izquierda: Paso 2.

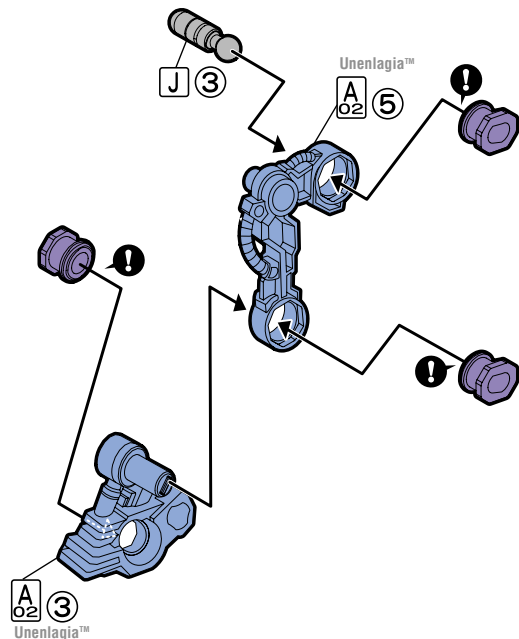
**S**

Assembling the left leg: Step 3.
 Assemblage de la patte gauche: Étape 3.
 Armado de la pata izquierda: Paso 3.

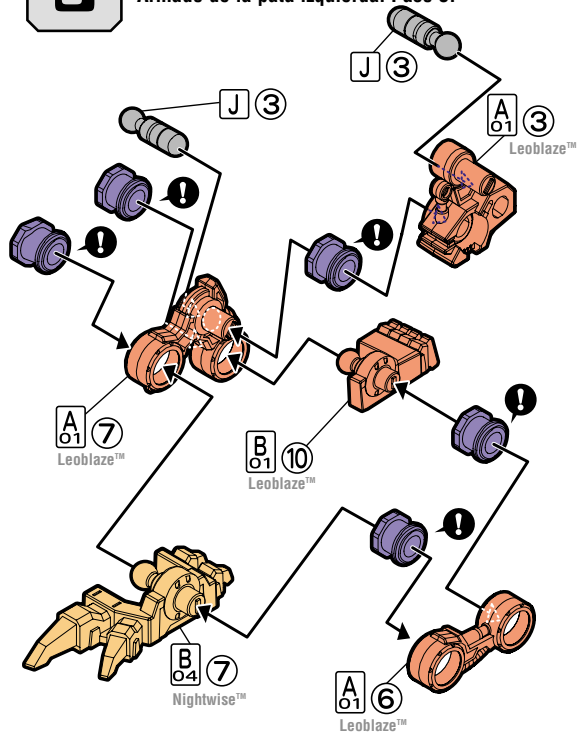

6

Assembling the left leg: Step 4.
Assemblage de la patte gauche: Étape 4.
Armado de la pata izquierda: Paso 4.

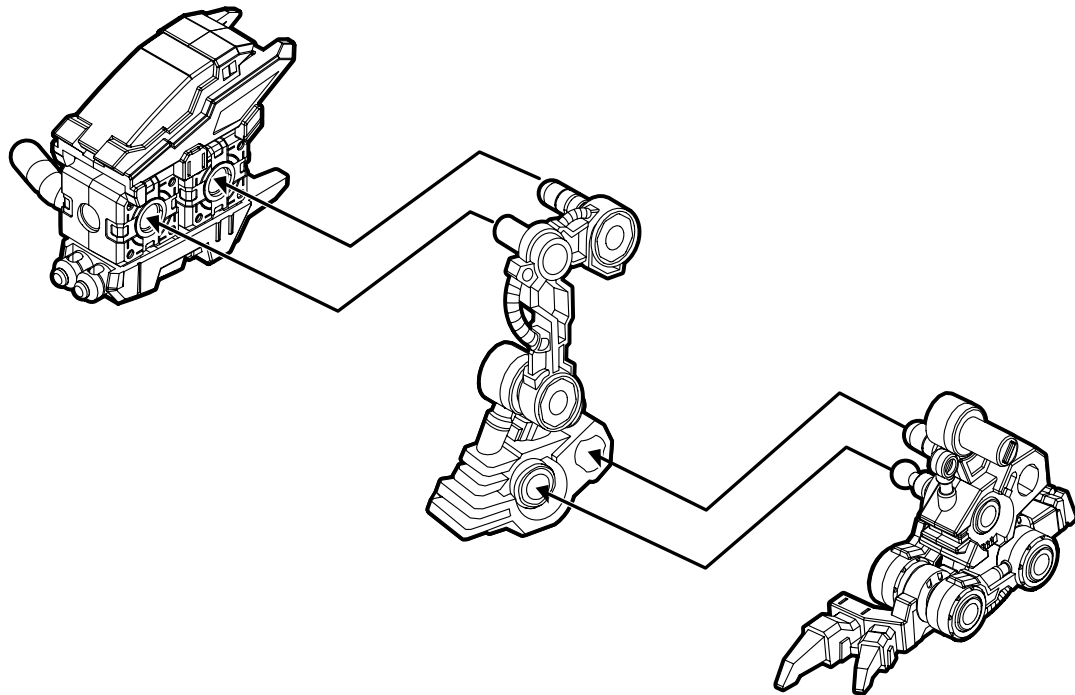

8

Assembling the right leg: Step 2.
 Assemblage de la patte droite: Étape 2.
 Armado de la pata derecha: Paso 2.

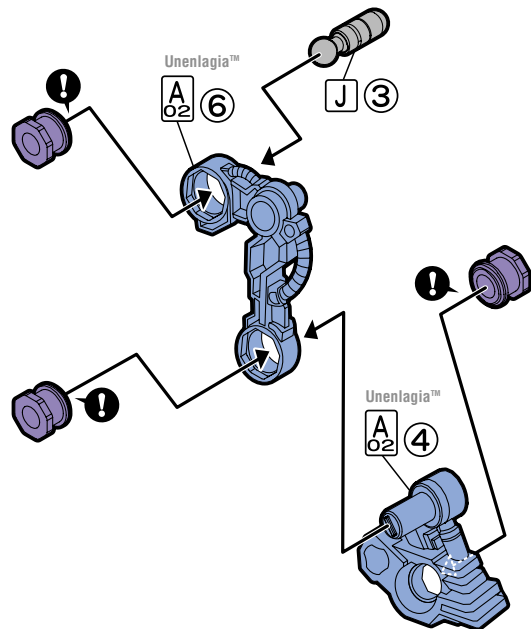

9

Assembling the right leg: Step 3.
 Assemblage de la patte droite: Étape 3.
 Armado de la pata derecha: Paso 3.

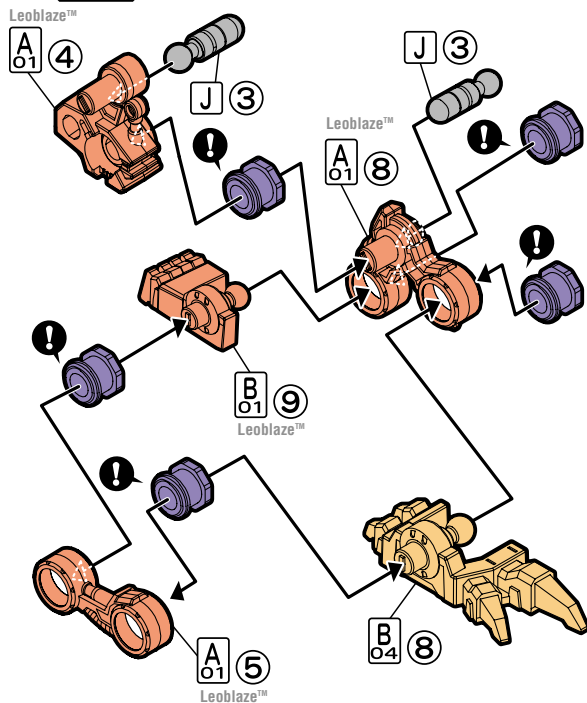



Assembling the right leg: Step 4.
Assemblage de la patte droite: Étape 4.
Armado de la pata derecha: Paso 4.

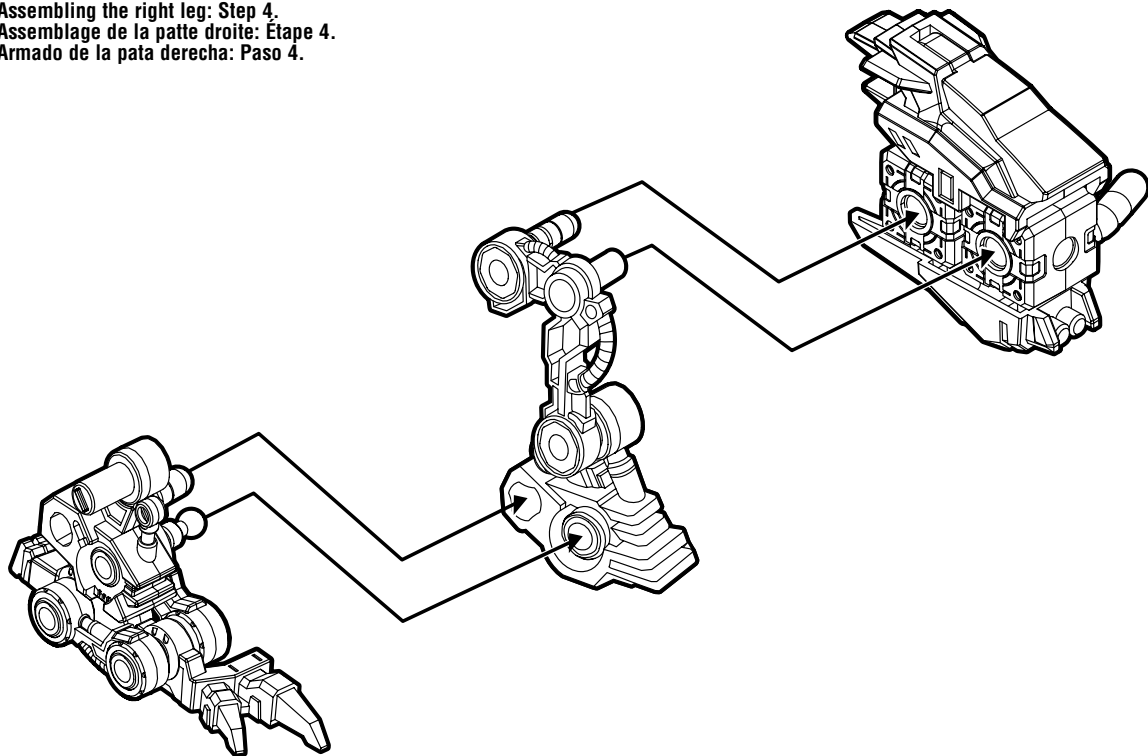

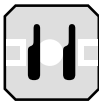

Assembling the wings.
Assemblage des ailes.
Armado de las alas.

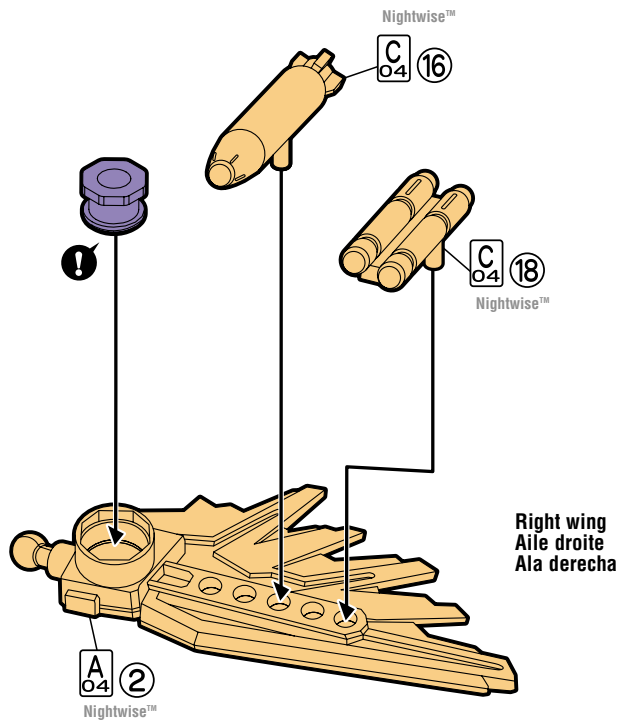
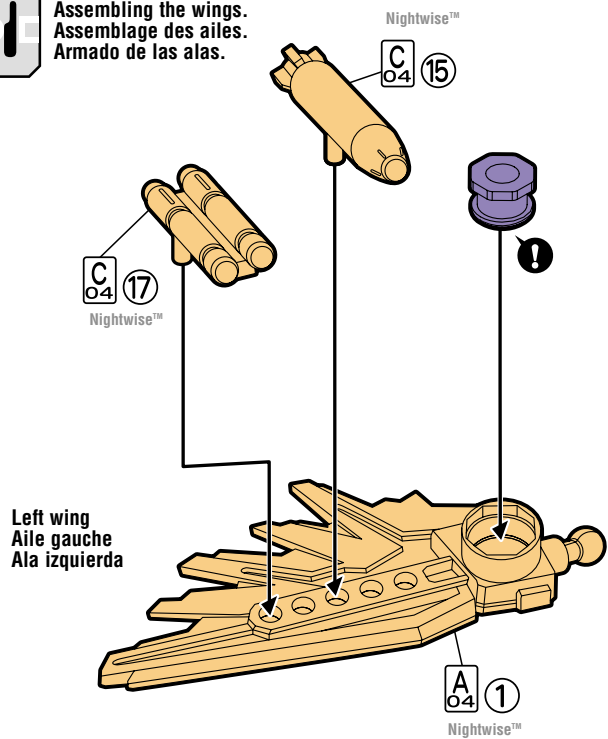

12

Assembling the body: Step 1.
Assemblage du corps: Étape 1.
Armado del cuerpo: Paso 1.

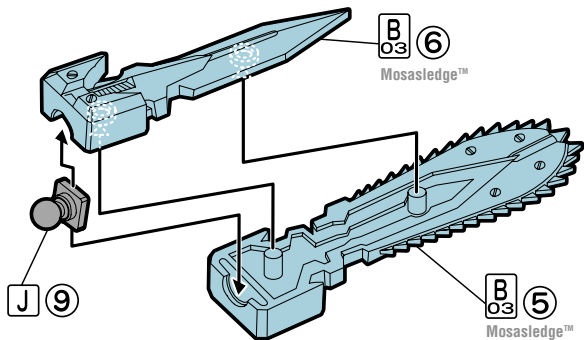
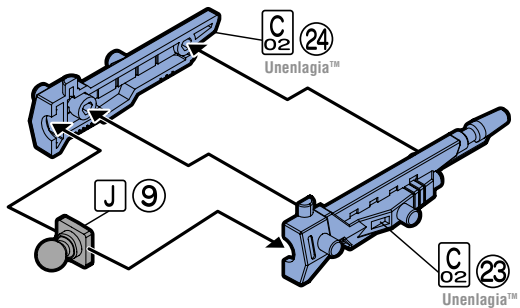

Mosasledge™ Cover B
Couvercle B de Mosasledge
Cubierta B de Mosasledge

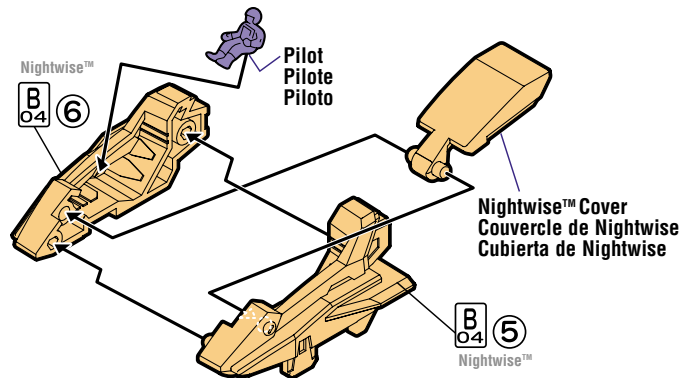
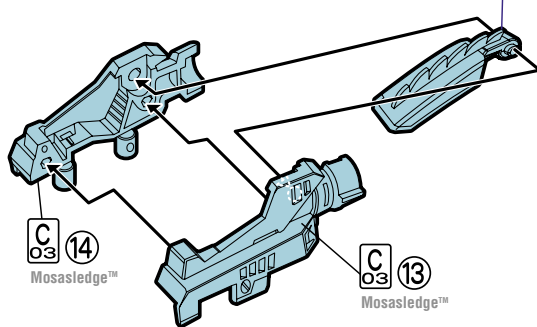

13

Assembling the body: Step 1.
Assemblage du corps: Étape 1.
Armado del cuerpo: Paso 1.

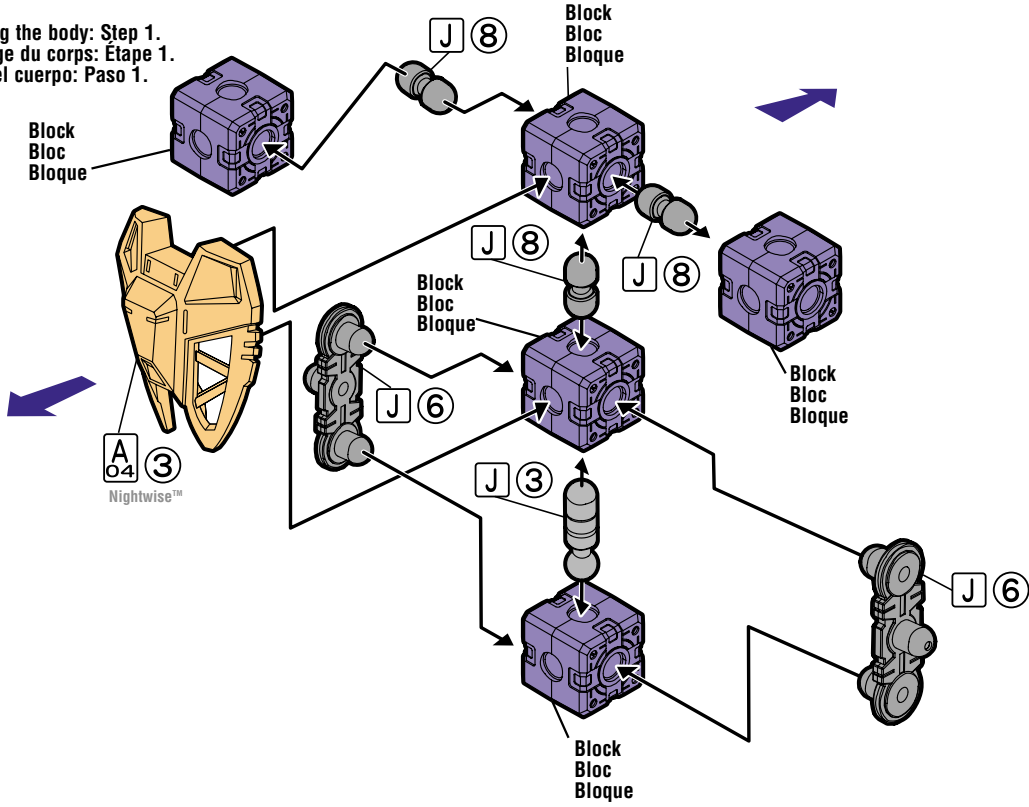

14

Assembling the body: Step 3.
Assemblage du corps: Etape 3.
Armado del cuerpo: Paso 3.

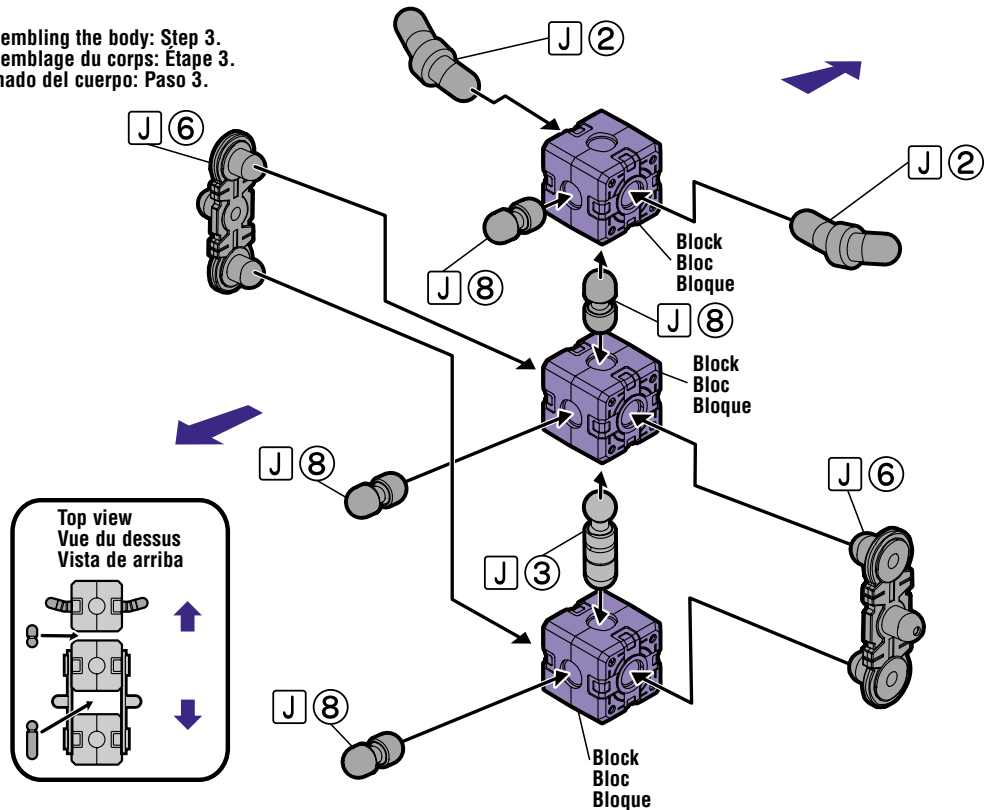

15

Assembling the body: Step 4.
Assemblage du corps: Étape 4.
Armado del cuerpo: Paso 4.

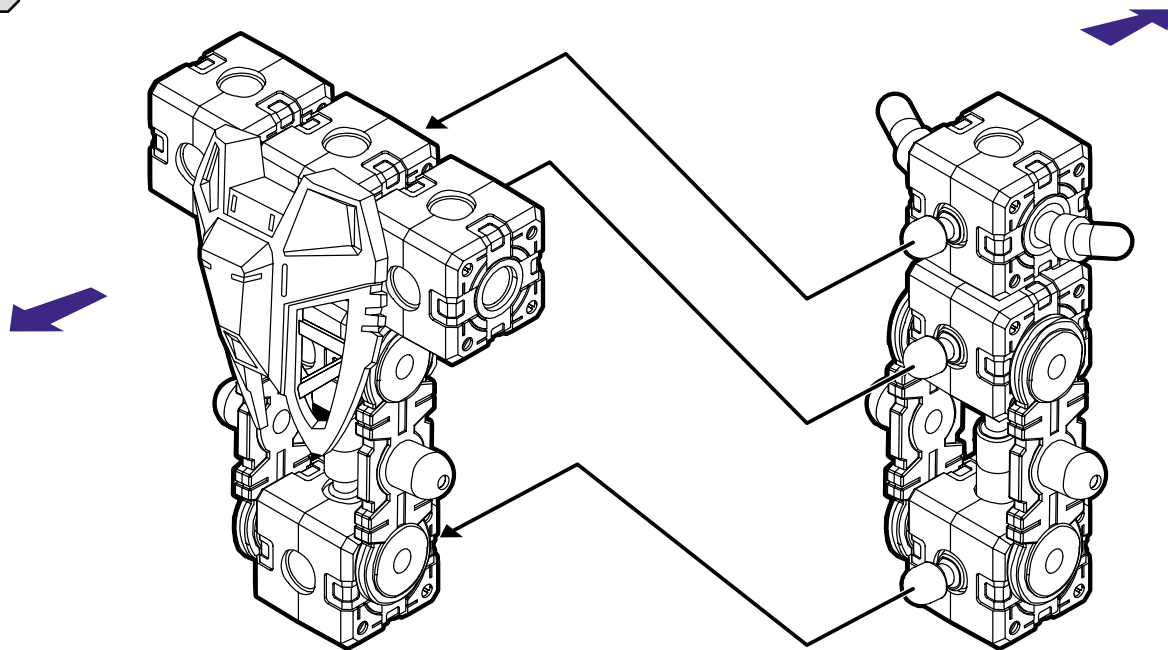

16

Assembling the body: Step 5.
Assemblage du corps: Etape 5.
Armado del cuerpo: Paso 5.

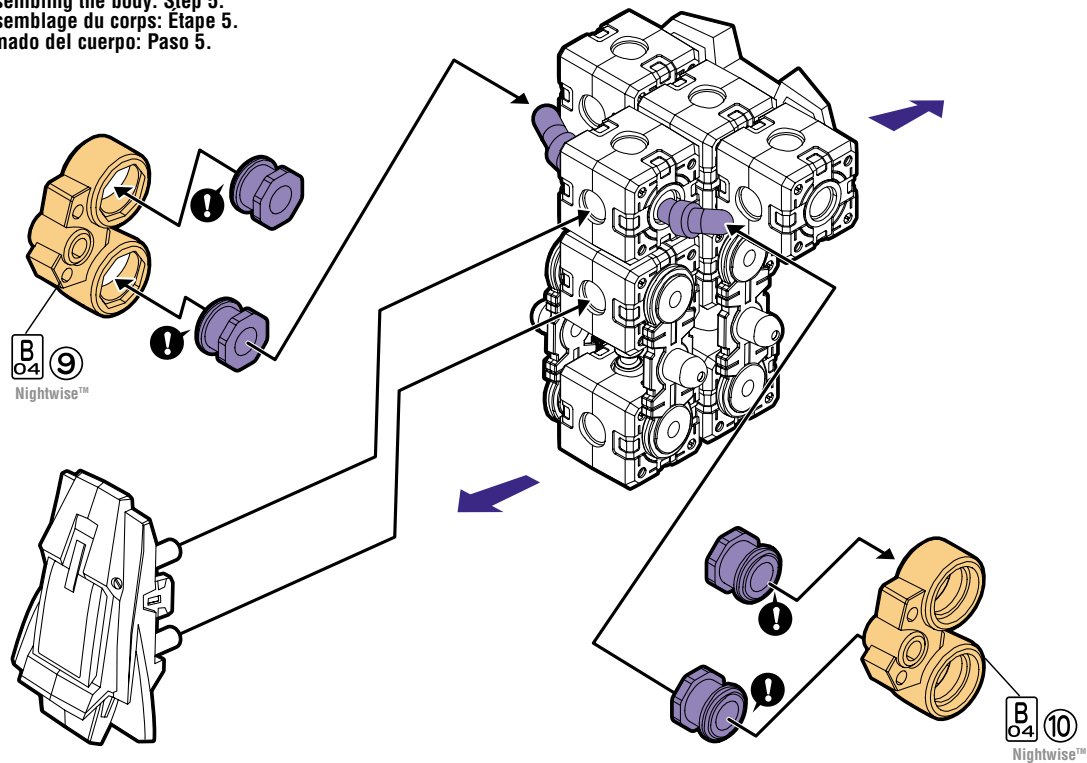

17

Assembling the body: Step 6.
Assemblage du corps: Étape 6.
Armado del cuerpo: Paso 6.

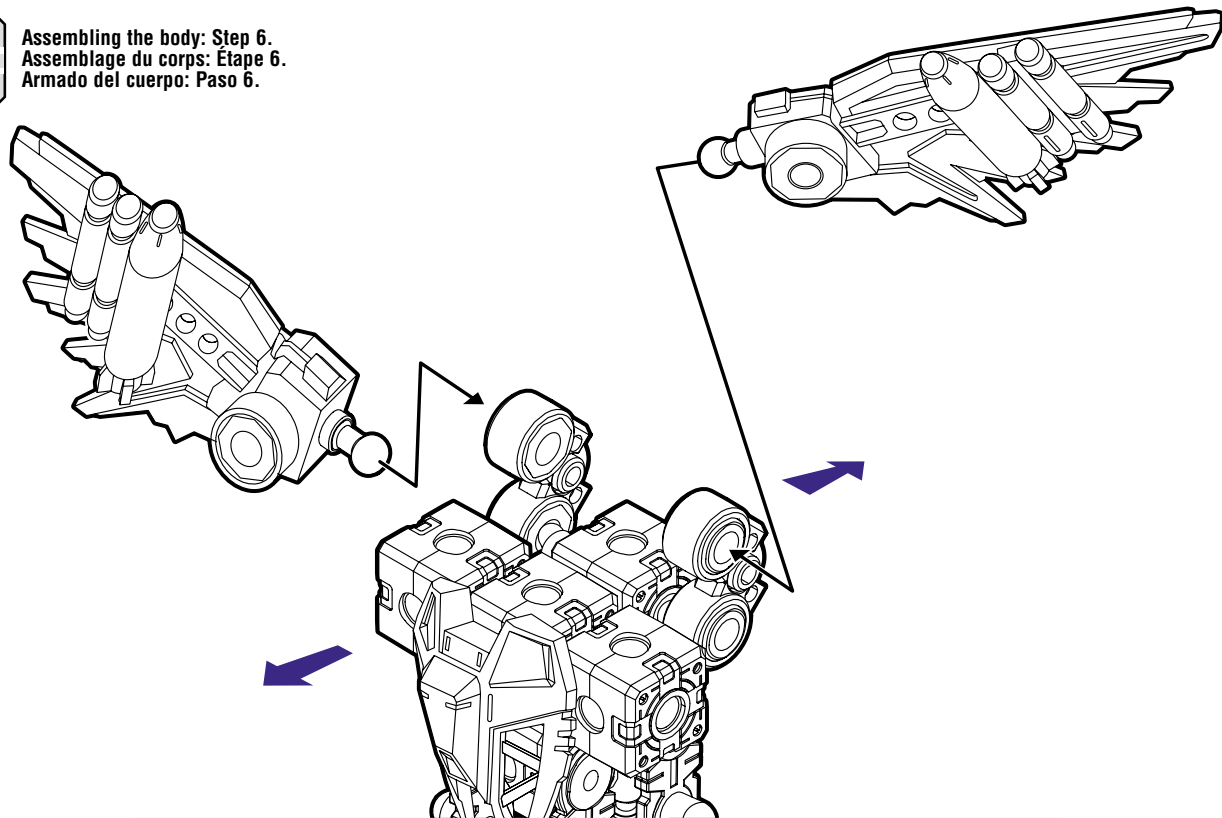

18

Assembling the body: Step 7.
Assemblage du corps: Étape 7.
Armado del cuerpo: Paso 7.

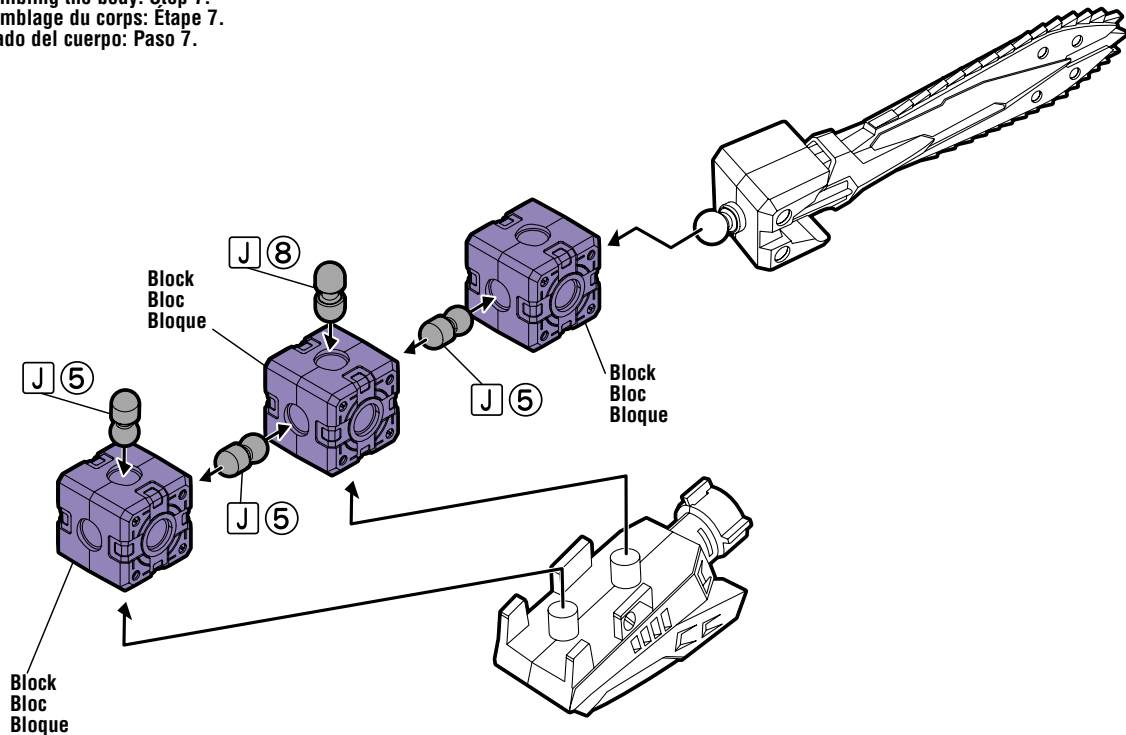

19

Assembling the body: Step 8.
Assemblage du corps: Étape 8.
Armado del cuerpo: Paso 8.

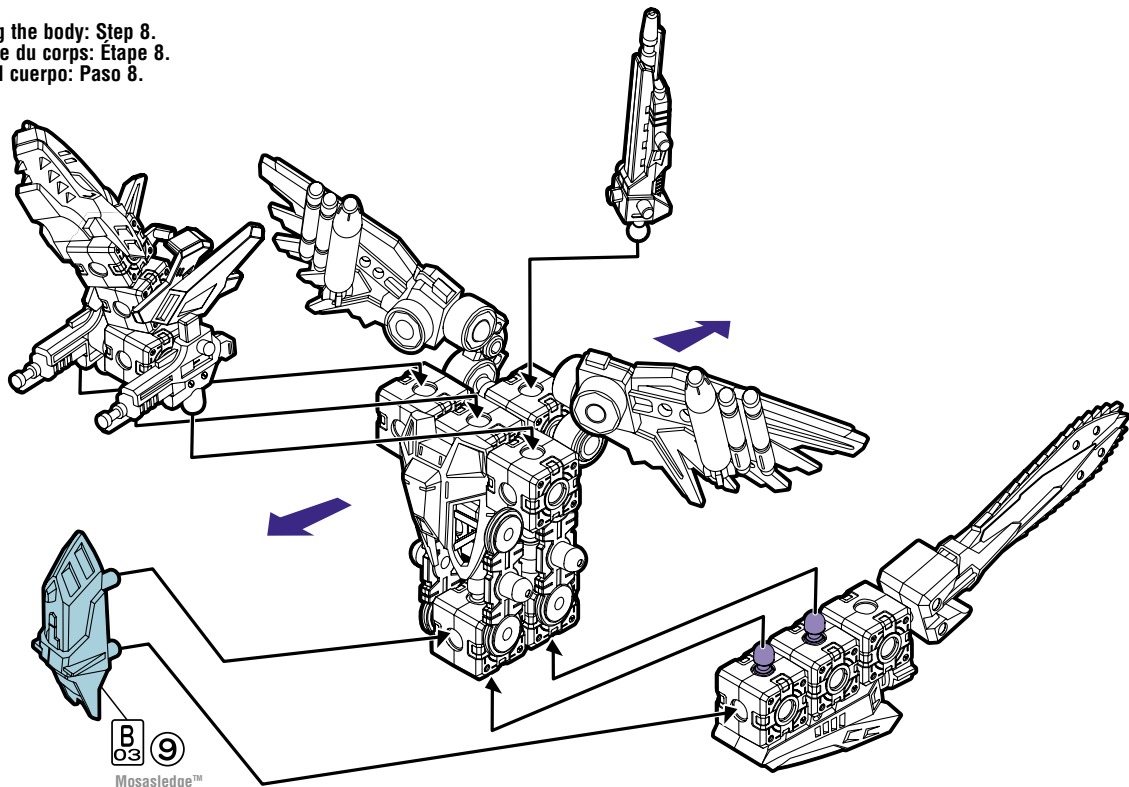

20

Assembling the body: Step 9.
Assemblage du corps: Etape 9.
Armado del cuerpo: Paso 9.

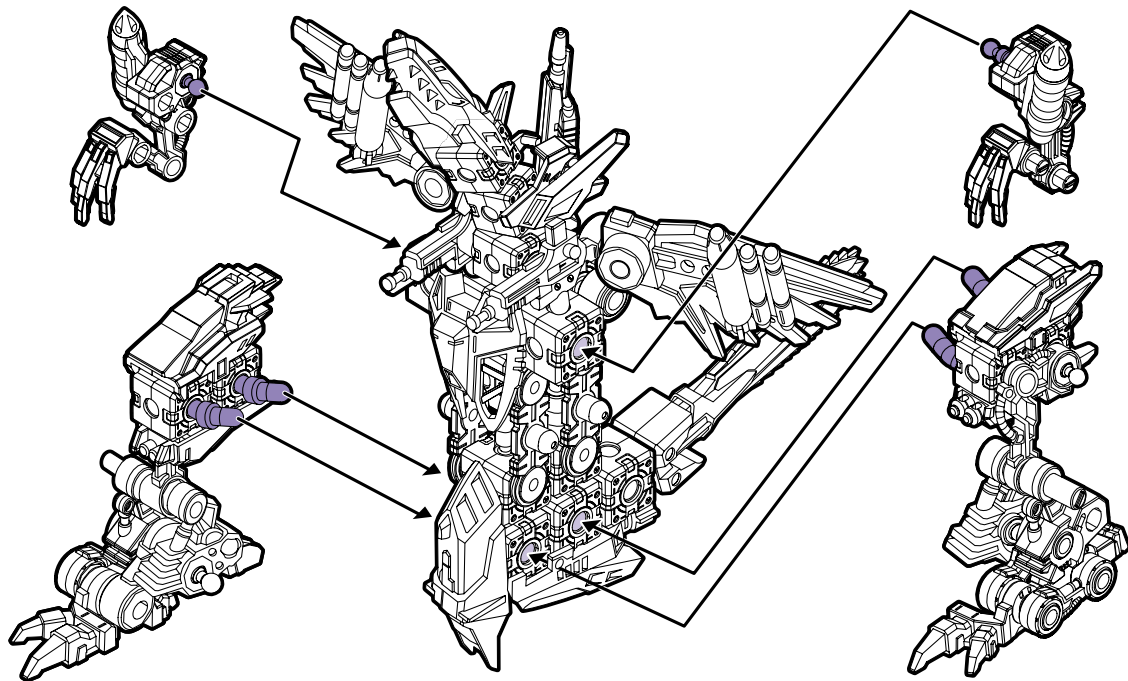

21

Complete!
Terminé!
¡Completo!

The unit may not stand in balance depending on the parts or the pose.

La figurine risque de perdre l'équilibre, dépendamment des pièces utilisées ou de sa position.

Es posible que la figura no quede estable dependiendo de las piezas utilizadas o de su pose.

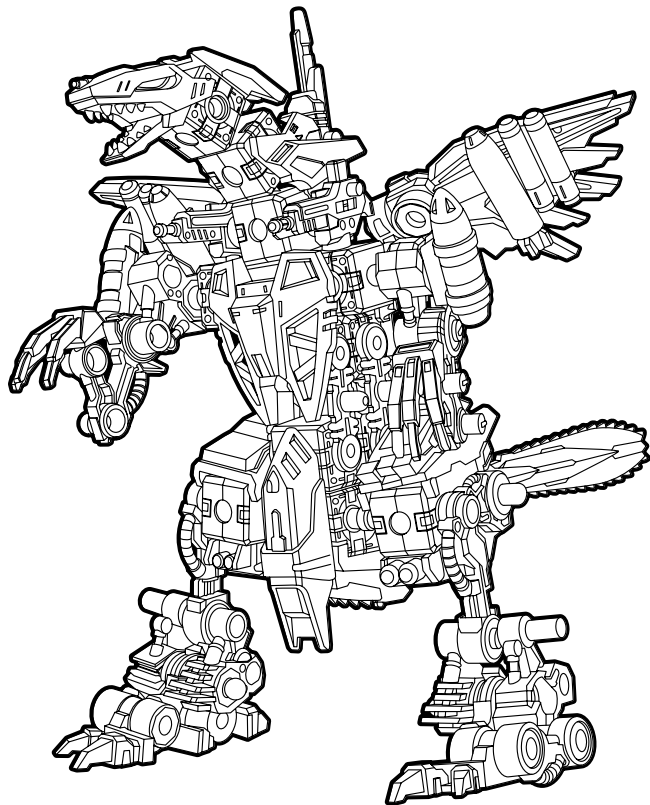

Do not hold by tail or other parts indicated in the illustration.

Ne tiens pas la figurine par la queue ou les autres pièces illustrées ci-contre.

No sostengas la figura por la cola o por las otras piezas ilustradas aquí.

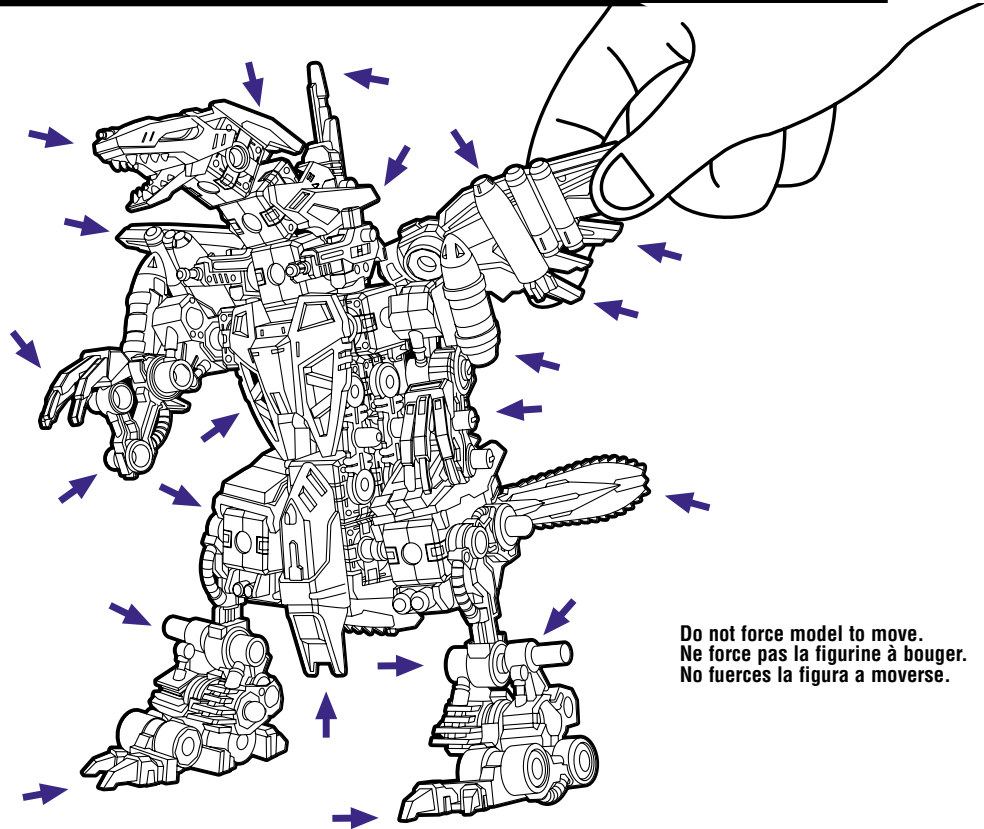

**Do not force model to move.
Ne force pas la figurine à bouger.
No fuerces la figura a moverse.**



Product and colors may vary. Le produit et les couleurs peuvent varier. El producto y los colores pueden variar.

©1983-2002 TOMY ©1999-2001 SHO-PRO • MBS • JRK All Rights Reserved. ZOIDS is a trademark of TOMY Company, Ltd. and used under license. Distributed by Hasbro. All Rights Reserved.

®* and/or ™* & © 2002 Hasbro. ® denotes Reg. U.S. Pat. & TM Office.

Hasbro Canada, 2350 de la Province, Longueuil, QC, Canada J4G 1G2.

Imp.: Servicios Mexicanos de Manufactura S. de R.L. de C.V. km 17,5 Carr. Tlalnepantla-Cuautitlán, Loma Bonita, Cuautitlán Izcalli, Edo. de Méx. C.P. 54756 R.F.C.: SMM-990712-156. Centro de Servicio para México: Tel.: 5872-9483 y para el interior de la República 01-800-712-6225.

Free Manuals Download Website

<http://myh66.com>

<http://usermanuals.us>

<http://www.somanuals.com>

<http://www.4manuals.cc>

<http://www.manual-lib.com>

<http://www.404manual.com>

<http://www.luxmanual.com>

<http://aubethermostatmanual.com>

Golf course search by state

<http://golfingnear.com>

Email search by domain

<http://emailbydomain.com>

Auto manuals search

<http://auto.somanuals.com>

TV manuals search

<http://tv.somanuals.com>