

# TRANSFORMERS



**AGES 5+**  
83743/15200 Asst.

**JOLT**  
DECEPTICON

NOTE: Some parts are made to detach if excessive force is applied and are designed to be reattached if separation occurs. Adult supervision may be necessary for younger children.

TRANSFORMERS.COM

## CHANGING TO ROBOT

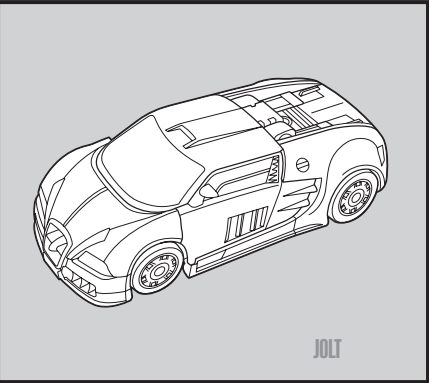

### TURBO MODE

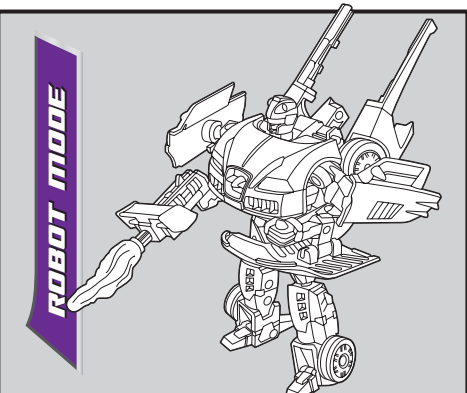
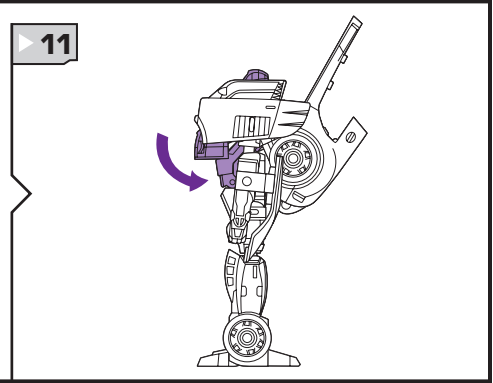
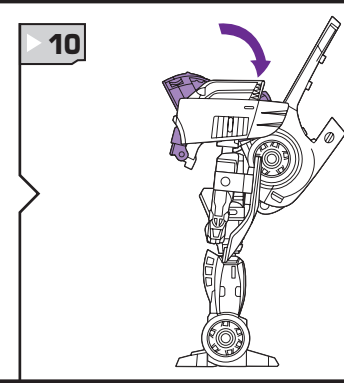
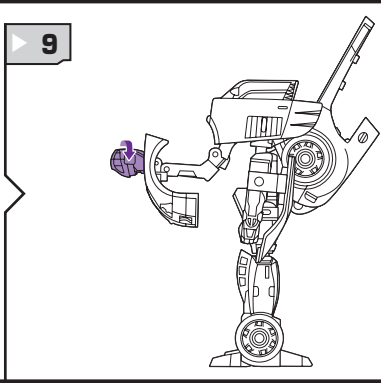
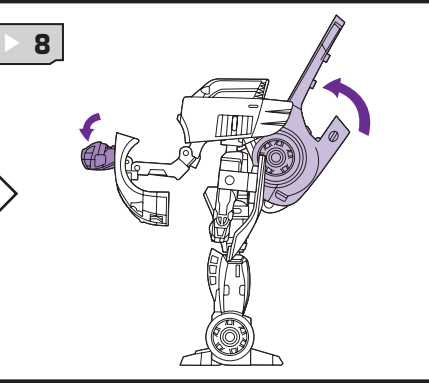
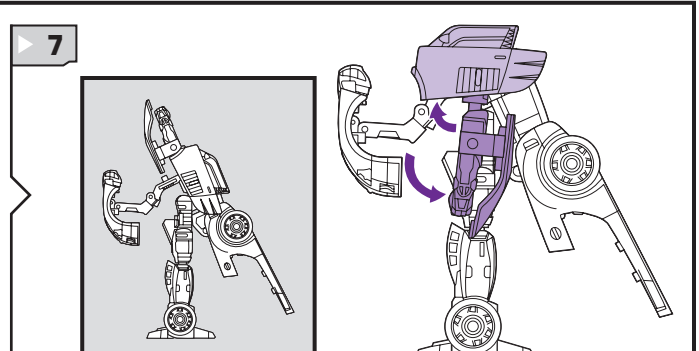
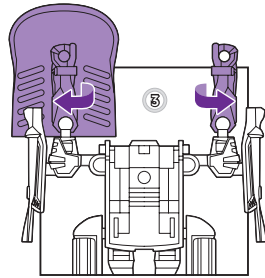
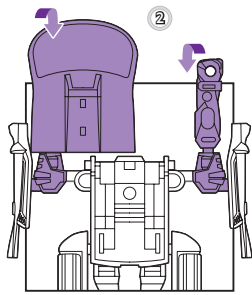
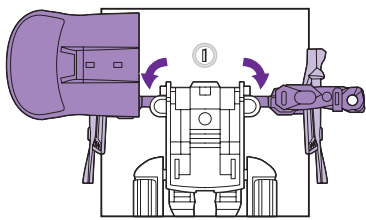
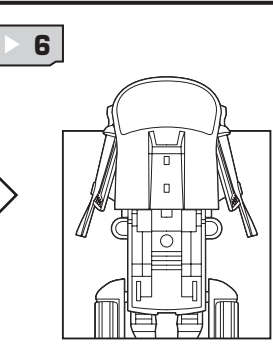
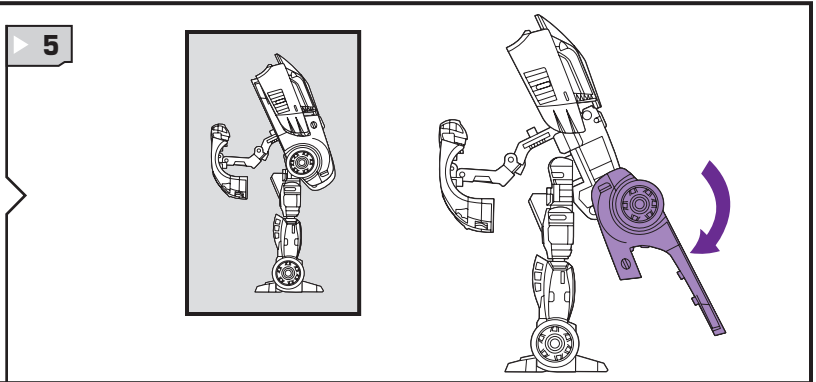
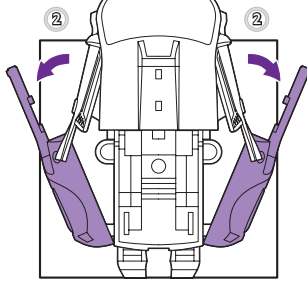
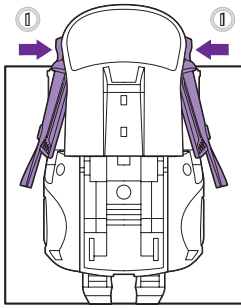
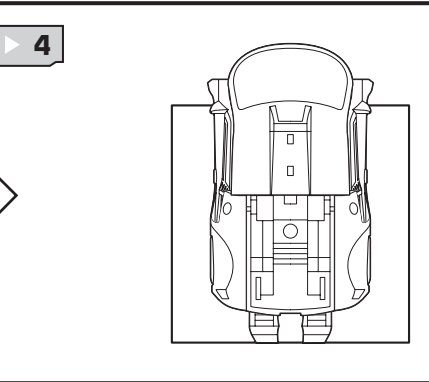
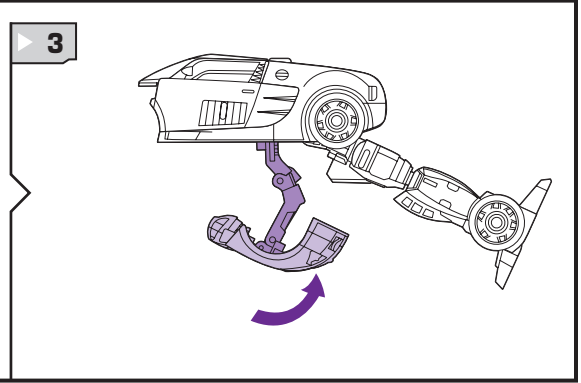
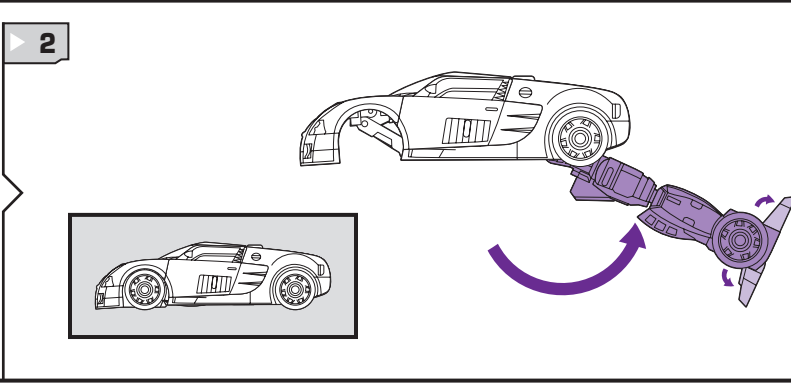
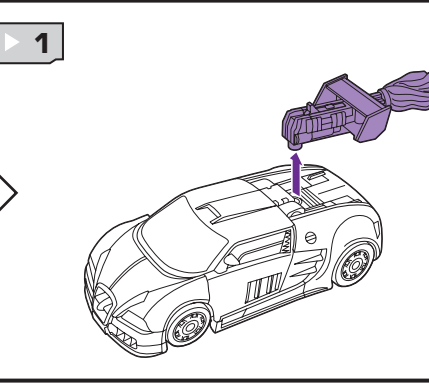
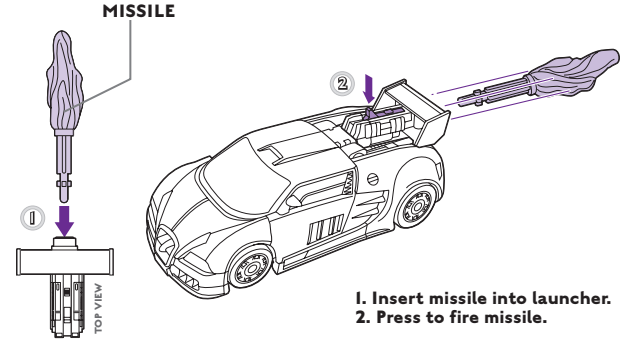
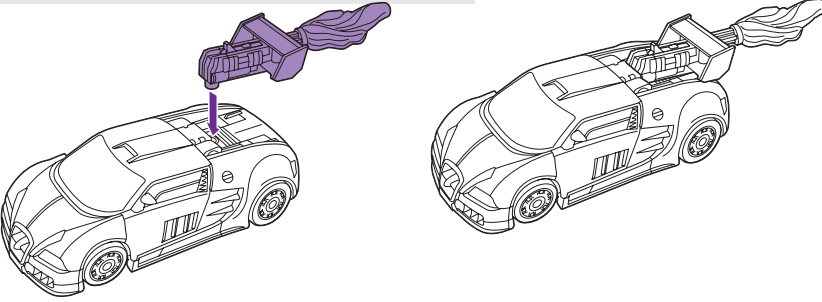

Reverse order of instructions to convert back into vehicle.



INSERT KEY TO ACTIVATE FEATURES!

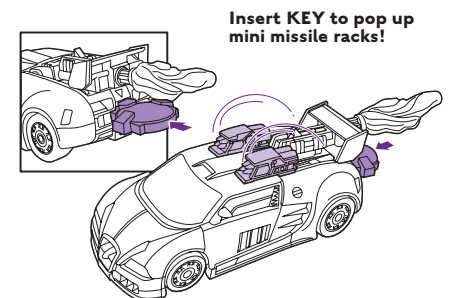
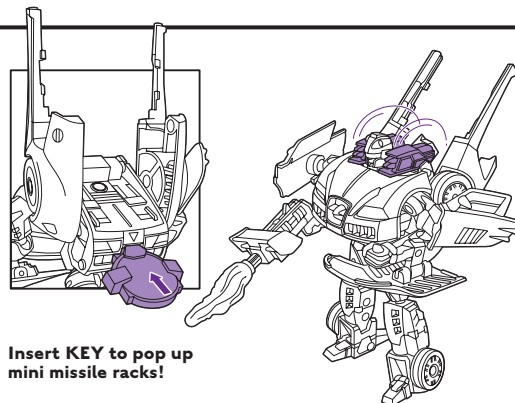

## Free Manuals Download Website

<http://myh66.com>

<http://usermanuals.us>

<http://www.somanuals.com>

<http://www.4manuals.cc>

<http://www.manual-lib.com>

<http://www.404manual.com>

<http://www.luxmanual.com>

<http://aubethermostatmanual.com>

Golf course search by state

<http://golfingnear.com>

Email search by domain

<http://emailbydomain.com>

Auto manuals search

<http://auto.somanuals.com>

TV manuals search

<http://tv.somanuals.com>