



3130 Advanced Function Printer

G544-3974-04

Introduction and Planning Guide

Note

Before using this information and the product it supports, be sure to read the general information under "Notices" on page vii.

Fifth Edition (September 1996)

This edition, G544-3974-04, applies to the IBM 3130 Advanced Function Printer and obsoletes G544-3974-03.

The following paragraph does not apply to any other country where such provisions are inconsistent with local law.

INTERNATIONAL BUSINESS MACHINES CORPORATION PROVIDES THIS PUBLICATION "AS IS" WITHOUT WARRANTY OF ANY KIND, EITHER EXPRESS OR IMPLIED, INCLUDING, BUT NOT LIMITED TO THE IMPLIED WARRANTIES OF MERCHANTABILITY OR FITNESS FOR A PARTICULAR PURPOSE. Some states do not allow disclaimer of express or implied warranties in certain transactions, therefore, this statement may not apply to you.

Requests for IBM publications should be made to your IBM representative or to your IBM branch office serving your locality. If you request publications from the address given below, your order will be delayed because publications are not stocked there.

IBM welcomes your comments. For your convenience, a form for readers' comments is provided at the back of this publication. You may send your comments by facsimile to 1-800-524-1519, by E-mail to *print_pubs@vnet.ibm.com*, or by mail to:

IBM Printing Systems Company
Information Development
Department H7FE, Building 003G
P.O. Box 1900
Boulder, CO 80301-9191, U.S.A.

When you send information to IBM, you grant a nonexclusive right to use or distribute the information in any way IBM believes appropriate without incurring any obligation to you.

© **Copyright International Business Machines Corporation 1994, 1996. All rights reserved.**

Note to U.S. Government Users — Documentation related to restricted rights — Use, duplication or disclosure is subject to restrictions set forth in GSA ADP Schedule Contract with IBM Corp.

Contents

Notices	vii
Communication Statements	vii
Trademarks	ix
Related Publications	x
 What's New in This Release	 xi
 Chapter 1. Introduction to the 3130 Advanced Function Printer	 1
General Description	1
Models	2
Common Highlights	3
Optional Features	3
Host Environments	4
IPDS Application Environment	4
Operational Capabilities	5
Data Security	6
Fonts	6
Performance and Print Quality	7
Advanced Function Image and Graphics (IPDS Only)	7
Print Material and Paper Handling	8
 Chapter 2. Planning Overview	 9
Implementation Plan	10
Additional Planning Tasks	11
 Chapter 3. Preparing the Processing Environment	 13
Performance Considerations	13
Compatibility Considerations	14
Attachments	14
Advanced Function Presentation Licensed Programs (IPDS-Only)	14
Installing and Verifying AFP Programs	14
Conversion	15
240-Pel to 300-Pel Migration Considerations (IPDS-Only)	15
IOCA Images and IM Images	15
GOCA Objects	15
Fonts	15
Page Definitions and Form Definitions	16
Bar Codes	16
Overlay Generation Language/370	17
AS/400 Migration Considerations (IPDS-Only)	17
Bolding of Characters	17
Enlarge Print Function	17
Box Draw Function	17
Other Font Considerations	18
 Chapter 4. Preparing the Physical Environment	 19
Environmental Requirements	19
Temperature and Humidity	19
Altitude Range	19
Ventilation	19

Heat and Airflow	19
Sound Levels	20
Power Requirements	20
Power Dissipation	20
Physical Requirements	21
Weight and Dimensions	21
Service Clearances	21
Physical Layout and Space Requirements	21
Installation Requirements	22
Physical Installation Worksheet	23
Chapter 5. Configuring the 3130	25
Printer Configuration Worksheet	25
Other Configuration Considerations	26
Font Management	26
Data Stream Configurations	26
System Attachments	26
Twinaxial Attachment	27
Ethernet TCP/IP and NetWare Attachment	27
SDLC SNA Attachment	27
Token-Ring (SNA, TCP/IP, and NetWare) Attachment	28
PC Parallel Attachment	28
Chapter 6. Ordering and Storing Supplies	29
Printer Supplies	29
Ordering Supplies	29
Selecting Paper	30
Paper Parameters	31
Label Parameters	32
Prepunched Paper	32
Paper Cassettes	33
Preprinted Paper	34
Envelopes	34
Selecting, Testing, and Ordering Paper Forms	36
Storing Paper and Supplies	36
Appendix A. 3130 Font Set	37
IBM Core Interchange Resident Scalable Font Set (IPDS-Only)	37
GCSGID Subsets for IBM Core Interchange Fonts	39
IBM Core Interchange Resident Code Page Set	39
4028 Compatibility Resident Font Set (IPDS-Only)	42
Other Resident Fonts (IPDS-Only)	43
Compatibility Resident Code Page Set	44
IBM Coordinated Font Set (IPDS-Only)	44
GCSGID Subsets	45
DBCS Resident Raster Font Set (IPDS-Only)	45
DBCS Resident Scalable (Outline) Fonts (IPDS-Only)	47
DBCS Resident Scalable Code Page Set	48
GCSGID Subsets for the DBCS Resident Scalable Font Set	49
Default Font (IPDS-Only)	49
AS/400 Bolding Function, Native and OfficeVision (IPDS-Only)	50
PostScript Resident Font Set	52
Adobe Type 1 Fonts	52
Duplicate Type 1 Fonts	54

Type 42 Fonts	54
PCL5e Resident Font Set	55
PCL5e Language Support	57
Appendix B. Software and Hardware Requirements	59
Attachments	59
Intelligent Printer Data Stream (IPDS) Considerations	60
PCL-5e and PostScript Considerations	61
PSF Support Notes	62
PSF/MVS Support	63
PSF/VSE Support	63
PSF/VM Support	64
PSF For OS/400 Support	64
Host Print Transforms for OS/400	64
PSF/2 Support	65
PSF for AIX Support	65
System Test	65
Applications (IPDS)	65
Token Ring Network Attachment	65
Ethernet Network Attachment	66
PSF Support Summary	67
Attachment Hardware	69
Appendix C. Plugs and Receptacles	71
Bibliography	73
Glossary	75
Acronyms and Abbreviations	84
Index	85

Figures

1. 3130 Service Clearances	22
2. Prepunched Paper Clearances -- A4, B5, and Letter Size	33
3. Prepunched Paper Clearances -- A3, B4, Legal, and Ledger Size	33
4. Preprinted Sheet	34
5. Envelope Dimensions	36
6. Power Plugs by Country	71
7. Power Plugs and Corresponding Receptacles	72

Notices

References in this document to IBM products, programs or services do not imply that IBM intends to make these available in all countries in which IBM operates. Any reference to an IBM licensed product, program, or service is not intended to state or imply that only IBM's product, program, or service may be used. Any functionally equivalent product, program, or service that does not infringe any of IBM's intellectual property rights may be used instead of the IBM product. Evaluation and verification of operation in conjunction with other products, except those expressly designated by IBM, is the user's responsibility.

Any performance data contained in this document was obtained in a controlled environment based on the use of specific data. The results that may be obtained in other operating environments may vary significantly. Users of this document should verify the applicable data in their specific environments. Therefore, such data does not constitute a performance guarantee or warranty.

IBM may have patents or pending patent applications covering subject matter in this document. The furnishing of this document does not give you any license to these patents. You can send license inquiries, in writing, to IBM Corporation, IBM Director of Licensing, 500 Columbus Ave, Thornwood, New York, 10594, United States.

The IBM 3130 Advanced Function Printer meets the requirements of IEC 950, First Edition, Amendments 1 and 2. The laser used in the 3130 complies with IEC 825 and EN 60825.

Communication Statements

Federal Communications Commission (FCC) Statement

Note: This equipment has been tested and found to comply with the limits for a Class A digital device, pursuant to Part 15 of the FCC Rules. These limits are designed to provide reasonable protection against harmful interference when the equipment is operated in a commercial environment. This equipment generates, uses, and can radiate radio frequency energy and, if not installed and used in accordance with the instruction manual, may cause harmful interference to radio communications. Operation of this equipment in a residential area is likely to cause harmful interference, in which case the user will be required to correct the interference at his own expense.

Properly shielded and grounded cables and connectors must be used in order to meet FCC emission limits. IBM is not responsible for any radio or television interference caused by using other than recommended cables and connectors or by unauthorized changes or modifications to this equipment. Unauthorized changes or modifications could void the user's authority to operate the equipment.

This device complies with Part 15 of the FCC Rules. Operation is subject to the following two conditions: (1) this device may not cause harmful interference, and (2) this device must accept any interference received, including interference that may cause undesired operation.

The United Kingdom Telecommunications Act 1984: This apparatus is approved under approval No. NS/G/1234/J/100003 for the indirect connections to the public telecommunications systems in the United Kingdom.

Canadian Department of Communications Compliance Statement: This Class A digital apparatus meets the requirements of the Canadian Interference-Causing Equipment Regulations.

Avis de conformité aux normes du ministère des Communications du Canada: Cet appareil numérique de la classe A respecte toutes les exigences du Règlement sur le matériel brouilleur du Canada.

German Conformity Statement: Dieses Gerät erfüllt die Bedingungen der EN 55022 Klasse A. Für diese Klasse von Geräten gilt folgende Bestimmung nach dem EMVG:

Geräte dürfen an Orten, für die sie nicht ausreichend entstört sind, nur mit besonderer Genehmigung des Bundesministers für Post und Telekommunikation oder des Bundesamtes für Post und Telekommunikation betrieben werden. Die Genehmigung wird erteilt, wenn keine elektromagnetischen Störungen zu erwarten sind.

(Auszug aus dem EMVG vom 9.Nov.92, Para.3, Abs.4)

European Community (EC) Conformity Statement: This product is in conformity with the protection requirements of EC Council Directive 89/336/EEC on the approximation of the laws of the Member States relating to electromagnetic compatibility. IBM cannot accept responsibility for any failure to satisfy the protection requirements resulting from a non-recommended modification of the product, including the fitting of non-IBM option cards.

Shielded Cables (European Statement): Properly shielded and grounded cables and connectors must be used in order to reduce the potential for causing interference to radio and TV communication and to other electrical or electronic equipment. Such cables and connectors are available from IBM authorized dealers. IBM cannot be responsible for any interference caused by using other than recommended cables and connectors.

Statement for CISPR 22 Edition 2 Compliance: Warning: This is a Class A product. In a domestic environment this product may cause radio interference in which case the user may be required to take adequate measures.

Japanese VCCI

この装置は、第一種情報装置（商工業地域において使用されるべき情報装置）で商工業地域での電波障害防止を目的とした情報処理装置等電波障害自主規制協議会（VCCI）基準に適合しております。

従って、住宅地域またはその隣接した地域で使用すると、ラジオ、テレビジョン受信機等に受信障害を与えることがあります。

取扱説明書に従って正しい取り扱いをして下さい。

VCCI

Trademarks

The following terms are trademarks of the IBM Corporation in the United States or other countries or both:

Advanced Function Presentation	MVS/SP
AFP	MVS/XA
AIX®	OfficeVision
AIX/6000®	OfficeVision/400
Application System/400®	Operating System/400
AS/400®	OS/2®
Bar Code Object Content Architecture	OS/400®
BCOCA	Personal System/2®
ES/3090	PrintManager
ES/4381	PS/2®
ES/9000	RISC System/6000®
ES/9370	SAA
ESCON®	System/360
GDDM	System/370
IBM®	VSE/ESA
Intelligent Printer Data Stream	
IPDS	
Micro Channel®	
MVS/ESA	

The following terms are trademarks or registered trademarks of other companies:

Trademark	Company
Agfa	Agfa-Gevaert A.G.
Agfa Rhombus	Agfa-Gevaert A.G.
AXIS	AXIS Communication, Inc.
CG Intellifont	Miles, Inc.
CG Omega	Miles, Inc.
CG Times	Miles, Inc. under license from Monotype Corp. (Times New Roman).
ITC Avant Garde Gothic	International Typeface Corp.
ITC Bookman	International Typeface Corp.
ITC Zapf Chancery	International Typeface Corp.
ITC Zapf Dingbats	International Typeface Corp.
Lexmark	Lexmark International, Inc.
Marigold	AlphaOmega Typography Corp.
NetWare	Novell Inc.
PostScript	Adobe Systems, Inc.
PCL-5	Hewlett Packard Co.
TrueType	Apple Computer Co.
Univerts	Linotype AG and Subsidiaries.
Windows	Microsoft Corp.

Related Publications

IBM 3130 Advanced Function Printer: User's Guide, S544-5337, describes how to operate the 3130.

IBM 3130 Advanced Function Printer: Administrator's Guide, S544-5328, describes job management, attachment configurations, font management, and other considerations for the 3130.

IBM InfoPrint 60; 3130, 3160, and 3935 Advanced Function Printer: Attachment Configuration Handbook, S544-3977, provides information to help you configure your system for the 3130 attachment you use.

Important

Before the customer engineer can install the 3130, you must complete a configuration worksheet for the attachment you plan to use. Simplified versions of these worksheets are available in this book (see "System Attachments" on page 26); however, for detailed worksheets, instructions, and examples, please refer to the *IBM InfoPrint 60; 3130, 3160, and 3935 Advanced Function Printer: Attachment Configuration Handbook*, S544-3977. If you do not have a copy of the handbook, ask your marketing representative to obtain one for you.

For a list of publications that describe Advanced Function Page Printers and related printing tools, see "Bibliography" on page 73.

For a more extensive listing of available publications, refer to *Advanced Function Presentation: Printer Information*, G544-3290.

For more information about Advanced Function Presentation, refer to the *Guide to Advanced Function Presentation*, G544-3876.

Contact your IBM marketing representative for information concerning the 3130, its documentation, or its associated licensed programs.

What's New in This Release

Most of the changes in this release concern attaching the 3130 to a Novell NetWare network.

Chapter 1. Introduction to the 3130 Advanced Function Printer

Chapter Overview

This chapter describes the characteristics, functions, features, and components of the 3130.

General Description

The 3130 is a cut-sheet, intermediate speed, non-impact, all-points-addressable printer. It uses low-power laser, electrophotographic print technology, and is capable of a volume-capacity of up to 200 000 impressions per month at speeds of up to 30 impressions per minute.

The 3130 can print at a resolution of either 240 x 240 or 300 x 300 picture elements (pels), and can be used for text, graphics, optical character recognition (OCR), and bar code printing. Text, images, and electronic overlays can be placed at any defined point on the page areas on which the 3130 can print.

The 3130 also features a high-speed RISC/6000-based control unit, which provides the following benefits:

- The ability to process complex print jobs at high speed
- Expanded network attachment capability
- Improved paper handling.

The O1S and O2S models shown on the following page are no longer marketed. They are shown for reference as current inventory machines.

Models

There are four models of the 3130: simplex, high-capacity simplex (two models), and duplex.

Model (Model Number)

Comes Standard with This...

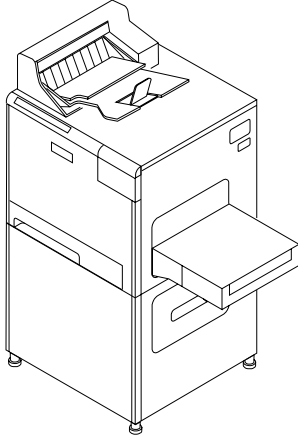

- One printer stand
- One top stacker
- One front 250-sheet input tray
- One side 500-sheet input tray

Simplex (01S)

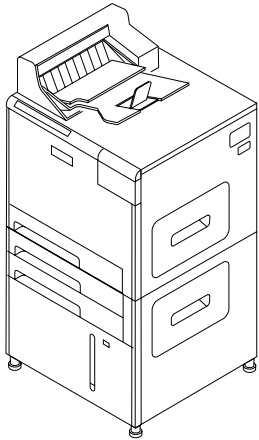

- One top stacker
- Three front 250-sheet input trays
- One front 2000-sheet input tray

High-capacity Simplex (02S)

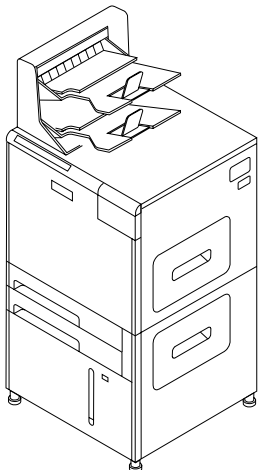

- Dual top stacker
- Two front 250-sheet input trays
- One front 2000-sheet input tray
- Upgradeable to Model 02D
- Replaces Models 01S and 02S

High-capacity Simplex (03S)

Model (Model Number)**Comes Standard with This...**

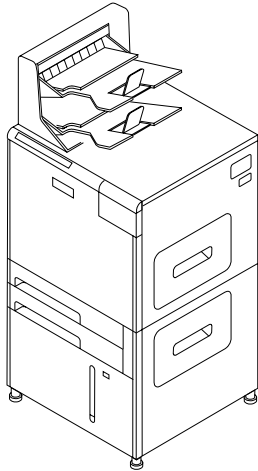

Duplex (02D)

- Dual top stacker
- Two front 250-sheet input trays
- One front 2000-sheet input tray

Common Highlights

The following are available on all models of the 3130:

- Advanced function common control unit (AFCCU) with 24 MB of storage. You can order additional memory in 16 MB increments up to 56MB maximum.
- Floppy disk drive
- Hard disk drive with resident fonts installed
- PC Parallel connector
- An Ethernet connector for one of the following optional Ethernet Transmission Control Protocol/Internet Protocol (TCP/IP) and/or NetWare (SPX/IPX) interfaces:
 - 10BaseT (twisted pair)
 - 10Base2 (thin)
 - 10Base5 (thick)
- An additional interface slot for one of the following optional attachments:
 - Twinaxial direct attachment
 - Synchronous Data Link Control (SDLC) V.24 or V.35 with System Network Architecture (SNA)
 - Token Ring with SNA, TCP/IP, NetWare (SPX/IPX), or all three.
- The ability to process IPDS, PostScript and PCL-5e data streams.

Optional Features

Table 1 on page 4 summarizes the optional features available for both models of the 3130. For details about obtaining these features, contact your marketing representative.

<i>Table 1. Optional Features</i>	
Feature	Comments
500-sheet side input tray	Adjustable to A4 and letter-size paper only. Requires the side input tray base.
500-sheet paper cassette	Adjustable to A4 and letter-size paper only
250-sheet adjustable paper cassettes	
Side input tray base	
1500-sheet side output stacker	
Additional memory	Up to two 16 MB increments
Relocation kit	Required for relocating the printer
DBCS resident fonts	IPDS only
Envelope Feeder	Requires the side input tray base

Host Environments

For a summary of host environments and support, see Appendix B, “Software and Hardware Requirements” on page 59. For a summary of PSF support and host software requirements, refer to *Advanced Function Presentation: Printer Information*, G544-3290.

IPDS Application Environment

The 3130 supports IBM Advanced Function Presentation (AFP) software, a collection of licensed programs that let application developers take advantage of many special kinds of printing, including bar code and optical character recognition (OCR) output. Three OCR fonts are available from IBM: OCR-A, OCR-B, and OCR 128. Many kinds of bar codes can be obtained. See “240-Pel to 300-Pel Migration Considerations (IPDS-Only)” on page 15 for additional bar code considerations.

Advanced Function Presentation uses the Intelligent Printer Data Stream (IPDS) to drive the printer. Refer to the *Guide to Advanced Function Presentation*, G544-3876, for more information. The 3130 also supports PostScript and PCL-5e data streams. See Appendix B, “Software and Hardware Requirements” on page 59 for additional information about these data streams.

Operational Capabilities

The following list is an overview of the 3130 operator panel menu: through it, you can see many of the operational capabilities available on the 3130. Refer to *IBM 3130 Advanced Function Printer User's Guide* for details about accessing and using these capabilities. Refer to *IBM InfoPrint 60; 3130, 3160, and 3935 Advanced Function Printer: Attachment Configuration Handbook* for details about configuring the items shown (except for "Printer Configuration," see Chapter 5, "Configuring the 3130" on page 25).

- Help
- Trays/Stackers
- System Shutdown
- Supplies
- Attachments
 - Twinaxial
 - SDLC
 - TCP/IP SYSTEM
 - Token Ring
 - Ethernet
 - PC Parallel
 - Application Setup
 - IPDS
 - NetWare
 - LPR
 - FTP
 - TFTP
- Setup
 - Print Quality Samples
 - Print Demo Pack
 - Machine Configuration
 - Job Management
 - Font Management
 - Data Streams
 - IPDS
 - PostScript Emulation
 - PCL Emulation
 - Printer Configuration (see "Printer Configuration Worksheet" on page 25.)
 - Define Forms
 - Machine Information
 - Adjust Print (IPDS)
 - Change Password
- Service

The following list summarizes some of the operational capabilities of the 3130:

- **Standalone operation**—the 3130 is designed to operate in an unattended office environment. It does not require a dedicated operator for normal printing tasks.
- **Operator messages and actions**—the 3130 has a 32-character display for messages, operator instructions, setup options, and host-related status.
- **Beeper**—the 3130 has a beeper that can alert operators whenever the 3130 requires attention.

- **Problem indicators**— LEDs on a printer icon at the left of the operator panel indicate where a problem such as a paper jam occurs.
- **Paper jam auto-eject drawers**—after a paper jam, you can usually automatically clear the jammed paper by opening one or two auto-eject drawers.
- **Traces**—the 3130 can perform several kinds of traces, which record details about printer activities and communications with the control unit and the controlling computer system to assist service personnel.
- **Print samples**—several print sample masters are stored in the 3130 control memory. Key operators can print these print samples whenever necessary to sample print quality or solve problems.
- **Authorization levels**—You can have one or more persons designated as a key operator. The key operator performs tasks such as configuring the printer, cleaning the printer, adding new toner, and replacing supplies.

You can specify that certain operator actions be password-protected; in other words, only the person who knows the password will be able to perform certain key operator functions.
- **Toner cartridge**—the 3130 monitors the toner supply and alerts the operator when it should be replenished. In addition, automatic toner recycling reduces the amount of toner the 3130 uses.
- **Error log**—sensors and other error-checking hardware detect status in the printer. Information about errors is displayed to the operator and logged for use in correcting problems.

Data Security

The 3130 has the following data security features:

- You cannot read data from the 3130 back into the controlling computer system.
- You cannot print data that remains in memory after a job is finished.
- Images on the photoconductor are removed after each print.
- The control unit accepts commands from the host to erase all residual print data and fonts from its memory.
- You can specify non-spoiled mode for most ASCII jobs. Refer to *IBM 3130 Advanced Function Printer System Administration Guide* for more information.

If many of the printing applications for your company are confidential, consider placing the 3130 in a controlled-access area.

Fonts

The 3130 supports the following for IPDS:

- The IBM strategic font set, which includes:
 - The IBM Core Interchange Resident Scalable Font Set
 - The 4028 Compatibility Resident Font Set
 - The IBM Coordinated Font Set

- The DBCS Resident Raster, including DBCS Scalable Font Sets (as a separately-orderable feature)
- A facility for adding and deleting fonts in the printer. Refer to *IBM 3130 Advanced Function Printer System Administration Guide* for more information about managing fonts.
- Downloading fonts from the host.

For a more detailed description of each font set, see Appendix A, “3130 Font Set” on page 37.

The 3130 supports the following for PostScript and PCL-5e fonts:

- Various resident fonts (see “PostScript Resident Font Set” on page 52 and “PCL5e Resident Font Set” on page 55) You can print samples of resident fonts from the printer. Refer to *IBM 3130 Advanced Function Printer User's Guide* for printing out resident fonts
- (PostScript only) A facility for adding and deleting fonts in the printer. Refer to *IBM 3130 Advanced Function Printer Administration Guide* for more information about managing fonts.
- Downloading fonts from the host or server.

Performance and Print Quality

The 3130 prints up to 30 impressions per minute in either simplex or duplex mode when using long-edge fed paper; it prints up to 15 impressions per minute for short-edge fed paper. Table 2 on page 8 summarizes the types of paper you can use and the maximum impressions per minute you can print.

Notes:

1. Actual printer performance is affected by a number of factors, including how you configure the printer, the complexity of the data you print, the performance of the host-system and the attachment you use, and the amount of available memory.
2. The quality of printer output is affected by the paper you use and the composition of the logical pages you print.

Advanced Function Image and Graphics (IPDS Only)

The 3130 can directly process advanced Image Object Content Architecture (IOCA) images and Graphics Object Content Architecture (GOCA) graphics data, as described in *Mixed Object Document Content Architecture Reference*, SC31-6802. This, in turn, provides the following performance benefits:

- The 3130 can process compressed images and vector graphics data in the GOCA format, thus reducing demand on attachment data transfer and host storage.
- The 3130, rather than the host system, decompresses images and rasterizes vectors, thus reducing host system processing cycles.
- The 3130 can perform arbitrary scaling operations or resolution correction for scanned images, which allows some complex jobs to print at greater throughput by increasing the overall data-processing speed of the printer.

Print Material and Paper Handling

The 3130 can use paper in a variety of sizes and weights, including preprinted paper, perforated paper, three-hole punched paper, drilled paper, color stock, and adhesive labels. The 3130 can accept paper with a basis weight of 64 to 160 grams per square meter (17 to 42 pounds). Paper is fed automatically from paper trays and, after printing, is automatically placed in output stackers.

Table 2 summarizes the paper sizes the 3130 can use and indicates the feed orientation and the number of impressions per minute for each paper size. See “Selecting Paper” on page 30 for more information on print materials you can use.

Paper Size	Feed Orientation	Impressions per Minute
Letter (8.5 x 11 in.)	Long-edge	30
Legal (8.5 x 14 in.)	short-edge	15
Ledger (11 x 17 in.)	Short-edge	15
A4 (210 x 297 mm)	Long-edge	30
A3 (297 x 420 mm)	Short-edge	15
B5 (182 x 257 mm)	Long-edge	30
B4 (257 x 364 mm)	Short-edge	15

Note: See “Envelopes” on page 34 for envelope sizes.

Paper input trays provide automatic, printer-controlled paper tray switching so you can load unused paper trays while the printer is running. Prints are stacked in output stackers, which collate printed pages face down and have offsetting capability.

The duplex model of the 3130 lets you print both sides of paper without restacking and refeeding the sheets.

Chapter 2. Planning Overview

Chapter Overview

This chapter provides an overview of the planning process for installing a 3130 printer.

There are two basic types of planning required for installing and using the 3130: physical planning and system planning.

- Physical planning consists of:
 - Determining the location for the 3130
 - Preparing a layout plan for the 3130
 - Making sure all 3130 environmental, electrical, and space requirements are met.

For more information, see Chapter 4, “Preparing the Physical Environment” on page 19. In addition, IBM offers special assistance with physical planning. Contact your IBM branch office for information.

- System planning consists of:
 - (IPDS-only) Ordering the Advanced Function Presentation licensed programs and updates required to use the printer.
 - (IPDS-only) Installing and testing the licensed programs and AFP resources.
 - (PostScript and PCL5e-only) Installing colon files and drivers.
 - Verifying that the host operating system is at the correct level.
 - Incorporating the 3130 into the system configuration and completing the configuration work sheets.

For more information, see Chapter 3, “Preparing the Processing Environment” on page 13 and Chapter 5, “Configuring the 3130” on page 25.

Implementation Plan

Note

The following checklist contains many of the major tasks that must be performed before and during 3130 installation. Use this checklist as a basis for developing your own detailed implementation plan.

Also, note that the tasks you need to perform depend on whether or not you are already running Advanced Function Presentation (AFP) programs.

Step One—Identify Team and Plan Layout

- ___ 1. Identify the people who can prepare the physical site, identify and test required software, and configure the host systems. Make sure to plan for the 3130 *and* the attachment you use to connect it to your host system.
- ___ 2. Order the 3130, including optional features you require, such as extra memory.
- ___ 3. Order any cabling, lines, equipment, or software you require for the attachment you use to connect the 3130 to your host system.
- ___ 4. (IPDS-only) Order the IBM Advanced Function Presentation licensed programs required for your system. If you already use IBM Advanced Function Presentation licensed programs, make sure that they are at the service level required to support the 3130.
- ___ 5. Make sure the host operating system is at the level required to support the Advanced Function Presentation licensed programs and their updates (IPDS) and printer drivers and colon files (PostScript and PCL5e).
- ___ 6. (IPDS-only) Determine which printer resolution will be used, and ensure that the host library resources (fonts, page segments, overlays, FORMDEFs, and PAGEDEFs) are compatible with the printer resolution you select.
- ___ 7. Prepare a plan for selecting and testing forms for use with the 3130.
- ___ 8. Determine the location for the 3130 and arrange for any changes to the site.
- ___ 9. Identify the internal delivery route for the 3130.
- ___ 10. Prepare a space layout plan.
- ___ 11. Determine who will install the electrical wiring and outlets.
- ___ 12. Create a conversion plan for line-printer data and electronic overlays.
- ___ 13. Prepare a plan for creating, converting, and testing applications that will be used with the 3130.

Step Two—Review Plans, Order Supplies, and Prepare Site

- ___ 1. Review installation plans with the IBM installation planning representative. See “Physical Installation Worksheet” on page 23 for the worksheet.
- ___ 2. Order initial supplies for the 3130.
- ___ 3. Ensure that attachment hardware is on order.
- ___ 4. Schedule the installation of lines and equipment required for the attachment.

- ___ 5. Schedule the installation of electrical wiring and outlets.
- ___ 6. Ensure that required host system updates are installed.
- ___ 7. Begin installing and testing the Advanced Function Presentation licensed programs and updates on the host system.

Step Three—Review Progress of Site Preparation

- ___ 1. Review site-preparation progress with the IBM installation planning representative.
- ___ 2. Ensure that the electrical wiring and outlets are being installed on schedule.
- ___ 3. Ensure that the attachment lines and equipment is being installed on schedule.

Step Four—Ensure that Site Preparation is Complete

- ___ 1. Ensure that installation and testing of electrical wiring and outlet is complete.
- ___ 2. Ensure that all site preparation activity is complete.
- ___ 3. Gather information for the configuration work sheets in Chapter 5, “Configuring the 3130” on page 25 and schedule an NCP Generation if needed.

Important

Before the customer engineer can install the 3130, you must complete a configuration worksheet for the attachment you plan to use. Completing the attachment worksheets usually requires input from the personnel responsible for network and device driver configuration. For detailed worksheets, instructions, and examples, refer to *IBM InfoPrint 60; 3130, 3160, and 3935 Advanced Function Printer: Attachment Configuration Handbook*, S544-3977. If you do not have a copy of the handbook, ask your marketing representative to obtain one for you. Information is also available on the Internet at <http://can.ibm.com/ibmprinters>.

Step Five—Arrival of the 3130

- ___ 1. Contact the customer engineer and arrange to have the 3130 installed.
- ___ 2. Arrange to have the 3130 attached to the host system.
- ___ 3. Complete tests of the Advanced Function Presentation licensed programs, including the IBM-supplied installation verification procedures.

Additional Planning Tasks

Here are some other issues to consider before you install the 3130:

- **Training.** Who will need training on the 3130 and AFP? Who will conduct the training sessions? When will training be scheduled?
- **Implementation.** How will the 3130 be phased into production? Which applications will use the 3130 first?

- **Documentation.** Which local procedures need to be changed? Who will be responsible for changing local procedures? Who will need copies of IBM hardware and software documents?
- **Supplies.** How large should the initial 3130 supply order be? What is the local procedure for ensuring that supplies are kept in stock? What is the anticipated usage of the 3130?

Chapter 3. Preparing the Processing Environment

Chapter Overview

This chapter contains information to help system programmers integrate the 3130 into the existing processing environment. The basic hardware, software, and application requirements for the 3130 are described in Appendix B, "Software and Hardware Requirements" on page 59.

Performance Considerations

- The quality of 3130 output is affected by the paper you use and the composition of the logical pages you print. To ensure printing legibility in your application, test small (4-point) fonts and special characters such as logos in your application. Refer to the *IBM Advanced Function Printer Cut-Sheet Paper Reference* for information about these considerations.
- The following factors affect the performance of the system and directly affect communication to the 3130:
 - Speed of the computer system
 - Amount of available memory
 - Priority of tasks assigned in the system
 - Control program used to drive the printer
 - Attachment type and line speed.
- Consider the following when setting up your host-attachment configuration:
 - Before attaching the 3130 to non-IBM equipment, ensure that the equipment supports the 3130. The equipment vendor can answer your questions about configuration options and other attachment issues.
 - High-speed, direct-access storage devices (DASD) are recommended for spool data sets and library data sets, particularly for printing workloads consisting of documents with many fonts and images.
 - Printer performance is best when high-use devices are used on a separate attachment from the 3130. Printer throughput can be degraded if the 3130 is attached with other high-use devices such as disk units, tape units, or another 3130 that prints complex documents.
- Printer traces, which you can run to help diagnose problems with the attachment, the software, or the printer microcode, run in the background while the printer performs its normal operations, and may reduce throughput.
- When memory can hold fonts and images for several pages at one time, performance improves substantially. Complex documents require more memory and, therefore, can take longer to print.
- To minimize the downloading of fonts, consider using printer resident fonts when possible. When using IPDS, also consider marking host fonts as "public" to allow the printer to capture and internally cache frequently used non-resident fonts. You can order up to 32MB of additional memory in increments of 16MB. To order additional memory, contact your IBM marketing representative.

Compatibility Considerations

Here are some factors to consider if you are sending jobs from other page printers to the 3130:

- (IPDS-Only) The 3130 supports fonts in the same format as those for the IBM 3160, 3820, 3825, 3827, 3828, 3835, and 3900 printers. User-modified or user-created 3800 printer fonts are not compatible with the 3130 fonts.
- Although the 3130 can print edge-to-edge, consider registration and paper size variations when defining the margins.
- The 3130 can print to the paper's edge, but for the best print quality, margins are recommended as follows:
Edges: 2.5 mm (0.1 in.)
Punched holes: 3 mm (1.2 in.)
- The 3130 default point of origin is the top left corner of the short side of the media.

Attachments

Important

Attaching your 3130 to your host system requires configuration changes to the host system. Depending on the type of attachment and the host system you use, some configuration changes may need to be performed before the 3130 can be installed. Several 3130 configuration parameters require values that match values in your host system; at the least, you need to be prepared to provide these values to the customer engineer who installs the 3130. Refer to *IBM InfoPrint 60; 3130, 3160, and 3935 Advanced Function Printer: Attachment Configuration Handbook* for more details about configuring host systems.

Advanced Function Presentation Licensed Programs (IPDS-Only)

Some Advanced Function Presentation (AFP) licensed programs are required for the operation of the 3130; others are optional. Work with your users to determine which optional advanced functions they need. For a list of publications that describe the programs you require for a particular environment, as well as a summary of Advanced Function Presentation concepts, products, and benefits, refer to the *Guide to Advanced Function Presentation, G544-3876*.

Installing and Verifying AFP Programs

Install and verify AFP programs before you install the 3130. The licensed programs include verification procedures to help you install the software correctly. In addition, the system programmer is responsible for:

- Creating the resources (page definitions, electronic overlays, form definitions, and page segments) that the resource libraries will contain.
- Creating or modifying the PSF startup procedure to include resource libraries and attachment information.
- Enabling printer resident fonts, if necessary.

Conversion

If Advanced Function Presentation is available on another printer, you may want to begin the conversion effort before you install the 3130. Some tasks to consider include:

- Changing font character sets
- Converting line-printer applications to page-printer applications
- Converting preprinted forms to electronic overlays
- Creating new applications by using electronic overlays
- Enhancing existing applications to take advantage of 3130 functions
- Investigating applications that have special programming requirements.

240-Pel to 300-Pel Migration Considerations (IPDS-Only)

The 3130 can print at 240-pel or 300-pel resolution. Usually, converting from 240-pel to 300-pel resolution requires little effort. You may need to evaluate applications that create complex printed pages with images, multiple fonts, graphics, and overlays for visual differences that occur at 300-pel resolution.

The following sections describe some more issues to consider if you choose to migrate from 240-pel to 300-pel resolution.

IOCA Images and IM Images

The 3130 printer supports image printing in one of two formats: IM image or IOCA image. If you print at 300-pel resolution, 240-pel IM images are automatically converted to IOCA and scaled to 300-pels.

While the 300-pel image and the 240-pel image will be the identical size, you may see some differences in the shading, diagonal lines, and curves of the image. Applications that produce images that are sensitive to exact duplication should be tested before migrating them to 300-pel resolution.

GOCA Objects

Graphical objects defined with vectors should look the same at 240-pel or 300-pel resolution because the 3130 builds the bit map for GOCA objects.

Fonts

When migrating print workload to the 3130, first determine if the fonts used by the application are resident in the 3130 or supported by the IBM PSF software as 300-pel raster fonts. Appendix A, "3130 Font Set" on page 37 details the fonts that the 3130 supports.

If the font you need is supported by the 3130, the 300-pel version of the font will be provided either from the resident outline font library or from the host raster-font library, to be downloaded from the host.

Notes:

1. For MVS, make sure to use the PSF APSRMARK utility to mark the resident fonts before you use them. PSF/MVS also ships another utility, APSRCF30, which you can use to convert 240-pel fonts to 300-pel fonts.
2. For VSE, make sure to use the PSF APTRMARK utility to mark the resident fonts before you use them. PSF/VSE also ships another utility, APTVCF30, which you can use to convert 240-pel fonts to 300-pel fonts.

See “PSF Support Notes” on page 62 for more information. Refer to *PSF/MVS: System Programming Guide* and *PSF/VSE: System Programming Guide* for information about these utilities. To create fonts from Adobe Type 1 fonts, you can use the Type Transformer, which is shipped with PSF/2.

The 3130 300-pel printed output will have the same line and page endings, but the right margins may not perfectly match those of the 240-pel version. For example, the typical line variation for a 12-point font is ± 13 mm (0.05 in.) or about one-half a character width.

If the font requested is not supported by the 3130 or by PSF, you can use either a supported substitute font or obtain a 300-pel version of the font from a font vendor. If you use a substitute font, the line endings, page endings, and right margins may be different from the 240-pel printed version.

Page Definitions and Form Definitions

Page definitions and form definitions often contain images and fonts that are dependent on resolution. Check these resources to see if they specify fonts, overlays, and page segments that need to be considered for migration or conversion. Also, overlays can specify other objects such as fonts and page segments that may need to be considered for migration or conversion.

Bar Codes

The 3130 can print the following types of bar codes:

- **BCOCA** - If the print data set was designed to run on a printer with BCOCA, it can be run with little or no change on a 3130. Some bar codes may print slightly differently on the 3130. Some differences include:
 - The 3812, 3816, and 4028 insert a blank area (called a quiet zone) at the beginning of the bar code area. Other printers, such as the 3130, 4224, 4230, and 4234 do not.
 - The Code128 modifier may print in a different position with the 3130.
 - EAN2, EAN5, UPC2, and UPC5 bar codes may print larger than they did on previous printers.

See the reference materials for your software and printers for more specific details on bar code implementation. For implementing BCOCA bar codes, see your application software documentation for information.

- **Bar Codes Generated by DCF** - When a program such as Document Composition Facility (DCF) is used to generate bar codes using draw rules, the output should be tested on the 3130 with the scanning equipment used for reading the bar codes. The different resolution of the printer may cause very slight differences in the placement of the bar code components.

- **Bar Code Fonts** - Non-resident bar code fonts also may be used. Check with your font vendor for the availability of the desired 300-pel rasterized bar code fonts.

Overlay Generation Language/370

With the Overlay Generation Language/370 (OGL/370), you can define overlays used to create forms. The overlay components (offsets, line lengths, line thickness, radii, and so on) are automatically scaled by the 3130 with the PSF software. Some differences may occur with slight “stair-stepping” effects for diagonal lines with rounded corners and some shading changes.

In addition, overlays created with OGL can specify other resources such as fonts and page segments which may need to be considered for migration or conversion. You should test applications using OGL/370 before migrating them to the 3130.

AS/400 Migration Considerations (IPDS-Only)

Here are some things to consider if you migrate your print workload to a 3130 attached to an AS/400 operating in the OS/400 environment.

Bolding of Characters

Both OfficeVision and Data Description Specification (DDS, the native OS/400 key word HIGHLIGHT function) enable you to make characters bold by using a font modification parameter. The printer automatically prints the indicated characters bold for any font supported by the printer. The 3130 printer supports this same function for the set of fonts resident in the printer that have bold versions. See “AS/400 Bolding Function, Native and OfficeVision (IPDS-Only)” on page 50 for a list of the 3130 fonts and what will occur when the bolding function is invoked.

Note: Note that bolding may cause changes to line length, and in some cases may cause information to exceed the page width.

Enlarge Print Function

OfficeVision/400, the Advanced Function Presentation Utilities/400 and the Data Description Specification (DDS, native OS/400) keyword for CHRSIZ enable you to direct the printer to enlarge characters. This function is not supported on the 3130 using fonts selected by FGID (Font Global ID). This function is only supported under DDS if you use GDDM fonts. GDDM fonts are selected by name, such as ADMVMOB for Multinational Open Block.

Box Draw Function

OfficeVision lets you draw boxes with the cursor and then print them as drawn. The 3130 supports this function if you specify **ON** for the AS/400 Box Draw Enhancement printer configuration item. If you specify **OFF** for the AS/400 Box Draw Enhancement printer, boxes drawn with OfficeVision will have breaks in them.

Note: To draw boxes correctly, the 3130 substitutes code page 1091 for code page 259.

Other Font Considerations

IPDS, PostScript and PCL5e fonts are listed in Appendix A, "3130 Font Set" on page 37 and are resident in the 3130.

Your job can download fonts not listed if you have them on your host system and your job requires them. Usually, the printer stores them in RAM and deletes them whenever the 3130 is powered off. However, the printer can store downloaded IPDS fonts on the hard disk.

A facility in the printer allows you to add fonts from a diskette to the hard drive and avoid losing them at power off. It also allows you to delete fonts from the hard drive. The fonts are:

- | | |
|-----------------|---|
| For PostScript: | Type 1 fonts |
| For IPDS: | AFP outline fonts containing either Type 1 or Character Identifier (CID)-keyed technology |
| For PCL: | TrueType or Intellifont fonts |

Chapter 4. Preparing the Physical Environment

Chapter Overview

This chapter describes the environmental, power, physical, and space requirements you must meet before you install the 3130. It includes an installation planning worksheet.

Environmental Requirements

Temperature and Humidity

Table 3 lists the permitted temperature and relative humidity values for the 3130. Operating the 3130 above or below these ranges may result in poor print quality and degraded paper handling.

	Temperature	Relative Humidity
With Power On	16 to 32°C (60 to 90°F)	20 to 80%
With Power Off	10 to 43°C (50 to 109°F)	8 to 80%
Shipping and Storage	-10 to 40°C (14 to 104°F)	5 to 90%

Altitude Range

The altitude range permitted for 3130 operation is sea level to 2100 meters (7000 feet).

Ventilation

The 3130 operates best in an air-conditioned computer room with year-round humidity control and recirculated, filtered air. Dust and other contamination can cause machine problems.

To reduce any health risks associated with preprinted forms, follow IBM preprinted forms recommendations and provide appropriate ventilation to the printer area. The American Society of Heating, Refrigeration, and Air Conditioning Engineers (ASHRAE) recommends a minimum of 0.42–0.57 meters³/minute (15–20 ft³/minute) per person of outdoor air make-up for an office size of 12 ft x 12 ft x 8 ft (32.4 Meter³) during human occupancy (ASHRAE 62–1989).

For information about selecting and safely using preprinted forms, refer to the *IBM Advanced Function Printer Cut-Sheet Paper Reference*.

Heat and Airflow

Average heat dissipation of the 3130 while printing is less than 930 Kcal/hour (3690 BTU/hour) based on 1.08kVA for the printer.

No airflow restrictions apply if the 3130 is installed according to the guidelines and floor plans established in this document.

Sound Levels

The upper limits for sound level are shown in Table 4.

Printer Condition	Sound Level
Idle	6.4 bels (55 dBA)
Operating	7.2 bels (46 dBA)

Power Requirements

Attention

Do not connect the 3130 to any 380—415 IT power distribution system (impedance grounded neutral system).

Make sure that your installation meets the electrical power requirements listed in Table 5 before the printer is delivered. In addition:

- Reserve a dedicated electrical outlet to support the printer and to allow the printer to be disconnected from power. This can be:
 - A compatible receptacle installed near the 3130.
 - A circuit breaker that breaks all live poles. This circuit breaker must be dedicated to the 3130 printer.
- Provide electrical outlets for auxiliary equipment, such as modems or communication modules. If necessary, make sure a telephone line and jack are available.
- The 3130 is equipped with an approved plug for your safety. Use it in conjunction with a properly grounded receptacle. Refer to Appendix C to find out which type plug is supplied in your country.

Item	North American and Japanese Requirements	European Requirements
Nominal Voltage	100V, 115V ac $\pm 10\%$, single phase, two wires plus ground	220V, 230V, and 240V ac $\pm 10\%$, single phase, two wires plus ground
Nominal Frequency	50/60 Hz $\pm 1.0\%$	50/60 Hz $\pm 1.0\%$
Input Current	10 amperes	5.2 amperes
Power Input	1.08 kVA	1.08 kVA

Power Dissipation

The 3130 can enter a power-save mode after a specified time has elapsed with no printer activity. When the 3130 enters power-save, it removes power from all printer subsystems. Normal operation resumes when the printer receives a host command.

<i>Table 6. 3130 Power Dissipation</i>	
Mode	Power Usage
Printing	900 watts
Standby	220 watts
Power Saving	100 watts

Physical Requirements

Weight and Dimensions

The standard simplex model O3S weighs 154 kg (337 lb); the standard duplex model O2D weighs 156 kg (343 lb).

The dimensions of the 3130 are:

	Standard Paper Handling	Fully Featured Paper Handling
Width	654 mm (26 in.)	1353 mm (53 in.)
Depth	640 mm (26 in.)	640 mm (26 in.)
Height	1385 mm (54 in.)	1385 mm (54 in.)

Service Clearances

The service clearances required for the 3130 are:

Front	1295 mm (51 in.)
Rear	910 mm (36 in.)
Left	760 mm (30 in.)
Right	760 mm (30 in.)

Physical Layout and Space Requirements

Figure 1 on page 22 shows the space requirements for a permanent installation.

As you plan your physical layout:

- Install the 3130 away from the main traffic pattern. Allow space for key operators and customer engineers to perform their tasks. This space should not extend into walkways.
- Install the 3130 in a location that is convenient for the key operator and other users. For example, consider whether the planned location is close to printer supply storage areas and to output distribution areas.
- Allow 2.1 meters (83 in.) between the floor and the lowest permanently attached object above the 3130, such as a light or a cable rail. This layout gives printer operators and customer engineers space in which to work.
- Check the route that the 3130 must travel from your loading dock to the location where it will be installed, to make sure it fits through the doorways and halls. When possible, move the printer from the dock to its installation location on its shipping pallet.

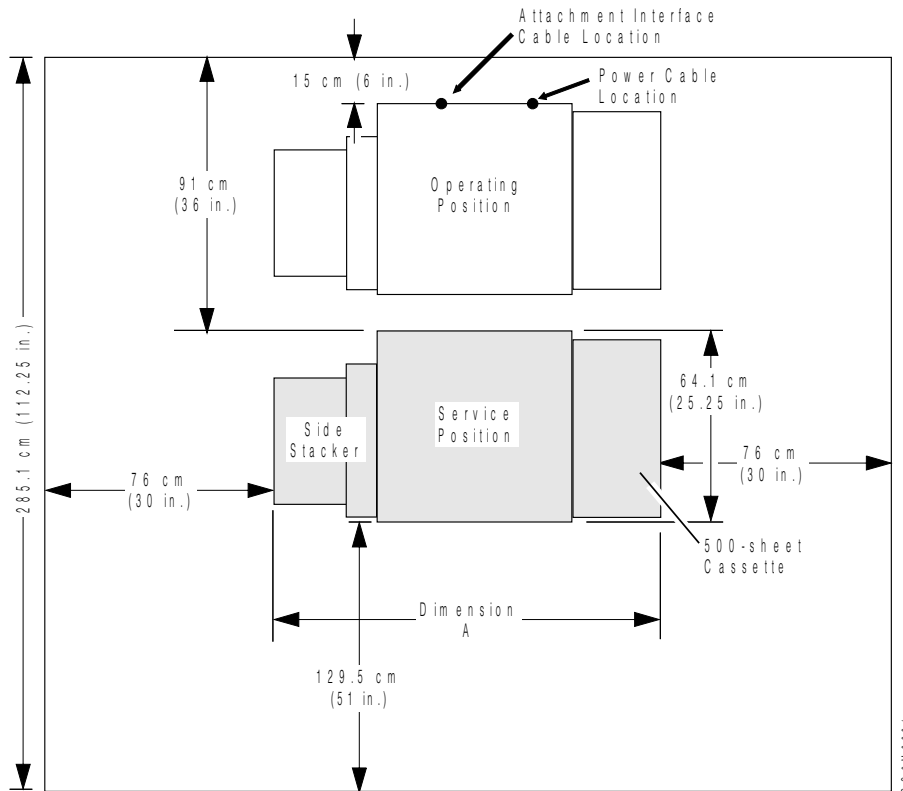

Figure 1. 3130 Service Clearances

Dimension A Values:

Dimension	Configuration
654 mm (25.75 in.)	Base printer
356 mm (14 in.)	Add to base printer for side stacker
343 mm (13.5 in.)	Add to base printer for 500-sheet cassette

Installation Requirements

Procedures for installing the 3130 are included with the printer and in the *3130 Advanced Function Printer: Maintenance Information*. This section describes only physical installation requirements. See “Implementation Plan” on page 10 for complete planning information. The installation is done by a service person; however, the customer is responsible for the following pre-installation requirements:

- Make sure the environmental, electrical, and space requirements specified in this chapter are met. Use the “Physical Installation Worksheet” on page 23 to complete this step.
- Make sure the receiving area and internal delivery route contain no obstacles that might interfere with moving the 3130 to its planned location.
 - Halls and doorways must be large enough for the printer to pass through, and corners and angles must be large enough to permit the printer to turn. For example, the minimum doorway opening through which the 3130 can pass from a 91.5 cm (36 in.) wide aisle is 75 cm (30 in.).
 - Ramps must have no more than 12 degrees, 50 minutes incline to allow clearance for the lower edge of the printer with its supporting feet retracted.

- Elevators and elevator doorways must be able to accommodate the size and weight of the printer and the people who are moving it.
- Stairs, sills and gaps, and carpeting can make it difficult to roll the printer.
- Do not tilt the printer past a 15° angle.
- Ensure that the floor is level within ±1.5° from earth horizontal in any plane.
- Ensure that an approved electrical outlet with correct power is reserved for the 3130, and that it can be reached with the power cable.
- If the 3130 is being installed in an area with a raised floor, ensure that the access hole in the raised floor is large enough for both the communication attachment cables and the power cable.

Physical Installation Worksheet

Before your 3130 is delivered, prepare a site installation plan. Use the following worksheet (Table 7) to ensure that all of the pre-installation requirements are met.

Requirements	Meets Requirements	Needs Attention	Assigned to	Date Due	Date Completed
Environmental <ul style="list-style-type: none"> • Ventilation • Temperature • Relative humidity 	_____	_____	_____	_____	_____
Space <ul style="list-style-type: none"> • Layout • Supplies storage space • Clearances • Delivery route 	_____	_____	_____	_____	_____
Electrical <ul style="list-style-type: none"> • Voltage • Outlets: <ul style="list-style-type: none"> – Reached by cables? – Correctly grounded? – Meet local and national codes? • Building branch circuit: <ul style="list-style-type: none"> – Correctly grounded? – Enough power to meet needs? – Meets local and national codes? 	_____	_____	_____	_____	_____
Host Attachment <ul style="list-style-type: none"> • Cables • Lines • Other equipment 	_____	_____	_____	_____	_____
Security	_____	_____	_____	_____	_____

Chapter 5. Configuring the 3130

Chapter Overview

This chapter contains worksheets you can use to configure the 3130, and descriptions of the attachments that connect host systems to the 3130.

Note: Before the customer engineer can install the 3130, you must complete all of the appropriate attachment configuration worksheets.

The only worksheet in this manual is Printer Configuration. All attachment worksheets, instructions, and examples are in the *IBM InfoPrint 60; 3130, 3160, and 3935 Advanced Function Printer: Attachment Configuration Handbook*. If you do not have a copy, ask your marketing representative to get you one.

Appendix B, "Software and Hardware Requirements" on page 59 summarizes the host environments that support the 3130 and the attachments that run under each.

"Operational Capabilities" on page 5 summarizes the printer's menu; it shows where the printer configuration appears in the structure.

Printer Configuration Worksheet

Printer Configuration includes duplex, sleep time, beeper languages, and print density.

Fill in the requested information in Table 8, and give a copy to the customer engineer when the 3130 is installed. The customer engineer will use the work sheet to configure the 3130. You can change some of these options later.

The procedures for customer engineering to configure the printer are in *IBM 3130 Advanced Function Printer Maintenance Information*; the procedures for updating the configuration are in *IBM 3130 Advanced Function Printer User's Guide*.

Item	Available Values	Selected Value
DUPLEX	ENABLE or DISABLE	
SLEEP TIME (MINUTES)	Up to 3 digits (minutes)	
BEEPER	ERROR: TIMED BEEP, CONTINUOUS, OFF KEYS: ON or OFF	
LANGUAGE (For operator panel display only)	ENGLISH, FRENCH, GERMAN, JAPANESE (KATAKANA), ITALIAN, SPANISH, BRAZILIAN PORTUGUESE, DUTCH	
PRINT DENSITY	LIGHT, MEDIUM, or DARK	

Duplex

Specifies duplex printing. This parameter applies only to the duplex model.

ENABLE Print duplex

DISABLE Print simplex

Sleep time	The length of time in minutes the printer waits before it goes into <i>sleep mode</i> . Specify a value from 0 to 999. 0 means the printer will never go to sleep.
Beeper	A beeper sounds when the 3130 detects an error or when keys are pressed during menu mode. <ul style="list-style-type: none"> • You can set the <i>error</i> beeper to: <ul style="list-style-type: none"> – Beep until any operator panel key is selected – Beep for three minutes and then stop – Never beep at all. • You can set the <i>keys</i> beeper to on or off.
Language	The language used to display operator console text for general users and key operators. Text for customer engineers is in English only.
Print Density	An indication of the darkness of the print. Settings are LIGHT, MEDIUM, or DARK. MEDIUM is the default value, although some applications may run better with Optical Density set to DARK.

Other Configuration Considerations

IBM InfoPrint 60; 3130, 3160, and 3935 Advanced Function Printer: Attachment Configuration Handbook contains the configuration worksheets for the items that follow. Items are included here as a reminder.

Font Management

The printer control unit allows you to add fonts, delete fonts, list the printer resident fonts, and list fonts on the diskette.

A detailed description of managing fonts and how to do it is in *IBM 3130 Advanced Function Printer System Administration Guide*.

Data Stream Configurations

The 3130 can process IPDS, PostScript, and PCL data streams simultaneously. To ensure that the printer handles your jobs properly, complete the appropriate worksheets in *IBM InfoPrint 60; 3130, 3160, and 3935 Advanced Function Printer: Attachment Configuration Handbook*. The *IPDS Handbook for Printers That Use the Advanced Function Common Control Unit* contains information about IPDS.

System Attachments

Appendix B, "Software and Hardware Requirements" on page 59 summarizes the host environments that support the 3130 and the attachments that run under each.

Important

Before the customer engineer can install the 3130, you must complete the appropriate attachment configuration worksheets. For detailed worksheets, instructions, and examples, refer to the *IBM InfoPrint 60; 3130, 3160, and 3935 Advanced Function Printer: Attachment Configuration Handbook*. If you do not have a copy, ask your marketing representative to get you one. Installing these attachments may require changes to your host system configuration.

Twinaxial Attachment

Twinaxial attachments directly attach the 3130 to an AS/400. A twinaxial cable system supports cable-through capability, which allows more than one device to be connected to a single cable. Refer to *Application System/400 Printer Device Programming*, SC31-3713.

Ethernet TCP/IP and NetWare Attachment

The 3130 is connected to a host Ethernet using the 'Integrated Ethernet LAN adapter' contained in the control unit.

The control unit can be attached directly to standard Thick (10Base5) Ethernet coaxial cable (Feature Code 4163). The output connector is a thick 15-pin D-shell "slide-latch" type that is compatible with IEEE 802.3 Section 7.6. Connection to thick Ethernet media is through an Ethernet/IEEE 802.3 AUI cable available from OEM vendors. Attachment to thin (10Base2) or twisted-pair (10BaseT) Ethernet media is through external transceivers.

The coaxial T connector is used in addition to the 10Base2 transceiver to connect to the thin Ethernet coaxial cable. You should use a customer-supplied RJ45 unshielded twisted-pair cable (must meet IEEE 802.3 requirements) to attach the 10BaseT transceiver to the Ethernet twisted-pair hub.

SDLC SNA Attachment

The 3130 can be attached to a host SDLC network by RS232 or V.35 cabling using the Four-Port Multiprotocol Communication Controller Adapter contained in the printer control unit. The Four-Port Multiprotocol Communication Controller Adapter connects, through a 3-meter (10-foot) Four-Port Multiprotocol Interface cable to either a 3-meter (10-foot) RS232 cable or to a 2-meter (7-foot) V.35 cable.

Notes:

1. SNA SDLC is intended to run on leased (non-switched) lines in point-to-point mode for either EIA 232 (19.2 Kbps) or V.35 (56 Kb/second) for limited distance modems or modem eliminators. You may also run V.35 (56 Kbps) on leased line (DDS1 Digital Data Service) point-to-point with digital DSU/CSU modems. Using speeds less than 19.2 Kbps, multipoint operation, or both can slow printer performance and is not recommended. Clocking is provided by setting limited distance modems or modem eliminators to an internal clock, or by setting digital DSU/CSU modems to a network clock.
2. The 3130 can replace a 3820 printer, but for better performance, change the MAXDATA or MAXFRAME and RU sizes in your VTAM, NCP, or system configurations.

Token-Ring (SNA, TCP/IP, and NetWare) Attachment

The 3130 can be attached to a host system using a 4 Mbps or 16 Mbps token-ring local area network (LAN) with the IBM Token-Ring cabling and Token-Ring High-Performance Adapter contained in the printer control unit.

The printer can be located a maximum of 100 meters (328 feet) from the 8228 Multistation Access Unit or 8230 Controlled Access Unit. The 8219 or 8220 Optical Fiber Repeaters can be used to increase this distance.

PC Parallel Attachment

The 3130 is connected to a host through the Integrated PC Parallel Adapter in the printer control unit. A standard PC parallel cable or a separately orderable network print server (NPS) connects the printer to the host computer.

Chapter 6. Ordering and Storing Supplies

Chapter Overview

This chapter describes how to order and store the supplies that the 3130 uses.

Printer Supplies

Table 9 lists printer supplies, parts, the part numbers you can use to order them, and an estimate of how often they need to be replaced. The yields listed in the table are approximations. They are not a warranty or guarantee of minimum life, and are provided only to assist in supplies planning. Analyze your actual usage figures to determine how much of each supply item to stock.

Actual supply life varies according to printer usage, toner settings, paper characteristics, temperature, and humidity. In addition, special applications (such as, adhesive labels, extensive graphics, bar codes, landscape applications, and pre-printed forms) may significantly reduce supply life.

When the 3130 runs low on a particular supply, it displays a message on the operator panel.

Supply Item	Part Number	Replace Every...
Cleaner unit	1372476	300 000 to 500 000 pages (job stream dependent)
Developer mix	1402691	600 000 pages
Fuser unit	100V: 1372475 200V: 1372478	600 000 impressions 600 000 impressions
Photoconductor belt	1372472	50 000 to 100 000 counts
Toner cartridge (package of six cartridges)	1402690	35 000 pages
Transfer belt unit	1372477	600 000 pages

Ordering Supplies

To order supplies for the 3130 in the United States, use any of the following methods:

- Contact a Lexmark International Incorporated authorized supply dealer.
- Call Lexmark Telemarketing at 1-800-438-2468 from 8 a.m. to 8 p.m. Eastern Standard Time.
- Write Lexmark Telemarketing at:

Lexmark Telemarketing
1221 Alverser Drive
Midlothian, Virginia 23113

Lexmark Telemarketing can help you locate dealers that sell 3130 supplies or take your order. Supplies are warranted to be free of defects in materials and workmanship. If you believe you are due a replacement, return the supply in its original package or a package from the replacement supply to the point of purchase. If purchased from a dealer, return it to that dealer. Include the following with the return:

- A brief explanation of the problem
- The approximate number of prints run with the supply
- A copy of your invoice
- Print-quality samples
- An estimate of the amount of the defective supplies used.

In the United States, supplies purchased from Lexmark by telephone or catalog should be mailed to:

Attention: Supplies Returns
Lexmark International, Inc. Building 988
1126 Russel Cave Rd
Lexington, Kentucky 40505

In other countries, contact your point of purchase for information about where to return items.

Selecting Paper

Printing on paper that does not comply with paper specifications may result in paper jams and print quality degradation. The 3130 uses standard white paper, pastel-colored paper, prepunched paper, preprinted paper, cardstock, and adhesive labels.

Xerographic paper is required to satisfy various electrical, heat, and mechanical characteristics. Select only high quality papers and forms to avoid print quality and printer paper handling problems. IBM recommends that you initially test several reams of special use materials in your 3130 before you purchase large quantities for a given application. For more detailed information regarding paper characteristics and pretesting, refer to *Advanced Function Printer Cut-Sheet Paper Reference* and the *IBM 3130 Advanced Function Printer User's Guide*. Table 10 on page 31 summarizes the paper sizes the 3130 can use and indicates the feed orientation and the number of impressions per minute for each paper size.

Paper Size	Feed Orientation	Imp per Minute
Letter (8.5 x 11 in.)	Long-edge	30
Legal (8.5 x 14 in.)	Short-edge	15
Ledger (11 x 17 in.)	Short-edge	15
A4 (210 x 297 mm)	Long-edge	30
A3 (297 x 420 mm)	Short-edge	15
B5 (182 x 257 mm)	Long-edge	30
B4 (257 x 364 mm)	Short-edge	15
Commercial #10 envelope* (4.5 x 9.5 in.) flap up	Long-edge	30
ISO International DL envelope* (110 x 220 mm) flap down	Long-edge	30
Note: * = Requires the Envelope Feeder feature		

Paper Parameters

Table 11 summarizes recommendations that can help you and your paper supplier choose paper that is most suitable for your 3130. This table contains parameters that you should consider when purchasing paper supplies for your Page Printer.

Parameter	Recommendation
Paper Grade	No. 1 or No. 4 Xerographic
Fiber Composition	Preferred: 100% chemical wood pulp Acceptable: Recycled or with cotton content
Color	White or Pastel Colors
Filler	Kaolin or china clay (aluminosilicate) or calcium carbonate. To improve brightness, paper may contain titanium dioxide or magnesium silicate.
Grain Direction	Parallel to the long dimension (grain long)
Cutting Method	Rotary Precision cut (Lennox, Will, or equivalent)
Cutting Tolerances	Length and Width: ± 0.787 mm (± 0.031 in.) Squareness: All corners $90^\circ \pm 0' 6''$
Basis Weight	Preferred: 75g/m ² (20 lb bond) Acceptable: 64 to 160g/m ² (17 to 42 lb bond) and 110 lb index paper (200g/m ²)
Caliper	20 to 24 lbs (75 to 90g/m ²): 3.5 to 5.0 mils (90 to 127 micrometers) 17 to 19 lbs (64 to 72g/m ²): 3.2 to 4.0 mils (81 to 102 micrometers)
Smoothness (Sheffield)	100 to 200 Sheffield units (75 to 90 g/m ² (20 to 24 lbs))
Porosity (Gurley)	10 sec/100 ml minimum
Surface Sizing	Starch—do not use synthetic surface sizing
Internal Sizing	Acid rosin or synthetic (alkylketene dimer or alkyl-succinic anhydride)
Coefficient of Static Friction	0.35 to 0.62

<i>Table 11 (Page 2 of 2). Paper Recommendations</i>	
Parameter	Recommendation
Stiffness (Tabor Method)	Machine direction: 1.7 minimum Cross direction: 0.8 minimum
Moisture Content	3.4 to 5.5 percent
Surface Resistivity	5x10 ⁹ to 2x10 ¹² ohms

Label Parameters

The 3130 can also print on paper face self-sticking adhesive-backed labels in simplex mode. Because the use of labels may cause more problems than printing on plain xerographic paper, IBM recommends that you and your label supplier consider the following parameters when purchasing labels:

<i>Table 12. Label Recommendations</i>	
Parameter	Recommendation
Total Basis Weight	64-160 g/m ²
Caliper	175 microns (6.8 mils) maximum
Face Stock Smoothness	70 to 200 Sheffield units

For more detailed information about paper, cardstock, labels, and other forms, refer to the *Advanced Function Printer Cut-Sheet Paper Reference*.

Attention: When printing labels, observe the following:

- Use only the base stacker or upper stacker. Using the side stacker for labels may damage the printer.
- Load labels face down in the upper sub tray, lower sub tray, or main tray.
- Run labels only in simplex mode.
- Before ordering large quantities of your labels, run several small jobs to be sure they work properly.
- Refer to *IBM 3130 Advanced Function Printer User's Guide* for more details about running labels.

Prepunched Paper

Prepunched paper should be flat and without deformation. Discard paper with ragged or damaged hole edges. Do not allow chad (the little paper bits that result from punching) or paper dust to adhere to the paper.

Supplies with prepunched holes must conform to the following specifications:

- Maximum of four holes
- Maximum hole diameter of 10 mm (0.39 in.)
- Holes may not be located in, or protrude into the area marked by the diagonal lines in the following figures; otherwise, the paper sensor detects the holes and may give false paper jam errors.

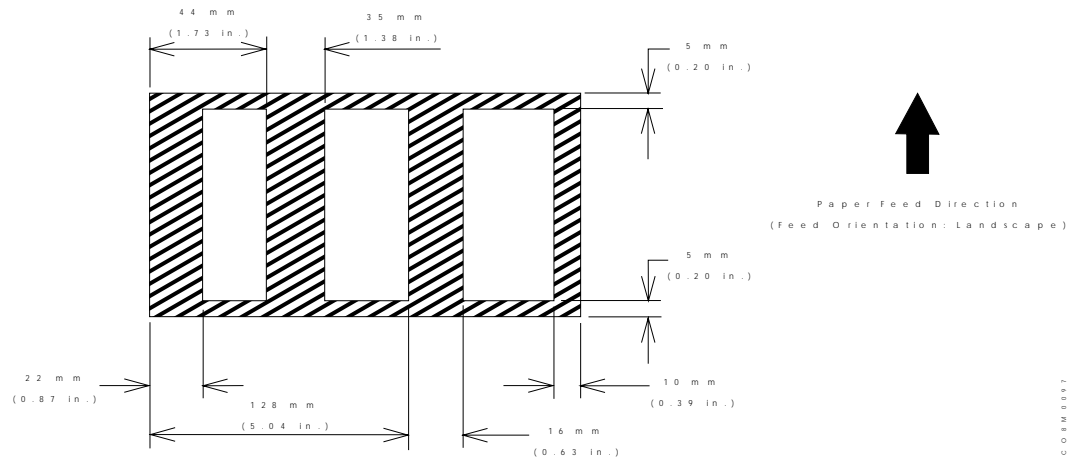

Figure 2. Prepunched Paper Clearances -- A4, B5, and Letter Size

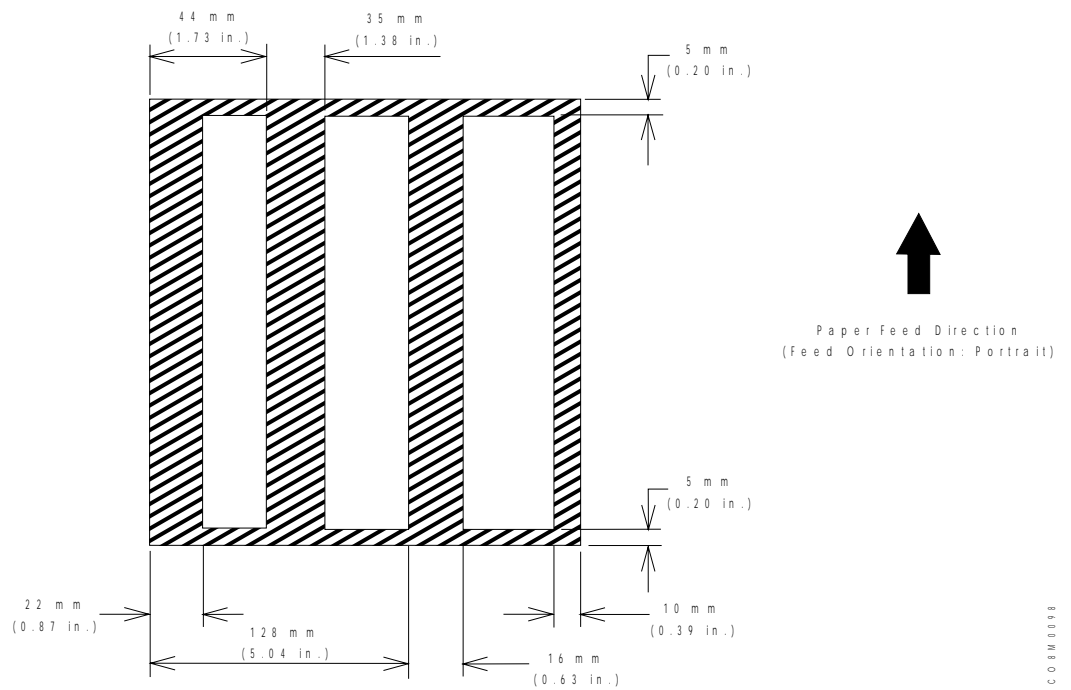

Figure 3. Prepunched Paper Clearances -- A3, B4, Legal, and Ledger Size

Paper Cassettes

Various paper cassettes are available and can be ordered in the sizes described in Table 1 on page 4.

Preprinted Paper

Preprinted paper has ink applied before the printer prints on it. Be sure that ink used in preprinting is non-volatile and contains drying or resin oils. Ink must not transfer when fusing temperatures are 200°C (392°F) and pressures are 450kPA (65 lbs/in²) for several seconds. IBM recommends the following inks:

- Cured by ultraviolet
- Cured by heat (Tinplate ink)
- Dried by oxidative polymerization

The shaded area in Figure 4 should not contain printing. Printing in this area can cause false double-sheet feeds.

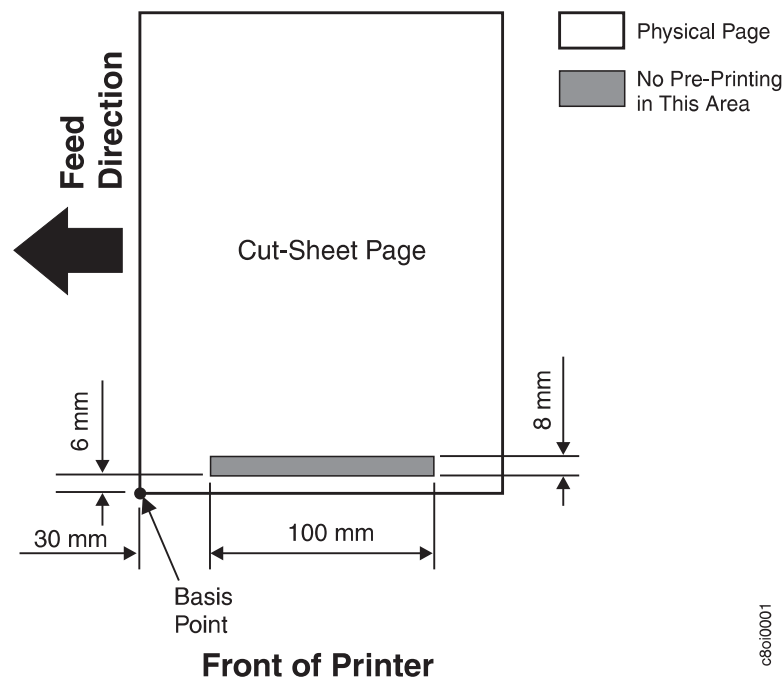

Figure 4. Preprinted Sheet

Envelopes

For optimum printing results, use either new 90 g/m² (24 lb) sulfite (100% chemical wood pulp) or 25% cotton bond envelopes. Before ordering large quantities of your envelopes, run several small jobs to make sure that they work properly. This includes envelopes with rough or highly textured surfaces, such as laid finishes.

The laser-printing process heats envelopes to a temperature of 175°C (350°F). Use only envelopes that are able to withstand these temperatures without sealing, excessive curling, wrinkling, or releasing hazardous emissions. Check with the supplier of the envelopes you plan to use to determine if they are usable with laser printers.

For optimum performance and to prevent paper jams, do not use envelopes that

- Have excessive curl or twist
- Are stuck together
- Are damaged in any way
- Contain windows, holes, perforations, cutouts, or deep embossing
- Have exposed flap adhesive when the flap is placed in the sealed or closed position
- Have interlocking design
- Have postage stamps attached

Table 13 summarizes recommendations that can help you and your envelope supplier choose envelopes that are the most suitable for your 3130.

<i>Table 13. Envelope Recommendations</i>	
Parameter	Recommendation
Fiber Composition	Preferred: 100% chemical wood pulp Acceptable: 25% cotton bond
Total Basis Weight	75 to 90 g/m ² (20 to 24 lb)

The 3130 supports the following standard envelope sizes:

Commercial: #10: 114 x 241 mm (4.5 x 9.5 in)
ISO international DL: 110 x 220 mm (4.3 x 8.7 in)

Table 14 and Figure 5 on page 36 show other allowable dimensions.

<i>Table 14. Envelope Dimensions</i>		
Dimensions	Maximum	Minimum
A	254 mm (10 in)	162 mm (6.4 in)
B	140 mm (5.5 in)	95 mm (3.7)
C	-	41 mm (1.6 in) See note.
D	200 mm (7.9 in)	137 mm (5.4 in)
E	-	110 mm (4.3 in)
F	70 mm (2.8)	-
Note: The C dimension must be 41 mm or greater and the angle (θ) must be greater than zero.		

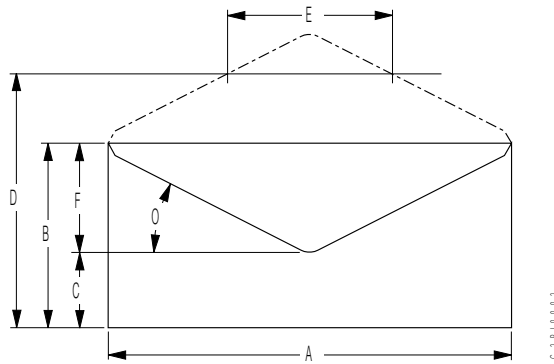

Figure 5. Envelope Dimensions

Selecting, Testing, and Ordering Paper Forms

To get the maximum print quality and reliability from your 3130, IBM recommends that you rely on the *Advanced Function Printer Cut-Sheet Paper Reference*, your paper forms supplier, and your marketing representative to help you choose the best forms and special-purpose materials for your applications.

Storing Paper and Supplies

Store paper and supplies that you intend to use soon near the printer, both for convenience and to condition the paper.

Otherwise, store paper and supplies

- In their original wrappers, away from heat or dampness
- On a flat surface, such as a shelf, but not on the floor
- In a closable cabinet for protection and monitoring.

Store forms and special-purpose materials in an area where the temperature and humidity are similar to the environment where you will use them. Avoid areas with extreme heat or humidity. Extended exposure to extremes can permanently damage the materials. Storing forms in an area where relative humidity is above 65% may result in reduced print quality.

To condition IBM 3130 supplies, store them in the same environment as the printer for at least 24 hours before you use them. At other times, supplies may be stored in an environment that does not exceed the following requirements:

Temperature -10° to 40°C (14° to 104°F)
Relative Humidity 5% to 80%

For additional information on storing and conditioning supplies, refer to *Advanced Function Printer Cut-Sheet Paper Reference*.

Appendix A. 3130 Font Set

Chapter Overview

This appendix describes 3130 single byte character set (SBCS) and double byte character set (DBCS) font support, including:

- The contents of the IBM Strategic Font Set (IPDS):
 - “IBM Core Interchange Resident Scalable Font Set (IPDS-Only)”
 - “4028 Compatibility Resident Font Set (IPDS-Only)” on page 42
 - “IBM Coordinated Font Set (IPDS-Only)” on page 44
 - “DBCS Resident Raster Font Set (IPDS-Only)” on page 45
 - “DBCS Resident Scalable (Outline) Fonts (IPDS-Only)” on page 47
- “PostScript Resident Font Set” on page 52
- “PCL5e Resident Font Set” on page 55
- A description of the 3130 default font, as well as other fonts you can select as the default font. See “Default Font (IPDS-Only)” on page 49.
- 3130 support of the AS/400 “bolding” function. See “AS/400 Bolding Function, Native and OfficeVision (IPDS-Only)” on page 50.

IBM Core Interchange Resident Scalable Font Set (IPDS-Only)

Table 15 lists the type faces in the IBM Core Interchange Resident Scalable Font Set, the 3130 resident typefaces, as well as the valid Font Global ID (FGID) and Graphic Character Set Global ID (GCSGID) for each typeface. Table 16 on page 39 lists the valid GCSGID subsets for each GCSGID listed in Table 15. Table 17 on page 39 lists the Code Pages that correspond to each typeface.

Typeface	FGID	GCSGID
Latin 1/2/3/4/5		
Times New Roman Medium	2308	1269
Times New Roman Bold	2309	1269
Times New Roman Italic Medium	2310	1269
Times New Roman Italic Bold	2311	1269
Helvetica Roman Medium	2304	1269
Helvetica Roman Bold	2305	1269
Helvetica Italic Medium	2306	1269
Helvetica Italic Bold	2307	1269
Courier Roman Medium	416	1269
Courier Roman Bold	420	1269
Courier Italic Medium	424	1269

Table 15 (Page 2 of 3). IBM Core Interchange Resident Scalable Font Set

Typeface	FGID	GCSGID
Courier Italic Bold	428	1269
Symbols		
Times New Roman Medium	2308	1275
Times New Roman Bold	2309	1275
Helvetica Roman Medium	2304	1275
Helvetica Roman Bold	2305	1275
Courier Roman Medium	416	1275
Courier Roman Bold	420	1275
Cyrillic Greek		
Times New Roman Medium	2308	1300
Times New Roman Bold	2309	1300
Times New Roman Italic Medium	2310	1300
Times New Roman Italic Bold	2311	1300
Helvetica Roman Medium	2304	1300
Helvetica Roman Bold	2305	1300
Helvetica Italic Medium	2306	1300
Helvetica Italic Bold	2307	1300
Courier Roman Medium	416	1300
Courier Roman Bold	420	1300
Courier Italic Medium	424	1300
Courier Italic Bold	428	1300
Arabic		
ITC Boutros Setting Medium	2308	1264
ITC Boutros Setting Bold	2309	1264
ITC Boutros Setting Italic Medium	2310	1264
ITC Boutros Setting Italic Bold	2311	1264
ITC Boutros Modern Rokaa Medium	2304	1264
ITC Boutros Modern Rokaa Bold	2305	1264
ITC Boutros Modern Rokaa Italic Medium	2306	1264
ITC Boutros Modern Rokaa Italic Bold	2307	1264
Boutros Typing Medium	416	1264
Boutros Typing Bold	420	1264
Boutros Typing Italic Medium	424	1264
Boutros Typing Italic Bold	428	1264
Hebrew		
Narkissim Medium	2308	1265
Narkissim Bold	2309	1265
Narkissim Italic Medium	2310	1265

Table 15 (Page 3 of 3). IBM Core Interchange Resident Scalable Font Set

Typeface	FGID	GCSGID
Narkissim Italic Bold	2311	1265
Narkiss Tam Medium	2304	1265
Narkiss Tam Bold	2305	1265
Narkiss Tam Italic Medium	2306	1265
Narkiss Tam Italic Bold	2307	1265
Shalom Medium	416	1265
Shalom Bold	420	1265
Shalom Italic Medium	424	1265
Shalom Italic Bold	428	1265

GCSGID Subsets for IBM Core Interchange Fonts

Table 16 lists the valid GCSGID subsets for each GCSGID listed in Table 15 on page 37.

Table 16. GCSGID Subsets for IBM Core Interchange Fonts

GCSGID	Valid GCSGID Subsets
1269	0101, 0103, 0119, 0251, 0265, 0269, 0273, 0277, 0281, 0285, 0288, 0289, 0293, 0297, 0301, 0305, 0309, 0313, 0317, 0321, 0325, 0329, 0337, 0341, 0611, 0697, 0919, 0959, 0965, 0980, 0982, 0983, 0987, 0990, 0991, 0993, 0995, 1111, 1132, 1133, 1145, 1146, 1149, 1152, 1166, 1167, 1174, 1188, 1189, 1198, 1220, 1232, 1233, 1237, 1256, 1258, 1259, 1260, 1261, 1268, 1286, 1301, 1302, 2039
1275	0340, 0630, 0909, 1191, 1257
1264	0235, 0994, 1154, 1162, 1177, 1244
1265	0941, 0687, 0986, 0992, 1147, 1199, 1217, 1218
1300	0218, 0925, 0960, 0981, 0985, 0996, 0998, 1150, 1190, 1231, 1235, 1249, 1251, 1276, 1401

IBM Core Interchange Resident Code Page Set

Table 17 lists the code pages used with the IBM Core Interchange Resident Fonts.

Table 17 (Page 1 of 4). IBM Core Interchange Resident Code Page Set

CPGID	GCSGID	Language Supported
Latin 1 Country Extended Code Pages		
037	697	US English, Canadian English, Canadian French, Dutch, Brazilian Portuguese, Portuguese
273	697	German
274	697	Belgian
275	697	Brazilian
277	697	Danish, Norwegian
278	697	Finnish, Swedish

<i>Table 17 (Page 2 of 4). IBM Core Interchange Resident Code Page Set</i>		
CPGID	GCSGID	Language Supported
280	697	Italian
281	697	Japanese
282	697	Portuguese
284	697	Castillian Spanish, Latin American Spanish
285	697	UK English
297	697	French, Catalan
500	697	Multinational, Belgium French, Belgium Dutch, Swiss French, Swiss German, Swiss Italian
871	697	Icelandic
Latin 1 EBCDIC Publishing Code Pages		
361	1145	Multinational, Belgium French, Belgium Dutch, Swiss French, Swiss German, Swiss Italian
382	1145	German
383	1145	Belgian
384	1145	Brazilian Portuguese
385	1145	Canadian French
386	1145	Danish, Norwegian
387	1145	Finnish, Swedish
388	1145	French, Catalan
389	1145	Italian
390	1145	Japanese
391	1145	Portuguese
392	1145	Castillian Spanish
393	1145	Latin American Spanish
394	1145	UK English
395	1145	US English, Canadian English
Latin 1 ASCII Code Pages		
437	919	Multinational, US English, UK English, Dutch, German, Finnish, French, Italian, Spanish, Swedish
850	980	Multinational PC
860	990	Portuguese (Primary = 850)
861	991	Icelandic (Primary = 850)
863	993	Canadian French (Primary = 850)
865	995	Nordic (Primary = 850)
1004	1146	IBM PC Desktop Publishing
819	697	ISO Latin 1
Latin 2/3/4/5 EBCDIC and ASCII Code Pages		
852	982	Croatian, Czech, East German, Hungarian, Polish, Romanian, Slovak, Slovenian

Table 17 (Page 3 of 4). IBM Core Interchange Resident Code Page Set

CPGID	GCSGID	Language Supported
870	959	Latin 2 Multilingual
912	959	Latin 2 ISO/ ANSI 8 Bit
853	983	Latin 3 Multilingual PC
905	1286	Latin 3 Multilingual
1069	1256	Latin 4 ISO/ASCII
914	1256	Latin 4 EBCDIC
857	987	Latin 5 PC
920	1152	Latin 5 ISO/ANSI 8 Bit
1026	1152	Latin 5
Latin EBCDIC DCF Code Pages		
1002	1132	DCF Release 2 Compatibility
1003	1133	US Text Subset
1068	1259	Text with Numeric Spacing
1039	1258	GML List Symbols
Cyrillic and Greek EBCDIC and ASCII Code Pages		
880	960	Cyrillic Multilingual (Primary = 1025)
915	1150	Cyrillic ISO/ASCII 8 Bit
855	985	Cyrillic PC
866	996	Cyrillic #2 PC
1025	1150	Cyrillic Multilingual
423	218	Greek 183 (Primary = 875)
813	925	Greek ISO/ASCII 8 Bit
851	981	Greek PC (Primary = 869)
869	998	Greek PC
875	925	Greek
1039	1258	GML List Symbols
Arabic EBCDIC and ASCII Code Pages		
420	235	Arabic Bilingual
864	994	Arabic PC
1008	1162	Arabic ISO/ASCII 8 Bit
1029	1154	Arabic Extended ISO/ASCII 8 Bit
1046	1177	Arabic Extended ISO/ASCII 8 Bit
1039	1258	GML List Symbols
Hebrew EBCDIC and ASCII Code Pages		
916	941	Hebrew ISO/ASCII 8 Bit
1028	1199	Hebrew Publishing
424	941	Hebrew
803	1147	Hebrew Character Set A (Primary = 424)

<i>Table 17 (Page 4 of 4). IBM Core Interchange Resident Code Page Set</i>		
CPGID	GCSGID	Language Supported
856	986	Hebrew PC (Primary = 862)
862	992	Hebrew PC
1039	1258	GML List Symbols
Symbols		
259	340	Symbols, Set 7
899	340	Symbols, Set 7 ASCII
1087	1257	Symbols, Adobe
1038	1257	Symbols, Adobe ASCII
1091	1191	Symbols, Modified Set 7
1092	1191	Symbols, Modified Set 7 ASCII
363	630	Symbols, Set 8
829	909	Math Symbols

4028 Compatibility Resident Font Set (IPDS-Only)

Table 18 describes the 4028 Compatibility Resident Font Set.

Notes:

1. The 3130 substitutes Times New Roman (from the IBM Core Interchange Set) for the Times Roman fonts listed in Table 18.
2. Table 20 on page 44 describes the code pages that correspond to the Code Page column in Table 18.
3. Prestige fonts with a Code Page ID (CPGID) of 259 are mapped to the Courier Roman Medium Symbols font.
4. The Prestige Proportional Spaced font (FGID 164) is not supported as a resident font.

<i>Table 18 (Page 1 of 2). 4028 Compatibility Resident Font Set</i>						
Typeface	FGID	Alt FGID	Pitch	Point Size	Font width	Code Pages
APL	76		12	10	120	310
Boldface	159	20224	Proportional	12	120	A, B
Courier	11		10	12	144	259, A, B
Courier	85		12	10	120	259, A, B
Courier	223		15	9	96	A, B
Courier	254		17.1	8.5	84	A, B
Courier Bold	46		10	12	144	A, B
Courier Italic	18		10	12	144	A, B
Courier Italic	92		12	10	120	A, B

Typeface	FGID	Alt FGID	Pitch	Point Size	Font width	Code Pages
Letter Gothic	281		20	7.5	72	A, B
OCR A	19		10	12	144	892
OCR B	03		10	12	144	893
Prestige	86		12	10	120	259, A, B
Prestige	221		15	9	96	A, B
Prestige	256		17.1	8.5	84	A, B
Prestige Pica	12		10	12	144	259, A, B
Prestige Elite Bold	111		12	10	120	A, B
Prestige Elite Italic	112		12	10	120	A, B
Times Roman	5687	760	Typo	6	40	A
Times Roman	5687	751	Typo	8	53	A
Times Roman	5687	1051	Typo	10	67	A
Times Roman	5687	1351	Typo	12	80	A
Times Roman Bold	5707	1053	Typo	10	67	A
Times Roman Bold	5707	761	Typo	12	80	A
Times Roman Bold	5707	762	Typo	14	93	A
Times Roman Bold	5707	1803	Typo	18	120	A
Times Roman Bold	5707	2103	Typo	24	160	A
Times Roman Italic	5815	1056	Typo	10	67	A
Times Roman Italic	5815	763	Typo	12	80	A
Times Roman Bold Italic	5835	764	Typo	10	67	A
Times Roman Bold Italic	5835	765	Typo	12	80	A

Other Resident Fonts (IPDS-Only)

Table 19 shows a font included for other compatibility reasons. Table 20 on page 44 describes the code pages that correspond to the Code Page column in Table 19.

Typeface	FGID	Alt FGID	Pitch	Point Size	Font Width	Code Pages
Courier.17.	252		17.1	11	84	A,B

Compatibility Resident Code Page Set

Table 20 provides an explanation of the groups as used in the Code Pages column of Table 18 on page 42.

<i>Table 20. Compatibility Resident Code Page Set</i>	
CPGID	GCSGID
Group A	
037, 273, 274, 277, 278, 280, 281, 284, 285, 297, 500, 871	697
038, 367	103
260	341
276	277
286	317
287	321
288	325
1002	1132
Group B	
256 (Replaced by 500)	337
289 (Replaced by 500, but missing obsolete "Peseta" character)	329
Miscellaneous	
310	963
259	340
892	968
893	969

IBM Coordinated Font Set (IPDS-Only)

Table 21 on page 45 lists the IBM Coordinated font set typefaces resident in 3130. All of the listed fonts are scalable.

Where the IBM Core Interchange code pages are referenced in Table 17 on page 39, only the Latin 1 Country Extended, Latin 1 EBCDIC Publishing, Latin 1 ASCII and Latin EBCDIC DCF code pages are supported.

<i>Table 21. IBM Coordinated Font Set</i>			
Typeface	FGID	GCSGID	Code Pages
APL	307	1304	293, 310, 910
APL Bold	322	1304	293, 310, 910
Boldface	20224	2039	See Table 17 on page 39
Gothic Text	304	2039	See Table 17 on page 39
Letter Gothic	400	2039	See Table 17 on page 39
Letter Gothic Bold	404	2039	See Table 17 on page 39
OCR A	305	968	876, 892
OCR B	306	969	877, 893
Prestige	432	2039	See Table 17 on page 39
Prestige Bold	318	2039	See Table 17 on page 39
Prestige Italic	319	2039	See Table 17 on page 39
Katakana Gothic	304	1306	290, 897, 1027, 1041

GCSGID Subsets

Table 22 maps the valid subsets of the GCSGIDs listed for the Pennant Strategic Font Set 2.

<i>Table 22. GCSGID Subsets</i>	
GCSGID	Valid GCSGID Subsets
1304	0380, 0963, 1113
2039	0101, 0103, 0119, 0251, 0265, 0269, 0273, 0277, 0281, 0285, 0288, 0289, 0293, 0297, 0301, 0305, 0309, 0313, 0317, 0321, 0325, 0329, 0337, 0341, 0611, 0697, 0919, 0980, 0990, 0991, 0993, 0995, 1132, 1133, 1145, 1146, 1149, 1198, 1220, 1258, 1259, 1260
1306	0332, 1164, 1172, 1187

DBCS Resident Raster Font Set (IPDS-Only)

The following tables list the DBCS resident fonts that are available as a part of separately-orderable feature for the 3130. These fonts provide 240-pel capability for Japanese (Katakana), Korean, Simplified Chinese, Traditional Chinese, and Thai languages.

Notes:

1. These fonts are only available in raster form at 240 pel.
2. The 5 Japanese/Kanji DBCS fonts supported by 3820 ROM Font RPQ #8A5014 are included in the Japanese font set.
3. Your printer man or may not have all of these fonts, depending on the date of the code in your printer. Refer to *IBM 3130 Advanced Function Printer System Administration Guide* for how to determine the fonts your printer has.

Typeface	Box Size	Point Size	Font Width	GCSGID	CPGID	FGID
Mincho (M16F)	16x16	4.8	96	370	300	53559
Mincho (M24F)	24x24	7	140	370	300	53559
Mincho (Z24F)	24x24	7.2	144	370	300	53559
Mincho (M26F)	26x26	7.8	156	370	300	53559
Mincho (M32F)	32x32	10	180	370	300	53559
Mincho (M36F)	36x36	10.8	216	370	300	53559
Mincho (M40F)	40x40	12	240	370	300	53559
Mincho (M44F)	44x44	13.2	264	370	300	53559
Mincho (M48F)	48x48	14.4	288	370	300	53559
Mincho (M52F)	52x52	15.6	312	370	300	53559
Mincho (M64F)	64x64	19.2	384	370	300	53559
Gothic (G16F)	16x16	5	100	370	300	53815
Gothic (G20F)	20x24	7.2	120	370	300	53813
Gothic (G24F)	24x30	7	140	370	300	53813
Gothic (G32F)	32x32	9.6	192	370	300	53815
Gothic (G36F)	36x36	10.8	216	370	300	53815
Gothic (G40F)	40x40	12	240	370	300	53815
Gothic (G48F)	48x48	14.4	288	370	300	53815
Gothic (G64F)	64x64	19.2	384	370	300	53815
R-Gothic (R36F)	36x36	10.8	216	370	300	54071
R-Gothic (R40F)	40x40	12	240	370	300	54071
R-Gothic (R48F)	48x48	14.4	288	370	300	54071
R-Gothic (R64F)	64x64	19.2	384	370	300	54071

Typeface	Box Size	Point Size	Font Width	GCSGID	CPGID	FGID
Mincho (M24K)	24x24	7.2	144	934	834	53559
Mincho (M32K)	32x32	9.6	192	934	834	53559
Mincho (M36K)	36x36	10.8	216	934	834	53559
Mincho (M40K)	40x40	12	240	934	834	53559
Mincho (M48K)	48x48	14.4	288	934	834	53559
Mincho (M64K)	64x64	19.2	384	934	834	53559
Gothic (G16K)	16x16	4.8	96	934	834	53815
Gothic (G24K)	24x30	9	144	934	834	53813

<i>Table 25. Traditional Chinese Font Set</i>						
Typeface	Box Size	Point Size	Font Width	GCSGID	CPGID	FGID
Ming (M24T)	24x24	7.2	144	935	835	54583
Ming (M32T)	32x32	9.6	192	935	835	54583
Ming (M40T)	40x40	12	240	935	835	54583
Gothic (G16T)	16x16	4.8	96	935	835	53815

<i>Table 26. Simplified Chinese Font Set</i>						
Typeface	Box Size	Point Size	Font Width	GCSGID	CPGID	FGID
Song (S26P)	26x26	7.8	156	937	837	54327
Song (S32P)	32x32	9.6	192	937	837	54327
Song (S40P)	40x40	12	240	937	837	54327
Gothic (G16P)	16x16	4.8	96	937	837	53815

<i>Table 27. Thai Font Set</i>						
Typeface	Box Size	Point Size	Font Width	GCSGID	CPGID	FGID
Official (O40F)	24x40	12	144	939	839	57655
Official (O60F)	24x60	18	144	939	839	57655
Italics (I60F)	24x60	18	144	939	839	58039

DBCS Resident Scalable (Outline) Fonts (IPDS-Only)

The following tables list the Scalable DBCS resident fonts that are available as part of a separately orderable feature for the 3130. Table 30 on page 49 provides a mapping of the valid subsets of the GCSGIDs listed for the DBCS Resident Scalable Font Set.

<i>Table 28 (Page 1 of 2). DBCS Resident Scalable Font Set</i>			
Typeface	FGID	Code Page	Character Set GCSGID
Japanese			
Heisei Mincho	53248	300	1067
Heisei Kaku Gothic	53249	300	1067
Traditional Chinese			
Sung	54563	835	2070
Kai	54568	835	2070
Simplified Chinese			
Fang Song	54566	837	1082

Table 28 (Page 2 of 2). DBCS Resident Scalable Font Set

Typeface	FGID	Code Page	Character Set GCSGID
Hei	54565	837	1082
Kai	54568	837	1082
Song	54567	837	1082
Korean			
Myengjo	53560	834	1091
Gothic	53816	834	1091

DBCS Resident Scalable Code Page Set

The following tables list the code pages used with the DBCS Resident Scalable Fonts. UDC means User-Defined Characters.

Table 29. DBCS Resident Scalable Code Page Set

GCSGID	CPGID	Language and Width Supported
Japanese Code Pages		
1000	300	Japanese Full Width
1001	300	Japanese Full Width with User Defined Character (UDC) support.
1172	290	Japanese Half Width
1132	1002	Japanese Half Width
1172	1027	Japanese Half Width
1187	11041	Japanese Half Width
Traditional Chinese Code Pages		
0935	835	Chinese Full Width with UDC support
1030	835	Chinese Full Width
1175	37	Chinese Half Width
1189	1043	Chinese Half Width
1238	1114	Chinese Half Width
Simplified Chinese Code Pages		
0937	837	Chinese Full Width with UDC support
1020	837	Chinese Full Width
1174	836	Chinese Half Width
1240	1115	Chinese Half Width
Korean Code Pages		
0934	834	Korean Full Width with UDC support
1010	834	Korean Full Width
1173	833	Korean Half Width
1327	1088	Korean Half Width

GCSGID Subsets for the DBCS Resident Scalable Font Set

Table 30 lists the valid GCSGID subsets for each GCSGID listed in Table 28 on page 47 and the valid subsets (denoted by an asterisk '*') for GCSGIDs intended for user-defined font sets.

GCSGID	Valid GCSGID Subsets
1067	1000, 1132, 1172, 1187
1068*	1001, 1067
1082	1020, 1174, 1240
1083*	937, 1082
1091	1010, 1173, 1327
1092*	934, 1091
2070	1030, 1175, 1189, 1238
2071*	935, 2070

Default Font (IPDS-Only)

The default font for the 3130 is Courier Roman Medium 12 pitch (10 point) using code page 500, version 1.

The printer operator can change the default font and code page by selecting from the code pages listed below.

Code Page	Description	Typefaces/Sized (CPI)
500	Belgian, Swiss / International	See Note
037	US, Canadian, Dutch, Portuguese	See Note
038	US English ASCII	See Note
260	Canadian French	See Note
273	Austrian / German	See Note
274	Belgian	See Note
277	Danish / Norwegian	See Note
278	Finnish / Swedish	See Note
280	Italian	See Note
281	Japanese	See Note
284	Spanish	See Note
285	UK English	See Note
286	Austrian / German (alternate)	See Note
287	Danish / Norwegian (Alternate)	See Note
288	Finnish / Swedish (Alternate)	See Note

<i>Table 31 (Page 2 of 2). Selectable Default Fonts</i>		
Code Page	Description	Typefaces/Sized (CPI)
290	Japanese / Katakana	Katakana Gothic Medium/10 and 12
297	French	See Note
420	Arabic	Boutros Typing Medium/10 and 12 Boutros Typing Bold/10 and 12 Boutros Typing Italic Medium/10 and 12 Boutros Typing Italic Bold/10 and 12
423	Greek	See Note
424	Hebrew	Shalom Medium/10 and 12 Shalom Bold/10 and 12 Shalom Italic Medium/10 and 12 Shalom Italic Bold/10 and 12
870	Latin 2 Multilingual	See Note
871	Icelandic	See Note
880	Cyrillic	See Note
892	OCR - A	Medium/10
893	OCR - B	Medium/10
905	Turkish	See Note
1026	Turkish	See Note
875	Greek	See Note
Note: Courier Medium/10 and 12 Courier Bold/10 and 12 Courier Italic/10 and 12 Courier Italic Bold/10 and 12		

AS/400 Bolding Function, Native and OfficeVision (IPDS-Only)

The following tables show the typeface substitutions that occur on the 3130 printer when an application running in native OS/400 or OfficeVision uses the “bolding” function. The tables list the original typeface, the typeface that the 3130 substitutes, and the FGIDs of both.

Notes:

1. This support is available for resident fonts only.
2. The bold font may have different metrics than the original font; this can affect line endings.

<i>Table 32 (Page 1 of 2). IBM Core Interchange Resident Scalable Font Set</i>			
Requested Font	FGID	Result	FGID
Latin 1/2/3/4/5			
Times New Roman Medium	2308	Times New Roman Bold	2309

<i>Table 32 (Page 2 of 2). IBM Core Interchange Resident Scalable Font Set</i>			
Requested Font	FGID	Result	FGID
Times New Roman Italic Medium	2310	Times New Roman Italic Bold	2311
Helvetica Roman Medium	2304	Helvetica Roman Bold	2305
Helvetica Italic Medium	2306	Helvetica Italic Bold	2307
Courier Roman Medium	416	Courier Roman Bold	420
Courier Italic Medium	424	Courier Italic Bold	428
Symbols			
Times New Roman Medium	2308	Times New Roman Bold	2309
Helvetica Roman Medium	2304	Helvetica Roman Bold	2305
Courier Roman Medium	416	Courier Roman Bold	420
Cyrillic Greek			
Times New Roman Medium	2308	Times New Roman Bold	2309
Times New Roman Italic Medium	2310	Times New Roman Italic Bold	2311
Helvetica Roman Medium	2304	Helvetica Roman Bold	2305
Helvetica Italic Medium	2306	Helvetica Italic Bold	2307
Courier Roman Medium	416	Courier Roman Bold	420
Courier Italic Medium	424	Courier Italic Bold	428
Arabic			
ITC Boutros Setting Medium	2308	ITC Boutros Setting Bold	2309
ITC Boutros Setting Italic Medium	2310	ITC Boutros Setting Italic Bold	2311
ITC Boutros Modern Rokaa Medium	2304	ITC Boutros Modern Rokaa Bold	2305
Boutros Typing Medium	416	Boutros Typing Bold	420
Boutros Typing Italic Medium	424	Boutros Typing Italic Bold	428
Hebrew			
Narkissim Medium	2308	Narkissim Bold	2309
Narkissim Italic Medium	2310	Narkissim Italic Bold	2311
Narkiss Tam Medium	2304	Narkiss Tam Bold	2305
Narkiss Tam Italic Medium	2306	Narkiss Tam Italic Bold	2307
Shalom Medium	416	Shalom Bold	420
Shalom Italic Medium	424	Shalom Italic Bold	428

<i>Table 33 (Page 1 of 2). 4028 Compatibility Resident Font Set</i>			
Requested Font	FGID	Result	FGID
Courier	11	Courier Roman Bold	420
Courier	85	Courier Roman Bold	420
Courier	223	Courier Roman Bold	420
Courier	254	Courier Roman Bold	420
Courier Italic	18	Courier Italic Bold	428

Table 33 (Page 2 of 2). 4028 Compatibility Resident Font Set

Requested Font	FGID	Result	FGID
Courier Italic	92	Courier Italic Bold	428
Letter Gothic	281	Letter Gothic Bold	404
Prestige	86	Prestige Bold	318
Prestige	221	Prestige Bold	318
Prestige	256	Prestige Bold	318
Prestige Pica	12	Prestige Bold	318
Times Roman	5687	Times New Roman Bold	2309
Times Roman	5687/751	Times New Roman Bold	2309
Times Roman	5687/1051	Times New Roman Bold	2309
Times Roman	5687/1351	Times New Roman Bold	2309
Times Roman Italic	5815/1056	Times New Roman Italic Bold	2311
Times Roman Italic	5815	Times New Roman Italic Bold	2311

Table 34. IBM Coordinated Font Set

Requested Font	FGID	Result	FGID
APL	307	APL Bold	322
Letter Gothic	400	Letter Gothic Bold	404
Prestige	432	Prestige Bold	318

PostScript Resident Font Set

This font set is available in SBCS outline 300 pel only.

The 3130 has three sets of resident PostScript fonts. These three sets are:

- Fifty-six Type 1 fonts. A few of these fonts have names that are identical to names of fonts in the set of Adobe standard fonts.
- Thirteen duplicate Type 1 fonts with different names. These fonts are duplicates of fonts from the first set, with their names changed for IBM compatibility purposes.
- Ten Type 42 Fonts. These are TrueType fonts converted to Type 42 format for use by PostScript. Some of them have significantly fewer characters than PostScript fonts normally have. None of them provide all of the characters for the PostScript Standard encoding or ISO Latin 1 encoding.

Adobe Type 1 Fonts

Font Name used in PostScript Programs	Full Name of Font
AvantGarde-Demi	ITC Avant Garde Gothic Demi
Avant Garde-DemiOblique	ITC Avant Garde Gothic Demi Oblique

Font Name used in PostScript Programs	Full Name of Font
AvantGarde-Book	ITC Avant Garde Gothic Book
AvantGarde-BookOblique	ITC Avant Garde Gothic Book Oblique
CourierAPL2	Courier APL2
CourierAPL2-Bold	Courier APL2 Bold
Boldface-Bold	Boldface Bold
Bookman-Demi	ITC Bookman Demi
Bookman-Demitalic	ITC Bookman Demi Italic
Bookman-Light	ITC Bookman Light
Bookman-Lightitalic	ITC Bookman Light Italic
CenturySchlbk-Bold	Century Schoolbook Bold
CenturySchlbk-BoldItalic	Century Schoolbook Bold Italic
CenturySchlbk-Italic	Century Schoolbook Italic
Courier	Courier
CourierSymbols	Courier Symbols
CourierSymbols-Bold	Courier Symbols Bold
Courier-Bold	Courier Bold
Courier-BoldItalic	Courier Bold Italic
Courier-Italic	Courier Italic
CenturySchlbk-Roman	Century Schoolbook Roman
GothicText	Gothic Text
GothicKatakana	Gothic Katakana
Helvetica	Helvetica
HelveticaSymbols	Helvetica Symbols
HelveticaSymbols-Bold	Helvetica Symbols Bold
Helvetica-Bold	Helvetica Bold
Helvetica-BoldItalic	Helvetica Bold Italic
Helvetica-Italic	Helvetica Italic
Helvetica-Black	Helvetica Black
Helvetica-BlackOblique	Helvetica Black Oblique
Helvetica-Light	Helvetica Light
Helvetica-LightOblique	Helvetica Light Oblique
Helvetica-Narrow	Helvetica Narrow
Helvetica-Narrow-BoldOblique	Helvetica Narrow Bold Oblique
Helvetica-Narrow-Oblique	Helvetica Narrow Oblique
LetterGothic	Letter Gothic
LetterGothic-Bold	Letter Gothic Bold
OCRA	OCR A
OCRB	OCR B
Palatino-Bold	Palatine Bold

Font Name used in PostScript Programs	Full Name of Font
Palatino-BoldItalic	Palatino Bold Italic
Palatino-Italic	Palatino Italic
Palatino-Roman	Palatino Roman
Prestige	Prestige
Prestige-Bold	Prestige Bold
Prestige-Italic	Prestige Italic
TimesNewRoman	Times New Roman
TimesNewRomanSymbols	Times New Roman Symbols
TimesNewRomanSymbols-Bold	Times New Roman Symbols Bold
TimesNewRoman-Bold	Times New Roman Bold
TimesNewRoman-BoldItalic	Times New Roman Bold Italic
TimesNewRoman-Italic	Times New Roman Italic
ZapfChancery-MediumItalic	ITC Zapf Chancery Medium Italic
ZapfDingbats	ITC Zapf Dingbats

Duplicate Type 1 Fonts

Font Name used in PostScript Programs	Full Name of Font
NewCenturySchlbk-BoldItalic	Century Schoolbook Bold Italic
NewCenturySchlbk-Bold	Century Schoolbook Bold
NewCenturySchlbk-Italic	Century Schoolbook Italic
Courier-BoldOblique	Courier Bold Italic
Courier-Oblique	Courier Italic
NewCenturySchlbk-Roman	Century Schoolbook Roman
Helvetica-BoldOblique	Helvetica Bold Italic
Helvetica-Oblique	Helvetica Italic
Palatino	Palatino Roman
Times-Roman	Times New Roman
Times-Bold	Times New Roman Bold
Times-BoldItalic	Times New Roman Bold Italic
Times-Italic	Times New Roman Italic

Type 42 Fonts

For six of these fonts, the names are the names of the corresponding Type 1 typeface. Four of them have names that start with the names of the corresponding Type 1 typeface, and have a "TT" suffix. The "TT" distinguishes them from the like-named Type 1 fonts, so that you can access both of them.

Font Name used in PostScript Programs	Full Name of Font
Arial	Arial
Ariel-Bold	Ariel Bold
Arial-BoldItalic	Arial Bold Italic
Arial-Italic	Arial Italic
TimesNewRomanTT	Times New Roman
TimesNewRoman-BoldTT	Times New Roman Bold
TimesNewRoman-BoldItalicTT	Times New Roman Bold Italic
TimesNewRoman-ItalicTT	Times New Roman Italic
Wingdings	Wingdings
Symbol	Symbol

The Arial and Times New Roman font families in this set are provided with the Windows 3.1 encoding and character set, except that the Medium Shading character at code point X'7F' is missing.

The Type 42 Symbol font provides all the characters and the same encoding used in the Adobe Type 1 Symbol font.

PCL5e Resident Font Set

This font set is available in SBCS outline 300 pel only.

Font Number	Typefaceion	Font Type (Symbol Set ID)
0	Courier	Intellifont
1	CG Times	Intellifont
2	CG Times Bold	Intellifont
3	CG Times Italic	Intellifont
4	CG Times Bold Italic	Intellifont
5	CG Omega	Intellifont
6	CG Omega Bold	Intellifont
7	CG Omega Italic	Intellifont
8	CG Omega Bold Italic	Intellifont
9	Coronet	Intellifont
10	Clarendon Condensed	Intellifont
11	Univers	Intellifont
12	Univers Bold	Intellifont
13	Univers Italic	Intellifont
14	Univers Bold Italic	Intellifont
15	Univers Condensed	Intellifont
16	Univers Condensed Bold	Intellifont
17	Univers Condensed Italic	Intellifont

Table 35 (Page 2 of 2). PCL5e Resident Fonts

Font Number	Typefaceion	Font Type (Symbol Set ID)
18	Univers Condensed Bold Italic	Intellifont
19	Antique Olive	Intellifont
20	Antique Olive Bold	Intellifont
21	Antique Olive Italic	Intellifont
22	Garamond Antiqua	Intellifont
23	Garamond Halbfett	Intellifont
24	Garamond Kursiv	Intellifont
25	Garamond Kursiv Halbfett	Intellifont
26	Marigold	Intellifont
27	Albertus Medium	Intellifont
28	Albertus Extra Bold	Intellifont
29	Arial	TrueType
30	Arial Bold	TrueType
31	Arial Italic	TrueType
32	Arial Bold Italic	TrueType
33	Times New Roman	TrueType
34	Times New Roman Bold	TrueType
35	Times New Roman Italic	TrueType
36	Times New Roman Bold Italic	TrueType
37	Symbol	TrueType
38	Wingdings	TrueType
39	Courier Bold	Intellifont
40	Courier Italic	Intellifont
41	Courier Bold Italic	Intellifont
42	Letter Gothic	Intellifont
43	Letter Gothic Bold	Intellifont
44	Letter Gothic Italic	Intellifont
45	Line Printer Roman-8	Bitmapped (8U)
46	Line Printer ISO 8859-1 Latin 1	Bitmapped (0N)
47	Line Printer PC-8	Bitmapped (10U)
48	Line Printer PC-8 D/N	Bitmapped (11U)
49	Line Printer PC-850	Bitmapped (12U)
50	Line Printer Legal	Bitmapped (1U)
51	Line Printer ISO 8859-2 Latin 2	Bitmapped (2N)
52	Line Printer ISO 8859-9 Latin 5	Bitmapped (5N)

Note: Intellifont and TrueType font sets are scalable; Bitmapped font sets are not.

Characteristics of the Bitmapped Font Sets are

Spacing Fixed
 Pitch 16.67 CPI
 Height 8.5 point
 Style Upright
 Weight Medium

PCL5e Language Support

Table 36 (Page 1 of 2). PCL5e Language Support

Symbol Set ID	Symbol Set	Language
8U	Roman-8	Roman-8
0N	ECMA-94 Latin 1	Latin 1
0N	ISO-8859-1 Latin 1	Latin 1
2N	ISO-8859-2 Latin 2	Latin 2
5N	ISO 8859-9 Latin 5	Latin 5
10U	PC-8	Multilingual
11U	PC-8 D/N	Danish/Norwegian
12U	PC-850	Multilingual
17U	PC-852	Latin 2
9T	PC Turkish	Turkish
19U	Windows 3.1 Latin 1	Latin 1
9E	Windows 3.1 Latin 2	Latin 2
5T	Windows 3.1 Latin 5	Latin 5
7J	Desktop	Multilingual
10J	PS Text	Multilingual
13J	Ventra International	Multilingual
14J	Ventura US	English
6J	Microsoft Publishing	Multilingual
8M	Math-8	Multilingual
5M	PS Math	Multilingual
6M	Ventura Math	Multilingual
15U	Pi Font	Multilingual
1U	Legal	Multilingual
1E	ISO-4 United Kingdom	UK
0U	ISO-6:ASCII	Multilingual
0S	ISO-11 Swedish Names	Swedish
0I	ISO-15 Italian	Italian
2S	ISO-17 Spanish	Spanish
1G	ISO-21 German	German
OD	ISO-60 Norwegian V1	Norwegian
1F	ISO-69 French	French

Table 36 (Page 2 of 2). PCL5e Language Support

Symbol Set ID	Symbol Set	Language
9U	Windows 3.0 Latin 1	Latin 1
12J	MC Text	Multilingual
19M	Symbol	Multilingual
579L	Wingdings	Multilingual

Appendix B. Software and Hardware Requirements

Important

Table 43 on page 68 summarizes the support that various versions of PSF provide the 3130. Note that the information it contains is subject to change, and therefore should be used for general planning only. For more detailed information about host software requirements, refer to *Advanced Function Presentation: Printer Information*, G544-3290.

Attachments

The 3130 supports up to three simultaneously active attachment interfaces with switching under microcode control. Only one IPDS host can be attached at a time. The following are standard with every 3130:

- PC Parallel Interface
- Ethernet Interface (10BaseT, 10Base2, or 10Base5)

One optional interface slot is available for one of the following:

- Twinaxial Interface
- Token-Ring Interface
- SDLC Interface

The data streams for each attachment are:

Attachment (Protocol)	Data stream
Twinaxial (Arctic)	IPDS
SDLC (SNA LU6.2 V.24)	IPDS
SDLC (SNA LU6.2 V.35)	IPDS
Token Ring (SNA LU6.2)	IPDS
Token Ring (TCP/IP)	IPDS/PCL-5e/PostScript L2
Token Ring (Novell SPX/IPX)	PCL-5e/PostScript L2
Ethernet (TCP/IP)	IPDS/PCL-5e/PostScript L2
Ethernet (Novell SPX/IPX)	PCL-5e/PostScript L2
PC Parallel (Converged)	PCL-5e/PostScript L2
Network Print Server*	PCL-5e/PostScript L2

* For Novell SPX/IPX, NetBios, and TCP/IP

Intelligent Printer Data Stream (IPDS) Considerations

Host system software is required for attaching to the host system and for creating the IPDS data stream. System software is the same set of AFP programs that are used for the AFP family of printers. The following central processing unit (CPU) configurations support the 3130:

- AS/400
- PS/2 and PC Local Area Networks (LAN)
- RISC System/6000 LAN
- ES/4381
- 308X
- ES/3090
- ES/9000
- ES/9370
- ES/9371

Connectivity to the host processors is through the following architectures:

- Twinaxial
- SDLC (SNA V.24 19.2 Kbps)
- SDLC (SNA V.35 56 Kbps)
- Token-Ring (SNA)
- Token-Ring (TCP/IP)
- Ethernet (TCP/IP)

Table 37. MVS Support

System	SDLC (SNA)	Token-Ring (SNA)	Token-Ring (TCP/IP) Ethernet (TCP/IP)
ES/4381	Yes	Yes	Yes
308X	Yes	Yes	Yes
ES/3090	Yes	Yes	Yes
ES/9000	Yes	Yes	Yes
ES/9370	Yes	No	Yes
ES/9371	Yes	No	Yes

Table 38. VSE Support

System	SDLC (SNA)	Token-Ring (SNA)
ES/4381	Yes	Yes
308X	Yes	Yes
ES/3090	Yes	Yes
ES/9000	Yes	Yes
ES/9370	Yes	No
ES/9371	Yes	No

System	SDLC (SNA)	Token-Ring (SNA)
ES/4381	Yes	Yes
308X	Yes	Yes
ES/3090	Yes	Yes
ES/9000	Yes	Yes
ES/9370	Yes	Yes
ES/9371	Yes	Yes

System	Twinax	SDLC (SNA)	Token-Ring (SNA)	Token-Ring (TCP/IP)	Ethernet (TCP/IP)
AS/400	Yes	Yes	Yes	Yes	Yes
PS/2	No	V.24 only	Yes	Yes	Yes
RISC/6000	No	No	No	Yes	Yes

PCL-5e and PostScript Considerations

The 3130 can support PCL-5e and PostScript through a variety of attachments. This section describes a few of them, but it is not a complete list.

Network Operating Systems

IBM OS/2 LAN Server

- Token Ring using TCP/IP and Ethernet using TCP/IP
- Network Print Server using TCP/IP and NetBios

Novell NetWare: Novell NetWare 3.11 and later releases support the 3130.

- Token Ring using IPX/SPX for print server mode only
- Ethernet using IPX/SPX for print server mode only
- Network print server attached to the printer PC parallel interface for remote printer mode or print server mode on Token Ring or Ethernet

Microsoft LAN Manager

- Token Ring using TCP/IP and Ethernet using TCP/IP
- Network Print Server using TCP/IP and NetBios

PCL-5e and PostScript Drivers

Although Table 41 on page 62 shows the drivers that are shipped with the 3130, IBM recommends that you get these drivers from the Internet and install them on your system before your machine arrives. The Universal Resource Locator (URL) for the World Wide Web is

<http://www.can.ibm.com/ibmprinters>

Note: Each driver has a README file. Print it and read it before installing or using the driver.

Driver Description	File Name	Diskette Format
Windows PCL	3130WIN.PCL	DOS
Windows PostScript	3130WIN.PS	DOS
OS/2 PCL	3130OS2.PCL	DOS
OS/2 PostScript	3130OS2.PS	DOS
AIX PCL-5e	3130.pcl	DOS
AIX PostScript	3130.ps	DOS

Table 42 lists several of the supported PCL-5e and PostScript systems and attachments.

System	Driver	PC Parallel	TCP/IP (*)	NetWare (*)
DOS	Windows 3.1 +	Yes	Yes	Yes
OS/2	OS/2 2.11 +	Yes	Yes	Yes
RISC/6000	colon file	Yes	Yes	Yes
Note: (*) Supports both Token-Ring and Ethernet				

IBM PS/2 and PC: The following workstation software supports the 3130 with PCL-5e and PostScript L2 data streams through print drivers shipped with the printer:

- OS/2 2.11 Service Pack and later (32 bit support only), including the OS/2 LAN Server
 - Note:** Before using IBM printer drivers on OS/2 2.11, obtain and install FixPac, XR_B103 on your workstation. To obtain FixPac, contact IBM OS/2 Support at 1-407-994-5544.
- Microsoft Windows 3.1 and Windows 95

RISC System/6000: AIX supports the 3130 through a “colon” file driver diskette shipped with the printer. AIX Version 3.2.5 and Version 4.1 are supported.

OS/400 Host Print Transforms

If you need to transform AFP into PCL-5e, OS/400 requires customization objects. See “Host Print Transforms for OS/400” on page 64 for more information about these objects.

PSF Support Notes

Basic N_Up and Enhanced N_Up Printing:

- Basic N_UP
 - Enables printing output that places one, two, three, or four pages in sequence in equal-sized partitions on each side of a sheet. Two 8.5 x 11 inch application pages can print two-up on a single 11 x 17 inch sheet. For duplex operations, each side of the form or sheet can have up to four pages.

- Enhanced N_UP (Page Positioning)

Enables the following:

- Page Orientation – places individual pages in any position on either side of the sheet in any orientation and in any size that fits on the sheet.
- Overlays – places overlays relative to any partition origin with or without variable page data from the application program. You can specify different overlays for each page.
- Offsets – specifies different offsets for each page.
- Form Ejection – ejects to a new partition or a new sheet.

PSF/MVS Support

- PSF/MVS V2.2.0:
 - With APAR OW12840, supports TCP/IP (Token Ring and Ethernet)
 - With APAR OW15018, allows the 3130 to accept input from non-IPDS attachments intermittently while the PSF attachment is active
 - With APAR OW14128, supports DBCS scalable (outline) fonts and capture of raster fonts
 - Supports N_UP
 - With APAR OW03243, supports Enhanced N_Up
 - With APAR OW08340 and IBM Font Collection for Operating Systems installed, can:
 - Activate the proper resident fonts without using the APSRMARK utility
 - Use downloaded and printer-resident outline fonts
 - Media-Destination Selection Function (Multiple Output Bin) support applies to:
 - MVS/ESA V4.2.0, V4.3.0, and V5.1.0
 - MVS/ESA JES3 V4.2.1 in support of PSF/MVS V2.2.0
 - For multiple output bin support:
 - PSF/MVS V2.2. with APAR OW07348
 - MVS/ESA V4.2.0, V4.3.0, and V5.1.0 with APAR OW04349
 - MVS/ESA JES3 V4.2.1 with APAR OW07286
- PSF/MVS V2.1 and later:
 - APAR OW08127 is required for five input bin support
 - The resident 3130 Core Set outline fonts are activated by host library raster fonts if you have identified them using the APSRMARK utility
 - PSF/MVS V2.1 does not support multiple input bins at the copy subgroup level
 - With APAR OW16190 supports capture of raster fonts

PSF/VSE Support

To use resident fonts, identify them to PSF/VSE, using the APTRMARK utility. Resident fonts are not supported when using the Data Facility Product (DFP).

PSF/VM Support

PSF/VM does not support resident fonts; however, you can print with fully described downloaded fonts.

PSF For OS/400 Support

- Version 3.1:
 - Requires a PTF for native 3130 support
 - Supports Basic N_Up but not Enhanced N_Up
 - Requires a PTF for DBCS resident font support
 - Does not support the font capture function
- Version 3.0.5:
 - Requires Cum Tape C4263305
 - Does not support N_Up or Enhanced N_Up
 - Configure the 3130 as a 3935
 - Supports outline font scaling only for whole font sizes (for example, 10, 12, 15 CPI ...)
- Version 2.3
 - Requires Cum Tape CA193230
 - Requires PTF C4193230
 - Does not support N_Up or Enhanced N_Up
 - Configures the 3130 as a 3935
 - Supports outline fonts scaling only for whole font sizes (for example, 10, 12, 15 CPI ...)
- Version 2.2:
 - This version went out of service on 31 March 95; it is included for reference only
 - Requires PTF SF16030 and SF16187
 - Only letter (8.5 x 11 in.) and legal (8.5 x 14 in.) size paper are supported
 - IBM AFP Multiple-up page capability is not supported; multiple-up page capability is available only by using the OS/400 function
 - Only the printer default output bin is supported (#5, first top stacker)
 - Supports outline font scaling only for whole font sizes (for example, 10, 12, 15 CPI ...)
- Printing with the large print function for OfficeVision/400 on the AS/400 is not supported by the 3130; also, the AS/400 (DDS) key word CHRISZ function is not supported by the 3130.
- Bolding is not supported on the following fonts when using OfficeVision/400 or the AS/400 (DDS) key word HIGHLIGHT function: Boldface, Gothic Text, Gothic Katakana, OCR A, OCR B, Prestige Italic, or fonts that are already bold-faced fonts.

Host Print Transforms for OS/400

Transforming an AFP or SCS data stream to PCL-5e requires one of several 3130 Customization Objects:

- IBM3130A: Is the Advanced Customization object for duplex and high-capacity simplex models. It contains tags for AFP-to-PCL5e transform support and requires V3.1 and PTF SF25752. The host supports all input paper trays.

- IBM313SA: Is the Advanced Customization object for the Model 01S (simplex). It contains tags for AFP-to-PCL5e transform support and requires V3.1 and PTF SF25752. The host supports selecting the side input tray (drawer 1), the top front input tray (drawer 2), and the optional envelope feeder.
- IBM3130: Is the pre-V3.1 Customization object for duplex and high-capacity simplex models. It operates with V2.3 or later. The host supports selecting the main and lower side tray and the optional envelope feeder.
- IBM313SA: Is the pre-V3.1 Customization object for the Model 01S (simplex). It operates with V2.3 or later. The host supports selecting the side input tray (drawer 1), the top front input tray (drawer 2), and the optional envelope feeder.

PSF/2 Support

- Resident fonts are not supported when using the DPF function of PSF/2.
- When using “PSF Direct,” the function supported is equivalent to that provided by the host PSF.

PSF for AIX Support

When using “PSF Direct,” the function supported is equivalent to that provided by the host PSF.

System Test

SNA Token-Ring uses NetView for recording errors. Token-Ring uses the ‘Self Test Frame’ on the ring itself.

For AS/400, use the Verify Print (VFYPRT) command to obtain the printer type and send a test print. The AS/400 uses ERAPs to log errors.

Applications (IPDS)

The 3130 prints text data referred to as Coded Information, image data referred to as Non-Coded Information, and GDDM raster graphics. You can print all of these at any location on the printed page and in any combination. Printing the mixture or combination of data at any printed page location is called all points addressable or APA printing.

Token Ring Network Attachment

For details on SNA, TCP/IP, or NetWare attachment, see *IBM InfoPrint 60; 3130, 3160, and 3935 Advanced Function Printer: Attachment Configuration Handbook*.

The 3130 connects to a host Token-Ring through the IBM Token-Ring cabling. It uses the Auto Token-Ring LANStreamer Adapter which is installed in the AFCCU. The adapter and an 8-foot long external cable are provided when this feature is ordered. The external cable is connected to an IBM 8228 Token-Ring Multistation Access Unit or an IBM 8230 Token-Ring Network Controller Access Unit, which is connected as follows:

- Directly to a PS/2, AS/400, or RISC System/6000 CPU
- To a 3172, 3174, 3720, 3725, or 3745, which in turn is connected directly to a ES/4381, 308X, ES/3090, or ES/9000 CPU

The control unit can attach to either a 4Mbps or 16Mbps Token-Ring Local Area Network.

The attachment adheres to the IBM Token-Ring Network OEMI. The following documents, together, compose the IBM Token-Ring Network Other Equipment Manufacture Interface:

- *IBM Cabling System Technical Interface Specification, GA27-3773*
- *IBM Local Area Network Technical Reference, SC30-3383*
- *IBM Token-Ring Area Network Architecture Reference, SC30-3374*
- *Carrier Sense Multiple Access with Collision Detection, IEEE Std 802.3-1985*
- *Token-Ring Access Method and Physical Layer Specification, IEEE Standard 802.5-1989*

The 3130 can be a maximum distance of 100 meters from the 8228 Multistation Access Unit or 8230 Controlled Access Unit. For more information, refer to the 8228 and 8230 Product Publications. For cable attachment options from the 8228 or 8230 to the host system CPU, refer to the specific CPU cabling information.

Ethernet Network Attachment

For details on TCP/IP or NetWare attachment, see *IBM InfoPrint 60; 3130, 3160, and 3935 Advanced Function Printer: Attachment Configuration Handbook*.

The 3130 offers one of three Ethernet attachment types as an optional feature:

10Base-T (Twisted Pair)

The 3130 can attach to standard Twisted Pair (10BaseT) cable. The feature attachment includes the type 10BaseT transceiver and the transceiver cable used to connect the transceiver to the printer. RJ45 unshielded twisted pair cable (which must meet IEEE 802.3 requirements) is required to attach the 10BaseT transceiver to the Ethernet Twisted Pair Network. A wrap plug is included with the feature for diagnostic purposes.

Connection can be either directly to a RISC System/6000 or to a 8250 or 8260 Twisted Pair Hub (which connects to a RISC System/6000 or a PS/2).

10Base2 (Thin Coaxial)

The 3130 can attach to standard Thin type 10Base2 Ethernet coaxial cable. The attachment includes the type 10Base2 transceiver and the transceiver cable used to connect the transceiver to the printer. The transceiver attaches to a standard Thin Ethernet Network. A wrap plug is included with the feature for diagnostic purposes.

Connection is made directly to a RISC System/6000, PS/2, or AS/400.

10Base5 (Thick Coaxial)

The 3130 can attach to standard Thick type 10Base5 Ethernet coaxial cable. A type 10Base5 cable is required to connect the D-connector on the printer to the 10Base5 network. A wrap plug is included with the feature for diagnostic purposes.

Connection is made directly to a RISC System/6000, PS/2, or AS/400.

PSF Support Summary

Table 43 on page 68 summarizes the support that various versions of PSF provide the 3130.

Table 43. PSF Support Summary (IPDS)

Function	PSF/MVS		PSF/VSE V2.2.1	PSF/VM V2.1.1	PSF for OS/400			PSF/6000 V1.2/ PSF for AIX V2.1	PSF/2 V2.0
	V2.2.0	V2.1, V.2.1.1			V3.1	V2.3, V3.0.5	V2.2		
Base Support:									
3935 Emulation	No	No	Yes	Yes	Yes	Yes (PTF)	Yes (PTF)	NA/NA	NA
Native	Yes	Yes	Yes	Yes	Yes	No	No	NA/NA	NA
300 Pci	Yes	Yes	Yes	Yes	Yes	Yes	Yes	Yes/Yes	Yes
240 Pci	Yes	Yes	Yes	Yes	Yes	Yes	Yes	Yes/Yes	Yes
Multiple Input (sources)	Yes (5)	Yes (5)	Yes (5)	Yes (5)	Yes (5)	Yes (4)	Yes (3)	Yes (4)/Yes (5)	Yes (4)
Multiple Output (stackers)	Yes (3)	No	Yes (3)	No	Yes (3)	No	No	No/Yes	No
IPDS Towers:	All	All	All	All	All	All	All	All/All	All
Printer Connectivity:									
Token-ring SNA	Yes	Yes	Yes	Yes	Yes	Yes	Yes	No/No	Yes
SDLC SNA	Yes	Yes	Yes	Yes	Yes	Yes	Yes	No/No	Yes
Ethernet TCP/IP	Yes	No	No	No	Yes	No	No	Yes/Yes	Yes
Token-Ring TCP/IP	Yes	No	No	No	Yes	No	No	Yes/Yes	Yes
Twinaxial	No	No	No	No	Yes	Yes	No	No/No	No
Downloadable Raster Fonts	Yes	Yes	Yes	Yes	Yes	Yes	Yes	Yes	Yes
Downloadable Outline Fonts									
SBCS	Yes	No	No	No	No	No	No	No/Yes	No
DBCS	No	No	No	No	No	No	No	No/No	No
SBCS Font Resident									
4028 (Raster)	Yes	Yes	Yes	No	Yes	Yes	No	No	No
Core	Yes	Yes	Yes	No	Yes	Yes	No	No	No
Coordinated	No	No	Yes	No	Yes	Yes	No	No	No
DBCS Resident Fonts (Rasters)	Yes	Yes	Yes	No	No	No	No	No	No
DBCS Resident Fonts (Outline)	Yes	No	Yes	No	No	No	No	Yes	No

Attachment Hardware

- The Ethernet TCP/IP interface attaches to the following network configurations:
 - RS/6000, AS/400, and PS/2 Ethernet 10BaseT Networks
 - RS/6000, AS/400, and PS/2 Ethernet 10Base2 Networks
 - RS/6000, AS/400, and PS/2 Ethernet 10Base5 Networks
 - ES/4381, 308X, ES/3090, or ES/9000 CPU
- The Ethernet NetWare interface attaches to the following network configurations:
 - RS/6000 and PS/2 Ethernet 10BaseT Networks
 - RS/6000 and PS/2 Ethernet 10Base2 Networks
 - RS/6000 and PS/2 Ethernet 10Base5 Networks
- The Token-Ring TCP/IP interface attaches to either 4Mbps or 16Mbps Token Ring networks through the following devices:
 - 8228 Token-Ring Multistation Access Unit attached to an RS/6000, an AS/400, or a PS/2
 - 8230 Token-Ring Network Controller Access Unit attached to an RS/6000, an AS/400, or a PS/2
- The Token-Ring NetWare interface attaches to either 4Mbps or 16Mbps Token-Ring networks through the following devices:
 - 8228 Token-Ring Multistation Access Unit attached to an RS/6000 or a PS/2
 - 8230 Token-Ring Network Controller Access Unit attached to an RS/6000 or a PS/2
- The SNA Token-Ring interface attaches to either 4 or 16 Mbps Token Ring networks through the following devices:
 - 8228 Token-Ring Multistation Access Unit attached to an AS/400 or PS/2 processor
 - 8230 Token-Ring Network Controller Access Unit attached to an AS/400 or PS/2 processor
 - 8228 Token-Ring Multistation Access Unit attached to 3172, 3174, 3745, 3725, or 3720, which in turn is attached to a 3090, ES/9000, 308X, or 4381 processor
 - 8230 Token-Ring Network Controller Access Unit attached to a 3172, 3174, 3745, 3725, or 3720, which in turn is attached to a 3090, ES/9000, 308X, or 4381 processor
- The SDLC V.35 with SNA at 56 Kbps interface attaches to the following devices:
 - 5822 Communications Network Management Data/Channel Service attached to a 9370, 9371, or AS/400 processor
 - 5822 Communications Network Management Data/Channel Service attached to a 3745, 3725, 3720, or 3705 Communication Controller, which in turn is attached to a 3090, ES/9000, 308X, or 4381 processor.
- The SDLC EIA-232 V.24 with SNA at 19.2 Kbps interface attaches to the following devices:
 - 7861-047 Modem attached to a 9370, 9371, or AS/400 processor

- 7861-047 Modem attached to a 3745, 3725, 3720, or 3705 Communication Controller, which in turn is attached to a 3090, ES/9000, 308X, or 4381 processor
- 7861-047 Modem attached to a PS/2 (PS/2 has an IBM Multiprotocol Adapter and PSF/2 software).
- The Twinaxial interface attaches to the following devices:
 - AS/400 Twinaxial Workstation Controllers
 - 5394 Remote Control Unit attached to AS/400
 - 5494 Remote Control Unit attached to AS/400
- The PC Parallel interface port supports a subset of the IEEE 1284 Standard. This includes Compatibility Mode.

It does not support bi-directional communication. The PC parallel interface supports attachment to:

- RISC System/6000 workstations, excluding POWERServer 930
- PS/2 computer LPTx ports
- Direct LAN attachment using the IBM 4033 LAN Connection
- Network Print Server
- Non-IBM personal computers using the Centronics Parallel interface

Appendix B. Software and Hardware Requirements

Important

Table 43 on page 68 summarizes the support that various versions of PSF provide the 3130. Note that the information it contains is subject to change, and therefore should be used for general planning only. For more detailed information about host software requirements, refer to *Advanced Function Presentation: Printer Information*, G544-3290.

Attachments

The 3130 supports up to three simultaneously active attachment interfaces with switching under microcode control. Only one IPDS host can be attached at a time. The following are standard with every 3130:

- PC Parallel Interface
- Ethernet Interface (10BaseT, 10Base2, or 10Base5)

One optional interface slot is available for one of the following:

- Twinaxial Interface
- Token-Ring Interface
- SDLC Interface

The data streams for each attachment are:

Attachment (Protocol)	Data stream
Twinaxial (Arctic)	IPDS
SDLC (SNA LU6.2 V.24)	IPDS
SDLC (SNA LU6.2 V.35)	IPDS
Token Ring (SNA LU6.2)	IPDS
Token Ring (TCP/IP)	IPDS/PCL-5e/PostScript L2
Token Ring (Novell SPX/IPX)	PCL-5e/PostScript L2
Ethernet (TCP/IP)	IPDS/PCL-5e/PostScript L2
Ethernet (Novell SPX/IPX)	PCL-5e/PostScript L2
PC Parallel (Converged)	PCL-5e/PostScript L2
Network Print Server*	PCL-5e/PostScript L2

* For Novell SPX/IPX, NetBios, and TCP/IP

Intelligent Printer Data Stream (IPDS) Considerations

Host system software is required for attaching to the host system and for creating the IPDS data stream. System software is the same set of AFP programs that are used for the AFP family of printers. The following central processing unit (CPU) configurations support the 3130:

- AS/400
- PS/2 and PC Local Area Networks (LAN)
- RISC System/6000 LAN
- ES/4381
- 308X
- ES/3090
- ES/9000
- ES/9370
- ES/9371

Connectivity to the host processors is through the following architectures:

- Twinaxial
- SDLC (SNA V.24 19.2 Kbps)
- SDLC (SNA V.35 56 Kbps)
- Token-Ring (SNA)
- Token-Ring (TCP/IP)
- Ethernet (TCP/IP)

System	SDLC (SNA)	Token-Ring (SNA)	Token-Ring (TCP/IP) Ethernet (TCP/IP)
ES/4381	Yes	Yes	Yes
308X	Yes	Yes	Yes
ES/3090	Yes	Yes	Yes
ES/9000	Yes	Yes	Yes
ES/9370	Yes	No	Yes
ES/9371	Yes	No	Yes

System	SDLC (SNA)	Token-Ring (SNA)
ES/4381	Yes	Yes
308X	Yes	Yes
ES/3090	Yes	Yes
ES/9000	Yes	Yes
ES/9370	Yes	No
ES/9371	Yes	No

System	SDLC (SNA)	Token-Ring (SNA)
ES/4381	Yes	Yes
308X	Yes	Yes
ES/3090	Yes	Yes
ES/9000	Yes	Yes
ES/9370	Yes	Yes
ES/9371	Yes	Yes

System	Twinax	SDLC (SNA)	Token-Ring (SNA)	Token-Ring (TCP/IP)	Ethernet (TCP/IP)
AS/400	Yes	Yes	Yes	Yes	Yes
PS/2	No	V.24 only	Yes	Yes	Yes
RISC/6000	No	No	No	Yes	Yes

PCL-5e and PostScript Considerations

The 3130 can support PCL-5e and PostScript through a variety of attachments. This section describes a few of them, but it is not a complete list.

Network Operating Systems

IBM OS/2 LAN Server

- Token Ring using TCP/IP and Ethernet using TCP/IP
- Network Print Server using TCP/IP and NetBios

Novell NetWare: Novell NetWare 3.11 and later releases support the 3130.

- Token Ring using IPX/SPX for print server mode only
- Ethernet using IPX/SPX for print server mode only
- Network print server attached to the printer PC parallel interface for remote printer mode or print server mode on Token Ring or Ethernet

Microsoft LAN Manager

- Token Ring using TCP/IP and Ethernet using TCP/IP
- Network Print Server using TCP/IP and NetBios

PCL-5e and PostScript Drivers

Although Table 41 on page 62 shows the drivers that are shipped with the 3130, IBM recommends that you get these drivers from the Internet and install them on your system before your machine arrives. The Universal Resource Locator (URL) for the World Wide Web is

<http://www.can.ibm.com/ibmprinters>

Note: Each driver has a README file. Print it and read it before installing or using the driver.

Driver Description	File Name	Diskette Format
Windows PCL	3130WIN.PCL	DOS
Windows PostScript	3130WIN.PS	DOS
OS/2 PCL	3130OS2.PCL	DOS
OS/2 PostScript	3130OS2.PS	DOS
AIX PCL-5e	3130.pcl	DOS
AIX PostScript	3130.ps	DOS

Table 42 lists several of the supported PCL-5e and PostScript systems and attachments.

System	Driver	PC Parallel	TCP/IP (*)	NetWare (*)
DOS	Windows 3.1 +	Yes	Yes	Yes
OS/2	OS/2 2.11 +	Yes	Yes	Yes
RISC/6000	colon file	Yes	Yes	Yes
Note: (*) Supports both Token-Ring and Ethernet				

IBM PS/2 and PC: The following workstation software supports the 3130 with PCL-5e and PostScript L2 data streams through print drivers shipped with the printer:

- OS/2 2.11 Service Pack and later (32 bit support only), including the OS/2 LAN Server

Note: Before using IBM printer drivers on OS/2 2.11, obtain and install FixPac, XR_B103 on your workstation. To obtain FixPac, contact IBM OS/2 Support at 1-407-994-5544.

- Microsoft Windows 3.1 and Windows 95

RISC System/6000: AIX supports the 3130 through a “colon” file driver diskette shipped with the printer. AIX Version 3.2.5 and Version 4.1 are supported.

OS/400 Host Print Transforms

If you need to transform AFP into PCL-5e, OS/400 requires customization objects. See “Host Print Transforms for OS/400” on page 64 for more information about these objects.

PSF Support Notes

Basic N_Up and Enhanced N_Up Printing:

- Basic N_UP

Enables printing output that places one, two, three, or four pages in sequence in equal-sized partitions on each side of a sheet. Two 8.5 x 11 inch application pages can print two-up on a single 11 x 17 inch sheet. For duplex operations, each side of the form or sheet can have up to four pages.

- Enhanced N_UP (Page Positioning)

Enables the following:

- Page Orientation – places individual pages in any position on either side of the sheet in any orientation and in any size that fits on the sheet.
- Overlays – places overlays relative to any partition origin with or without variable page data from the application program. You can specify different overlays for each page.
- Offsets – specifies different offsets for each page.
- Form Ejection – ejects to a new partition or a new sheet.

PSF/MVS Support

- PSF/MVS V2.2.0:
 - With APAR OW12840, supports TCP/IP (Token Ring and Ethernet)
 - With APAR OW15018, allows the 3130 to accept input from non-IPDS attachments intermittently while the PSF attachment is active
 - With APAR OW14128, supports DBCS scalable (outline) fonts and capture of raster fonts
 - Supports N_UP
 - With APAR OW03243, supports Enhanced N_Up
 - With APAR OW08340 and IBM Font Collection for Operating Systems installed, can:
 - Activate the proper resident fonts without using the APSRMARK utility
 - Use downloaded and printer-resident outline fonts
 - Media-Destination Selection Function (Multiple Output Bin) support applies to:
 - MVS/ESA V4.2.0, V4.3.0, and V5.1.0
 - MVS/ESA JES3 V4.2.1 in support of PSF/MVS V2.2.0
 - For multiple output bin support:
 - PSF/MVS V2.2. with APAR OW07348
 - MVS/ESA V4.2.0, V4.3.0, and V5.1.0 with APAR OW04349
 - MVS/ESA JES3 V4.2.1 with APAR OW07286
- PSF/MVS V2.1 and later:
 - APAR OW08127 is required for five input bin support
 - The resident 3130 Core Set outline fonts are activated by host library raster fonts if you have identified them using the APSRMARK utility
 - PSF/MVS V2.1 does not support multiple input bins at the copy subgroup level
 - With APAR OW16190 supports capture of raster fonts

PSF/VSE Support

To use resident fonts, identify them to PSF/VSE, using the APTRMARK utility. Resident fonts are not supported when using the Data Facility Product (DFP).

PSF/VM Support

PSF/VM does not support resident fonts; however, you can print with fully described downloaded fonts.

PSF For OS/400 Support

- Version 3.1:
 - Requires a PTF for native 3130 support
 - Supports Basic N_Up but not Enhanced N_Up
 - Requires a PTF for DBCS resident font support
 - Does not support the font capture function
- Version 3.0.5:
 - Requires Cum Tape C4263305
 - Does not support N_Up or Enhanced N_Up
 - Configure the 3130 as a 3935
 - Supports outline font scaling only for whole font sizes (for example, 10, 12, 15 CPI ...)
- Version 2.3
 - Requires Cum Tape CA193230
 - Requires PTF C4193230
 - Does not support N_Up or Enhanced N_Up
 - Configures the 3130 as a 3935
 - Supports outline fonts scaling only for whole font sizes (for example, 10, 12, 15 CPI ...)
- Version 2.2:
 - This version went out of service on 31 March 95; it is included for reference only
 - Requires PTF SF16030 and SF16187
 - Only letter (8.5 x 11 in.) and legal (8.5 x 14 in.) size paper are supported
 - IBM AFP Multiple-up page capability is not supported; multiple-up page capability is available only by using the OS/400 function
 - Only the printer default output bin is supported (#5, first top stacker)
 - Supports outline font scaling only for whole font sizes (for example, 10, 12, 15 CPI ...)
- Printing with the large print function for OfficeVision/400 on the AS/400 is not supported by the 3130; also, the AS/400 (DDS) key word CHRISZ function is not supported by the 3130.
- Bolding is not supported on the following fonts when using OfficeVision/400 or the AS/400 (DDS) key word HIGHLIGHT function: Boldface, Gothic Text, Gothic Katakana, OCR A, OCR B, Prestige Italic, or fonts that are already bold-faced fonts.

Host Print Transforms for OS/400

Transforming an AFP or SCS data stream to PCL-5e requires one of several 3130 Customization Objects:

- IBM3130A: Is the Advanced Customization object for duplex and high-capacity simplex models. It contains tags for AFP-to-PCL5e transform support and requires V3.1 and PTF SF25752. The host supports all input paper trays.

- IBM313SA: Is the Advanced Customization object for the Model 01S (simplex). It contains tags for AFP-to-PCL5e transform support and requires V3.1 and PTF SF25752. The host supports selecting the side input tray (drawer 1), the top front input tray (drawer 2), and the optional envelope feeder.
- IBM3130: Is the pre-V3.1 Customization object for duplex and high-capacity simplex models. It operates with V2.3 or later. The host supports selecting the main and lower side tray and the optional envelope feeder.
- IBM313SA: Is the pre-V3.1 Customization object for the Model 01S (simplex). It operates with V2.3 or later. The host supports selecting the side input tray (drawer 1), the top front input tray (drawer 2), and the optional envelope feeder.

PSF/2 Support

- Resident fonts are not supported when using the DPF function of PSF/2.
- When using “PSF Direct,” the function supported is equivalent to that provided by the host PSF.

PSF for AIX Support

When using “PSF Direct,” the function supported is equivalent to that provided by the host PSF.

System Test

SNA Token-Ring uses NetView for recording errors. Token-Ring uses the ‘Self Test Frame’ on the ring itself.

For AS/400, use the Verify Print (VFYPRT) command to obtain the printer type and send a test print. The AS/400 uses ERAPs to log errors.

Applications (IPDS)

The 3130 prints text data referred to as Coded Information, image data referred to as Non-Coded Information, and GDDM raster graphics. You can print all of these at any location on the printed page and in any combination. Printing the mixture or combination of data at any printed page location is called all points addressable or APA printing.

Token Ring Network Attachment

For details on SNA, TCP/IP, or NetWare attachment, see *IBM InfoPrint 60; 3130, 3160, and 3935 Advanced Function Printer: Attachment Configuration Handbook*.

The 3130 connects to a host Token-Ring through the IBM Token-Ring cabling. It uses the Auto Token-Ring LANStreamer Adapter which is installed in the AFCCU. The adapter and an 8-foot long external cable are provided when this feature is ordered. The external cable is connected to an IBM 8228 Token-Ring Multistation Access Unit or an IBM 8230 Token-Ring Network Controller Access Unit, which is connected as follows:

- Directly to a PS/2, AS/400, or RISC System/6000 CPU
- To a 3172, 3174, 3720, 3725, or 3745, which in turn is connected directly to a ES/4381, 308X, ES/3090, or ES/9000 CPU

The control unit can attach to either a 4Mbps or 16Mbps Token-Ring Local Area Network.

The attachment adheres to the IBM Token-Ring Network OEMI. The following documents, together, compose the IBM Token-Ring Network Other Equipment Manufacture Interface:

- *IBM Cabling System Technical Interface Specification, GA27-3773*
- *IBM Local Area Network Technical Reference, SC30-3383*
- *IBM Token-Ring Area Network Architecture Reference, SC30-3374*
- *Carrier Sense Multiple Access with Collision Detection, IEEE Std 802.3-1985*
- *Token-Ring Access Method and Physical Layer Specification, IEEE Standard 802.5-1989*

The 3130 can be a maximum distance of 100 meters from the 8228 Multistation Access Unit or 8230 Controlled Access Unit. For more information, refer to the 8228 and 8230 Product Publications. For cable attachment options from the 8228 or 8230 to the host system CPU, refer to the specific CPU cabling information.

Ethernet Network Attachment

For details on TCP/IP or NetWare attachment, see *IBM InfoPrint 60; 3130, 3160, and 3935 Advanced Function Printer: Attachment Configuration Handbook*.

The 3130 offers one of three Ethernet attachment types as an optional feature:

10Base-T (Twisted Pair)

The 3130 can attach to standard Twisted Pair (10BaseT) cable. The feature attachment includes the type 10BaseT transceiver and the transceiver cable used to connect the transceiver to the printer. RJ45 unshielded twisted pair cable (which must meet IEEE 802.3 requirements) is required to attach the 10BaseT transceiver to the Ethernet Twisted Pair Network. A wrap plug is included with the feature for diagnostic purposes.

Connection can be either directly to a RISC System/6000 or to a 8250 or 8260 Twisted Pair Hub (which connects to a RISC System/6000 or a PS/2).

10Base2 (Thin Coaxial)

The 3130 can attach to standard Thin type 10Base2 Ethernet coaxial cable. The attachment includes the type 10Base2 transceiver and the transceiver cable used to connect the transceiver to the printer. The transceiver attaches to a standard Thin Ethernet Network. A wrap plug is included with the feature for diagnostic purposes.

Connection is made directly to a RISC System/6000, PS/2, or AS/400.

10Base5 (Thick Coaxial)

The 3130 can attach to standard Thick type 10Base5 Ethernet coaxial cable. A type 10Base5 cable is required to connect the D-connector on the printer to the 10Base5 network. A wrap plug is included with the feature for diagnostic purposes.

Connection is made directly to a RISC System/6000, PS/2, or AS/400.

PSF Support Summary

Table 43 on page 68 summarizes the support that various versions of PSF provide the 3130.

Table 43. PSF Support Summary (IPDS)

Function	PSF/MVS		PSF/VSE V2.2.1	PSF/VM V2.1.1	PSF for OS/400			PSF/6000 V1.2/ PSF for AIX V2.1	PSF/2 V2.0
	V2.2.0	V2.1, V.2.1.1			V3.1	V2.3, V3.0.5	V2.2		
Base Support:									
3935 Emulation	No	No	Yes	Yes	Yes	Yes (PTF)	Yes (PTF)	NA/NA	NA
Native	Yes	Yes	Yes	Yes	Yes	No	No	NA/NA	NA
300 Pci	Yes	Yes	Yes	Yes	Yes	Yes	Yes	Yes/Yes	Yes
240 Pci	Yes	Yes	Yes	Yes	Yes	Yes	Yes	Yes/Yes	Yes
Multiple Input (sources)	Yes (5)	Yes (5)	Yes (5)	Yes (5)	Yes (5)	Yes (4)	Yes (3)	Yes (4)/Yes (5)	Yes (4)
Multiple Output (stackers)	Yes (3)	No	Yes (3)	No	Yes (3)	No	No	No/Yes	No
IPDS Towers:	All	All	All	All	All	All	All	All/All	All
Printer Connectivity:									
Token-ring SNA	Yes	Yes	Yes	Yes	Yes	Yes	Yes	No/No	Yes
SDLC SNA	Yes	Yes	Yes	Yes	Yes	Yes	Yes	No/No	Yes
Ethernet TCP/IP	Yes	No	No	No	Yes	No	No	Yes/Yes	Yes
Token-Ring TCP/IP	Yes	No	No	No	Yes	No	No	Yes/Yes	Yes
Twinaxial	No	No	No	No	Yes	Yes	No	No/No	No
Downloadable Raster Fonts	Yes	Yes	Yes	Yes	Yes	Yes	Yes	Yes	Yes
Downloadable Outline Fonts									
SBCS	Yes	No	No	No	No	No	No	No/Yes	No
DBCS	No	No	No	No	No	No	No	No/No	No
SBCS Font Resident									
4028 (Raster)	Yes	Yes	Yes	No	Yes	Yes	No	No	No
Core	Yes	Yes	Yes	No	Yes	Yes	No	No	No
Coordinated	No	No	Yes	No	Yes	Yes	No	No	No
DBCS Resident Fonts (Rasters)	Yes	Yes	Yes	No	No	No	No	No	No
DBCS Resident Fonts (Outline)	Yes	No	Yes	No	No	No	No	Yes	No

Attachment Hardware

- The Ethernet TCP/IP interface attaches to the following network configurations:
 - RS/6000, AS/400, and PS/2 Ethernet 10BaseT Networks
 - RS/6000, AS/400, and PS/2 Ethernet 10Base2 Networks
 - RS/6000, AS/400, and PS/2 Ethernet 10Base5 Networks
 - ES/4381, 308X, ES/3090, or ES/9000 CPU
- The Ethernet NetWare interface attaches to the following network configurations:
 - RS/6000 and PS/2 Ethernet 10BaseT Networks
 - RS/6000 and PS/2 Ethernet 10Base2 Networks
 - RS/6000 and PS/2 Ethernet 10Base5 Networks
- The Token-Ring TCP/IP interface attaches to either 4Mbps or 16Mbps Token Ring networks through the following devices:
 - 8228 Token-Ring Multistation Access Unit attached to an RS/6000, an AS/400, or a PS/2
 - 8230 Token-Ring Network Controller Access Unit attached to an RS/6000, an AS/400, or a PS/2
- The Token-Ring NetWare interface attaches to either 4Mbps or 16Mbps Token-Ring networks through the following devices:
 - 8228 Token-Ring Multistation Access Unit attached to an RS/6000 or a PS/2
 - 8230 Token-Ring Network Controller Access Unit attached to an RS/6000 or a PS/2
- The SNA Token-Ring interface attaches to either 4 or 16 Mbps Token Ring networks through the following devices:
 - 8228 Token-Ring Multistation Access Unit attached to an AS/400 or PS/2 processor
 - 8230 Token-Ring Network Controller Access Unit attached to an AS/400 or PS/2 processor
 - 8228 Token-Ring Multistation Access Unit attached to 3172, 3174, 3745, 3725, or 3720, which in turn is attached to a 3090, ES/9000, 308X, or 4381 processor
 - 8230 Token-Ring Network Controller Access Unit attached to a 3172, 3174, 3745, 3725, or 3720, which in turn is attached to a 3090, ES/9000, 308X, or 4381 processor
- The SDLC V.35 with SNA at 56 Kbps interface attaches to the following devices:
 - 5822 Communications Network Management Data/Channel Service attached to a 9370, 9371, or AS/400 processor
 - 5822 Communications Network Management Data/Channel Service attached to a 3745, 3725, 3720, or 3705 Communication Controller, which in turn is attached to a 3090, ES/9000, 308X, or 4381 processor.
- The SDLC EIA-232 V.24 with SNA at 19.2 Kbps interface attaches to the following devices:
 - 7861-047 Modem attached to a 9370, 9371, or AS/400 processor

- 7861-047 Modem attached to a 3745, 3725, 3720, or 3705 Communication Controller, which in turn is attached to a 3090, ES/9000, 308X, or 4381 processor
- 7861-047 Modem attached to a PS/2 (PS/2 has an IBM Multiprotocol Adapter and PSF/2 software).
- The Twinaxial interface attaches to the following devices:
 - AS/400 Twinaxial Workstation Controllers
 - 5394 Remote Control Unit attached to AS/400
 - 5494 Remote Control Unit attached to AS/400
- The PC Parallel interface port supports a subset of the IEEE 1284 Standard. This includes Compatibility Mode.

It does not support bi-directional communication. The PC parallel interface supports attachment to:

- RISC System/6000 workstations, excluding POWERServer 930
- PS/2 computer LPTx ports
- Direct LAN attachment using the IBM 4033 LAN Connection
- Network Print Server
- Non-IBM personal computers using the Centronics Parallel interface

Bibliography

The documentation listed in this bibliography contain detailed information related to subjects discussed in the 3130 Documentation Library. For information about

how to order these documents, contact your local IBM branch office.

Document Title	Order Number
<i>About Type: IBM's Technical Reference for Digitized Type</i>	S544-3516
<i>About Type: IBM's Typographic Primer for Digitized Type Program Products</i>	G544-3183
<i>About Type: IBM's Guide for Type Users</i>	G544-3122
<i>About Type: IBM's Typographic Primer for Digitized Type Supplement</i>	G544-3186
<i>Advanced Function Printing: Managing the Presentation of Information</i>	G544-3825
<i>Advanced Function Presentation: Printer Summary</i>	G544-3135
<i>Advanced Function Presentation: Printer Information</i>	G544-3290
<i>Advanced Function Image and Graphics</i>	G221-3075
<i>Guide to Advanced Function Presentation</i>	G544-3876
<i>IBM Bar Code Fonts User's Guide</i>	S544-3190
<i>Bar Codes Brochure</i>	G320-9875
<i>IBM Document Composition Facility: Bar Code User's Guide</i>	S544-3115
<i>Advanced Function Printer Cut-Sheet Paper Reference for use with IBM Electrophotographic Printers</i>	G544-3915
<i>IBM InfoPrint 60; 3130, 3160, and 3935 Advanced Function Printer: Attachment Configuration Handbook</i>	S544-3977
<i>IBM 3130 Advanced Function Printer: Administrator's Guide</i>	S5445328
<i>3130 Advanced Function Printer User's Guide</i>	S544-5337
<i>IBM 3130 Advanced Function Printer Maintenance Information (Volume 1)</i>	57G5477
<i>IBM 3130 Advanced Function Printer Maintenance Information (Volume 2)</i>	57G5478
<i>IBM 3130 Advanced Function Printer Safety Notices</i>	S544-3978
<i>Document Composition Facility and Document Library Facility General Information</i>	GH20-9158
<i>IBM Dictionary of Computing</i>	ZC20-1699
<i>Graphical Data Display Manager General Information</i>	GC33-0319
<i>Graphical Data Display Manager Guide for User's</i>	SC33-0327
<i>Graphical Data Display Manager Installation and System Management for MVS</i>	SC33-0321
<i>Graphical Data Display Manager Installation and System Management for VSE</i>	SC33-0322
<i>IPDS Handbook for Printers That Use the Advanced Function Common Control Unit</i>	G544-3895
<i>IBM Intelligent Printer Data Stream Reference</i>	S544-3417
<i>OGL/370: Getting Started</i>	G544-3691
<i>IBM System/360, System/370, 4300 Processors: Input/Output Equipment Installation Manual—Physical Planning</i>	GC22-7064
<i>Page Printer Formatting Aid/370 User's Guide and Reference</i>	S544-3700
<i>IBM Print Services Facility/VSE: System Programming Guide</i>	S544-3665
<i>IBM Print Service Facility/MVS Program Directory</i>	G544-3668
<i>IBM Print Service Facility/VSE Program Directory</i>	G544-3805
<i>IBM Print Service Facility/MVS: Application Programming Guide</i>	S544-3673
<i>IBM Print Service Facility/VSE: Application Programming Guide</i>	S544-3666
<i>IBM System/370 Enterprise Systems Architecture Principles of Operation</i>	SA22-7085
<i>IBM System/370 Principles of Operation</i>	GA22-7000

Document Title	Order Number
<i>IBM System/370, 30xx, 4300, and 9370 Processors Bibliography</i>	GC20-0001
<i>IBM 9370 System Installation Physical Planning</i>	GA24-4031
<i>Application System/400 Printer Device Programming</i>	SC31-3713
<i>IBM Cabling System Interface Technical Specification</i>	GA27-3773
<i>IBM Local Area Network Technical Reference</i>	SC30-3383
<i>IBM Token-Ring Area Network Architecture Reference</i>	SC30-3374
<i>IBM Network Problem Determination Application Action Guide</i>	SC34-2113
<i>IBM System Network Architecture SDLC Protocols</i>	SC19-5234 SC19-5237
Note: * = To order this document, call 1-800-388-7080.	

Glossary

The following terms are defined as they are used in 3130 documentation. If you do not find the term you need, refer to the index or to the *IBM Dictionary of Computing*, ZC20-1699.

A

adhesive label. Special-application material; typically consists of paper labels coated on one side with an adhesive mixture temporarily affixed to backing material. See also *carrier*.

Advanced Function Image and Graphics. This allows the 3130 to directly process IO1 subset of the IO-image command set and GR1 subset of the graphics command set data streams.

Advanced Function Presentation (AFP). The ability of programs to use the all-points-addressable concept to print text and images with a printer.

all-points addressability. The capability to address, reference, and position text, overlays, and images at any defined point on the printable area of a page.

application. The use to which an information processing system is put; for example, a payroll application, an airline reservation application, a network application.

application program. A program written for or by a user that applies to the user's work, such as a program that does inventory control or payroll.

application programmer. A person who develops application programs. Contrast with *system programmer*.

B

bar code. A code representing characters by sets of parallel bars of varying thickness and separation that are read optically by transverse scanning.

Bar Code Object Content Architecture (BCOCA). An IPDS command set that provides data control information to print bar-code information on a page, page segment, or overlay.

basis weight. The weight in pounds of a ream (500 sheets) of paper cut to a given standard size for that grade; for example, 25 x 38 inches for book papers, 17 x 22 inches for bond papers, and other sizes for other grades.

binder holes. A series of holes or slots punched at set intervals that allows the form to be inserted in a loose-leaf or ring binder.

bond (paper). Paper formulated with at least 80% wood pulp. Bond-paper forms work best in the IBM 3130.

C

calender. A process to make paper smooth or glossy by passing it through a series of metal rollers during the last steps of a paper-making machine.

calender cut. Slits, glazed lines, or discolored lines across the paper caused when wrinkles pass through the calender rollers.

caliper. The thickness of forms. This is usually expressed in thousandths of an inch.

carrier. The backing material for labels. Labels consist of the printable material, the adhesive, and the carrier.

chad. (1) The material separated from a data medium when punching a hole. (2) The residue separated from the carrier holes in continuous forms.

channel. (1) A path along which signals can be sent (for example, data channel, output channel). (2) In the 3130 printer environment, the communication attachment.

character. A letter, number, punctuation mark, or special graphic used for the production of text.

character set. (1) A finite set of different characters that is complete for a given purpose; for example, the character set in ISO Standard 646, "7-bit Coded Character Set of Information Processing Interchange." (2) A group of characters used for a specific reason; for example, the set of characters a printer can print.

coated paper. Paper that has had a surface coating applied to produce smoothness.

code page. A font library member that associates code points and character identifiers.

coded font. A set of graphic characters to which code points from a code page and character-representations font have been assigned. A coded font may be stored in a library for later use, or used immediately as a collection of data that specifies the character pattern of zero or more graphic characters. A coded font associates the graphic characters with code points, and provides some of the control information the printer needs to place the character patterns on a page.

Coded fonts are typically used where typographic quality is required.

code point. An element of a code page or a site in a code table to which a character can be assigned.

configuration. (1) The arrangement of a computer system or network as defined by the nature, the number, and the chief characteristics of its functional units. More specifically, the term configuration may refer to a hardware configuration or a software configuration. (2) The devices and programs that make up a system, subsystem, or network.

configure. The procedure used to customize the 3130 to a specific operating and communication environment.

constant data. Data that does not change; for example, the company letterhead and standard text in form letters, or the headings and boxes on a preprinted form. Contrast with *variable data*.

constant spaced font. A font in which the graphic characters are contained in character cells of uniform size. The distance between reference points of adjacent graphic characters is constant in the in-line progression. The white spaces between graphic characters may vary. Synonymous with fixed-space font. Contrast with proportionally-spaced font.

control storage. In the 3130, a portion of storage that contains microcode and other data.

control unit (CU). (1) A device that controls input and output operations at one or more devices. (2) In the 3130, the electronics and code that control the printhead and the attachment to the host processor.

controlling computer. The processing unit to which the 3130 is connected through a communication attachment.

controlling computer system. The data-processing system to which a network is connected and with which the system can communicate.

corner cut. In a form, a cut or opening of any size containing one or more right angles.

corona. A small diameter wire (or wires, depending on the function) to which a high voltage is applied, causing ionization of the air. The ionization creates an electrical charge to perform various functions during the printing process.

copy group. One or more copies of a sheet of paper. Each may have modifications applied; for example, overlays and text suppression.

copy modification. The process of adding, deleting, or replacing data on selected copies of certain sheets of paper.

copy separation. The mechanism for distinguishing consecutive copies of a single data set. In the stacker, it consists of offset stacking.

cure. The process of drying ink sufficiently for minimum transfer of the ink to any parts of the printer it contacts.

customer engineer. See *service representative*

cut. The severed part of a perforation. Cuts are separated by ties. See also *perforation*.

cutout. A part of the form that has been eliminated or perforated for subsequent removal; for example, corner cuts and binder holes.

D

developed image. The image that has been exposed onto the photoconductor and covered with toner by the developer.

developer. The unit in the process assembly that supplies a flow of developer mix (toner) over the photoconductor to develop the electrostatic image.

diagnostic. Pertaining to the detection and isolation of errors in programs and faults in equipment.

diagnostic mode. The operational mode in which the printer can check itself in case of a malfunction. When the 3130 is in diagnostic mode, it is not accepting information from the attached controlling computer system. In the 3130, only service representatives can use diagnostic mode. Contrast with *print mode* and *test mode*.

direct attach. The environment in which an application program directly allocates the 3130 printer.

disabled mechanism. If necessary, the operator can disable some printer functions to continue operation until the problem can be corrected. In the 3130, the mechanisms that can be disabled are the top paper supply, the bottom paper supply, the duplex mechanism, and the offset-stacker mechanism.

diskette. A flexible magnetic disk enclosed in a protective container.

diskette-storage device. A direct-access-storage device that uses diskettes as the storage medium.

Document Composition Facility (DCF). An IBM licensed program that provides text formatting for the 3130.

double-byte character set. A type of character set required to print unique characters, such as Japanese Kanji.

double-byte coded font. A font in which the characters are defined by two bytes; the first defines a coded-font section, the second defines a code point. Contrast with *single-byte coded font*.

double-byte font. See *double-byte coded font*.

drum count. The number of revolutions of the drum.

dry ink. The material that forms the image on the paper. Synonymous with toner.

duplex printing. Printing on both sides of a sheet of paper. Synonym for *two-sided printing*. Contrast with *simplex printing*.

E

electronic form. See *electronic overlay*.

electronic overlay. (1) A collection of constant data that is electronically composed in the host system and may be combined with variable data on a sheet during printing. (2) The library member that contains the definition of the electronic overlay. See *overlay*.

electrophotographic process. The creation of an image on forms by uniformly charging the photoconductor, creating an electrostatic image on the photoconductor, attracting negatively charged toner to the discharged areas of the photoconductor, and transferring and fusing the toner to forms.

electrostatic image. The invisible image consisting of discharged areas of the photoconductor as a result of exposure from digital data.

emboss. To press and raise the surface of paper into a design. Embossed paper appears thicker than non-embossed paper, can increase printer wear, and can degrade print quality.

Enhanced N_UP Printing. To divide a sheet into a maximum of 8 partitions, anywhere on the sheet. See also N_UP Printing.

error log. (1) A data set or file in a product or system where error information is stored for later access. (2) A record of machine checks, device errors, and volume statistical data.

error-recovery procedure. Procedures designed to help isolate and, where possible, to recover from errors in equipment. The procedures are often used in conjunction with programs that record the statistics of machine malfunctions.

exception. (1) An invalid or unsupported data-stream construction. (2) In IPDS, a condition requiring host notification or requiring the host to resend data.

F

font. (1) A family or assortment of characters of a given size and style; for example, 9-point Bodoni modern. A font has a unique name and may have a registry number. (2) A font is data used to create an image of each graphic character; for example, a raster pattern.

Font Library Service Facility (FLSF). A licensed program that provides a way to make changes to a font while retaining its correct format, as defined by the architecture and as required by Print Services Facility.

font section. A subdivision of a double-byte font character set. The section consists of a maximum of 256 characters.

form definition (FORMDEF). In Print Services Facility (PSF), a resource object that defines the characteristics of the form, which include: overlays to be used, text suppression, position of page data on the form, and number and modifications of a page.

format. (1) The arrangement or layout of data on a data medium. (2) The size, style, type of page, margins, printing requirements, and so on, of a printed page.

forms. The material on which output data is printed, such as paper or adhesive labels. See *electronic overlay* and *preprinted form*.

forms path. The entire route that forms travel during processing. The forms path usually begins where the forms are loaded and ends at the stacker. Synonym for *paper path*.

forms overlay. In the 3130, that function of the printer that allows customer-prepared data to be printed with variable-page data.

fuse. To use heat and pressure to blend toner onto forms to make a permanent bond.

fuser. The assembly that bonds the toned image to the paper using heat and pressure.

G

graphic. A symbol produced by a process such as handwriting, drawing, or printing. See also *vector graphics*.

graphic character. A character that is normally represented by a graphic, independent of code points or fonts. A graphic character is often in the form of a spatial arrangement of adjacent or connected strokes; for example, a letter or digit.

Graphic Object Content Architecture (GOCA). An IPDS command set that provides data control information for printing graphics on a page, page segment, or overlay.

Graphical Data Display Manager (GDDM). An IBM licensed program that allows pictures to be defined and displayed through function routines.

H

host system. (1) The primary or controlling computer in a multiple-computer installation. (2) A computer used to prepare programs for use on another computer or on another data-processing system; for example, a computer used to compile, link edit, or test programs to be used on another system.

I

ideographic. Pertaining to 2-byte characters consisting of pictograms, symbolic characters, and other types of symbols.

image. (1) A string of picture elements organized in scan lines to represent the contrasting portions of a picture. (2) A likeness or imitation of an object. (3) In this printer, an image comprises a string of pels organized in scan lines to represent the contrasting portions of a picture. The image may consist of any data stored as a raster pattern. The term image is interchangeable with impression and is printed on one side of a sheet of paper.

Image Object Content Architecture (IOCA). An IPDS command set to print image data on a page, page segment, or overlay.

impact printer. A printer in which printing is the result of mechanical impacts. Contrast with *non-impact printer*.

impression. An implied or physical page. Used when calculating the reduction of printer output caused by

switching the printer between duplex and simplex modes or upper and lower paper supplies. The term impression is interchangeable with image.

initial machine load (IML). A procedure that prepares the 3130 for use.

installation. (1) In system development, preparing and placing a functional unit in position for use. (2) A particular computing system, including the work it does and the people who manage it, operate it, apply it to problems, service it, and use the results it produces.

installation verification procedure. A procedure distributed with IBM licensed programs that tests the newly installed IBM programs to verify that the basic facilities of the programs are functioning correctly.

intelligent printer data stream (IPDS). An architected *host-to-printer* data stream that contains both data and controls defining how the data is to be presented. Generally, this information contains basic formatting, error recovery, and character data.

interface. A shared boundary. An interface might be a hardware component to link two devices or it might be a portion of storage or registers accessed by two or more computer programs.

interlocked mode. Prevents a machine or device from initiating further operations until an operation in process is completed.

IPX. Internetwork Packet eXchange. A Novell, Inc. implementation of the XNS communication protocol that transports data packets between network devices. Delivery of the data packets is not guaranteed. Contrast with *SPX*.

ISO sizes. Pertaining to a set of paper sizes selected from those standardized by the International Organization for Standardization (ISO) for use in data processing.

J

jam. In a printer, a condition where forms have become blocked or wedged in the forms path so the printer cannot operate.

JIS. Japanese Industry Standards. Used in reference to paper standards for size.

job separation. (1) The hardware mechanism that uses the mark form sequence to distinguish jobs, which are consecutively stacked in the output stacker. (2) In the 3130, job offset stacking is used to indicate job termination. See also *offset stacking*.

K

Kanji. A graphic character set consisting of symbols used in Japanese ideogram alphabets. Each character requires two bytes of data (double-byte characters).

L

landscape orientation. Text and images that are printed parallel to the longer side of the forms. Contrast with *portrait orientation*.

laser (light amplification by stimulated emission of radiation). A device that emits a beam of coherent light.

latent image. In a printer, the invisible image that exists in the sensitized material after exposure but before development.

layout plan. A list of requirements, such as electrical and space, that must be considered before installing the IBM 3130 Advanced Function Printer.

library. A collection of related files. For example, one line of an invoice may form an item, a complete invoice may form a file, and the collection of inventory control files may form a library. The libraries used by an organization are known as the data bank.

licensed program. A separately priced program that bears an IBM copyright and is offered to customers under the terms and conditions of the Agreement for IBM Licensed Programs.

line printer. A printer that prints a line of characters as a unit. Contrast with *page printer*.

logical page. The print on the page, such as composed text, graphics, and fonts within defined margins. Contrast with *physical page*.

logo. An identifying emblem, statement, or motto of a company.

M

memory. All of the addressable storage space in a processing unit and other internal storage that is used to execute instructions. Main storage.

microcode. In the 3130, refers to the microprogramming stored on the microcode diskette. Microcode is used by the control unit to manage the printer and its functions.

N

NetWare. A network operating system developed by Novell, Inc. NetWare runs on a server and provides several functions to the network and the applications running on it, including print spooling, file serving, and interprocess communications.

non-impact printer. A printer in which printing is not the result of mechanical impacts. Contrast with *impact printer*.

N_Up Printing. In Basic N_UP, the ability to print more than one logical page on a single side by using a control in the form definition. See also Enhanced N_UP.

O

offline. Pertaining to the operation of a functional unit when not under the direct control of a computer. Contrast with *online*.

offset paper. A grade of paper to which sizing is added to resist moisture and surface during printing by ink presses.

offset stacking. The jogged stacking of output media in the output stacker so that jobs protrude from the balance of the stack to give physical identification. See also *job separation*.

online. Pertaining to the operation of a functional unit when under the direct control of a computer. Contrast with *offline*.

operating environment. The physical environment; for example, temperature, humidity, layout, or power requirements.

operating requirements. A list of requirements, such as environmental, electrical, and space, that must be satisfied before the 3130 Advanced Function Printer can be installed.

optical character recognition (OCR). Character recognition that uses optical means to identify graphic characters.

orientation. The number of degrees an object is rotated relative to a reference; for example, the orientation of an overlay relative to the page point of origin. See also *text orientation*.

outboard recorder (OBR). A feature that records pertinent data on the system recorder file when an unrecoverable I/O exception occurs.

output stacker. The part of the 3130 where the printed sheets are collected.

overlay. (1) A collection of predefined data, such as lines, shading, text, boxes, or logos, that can be combined with variable data on a sheet while printing. (2) The library member that contains the definition of an overlay. See also *electronic overlay* and *forms overlay*.

Overlay Generation Language (OGL). The licensed program that is used to create electronic overlays that are included in the IPDS data.

overrun condition. Loss of data because a receiving device is unable to accept data at the rate it is transmitted.

overstrike. The merging of two or more graphic characters in the same position on a sheet of paper.

P

page. A collection of information bound by the beginning page control and its associated end control. A page of printing is one side of a sheet of paper or form. See also *logical page* and *physical page*.

page-buffer storage. Writable control storage in which data to be printed is stored. The data is stored one line at a time until a page is complete and ready to print.

page definition (PAGEDEF). A statement that specifies attributes of a logical page, such as the width of its margins and the orientation of text.

page printer. A device that prints one page at a time (for example, xerographic printer, cathode-ray-tube printer, film printer). Contrast with *line printer*.

page-printer data stream. A data stream that enables a printer to format a complete page at one time, including text, images, and page segments. It is characterized by a composed-page data-stream format.

Page Printer Formatting Aid (PPFA). A licensed program that creates form definitions (FORMDEFs) and page definitions (PAGEDEFs).

page segment. (1) An object that can include text and images and that can be printed on any addressable point on a page or electronic overlay. It assumes the environment of the object in which it is included. (2) The library member which contains the definition of a page segment.

pallet. A portable platform for handling, storing, or moving materials.

paper path. The entire route that forms travel while they are being processed. The paper path usually

begins where the forms are loaded and ends at the stacker. Because not all forms are paper, the term *forms path* is preferred.

parameter. A variable that is given a constant value for a specified application and that may denote the application.

pattern storage. In the 3130, a part of storage that contains the fonts and images used for printing the character data, overlays, and segments contained in the page buffer.

partition. In Basic N_Up printing, the division of the medium presentation space into a specified number of equal-sized areas in a manner determined by the current physical medium.

PC drum. A hollow cylinder that is covered with photoconductive material.

pel (picture element). (1) An element of a raster pattern; a point where a toned area on the photoconductor may appear. (2) On an all-points-addressable output medium, each pel is an addressable unit. On a row-column addressable output medium, the only pel addressable is the beginning of a character cell.

photoconductor. The material that is wrapped about the drum. The medium for transferring images to paper.

physical page. The form on which the printer is printing, such as an 8-1/2 x 11-inch sheet of paper. Contrast with *logical page*.

physical planner. The person in an organization who plans the environmental, electrical, and space requirements for your facility.

pica. A unit of about 1/6 inch used to measure typographical material.

pitch. A unit of measurement for the width of a printed character. It identifies the number of graphic characters per inch; for example, 10-pitch has ten graphic characters per inch. Uniformly spaced fonts are measured in pitches. Contrast with point.

planning coordinator. The person in your organization who is responsible for coordinating all the planning and installation activities for the 3130.

point. A unit of measurement for describing type sizes. There are 12 points to a pica, about 72 points to an inch.

point of origin. The location of the first print position on a logical page. The point of origin is usually stated in terms of X and Y coordinates. The point of origin

used by a printer can be affected by factors such as printable area and forms orientation.

portrait orientation. Pertaining to a display or hard copy with greater height than width. Contrast with *landscape orientation*.

preprinted form. A sheet of forms containing a preprinted design of constant data with which variable data can be combined. See also *electronic overlay*.

Presentation Text Object Content Architecture (PTOCA). OPDS control sequences used to present text information on a page, page segment, or overlay.

print-error marker (PEM). Small, black, rectangular marks that indicate incorrectly placed data in the valid printable area.

Print Management Facility (PMF). An interactive menu-driven program that can be used to create and modify fonts and to define output formatting for data printed on the IBM 3130 Advanced Function Printer.

print mode. The operational mode in which information is received from the attached controlling computer system and printed output is produced. Contrast with *test mode* and *diagnostic mode*.

print position. The physical positions of the characters constituting a print line relative to the form.

print quality. The quality of printed output relative to existing standards and in comparison with jobs printed earlier.

Print Service Facility (PSF). The access method that supports the printing of text and images on a page.

Print Services Access Facility (PSAF). A menu-driven, print-parameter selection program for page printers controlled by PSF.

print surface. The side of a form that receives the printed image.

proportionally-spaced font. A font in which the graphic characters are contained in character cells that may vary with the size of each graphic character and have varying character increments. This allows for even spacing between printed characters and eliminates excess white space around narrow characters. Contrast with constant spaced font.

R

random-access memory (RAM). A storage device into which data is entered and from which data is retrieved in a non-sequential matter.

raster. (1) In computer graphics, a predetermined pattern of lines that provides uniform coverage of a display space. (2) The coordinate grid that divides the display area of a display device. (3) In the 3130 Printer Subsystem, an on/off pattern of electrostatic images produced by the laser print head under control of the character generator.

raster pattern. A series of picture elements (pels) arranged in scan lines to form an image.

raster scan. A technique of generating or recording the elements of an image by a line-by-line sweep across the entire output medium.

registration. In printing, refers to the relative print positions of images that are printed at different times. For example, when you process preprinted forms, the registration is good if the new image printed by the 3130 aligns correctly with the preprinted image. Print that extends beyond box edges and text that overlaps other text are examples of poor registration.

resident font. Those font data sets that are resident within the printer. They usually reside on the printer diskette media (floppy or hard disk). These font sets are usually commonly used fonts and by having them resident reduces font load time. These fonts may also be used during offline testing of the printer.

resource. (1) People, equipment, or material used to perform a task or a project. (2) Any facility of a computing system or operating system required by a job or task, including main storage, input/output devices, processing units, data sets, and controller processing programs; for example, page printers use resources such as form definitions, page definitions, and fonts.

reverse heading. A heading where each character is highlighted by reversing the color of the character with its background; for example, changing a black character on a white background to a white character on a black background.

S

scanner. A device that examines OCR, graphics, MICR, or bar-code patterns and generates electrical signals corresponding to the pattern. It sends the signals to a computing device for processing.

screen or screening. In document printing, a sheet of material, usually film, carrying a regular pattern of small

dots. When printing, ink adheres only to the dots, and many dots close together appear solid. This method prints large areas of ink on paper but uses much less ink than printing the same area with solid ink.

security paper. Specially formulated paper used for negotiable documents, such as checks, which improves the anti-fraud characteristics of the document.

sense byte. A byte that contains sense (exception) information.

sense data. Sense information used to indicate the causes of command-stream and device exceptions and to direct the host program to the appropriate exception-recovery actions.

service representative. The person responsible for installing and repairing the printer. Synonymous with customer engineer.

sheet. In reference to paper, a single sheet may be printed on one side (simplex) or both sides (duplex).

simplex printing. Printing on one side of a sheet of paper. Contrast with *duplex printing*.

single-byte coded font. A font in which the characters are defined by one byte. A single-byte coded font has only one coded-font section. Contrast with *double-byte coded font*.

sizing. A process where paper is treated to give it resistance against penetration of liquids.

special-purpose materials. Printable items other than blank forms; for example, adhesive labels and preprinted forms.

SPX. Sequenced Packet eXchange. A Novell, Inc. communication protocol that monitors network transmissions to ensure successful delivery of data packets to the destination. Contrast with *IPX*.

SRC. See system reference code.

stacker. A device used to hold paper or other media; usually used to refer to the output device of a printer.

stack lean. A measurable slope from the vertical of a stack of forms. Excessive stack lean can cause failures when feeding forms.

storage. (1) The retention of data in a storage device. (2) In word processing, a unit into which recorded text can be entered, in which it can be retained and processed, and from which it can be retrieved. (3) A device, or part of a device, that can retain data.

Synchronous Data Link Control (SDLC). For managing synchronous, code-transparent, serial-by-bit, information transfer over a link connection.

System Application Architecture (SAA). A set of software interfaces, conventions, and protocols resident in the host system for designing and developing applications that are consistent across systems.

system programmer. A programmer who plans, generates, maintains, extends, and controls the use of an operating system, with the aim of improving overall productivity of an installation. Contrast with *application programmer*.

system reference code (SRC). A code that contains information, such as a failing field-replaceable unit, for a customer engineer.

System/370. An upward-compatible extension of the IBM System/360. A large collection of computing system devices that can be combined to produce a wide range of computing systems that share many characteristics, including a common machine language.

T

task. A basic unit of work to be accomplished by a device or an operator.

tensile strength. A measure of the force that the paper forms can withstand without tearing.

test mode. The operational mode in which the printer can produce print samples, accept configuration changes, and control traces. When the 3130 is in test mode, it is not accepting information from the attached controlling computer system. Contrast with *print mode* and *diagnostic mode*.

text orientation. The position of text as a combination of print direction and baseline direction.

throughput. Amount of work performed by a printer or computer over a period of time, for example, number of jobs per day.

toner. The material that forms the image on the paper. Synonymous with dry ink.

trace. (1) A record of the running of a computer program. It exhibits the sequences in which the instructions were executed. (2) To record a series of events as they occur. (3) In the 3130, a customer engineer and customer analysis procedure.

two-sided printing. Printing on both sides of a sheet of paper. Synonymous with *duplex printing*. Contrast with *simplex printing*.

V

variable data. The data that can vary; for example, the names and addresses in form letters. Contrast with *constant data*.

vector graphics. Computer graphics in which display images are generated from display commands and coordinate data. Contrast with *raster pattern*.

void. A missing part of the printed character.

Acronyms and Abbreviations

This list explains the acronyms and abbreviations used in this documents, and in the other documents that are part of the 3130 documentation library.

ABIC	Adoptive Bi-Level Image Compression.	IPDS	Intelligent Printer Data Stream.
AEA	Alternate Exception Action.	ISO	International Organization for Standardization.
AFIG	Advanced Function Image and Graphics.	LAN	Local Area Network.
AFP	Advanced Function Printing.	LF	Load Font command.
AFPDS	Advanced Function Printing Data Stream.	LU	Logical Unit.
AFPF	Advanced Function Print Finishing.	MB	Megabyte (1MB=1 048 576 bytes).
APA	All-Points Addressable.	MICR	Magnetic Ink Character Recognition.
ARQ	Active Record Queue.	MIH	Missing-Interrupt Handler.
ASHRAE	American Society of Heating, Refrigeration, and Air Conditioning Engineers.	MMR	Modified-Modified READ 2 dimensional image.
BCOCA	Bar Code Object Content Architecture.	MO:DCA	Mixed Object Document Content Architecture.
CCITT	Comite Consultatif International Telegraphique et Telephonique.	MR	Modified READ; (READ=Relative Element Address Designate) 2-dimensional image compression algorithm. Also referred to as CCITT Group 3.
CPGID	Code Page Identifier.	MVS	Multiple Virtual Storage.
CE	Customer Engineer (IBM).	NCP	Network Control Program
CEE	International Commission for Conformity Certification of Electrical Equipment.	OCR	Optical Character Recognition.
CSA	Canadian Standards Association.	OGL	Overlay Generation Language.
CU	Control Unit.	OS	Operating System
DASD	Direct Access Storage Device.	PAGEDEF	Page Definition.
DCF	Document Composition Facility.	PC	Photoconductor.
DPE	Decompression Performance Enhancement.	PEL	Picture Element.
EBCDIC	Extended Binary-Coded Decimal Interchange Code.	PEM	Print-Error Marker.
EC	Engineering Change.	PMF	Print Management Facility.
EHC	Exception Handling Control command.	PPFA	Page Printer Formatting Aid.
ESA	Enterprise System Architecture.	PSAF	Print Services Access Facility.
ESMM	End Select Medium Modification.	PSF	Print Services Facility.
FLSF	Font Library Service Facility.	RAM	Random Access Memory.
FGID	Font Global Identifier.	RRL	Request resource list.
FORMDEF	Form Definition.	SAA	System Application Architecture.
GCSGID	Graphic Character Set Global Identifier.	SDLC	Synchronous Data Link Control.
GDDM	Graphical Data Display Manager.	SMM	Select Medium Modification.
HAID	Host-Assigned ID.	SNA	System Network Architecture.
IHF	Image Handling Facility.	SSCP	System Services Control Point.
IML	Initial Microcode Load.	TCP/IP	Transmission Control Protocol/Internet Protocol.
		UL	Underwriter's Laboratory.
		VSE	Virtual Storage Extended.
		XA	Extended Architecture.
		XID	Exchange Station Identification.

Index

Numerics

4028 Compatibility Resident Font Set 42

A

abbreviations 84
acronyms 84
adhesive labels 32
Advanced Function Image and Graphics 7
airflow 19
altitude 19
applications
 converting to 3130 15
 environment 4
AS/400 Bolding Function 50
ASHRAE 19
attachment
 Ethernet TCP/IP 27
 hardware requirements 69
 SNA SDLC 27
 SNA Token-Ring 28
 twinaxial 27
audible alarm 5
authorization levels 6
auto eject 6
auto load 8

B

bar-code
 edge tolerance 14
 positioning and size 17
Basic N_Up and Enhanced N_Up Printing: 62
Basic N_Up Printing 62
basis weight 8
bibliography 73
Bolding Function 50
bolding of characters 17

C

cables
 locations 21
 power 20
cassettes 3
characteristics of the 3130 1—8
checklists and work sheets
 Ethernet TCP/IP attachment 27
 implementation plan 10
 installation planning worksheet 23
 SNA SDLC attachment 27
 SNA Token-Ring attachment 28

checklists and work sheets (*continued*)
 twinaxial attachment 27
cleaner unit 29
clearances, service 21
common features 3
Compatibility Resident Font Set, 4028 42
configuration
 Ethernet TCP/IP attachment 27
 of the printer 25
 SNA SDLC attachment 27
 SNA Token-Ring attachment 28
 twinaxial attachment 27
 work sheet 25
converting applications to the 3130 15
Coordinated Font Set 44
Core Interchange Resident Scalable Font Set 37
current, input 20

D

data security 6
DBCS Resident Raster Font Set 45
default font 49
developer mix 29
dimensions 21

E

electrical
 power requirements 20
 requirements 20
 safety 20
Enhanced N_Up Printing 62
environment
 application 4
 requirements 19
environments 4, 59
error log 6
Ethernet TCP/IP attachment 27

F

features
 Advanced Function Image and Graphics 7
 common 3
 operational 5
 optional 3
 paper cassettes 33
fire safety 20
fonts
 4028 Compatibility Resident Code Page Set 44
 4028 Compatibility Resident Font Set 42
 AS/400 Bolding Function 50

fonts (*continued*)

- DBCS Resident Raster Font Set 45
- default 49
- GCSGID Subsets 45
- GCSGID Subsets for IBM Core Interchange Fonts 39
- IBM Coordinated Font Set 44
- IBM Core Interchange Resident Code Page Set 39
- IBM Core Interchange Resident Scalable Font Set 37
- migration considerations 15
- supported 37—52

forms

- basis weight 8
- requirements 8
- sizes and types used 8

frequency, nominal 20

functional overview 1—8

fuser unit 29

G

Graphic Image Content Architecture objects 15

graphics performance 7

H

handling paper 8

heat

- dissipation 19

- output 19

host environments 4, 59

humidity 19

I

IBM Coordinated Font Set 44

IBM Core Interchange Resident Scalable Font Set 37

IM images 15

Image Object Content Architecture images 15

images 7

implementation plan 10

input trays 3

installation

- licensed programs 14

- planning worksheet 23

- requirements 22

Interchange Resident Scalable Font Set, IBM

CORE 37

L

labels 32

LAN Manager (Microsoft) 61

LAN Server (OS/2) 61

large print function 17

layout considerations 21

levels, sound 20

Lexmark International 29

line-printer data conversion 15

M

measurements, clearance 21

Microsoft LAN Manager 61

models 2

N

N_Up Printing 62

noise levels 20

O

operating requirements

- attachment hardware 69

- electrical 20

- environmental 19

- space 21

operational features 5

options, printer 3

ordering supplies 29

OS/2 LAN Manager 61

OS/400 printer transforms 64

output trays 3

output, heat 19

overlay generation language (OGL) 17

overview 1—8

P

paper

- cassettes 33

- handling 8

- input trays 8

- sizes 8, 30, 31

- storage 36

- weight ranges 8, 30

performance

- factors affecting 7

- image and graphics 7

photoconductor belt 29

physical layout 21

plugs 71

point of origin 14

power

- consumption 20

- dissipation 20

- input 20

- voltage 20

pre-installation tasks 22

print

- density 7

- print (*continued*)
 - material 8
 - supplies 29
- printer
 - cleaner unit 29
 - common features 3
 - configuration 25
 - developer mix 29
 - dimensions 21
 - fuser unit 29
 - host environments 4, 59
 - operational features 5
 - paper cassettes 33
 - photoconductor belt 29
 - supplies 29
 - toner cartridge 29
 - transfer belt unit 29
- printer transforms for OS/400 64
- product summary 1—8
- publications x

R

- receptacles 71
- related publications x
- relative humidity, permitted values 19
- requirements
 - Advanced Function Presentation (AFP) licensed programs 14
 - airflow 19
 - altitude 19
 - attachment hardware 69
 - electrical 20
 - environmental 19
 - humidity 19
 - installation 22
 - paper 8
 - sound levels 20
 - space 21
 - special-purpose materials 8
 - temperature 19
 - ventilation 19
- Resident Raster Font Set, DBCS 45
- Resident Scalable Font Set, IBM CORE Interchange 37

S

- safety 20
- Scalable Font Set, IBM CORE Interchange 37
- security, data 6
- service clearances 21
- SNA SDLC attachment 27
- SNA Token-Ring SNA attachment 28
- sound levels 20

- space requirements 21
- special-purpose materials
- stackers 3
- storage
 - forms 36
 - paper 36
 - supplies 36
- supplies
 - ordering 29
 - paper cassettes 33
 - special-purpose materials 8
 - storage 36
- supported environments 4, 59

T

- temperature 19
- threading, automatic 8
- token-ring SNA attachment 28
- toner cartridge 29
- traces 6
- training 11
- transfer belt unit 29
- transforms, OS/400 64
- twinaxial attachment 27

V

- ventilation 19
- verifying licensed programs 14
- voltage
 - input current 20
 - nominal 20
 - requirements 20

W

- weight 21
- wiring information 20
- work sheets and checklists
 - implementation plan 10
 - installation planning worksheet 23

Readers' Comments — We'd Like to Hear from You

**3130 Advanced Function Printer
Introduction and Planning Guide
Publication No. G544-3974-04**

Use this form to provide comments about this publication, its organization, or subject matter. Understand that IBM may use the information any way it believes appropriate, without incurring any obligation to you. Your comments will be sent to the author's department for the appropriate action. Comments may be written in your language.

Note: IBM publications are not stocked at the location to which this form is addressed. Direct requests for publications or for assistance in using your IBM system, to your IBM representative or local IBM branch office.

	Yes	No
• Does the publication meet your needs?	_____	_____
• Did you find the information:		
Accurate?	_____	_____
Easy to read and understand?	_____	_____
Easy to retrieve?	_____	_____
Organized for convenient use?	_____	_____
Legible?	_____	_____
Complete?	_____	_____
Well illustrated?	_____	_____
Written for your technical level?	_____	_____
• Do you use this publication:		
As an introduction to the subject?	_____	_____
As a reference manual?	_____	_____
As an instructor in class?	_____	_____
As a student in class?	_____	_____
• What is your occupation?	_____	_____

Thank you for your input and cooperation.

Note: You may either send your comments by fax to 1-800-524-1519, or mail your comments. If mailed in the U.S.A., no postage stamp is necessary. For residents outside the U.S.A., your local IBM office or representative will forward your comments.

Comments:

Name

Address

Company or Organization

Phone No.



Cut or Fold
Along Line

Fold and Tape

Please do not staple

Fold and Tape



NO POSTAGE
NECESSARY
IF MAILED IN THE
UNITED STATES

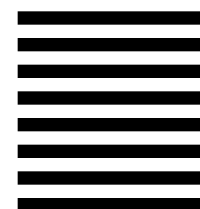

BUSINESS REPLY MAIL

FIRST-CLASS MAIL PERMIT NO. 40 ARMONK, NEW YORK

POSTAGE WILL BE PAID BY ADDRESSEE

Information Development
The IBM Printing Systems Company
Department H7FE Building 003G
P O Box 1900
BOULDER CO 80301-9817



Fold and Tape

Please do not staple

Fold and Tape

Cut or Fold
Along Line

Free Manuals Download Website

<http://myh66.com>

<http://usermanuals.us>

<http://www.somanuals.com>

<http://www.4manuals.cc>

<http://www.manual-lib.com>

<http://www.404manual.com>

<http://www.luxmanual.com>

<http://aubethermostatmanual.com>

Golf course search by state

<http://golfingnear.com>

Email search by domain

<http://emailbydomain.com>

Auto manuals search

<http://auto.somanuals.com>

TV manuals search

<http://tv.somanuals.com>