

**These user's setup instructions cover typical user environments. The on-screen messages may differ depending on the level of your hardware and software. In some cases you may need to vary the setup procedures.**

**For more information, refer to your computer or operating system manuals or consult your system administrator or dealer.**

**Ces instructions de configuration d'exploitation s'appliquent aux environnements d'utilisation types. Les messages affichés à l'écran peuvent varier en fonction du niveau de votre matériel et de vos logiciels informatiques. Dans certains cas, vous pouvez être amenés à changer de procédures de configuration.**

**Pour de plus amples informations à ce sujet, veuillez vous reporter aux manuels de votre ordinateur et de votre système d'exploitation, ou consultez l'administrateur de votre système ou votre revendeur.**

**Diese Einstellungsanweisungen durch den Benutzer gelten für typische Betriebsumgebungen. Die Bildschirmmeldungen können je nach Art der verwendeten Hardware und Software auch anders lauten. In einigen Fällen müssen die Einstellungsschritte unter Umständen abgeändert werden.**

**Weitere Informationen finden Sie im Computer- oder Betriebssystemhandbuch, oder wenden Sie sich an Ihren Systemadministrator oder Fachhändler.**

**En estas instrucciones de configuración se describen entornos de usuarios típicos. Los mensajes en pantalla, pueden diferir según sea el nivel del hardware y del software. En algunos casos, necesitará seguir otros procedimientos para la configuración.**

**Para obtener más información, puede consultar los manuales del ordenador o del sistema operativo o ponerse en contacto con el administrador del sistema o con el distribuidor.**

**Queste istruzioni di configurazione per l'utente coprono gli ambienti operativi comuni. I messaggi che appaiono sul video possono differire a seconda dell'hardware e del software utilizzati. In alcuni casi potrebbe essere necessario variare le procedure di configurazione.**

**Per ulteriori informazioni, fare riferimento ai manuali del computer o del sistema operativo, o consultare il proprio amministratore di sistema o il concessionario.**

## DANGER

### To avoid shock hazard:

- Do not remove the covers.
- Do not operate this product unless the stand is attached.
- Do not connect or disconnect this product during an electrical storm.
- The power cord plug must be connected to a properly wired and grounded power outlet.
- Any equipment to which this product will be attached must also be connected to properly wired and grounded power outlets.
- To isolate the monitor from the electrical supply, you must remove the plug from the power outlet. The power outlet should be easily accessible.

## DANGER

### Pour éviter les risques d'électrocution :

- Ne retirez pas les capots du moniteur.
- N'utilisez pas ce produit si le socle n'est pas fixé.
- Ne connectez, ni ne déconnectez ce produit pendant un orage.
- Le câble d'alimentation doit être connecté à une prise électrique correctement mise à la terre et en bon état de marche.
- Tout équipement auquel ce produit est relié doit être également connecté à une prise correctement mise à la terre et en bon état de marche.
- Pour isoler le moniteur de la source d'alimentation électrique, vous devez le débrancher de la prise électrique. Cette prise doit être facile d'accès

## GEFAHRENHINWEIS

### Um die Gefahr eines elektrischen Schlags zu vermeiden, folgendes beachten:

- Unter keinen Umständen die Abdeckungen abnehmen.
- Das Produkt nicht in Betrieb nehmen, wenn der Sockel nicht montiert ist.
- Das Gerät nicht während eines Gewitters an eine Steckdose anschließen oder von ihr trennen.
- Das Netzkabel ist an eine ordnungsgemäß verdrahtete und geerdete Steckdose anzuschließen.
- Jedes Gerät, mit dem dieses Produkt verbunden wird, muß ebenfalls an eine ordnungsgemäß verdrahtete und geerdete Steckdose angeschlossen werden.
- Um den Monitor von der Stromversorgung zu trennen, muß der Stecker aus der Steckdose gezogen werden. Die Steckdose sollte leicht zugänglich sein.

 **GEVAAR****Ga als volgt te werk om het gevaar van een elektrische schok te voorkomen:**

- Verwijder in geen enkel geval de kap.
- Stel dit produkt alleen in werking als de voet is bevestigd.
- Sluit dit apparaat niet aan op, of verbreek de aansluiting van dit apparaat niet van een contactdoos tijdens onweer.
- Het netsnoer moet worden aangesloten op een gearde contactdoos met correcte bedrading.
- Ook alle apparatuur waarop dit produkt wordt aangesloten moet zijn aangesloten op een contactdoos met correcte bedrading.
- Om het beeldscherm te ontkoppelen van de netvoeding, dient u de stekker uit de contactdoos te trekken. De contactdoos dient goed toegankelijk te zijn.

 **PELIGRO****Para evitar riesgos de descargas eléctricas:**

- No retire bajo ningún concepto las cubiertas.
- No maneje el monitor sin antes acoplar el soporte.
- No conecte ni desconecte el equipo de una toma de alimentación durante una tormenta eléctrica.
- El cable de alimentación debe estar conectado a un enchufe debidamente cableado y con toma de tierra.
- Cualquier equipo al que se vaya a conectar este producto también debe estar conectado a tomas de alimentación cableadas y conectadas a tierra correctamente.
- Para aislar el monitor del suministro eléctrico, debe retirar el enchufe de la toma de alimentación. Esta toma deberá ser de fácil acceso.

 **PERICOLO****Per evitare il rischio di scariche elettriche:**

- Non rimuovere nessuna parte del telaio.
- Non accendere il prodotto se il piedistallo non è stato montato.
- Non collegare o scollegare il prodotto nel corso di un temporale.
- La spina del cavo di alimentazione deve essere collegata ad una presa di corrente con messa a terra, installata in maniera appropriata.
- Le apparecchiature a cui il prodotto viene attaccato devono essere collegate a prese di corrente con messa a terra, installate in maniera appropriata.
- Per isolare il monitor dalla corrente elettrica, staccare la spina dalla presa di alimentazione, che deve essere facilmente accessibile.

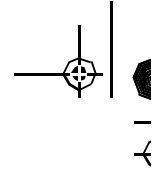

## PERIGO

### Para evitar o perigo de choques eléctricos:

- Não retire as coberturas.
- Não utilize este produto antes de montar a base.
- Não ligue nem desligue este produto durante uma tempestade eléctrica.
- O cabo de alimentação deve ser ligado a uma tomada eléctrica devidamente ligada à terra.
- Qualquer equipamento ligado a este produto deve estar ligado a tomadas eléctricas devidamente ligadas à terra.
- Para isolar o monitor da fonte de alimentação, retire a ficha do cabo de alimentação da tomada eléctrica. A tomada eléctrica deve ser de fácil acesso.

## FARE

### Sådan undgår du elektrisk stød:

- Kabinettet må under ingen omstændigheder fjernes.
- Undgå at anvende dette produkt, uden at vippe/drejefoden er monteret.
- Undgå at tilslutte eller frakoble dette produkt i tordenvejr.
- Netledningen skal være tilsluttet en korrekt jordet stikkontakt med korrekt ledningsføring.
- Alt udstyr, som tilsluttes dette produkt, skal også være tilsluttet korrekt jordede stikkontakter med korrekt ledningsføring.
- For at isolere skærmen fra strømforsyningen, skal stikket tages ud af stikkontakten. Stikkontakten bør være let tilgængelig.

## FARE

### Slik unngår du fare for elektrisk støt:

- Ikke ta av dekslene.
- Ikke bruk produktet dersom sokkelen ikke er montert.
- Ikke koble produktet til eller fra under tordenvær.
- Pluggen på strømledningen må kobles til korrekt montert og jordet strømuttak.
- Utstyr som dette produktet eventuelt blir koblet til, må også kobles til korrekt montert og jordet strømuttak.
- For å isolere skjermen fra strømkilden må du ta ut pluggen fra strømuttaket. Strømuttaket bør være lett tilgjengelig.

## VARNING - LIVSFARA

### För att undvika risk för elektriska stötar måste du tänka på följande:

- Ta inte bort några skyddskåpor.
- Använd inte den här produkten innan du har satt fast stativet.
- Anslut inte produkten till ett eluttag under åskväder. Koppla inte heller ur produkten från ett eluttag under åskväder.
- Strömkabeln måste anslutas till ett felfritt och jordat uttag.
- All utrustning som den här produkten kopplas till måste också anslutas till felfria och jordade uttag.
- För att bryta strömmen till bildskärmen måste du dra ut kontakten. Vägguttaget bör vara lätt att komma åt.

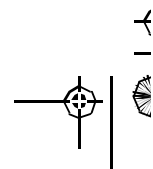
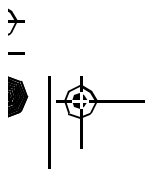

## **VAARA**

### **Sähköiskun vaaran välttämiseksi:**

- **Älä avaa laitteen kansia missään tilanteessa.**
- **Älä käytä laitetta, ellei jalustaa ole kiinnitetty.**  
Älä kytke laitetta pistorasiaan tai irrota sitä pistorasiasta ukonilman aikana. Virtajohto on kytkettävänä asianmukaisesti johdotettuun ja maadoitettuun pistorasiaan. Kaikki muutkin laitteet, joihin tämä tuote on liitetty, on kytkettävänä asianmukaisesti johdotettuihin pistorasioihin.
- **Kun haluat erottaa näyttimen sähköverkosta, sinun pitää irrottaa sen verkkojohto pistorasiasta.** Pistorasian pitäisi olla mahdollisimman lähellä näyttintä ja vaivattomasti käsillä.

## **ΚΙΝΔΥΝΟΣ**

### **Για την αποφυγή κινδύνου ηλεκτροπληξίας:**

- Μην αφαιρείτε τα καλύμματα.
- Μη θέτετε το προϊόν αυτό σε λειτουργία χωρίς να είναι στερεωμένη η βάση του.
- Μη συνδέετε ή αποσυνδέετε το προϊόν αυτό κατά τη διάρκεια ηλεκτροθύελλας.
- Το φως του καλωδίου ρευματολήπτη πρέπει να συνδεθεί σε μια πρίζα με σωστή καλωδίωση και γείωση.
- Κάθε συσκευή στην οποία συνδεθεί αυτό το προϊόν πρέπει επίσης να συνδεθεί σε πρίζα με σωστή καλωδίωση και γείωση.
- Για να απομονώσετε την οθόνη από την παροχή ρεύματος, πρέπει να αφαιρέσετε το φως από την πρίζα. Η πρίζα πρέπει να είναι σε σημείο εύκολα προσβάσιμο.

## **TEHLIKE**

### **Elektrik çarpması tehlikesinden kaçınmak için:**

- Kapakları çıkarmayınız.
- Bu cihazı kaidesine takılı durumda değilken çalıştırmayınız.
- Bu cihazı elektriksel fırtına sırasında prize takmayınız veya prizden çıkarmayınız.
- Elektrik kablosunun fişi, elektrik ve toprak bağlantıları usulüne uygun olarak yapılmış bir prize takılmalıdır.
- Bu cihazın bağlanacağı diğer tüm cihazlar da elektrik ve toprak bağlantıları usulüne uygun olarak yapılmış prize takılmış olmalıdır.
- Monitörün elektrikle bağlantısını kesmek için fişini prizden çekmeniz gereklidir. Priz, kolayca erişilebilecek bir yerde olmalıdır.

# English

ENGLISH

---

## First Edition (Nov/1998)

This publication could contain technical inaccuracies or typographical errors. Changes are made periodically to the information herein; these changes will be made in later editions. IBM may make improvements and/or changes in the product(s) and/or program(s) at any time.

It is possible that this publication may contain reference to, or information about, IBM products (machines and programs), programming, or services that are not announced in your country.

Requests for copies of this publication and for technical information about IBM products should be made to your IBM Authorized Dealer or IBM Retailer.

No part of this publication may be reproduced or distributed in any form or by any means without prior permission in writing from the International Business Machines Corporation.

© Copyright International Business Machines Corporation 1998. All rights reserved.

---

## Notices

References in this publication to IBM products, programs, or services do not imply that IBM intends to make these available in all countries in which IBM operates. Any reference to an IBM product, program or service is not intended to state or imply that only IBM's product, program, or service may be used. Any functionally equivalent product, program, or service that does not infringe any of IBM's intellectual property rights or other legally protectable rights may be used instead of the IBM product, program, or service. Evaluation and verification of operation in conjunction with other products, programs, or services, except those expressly designated by IBM, are the user's responsibility.

IBM may have patents or pending patent applications covering subject matter in this document. The furnishing of this document does not give you any license to these patents.

---

## Trademarks

The following terms, used in this publication, are trademarks or service marks of the IBM Corporation in the United States or other countries:

### **IBM HelpCenter**

ENERGY STAR is a U.S. registered mark.

# Contents

<b>Setup</b> .....	<b>2</b>
Hardware Requirements .....	2
Workplace Preparation .....	2
Working Practices .....	2
Handling Instructions .....	3
Connecting your Monitor .....	4
Switching on your Monitor .....	4
Adjusting the Monitor Position .....	5
Caring for your Monitor .....	5
<b>Configuring your Monitor</b> .....	<b>6</b>
Automatic Setup .....	6
Setup Diskette for Windows 95 or Windows 98 .....	6
<b>Auto Setup for the PC</b> .....	<b>7</b>
Auto Setup for DOS .....	8
Auto Setup for Windows 3.1, Windows 95, Windows 98 or Windows NT .....	9
Auto Setup OS/2 .....	11
<b>Manual Setup</b> .....	<b>13</b>
<b>Adjusting Your LCD Monitor</b> .....	<b>14</b>
User controls .....	14
On-screen display (OSD) controls .....	16
<b>Further Information</b> .....	<b>19</b>
Display modes .....	19
Power Management .....	21
<b>Troubleshooting</b> .....	<b>22</b>
Further Help .....	24
<b>Specifications</b> .....	<b>27</b>
<b>Compliances</b> .....	<b>I</b>
<b>Warranty</b> .....	<b>IV</b>



# Setup

---

## Hardware Requirements

This monitor requires a computer with a suitable on-board video sub-system or Video Adapter card that can support SXGA 1280 x 1024, XGA 1024 x 768, SVGA 800 x 600, or VGA 640 x 480 at 60 Hz.

---

## Handling Instructions

 Do not support the monitor within the screen area. The Liquid Crystal Display is glass and can be damaged by rough handling or excessive pressure.

1. Lift the monitor by placing both hands under the lower part of the cover.

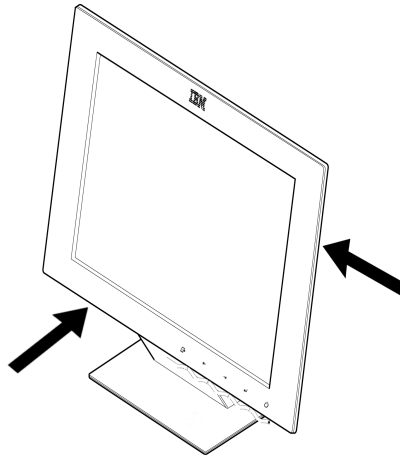

2. Before using your monitor for the first time, remove the clear protective film from the front of the screen.
- 

## Workplace Preparation

 This section gives advice on what you should consider before you set up your monitor.

### Height

The monitor should be positioned so that the top of the screen is slightly below your eye level when you sit at your workstation.

### Orientation

Choose a position that gives the least reflection from lights and windows, usually at a right angle to any windows. The monitor should be positioned directly in front of you so that you do not have to twist your body to use it. Tilt the monitor to a comfortable viewing angle.

---

## Working Practices

*i* This section gives advice on how you can work comfortably and reduce fatigue.

### Rest

Take regular breaks. Vary your posture, stand up and stretch occasionally as prolonged use of computer workstations can be tiring.

### Back

Adjust the height and angle of the chairback to support your lower back. Sit well back in your chair.

### Hands

Adjust the seat height so that your forearms are approximately horizontal and your wrists are straight when using the keyboard. Your upper arms should be relaxed with your elbows near your body.

Use a light touch on the keyboard, keeping your hands and fingers relaxed. Allow a space in front of the keyboard to rest your wrists when not typing. Consider using a wristpad.

### Eyesight

Working with monitors, in common with any prolonged close work, can be visually demanding. Look away from the screen periodically and have your eyesight checked regularly.

### Screen settings

Set the screen brightness and contrast to a comfortable level. You may have to adjust this as the lighting changes during the day. Many application programs let you select color combinations which can help you to view in comfort. See the **User controls** section starting on page 14 for more information.

---

## Connecting your Monitor

 Be sure to read the **'Safety Information'** at the front of this User Guide before carrying out this procedure.

 The AC adapter and D-SUB signal cable are connected to your monitor. If you wish to change these or to fit a different stand, see **Further Help** on page 24.

1. Turn off your PC and all attached devices.
2. Connect the signal cable (D-SUB type) to the video port on the back of your computer. This port might be directly attached to your computer (figure A), or it might be part of a video adapter card (figure B). The video port on your computer or video adapter card may be colored blue to match the blue connector on your monitor's video cable.

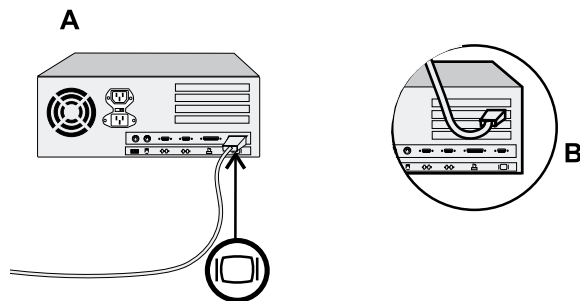

If you are using a workstation, you may need to use a 13W3 cable. Refer to **Installing a 13W3 Cable** on page 26 for instructions.

3. Connect the power cord to the power adapter first, then insert the plug into a properly grounded electrical outlet.

---

## Switching on your Monitor

1. Switch on the power source and your computer.
2. Switch on your monitor by pushing and releasing the power switch marked .  
(To switch off your monitor, push and release the power switch again.)
3. If you are using your monitor with a workstation, use the monitor's OSD to choose the 13W3 input source. (See **INPUT SELECTION** on page 18.)
4. Run AUTO SETUP by following the instructions in the **Configuring your Monitor** section on page 6.

---

## Adjusting the Monitor Position

### Viewing Angle

You can tilt the screen backward and forward as shown below.

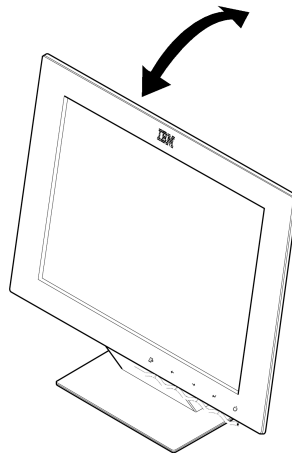

---

## Caring for your Monitor

Be sure to turn off the power before you perform any maintenance on the monitor. Clean your monitor as follows:

- Gently wipe the covers and the screen with a soft cloth.
- Remove finger marks and grease with a damp cloth and mild detergent; do not use solvents or abrasives.
- Never use flammable cleaning material to clean your IBM monitor or any other electrical apparatus.

# Configuring your Monitor

---

## Automatic Setup

*i* The Setup Utility included on the setup diskette is for displaying dot patterns. They do not replace or modify the display driver.

*i* The Automatic Setup instructions require the monitor to be warmed up for 15 minutes. This is not required for normal operation.

When you first use your monitor you must perform Automatic Setup (AUTO SETUP). This procedure sets up your monitor to process the video signals from your computer without image discoloration or smearing. After you perform AUTO SETUP, the settings are stored and used each time you turn on the monitor.

---

## Setup Diskette for Windows 95 or Windows 98

 **This section must be completed before continuing with the Windows 95 or Windows 98 Auto Setup for the PC on page 7.**

To use the Plug and Play feature in Windows 95 or Windows 98, files should be loaded from the IBM Color LCD Monitor Installation diskette as follows:

1. Turn off the computer and all attached devices.
2. Ensure that the monitor is connected correctly.
3. Turn on the monitor and then the system unit. Allow the system to boot into Windows 95 or Windows 98.  
Your computer's Plug and Play code may warn you that your system hardware has changed. This probably means that it has detected your new monitor for the first time.
4. Open the DISPLAY PROPERTIES window by clicking on START, SETTINGS, CONTROL PANEL and then double clicking on the DISPLAY icon.
5. Select the SETTINGS tab.
6. Select the CHANGE DISPLAY TYPE button.
7. Select the CHANGE MONITOR TYPE button.
8. Insert the Setup diskette into drive A: and select the HAVE DISK button.
9. Select OK.
10. Choose IBM T85A monitor and select OK. The files will be copied from the diskette to your hard drive.
11. Close all open windows and remove the diskette.
12. Reboot the system.

The system will automatically select the maximum refresh rate and corresponding Color Matching Profiles.

*i* On LCD monitors, unlike CRTs, a faster refresh rate does not improve display quality. IBM recommends using either 1280 x 1024 at a refresh rate of 60Hz or 640 x 480 at a refresh rate of 60Hz.

# Auto Setup for the PC

 **Before carrying out this section, it is very important that The Setup Diskette for Windows 95 or Windows 98 has been run. (see page 6)**

Locate the operating system installed on your PC in the table below and follow the appropriate instructions. You may choose to run AUTO SETUP for each operating system that you use. This means that if you sometimes use your monitor while running any version of Windows and sometimes also use it from within DOS (not a DOS window), you must run AUTO SETUP for both Windows and DOS. You may run versions of AUTO SETUP in any order.

Operating System	Corresponding Auto Setup procedure
DOS	<b>Auto Setup for DOS on page 8</b>
Windows 3.1	<b>Auto Setup for Windows 3.1, Windows 95, Windows 98 or Windows NT on page 9</b>
Windows 95	
Windows 98	
Window NT	
Operating System/2 (OS/2)	<b>Auto Setup OS/2 on page 11</b>

 If your PC does not run with the setup diskettes shipped with the monitor, refer to **Manual Setup** on page 13

Before you begin AUTO SETUP for your PC:

1. Make a backup copy of the setup diskettes supplied with the monitor.
2. Make sure the PC's video mode is set in the range of the supported screen resolution shown in the table on page 20.

 The AUTO SETUP process only applies to the current screen mode. When a new mode is selected, repeat this section to reset the monitor

You should perform AUTO SETUP for each screen mode you use.

---

## Auto Setup for DOS

***i** If the monitor is in standby mode (STANDBY ON), it may automatically turn off while you are waiting for it to warm up. If this happens, switch off the monitor and switch it on again after a few seconds.*

*If your system goes into standby mode again, reboot your system and change the system Bios Setup Utility to DISABLE Power Saving. Refer to your system manual.*

***i** If you are using PC-DOS/ V, change to U.S. mode by typing 'CHEV US' and pressing ENTER at the command prompt.*

**⚠ You must use DOS or OS/2 DOS Full Screen (not under Windows or OS/2 DOS window, OS/2 window, or OS/2 full screen) when you run DOS Auto Setup.**

***i** The size and diversity of the dot pattern varies with the screen resolution.*

***i** If the screen flickers, repeat the setup several times until the flicker is minimised, or adjust it manually by following **Manual Setup** on page 13.*









1. Turn on the monitor first; then the PC.

If the message CHECK SIGNAL CABLE is displayed, or if nothing is displayed check:

- that the video interface cable is connected properly
- the correct video adapter card is installed
- the correct supported display mode is selected for your PC.

2. Wait approximately 15 minutes, until the monitor warms up.
3. Insert the diskette labelled 'IBM Monitor Installation Disk' into the diskette drive.
4. Display the command prompt screen of the DOS full-screen display.
5. At the command prompt, type 'A:' and press ENTER.
6. Type 'TESTPATD' and press ENTER.
7. Select from the screen the number for the color or text mode you want to setup.
8. Select from the screen the number for the video mode you want to setup.

You may repeat this process for as many of the color and video modes as you need.

9. When the dot pattern appears, press the OSD Enter button  at the bottom of the monitor to display the initial OSD menu.
10. Use an Arrow button (  or  ) to select the IMAGE LOCK icon  then press the OSD Enter  button to access the function.
11. Using an Arrow button (  or  ), select AUTOMATIC and press the OSD Enter button . This activates the AUTO SETUP procedure, which will optimize the display settings with the provided dot-patterns.  
  
The screen will dim, blink on and off several times and you may notice small changes to the test pattern.
12. When finished, the OSD main menu returns. Press the Exit button  to exit from the OSD.
13. Press the ESCAPE key to exit the test pattern program.
14. Type 'Exit' at the command prompt to return to Windows.

If you use other operating systems, perform the appropriate AUTO SETUP for those systems, also: see **Auto Setup for Windows 3.1, Windows 95, Windows 98 or Windows NT** on page 9 and **Auto Setup OS/2** on page 11.

# Auto Setup for Windows 3.1, Windows 95, Windows 98 or Windows NT

*i* If the monitor is in standby mode (STANDBY ON), it may automatically turn off while you are waiting for it to warm up. You can disable the Windows energy saving feature by clicking on the START button and selecting SETTINGS, CONTROL PANEL, DISPLAY, SCREEN SAVER. Make sure that the ENERGY SAVING FEATURES OF MONITOR check boxes are either empty, or that the features are set to at least 20 minutes.









Your system may also have its Power Saving utility enabled through the Bios Setup Utility. Refer to your system manual for directions on disabling that bios option.

1. Turn on the monitor first; then the PC.  
If the message CHECK SIGNAL CABLE is displayed, or if nothing is displayed check:
  - that the video interface cable is connected properly.
  - the correct video adapter card is installed.
  - the correct supported display mode is selected for your PC.
2. Wait approximately 15 minutes, until the monitor warms up.
3. Drag the icon bar and tool bar, if they are displayed, to the bottom of the screen.
4. Insert the diskette labelled 'IBM Monitor Installation Disk' into the diskette drive.
5. Check the operating system installed on your PC and follow the instructions from the table below.

Operating System	Step1	Step2	Step3	Step4
Windows 3.1	Open PROGRAM MANGER	Select FILE	Select RUN	Type 'A:\TESTPAT' and press ENTER
Windows NT 3.5				
Windows 95	Select START	Select RUN		
Windows 98				
Windows NT 4.0				

*i* The size and diversity of the dot pattern varies with the screen resolution.

*i* Position the mouse pointer at the bottom center of the screen. This allows AUTO SETUP to run properly

6. When the test pattern appears, press the OSD Enter button  at the bottom of the monitor to display the initial OSD menu.
7. Use an Arrow button (  or  ) to select the IMAGE LOCK icon  and press the OSD Enter button  to access the function.
8. Using an Arrow button (  or  ), select AUTOMATIC and press the OSD Enter button . This activates the AUTO SETUP procedure, which will optimize the display settings with the provided test pattern.  
The screen will dim, blink on and off several times, and you may notice small changes to the test pattern.  
*(To abort the AUTO SETUP function, press the Esc key.)*
9. When finished, the OSD main menu returns. Press the Exit button  once to exit from the OSD.



10. Press the Esc key to return to Windows.

You have completed the monitor setup for Windows. If you use other operating systems, perform the appropriate AUTO SETUP for those systems, also: see ***Auto Setup OS/2*** on page 11 and ***Auto Setup for DOS*** on page 8.









## Auto Setup OS/2

*i* If the monitor is in standby mode (STANDBY ON), it may automatically turn off while you are waiting for it to warm up.

1. Turn on the monitor first; then the PC.

If the message CHECK SIGNAL CABLE is displayed, or if nothing is displayed check:

- that the video interface cable is connected properly.
- the correct video adapter card is installed.
- the correct supported display mode is selected for your PC.

2. Wait approximately 15 minutes, until the monitor warms up.
3. Insert the diskette labelled 'IBM Monitor Installation Disk' into the diskette drive.
4. Select OS/2 SYSTEM, SYSTEMS SETUP, SYSTEM. Select SCREEN RESOLUTION 1280 x 1024 x 256.
5. Select SCREEN REFRESH of 60Hz.
6. Close SYSTEMS and restart your system.
7. At the OS/2 command prompt, select the OS/2 FULL SCREEN command.
8. Press mouse button 2 and select SETTINGS or PROPERTIES (depending on your OS/2 version).
9. Select SESSION and then choose WIN-OS/2 FULL SCREEN.
10. Open the OS/2 full-screen window.
11. At the command prompt type **A:** and press ENTER.
12. Type **TESTPATS** and press ENTER.
13. When the dot pattern appears, press the OSD Enter button  to display the initial OSD menu.
14. Use an Arrow button (  or  ) to select the IMAGE LOCK icon  and press the OSD Enter button  to access the function.
15. Using an Arrow button (  or  ), select AUTOMATIC and press the OSD Enter button . This activates the AUTO SETUP procedure, which will optimize the display settings with the provided test pattern.  
The screen will dim, blink on and off several times, and you may notice small changes to the test pattern.

*(To abort the AUTO SETUP function, press the ESCAPE key.)*

*i* The size and diversity of the dot pattern varies with the screen resolution.

*i* Position the mouse pointer at the bottom center of the screen. This allows AUTO SETUP to run properly.

***i** If the screen flickers, repeat the setup several times until the flicker is minimised, or adjust it manually by following **Manual Setup** on page 13.*

16. When finished, the OSD main menu returns. Press the Exit button  to exit from the OSD.
17. Press the ESCAPE key to return to the OS/2 Window.

You have completed the monitor setup for OS/2. If you use other operating systems, perform the appropriate AUTO SETUP for those systems, also: see **Auto Setup for Windows 3.1, Windows 95, Windows 98 or Windows NT** on page 9 and **Auto Setup for DOS** on page 8.













# Manual Setup

**i** If the monitor is in standby mode (STANDBY ON), it might automatically turn off while you are waiting for it to warm up.

To disable the Windows energy saving feature by clicking on the START button and selecting SETTINGS, CONTROL PANEL, DISPLAY, SCREEN SAVER. Make sure that the ENERGY SAVING FEATURES OF MONITOR check boxes are either empty, or that the features are set to at least 20 minutes.

Your system may also have its Power Saving utility enabled through the Bios Setup Utility. Refer to your system manual for directions on disabling that bios option.

Normally, you can complete the setup procedure using AUTO SETUP, however, if your screen image is still distorted after you perform AUTO SETUP or the setup diskette does not run on your system, perform MANUAL SETUP.

1. Have your computer and monitor turned on for at least 15 minutes until the monitor and video adapter have warmed up.
2. You may wish to start the program you most often use so that you can adjust for a “typical” screen.
3. Press the OSD Enter button  at the bottom of the monitor to display the initial OSD menu.
4. Use an Arrow button (  or  ) to select the IMAGE LOCK icon  and press the OSD Enter button  to access the function.
5. Using an Arrow button (  or  ), select MANUAL, press  and then press  once to select COARSE. Left and right arrow adjustment indicators become illuminated (see page 17).
6. Use the Arrow buttons to correct (as much as possible) for noise in the video signal then press  to save the changes.
7. Use an Arrow button to select FINE and press the  button.
8. Use the Arrow buttons again to tune the image to your liking.
9. When finished, press the Exit button  four times to exit from the OSD.

You have completed the monitor setup.

# Adjusting Your LCD Monitor

## User controls



### User control features

Icon	Control	Description
	Exit	OSD inactive: Switches the video input source OSD active: Exits from menus and sub-menus Exits the OSD
	Left Arrow	Displays the OSD main menu Moves the cursor to highlight icons and other options
	Right Arrow	Displays the OSD main menu Moves the cursor to highlight icons and other options
	OSD Enter	Displays the OSD main menu Enters menus and sub-menus and selects the highlighted option
	Power Switch	Switches the monitor on and off

### Operation

- Press an Arrow button or the OSD Enter button to display the main OSD menu.
- Use the Arrow buttons to move among the icons. Select an icon and press OSD Enter to access that function. If there is a sub-menu, you can move between options using the Arrow buttons, then press OSD Enter to select that function. Use the Arrow buttons to make adjustments.
- Press the Exit button to move backwards through the sub-menus and exit from the OSD.

**Note:** After making adjustments, the Power indicator LED will briefly turn amber to indicate that the new value has been saved.

*i* The image is already optimized for many display modes, however the user controls can be used to adjust the image to your liking.

*i* The settings are saved after adjustment and when exiting the OSD and will be effective thereafter.

## **OSD Lock / Unlock**

This feature allows you to secure the current control settings, while allowing the user to adjust Brightness and Contrast, so that they cannot be inadvertently changed. You can unlock the OSD controls at any time by using the same procedure.

Push and hold the button for 10 seconds to Lock or to Unlock. When locked, a "CONTROLS LOCKED" message will be displayed.

## On-screen display (OSD) controls





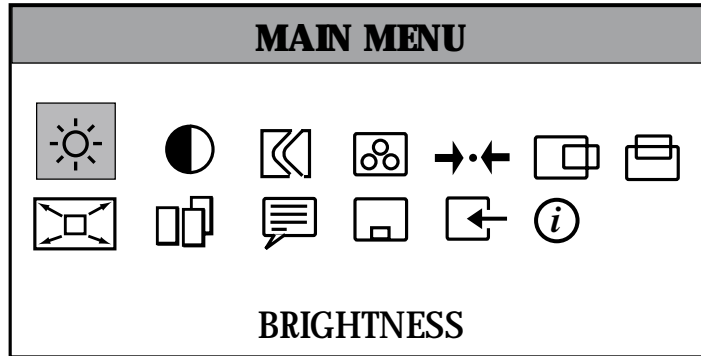

The settings adjustable with the user controls are viewed through the On-Screen Display (OSD). Press any of the OSD buttons to activate the OSD.







*i* The LCD monitor needs time to become thermally stable the first time you turn it on each day. Thus, to achieve more accurate adjustments for parameters, allow the LCD monitor to warm up (be On) for at least 15 minutes before making any screen adjustments.

### Initial appearance of OSD











### OSD functions

OSD Icon	Description	Sub-menu(s)	Controls and Adjustments	
 <b>BRIGHTNESS</b>	Adjusts brightness		 —	 <b>+</b>
 <b>CONTRAST</b>	Adjusts contrast		 —	 <b>+</b>
 <b>IMAGE LOCK</b>	The image lock function is used to adjust the level of noise in the video signal which causes horizontal lines or areas on the screen where the image appears to be unstable and jitters or shimmers. This can be done automatically or manually.	<b>AUTOMATIC</b>	Automatic adjusts the monitor.	

OSD Icon	Description	Sub-menu(s)	Controls and Adjustments		
 <p><b>IMAGE LOCK</b> (continued)</p>		<p><b>MANUAL -</b></p> <ul style="list-style-type: none"> <li>• <b>Fine</b></li> <li>• <b>Coarse</b></li> </ul>	<p>Use the Arrow buttons to adjust away the interference. If satisfactory results are not obtained using the Fine adjustment, use the Coarse adjustment and then use Fine again. This function may change the width of the display image. Use the H-Position function to center the display image on the screen.</p>		
 <p><b>COLOR</b></p>	<p>Select the preset Color mode you find most comfortable and then fine tune the colors using the User submenu, if necessary.</p>	<p><b>PRESET</b></p>	<p>1 - (Cool White) 2 - (Normal White) 3 - (Warm White)</p>		
		<p><b>USER</b></p> <ul style="list-style-type: none"> <li>• Red</li> <li>• Green</li> <li>• Blue</li> </ul>	<p>Increases or decreases redness Increases or decreases greenness Increases or decreases blueness</p>		
 <p><b>RESET</b></p>	<p>Resets the Brightness, Contrast, Image Lock Fine and Coarse, Color, H-Position, V-Position, and Display Size settings.</p>	<p><b>NO</b> - Does not make the adjustment <b>YES</b> - Resets the settings</p>			
 <p><b>H-POSITION</b></p>	<p>Moves the screen left and right.</p>	<table border="1" style="width: 100%; text-align: center;"> <tr> <td data-bbox="1090 1109 1219 1244">  —         </td> <td data-bbox="1219 1109 1343 1244">  +         </td> </tr> </table>		 —	 +
 —	 +				
 <p><b>V-POSITION</b></p>	<p>Moves the screen down and up.</p>	<table border="1" style="width: 100%; text-align: center;"> <tr> <td data-bbox="1090 1244 1219 1380">  —         </td> <td data-bbox="1219 1244 1343 1380">  +         </td> </tr> </table>		 —	 +
 —	 +				
 <p><b>DISPLAY SIZE</b></p>	<p>If your computer or video board supplies a signal rate and addressability lower than 1280 x 1024, this LCD monitor provides a scaling processor that can expand the addressability up to 1280 x 1024.</p>	<p><b>EXPANDED</b></p>	<p>1 - Image enlarged to fill the entire screen. 2 - Image enlarged to fill the width of the screen only.</p>		
		<p><b>NORMAL</b></p>	<p>Image at normal size.</p>		



OSD Icon	Description	Sub-menu(s)	Controls and Adjustments
 <b>IMAGE EFFECT</b>	Select this icon to optimize the display for the type of software you are using. <b>Scaling</b> smooths an image which may help the eye to see more detail. <b>Filtering</b> sharpens text by adding a fine, contrasting line around each character so that it is easier to recognize.	<b>SCALING</b>	<b>ON</b> - Turns Scaling on. <b>OFF</b> - Turns Scaling off.
		<b>FILTER</b>	<b>ON</b> - Turns Filtering on. <b>OFF</b> - Turns Filtering off.
 <b>LANGUAGE</b>	The language chosen affects only the language of the OSD. It has no effect on any software running on the computer.		Select one of the five languages to use for the OSD.
 <b>OSD MENU POSITION</b>	Changes the position of the OSD on the screen.	<b>H-POSITION</b>	 
		<b>V-POSITION</b>	 
 <b>INPUT SELECTION</b>	This monitor can accept video signals through two different connectors. Most desktop computers use a D-SUB connector. Most workstations use a 13W3 connector.		<b>1</b> - selects D-SUB <b>2</b> - selects 13W3
 <b>INFORMATION</b>	Shows information about the addressability and the horizontal and vertical frequencies available. The current setting for the images received from the computer or video board is displayed along the bottom of both submenus.	<b>USER MODES</b>	Lists all modes which you have defined by making changes using the OSD controls
		<b>PRESET MODES</b>	Lists all modes that have been defined during manufacture

# Further Information

---

## Display modes

The display mode the monitor uses is controlled by the computer. Therefore, you should refer to your computer documentation for details on how to change display modes.

The image size, position and shape may change when the display mode changes. This is normal and the image can be readjusted using AUTO SETUP and the monitor controls.

Unlike CRT monitors, which require a high refresh rate to minimize flicker, TFT technology is inherently flicker-free. If possible, configure your computer for 1280 x 1024 addressability at 60Hz vertical refresh rate.

For the display modes listed on page 20, the screen image has been optimized during manufacture.

## Factory Set Display Modes

*i* If your computer has previously been used with a CRT monitor and is currently configured to a display mode outside the range that the Flat Panel monitor can display, you may need to re-attach the CRT monitor temporarily until you have re-configured the computer, preferably to 1280 x 1024 at 60Hz.

Addressability	Refresh Rate	Horizontal Frequency
640 × 350	70 Hz	31.5 kHz
640 × 480	75 Hz	37.5 kHz
640 × 480	72 Hz	37.8 kHz
640 × 480	66 Hz	35.0 kHz
640 × 480	60 Hz	31.5 kHz
720 × 400	70 Hz	31.4 kHz
800 × 600	56 Hz	35.1 kHz
800 × 600	60 Hz	37.8 kHz
800 × 600	72 Hz	48.0 kHz
800 × 600	75 Hz	46.8 kHz
832 × 624	75 Hz	49.7 kHz
1024 × 768	60 Hz	48.8 kHz
1024 × 768	70 Hz	56.5 kHz
1024 × 768	75 Hz	60.0 kHz
1152 × 864	75 Hz	67.5 kHz
1152 × 870	75 Hz	68.7 kHz
1152 × 900	66 Hz	61.8 kHz
1280 × 1024	75 Hz	79.9 kHz
1280 × 1024†	60 Hz	63.9 kHz
1280 × 1024	72 Hz	78.1 kHz
1280 × 1024	76 Hz	81.1 kHz

† Recommended

## Power Management

To benefit from power management, the monitor must be used in conjunction with a computer that implements the Video Electronics Standards Association (VESA) Display Power Management Signalling (DPMS) Standard.

The power management feature is invoked when the computer recognizes that you have not used your mouse or keyboard for a user-definable period. There are several states as described in the table below.

As an ENERGY STAR<sup>®</sup> Partner, IBM has determined that this product meets the ENERGY STAR<sup>®</sup> guidelines for energy efficiency.

IBM recommends that you switch off your monitor at the end of each working day, or whenever you expect to leave it unused for long periods during the day.

State	Power Indicator	Screen	Restoring Operation	Compliance
<b>On</b>	Steady green	Normal		
<b>DPMS Standby</b>	Steady amber	Blank	Press a key or move the mouse.	ENERGY STAR <sup>®</sup> and NUTEK
<b>DPMS Suspend</b>	Flashing amber (0.5 sec. interval)	Blank	Press a key or move the mouse. ‡	ENERGY STAR <sup>®</sup> and NUTEK
<b>DPMS Off</b>	Flashing amber (1 sec. interval)	Blank	Press a key or move the mouse. ‡	ENERGY STAR <sup>®</sup> and NUTEK

‡ There may be a slight delay before the picture reappears.

# Troubleshooting

---

If you have a problem setting up or using your monitor, you may be able to solve it yourself. Before calling your retailer or IBM, try the suggested actions that are appropriate to your problem.

Problem	Possible Cause	Suggested Action	Reference
Screen is blank and power indicator is off	No power to monitor	Ensure that the electrical outlet and the monitor are both switched on. Check that the power cord is firmly plugged into the electrical outlet and the power supply unit. If the power cord plug has a removable fuse, replace it. Try another power cord. Try another electrical outlet.	<b>Connecting your Monitor</b> section on page 4
Screen is blank and power indicator is steady green	Brightness and Contrast may be too low	Adjust brightness and contrast.	<b>User controls</b> section on page 14
Screen is blank and power indicator is steady amber	The monitor is in the Power Management Standby state	Press any key on the keyboard or move the mouse to restore operation. Check the Power Management software on your computer	<b>Power Management</b> section on page 21

*i* For image problems, you may want to run **AUTO SETUP** again before consulting to this section. In most cases, **AUTO SETUP** can fix the problems. See **Auto Setup for the PC** on page 7 for details.

Problem	Possible Cause	Suggested Action	Reference
Screen is blank and power indicator is flashing green every 0.5 second	The monitor is not receiving a video signal	Check that the signal cable is firmly connected to the computer. Check that no pins are bent in the signal cable connector.	<b>Connecting your Monitor</b> section on page 4
	Display mode of the computer is outside the range of the monitor	Reconfigure the computer to use a supported display mode.	<b>Further Information</b> section on page 19
Screen is blank and power indicator is flashing amber every 0.5 or 1 second	The monitor is in the Power Management Suspend or Off state	Press any key on the keyboard or move the mouse to restore operation. Check the Power Management software on your computer.	<b>Power Management</b> section on page 21
Image appears to be smeared	There are noises in the video signal	Select IMAGE LOCK menu in the OSD. Then select MANUAL to adjust FINE/COARSE settings.	<b>User controls</b> section on page 14
Image appears to be discolored	The Color setting may be incorrect	Adjust the Color settings.	<b>User controls</b> section on page 14
A few dots are missing, discolored, or inappropriately lighted.	The LCD contains over 2,300,000 thin-film transistors (TFTs). A small number of missing, discolored, or lighted dots may be present on the screen, which is an intrinsic characteristic of the TFT LCD technology and is not an LCD defect.		

---

## Further Help

If you are unable to correct the problem yourself, you may seek further help as follows:

Call the IBM HELPCENTER.

In the US call 1-800-772-2227

In Canada call 1-800-565-3344

In other countries contact your dealer or retailer.

Before calling, please have available as much of the following information as possible:

1. Model and serial number from the label on your monitor.
2. Purchase receipt.
3. Description of problem.
4. Computer type and model.
5. System configuration (hardware fitted, etc.).
6. System BIOS version number.
7. Operating System and version number.
8. Display driver version number.
9. Video Adapter Type.

*i* If possible, stay by your computer. Your Technical Support Representative may wish to go through the problem with you during the call.

*i* More help, late-breaking news and details of the latest accessories for these products may be found on the worldwide web at:

<http://www.pc.ibm.com/us/accessories>

Information about the Video Electronics Standards Association can be found on the worldwide web at:

<http://www.vesa.org>

### Removing the stand and cables

Alternative stands for your IBM Flat Panel Monitor may be available from specialist suppliers.

This product is equipped with mounting facilities that conform to the VESA Flat Panel Monitor Physical Mounting Interface Standard (FPMPMI).

This product is shipped with the signal cable and the power cord attached to the monitor. If you want to use other cables for reasons such as having the monitor wall-mounted, follow the instructions below:

1. Disconnect the power cord from the wall outlet.

2. Carefully insert the head of a flathead (–) screwdriver into the slot visible along either side of the cable cover (a) and pry it off.

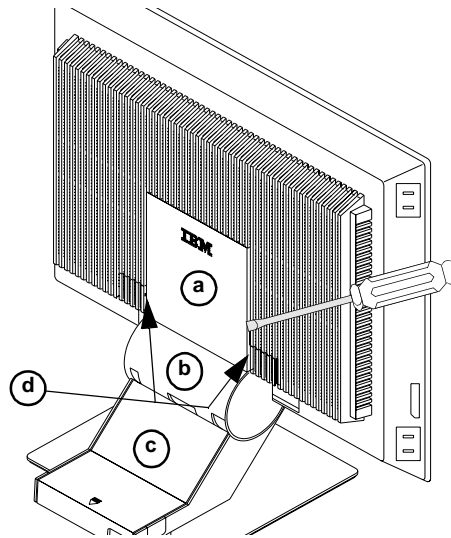

3. Squeeze the sides of the hinge cover (b) and pull it off.
4. Gently lift the stand cover (c) along the top and then slide it backwards and off the stand.
5. Remove the signal cable and the power cord from the monitor by disconnecting the corresponding adapters. Carefully cut the plastic tie to free the power cord and remove the screw holding the power cord clamp.
6. Lay the monitor facedown on a cushion and remove the six screws holding the hinge mechanism on the monitor. Lift off the hinge and base assembly.
7. Insert the head of a flathead (–) screwdriver in the slot of one of the two VESA caps (d) and pry the cap off. Repeat the procedure on the other VESA cap.
8. If you are installing an arm or wall-mounting device, follow the directions included with the device. If you are just changing your cables, continue with Step 9.
9. Connect the signal cable and the power cord, then refit the power cord clamp in its original screwpost.
10. Slide the stand cover back on the stand.



11. Put the hinge cover back on, making sure that the straight side is at the top.
12. Insert the three tabs at the top of the cable cover into the slots in the back of the monitor and push the cover into place.

To obtain the correct cables and/or to get further instructions on installing them, call the IBM HELPCENTER at the above numbers or contact your dealer, retailer, or other IBM authorized Servicer.

### **Installing a 13W3 Cable**

13W3 cables are most often used with workstations. To install a 13W3 cable follows steps 1 through 4 starting on page 24(Removing the stand and cables), then continue with the steps below:

5. Remove the D-SUB signal cable, if you will not be using it.
6. Connect the 13W3 signal cable to the 13W3 connector on the back of the monitor.
7. Slide the stand cover back on the stand.
8. Put the hinge cover back on, making sure that the straight side is at the top.
9. Insert the three tabs at the top of the cable cover into the slots in the back of the monitor and push the cover into place.

# Specifications

This color monitor (Type-model 9519-Axx) uses a 18.1-inch TFT LCD.

Dimensions	Width: Depth: Height:	462 mm 224 mm 459 mm
Weight	Unpackaged	19.8 lb. (9.0 Kg)
Tilt / Swivel	Tilt: Swivel:	- 4° / + 41° - 230° / + 90°
Image	Viewable Image Size: Maximum Height: Maximum Width: Pixel Pitch:	18.1" (459.7 mm) 287 mm 359 mm 0.281 mm (H) × 0.281 mm (V)
Power Input	Supply Voltage: Max Supply Current:	90 - 260 Vac 60/50 ± 3 Hz 1.5 A at 120 Vac
Power Consumption	Normal Operation: DPMS Stand-by: DPMS Suspend: DPMS off:	< 48 W < 5 W < 5 W < 5 W
Video Input	Input Signal: Horiz. Addressability: Vert. Addressability: Clock Frequency:	Analog Direct Drive 75 ohm 0.7 V 1280 pixels (max) 1024 lines (max) 135 MHz
Communications	VESA DDC:	2 B
Supported Display Modes	Standard modes: between Horiz. Frequency: Vert. Frequency:	IBM, VESA, HP, Sun, Mac 30 kHz - 82 kHz 56 Hz - 75 Hz See <b>Factory Set Display Modes</b> on page 20 See <b>Display Mode Ranges</b> on page 28
Environment	Temperature: Operating: Storage: Shipping: Humidity: Operating: Storage: Shipping:	10 to 35° C - 20 to 60° C - 20 to 60° C 10 to 80% 5 to 95% 5 to 95%

*i* Power consumption figures are for the monitor and the power supply combined.

## Display Mode Ranges

Addressability	Refresh Rate / Range (±1 Hz)	Horizontal Frequency / Range (±500 Hz)
640 x 350	70 Hz	31.5 kHz
640 x 480, VGA	60 / 59 - 61 Hz	31.5 / 30.5 - 35.0 kHz
640 x 460	66 Hz	35.0 kHz
640 x 480, VGA	72 / 71 - 73 Hz	37.9 / 36.5 - 39.9 kHz
640 x 480, VGA	75 / 74 - 76 Hz	37.5 / 36.8 - 43.0 kHz
720 x 400	70 Hz	31.5 kHz
800 x 600	56 Hz	35.2 kHz
800 x 600, SVGA	60 / 59 - 61 Hz	37.9 / 37.5 - 43.0 kHz
800 x 600, SVGA	72 / 71 - 73 Hz	48.1 / 45.2 - 51.0 kHz
800 x 600, SVGA	75 / 74 - 76 Hz	46.9 / 46.0 - 51.0 kHz
832 x 624	75 Hz	49.7 kHz
1024 x 768, XGA	60 / 59 - 61 Hz	48.4 / 47.8 - 53.0 kHz
1024 x 768, XGA	70 / 69 - 71 Hz	56.5 / 56.0 - 61.0 kHz
1024 x 768, XGA	75 / 74 - 76 Hz	60.0 / 59.5 - 61.0 kHz
1152 x 864, VESA	75 Hz	67.5 kHz
1152 x 870	75 Hz	68.7 kHz
1152 x 900, Sun	66 Hz	61.8 kHz
1280 x 1024, SXGA	60 / 59 - 61 Hz	64.0 / 61.5 - 66.0 kHz
1280 x 1024, HP	72 Hz	78.1 kHz
1280 x 1024, SXGA	75 / 74 - 76 Hz	80.0 / 78.0 - 82.0 kHz
1280 x 1024, Sun	76 Hz	81.1 kHz

# Compliances

## Federal Communications Commission (FCC) Statement

This equipment has been tested and found to comply with the limits for a Class B digital device, pursuant to Part 15 of the FCC Rules. These limits are designed to provide reasonable protection against harmful interference in a residential installation. This equipment generates, uses, and can radiate radio frequency energy and, if not installed and used in accordance with the instructions, may cause harmful interference to radio communications. However, there is no guarantee that interference will not occur in a particular installation. If this equipment does cause harmful interference to radio or television reception, which can be determined by turning the equipment off and on, the user is encouraged to try to correct the interference by one or more of the following measures:

- Reorient or relocate the receiving antenna.
- Increase the separation between the equipment and receiver.
- Connect the equipment into an outlet on a circuit different from that to which the receiver is connected.
- Consult an IBM authorized dealer or service representative for help.

Properly shielded and grounded cables and connectors must be used in order to meet FCC emission limits. Proper cables and connectors are available from IBM authorized dealers. IBM is not responsible for any radio or television interference caused by using other than recommended cables and connectors or by unauthorized changes or modifications to this equipment.

Unauthorized changes or modifications could void the user's authority to operate the equipment.

### Declaration of Conformity

<b>Trade Name:</b>	IBM Corporation
<b>Model No.:</b>	9519-AW*, 9519-AG*
<b>Responsible Party:</b>	Samsung Electronics Co., Ltd.
<b>Address:</b>	QA Lab of Samsung America 85 West Tasman Drive San Jose, CA 95134 USA
<b>Telephone:</b>	408-554-5124
<b>Fax:</b>	408-554-5191

This device complies with Part 15 of the FCC Rules. Operation is subject to the following two conditions: (1) this device may not cause harmful interference, and (2) this device must accept any interference received, including interference that may cause undesired operation.

## Power Cords

For your safety, IBM provides a power cord with a grounded attachment plug to use with this IBM product. To avoid electrical shock, always use the power cord and plug with a properly grounded power outlet.

IBM power cords used in the United States and Canada are listed by the Underwriters Laboratories (UL) and certified by the Canadian Standards Association (CSA).

For units intended to be operated at 115 volts: Use a UL listed and CSA certified cord set consisting of a minimum 18 AWG, type SVT or SJT, three conductor cord, a maximum of 4.5 meters (15 feet) in length and a parallel blade, grounding type attachment plug rated 15 amperes, 125 volts.

For units intended to be operated at 230 volts (U.S. use): Use a UL listed and CSA certified cord set consisting of a minimum 18 AWG, type SVT or SJT, three conductor cord, a maximum of 4.5 meters (15 feet) in length and a tandem blade, grounding type attachment plug rated 15 amperes 250 volts.

For units intended to be operated at 230 volts (outside the U.S.): Use a cord set with a grounding type attachment plug rated 13 amperes (minimum), 250 volts. The cord set should be marked <HAR> and have the appropriate safety approvals for the country in which the equipment will be installed.



As an ENERGY STAR® Partner, IBM Corporation has determined that this product meets the ENERGY STAR guidelines for energy efficiency.



This monitor complies with TCO'95 guidelines.

## MPRII

This product complies with Swedish National Council for Metrology (MPR) standards issued in December 1990 (MPRII) for very low frequency (VLF) and extremely low frequency (ELF).

## Hinweise

Gemäß der Amtsblätter des BMPT Nm. 61/1991 und 6/1992 wird der Betreiber darauf aufmerksam gemacht, daß die von ihm mit diesem Gerät zusammengestellte Anlage auch den technischen Bestimmungen dieser Amtsblätter genügen muß.

Aus ergonomischen Gründen wird empfohlen, die Grundfarbe Blau nicht auf dunklem Untergrund zu verwenden (schlechte Erkennbarkeit, Augenbelastung bei zu geringem Zeichenkontrast).

Aus ergonomischen Gründen sollten nur Darstellungen auf dunklem Hintergrund bei Vertikalfrequenzen ab 60 Hz (ohne Zeilensprung) benutzt werden.

Die Konvergenz des Bildes kann sich auf Grund des Magnetfeldes am Ort der Aufstellung aus der korrekten Grundeinstellung verändern. Zur Korrektur empfiehlt es sich deshalb, die Regler an der Frontseite für H STAT und V STAT so einzustellen, daß die getrennt sichtbaren Farblinien für Rot, Grün und Blau bei z.B. der Darstellung eines Buchstabens zur Deckung (Konvergenz) gelangen. Siehe hierzu auch die Erklärungen zu H STAT und V STAT.

## Industry Canada Compliance Statement

This Class B digital apparatus meets the requirements of the Canadian Interference-Causing Equipment Regulations.

Cet appareil numérique de la classe B respecte toutes les exigences du Règlement sur le matériel brouilleur du Canada.

## NOM

IBM de México, S.A.  
IBM 9513-Axx TFT LCD Color Monitor  
Planta de Manufactura  
416, Maetan-3Dong, Paldal-Gu  
Suwon City, Kyungki-Do, Korea  
442-742  
Hecho en Korea  
**NOM** - 018  
Consumo de Corriente 1.5 A  
Frecuencia de Operacion 50/60 Hz  
Rension de Alimentacion 100-240 V

## European Union (EU) Statement

This product has been tested and found to comply with the limits for Class B Information Technology Equipment according to CISPR 22 / European Standard EN 55022. The limits for Class B equipment were derived for typical residential environments to provide reasonable protection against interference with licensed communication devices.

Properly shielded and grounded cables and connectors must be used in order to reduce the potential for causing interference to radio and TV communications and to other electrical or electronic equipment. Such cables and connectors are available from IBM authorised dealers.

In accordance with EN 50082-1 1992, Performance Criterion A.; it should be noted that in the presence of certain electromagnetic fields, some screen jitter may be observed.

# Warranty

---

For European warranty terms and conditions, refer to the enclosed IBM Warranty statement, Part Number 72H9623.

## Statement of Limited Warranty

The warranties provided by IBM in this Statement of Limited Warranty apply only to Machines you originally purchase for your use, and not for resale, from IBM or your reseller. The term "Machine" means an IBM machine, its features, conversions, upgrades, elements, or accessories, or any combination of them. Unless IBM specifies otherwise, the following warranties apply only in the country where you acquire the Machine. If you have any questions, contact IBM or your reseller.

<b>Machine:</b>	IBM 9519 LCD Color Monitors
<b>Warranty Period*:</b>	3 years, including backlight
	• Contact your place of purchase for warranty service information

## Production Status

Each Machine is manufactured from new parts, or new and serviceable used parts (which perform like new parts). In some cases, the Machine may not be new and may have been previously installed. Regardless of the Machine's production status, IBM's warranty terms apply.

## The IBM Warranty

IBM warrants that each Machine 1) is free from defects in materials and workmanship and 2) conforms to IBM's Official Published Specifications. The warranty period for a Machine is a specified, fixed period commencing on its Date of Installation. The date on your receipt is the Date of Installation, unless IBM or your reseller informs you otherwise.

During the warranty period IBM or your reseller, if authorized by IBM, will provide warranty service under the type of service designated for the Machine and will manage and install engineering changes that apply to the Machine.

For IBM or your reseller to provide warranty service for a feature, conversion, or upgrade, IBM or your reseller may require that the Machine on which it is installed be 1) for certain Machines, the designated, serial-numbered Machine and 2) at an engineering-change level compatible with the feature, conversion, or upgrade. Many of these transactions involve the removal of parts and their return to IBM. You represent that all removed parts are genuine and unaltered. A part that replaces a removed part will assume the warranty service status of the replaced part.

If a Machine does not function as warranted during the warranty period, IBM or your reseller will repair it or replace it with one that is at least functionally equivalent, without charge. The replacement may not be new, but will be in good working order. If IBM or your reseller is unable to repair or replace the Machine, you may return it to your place of purchase and your money will be refunded.

If you transfer a Machine to another user, warranty service is available to that user for the remainder of the warranty period. You should give your proof of purchase and this Statement to that user. However, for Machines which have a life-time warranty, this warranty is not transferable.

## Warranty Service

To obtain warranty service for the Machine, you should contact your reseller or call IBM. In the United States, call IBM at 1-800-772-2227. In Canada, call IBM at 1-800-565-3344. You may be required to present proof of purchase.

IBM or your reseller will provide certain types of repair and exchange service, either at your location or at IBM's or your reseller's service center, to restore a Machine to good working order.

When a type of service involves the exchange of a Machine or part, the item IBM or your reseller replaces becomes its property and the replacement becomes yours. You represent that all removed items are genuine and unaltered. The replacement may not be new, but will be in good working order and at least functionally equivalent to the item replaced. The replacement assumes the warranty service status of the replaced item. Before IBM or your reseller exchanges a Machine or part, you agree to remove all features, parts, options, alterations, and attachments not under warranty service. You also agree to ensure that the Machine is free of any legal obligations or restrictions that prevent its exchange.

You agree to:

- obtain authorization from the owner to have IBM or your reseller service a Machine that you do not own; and where applicable, before service is provided :
- follow the problem determination, problem analysis, and service request procedures that IBM or your reseller provide,
- secure all programs, data, and funds contained in a Machine, and
- inform IBM or your reseller of changes in a Machine's location.

IBM is responsible for loss of, or damage to, your Machine while it is 1) in IBM's possession or 2) in transit in those cases where IBM is responsible for the transportation charges.

## Extent of Warranty

IBM does not warrant uninterrupted or error-free operation of a Machine.

Misuse, accident, modification, unsuitable physical or operating environment, improper maintenance by you, or failure caused by a product for which IBM is not responsible may void the warranties.

THESE WARRANTIES REPLACE ALL OTHER WARRANTIES, EXPRESS OR IMPLIED, INCLUDING, BUT NOT LIMITED TO, THE IMPLIED WARRANTIES OF MERCHANTABILITY AND FITNESS FOR A PARTICULAR PURPOSE. HOWEVER, SOME LAWS DO NOT ALLOW THE EXCLUSION OF IMPLIED WARRANTIES. IF THESE LAWS APPLY, THEN ALL EXPRESS AND IMPLIED WARRANTIES ARE LIMITED IN DURATION TO THE WARRANTY PERIOD. NO WARRANTIES APPLY AFTER THAT PERIOD.

In Canada, warranties include both warranties and conditions.

Some jurisdictions do not allow limitations on how long an implied warranty lasts, so the above limitation may not apply to you.



For European warranty terms and conditions refer to enclosed IBM warranty statement Part Number 72H9623.

Référez-vous à la garantie IBM N° de référence 72H9623 pour les conditions de garantie européennes.

Die europäischen Garantiebedingungen finden Sie in der beigefügten IBM-Gewährleistungserklärung, Teilenummer 72H9623.

Los términos y condiciones de las garantías en Europa se recogen en la declaración de garantía adjunta del número de pieza IBM 72H9623.

Per le condizioni e i termini de garanzia relativi ai paesi europei, consultare l'apposita dichiarazione IBM (numero di matricola 72H9623).

### ***Service Information***

The following parts are for use by IBM service, or IBM authorised dealers, to support the customer warranty. Parts are for service use only.

#### **T85A Model Type 9519**

21L4364	9519-AW1	Monitor - Pearl White
21L4365	9519-AG1	Monitor - Stealth Black
21L4403		Power Supply
21L4505		Video I/F Cable (White)
21L4507		Video I/F Cable (Black)

## Free Manuals Download Website

<http://myh66.com>

<http://usermanuals.us>

<http://www.somanuals.com>

<http://www.4manuals.cc>

<http://www.manual-lib.com>

<http://www.404manual.com>

<http://www.luxmanual.com>

<http://aubethermostatmanual.com>

Golf course search by state

<http://golfingnear.com>

Email search by domain

<http://emailbydomain.com>

Auto manuals search

<http://auto.somanuals.com>

TV manuals search

<http://tv.somanuals.com>