

# English

---

## First Edition (Mar/2001)

This publication could contain technical inaccuracies or typographical errors. Changes are made periodically to the information herein; these changes will be made in later editions. IBM may make improvements and/or changes in the product(s) and/or program(s) at any time.

It is possible that this publication may contain reference to, or information about, IBM products (machines and programs), programming, or services that are not announced in your country.

Requests for copies of this publication and for technical information about IBM products should be made to your IBM Authorized Dealer or IBM Retailer.

No part of this publication may be reproduced or distributed in any form or by any means without prior permission in writing from the International Business Machines Corporation.

© Copyright International Business Machines Corporation 2000. All rights reserved.

---

## Notices

References in this publication to IBM products, programs, or services do not imply that IBM intends to make these available in all countries in which IBM operates. Any reference to an IBM product, program or service is not intended to state or imply that only IBM's product, program, or service may be used. Any functionally equivalent product, program, or service that does not infringe any of IBM's intellectual property rights or other legally protectable rights may be used instead of the IBM product, program, or service. Evaluation and verification of operation in conjunction with other products, programs, or services, except those expressly designated by IBM, are the user's responsibility.

IBM may have patents or pending patent applications covering subject matter in this document. The furnishing of this document does not give you any license to these patents.

---

## Trademarks

The following terms, used in this publication, are trademarks or service marks of the IBM Corporation in the United States or other countries:

**IBMHelpCenter**

ENERGY STAR is a U.S. registered mark.

# Contents

ENGLISH

<b>Setup</b> .....	<b>2</b>
Hardware Requirements .....	2
Handling Instructions .....	2
Workplace Preparation .....	2
Adjusting the Monitor Position .....	3
Working Practices .....	3
Connecting your Monitor .....	5
Switching on your Monitor .....	5
<b>Configuring your Monitor</b> .....	<b>6</b>
Setup Diskette for Windows 95, Windows 98 .....	6
Setup Diskette for Windows 2000 .....	7
<b>Auto Setup</b> .....	<b>8</b>
Auto Setup for DOS .....	9
Auto Setup for Windows 3.1, Windows 95, Windows 98, Windows NT, or Windows 2000 .....	10
<b>Manual Setup</b> .....	<b>12</b>
<b>Adjusting Your LCD Monitor</b> .....	<b>13</b>
User controls .....	13
On-screen display (OSD) controls .....	15
<b>Further Information</b> .....	<b>18</b>
Display modes .....	19
Power Management .....	19
Product Disposal .....	19
<b>Troubleshooting</b> .....	<b>20</b>
Further Help .....	22
<b>Specifications</b> .....	<b>25</b>
<b>Warranty Statements</b> .....	<b>26</b>

## Appendices (Compliances and Warranty)

# Setup

## Hardware Requirements

This monitor requires a computer with a suitable on-board sub-system or Video Adapter card that can support XGA 1024 x 768, SVGA 800 x 600, or VGA 640 x 480 at 60 Hz.

## Handling Instructions

*Do not support the monitor within the screen area. The Liquid Crystal Display is glass and can be damaged by rough handling or excessive pressure.*

1. Lift the monitor by placing your hands where indicated below.

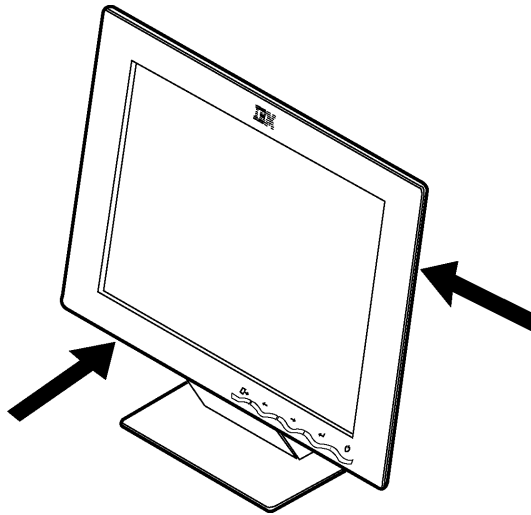

2. Before using your monitor for the first time, remove the clear protective film from the front of the screen.

## Workplace Preparation

***i** This section gives advice on what you should consider before you set up your monitor.*

### Height

The monitor should be positioned so that the top of the screen is slightly below your eye level when you sit at your workstation.

### Orientation

Choose a position that gives the least reflection from lights and windows, usually at a right angle to any windows. The monitor should be positioned directly in front of you so that you do not have to twist your body to use it. Tilt the monitor to a comfortable viewing angle.

## Adjusting the Monitor Position

### Viewing Angle

You can tilt the screen backward and forward as shown below.

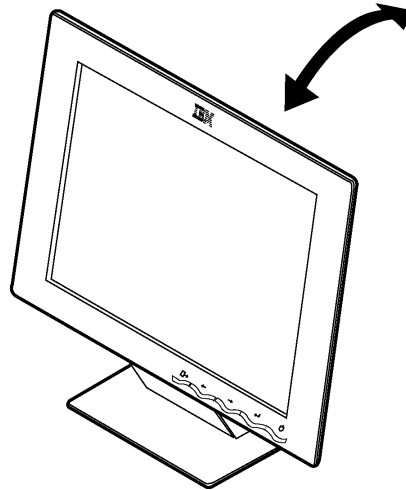

## Working Practices

***i** This section gives advice on how you can work comfortably and reduce fatigue.*

### Rest

Take regular breaks. Vary your posture, stand up and stretch occasionally as prolonged use of computer workstations can be tiring.

### Back

You should sit back in your chair and use the backrest.

### Hands

Adjust the seat height so that your forearms are approximately horizontal and your wrists are straight when using the keyboard. Your upper arms should be relaxed with your elbows near your body.

Use a light touch on the keyboard, keeping your hands and fingers relaxed. Allow a space in front of the keyboard to rest your wrists when not typing. Consider using a wristpad.

## Eyesight

Working with monitors, in common with any prolonged close work, can be visually demanding. Look away from the screen periodically and have your eyesight checked regularly.

## Screen settings

Set the screen brightness and contrast to a comfortable level. You may have to adjust this as the lighting changes during the day. Many application programs let you select color combinations which can help you to view in comfort. See the **User controls** section on page 13 for more information.

## Connecting your Monitor

*Be sure to read the 'Safety Information' at the front of this User Guide before carrying out this procedure.*

1. Turn off your PC and all attached devices.
2. Connect the signal cable to the video port on the back of your computer. This port might be directly attached to your computer (figure A), or it might be part of a video adapter card (figure B). The video port on your computer or video adapter card may be colored blue to match the blue connector on your monitor's video cable.

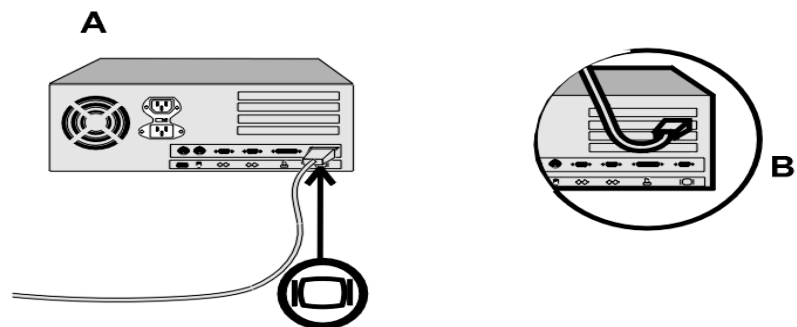

***i** The AC adapter and signal cable are connected to your monitor. If you wish to change these or to fit a different stand, see **Further Help** on page 22.*

3. Connect the power cord to the power adapter first, then insert the plug into a properly grounded electrical outlet.

## Switching on your Monitor

1. Switch on the power source and your computer.
2. Switch on your monitor by pushing and releasing the power switch marked . To switch off your monitor, push and release the power switch again.
3. Turn on the monitor and then the computer.
4. Run AUTO SETUP by following the instructions in the **Configuring your Monitor** section on page 6.

# Configuring your Monitor

## Setup Diskette for Windows95 or Windows 98

*This section must be completed before continuing with the Windows 95 or Windows 98 Auto Setup on Page 10.*

*On LCD monitors, unlike CRTs, a faster refresh rate does not improve display quality. IBM recommends using 1024 x 768 at a refresh rate of 60Hz.*

To use the Plug and Play feature in Windows 95 or Windows 98, files should be loaded from the **IBM Flat Panel Monitor Installation diskette**:

1. Turn off the computer and all attached devices.
2. Ensure that the monitor is connected correctly.
3. Turn on the monitor and then the system unit. Allow the system to boot into Windows 95 or Windows 98.  
Your computer's Plug and Play code may warn you that your system hardware has changed. This probably means that it has detected your new monitor for the first time.
4. Open the DISPLAY PROPERTIES window by clicking on START, SETTINGS, CONTROL PANEL and then double clicking on the DISPLAY icon.
5. Select the SETTINGS tab.
  - **In case of Windows 95:**
6.
  - 1. Select the Change Display Type button.
  2. Select the Change Monitor Type button.
  - **In case of Windows 98:**
6.
  - 1. Select the ADVANCED BUTTON.
  2. Select the MONITOR tab.
  3. Open the UPGRADE DEVICE WIZARD windows by clicking on Change button and then select the NEXT button.  
If the UPGRADE DEVICE WIZARD is open go step 6-3. if not continue to step 4.
  4. Select the "Display a list of the known drivers for this device so that I can choose a specific driver" and then select the NEXT button.
7. Insert the Setup diskette into drive A: and select the HAVE DISK button.
8. Select OK.
9. Choose IBM T540 monitor and select OK. The files will be copied from the diskette to your hard drive.
10. Close all open windows and remove the diskette.
11. Reboot the system.  
The system will automatically select the maximum refresh rate and corresponding Color Matching Profiles.



## Setup Diskette for Windows 2000

***This section must be completed before continuing with the Windows 2000 configuring for your monitor on page 10.***

***i*** *On LCD monitors, unlike CRTs, a faster refresh rate does not improve display quality. IBM recommends using 1024 x 768 at a refresh rate of 60Hz.*

To use the Plug and Play feature in Windows 2000, files should be loaded from the **IBM Flat Panel Monitor Installation diskette**.

1. Turn off the computer and all attached devices.
2. Ensure that the monitor is connected correctly.
3. Turn on the monitor and then the system unit. Allow the system to boot into Windows 2000.
4. Open the DISPLAY PROPERTIES window by clicking on START, SETTINGS, CONTROL PANEL and then double clicking on the DISPLAY icon.
5. Select the SETTINGS tab.
6. Select the ADVANCED button.
7. Select the MONITOR tab.
8. Select the PROPERTIFS button.
9. Select the Driver tab.
10. Open the Upgrade Device Driver Wizard window by clicking on UPDATE DRIVER and then select the NEXT button.
11. select the "Display a list of the known dirvers for this device so that I can choose a specifc driver" and then sefect the NEXT button.
12. Inset the Setup diskette into drive A: and select the HAVE DISK button.
13. select OK.
14. Choose IBM T540 monitor and select OK. The files will be copied from the diskette to your hard drive.
15. Close all open windows and remove the diskette.
16. Reboot the system.  
The system will automatically select the maximum refresh rate and corresponding Color Matching Profiles.

# Auto Setup

## Auto Setup

*i* Before carrying out this section, it is very important that The Setup Diskette for Windows 95 or Windows 98 has been run. (see page 6)

*i* The Setup Utility included on the setup diskette is for displaying do patterns. They do not replace or modify the display driver.

The Auto Setup instructions require the monitor to be warmed up for 15 minutes. This is not required for normal operation.

By pressing the ← and → keys *i* simultaneously allows direct access to the auto set-up controls.

*i* If your PC does not run with the setup diskettes shipped with the monitor, refer to Manual Setup on page 12

*i* The AUTO SETUP process only applies to the current screen mode. When a new mode is selected, repeat this section to reset the monitor

When you first use your monitor you must perform Auto Setup. This procedure sets up your monitor to process the video signals from your computer without image discoloration or smearing. After you perform Auto Setup, the settings are stored and used each time you turn on the monitor.

In order to optimise the displayed image a set-up utility is provided on the IBM Monitor Installation Diskette. Operation of the utility is dependent on the operating system on your PC. For correct operation locate the operating system on your PC from the table below and follow the appropriate instructions. You may choose to run AUTO SETUP for each operating system that you use. This means that if you sometimes use your monitor while running any version of Windows and sometimes also use it from within DOS (not a DOS window), you must run AUTO SETUP for both Windows and DOS. You may run versions of AUTO SETUP in any order.

Operating System	Corresponding Auto Setup procedure
DOS	<b>Auto Setup for DOS on page 9</b>
Windows 3.1	<b>Auto Setup for Windows 3.1, Windows 95, Windows 98, Windows 2000 or Windows NT on page 10</b>
Windows 95	
Windows 98	
Window 2000	
Window NT	

Before you begin AUTO SETUP for your PC:

1. Make a backup copy of the setup diskettes supplied with the monitor.
2. Make sure the PC's video mode is set in the range of the supported screen resolution shown in the table on page 18.

You should perform AUTO SETUP for each screen mode you use.

## Auto Setup for DOS









*i* If the monitor is in standby mode (STANDBY ON), it may automatically turn off while you are waiting for it to warm up. If this happens, switch off the monitor and switch it on again after a few seconds.

*i* If you are using PC-DOS/V, change to U.S. mode by typing 'CHEV US' and pressing ENTER at the command prompt.

**You must use DOS when you run DOS Auto Setup.**

*i* The size and diversity of the dot pattern varies with the screen resolution.

*i* If the screen flickers, repeat the setup several times until the flicker is minimised, or adjust it manually by following **Manual Setup** on page 12.

1. Turn on the monitor first; then the PC.  
If the message CHECK SIGNAL CABLE is displayed, or if nothing is displayed check:
  - that the video interface cable is connected properly.
  - the correct video adapter card is installed.
  - the correct supported display mode is selected for your PC.
2. Wait approximately 15 minutes, until the monitor warms up.
3. Insert the diskette labelled 'IBM Flat Panel Monitor Installation Diskette' into the diskette drive.
4. Display the command prompt screen of the DOS full-screen display.
5. At the command prompt, type 'A:' and press ENTER.
6. Type 'TESTPATD' and press ENTER.
7. Select from the screen the number for the color or text mode you want to setup.
8. Select from the screen the number for the video mode you want to setup.  
You may repeat this process for as many of the color and video modes as you need.
9. When the dot pattern appears, press the OSD Enter button  at the bottom of the monitor to display the initial OSD menu.
10. Use an Arrow button (  or  ) to select the IMAGE LOCK icon  then press the OSD Enter  button to access the function.
11. Using an Arrow button (  or  ), select AUTOMATIC and press the OSD Enter button . This activates the AUTO SETUP procedure, which will optimize the display settings with the provided dot-patterns.  
The screen will3d off several times and you may notice small changes to the test pattern.
12. When finished, the OSD main menu returns. Press the Exit button  to exit from the OSD.
13. Press the ESCAPE key to exit the test pattern program.
14. Type 'Exit' at the command prompt to return to Windows.

If you use other operating systems, perform the appropriate AUTO SETUP for those systems, also: see

**Auto Setup for Windows 3.1, Windows 95, Windows 98, Windows NT or Windows 2000 on page 10.**

## Auto Setup for Windows 3.1, Windows 95, Windows 98, Windows NT or Windows 2000









***i** If the monitor is in standby mode (STANDBY ON), it may automatically turn off while you are waiting for it to warm up.*

***i** The size and diversity of the dot pattern varies with the screen resolution.*

***i** Position the mouse pointer at the bottom center of the screen. This allows AUTO SETUP to run properly*

1. Turn on the monitor first; then the PC.  
If the message CHECK SIGNAL CABLE is displayed, or if nothing is displayed check:
  - that the video interface cable is connected properly.
  - the correct video adapter card is installed.
  - the correct supported display mode is selected for your PC.
2. Wait approximately 15 minutes, until the monitor warms up.
3. Drag the icon bar and tool bar, if they are displayed, to the bottom of the screen.
4. Insert the diskette labelled 'IBM Flat Panel Monitor Installation Disk' into the diskette drive.
5. Check the operating system installed on your PC and follow the instructions from the table below.

Operating System	Step1	Step2	Step3	Step4
Windows 3.1	Open PROGRAM MANGER	Select FILE	Select RUN	Type 'A:\TESTPAT' and press ENTER
Windows NT 3.5				
Windows 95	Select START	Select RUN		
Windows 98				
Windows NT 4.0				













6. When the test pattern appears, press the OSD Enter button  at the bottom of the monitor to display the initial OSD menu.
7. Use an Arrow button (  or  ) to select the IMAGE LOCK icon  and press the OSD Enter button  to access the function.
8. Using an Arrow button (  or  ), select AUTOMATIC and press the OSD Enter button . This activates the AUTO SETUP procedure, which will optimize the display settings with the provided test pattern.  
The screen will dim, blink on and off several times, and you may notice small changes to the test pattern.  
To abort the AUTO SETUP function, press the Esc key.
9. When finished, the OSD main menu returns. Press the Exit button  once to exit from the OSD.
10. Press the Esc key to return to Windows.

You have completed the monitor setup for Windows. If you use other operating systems, perform the appropriate AUTO SETUP for those systems, also: see **Auto Setup for DOS** on page 9.

# Manual Setup

***i** If the monitor is in standby mode (STANDBY ON), it might automatically turn off while you are waiting for it to warm up.*

Normally, you can complete the setup procedure using AUTO SETUP, however, if your screen image is still distorted after you perform AUTO SETUP or the setup diskette does not run on your system, perform MANUAL SETUP.

1. Have your monitor turned on for about 15 minutes, until the monitor warms up.
2. Display the image you most frequently use on the screen.
3. Press the OSD Enter button  at the bottom of the monitor to display the initial OSD menu.
4. Use an Arrow button (  or  ) to select the IMAGE LOCK icon  and press the OSD Enter button  to access the function.
5. Using an Arrow button (  or  ), select MANUAL, press  and then press  once to select COARSE. Left and right arrow adjustment indicators become illuminated (see page 16).
6. Use the Arrow buttons to manually adjust to correct (as much as possible) for noise in the video signal then press  to save the changes.
7. Use an Arrow button to select FINE and press the  button.
8. Use the Arrow buttons again to tune the image to your liking.
9. When finished, press the Exit button  four times to exit from the OSD.

You have completed the monitor setup.

# Adjusting Your LCD Monitor

## User controls



### User control features

Icon	Control	Description
	<b>Exit</b>	Displays the OSD main menu Exits from menus and sub-menus Exits the OSD
	<b>Left Arrow</b>	Displays the OSD main menu Moves the cursor to highlight icons and other options
	<b>Right Arrow</b>	Displays the OSD main menu Moves the cursor to highlight icons and other options
	<b>OSD Enter</b>	Displays the OSD main menu Enters menus and sub-menus and selects the highlighted option
	<b>Power Switch</b>	Switches the monitor on and off

### Operation

*i* The image is already optimized for many display modes, however the user controls can be used to adjust the image to your liking.

- Press any of the OSD control buttons to display the main OSD menu.
- Use the Arrow buttons to move among the icons. Select an icon and press OSD Enter to access that function. If there is a sub-menu, you can move between options using the Arrow buttons, then press OSD Enter to select that function. Use the Arrow buttons to make adjustments.

***i** The settings are saved after adjustment and when exiting the OSD and will be effective thereafter.*

- Press the Exit button to move backwards through the sub-menus and exit from the OSD.

**Note:** After making adjustments, the Power indicator LED will briefly turn amber to indicate that the new value has been saved.

### **OSD Lock / Unlock**

This feature allows you to secure the current control settings, while allowing the user to adjust Brightness and Contrast, so that they cannot be inadvertently changed. You can unlock the OSD controls at any time by using the same procedure.

Push and hold the OSD Enter button for 10 seconds to Lock or to Unlock. When locked, a "LOCKED" message will be displayed.



## On-screen display (OSD) controls

The settings adjustable with the user controls are viewed through the On-Screen Display (OSD). Press any of the OSD buttons to activate the OSD.





*i* The LCD monitor needs time to become thermally stable the first time you turn it on each day. Thus, to achieve more accurate adjustments for parameters, allow the LCD monitor to warm up (be On) for at least 15 minutes before making any screen adjustments.





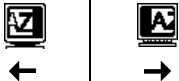
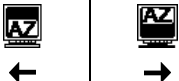

### Initial appearance of OSD



### OSD functions

OSD Icon	Description	Sub-menu(s)	Controls and Adjustments	
 <b>BRIGHTNESS</b>	Adjusts brightness			
 <b>CONTRAST</b>	Adjusts contrast			
 <b>IMAGE LOCK</b>	The image lock function is used to adjust the level of noise in the video signal which causes horizontal lines or areas on the screen where the image appears to be unstable and jitters or shimmers. This can be done automatically or manually.	<b>Automatic</b>	Automatic adjustment	

OSD Icon	Description	Sub-menu(s)	Controls and Adjustments
 <p><b>IMAGE LOCK</b> (continued)</p>		<p><b>Manual -</b></p> <ul style="list-style-type: none"> <li>• <b>Fine</b></li> <li>• <b>Coarse</b></li> </ul>	<p>Use the Arrow buttons to adjust away the interference. If satisfactory results are not obtained using the Fine adjustment, use the Coarse adjustment and then use Fine again. This function may change the width of the display image. Use the H-Position function on the Image Position menu to center the display image on the screen.</p>
 <p><b>IMAGE POSITION</b></p>	<p>Moves the screen left and right or up and down.</p>	<p><b>H-Position</b></p>	
		<p><b>V-Position</b></p>	
 <p><b>COLOR</b></p>	<p>Select the Color Mode you find most comfortable and then fine tune the colors using the User Color Mode menu, if necessary.</p>	<p><b>Color Mode</b></p>	<p><b>Mode 1</b> (Cool White)</p> <p><b>Mode 2</b> (Normal White)</p> <p><b>Mode 3</b> (Warm White)</p>
		<p><b>User Mode -</b></p> <ul style="list-style-type: none"> <li>• Red</li> </ul>	<p>Increases or decreases redness</p>
		<ul style="list-style-type: none"> <li>• Green</li> </ul>	<p>Increases or decreases greenness</p>
		<ul style="list-style-type: none"> <li>• Blue</li> </ul>	<p>Increases or decreases blueness</p>

OSD Icon	Description	Sub-menu(s)	Controls and Adjustments
 <b>RESET</b>	Resets the Brightness, Contrast and Color settings.	<b>Color Reset</b>	<b>NO</b> - Does not make the adjustment  <b>YES</b> - Resets the color
	Resets the Image position settings	<b>Geometry Reset</b>	<b>NO</b> - Does not make the adjustment  <b>YES</b> - Resets the geometry
 <b>INFORMATION</b>	Shows information about the addressability and the horizontal and vertical frequencies of the images received from the computer or video board.		
 <b>LANGUAGE</b>	The language chosen affects only the language of the OSD. It has no effect on any software running on the computer.		Select one of the five languages to use for the OSD.
 <b>OSD MENU POSITION</b>	Changes the position of the OSD on the screen.	<b>H-Position</b>	
		<b>V-Position</b>	

# Further Information

## Display modes

The display mode the monitor uses is controlled by the computer. Therefore, you should refer to your computer documentation for details on how to change display modes.

The image size, position and shape may change when the display mode changes. This is normal and the image can be readjusted using AUTO SETUP and the monitor controls.

Unlike CRT monitors, which require a high refresh rate to minimize flicker, TFT technology is inherently flicker-free. If possible, configure your computer for 1024 × 768 addressability at 60Hz vertical refresh rate.

For the display modes listed below, the screen image has been optimized during manufacture.

### Factory Set Display Modes

Addressability	Refresh Rate	Horizontal Frequency
640 × 350	70 Hz	31.5 kHz
640 × 480	60 Hz	31.5 kHz
640 × 480	72 Hz	37.9 kHz
640 × 480	75 Hz	37.5 kHz
720 × 400	70 Hz	31.5 kHz
800 × 600	75 Hz	46.9 kHz
800 × 600	72 Hz	48.1 kHz
800 × 600	60 Hz	37.9 kHz
800 × 600	56 Hz	35.2 kHz
832 × 624	75 Hz	49.7 kHz
1024 × 768†	60 Hz	48.4 kHz
1024 × 768	70 Hz	56.5 kHz
1024 × 768	75 Hz	60.0 kHz

† Recommended

**'Note: VESA timings are as detailed in the VESA "Display Monitor Timing Specification". Version 1.0, Revision 0.8, dated 09/17/98.'**

## Power Management

***i** If your computer has previously been used with a CRT monitor and is currently configured to a display mode outside the range that the Flat Panel monitor can display, you may need to re-attach the CRT monitor temporarily until you have re-configured the computer, preferably to 1024 x 768 at 60Hz.*

To benefit from power management, the monitor must be used in conjunction with a computer that implements the Video Electronics Standards Association (VESA) Display Power Management Signalling (DPMS) Standard.

The power management feature is invoked when the computer recognizes that you have not used your mouse or keyboard for a user-definable period. There are several states as described in the table below.

As an ENERGY STAR® Partner, IBM has determined that this product meets the ENERGY STAR® guidelines for energy efficiency.

IBM recommends that you switch off your monitor at the end of each working day, or whenever you expect to leave it unused for long periods during the day.

State	Power Indicator	Screen	Restoring Operation	Compliance
<b>On</b>	Steady green	Normal		
<b>DPMS Standby</b>	Steady amber	Blank	Press a key or move the mouse.	ENERGY STAR® and NUTEK
<b>DPMS Suspend</b>	Flashing amber (0.5 sec. interval)	Blank	Press a key or move the mouse. ‡	ENERGY STAR® and NUTEK
<b>DPMS Off</b>	Flashing amber (1 sec. interval)	Blank	Press a key or move the mouse. ‡	ENERGY STAR® and NUTEK

‡ There may be a slight delay before the picture reappears.

## Product Disposal

The fluorescent lamp in the liquid crystal display contains mercury. Dispose of it as required by local ordinances and regulations.

# Troubleshooting

If you have a problem setting up or using your monitor, you may be able to solve it yourself. Before calling your retailer or IBM, try the suggested actions that are appropriate to your problem.

Problem	Possible Cause	Suggested Action	Reference
Screen is blank and power indicator is off	No power to monitor	<ul style="list-style-type: none"> <li>◆ Ensure that the electrical outlet and the monitor are both switched on.</li> <li>◆ Check that the power cord is firmly plugged into the electrical outlet and the power supply unit.</li> <li>◆ If the power cord plug has a removable fuse, replace it.</li> <li>◆ Try another power cord.</li> <li>◆ Try another electrical outlet.</li> </ul>	<b>Connecting your Monitor</b> section on page 5
Screen is blank and power indicator is steady green	Brightness and Contrast may be too low	<ul style="list-style-type: none"> <li>◆ Adjust brightness and contrast.</li> </ul>	<b>User controls</b> section on page 13
Screen is blank and power indicator is steady amber	The monitor is in the Power Management Standby state	<ul style="list-style-type: none"> <li>◆ Press any key on the keyboard or move the mouse to restore operation.</li> <li>◆ Check the Power Management software on your computer</li> </ul>	<b>Power Management</b> section on page 19

Problem	Possible Cause	Suggested Action	Reference
Screen is blank and power indicator is Flashing green every 0.5 second	The monitor is not receiving a video signal	<ul style="list-style-type: none"> <li>◆ Check that the signal cable is firmly connected to the computer.</li> <li>◆ Check that no pins are bent in the signal cable connector.</li> </ul>	<b>Connecting your Monitor</b> section on page 5
	Display mode of the computer is outside the range of the monitor	<ul style="list-style-type: none"> <li>◆ Reconfigure the computer to use a supported display mode.</li> </ul>	<b>Further Information</b> section on page 18
Screen is blank and power indicator is flashing amber every 0.5 or 1 second	The monitor is in the Power Management Suspend or Off state	<ul style="list-style-type: none"> <li>◆ Press any key on the keyboard or move the mouse to restore operation.</li> <li>◆ Check the Power Management software on your computer.</li> </ul>	<b>Power Management</b> section on page 19
Image appears to be smeared	There are noises in the video signal	<ul style="list-style-type: none"> <li>◆ Select IMAGE LOCK menu in the OSD. Then select MANUAL to adjust FINE/COARSE settings.</li> </ul>	<b>User controls</b> section on page 13
Image appears to be discolored	The Color setting may be incorrect	<ul style="list-style-type: none"> <li>◆ Adjust the Color settings.</li> </ul>	<b>User controls</b> section on page 13
A few dots are missing, discolored, or inappropriately lighted.	<ul style="list-style-type: none"> <li>◆ The LCD contains over 2,300,000 thin-film transistors (TFTs). A small number of missing, discolored, or lighted dots may be present on the screen, which is an intrinsic characteristic of the TFT LCD technology and is not an LCD defect.</li> </ul>		

**i** For image problems, you may want to run **AUTO Setup** again before consulting to this section. In most cases, **AUTO SETUP** can fix the problems. See **Auto Setup** on page 8 for details.

## Further Help

If you are unable to correct the problem yourself, you may seek further help as follows:

Call the IBM HELPCENTER.

In the US call 1-800-772-2227

In Canada call 1-800-565-3344

In other countries contact your dealer, retailer, or other IBM authorized Servicer.

***i** If possible, stay by your computer. Your Technical Support Representative may wish to go through the problem with you during the call.*

Before calling, please have available as much of the following information as possible:

1. Model and serial number from the label on your monitor.
2. Purchase receipt.
3. Description of problem.
4. Computer type and model.
5. System configuration (hardware fitted, etc.).
6. System BIOS version number.
7. Operating System and version number.
8. Display driver version number.
9. Video Adapter Type.

### Removing the stand and cables

Alternative stands for your IBM Flat Panel Monitor may be available from specialist suppliers.

This product is equipped with mounting facilities that conform to the VESA Flat Panel Monitor Physical Mounting Interface Standard (FPMPMI).

This product is shipped with the signal cable and the power cord attached to the monitor. If you want to use other cables for reasons such as having the monitor wall-mounted, follow the instructions below:

1. Disconnect the power cord from the wall outlet.

***i** More help, late-breaking news and details of the latest accessories for these products may be found on the worldwide web at:*

*<http://www.pc.ibm.com/us/accessories>*

*Information about the Video Electronics Standards Association can be found on the worldwide web at:*

*<http://www.vesa.org>*



2. Carefully insert the head of a flathead (–) screwdriver into the slot visible along either side of the cable cover (a) and pry it off.

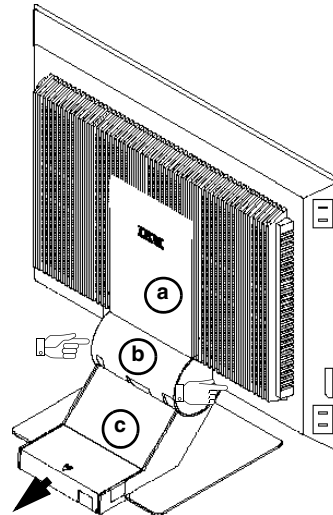

3. Squeeze the sides of the hinge cover (b) and pull it off.
4. Gently lift the stand cover (c) along the top and then slide it backwards and off the stand.
5. Remove the signal cable and the power cord from the monitor by disconnecting the corresponding adapters. Carefully cut the plastic tie to free the power cord and remove the screw holding the power cord clamp.
6. Lay the monitor facedown on a cushion and remove the six screws holding the hinge mechanism on the monitor. Lift off the hinge and base assembly.
7. If you are installing an arm or wall-mounting device, follow the directions included with the device. If you are just changing your cables, continue with Step 8.
8. Connect the signal cable and the power cord, then refit the power cord clamp in its original screwpost.
9. Slide the stand cover back on the stand.
10. Put the hinge cover back on, making sure that the straight side is at the top.
11. Insert the three tabs at the top of the cable cover into the slots in the back of the monitor and push the cover into place.

To obtain the correct cables and/or to get further instructions on installing them, call the IBM HELPCENTER at the above numbers or contact your dealer, retailer, or other IBM authorized Servicer.

# Specifications

This color monitor (Type-model 9511-Axx) uses a 15-inch TFT LCD

Dimensions	Width: Depth: Height:	401 mm 202 mm 371 mm
Weight	Unpackaged: packaged:	11.2 lb. (5.1 Kg) 13.9 lb. (6.3 Kg)
Tilt	Forward Tilt: Backward tilt:	- 4° + 41°
Image	Viewable Image Size: Maximum Height: Maximum Width: Pixel Pitch:	15.0" (381 mm) 228.1 mm 304.1 mm 0.297 mm (H) × 0.297 mm (V)
Power Input	Supply Voltage: Max Supply Current:	90 - 260 Vac 60/50 ± 3 Hz 1.0 A at 120 Vac
Power Consumption	Normal Operation: DPMS Stand-by: DPMS Suspend: DPMS off:	< 30 W < 3 W < 3 W < 3 W
Video Input	Input Signal: Horiz. Addressability: Vert. Addressability: Clock Frequency:	Analog Direct Drive 75 ohm 0.7 V 1024 pixels (max) 768 lines (max) 80 MHz
Communications	VESA DDC:	2 B
Supported Display Modes	VESA Standard 12 modes Macintosh 1 mode	See page 18
Environment	Temperature: Operating: Storage: Shipping: Humidity: Operating: Storage: Shipping:	10 to 35° C - 20 to 60° C - 20 to 60° C 10 to 80% 5 to 95% 5 to 95%

***i*** Power consumption figures are for the monitor and the power supply combined.

# Warranty Statements

Your Installation Diskette includes translation of IBM's Statement of Warranty in following languages:

<b>Worldwide Statement of Warranty (Except Turkiye, U.S., Puerto Rico and Canada):</b>	
Arabic	Z1255697.ara.html
Brazilian portuguese	Z1255697.bra.html
Bulgarian	Z1255697.bul.html
Chinese	Z1255697.chi.html
Croatian	Z1255697.cro.html
Czech	Z1255697.cze.html
Danish	Z1255697.dan.html
Dutch	Z1255697.dut.html
English	Z1255697.eng.html
Finnish	Z1255697.fin.html
French	Z1255697.fre.html
German	Z1255697.ger.html
Greek	Z1255697.gre.html
Hebrew	Z1255697.heb.html
Hungarian	Z1255697.hun.html
Italian	Z1255697.ita.html
Japanese	Z1255697.jap.html
Korean	Z1255697.kor.html
Norwegian	Z1255697.nor.html
Polish	Z1255697.pol.html
Portuguese	Z1255697.por.html
Russian	Z1255697.rus.html
Slovakian	Z1255697.sla.html
Slovenian	Z1255697.sle.html

Spanish	Z1255697.spa.html
Swedish	Z1255697.swe.html
Taiwanese	Z1255697.tai.html

<b>Turkiye Statement of Warranty:</b>	
Turkish	Z1255698.tur.html
English	Z1255698.eng.html

<b>United States, Puerto Rico and Candada Statement of Limited Warranty:</b>	
English	Z1254753.eng.html
French Canadian	Z1254753.fca.html

## Free Manuals Download Website

<http://myh66.com>

<http://usermanuals.us>

<http://www.somanuals.com>

<http://www.4manuals.cc>

<http://www.manual-lib.com>

<http://www.404manual.com>

<http://www.luxmanual.com>

<http://aubethermostatmanual.com>

Golf course search by state

<http://golfingnear.com>

Email search by domain

<http://emailbydomain.com>

Auto manuals search

<http://auto.somanuals.com>

TV manuals search

<http://tv.somanuals.com>