



**Note:** Before using this information and the product it supports, be sure to read the general information under “Safety information” on page vii, and “Notices” on page 134. For ergonomics information, see the *Online User's Guide*.

## **First Edition (March 2000)**

**The following paragraph does not apply to the United Kingdom or any country where such provisions are inconsistent with local law:**

INTERNATIONAL BUSINESS MACHINES CORPORATION PROVIDES THIS PUBLICATION "AS IS" WITHOUT ANY WARRANTY OF ANY KIND, EITHER EXPRESS OR IMPLIED, INCLUDING, BUT NOT LIMITED TO, THE LIMITED WARRANTIES OF MERCHANTABILITY OR FITNESS FOR A PARTICULAR PURPOSE. Some states do not allow disclaimers or express or implied warranties in certain transactions; therefore, this statement may not apply to you.

This publication could include technical inaccuracies or typographical errors. Changes are periodically made to the information herein; these changes will be incorporated in new editions of the publication. IBM may make improvements or changes in the products or the programs described in this publication at any time.

Requests for technical information about IBM products should be made to your IBM Authorized Dealer or your IBM Marketing Representative.

© **Copyright International Business Machines Corporation 2000. All rights reserved.** Note to US Government Users — Documentation related to restricted rights — Use, duplication, or disclosure is subject to restrictions set forth in GSA ADP Schedule Contract with IBM Corp.

## Thank you for choosing an IBM ThinkPad i Series 1200/1300 computer

---

We at IBM have developed this ThinkPad computer to meet both your technical requirements and your high expectations. To help us continue to build products that address your mobile computing needs, please take a moment to complete the ThinkPad Registration.

---



## Functional highlights

**Slim and compact design with core technology** The slim and compact design of the ThinkPad i Series 1200/1300 brings ease-of-use and portability to your computing needs.

**High-speed processor** The Intel® high-speed processor enables high-speed data processing and provides advanced performance.

**Large-capacity hard disk drive** The large-capacity hard disk drive can respond to a wide variety of your business demands.

**Large color LCD** The large TFT (thin-film transistor) or HPA (high performance addressing) display provides clear and brilliant text and graphics.

**Nickel metal hydride battery pack** The large-capacity battery pack extends the operating time of your computer, further enhancing its portability.

**Audio with 3D Stereo Sound** Your computer is equipped with internal audio record and playback capabilities including 3D audio from two speakers. When you enable the 3D stereo feature, sounds will appear to be generated all around you.

The audio feature supports the following:

- Wave audio recording and playback of up to 16 bits, stereo, and 48 KHz sampling.
- Music CD playback.

For more information on using the audio function, see the *Online User's Guide*.

**ThinkPad Modem** The ThinkPad modem enables you to send or receive data and faxes over a telephone line.

For more information on using the ThinkPad modem, see the *Online User's Guide*.

## ***Functional highlights***

**TrackPoint with Enhanced Controls** Your computer has an enhanced TrackPoint function that enables you to make selections merely by pressing on the TrackPoint. A new center button, the Internet Scroll Bar, converts the TrackPoint into a scroll controlling device or a magnifying glass on the screen.

For more information on using the TrackPoint, see “TrackPoint” on page 9.

**PC Card Support** Your computer provides a PC Card slot that accepts a 16-bit PC Card, CardBus Card, or Zoomed Video Card.

For more information on installing PC Cards, see “Inserting a PC Card” on page 70.

**Easy Launch buttons** Your computer is equipped with four customizable buttons that allow you to connect to the Internet or to run programs at a single press of a button.

For more information on customizing the Easy Launch buttons, see “Easy Launch buttons Customization Utility” on page 33.

## About this book

## About this book

This book contains information that will help you operate the IBM ThinkPad i Series 1200/1300 computer. Be sure to read the *ThinkPad i Series 1200/1300 Setup Guide* and Chapter 1 of this book before using the computer.

**Chapter 1. "Getting familiar with your computer,"** acquaints you with the basic features of your computer



**Chapter 2. "Extending the features of your computer,"** provides information on installing options and using your computer's high-technology features.

**Chapter 3. "Protecting your computer,"** provides information on using passwords, and using locks.

**Chapter 4. "Solving computer problems,"** describes what to do when you have a computer problem. The chapter includes a troubleshooting guide and information on how to recover lost or damaged software.

**Chapter 5. "Getting service,"** describes various options of IBM's support and service.

**Appendix A, Features and specifications** describes the features and specifications associated with your computer, including information on power cords.

**Appendix B, Product warranties and notices** contains the warranty statements for your computer and notices for this book.

The book concludes with an **index**.

## Safety information

### Electrical safety notice



#### **DANGER**

**Electrical current from power, telephone, and communication cables is hazardous. Reduce the risk of fire and electric shock by always following basic safety precautions, including the following:**

- **Do not use your computer in or near water.**
- **During electrical storms, do not connect the cable to or disconnect it from the telephone outlet on the wall.**

**To avoid shock hazard, connect and disconnect cables as shown below when installing, moving, or opening the covers of this product or attached devices. The 3-pin power cord must be used with a properly grounded outlet.**

**Safety information**

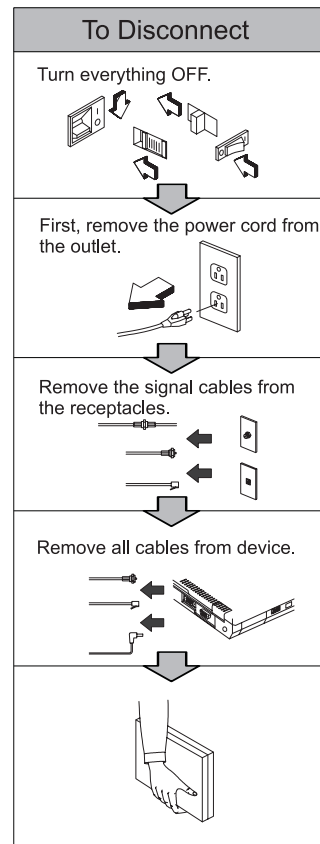
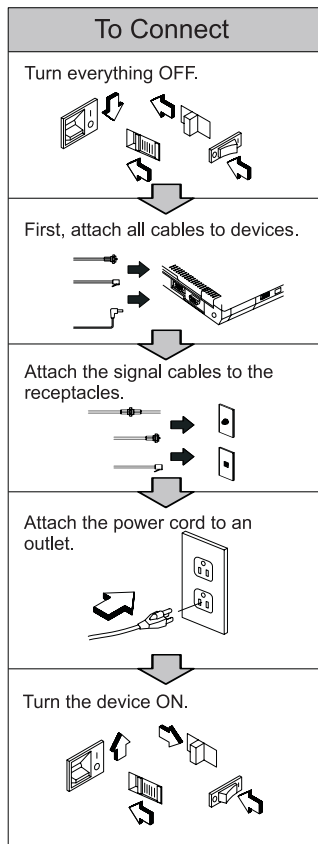

**DANGER**

**Do not disassemble, incinerate, or short-circuit the rechargeable battery pack. Do not put it in trash that is disposed of in landfills. Dispose of it as required by local ordinances or regulations. In the United States, call IBM at 1-800-IBM-4333 for information on disposal.**



## ***Safety information***



### **DANGER**

There is a danger of an explosion if the battery is incorrectly replaced.

The lithium battery (IBM P/N 02K6502 UL-recognized component [file no. MH12210]) contains lithium and can explode if it is not properly handled or disposed of.

Replace only with a battery of the same type.

Do not: (1) throw or immerse it into water, (2) allow it to heat to more than 100°C (212°F), or (3) attempt to repair or disassemble it. Dispose of it as required by local ordinances or regulations.

### **CAUTION:**

The fluorescent lamp in the liquid crystal display (LCD) contains mercury. Do not put it in trash that is disposed of in landfills. Dispose of it as required by local ordinances or regulations.

The LCD is made of glass, and rough handling or dropping the computer can cause the LCD to break. If the LCD breaks and the internal fluid gets into your eyes or on your hands, immediately wash the affected areas with water for at least 15 minutes; then get medical care if any symptoms are present after washing.

## **Laser compliance statement**

The CD-ROM drive of the ThinkPad i Series 1200/1300 computer is a laser product. The CD-ROM drive's classification label (shown below) is located on the top of the drive.

CLASS 1 LASER PRODUCT  
LASER KLASSE 1  
LUOKAN 1 LASERLAITE

## **Safety information**

### APPAREIL A LASER DE CLASSE 1 KLASS 1 LASER APPARAT

The CD-ROM drive is certified in the U.S. to conform to the requirements of the Department of Health and Human Services 21 Code of Federal Regulations (DHHS 21 CFR) Subchapter J for Class 1 laser products.

In other countries, the drive is certified to conform to the requirements of EN60825.



#### **CAUTION:**

**Do not open the CD-ROM drive; no user adjustments or serviceable parts are inside.**

**Use of controls, adjustments, or the performance of procedures other than those specified may result in hazardous radiation exposure.**

Class 1 laser products are not considered to be hazardous. The CD-ROM drive has an internal, Class 1, 0.5-milliwatt, aluminum gallium-arsenide laser that operates at a wavelength of 760 to 810 nanometers. The design of the laser system and the CD-ROM drive ensures that there is no exposure to laser radiation above a Class 1 level during normal operation, user maintenance, or servicing conditions.

## Contents

---

|   |     |
|---|-----|
| <b>Thank you for choosing an IBM ThinkPad i Series 1200/1300 computer</b> . . . . . | iii |
| Functional highlights . . . . .   | iv  |
| About this book . . . . .   | vi  |
| Safety information . . . . .  | vii |
| Electrical safety notice . . . . .  | vii |
| Laser compliance statement . . . . .  | ix  |
| <br>  |     |
| <b>Getting familiar with your computer</b> . . . . .                                | 1   |
| Identifying the hardware features . . . . .   | 2   |
| Front view of the computer . . . . .  | 2   |
| Rear view of the computer . . . . .   | 4   |
| Bottom view of the computer . . . . .   | 6   |
| System status indicators . . . . .  | 7   |
| Distinctive functions of your computer . . . . .                                    | 9   |
| Keyboard functions . . . . .  | 9   |
| CD-ROM drive . . . . .  | 16  |
| ThinkPad utility programs . . . . .   | 17  |
| Online User's Guide . . . . .   | 37  |
| Reinstalling software . . . . .   | 38  |
| ThinkPad Software Selections CD . . . . .   | 38  |
| Recovery CD . . . . .   | 38  |
| ThinkPad Web site or bulletin board . . . . .                                       | 38  |
| Replacing the battery pack . . . . .  | 39  |
| Handling your ThinkPad computer . . . . .   | 40  |
| ThinkPad do's . . . . .   | 40  |
| ThinkPad don'ts . . . . .   | 40  |
| Carrying your computer . . . . .  | 42  |
| Cleaning your computer . . . . .  | 42  |
| Extending your battery life . . . . .   | 42  |
| For more information . . . . .  | 43  |
| <br>  |     |
| <b>Extending the features of your computer</b> . . . . .                            | 45  |
| Customizing the TrackPoint . . . . .  | 46  |
| Changing TrackPoint sensitivity . . . . .   | 46  |
| Enabling Press-to-Select . . . . .  | 47  |

|   |           |
|---|-----------|
| Enabling the scrolling feature . . . . .                  | 49        |
| Enabling the magnifying glass . . . . .                   | 50        |
| Changing TrackPoint button assignments . . . . .          | 50        |
| Increasing memory . . . . .                               | 52        |
| Upgrading the hard disk drive . . . . .                   | 56        |
| Attaching an external mouse, keypad or keyboard . . . . . | 58        |
| Attaching an external mouse or numeric keypad . . . . .   | 58        |
| Attaching an external keyboard and mouse . . . . .        | 60        |
| Disabling the TrackPoint . . . . .                        | 61        |
| Attaching an external monitor . . . . .                   | 62        |
| Display output location . . . . .                         | 63        |
| Display modes . . . . .                                   | 65        |
| Using the dual display function . . . . .                 | 66        |
| Attaching a printer . . . . .                             | 69        |
| Inserting a PC Card . . . . .                             | 70        |
| Removing the PC Card . . . . .                            | 71        |
| <b>Protecting your computer . . . . .</b>                 | <b>73</b> |
| Using passwords . . . . .                                 | 74        |
| Setting a password . . . . .                              | 75        |
| Entering a password . . . . .                             | 77        |
| Removing and changing a password . . . . .                | 78        |
| Using locks . . . . .                                     | 80        |
| <b>Solving computer problems . . . . .</b>                | <b>81</b> |
| Frequently asked questions . . . . .                      | 82        |
| Hints, tips and considerations . . . . .                  | 87        |
| Troubleshooting guide . . . . .                           | 88        |
| Troubleshooting charts . . . . .                          | 89        |
| Error codes or messages . . . . .                         | 90        |
| No error codes or messages . . . . .                      | 92        |
| Input problems . . . . .                                  | 93        |
| Standby or hibernation problems . . . . .                 | 95        |
| LCD problems . . . . .                                    | 97        |
| Indicator problems . . . . .                              | 98        |
| Battery problems . . . . .                                | 98        |
| CD-ROM Problems . . . . .                                 | 99        |
| Audio Problems . . . . .                                  | 100       |
| Universal Serial Bus (USB) problems . . . . .             | 100       |
| Modem problems . . . . .                                  | 101       |
| PC Card problems . . . . .                                | 102       |

|  |            |
|--|------------|
| Printer problems . . . . .   | 103        |
| External monitor problems . . . . .  | 104        |
| Other option problems . . . . .  | 106        |
| Software problems . . . . .  | 107        |
| Other problems . . . . .   | 108        |
| Recovering lost or damaged software . . . . .  | 109        |
| Using the PC-Doctor program . . . . .  | 109        |
| Using the ThinkPad Software Selections CD . . . . .                                  | 109        |
| Using the Recovery CD . . . . .  | 110        |
| ThinkPad Web site or Bulletin Board . . . . .  | 111        |
| <b>Getting service . . . . .</b>   | <b>113</b> |
| Information on your computer . . . . .   | 114        |
| Option list . . . . .  | 114        |
| Identification numbers . . . . .   | 114        |
| Problem recording sheet . . . . .  | 115        |
| Customer service and support . . . . .   | 116        |
| Online support services . . . . .  | 116        |
| Fax information . . . . .  | 116        |
| Help by telephone . . . . .  | 117        |
| EasyServ . . . . .   | 118        |
| Getting help around the world . . . . .  | 118        |
| Purchasing additional services . . . . .   | 119        |
| Enhanced PC support line . . . . .   | 119        |
| Ordering support line services . . . . .   | 120        |
| Warranty and repair services . . . . .   | 120        |
| <b>Appendix A. Features and specifications . . . . .</b>                             | <b>123</b> |
| Features . . . . .   | 124        |
| Specifications . . . . .   | 126        |
| IBM power cords . . . . .  | 127        |
| <b>Appendix B. Product warranties and notices . . . . .</b>                          | <b>129</b> |
| Notices . . . . .  | 134        |
| Year 2000 readiness and instructions . . . . .                                       | 134        |
| Trademarks . . . . .   | 135        |
| Electronic emission notices . . . . .  | 135        |
| Telecommunication notice . . . . .   | 137        |
| Industry Canada requirements . . . . .   | 139        |
| Regions where ThinkPad i Series 1200/1300 has ThinkPad<br>modem integrated . . . . . | 141        |

|  |            |
|--|------------|
| Notice to European Users of the IBM ThinkPad Modem . . .                   | 142        |
| Warning notice to New Zealand users of the IBM ThinkPad<br>modem . . . . . | 142        |
| <b>Index</b> . . . . .   | <b>145</b> |

## Getting familiar with your computer

---

This chapter provides basic information about your computer.

|   |    |
|---|----|
| Identifying the hardware features . . . . .         | 2  |
| Front view of the computer . . . . .                | 2  |
| Rear view of the computer . . . . .                 | 4  |
| Bottom view of the computer . . . . .               | 6  |
| System status indicators . . . . .                  | 7  |
| Distinctive functions of your computer . . . . .    | 9  |
| Keyboard functions . . . . .                        | 9  |
| TrackPoint . . . . .                                | 9  |
| Fn key . . . . .                                    | 12 |
| Easy Launch buttons . . . . .                       | 14 |
| Numeric keypad . . . . .                            | 15 |
| CD-ROM drive . . . . .                              | 16 |
| Using the CD-ROM drive . . . . .                    | 16 |
| Handling CDs . . . . .                              | 17 |
| ThinkPad utility programs . . . . .                 | 17 |
| BIOS Utility . . . . .                              | 18 |
| Notebook Manager . . . . .                          | 26 |
| Sleep Manager . . . . .                             | 31 |
| Easy Launch buttons Customization Utility . . . . . | 33 |
| Online User's Guide . . . . .                       | 37 |
| Reinstalling software . . . . .                     | 38 |
| ThinkPad Software Selections CD . . . . .           | 38 |
| Recovery CD . . . . .                               | 38 |
| ThinkPad Web site or bulletin board . . . . .       | 38 |
| Replacing the battery pack . . . . .                | 39 |
| Handling your ThinkPad computer . . . . .           | 40 |
| ThinkPad do's . . . . .                             | 40 |
| ThinkPad don'ts . . . . .                           | 40 |
| Carrying your computer . . . . .                    | 42 |
| Cleaning your computer . . . . .                    | 42 |
| Extending your battery life . . . . .               | 42 |
| For more information . . . . .                      | 43 |

## Identifying the hardware features

### Front view of the computer

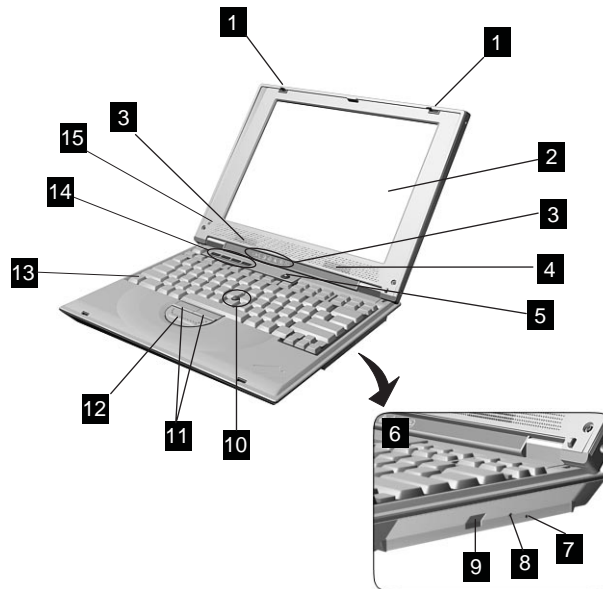

- (1) The **LCD latches** release the LCD when pressed and allow it to be opened.
- (2) The **color LCD screen** displays computer output.
- (3) The **indicator panel** consists of the system-status indicators and their associated symbols.
- (4) The left and right **internal speakers** generate stereo sound.
- (5)  The **power switch** turns the computer on and off.
- (6) The **CD-ROM drive**.
- (7) The **manual-eject hole** is used to eject the CD-ROM tray when it does not open with the eject button.
- (8) The **CD-ROM access indicator** is on when data is read from a CD in the CD-ROM drive.
- (9) The **CD-ROM eject button** ejects the CD-ROM tray.
- (10) The **TrackPoint** is a built-in pointing device that provides a function similar to that of a mouse.
- (11) The **TrackPoint buttons** work with the TrackPoint (10) and function similar to the buttons on a mouse.









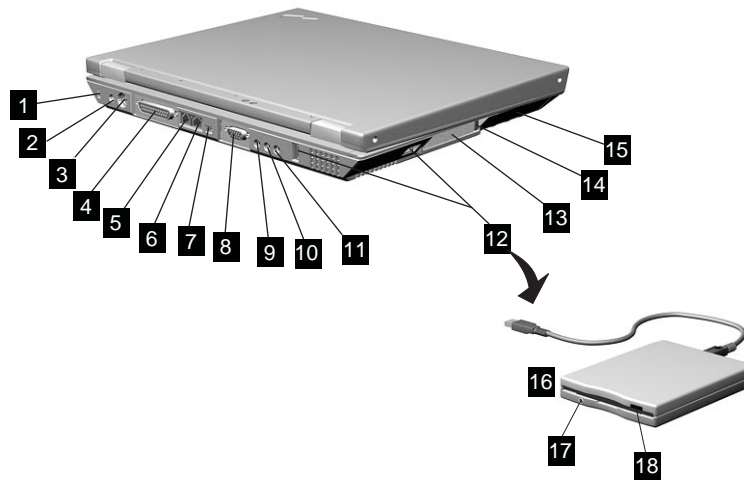

### *Identifying the hardware features*

- (12) The **Internet Scroll Bar** works with the TrackPoint (10) and functions as a scroll controlling device to easily scroll through Web pages or program windows.
- (13) The **Fn key** is used with the function keys to activate the **Fn** key functions.
- (14) The **Easy Launch buttons** are four customizable keys that allow you to run programs at a single press of a button. See “Easy Launch buttons Customization Utility” on page 33 for more information.
- (15) The **built-in microphone** captures sound and voice when it is used with an application program capable of handling audio.



## Identifying the hardware features

### Rear view of the computer



- (1)  The **security keyhole** is used with a mechanical lock.
- (2)  The **power jack** is where the AC Adapter cable is connected.
- (3)  The **PS/2 mouse and keyboard connector** is used to attach a mouse, external keyboard, or external numeric keypad to the computer.
- (4)  The **parallel connector** is where you connect a parallel-printer signal cable.
- (5)  The **internal modem port** is used for connecting your computer to an analog telephone line.
- (6) The **internal network port** (available on select models) is used for connecting your computer to an Ethernet (10BaseT or 100BaseT) network.
- (7) The **internal FireWire port** (available on select models) allows you to connect any device that conforms to the IEEE 1394 standard.
- (8)  The **external-monitor connector** is where you attach the external monitor.
- (9)  The **headphone jack**, a  $\frac{1}{8}$  inch (3.5mm) diameter jack, is where you connect stereo headphones or external speakers.

### *Identifying the hardware features*

- (10)  The **line-in jack**, a  $\frac{1}{8}$ inch (3.5mm) diameter jack, is where you connect an external audio device.
- (11)  The **microphone jack**, a  $\frac{1}{8}$ inch (3.5mm) diameter jack, is where you connect a self-powered stereo microphone.
- Note:** Do not plug any device into the microphone jack except a microphone.
- (12)  The two **universal serial bus (USB) ports** allow you to connect any device that conforms to the USB standard.
- (13) The **PC Card slot** accepts a PC Card.
- (14) The **PC Card eject button** ejects the PC Card from the PC Card slot.
- (15) The **hard disk drive**
- (16) The external **diskette drive** connects to a USB port (available as standard on select models or as an option).
- (17) The **diskette-drive-activity indicator** lights up when the computer is accessing the diskette drive.
- (18) The **diskette-eject button** ejects the diskette from the diskette drive.

## Identifying the hardware features

### Bottom view of the computer

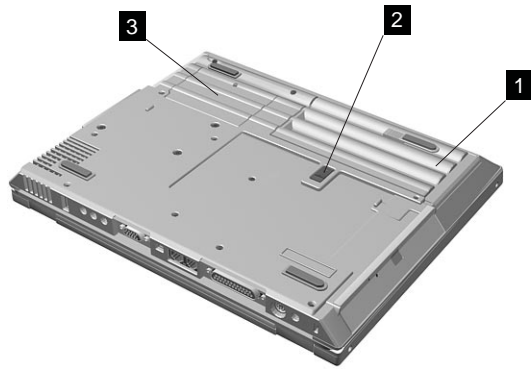

- (1) The **battery pack** is a built-in power source for the computer.
- (2) The **battery-pack latch** locks or releases the battery pack.
- (3) The **hard disk screw** secures the hard disk drive.
- (4) The **memory-slot cover** covers the memory slot.

The **memory slot** accepts a dual inline memory module (DIMM) option.







**Note:** Base memory (32 MB or 64 MB) is internal and cannot be upgraded.

## System status indicators

The system-status indicators on the computer show the current status of your computer by their on or off states and colors (green and orange). Each indicator is identified with a symbol. The following shows the location and the meaning of each icon:



## System status indicators

| Symbol   | Color           | Meaning   |
|--|-----------------|---|
| (1) Battery status<br> | Green           | Enough battery power remains for operation.   |
|  | Blinking orange | The battery pack needs to be charged  |
|  | Orange          | The battery pack is being charged.  |
| (2) Standby mode<br>   | Green           | The computer is in standby mode   |
|  | Blinking green  | The computer is entering or resuming from hibernation mode.   |
| (3) Drive in use<br>   | Orange          | Data is being read from or written to the hard disk. Do not enter standby mode or power off the computer when this indicator is on.   |
| (4) Numeric lock<br> | Green           | The numeric keypad on the keyboard is enabled. You enable or disable the keypad by pressing and holding the <b>Shift</b> key, and pressing the <b>NumLk</b> key. For details, see “Numeric keypad” on page 15.  |
| (5) Caps lock<br>    | Green           | Caps Lock mode is enabled. All alphabetic characters (A-Z) are entered in capital letters without the <b>Shift</b> key being pressed. You enable or disable the Caps Lock mode by pressing the <b>Caps Lock</b> key.  |
| (6) Scroll lock<br>  | Green           | Scroll Lock mode is enabled. The <b>Arrow</b> keys can be used as screen-scroll function keys. The cursor cannot be moved with the <b>Arrow</b> keys. <i>Not all application programs support this function.</i> You enable or disable Scroll Lock mode by pressing the <b>ScrLk</b> key. |
| (7) Power on<br>     | Green           | The computer is operational. This indicator is on when the computer is on.  |

## Distinctive functions of your computer

Your computer has unique keyboard functions and utility programs for easy configuration. This section includes the following topics:

- Keyboard functions
- CD-ROM drive
- ThinkPad utilities
- Online User's Guide

### Keyboard functions

Your computer's keyboard has the following functions:

- TrackPoint
- Fn key
- Easy Launch buttons
- Numeric keypad

#### *TrackPoint*

The keyboard contains a unique cursor-pointing device called the *TrackPoint*. Pointing, selecting, and dragging all become part of a single process you can perform without moving your fingers from their typing position.

The TrackPoint consists of a **stick** on the keyboard and three **click buttons** below the keyboard. Movement of the pointer on the screen is controlled by the amount of pressure you apply to the nonslip cap on the stick in any direction parallel to the keyboard; the stick itself does not move. The speed at which the pointer moves corresponds to the pressure you apply to the stick. The function of the click buttons depends on the software you are using.

## *Distinctive functions of your computer*

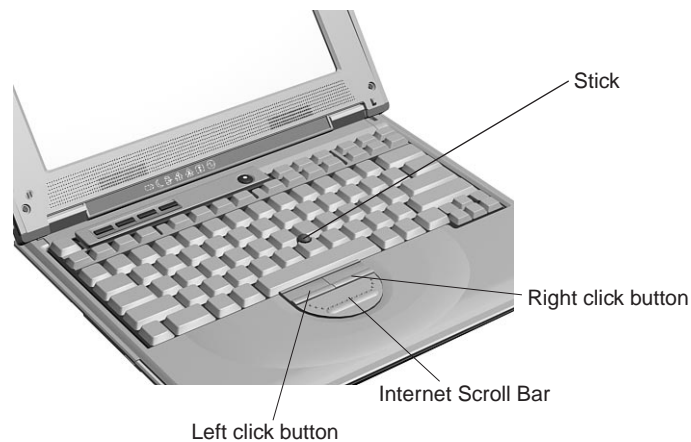

If you are not familiar with using the TrackPoint, these instructions will help you get started:

1. Place your hands in the typing position and press gently with your left or right index finger on the stick in the direction you want the cursor to move.

Pressing the stick away from you moves the cursor up the screen; pressing it toward you moves the cursor down the screen. You can also move the cursor side to side by pressing sideways.

**Note:** The cursor may drift. This is not a defect. Do not use the TrackPoint until the cursor stops moving.



## *Distinctive functions of your computer*

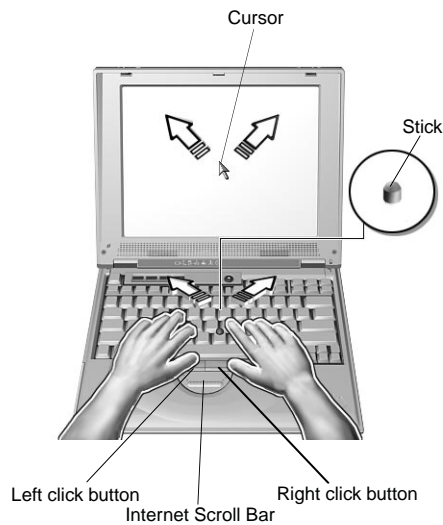

2. Press the click buttons with your left or right thumb to select and drag as required by your software.

### **Changing the Cap**

The cap (1) on the end of the TrackPoint is removable. You can replace it with the spare shipped with your computer.

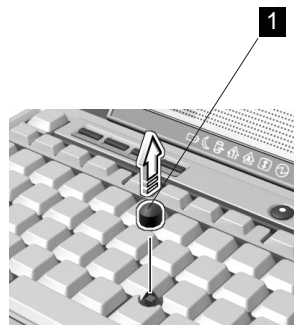

For more information on customizing the TrackPoint and using the Internet Scroll Bar, see “Customizing the TrackPoint” on page 46.

## *Distinctive functions of your computer*





### *Fn key*

The **Fn** key function allows you to change operational features instantly. When you use the following functions, press and hold the **Fn** key; then press the appropriate function key (**F1** to **F12**) or other keys (**Insert**, **Delete**, **Home**, **End**, **PgUp**, **PgDn** and **Backspace**).



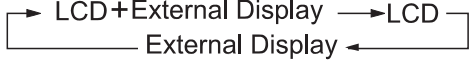

### *Distinctive functions of your computer*

The following table shows the function of the **Fn** key combined with keys:

| Feature and Icon  | Key Combination     | Meaning   |
|---|---------------------|---|
| Audio Functions   |                     |   |
| Previous track  | <b>Fn+F9</b>        | This plays the previous track of an audio CD in the CD-ROM drive.   |
| Next track  | <b>Fn+F10</b>       | This plays the next track of an audio CD in the CD-ROM drive.   |
| Play/Pause  | <b>Fn+F11</b>       | This starts the playback of an audio CD in the CD-ROM drive. Press this Fn key function again to pause playback.  |
| Stop/Eject  | <b>Fn+F12</b>       | This stops the playback of an audio CD in the CD-ROM drive. Press this Fn key function again to eject the CD-ROM tray.  |
| Volume up   | <b>Fn+PgUp</b>      | This increases the volume.  |
| Volume down   | <b>Fn+PgDn</b>      | This decreases the volume.  |
| Mute  | <b>Fn+Backspace</b> | This turns off the sound.   |
| Display Functions   |                     |   |
| Switching between the LCD and the external monitor<br> | <b>Fn+F7</b>        | Computer output is displayed in the following order when an external monitor is attached.<br> |
| Increase brightness<br>                                | <b>Fn+Home</b>      | This increases the brightness of the computer LCD.  |
| Decrease brightness<br>                                | <b>Fn+End</b>       | This decreases the brightness of the computer LCD.  |
| Contrast up<br>  | <b>Fn+Insert</b>    | This increases the contrast of the computer LCD.  |
| Contrast down<br>                                      | <b>Fn+Delete</b>    | This decreases the contrast of the computer LCD.  |
| Power Mode Functions  |                     |   |

## Distinctive functions of your computer

| Feature and Icon  | Key Combination | Meaning   |
|---|-----------------|---|
| Power Management Properties<br> | <b>Fn+F2</b>    | If you press this key combination, the Power Management Properties window appears. You can view and set parameters for battery status in the window.                  |
| Sleep<br>                       | <b>Fn+F4</b>    | The computer enters sleep mode. You can set the sleep button function in the "Advanced" section of the Power Management Properties window.                            |
| Other Functions   |                 |   |
| Controls at a glance ?<br>    | <b>Fn+F1</b>    | The <b>Controls at a glance</b> screen appears. This screen briefly describes the different user control features of the computer, including the Easy Launch buttons. |

**Note:** The contrast Fn key functions are available only on HPA models. The TFT models have optimized contrast settings.

### Easy Launch buttons

The Easy Launch buttons are four customizable keys located to the left of the power switch. These keys allow you to launch programs or visit Web sites at a single press of a button.

Easy Launch buttons



For more information on customizing the Easy Launch buttons, see "Easy Launch buttons Customization Utility" on page 33.

## *Distinctive functions of your computer*

### *Numeric keypad*

The keyboard has some keys that, when enabled, work as if they were on a 10-key numeric keypad. (The numeric keypad on the keyboard is not active when the external keyboard or the external numeric keypad is attached to the computer.)

To enable or disable the numeric keypad, press and hold **Shift** and then press **NumLk**.

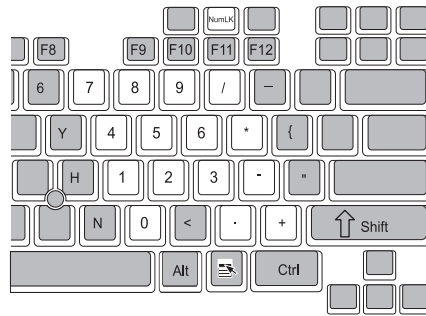

If the numeric keypad is enabled, press and hold **Shift** to temporarily use the cursor- and screen-control keys.

**Note:** The functions of the cursor- and screen-control keys are not printed on the keys.

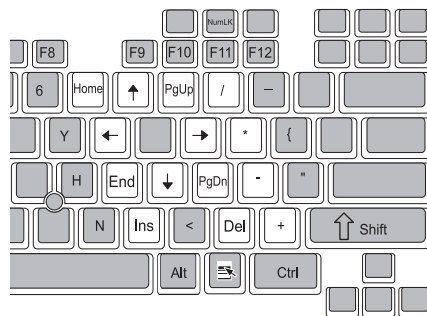

## *Distinctive functions of your computer*

### **CD-ROM drive**

The ThinkPad i Series 1200/1300 computer comes with a built-in CD-ROM drive. The CD-ROM drive allows you to use compact discs (CDs).

The following CDs are supported by the computer:

- Music CDs
- Photo CDs
- CD-ROM or CD-ROM XA
- Video CDs

#### *Using the CD-ROM drive*

To use the CD-ROM drive, do the following:

1. Turn on the computer.
2. Push the CD-ROM eject button on the side of the computer; then pull out the CD-ROM tray.
3. **Fit your CD on the center pivot. Firmly press the CD down until you hear it click into place.**



4. Push the tray into the computer until it fully closes.

The way you access the data on the CD depends on what type it is.

To remove the CD, do the following:

1. Close the application program that uses the CD.

### *Distinctive functions of your computer*

2. Push the CD-ROM eject button on the side of the computer; then pull out the CD-ROM tray.
3. Lift the CD by its edge while pressing the pivot.



4. Push the tray into the computer until it fully closes.

### *Handling CDs*

CDs are high-density media that must be handled with care and kept clean to ensure that data remains readable. Keep in mind the following to maintain reliability:

- Hold the disc by the edges. Do not touch the surface of the disc.
- To remove dust or fingerprints, wipe the disc from the center to the outside of the disc. Wiping the disc in a circular direction can cause loss of data.
- Do not write on the surface.
- Do not store or place the disc in direct sunlight
- Do not use benzene, thinner, or other cleaners to clean the disc. Use a CD-ROM cleaner kit.
- Do not flex or bend the disc.

### **ThinkPad utility programs**

Your ThinkPad computer has the following utility programs for easy configuration:

- BIOS Utility
- Notebook Manager program

## *Distinctive functions of your computer*

- Sleep Manager program
- Easy Launch buttons Customization Utility

This section summarizes these utility programs.

### *BIOS Utility*

Your computer provides a BIOS Utility which allows you to select various setup parameters:

- **System Information:** View information about the computer.
- **Basic System Settings:** Set date and time.
- **Startup Configuration:** Set startup options.
- **Onboard Devices Configuration:** Set device resource settings.
- **System Security:** Set a password.
- **Load Default Settings:** Load the default settings for all parameters.

To start the BIOS Setup Utility, do as follows:

1. Remove any diskette from the external diskette drive, and remove any CD from the CD-ROM drive; then turn off the computer.
2. Turn on the computer.
3. While the ThinkPad logo is being displayed, the following lines appear:

Press F1 for IBM BIOS Setup Utility  
Press F12 to choose temporary device

Press **F1**.

The BIOS Utility menu appears:



## *Distinctive functions of your computer*

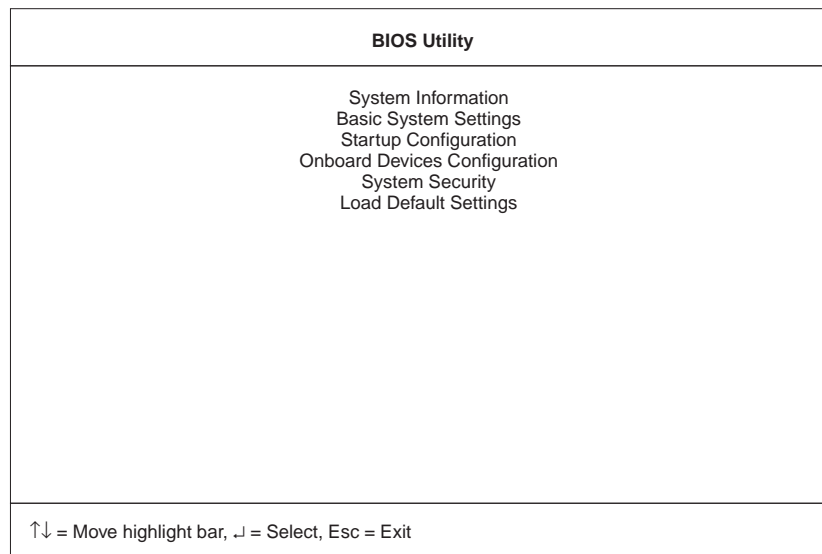

4. Move to an item you want to change using the up/down arrow keys, and press **Enter**.

A submenu is displayed.

5. Change the items you wish to change.

To change the value of an item, use the left/right arrow keys.

6. Press **Esc** to exit from the submenu.

7. Press **Esc** from the main menu and press **Enter** to save your changes and exit from the BIOS Setup Utility menu.

Your computer restarts.

**Note:** If you would like to discard your changes, select **No** and press **Enter**.

*System Information:* Selecting the **System Information** item and pressing **Enter** displays the following "System Information" submenu.

## Distinctive functions of your computer

| System Information        |                                  | Page 1/1 |
|---------------------------|----------------------------------|----------|
| CPU Type & Speed -----    | Pentium(R) III 500 MHz           |          |
| Diskette Drive A -----    | 1.44MB 3.5-inch (USB)            |          |
| Hard Disk Drive -----     | 5729 MB                          |          |
| HDD Serial Number -----   | xxxxxx                           |          |
| System with -----         | CD-ROM Attached                  |          |
| System BIOS Version ----- | VA.00Q                           |          |
| VGA BIOS Version -----    | 2.21.70                          |          |
| UUID -----                | xxxxxxxxxxxxxxxxxxxxxxxxxxxxxxxx |          |

Esc = Exit

**Note:** The items found in the screen above are for your reference only. Please refer to your computer's System Information screen for the correct data.

The "System Information" submenu includes the following:

- **CPU Type and Speed** shows the type and speed (in Megahertz) of the processor.
- **Diskette Drive A** shows information on the diskette drive.
- **Hard Disk Drive** shows the capacity of the hard disk drive.
- **HDD Serial Number** shows the serial number of the hard disk drive.
- **System with** shows information on the internal high-capacity media drive.
- **System BIOS Version** shows the BIOS version of the computer.
- **VGA BIOS Version** shows the BIOS version of the computer's video.
- **UUID** shows the universally-unique identifier code of the computer.

## *Distinctive functions of your computer*

**Basic System Settings:** Selecting the **Basic System Settings** item and pressing **Enter** displays the following "Basic System Settings" submenu.

| Basic System Settings                                   |                    | Page 1/1 |
|---|--------------------|----------|
| Date -----  | [Thu Feb 17, 2000] |          |
| Time -----  | [10:32:30]         |          |
| ↑↓ = Move highlight bar, ←→ = Change setting, F1 = Help |                    |          |

The "Basic System Settings" submenu includes the following:

- **Date** sets the system date.
- **Time** sets the system time.

**Note:** You can also set the current date and time in Windows 98.

**Startup Configuration:** Selecting the **Startup Configuration** item and pressing **Enter** displays the following "Startup Configuration" submenu.

## Distinctive functions of your computer

| Startup Configuration                                   |               | Page 1/1 |
|---|---------------|----------|
| Boot Display .....                                      | [ Auto ]      |          |
| Screen Expansion .....                                  | [Enabled ]    |          |
| Hotkey Beep .....                                       | [Enabled ]    |          |
| Fn Key Lock .....                                       | [Disabled ]   |          |
| Fast Boot .....   | [Enabled ]    |          |
| Boot Drive Sequence:                                    |               |          |
| 1st. ....   | [Floppy Disk] |          |
| 2nd. ....   | [CD-ROM]      |          |
| 3rd. ....   | [Hard Disk]   |          |
| ↑↓ = Move highlight bar, ←→ = Change setting, F1 = Help |               |          |

This submenu is used to set startup options and change the startup sequence of the drives in your computer. It includes the following:

- **Boot Display** sets the display output device on start up.
- **Screen Expansion** expands or shrinks the screen on your computer.
- **Hotkey Beep** enables or disables beeps when an Fn key function is pressed.
- **Fn Key Lock** enables or disables the Fn key lock function.

When enabled, you do not need to hold the Fn key to enable an Fn key function. Simply press the **Fn** key, release it, then press the other key(s) in the combination.

- **Fast Boot** enables or disables Fast Boot feature on your computer.

Fast Boot allows your computer to start up and resume faster. When enabled, the BIOS communicates with the Windows 98 operating system with ACPI about Plug-and-Play resources settings and information about previous start ups.

- **Boot Drive Sequence (1st, 2nd and 3rd)** specifies the start up sequence of local drives.

## *Distinctive functions of your computer*

**Choosing a temporary boot device:** You can choose a temporary boot device when you start up your computer. Do as follows:

1. While the ThinkPad logo is being displayed, the following lines appear:

Press F1 for IBM BIOS Setup Utility  
Press F12 to choose temporary device

Press **F12**.

The Boot Menu appears:

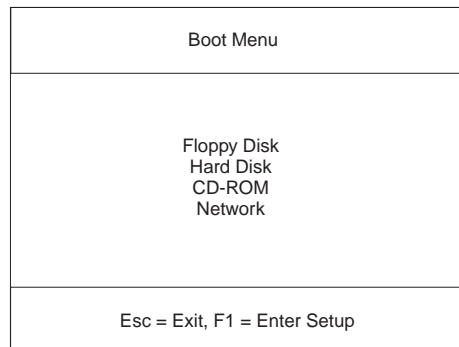

2. Use the cursor keys to select the device you want to boot from and press **Enter**.

**Note:** Make sure there are boot-up system files in the device you select. For example, a bootable diskette in the attached external diskette drive.

**Onboard Devices Configuration:** Selecting the **Onboard Devices Configuration** item and pressing **Enter** displays the following "Onboard Devices Configuration" submenu.

*Distinctive functions of your computer*

| Onboard Devices Configuration |                  | Page 1/1 |
|-------------------------------|------------------|----------|
| Parallel Port -----           | [Enabled ]       |          |
| Base Address -----            | [3BCh]           |          |
| IRQ -----                     | [7 ]             |          |
| Operation Mode -----          | [Bi-directional] |          |
| ECP DMA Channel -----         | [-]              |          |

↑↓ = Move highlight bar, ←→ = Change setting, F1 = Help

**Note:** You do not need to change the settings in the screen because the default settings are already optimized for you. Changing the values may cause device conflicts.

The "Onboard Devices Configuration" submenu includes the following:

- **Parallel Port section** enables and sets the resource values for the parallel port.

## Distinctive functions of your computer

**System Security:** Selecting the **System Security** item and pressing **Enter** displays the following "System Security" submenu.

| System Security          |          | Page 1/1 |
|--------------------------|----------|----------|
| Setup Password -----     | [ None ] |          |
| Power-on Password -----  | [ None ] |          |
| Hard Disk Password ----- | [ None ] |          |

↑↓ = Move highlight bar, ←→ = Change setting, F1 = Help

This submenu is used to set the power-on password, setup password, and hard disk password. Refer to "Using passwords" on page 74 for details.

**Load Default Settings:** Selecting this item displays the following dialog box.

|                                       |      |
|---------------------------------------|------|
| Do you want to load default settings? |      |
| [Yes]                                 | [No] |

To load factory-default settings for all the parameters in the BIOS Utility, select **Yes** and press **Enter**. Otherwise, select **No** and press **Enter**.

### CAUTION:

**Selecting Yes will erase all your changes.**

## *Distinctive functions of your computer*

### *Notebook Manager*

The Notebook Manager allows you to set passwords, the startup sequence of drives and power management settings. It also shows the current hardware configuration.

**Note:** Display-related **Fn** key functions are disabled when you access the Notebook Manager.

To start the Notebook Manager program, do as follows:

1. Click **Start**.
2. Move the cursor to **Programs, Notebook Manager**; then click **Notebook Manager**.

The Notebook Manager program consists of the following pages:

- Information Viewer
- POST
- Boot Sequence
- Password
- Display Device
- Parallel Port

**Note:** Making changes to most settings in Notebook Manager take effect the next time the computer restarts. If you make changes in the Power Management and Display Device pages, these take effect immediately.

*Information Viewer:* The Information Viewer page summarizes and lists information about the specifications and settings of the different components of your computer.



## Distinctive functions of your computer

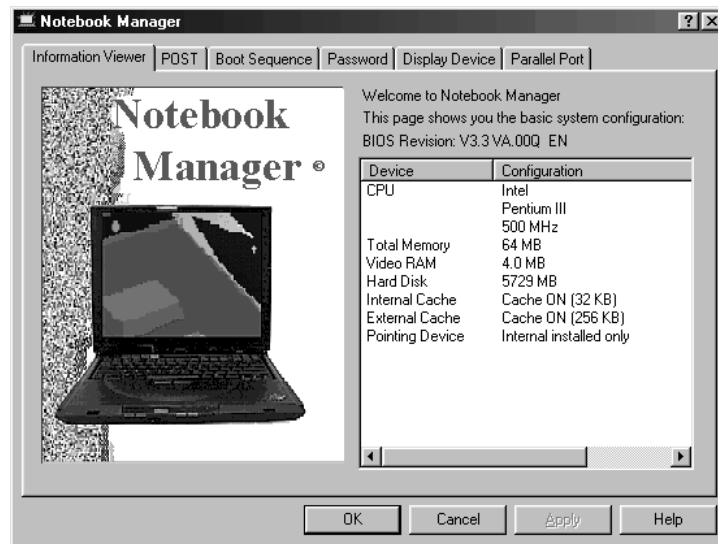

**Note:** The values and settings in the window above may differ from the ones on your computer.

Click the **Help** button to learn more about these system components.

## POST

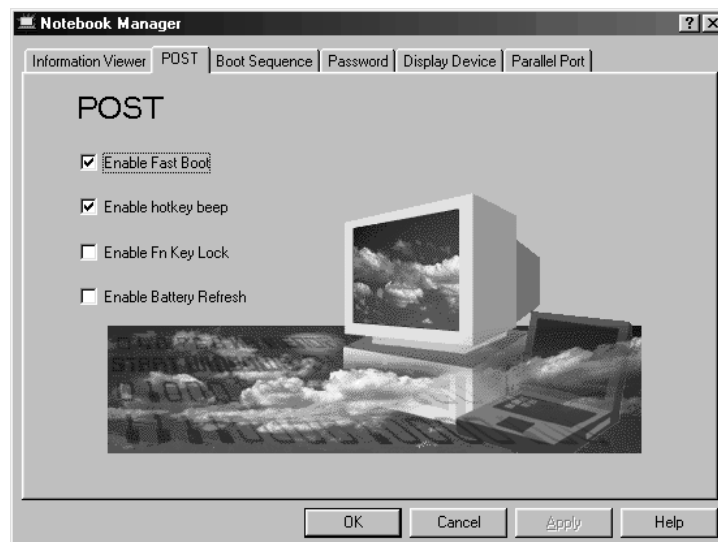

## Distinctive functions of your computer

The POST page displays the following items:

- *Enable Fast Boot* enables or disables the Fast Boot feature on your computer.

Fast Boot allows your computer to start up and resume faster. When enabled, the BIOS communicates with the Windows operating system with ACPI about Plug-and-Play resources settings and information about previous start ups.

- *Enable hotkey beep* When enabled, the computer gives off beeps when an Fn key function is pressed.
- *Enable Fn Key Lock* When enabled, you can execute an Fn key function without holding down the Fn key when pressing the other keys in the combination.
- *Enable battery refresh* When enabled, the computer uses battery power even when the AC Adapter is connected and supplying power to the computer.

**Boot Sequence:** In the Boot Sequence page, you can specify the startup sequence of the drives in your computer.

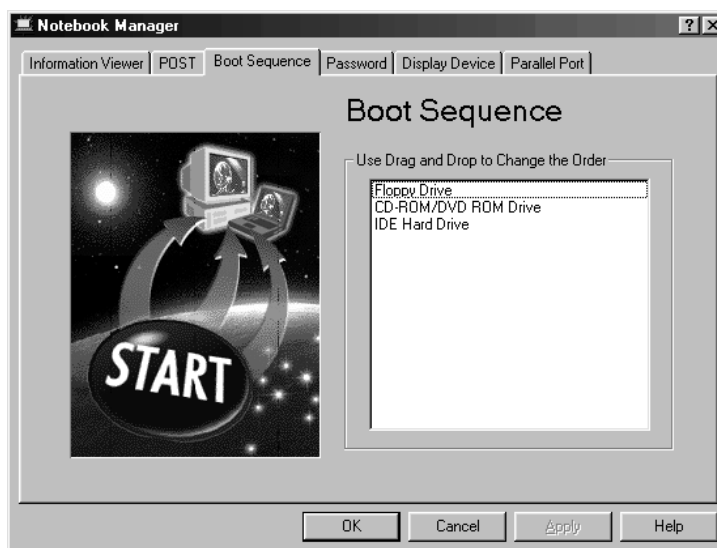

The Boot Sequence page allows you to set the startup sequence of the drives in your computer by simply dragging and dropping the

## *Distinctive functions of your computer*

drives in the list window. Click the **Help** button to learn more about these startup sequence settings.

**Password:** In the Password page, you can set, modify, or delete the password(s) for your computer.

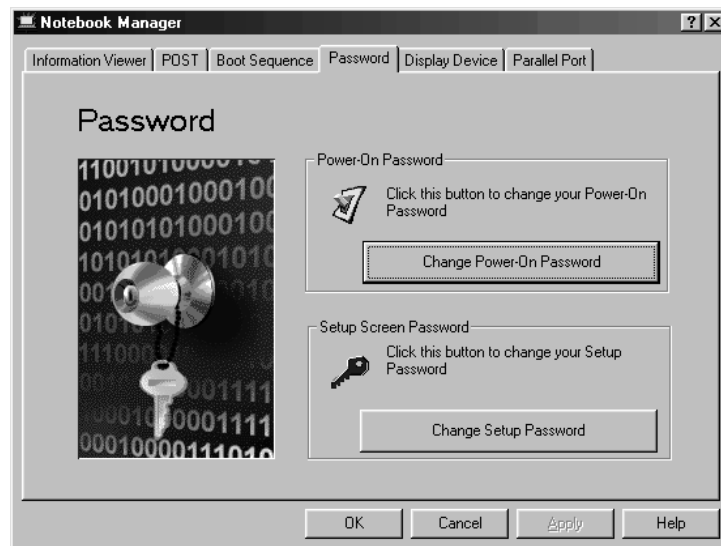

The Password page displays the following items:

- *Power-On Password.* The Power-On Password prevents unauthorized access to your computer at startup and when the computer resumes from hibernation mode.
- *Setup Password.* The Setup Password prevents unauthorized access to the BIOS Utility and Notebook Manager.

For more information on passwords, see “Protecting your computer” on page 73.

**Note:** The hard disk password can only be set using the BIOS Setup Utility. See “Using passwords” on page 74 for instructions on how to set passwords.

## Distinctive functions of your computer

**Display Device:** In the Display Device page, you can set options related to your display and attached external display devices.

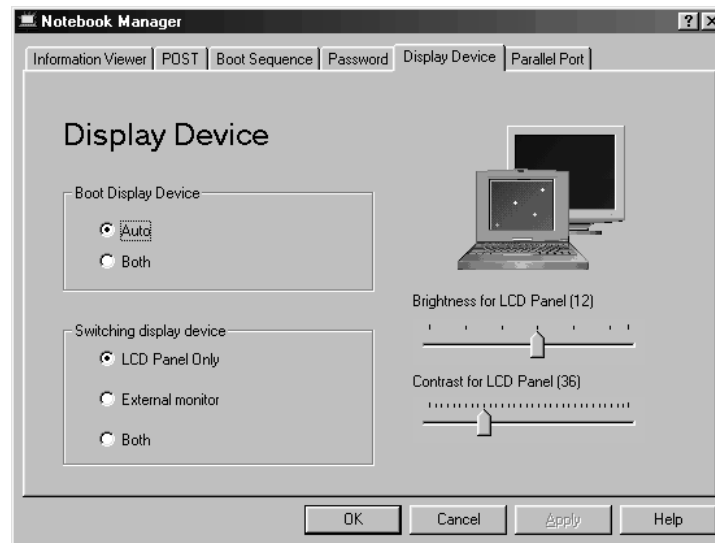

The Display Device page displays the following items:

- *Boot Display Device*. Sets the default display device on startup.
- *Switching Display Device*. Sets the current display device.

**Notes:**

1. You can also press **Fn+F7** to switch between display devices.
  2. Make sure an external monitor is connected before External Monitor is selected.
- *Brightness for LCD Panel*. Sets the brightness level for the computer LCD.

**Note:** A contrast slider is available for HPA models.

## Distinctive functions of your computer

**Parallel Port:** In the Parallel Port page, you can specify the settings for your computer's parallel port.

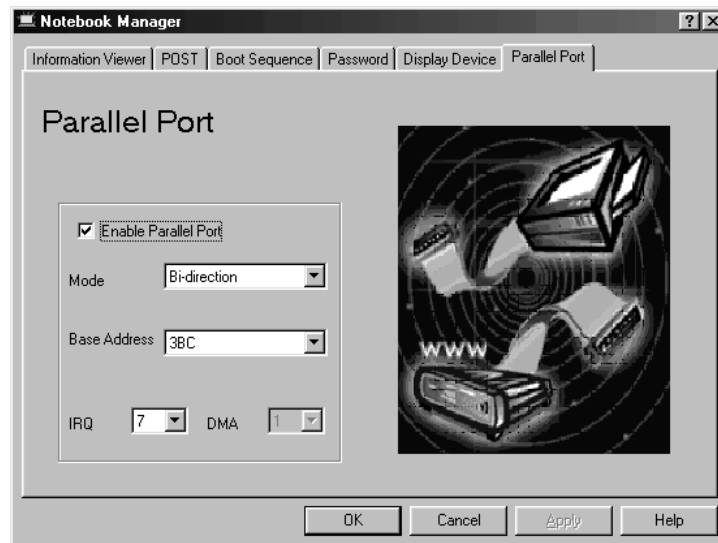

The Parallel Port page displays the following items:

- *Enable Parallel Port.* Enables or disables the parallel port.
- *Mode.* When the parallel port is enabled, allows you to set the mode used by the parallel port.
- *Base Address.* When the parallel port is enabled, allows you to set the base address used by the parallel port.
- *IRQ.* When the parallel port is enabled, allows you to set the interrupt request level to use.
- *DMA.* When the parallel port is enabled and the Mode is set to ECP, allows you to set the Direct Memory Access level to use.

### *Sleep Manager*

**Note:** Sleep Manager is only available in Windows 98.

The Sleep Manager program works with your computer's BIOS and Windows ACPI (Advanced Configuration and Power Interface) to manage the hibernation operation on your computer. In hibernation mode, the computer shuts off after saving the current state of your

## Distinctive functions of your computer

computer into your hard disk drive. The next time you power on your computer, it resumes from where you left off.

Its functions include:

- creating the hibernation file where Sleep Manager saves the current state of the computer
- verifying if the hibernation file is valid, and automatically re-creates and adjusts the file if necessary
- saving and loading the contents of the hibernation file when entering into and resuming from hibernation mode

To open the Sleep Manager program, locate the Sleep Manager icon on the taskbar and double-click on it.

**Note:** You can also access Sleep Manager as follows:

1. Click **Start**.
2. Move the cursor to **Programs, Sleep Manager**; then click **Sleep Manager**.

The following window appears:

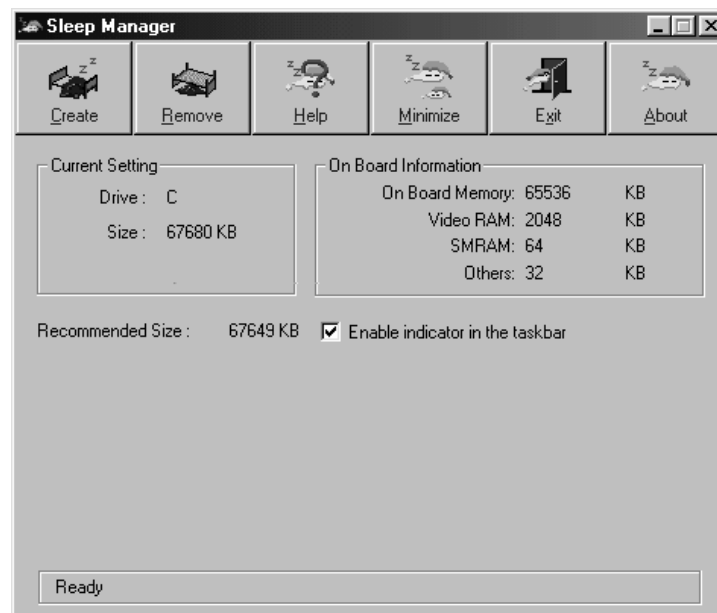

## *Distinctive functions of your computer*

**Note:** The computer automatically loads Sleep Manager everytime you start Windows 98. When Sleep Manager is active, it takes care of the hibernation file management chores in the background. Do not close this application or the computer may not enter hibernation mode properly.

Click the **Help** button to learn more about the Sleep Manager program.

### *Easy Launch buttons Customization Utility*

The Easy Launch buttons Customization Utility program enables you to start programs or launch Web sites by pressing one of four customizable keys found to the left of the power switch.

To start the Easy Launch buttons Customization Utility, double-click on the **Easy Launch buttons** icon on the taskbar.

**Note:** You can also run the Easy Launch buttons Customization Utility as follows:

1. Press **Fn+F1**.
2. Click the **Easy Launch buttons Utility** button in the **Controls at a glance** window.

or

1. Open the Control Panel. (Click **Start, Settings, Control Panel**.)
2. Double-click the **IBM Easy Launch buttons** icon.

The following window appears:

## Distinctive functions of your computer

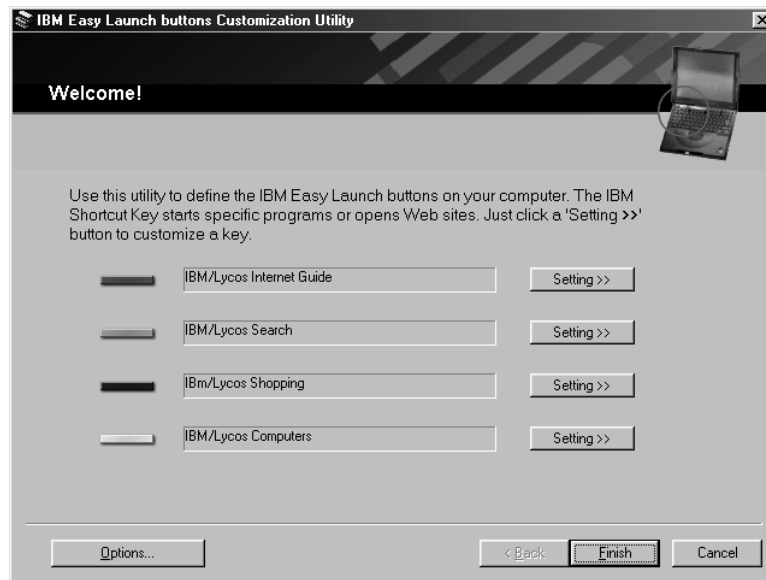

This window shows the current assignments of the Easy Launch buttons and includes instructions on how to use the Easy Launch buttons Customization Utility.

**Easy Launch buttons options:** When you click the Options button in the Easy Launch buttons Customization Utility window, the options window shows the following items:



- **On Screen Display.** When enabled, the title of an application or a Web site is drawn on the desktop. You can customize the color and font.



## *Distinctive functions of your computer*

**Note:** This feature is available for Easy Launch buttons, Fn+F1, Fn+F2, and audio CD playback buttons.

- **Sound.** When a wave file is defined as the event for an Easy Launch button in Sound Properties, the utility plays the wave file.

**Note:** This feature is available for Easy Launch buttons, Fn+F1, Fn+F2, and audio CD playback buttons.

- **Show icon on taskbar.** When enabled, the Easy Launch buttons icon appears on the taskbar.

*Customizing the Easy Launch buttons:* To customize the Easy Launch buttons:

1. Start the Easy Launch buttons Customization Utility.
2. Click the **Setting>>** button for the key you want to customize.

The following window appears:



3. Mark the button beside **Web Site** or **Launch an Application**; then click **Next>**.

If you mark **Web Site**, the following window appears:

*Distinctive functions of your computer*

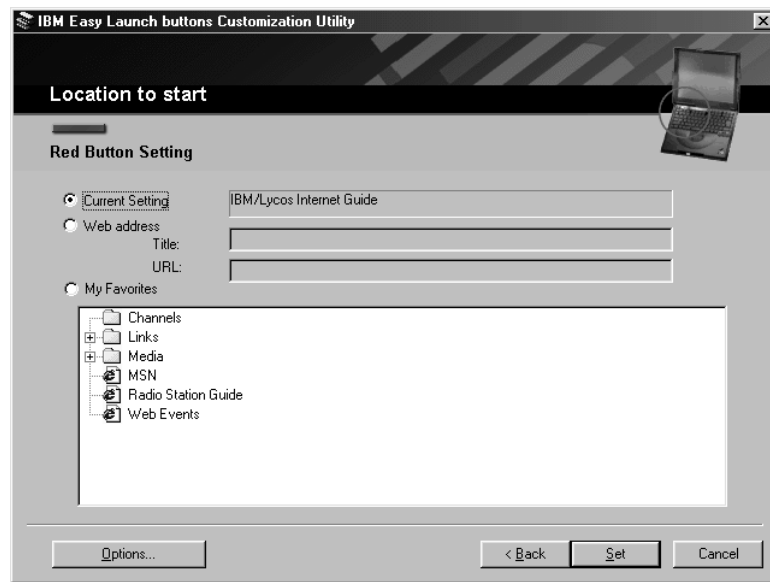

If you mark **Launch an Application**, the following window appears:

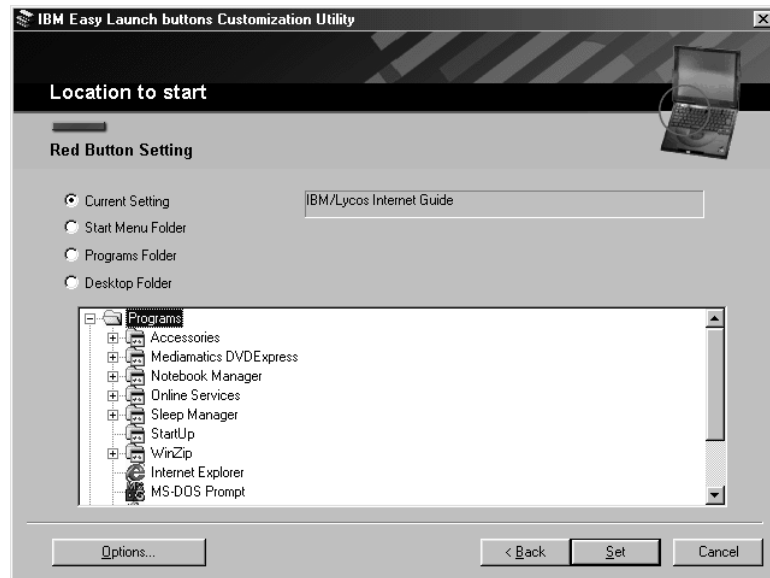

4. Select a Web site or an application you want to assign to the button; then click **Set**.

### *Distinctive functions of your computer*

The main window of Easy Launch buttons Customization Utility reopens.

5. Click **Finish** to complete the customization.

## **Online User's Guide**

Your ThinkPad computer features an online user's guide, so that you will always have key information at your fingertips even if you are traveling. It contains the following information:

- Using your computer outside your home country
- Using the audio and modem features
- Using your computer with a battery pack
- Using your computer with a PC Card
- Resolving system resource conflicts
- Solving computer problems
- Installing software
- Handling the ThinkPad
- Getting service

To start the online user's guide, click **Start**, move the cursor to **Programs** and **ThinkPad i Series 1200/1300**; then click **ThinkPad i Series 1200/1300 User's Guide**.

The Online User's Guide appears. Go to the section you want, and make a printout if necessary.

## Reinstalling software

To back up your system or reinstall the operating system, your ThinkPad computer has the following features:

**Note:** You can also get the latest hardware device drivers from the ThinkPad Web site (see “ThinkPad Web site or bulletin board”).

- The ThinkPad Software Selections CD
- The Recovery CD
- ThinkPad Web site or bulletin board

For more information about recovering lost or damaged software, see “Recovering lost or damaged software” on page 109.

### ThinkPad Software Selections CD

You can customize your system using this CD. It contains all the software applications and hardware device drivers for your computer in Windows. It features the ThinkPad Software Selections program. (To use the ThinkPad Software Selections CD, see the *Online User's Guide*.)

### Recovery CD

If you accidentally erased your hard disk, you can use the Recovery CD to restore the contents of the preinstalled hard disk to what it was at the time of purchase. To use the Recovery CD, see “Using the Recovery CD” on page 110.

### ThinkPad Web site or bulletin board

IBM supplies all of the latest hardware device drivers and system BIOS for your computer on the ThinkPad Web site:

**<http://www.pc.ibm.com/thinkpad>**

You can also use the IBM bulletin board service.

For more information about electronic service and support, see “Getting service” on page 113.

## Replacing the battery pack

To replace the battery pack, do as follows:

1. Power off your computer.
2. Disconnect the AC Adapter and cables.
3. Close the LCD and turn the computer over.
4. Slide and hold the battery-pack latch (1); then remove the battery pack (2).

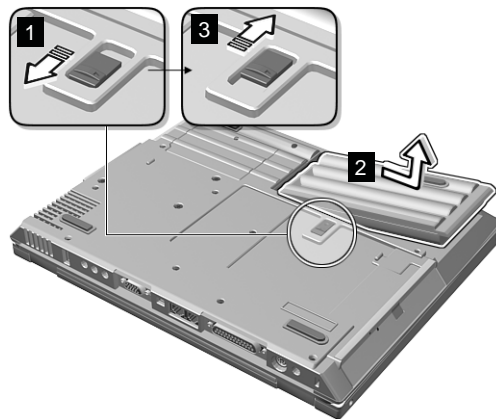

5. To install the new battery pack, insert it into the battery bay. The battery-pack latch automatically snaps into place.
6. Slide the battery-pack latch to the lock position (3).

You have finished replacing the battery pack.

**Note:** You can replace the battery pack when the computer is in hibernation mode or when it is powered off. If you are using a PC Card, the computer might not be able to enter hibernation mode. If this happens power off the computer.

## Handling your ThinkPad computer

Laptop computers are precision machines that require a bit of careful handling. Though the IBM ThinkPad computer is designed and tested to be a durable notebook computer that functions reliably in normal work environments, following the ThinkPad do's and don'ts will help ensure many years of comfortable and productive use from your computer.

### ThinkPad do's

- Choose a quality carrying case that will provide excellent protection for your computing investment. Treat your computer like a precision piece of electronic machinery.
- Register your ThinkPad products with IBM. This can help authorities return your computer to you if it is lost or stolen. Registering your computer also enables IBM to notify you about possible upgrades.
- Retain and store packing materials safely out of reach of children to prevent the risk of suffocation from plastic bags.
- Check the IBM Web pages at <http://www.pc.ibm.com/support> periodically to get current information about your computer.

### ThinkPad don'ts

- Do not leave the base of your computer in contact with your lap or any part of your body for an extended period when the computer is functioning or when the battery is charging. You computer dissipates some heat during normal operation. Extended contact to the skin could cause discomfort or, eventually, a skin burn.
- Do not subject your computer to physical punishment, such as dropping or bumping.
- Do not place heavy objects on your computer.
- Do not spill or allow liquids into your computer.
- Do not use your computer in or near water (to avoid the danger of electrical shock).

### *Handling your ThinkPad computer*

- Do not pack your computer in a tightly packed suitcase or bag. The compression might cause internal damage.
- Do not disassemble your computer. Only an authorized IBM ThinkPad repair person should disassemble and repair your computer.
- Do not scratch, twist, hit, or push the surface of your computer display.
- Do not place any objects between the display and keyboard or under the keyboard.
- Do not pick up or hold your computer by the display. When picking up your open computer, hold it by the bottom (keyboard) half.
- Do not modify or tape the latches to keep the display open or closed.
- Do not turn your computer over while the AC Adapter is plugged in. This could break the adapter plug.
- Do not use or store your computer where the temperature is below 5° C or above 35°C (41°F and 95°F).
- Do not place your computer closer than 13 cm (5 in.) from any electrical appliance that generates a strong magnetic field, such as a motor, magnet, TV, refrigerator, or large audio speakers.
- Do not hard-mount your computer in a vehicle or anywhere that it is subject to strong vibration. See the section on ruggedized mobile computers for information on a more appropriate model for demanding applications.
- Do not insert a diskette into the external diskette drive at an angle. Not inserting the diskette straight into the drive can damage the drive.
- Do not place more than one label on a diskette. Multiple or loose labels can detach or tear and then lodge in the drive.
- Do not touch the lens on the CD-ROM tray. You should hold the compact disc by the edges and not touch its surface.
- Do not connect a PBX (private branch exchange) or other digital telephone extension line. **Your computer can use only a public-switched telephone network (PSTN).** Use of a phone

## ***Handling your ThinkPad computer***

line other than PSTN can damage your modem. If you are not sure which kind of phone line you are using, contact your telephone company. Many hotels or office buildings use digital telephone extension lines, so check before connecting the telephone cable in such places.

- Do not place an active cellular phone on the computer.

## **Carrying your computer**

When carrying your computer, follow these instructions to prevent possible damage to your computer and data:

1. Remove any media from the external diskette drive or CD-ROM drive.
2. Turn off all attached devices.
3. Turn off the computer and close the LCD.
4. Unplug all external cables and cords connected to your computer.
5. Make sure all computer doors and covers are closed.
6. Use a quality carrying case that provides adequate cushion and protection.

## **Cleaning your computer**

You should occasionally clean your computer as follows:

- Use a soft cloth moistened with non-alkaline detergent to wipe the exterior of the computer.
- Don't spray cleaner directly on the display or keyboard.
- Gently wipe the LCD with a dry, soft cloth.

## **Extending your battery life**

The amount of battery power consumed by your computer depends on such conditions as the usage frequency, the operating temperature, and the period in storage (if unused). The following tips can help you to extend the life of your battery:

- If your battery is brand new and you are charging it for the first time, it might not become fully charged due to the characteristics of the chemicals in the cell. To maximize performance, ensure



## ***Handling your ThinkPad computer***

that all chemicals in the battery are fully activated by cycling the battery (fully charge, then fully discharge) three times. This procedure is also recommended if you stored the battery for a few months.

- Do not charge the battery pack until all of its power is used. Recharging a battery pack that is not completely discharged can shorten battery life.
- Once you start charging the battery pack, do not use it until it is fully charged.
- Whenever possible, use the ThinkPad battery power-saving modes:
  - standby: The LCD and the hard disk drive are turned off.
  - hibernation: All tasks are stopped. The memory data and the current status of the computer are stored in the hard disk drive; then the power is turned off.
- Decrease the LCD brightness.
- Stop the power supply to a serial device if it is not in use.
- Remove the battery pack and keep it in a cool place if you will not be using the computer for a long period.

### **For more information**

|   |   |
|---|---|
| For information via the World Wide Web                        | <a href="http://www.pc.ibm.com/us/thinkpad">http://www.pc.ibm.com/us/thinkpad</a><br><a href="http://www.networking.ibm.com/wireless">www.networking.ibm.com/wireless</a> |
| For product and dealer location information                   | 1 800 426-2968  |
| To access the IBM PC Company Bulletin Board                   | 1 919 517-0001  |
| For product information sent directly to your fax machine     | 1 800 IBM-3395<br>(1 800 426-3395)  |
| IBM PC Product Guide Directory (to specific product sections) | Select FaxDoc #12745  |
| IBM ThinkPad Information Directory                            | Select FaxDoc #11078  |



## Extending the features of your computer

---

This chapter provides information on how to customize and extend the ThinkPad computer's features. You can use the ThinkPad computer with external devices and increase the memory.

|   |    |
|---|----|
| Customizing the TrackPoint . . . . .                      | 46 |
| Changing TrackPoint sensitivity . . . . .                 | 46 |
| Enabling Press-to-Select . . . . .                        | 47 |
| Enabling the scrolling feature . . . . .                  | 49 |
| Choosing the scrolling method . . . . .                   | 49 |
| Enabling the magnifying glass . . . . .                   | 50 |
| Changing TrackPoint button assignments . . . . .          | 50 |
| Increasing memory . . . . .                               | 52 |
| Upgrading the hard disk drive . . . . .                   | 56 |
| Attaching an external mouse, keypad or keyboard . . . . . | 58 |
| Attaching an external mouse or numeric keypad . . . . .   | 58 |
| Attaching an external keyboard and mouse . . . . .        | 60 |
| Disabling the TrackPoint . . . . .                        | 61 |
| Attaching an external monitor . . . . .                   | 62 |
| Display output location . . . . .                         | 63 |
| Display modes . . . . .                                   | 65 |
| Using the dual display function . . . . .                 | 66 |
| Disabling dual display . . . . .                          | 67 |
| Considerations when using dual display . . . . .          | 67 |
| Attaching a printer . . . . .                             | 69 |
| Inserting a PC Card . . . . .                             | 70 |
| Removing the PC Card . . . . .                            | 71 |

## Customizing the TrackPoint

You can customize the TrackPoint by doing the following:

1. Click **Start**.
2. Move the cursor to **Settings**, then click on **Control Panel**.
3. Double-click **Mouse**.

The "Mouse Properties" window appears.

4. Click the **TrackPoint** tab.

You can set the following features in this window:

- TrackPoint sensitivity
- Press-to-Select
- Scrolling
- Magnifying Glass

**Note:** To use these special TrackPoint functions, you must disconnect any PS/2 mouse and enable the TrackPoint.

## Changing TrackPoint sensitivity

## Customizing the TrackPoint



You can change the way the TrackPoint cursor pointing device responds to your touch. You might prefer to use a light touch, or you might want to use more pressure.

Experiment with the sensitivity control to find the setting you like best. Of course, you can always adjust the setting by using Mouse Properties from the Control Panel.

To change TrackPoint sensitivity, do as follows:

1. Move the slider toward **Firm Touch** or **Light Touch**, depending on your preference.
2. Click **Apply**. While the Mouse Properties window is still open, test how the TrackPoint responds to your new setting.
3. When you have decided that the sensitivity is appropriate, click **OK**.

## Enabling Press-to-Select

You can use a special feature of the TrackPoint cursor pointing device to simplify selecting text and items in windows. To select text with Press-to-Select enabled, press downward on the TrackPoint

## Customizing the TrackPoint

stick, then move the cursor to select text or items in a window. You can also set how the Press-to-Select feature functions.

Press-to-Select allows you to make the TrackPoint stick function the same as the left or right click button. To enable Press-to-Select and set advanced settings, do as follows:

1. Click the **Enable Press-to-Select** check box.
2. Once Press-to-Select is enabled, you can click **Advanced...** under TrackPoint Stick. If you click this button, the Press-to-Select Advanced Settings window appears.



- If you check **Enable Dragging**, you can select an item with the TrackPoint stick and then drag the item by putting light pressure on the stick.
- If you check **Enable Release-to-Select**, you can click by simply lifting your finger quickly off the TrackPoint. Moving the cursor onto an icon and then lifting your finger off the TrackPoint works like clicking. Pressing the TrackPoint again works like double-clicking.
- Click one of the **Press means** radio buttons to select which mouse button the stick will simulate. For example, if you select **Left Click**, you will be able to start a program with the TrackPoint by putting the cursor on the program's icon and applying light pressure on the stick. To adjust the pressing timing of the stick, move the slider to set **Click Pace**.

**Note:** If you change the function of the right and left mouse buttons, that change will affect the function of the Press-to-Select feature. If you set the pace too slow,

## Customizing the TrackPoint

you might notice unintended clicks, a cursor delay, or a dragging delay. If you set the pace too fast, you might find Press-to-Select hard to use.

### Enabling the scrolling feature

The scrolling feature enables you to navigate easily through long documents or large spreadsheets with the press of a button. When scrolling is enabled, press the Internet Scroll Bar and then use the TrackPoint stick to scroll through text.

To enable scrolling, click the **Scrolling** radio button.

**Note:** To disable the scrolling and magnifying glass functions, click the **Neither** button.

### Choosing the scrolling method

When the scroll bar is enabled, you can choose any of three scrolling methods. Do as follows:

1. Make sure that the Scrolling radio button is checked.
2. Under the **Choose Scrolling or Magnifying Glass Function**, click **Advanced....**

The Center Button Advanced Setting window opens.

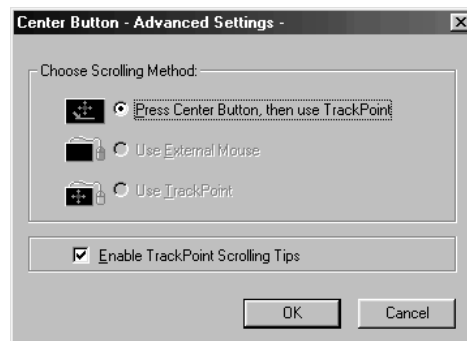

3. Click one of the following buttons:
  - **Press Center Button, then use TrackPoint:** If you choose this option, you will be able to control scrolling or the magnifying glass by holding down the Internet Scroll Bar and then using the TrackPoint. When you are not holding down the center button, the TrackPoint controls the cursor.

## Customizing the TrackPoint

- **Use External Mouse:** This option sets an externally attached mouse to scroll, or move the magnifying glass, horizontally or vertically. The TrackPoint controls only the cursor.
- **Use TrackPoint:** This option sets the TrackPoint to scroll horizontally or vertically without holding down the Internet Scroll Bar. Use an externally attached mouse to control the cursor. (You can still use the TrackPoint to control the cursor by pressing the Internet Scroll Bar and moving the stick in the direction you want the cursor to move.)

### Enabling the magnifying glass

This function enables you to enlarge a movable area of your display. You can click objects "through" the magnifying glass. The right click button changes the size of the magnifying glass, and the left click button changes its magnifying power. To move the magnified area, press the Internet Scroll Bar and then use the TrackPoint stick.

To enable the magnifying glass, click the **Magnifying Glass** radio button.

**Note:** To disable the scrolling and magnifying glass functions, click the **Neither** button.

### Changing TrackPoint button assignments

The left and right buttons at the bottom of your keyboard work like left and right mouse buttons. Your computer comes with the left button set for clicking or double-clicking items. The right button is set to open context-related menus and explanations. You can switch the function of these buttons.

To switch the functions of the left and right buttons, do as follows:

1. Click **Start**.
2. Move the cursor to **Settings**, then click on **Control Panel**.
3. Double-click **Mouse**.

The "Mouse Properties" window appears.

4. Click the button beside **Left-handed** or **Right-handed** depending on how you want to use the mouse.



## *Customizing the TrackPoint*

**Note:** When you click a button, the descriptions of the mouse button functions change to show the functions that you have assigned.

## Increasing memory

Increasing memory capacity is an effective way to make programs run faster. You can increase the amount of memory in your computer by installing a dual inline memory module (DIMM), available as an option.

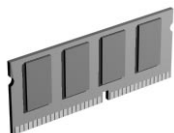

Different capacities of DIMM are available. You can install DIMMs directly in the memory slots on the bottom of the computer. Your computer memory capacity can be expanded up to 192 MB (one 128 MB DIMM option).

**Note:** Base memory (32 MB or 64 MB) is internal and cannot be upgraded.

**Attention:** The ThinkPad i Series 1200/1300 computer supports the static dynamic random access memory (SDRAM) card only. It does not support the enhanced data output dynamic random access memory (EDO DRAM) card. If you install a DIMM that is not supported by your computer, an error code might appear when the system starts. The appropriate memory option can be purchased through your IBM reseller or IBM marketing representative.

To install the DIMM, do the following:

1. Power off the computer; then disconnect the AC Adapter and all cables from the computer.
2. Close the LCD, turn the computer over, and then remove the battery pack.
3. Loosen the screw on the memory slot cover; then remove the cover.

## Increasing memory

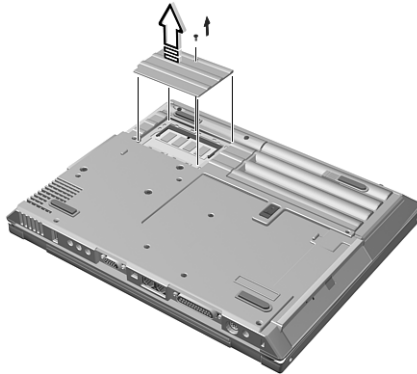

4. Install the DIMM into the memory slot.

**Note:** To avoid damaging the DIMM, do not touch its contact edge.

- a. Find the notch on the side of the DIMM.
- b. With the notched end of the DIMM toward the right side of the socket, insert the DIMM, at an angle or approximately 20°, into the socket; then press it firmly (1).
- c. Pivot the DIMM until it snaps into place (2).

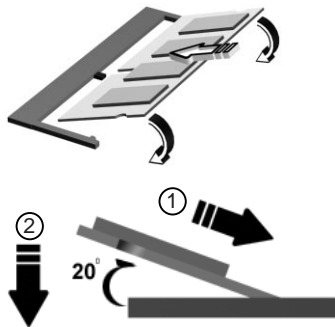

5. Replace the memory slot cover over the memory slot, aligning the back side of the cover first as shown; then tighten the screws.
6. Replace the battery pack.
7. Turn the computer over again, power on the computer.
8. Confirm that the new memory size is detected:

## Increasing memory

- a. While the ThinkPad logo is being displayed, wait for the BIOS Utility prompt before pressing **F1**.
- b. Select **Startup Configuration** and press **Enter**.
- c. Disable **Fast Boot**.
- d. Save the changes and exit the BIOS Utility.
- e. Verify the memory value (shown near the top left corner of the screen) when the computer restarts.

**Note:** After you have verified the memory value, shutdown and restart the computer. Enter the BIOS Utility to enable Fast Boot.

9. You have finished installing the DIMM. Reconnect all cables.

### Notes:

1. If the total memory size is not the same as the value you calculated, power off the computer and see pages 54 and 52 to reinstall the DIMM.
2. If you changed the memory installed in the computer, Sleep Manager automatically updates the hibernation file (see "Sleep Manager" on page 31).

### How to Calculate Total Memory Size

Calculate your total memory size in kilobytes (KB) by adding the DIMM memory size to the base memory size (32384 KB for a computer with 32 MB base memory).

**Note:** 384 KB is reserved by the system.

For example, if you installed a 32MB DIMM to a computer with 32 MB base memory, you should have about 64 MB.

Your computer displays the memory size in kilobytes. For example, 640 KB (system memory) + 64512 (extended memory) = 65152 KB.

### Removing a DIMM

If you need to remove a DIMM, follow these steps:

## ***Increasing memory***

1. Power off the computer and disconnect the AC Adapter and all cables from the computer.
2. Close the LCD, turn the computer over, and then remove the battery pack.
3. Loosen the screw and remove the memory slot cover.
4. Press out on the latches on both edges of the socket at the same time.

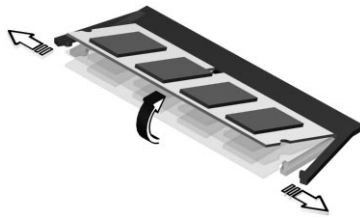

5. Remove the DIMM.  
Be sure to save the DIMM for future use.
6. Replace the memory slot cover; then tighten the screws.
7. Replace the battery pack.
8. Turn the computer over again; then connect the AC Adapter and all the cables you disconnected.

**Note:** Base memory (32 MB or 64 MB) is internal and cannot be upgraded.

## Upgrading the hard disk drive

You can increase the storage capacity of your computer by replacing the original, built-in hard disk drive with an optional one. You can purchase the option from your IBM reseller or IBM marketing representative.

**Note:** Replace the hard disk drive only if you upgrade it or have it repaired. You should not replace it often.

**Attention:** Do not drop or apply any shock to the hard disk drive. The drive is sensitive to physical shock. Incorrect handling can cause damage and permanent loss of data on the hard disk drive. Before removing the hard disk drive, have a backup copy of all the information on the hard disk drive. Never remove the drive while the system is operating or in suspend mode.

To replace the hard disk drive, do the following:

1. Power off the computer; then disconnect the AC Adapter and all cables from the computer.
2. Close the LCD, turn the computer over, and then remove the battery pack.
3. Loosen the coin screw by rotating it counterclockwise with a coin (1), as shown.

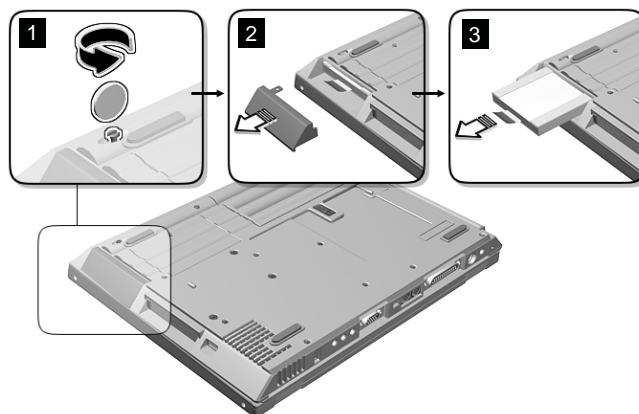

4. Remove the hard disk drive cover (2).

### ***Upgrading the hard disk drive***

5. Pull the strap of the hard disk drive to remove the drive (3).
6. To install the new hard disk drive, do the following:
  - a. Insert the new hard disk drive into the bay. Make sure you connect the drive firmly.
  - b. Replace the hard disk drive cover, and tighten the screw.
  - c. Turn the computer right-side up, and power it on.

## *Attaching an external mouse, keypad or keyboard*

# Attaching an external mouse, keypad or keyboard

This section explains how to attach an external mouse, external numeric keypad, and external keyboard to your computer.

## Attaching an external mouse or numeric keypad

You can attach an external mouse or numeric keypad to the PS/2 mouse and keyboard connector (  ) on the rear of the computer.



**Mouse**



**External keypad**

If you want to attach the mouse, attach it directly to the PS/2 mouse and keyboard connector as shown:



The TrackPoint is disabled automatically.

You can use an external USB mouse simultaneously with the TrackPoint.



### ***Attaching an external mouse, keypad or keyboard***

If you want to use both the external numeric keypad and mouse at the same time, first connect the keypad cable to the computer; then connect the mouse cable to the connector at the rear of the keypad.



**Note:** You can remove the keypad cover and use it as a stand for the keypad.



## Attaching an external mouse, keypad or keyboard

### Attaching an external keyboard and mouse

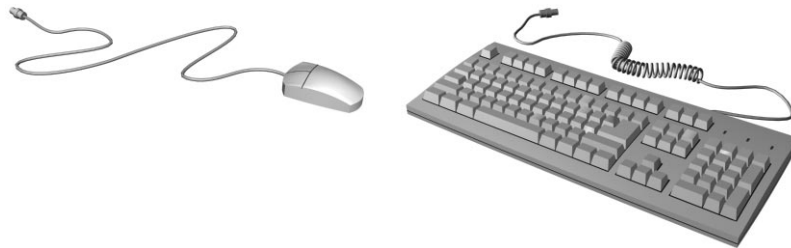

#### Mouse

#### External keyboard

You can connect an external keyboard to your computer either directly through the PS/2 mouse and keyboard connector or through the keyboard/mouse cable (available separately as an option).

When the external keyboard is attached, the following keys are not available:

- Numeric keypad on the computer keyboard
- External numeric keypad

Instead, use the numeric keypad on the external keyboard.

To attach the external keyboard, turn off the computer, attach the keyboard to the keyboard connector of the keyboard/mouse cable (1), and then attach the keyboard/mouse cable to the computer (2).

You can attach a mouse to the mouse connector of the keyboard/mouse cable.

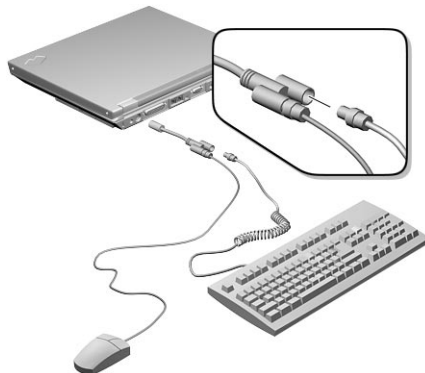

## *Attaching an external mouse, keypad or keyboard*

### **Using the IBM ThinkPad Space Saver Keyboard**

When using the IBM ThinkPad Space Saver Keyboard, ***do not*** install the device driver supplied with the Space Saver Keyboard. The TrackPoint on the ThinkPad is disabled when you use the Space Saver Keyboard.

### **Disabling the TrackPoint**

Attaching a PS/2 mouse automatically disables the TrackPoint. You can use a USB mouse simultaneously with the TrackPoint.

## *Attaching an external monitor*

# Attaching an external monitor

This section provides information about using the computer LCD and an external monitor. It also provides things to consider when using DOS applications.

The LCD of your computer uses thin-film transistor (TFT) technology or high performance addressing (HPA) technology. The TFT LCD displays output with XGA (1024x768 resolution) or SVGA (800x600 resolution) video mode and 16M colors, while the HPA LCD displays output with SVGA (800x600 resolution) video mode and 16M colors.

If you are attaching an external monitor that supports a resolution higher than XGA mode, you can achieve a maximum of 1280x1024 video resolution.

To attach an external monitor, do the following:

1. Connect the external monitor to the external-monitor connector (  ) at the rear of the computer; then connect the monitor to an electrical outlet.
2. Turn on the monitor.
3. Press **Fn+F7**.

**Note:** You can also change the display output location as follows:

1. Start the Notebook Manager program. (See "Notebook Manager" on page 26.)
2. Click the **Display Device** tab.
3. Change the display output location by clicking the **Both** or **External monitor** radio button in the "Switching display device" section.
4. Click **OK**.

## *Attaching an external monitor*

### **Notes:**

1. If you select **Both**, do not attach an external monitor that supports only VGA mode (640x480 resolution). Otherwise, the external monitor is scrambled and output is not displayed, or the screen might be damaged. Use **External monitor** instead.

2. Set your monitor type and display device driver as follows:

If you are attaching an SVGA monitor, refer “Display modes” on page 65 for information on the supported color depth or resolution.

- a. Click **Start, Settings, Control Panel**.
- b. Double-click **Display**.
- c. Double-click the **Settings** tab.
- d. Click the **Advanced...** button.
- e. Click the **Monitor** tab.
- f. Click the **Change...** button.

You can select your monitor type from the monitor list, or click on a new resolution.

**Note:** Refer to the specifications for your external monitor to determine its supported resolutions.

3. Restart the computer to make the changes effective.

## **Display output location**

**Attention:** Do not change the display output location while a moving picture is being drawn—for example, while playing a movie or a game. Stop the application before changing the display output location.

You can change the display output location with the Notebook Manager program. Select one of the following display output locations:

- **LCD Panel Only:** The computer output is displayed only on the LCD of the computer.
- **External monitor:** The computer output is displayed only on the attached external monitor.

## Attaching an external monitor

If no external monitor is attached to the computer and the display output location is set to External Display, the output is displayed on the LCD.

- Both: The computer output is displayed on both the LCD and the external monitor.

You can also change the display output location using the **Fn** key function. Press and hold the **Fn** key; then press the **F7** key. The output is displayed sequentially as follows:



### Important

Do not disconnect the external monitor while the computer is in hibernation mode. If no external monitor is attached when the computer resumes, the LCD remains blank and output is not displayed. This restriction does not depend on the resolution value.

## The DOS Screen Image on the LCD

If you use a DOS application that supports only VGA mode (640x480 resolution) with your computer, the screen image might appear smaller than the display size, as shown:

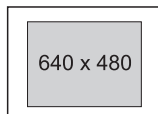

This is to maintain compatibility with DOS applications. To expand the screen image to the same size as the actual screen, you can use the screen expansion function.

- You can expand the screen image in DOS mode by enabling **Screen Expansion** in the Startup Configuration menu of the BIOS Utility. (See "Startup Configuration" on page 21.)
- The screen image in Windows can be expanded by following these steps:
  1. Click **Start**.

## *Attaching an external monitor*

2. Move the cursor to **Settings**; then click **Control Panel**.
3. Double-click **Display**.
4. Click the **LynxEM** tab.
5. Click the **ON** radio button for the "Stretch" feature in the Special Modes section.

However, the image might look slightly distorted.

## Display modes

The ThinkPad i Series 1200/1300 computer has an LCD that supports an XGA (1024x768 resolution) video mode or an SVGA (800x600 resolution) video mode. The following table shows the various display modes (resolution and color depth) available with your computer or external monitor. Use this table to set the display output (**LCD Panel Only**, **External monitor** or **Both**).

**Note:** When installing an operating system, you must install the display driver supplied with the computer to use SVGA mode.

- Display output on the LCD, or both on the LCD and external monitor (**LCD Panel Only** or **Both**).

**Note:** When using the **Both** setting, the external monitor must use the LCD resolution and refresh settings regardless of what resolution the LCD is set to display.

| Resolution   | Supported Color Depth       |
|--|-----------------------------|
| 640x480 (VGA)  | 256, 65,536, and 16,777,216 |
| 800x600 (SVGA)   | 256, 65,536, and 16,777,216 |
| 1024x768 (XGA)<br>(available only for models with a 13.3-inch TFT LCD) | 256, 65,536, and 16,777,216 |

- Display output only on the external monitor (**External monitor**).

## Attaching an external monitor

| Resolution       | Supported Color Depth                        | Frame Rate                    |
|------------------|--|-------------------------------|
| 640x480 (VGA)    | 256  | 60 Hz, 70 Hz, 75 Hz, or 85 Hz |
|                  | 65,536                                       |                               |
|                  | 16,777,216                                   |                               |
| 800x600 (SVGA)   | 256  | 60 Hz, 70 Hz, 75 Hz, or 85 Hz |
|                  | 65,536                                       |                               |
|                  | 16,777,216                                   |                               |
| 1024x768 (XGA)   | 256  | 60 Hz, 70 Hz, or 75 Hz        |
|                  | 65,536                                       |                               |
|                  | 16,777,216 (available only on select models) |                               |
| 1280x1024 (SXGA) | 256  | 43 Hz                         |
|                  | 65,536                                       |                               |
|                  | 16,777,216                                   |                               |

### Notes:

1. The resolution and color depth you can set depends on your external monitor.
2. If you are using an old external monitor, the resolution and color depth might be limited.

## Using the dual display function

Windows 98 and Windows 2000 support a function named *Multiple Display Support*, and your computer supports a function named *dual display* in the Windows environment. This function allows the Windows desktop to display output on the LCD-CRT display pair. You can display different desktop images on each monitor.

To enable dual display, do as follows:

1. Attach the computer to an external monitor (CRT).
2. Click **Start**.
3. Move the cursor to **Settings** and **Control Panel**; then click **Control Panel**.



### *Attaching an external monitor*

4. Double-click **Display**.
5. Click the **Settings** tab.
6. Click the Monitor-2 icon (for the secondary display, the CRT).
7. Click **Yes** to enable monitor 2 (if disabled).
8. Click the Monitor-1 icon (for the primary display, the LCD).
9. Select the color depth and the resolution of the primary display.
10. Click the Monitor-2 icon (for the secondary display, the CRT).
11. Select the color depth and the resolution of the secondary display.
12. Set the relative position of each monitor by dragging its icon.

**Note:** You can set the monitors in any relative position, but the icons must touch each other.

### *Disabling dual display*

1. Click **Start**.
2. Move the cursor to **Settings** and **Control Panel**; then click **Control Panel**.
3. Double-click **Display**.
4. Click the **Settings** tab.
5. Click the Monitor-2 icon (for the secondary display, the CRT).
6. Clear the **Extend my Windows desktop onto this monitor** check box.

The secondary display (monitor 2) is disabled.

### *Considerations when using dual display*

- You can select up to 64K colors for your secondary display.
- You can select a resolution up to 1024x768 for your secondary display.
- If you want to show DOS full screen, the secondary display shuts off. When you exit from the DOS full screen mode, the secondary display returns.

### *Attaching an external monitor*

- You cannot use the **Fn+F7** (display switching) function when you are in dual display mode.

## Attaching a printer

Any parallel printer with the standard Centronics\*\* interface can be attached to the 25-pin, parallel connector at the rear of the computer.

1. Attach the printer as shown.

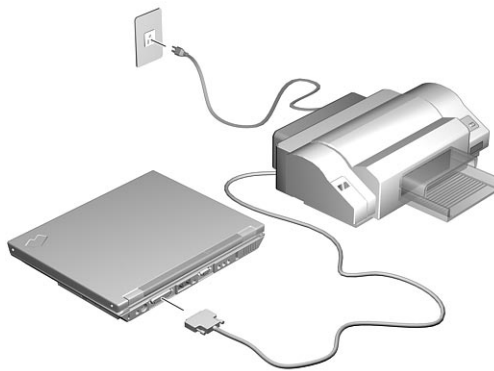

2. Turn on the printer.

## *Inserting a PC Card*

# Inserting a PC Card

This section describes how to prepare to use a PC Card.



Your computer has one PC Card slot and supports the following types of cards:

- PC Card (Type I, Type II, and Type III)
- CardBus
- Zoomed Video (ZV)

To install a PC Card in your computer, do the following:

1. Find the notched edge (1) of the PC Card as shown.

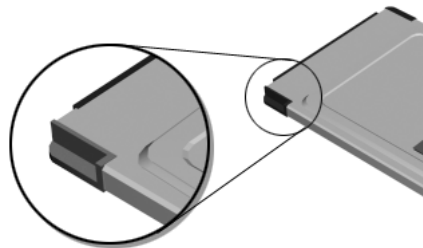

2. Insert the PC Card into the PC Card slot.

## Inserting a PC Card



3. Press the PC Card firmly into the connector.

A window appears and informs you about the new card.

**Note:** If you have not installed the PC Card driver, Windows 98 starts "PCMCIA Card Services Wizard" to install it. Follow the instructions on the screen.

You have completed setting up the PC Card, and you can now use it. For more information on how to use the PC Card software, refer to Windows help.

## Removing the PC Card

Before removing a PC Card, **you must stop it**. Otherwise, the system might freeze or data might be corrupted or lost.

1. Stop the card.

To stop the PC Card, find the PC Card icon on the right side of the taskbar; then click the icon and click **Stop**. For more information, see the *Online User's Guide*.

2. Press the PC Card eject button to pop out the button. Then press it again until the PC Card pops out.
3. Remove the PC Card and store it safely for future use.

## ***Inserting a PC Card***

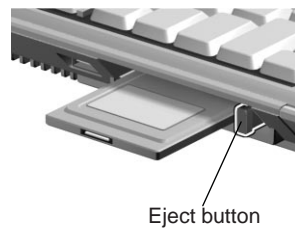

For more information on using a PC Card, see the *Online User's Guide*.

## Protecting your computer

---

This chapter provides information about how to protect your computer from theft or unauthorized use.

|  |    |
|--|----|
| Using passwords . . . . .                  | 74 |
| Setting a password . . . . .               | 75 |
| Entering a password . . . . .              | 77 |
| Removing and changing a password . . . . . | 78 |
| Using locks . . . . .                      | 80 |

## Using passwords

The password-setting feature helps to prevent your computer from being used by others. Once you set a password, a prompt appears on the screen each time you turn on the computer. You must enter your password at the prompt. You cannot use the computer unless you type the correct password. You can set the following passwords on your computer:

- Power-on password

Set the power-on password to protect your computer from use by another person. It provides the following security features:

- You need to type the power-on password at startup.
- You need to type the power-on password when resuming from hibernation mode.

Therefore, unauthorized users cannot use your computer.

- Setup password

Set the setup password to prevent unauthorized changes to your computer's configuration. It provides the following security features:

- You need to type the setup password to access the BIOS Utility.
- You need to type the setup password to access the Notebook Manager in Windows.
- You need to type the setup password before you can flash (update) the BIOS.

Therefore, unauthorized users cannot make changes to your computer's configuration.

- Hard disk password

The hard disk password provides an extra measure of security. Even if you set a power-on password, another user can remove the hard disk drive in your computer and put it in a different computer to access your data. If you set a hard disk password, however, another person cannot access the data on your hard



## *Using passwords*

disk without knowing the password. It provides the following features:

- You need to type the hard disk password at startup.
- If the hard disk drive is moved to another computer, the hard disk password must be typed at startup. Therefore, unauthorized users cannot access your hard disk even if the drive is removed from the computer.
- The hard disk password is required when the computer resumes from hibernation mode.

**Note:** If an incorrect hard disk password is entered three times, the system halts.

- Other password

Some Microsoft operating systems provide special Windows passwords. Refer to that system's user's guide for information on how to set, change, and use these passwords.

### **Do Not Forget Your Password**

If you forget your setup password, you have to take your computer to an IBM reseller or IBM marketing representative to have the password reset. Proof of purchase is required, and an additional charge might be required for the service.

**Attention:** If you forget your hard disk password, you can no longer access the hard disk. The password cannot be reset and you will lose all data and files on the hard disk. To use the computer, you will need to replace the hard disk. This replacement will incur expenses for parts and labor.

## **Setting a password**

To set a password, do the following:

1. Restart the computer.
2. As the ThinkPad logo is being displayed, the following lines appear:

Press F1 for IBM BIOS Setup Utility

Press F12 to choose temporary devices

## Using passwords

Press **F1**.

3.

The BIOS Utility menu appears.

4. Select **System Security** and press **Enter**. The "System Security" submenu appears:

| System Security          |          | Page 1/1 |
|--------------------------|----------|----------|
| Setup Password .....     | [ None ] |          |
| Power-on Password .....  | [ None ] |          |
| Hard Disk Password ..... | [ None ] |          |

↑↓ = Move highlight bar, ←→ = Change setting, F1 = Help

- **Setup Password** Selecting this displays a window for setting the setup password.
- **Power-On Password** Selecting this displays a window for setting the power-on password.
- **Hard Disk Password** Selecting this displays a window for setting the hard disk password.

5. Select the type of password you want to set, and press the left/right arrow key. The set password box appears.



6. Type your desired password and press **Enter**.

**Note:** You can type a maximum of seven random characters using a combination of letters (A to Z) and numbers (0 to 9).

## Using passwords

9). Uppercase and lowercase letters (for example, A and a) are treated as the same character.

If you type a wrong character, use the **Backspace** key to erase it and then type the correct one.

7. Type your password again and press **Enter** to verify it.

**Note:** Write down the password and keep it in a safe place.

### Do Not Forget Your Password

If you forget your setup password, you have to take your computer to an IBM reseller or IBM marketing representative to have the password reset. Proof of purchase is required, and an additional charge might be required for the service.

**Attention:** If you forget your hard disk password, you can no longer access the hard disk. The password cannot be reset and you will lose all data and files on the hard disk. To use the computer, you will need to replace the hard disk. This replacement will incur expenses for parts and labor.

## Entering a password

- Power-on Password

Once you set a power-on password, the power-on password

prompt (  ) appears at the top left corner of the screen each time you turn on your computer or when your computer returns from hibernation mode to normal operation.

### Notes:

1. When both power-on and hard disk passwords are set, the computer asks for the power-on password at boot-up and resume from hibernation mode.
2. When the power-on password is set, and you want to enter the BIOS Utility, you need to press **F1** immediately after correctly entering the power-on password.

- Setup Password

## Using passwords

Once you set a setup password, the setup password prompt (  ) appears at the top left corner of the screen when you press **F1** to enter the BIOS Setup Utility.

- **Hard Disk Password**

Once you set a hard disk password, the hard disk password prompt (  ) appears at the top left corner of the screen each time you turn on your computer or when your computer returns from hibernation mode to normal operation.

**Notes:**

1. When both power-on and hard disk passwords are set, the computer asks for the power-on password at boot-up and resume from hibernation mode.
2. When the hard disk password is set, and you want to enter the BIOS Utility, you need to press **F1** immediately after correctly entering the hard disk password.

To enter a password, do the following:

1. Type your password.

Don't hold down a key too long, because the same character will be entered continuously.

2. Press the **Enter** key.

An **X** appears if you enter the wrong password. If you fail to enter the correct password in three tries, you must press and hold the power switch for 5 seconds to turn off the computer, wait 5 seconds, and then turn it on again and retry.

## Removing and changing a password

To change or remove a password, do the following:

1. Restart the computer.
2. While the ThinkPad logo is being displayed, wait for the BIOS Utility prompt to appear.
  - If the power-on password or hard disk password is set, the corresponding password prompt appears. Enter the password correctly and press **Enter**. Then immediately press **F1** to enter the BIOS Utility.

## *Using passwords*

- If the setup password is set, the setup password prompt appears. Enter the setup password correctly and press **Enter**.

3. Select **System Security** and press **Enter**. The "System Security" submenu appears.

4. Select the type of password you want to change or remove, and press the left/right arrow key to remove the current password.

**Note:** If you want to change or remove the hard disk password, you need to enter the hard disk password correctly.

5. To set a new password, type your desired new password and press **Enter**.

If you do not want to set a new password, do not type anything in the password boxes.

6. Type your new password again and press **Enter** to verify it.

**Note:** Write down the password and keep it in a safe place.

**Note:** You can also set, remove and change the power-on and setup passwords using the Notebook Manager program. See "Notebook Manager" on page 26.

### **Do Not Forget Your Password**

If you forget your setup password, you have to take your computer to an IBM reseller or IBM marketing representative to have the password reset. proof of purchase is required, and an additional charge might be required for the service.

**Attention:** If you forget your hard disk password, you can no longer access the hard disk. The password cannot be reset and you will lose all data and files on the hard disk. To use the computer, you will need to replace the hard disk. This replacement will incur expenses for parts and labor.

## *Using locks*

# Using locks

You can attach a mechanical lock to your computer, to help to prevent it from being removed without your permission.

Attach a mechanical lock to the keyhole on the rear side of the computer; then secure the chain on the lock to a secure stationary object.



**Note:** You are responsible for evaluating, selecting, and implementing the locking devices and security features you choose to use. IBM makes no comments, judgments, or warranties about the function, quality, or performance of locking devices and security features.

## Solving computer problems

---

|   |     |
|---|-----|
| Frequently asked questions . . . . .                | 82  |
| Hints, tips and considerations . . . . .            | 87  |
| Troubleshooting guide . . . . .                     | 88  |
| Troubleshooting charts . . . . .                    | 89  |
| Error codes or messages . . . . .                   | 90  |
| No error codes or messages . . . . .                | 92  |
| Input problems . . . . .                            | 93  |
| Standby or hibernation problems . . . . .           | 95  |
| LCD problems . . . . .                              | 97  |
| Indicator problems . . . . .                        | 98  |
| Battery problems . . . . .                          | 98  |
| CD-ROM Problems . . . . .                           | 99  |
| Audio Problems . . . . .                            | 100 |
| Universal Serial Bus (USB) problems . . . . .       | 100 |
| Modem problems . . . . .                            | 101 |
| PC Card problems . . . . .                          | 102 |
| Printer problems . . . . .                          | 103 |
| External monitor problems . . . . .                 | 104 |
| Other option problems . . . . .                     | 106 |
| Software problems . . . . .                         | 107 |
| Other problems . . . . .                            | 108 |
| Recovering lost or damaged software . . . . .       | 109 |
| Using the PC-Doctor program . . . . .               | 109 |
| Using the ThinkPad Software Selections CD . . . . . | 109 |
| Using the Recovery CD . . . . .                     | 110 |
| ThinkPad Web site or Bulletin Board . . . . .       | 111 |

## Frequently asked questions

This section addresses frequently asked questions. Go to the page indicated in the following chart and do the specified action.

| <b>Questions</b>                            | <b>Page</b> |
|---|-------------|
| How to stop the screen from blanking        | 83          |
| How to switch the TrackPoint and mouse      | 83          |
| How to set the display resolution           | 83          |
| How to set the external monitor             | 84          |
| How to maximize the battery life            | 85          |
| How to install the operating system         | 85          |
| How to use the Recovery CD                  | 86          |
| How to test/troubleshoot installed hardware | 86          |
| How to restart the computer if it locks     | 86          |
| How to purchase accessories and upgrades    | 86          |
| How to get service                          | 86          |



## *Frequently asked questions*

---

### **My screen keeps blanking when I do not want it to. How do I stop this?**

You can change the power management timers with the Power Management Properties window.

1. Press **Fn+F2**.
2. Set a longer time-out value for "Turn off monitor".
3. Click **OK**.

---

### **How can I use an external mouse when I am at my desk, but then use the TrackPoint when I am away from my desk?**

#### **For a PS/2 mouse:**

Connect the PS/2 mouse. The TrackPoint is automatically disabled. To use the TrackPoint again, disconnect the PS/2 mouse.

#### **For a USB mouse:**

Connect the USB mouse.

**Note:** You can use the TrackPoint with an external USB mouse simultaneously.

---

### **Why do I not get the highest possible resolution out of my external monitor when I am using the LCD and external monitor at the same time?**

---

## Frequently asked questions

---

You can set any resolution for either the ThinkPad LCD or the external monitor. When you use both at the same time, the resolution of both is the same. If you set a higher resolution for the ThinkPad LCD, you can see only part of the screen at a time. You can see other parts by moving the image with the TrackPoint or other pointing device. You can change the display output type to the LCD, external monitor, or both with the **Switching Display Device** buttons of the Notebook Manager program or with **Fn+F7**.

You can set up the external monitor as follows:

1. Click **Start** and move the cursor to **Settings**; then click **Control Panel**.
2. Double-click **Display**.

The "Display Properties" window appears.

3. Click the **Settings** tab.
4. Click **Advanced...** button.
5. Click the **Monitor** tab.
6. Click the **Change...** button.
7. Select the **Model** and **Manufacturer** of your monitor.
8. Click **OK**; then **Close**.
9. Set the **Colors** and **Screen area** in the "Display Properties" windows.
10. Click **OK**.

---

**How can I set up the external monitor if the Windows plug-and-play feature does not detect it?**

---

## Frequently asked questions

---

If the external monitor you connected does not work properly, then the computer has not recognized the Plug and Play monitor. Do as follows:

1. Click **Start** and move the cursor to **Settings**; then click **Control Panel**.
2. Double-click **Display**.  
The "Display Properties" window appears.
3. Click the **Settings** tab.
4. Click **Advanced...** button.
5. Click the **Monitor** tab.
6. Make sure that **Automatically detect Plug & Play monitors** is checked.
7. If the option is checked and your monitor is still not recognized after you restart the computer, click the **Change** button.
8. Select the **Model** and **Manufacturer** of your monitor.
9. Click **OK**; then **Close**.
10. If you are prompted to restart your computer, click **OK**.

---

### How do I maximize battery life?

To maximize battery life, do the following:

- Use the battery pack until the charge is completely depleted (until the battery status LED flashes).
- Recharge the battery pack completely before using (the battery is fully charged when the AC Adapter is plugged in and the battery status LED is green).
- For a new battery pack or a battery pack that you have not used recently:
  1. Use the battery pack until the charge is completely depleted (until the battery status LED flashes).
  2. Recharge the battery pack completely before using the computer on battery power only (the battery is fully charged when the AC Adapter is plugged in and the battery status LED is green).
  3. Repeat steps 1 and 2 three times.
- For more detailed information about power management features, see the *Online User's Guide*.

---

### Where do I get the ThinkPad device drivers for this operating system?

---

## Frequently asked questions

---

See the *Online User's Guide* for information on installing device drivers. You can get the ThinkPad device drivers by using the ThinkPad Software Selections CD. Before installing a new operating system, do the following:

- Print the software installation section of the *Online User's Guide*.
- Make a Windows startup diskette.

---

### **How do I use the Recovery CD to reload my factory-installed ThinkPad operating system and applications?**

See "Using the Recovery CD" on page 110.

---

### **How do I test/troubleshoot my ThinkPad factory-installed hardware if I suspect a failure?**

See "Using the PC-Doctor program" on page 109.

---

### **How do I restart the computer if it locks, will not accept any input, or will not turn off using the power switch?**

See "Other problems" on page 108.

---

### **How do I purchase accessories and upgrades for my ThinkPad computer?**

Please visit our Web site at <http://www.ibm.com> and click on Shop IBM. Here you can find a variety of accessories and upgrades that can be purchased online to be used with your ThinkPad computer.

---

### **How do I arrange for service if I suspect my ThinkPad computer has a hardware problem?**

If you suspect there may be a hardware problem with a factory-installed device on your ThinkPad computer, you can test that device by running diagnostics (see "Using the PC-Doctor program" on page 109). If servicing the ThinkPad computer becomes necessary, this should be arranged by calling 1-800-772-2227 and speaking to a technical support representative who will make those arrangements for you.

---

## **Hints, tips and considerations**

This section provides hints, tips, and considerations.

- If you are using the Intel USB camera and the system resumes from standby mode, the USB camera is disabled. To enable it, unplug it and plug it in again.
- If the computer does not recognize your USB device, unplug and plug in the USB device. If your computer is in standby mode, your system might not recognize USB devices when operation resumes. Resume operation first, then plug in the USB device.
- If you want to use the scrolling or magnifying glass functions of the TrackPoint, you need to disconnect any external mouse and enable the internal TrackPoint.
- The microphone-in jack supports a self-battery-powered condenser microphone which might need a battery. See the instructions which come with the microphone.

## Troubleshooting guide

The PC-Doctor program is available on your computer to help you perform diagnostics tests on your computer. See “Using the PC-Doctor program” on page 109 for instructions on how to use the program.

---

**If a beep sounds, a message appears, or a function-related problem occurs:**

---

1. Find your symptom in the Troubleshooting Charts and try solving the problem. See “Troubleshooting charts” on page 89
2. If you can't solve the problem, note the error code and have the computer serviced. See “Getting service” on page 113

---

**If you accidentally lose or damage software in your computer:**

---

Recover it by using the ThinkPad Software Selections CD or the Recovery CD. See “Recovering lost or damaged software” on page 109

---

## Troubleshooting charts



If your computer has an error, it often displays a message or an error code, or a beep sounds when you power it on. Go through the charts and look for your problem. If you find the problem, go to the page indicated and do the specified action.

| <b>Troubleshooting Chart</b>        | <b>Page</b> |
|-------------------------------------|-------------|
| Error codes or screen messages      | 90          |
| No error codes or screen messages   | 92          |
| Input problems                      | 93          |
| Standby or hibernation problems     | 95          |
| LCD problems                        | 97          |
| Indicator problems                  | 98          |
| Battery problems                    | 98          |
| CD-ROM drive problems               | 99          |
| Audio problems                      | 100         |
| Universal serial bus (USB) problems | 100         |
| Modem problems                      | 101         |
| PC Card problems                    | 102         |
| Printer problems                    | 103         |
| External display problems           | 104         |
| Other option problems               | 106         |
| Software problems                   | 107         |
| Other problems                      | 108         |

## Troubleshooting charts

### Error codes or messages

**Note:** In the charts, x can be any character.

| Problem   | Action  |
|---|---|
| 006 (Equipment Configuration Error)<br>007 (Floppy Disk Controller Error)   | Restart the computer. If the problem persists, have the computer serviced.  |
| 070 (Real Time Clock Error)<br>071 (CMOS Battery Bad)   | Have the computer serviced.   |
| 072 (CMOS Checksum Error)   | Do as follows:<br>1. Enter the BIOS Setup Utility.<br>2. Load default settings and exit the BIOS Setup Utility.<br>If the problem persists, have the computer serviced.   |
| 110 (Incorrect password specified, system halted)   | Turn off the computer; then turn it on again. Type in the correct password. You cannot access the computer without the correct password. If you forget your password, have the computer serviced.   |
| 252 (VPD checksum error)  | Have the computer serviced.   |
| The power-on password prompt<br>  | If the power-on password prompt appears, a power-on password is set.<br>Type the correct password and press <b>Enter</b> to use the computer (see “Entering a password” on page 77).<br>If you still have a problem, have the computer serviced.  |
| The hard disk password prompt<br> | If the hard disk password prompt appears, a hard disk password is set.<br>Type the correct password and press <b>Enter</b> to use the computer (see “Entering a password” on page 77).<br><b>Attention:</b> If you forget your hard disk password, you can no longer access the hard disk. The password cannot be reset and you will lose all data and files on the hard disk. To use the computer, you will need to replace the hard disk. This replacement will incur expenses for parts and labor.<br>If you still have a problem, have the computer serviced. |

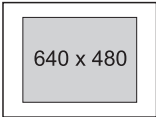

## Troubleshooting charts

| Problem   | Action   |
|---|--|
| <p>The setup password prompt</p>             | <p>If the setup password prompt appears when you press <b>F1</b> to access the BIOS Utility, a setup password is set.</p> <p>Type the correct password and press <b>Enter</b> to use the computer (see “Entering a password” on page 77).</p> <p><b>Attention:</b> If you forget your setup password, you have to take your computer to an IBM reseller or IBM marketing representative to have the password reset. Proof of purchase is required, and an additional charge might be required for the service.</p> <p>If you still have a problem, have the computer serviced.</p> |
| <p>The DOS full-screen looks smaller.</p>  | <p>When you use a DOS application that supports only the 640x480 resolution (VGA mode), the screen image might look slightly distorted or might appear smaller than the display size. This is to maintain compatibility with other DOS applications. This is not a defect.</p> <p>To expand the screen image to the same size as the actual screen, enter the BIOS Utility and enable the <b>Screen Expansion</b> parameter in the Startup Configuration menu. (The image might look slightly distorted.) See “Startup Configuration” on page 21.</p>                              |
| <p>The Windows startup screen does not fill the screen.</p>   | <p>When you enable <b>Screen Expansion</b> in the Startup Configuration menu of the BIOS Utility, the Windows startup screen expands but does not fill the entire screen. This is not a defect. (The image might look slightly distorted.) See “Startup Configuration” on page 21.</p>   |

## Troubleshooting charts

### No error codes or messages

| Problem   | Action  |
|---|---|
| <p>The screen is blank and you don't hear any beeps.</p> <p><b>Note:</b> If you are not sure whether you hear any beeps, turn the computer off; then turn it on again, and listen again. Also check the volume control and the power indicator.</p> <p>If you are using an external monitor, go to "External monitor problems" on page 104.</p> | <p>Make sure that:</p> <ul style="list-style-type: none"><li>• The battery pack is installed correctly.</li><li>• The AC Adapter is connected to the computer and the power cord is plugged into a working electrical outlet.</li><li>• The computer power is on. (Turn on the power switch again for confirmation.)</li></ul> <p>If a power-on password is set but does not appear, the brightness and/or contrast controls might be set to minimum levels. Adjust the brightness by pressing <b>Fn+Home</b> or <b>Fn+End</b>. For HPA models, try adjusting the contrast by pressing <b>Fn+Insert</b> or <b>Fn+Delete</b></p> <p>If the screen still remains blank, have the computer serviced.</p> |
| <p>The screen is blank and you hear a continuous beep, or two or more beeps.</p>  | <p>Have the computer serviced.</p>  |
| <p>The computer cannot boot-up.</p> <p>The message "Insert system diskette and press Enter key to reboot" appears.</p>  | <p>Have in hand a bootable diskette, such as the Windows startup diskette, and do as follows:</p> <ol style="list-style-type: none"><li>1. Turn off the computer.</li><li>2. Connect the external USB diskette drive.</li><li>3. Insert the bootable diskette into the diskette drive.</li></ol> <p>The Windows startup diskette can help diagnose the problem. If the problem remains, have the computer serviced.</p>   |

## Input problems

| Problem   | Action   |
|---|--|
| The cursor does not move after the computer awakens from one of the power management modes. | Make sure you followed the instructions in the <i>Online User's Guide</i> correctly if you reinstalled Windows 98.   |
| All or some keys on the keyboard do not work.   | <ul style="list-style-type: none"> <li>• If the problem occurred immediately after the computer returned from hibernation mode, enter the power-on password if it set.</li> <li>• If an external keyboard is connected, the numeric keypad on your computer will not work. This is not a defect.</li> <li>• If an external numeric keypad or a mouse is connected:               <ol style="list-style-type: none"> <li>1. Turn off the computer.</li> <li>2. Remove the external numeric keypad or the mouse.</li> <li>3. Turn on the computer and try using the keyboard again.</li> </ol> </li> </ul> <p>If the keyboard problem is solved, check the connection of the external numeric keypad, external keyboard, or mouse.</p> <p>If you still have a problem, have the computer serviced.</p> |
| The cursor drifts when the computer is turned on or after it resumes normal operation.      | <p>The cursor might drift when you are not using the TrackPoint during normal operation. This is a normal characteristic of the TrackPoint and is not a defect. Cursor drifting might occur for several seconds under the following conditions:</p> <ul style="list-style-type: none"> <li>• When the computer is turned on.</li> <li>• When the computer resumes normal operation.</li> <li>• When the TrackPoint is pressed for a long time.</li> <li>• When the temperature changes.</li> </ul>   |
| The mouse or pointing device does not work.   | <ul style="list-style-type: none"> <li>• Make sure that the mouse or pointing-device cable is securely connected to the computer.</li> <li>• Try using the TrackPoint. If the TrackPoint works, the error might be due to the mouse.</li> </ul> <p><b>Note:</b> See the manual supplied with the mouse for more information.</p>   |
| The mouse buttons do not work.  | Reinstall the PS/2 TrackPoint driver. See the <i>Online User's Guide</i> for instructions on how to install the driver.  |

## Troubleshooting charts

| Problem  | Action  |
|--|---|
| The scrolling or Magnifying Glass function does not work.    | See the General tab page in "Mouse Properties", and make sure that the PS/2 TrackPoint driver is loaded.<br><b>Note:</b> The TrackPoint functions work only with the TrackPoint.  |
| A number appears when you type a letter.                     | The numeric lock function is on. To disable it, press and hold <b>Shift</b> ; then press <b>NumLk</b> .   |
| All or some keys on the external numeric keypad do not work. | Make sure that the external numeric keypad is correctly connected to the computer.  |
| All or some keys on the external keyboard do not work.       | To use an external keyboard, you can attach it to the computer either directly or through the keyboard/mouse cable. Make sure that: <ul style="list-style-type: none"> <li>• The keyboard cable is correctly connected to the computer (if the keyboard is connected directly to the computer).</li> <li>• The keyboard/mouse cable is correctly connected to the computer.</li> <li>• The keyboard cable is connected to the correct side of the keyboard/mouse cable.</li> </ul> If these items are correct, disconnect the keyboard/mouse cable from the computer and make sure that the operation of the system keyboard is correct. If the system keyboard works, have the keyboard/mouse cable or the external keyboard serviced. |
| The internal numeric keypad does not work.                   | If you connect an external numeric keypad or an external keyboard with a numeric keypad, the internal numeric keypad is disabled. Use the external numeric keypad instead.  |
| All or some of the Fn key functions do not work.             | If Notebook Manager is active, the Fn key functions related to Display Device ( <b>Fn+F7</b> , <b>Fn+Home</b> , <b>Fn+End</b> , <b>Fn+Insert</b> , and <b>Fn+Delete</b> ) are disabled.<br><b>Notes:</b> <ol style="list-style-type: none"> <li>1. <b>Fn+Insert</b> and <b>Fn+Delete</b> are available only for HPA models.</li> <li>2. The sleep key function (<b>Fn+F4</b>) is available on the external keyboard by pressing <b>Ctrl+Alt+F4</b>.</li> </ol>  |

## Standby or hibernation problems

| Problem  | Action  |
|--|---|
| The computer enters standby mode automatically.  | The computer enters standby mode automatically when the processor temperature reaches a certain level. This is not a defect.  |
| Performance degrade when the computer gets hot during use.   | The processor speed might decrease under the following conditions: <ul style="list-style-type: none"> <li>• Use in a hot environment.</li> <li>• High-powered processing that requires high-power consumption.</li> </ul> This is not a defect.   |
| The computer enters standby mode immediately after POST (the standby indicator is on).                       | Make sure that: <ul style="list-style-type: none"> <li>• The battery pack is charged.</li> <li>• The AC Adapter is connected to the computer.</li> <li>• The operating temperature is within the acceptable range. Refer to Appendix A, "Features and specifications" on page 123.</li> </ul> If these items are correct, have the computer serviced.   |
| The computer turns on and immediately turns off.   | The battery pack power is getting low. Connect the AC Adapter to the computer, or replace the battery pack with a fully charged one.  |
| The computer does not return from standby mode, or the standby lamp stays on and the computer does not work. | The computer automatically enters standby or hibernation mode when the battery power is exhausted. Do one of the following: <ol style="list-style-type: none"> <li>1. Connect the AC Adapter to the computer.</li> <li>2. Replace the battery pack with a fully charged one; then press Fn.</li> </ol>  |
| The LCD is blank after resuming.   | Check if an external monitor was connected before the computer entered standby mode. <b>Do not disconnect the external monitor while the computer is in hibernation mode. If no external monitor is attached when the computer resumes, the LCD remains blank and output is not displayed. This restriction does not depend on the resolution value.</b>  |
| Your computer does not enter standby or hibernation mode.  | Check if the standby or hibernation options are set in the Power Management Properties window ( <b>Fn+F2</b> ).<br>Make sure the hibernation file is created. (See "Sleep Manager" on page 31.)<br><b>Note:</b> If a communication program is running, you cannot enter hibernation mode. To enter hibernation mode, stop the communication program, and then remove the PC Card or turn off power to the PC Card slot using the <b>Control Panel</b> . |

### **Troubleshooting charts**

| <b>Problem</b>   | <b>Action</b>   |
|--|---|
| When creating a hibernation file, Sleep Manager gives off a "Not Enough Space for Allocation" message. | <p>Sleep Manager needs enough, contiguous hard disk drive space to create and manage the hibernation file.</p> <p>Make sure the hard disk drive space is sufficient for Sleep Manager's requirements. This can be viewed from the Sleep Manager main screen. If there are still problems, there might not be enough contiguous free space to create the hibernation file. Use a disk defragmentation utility to solve the problem.</p> <p><b>Note:</b> Sleep Manager is available only in Windows 98.</p> |

## LCD problems

| <b>Problem</b>   | <b>Action</b>  |
|--|--|
| The screen is unreadable or distorted.   | <p>Make sure that the ThinkPad display driver is installed correctly:</p> <ol style="list-style-type: none"> <li>1. Click <b>Start</b> and move the cursor to <b>Settings</b>; then click <b>Control Panel</b>.</li> <li>2. Double-click <b>Display</b>.</li> <li>3. Select the <b>Settings</b> tab in the "Display Properties" window.</li> <li>4. Click <b>Advanced...</b>; then click the <b>Adapter</b> tab.</li> </ol> <p>Make sure that the display driver information is correct.</p> |
| Incorrect characters appear on the screen.   | <p>Did you install the operating system or application program with the correct procedure?</p> <p>If they are installed and configured correctly, have the computer serviced.</p>  |
| The screen stays on even after you power off the computer.   | <p>Push and hold the power switch for about five seconds; then release it to turn off your computer. Turn it on again.</p>   |
| Missing, discolored, or bright dots appear on the screen everytime you power on your computer (TFT model.) | <p>This is a characteristic of TFT technology. Your computer display contains multiple thin-film transistors (TFTs). A small number of missing, discolored, or bright dots on the screen might exist all the time.</p>   |

## Troubleshooting charts

### Indicator problems

| Problem  | Action  |
|--|---|
| The battery status indicator does not go on even though a battery pack is installed in the computer. | The over-current protection device inside the battery pack has been activated. Wait several hours and try again. If the indicator still does not go on, replace the battery pack or have the computer serviced. |

### Battery problems

| Problem  | Action  |
|--|---|
| The battery pack cannot be fully charged in 3.5 hours by the power-off charging method.  | The battery pack might be over-discharged. Do the following: <ol style="list-style-type: none"><li>1. Turn off the computer.</li><li>2. Make sure that the over-discharged battery pack is in the computer.</li><li>3. Connect the AC Adapter to the computer and let it charge.</li></ol> If the battery pack cannot be fully charged in 24 hours, use a new battery pack. |
| Your computer shuts down before the battery status indicator shows empty.<br><br><b>-or-</b><br>Your computer operates after the battery status indicator shows empty. | Repeat discharging and charging the battery pack at least three times.  |
| The computer does not operate with a fully charged battery pack.   | The over-current protective function in the battery pack might be activated. Turn off the computer and wait for several hours before you turn it back on again.   |



## CD-ROM Problems

| <b>Problem</b>   | <b>Action</b>   |
|--|---|
| The CD-ROM does not work.  | Make sure that: <ul style="list-style-type: none"><li>• The computer power is turned on and a compact disc is in the CD-ROM drive.</li><li>• The CD-ROM tray is firmly closed.</li><li>• The device drivers are correctly installed.</li></ul>  |
| You hear a noise from the CD-ROM when the disc is spinning.                    | The CD-ROM drive cover might be bent. Have the computer serviced.   |
| The CD-ROM tray does not open even if you press the CD-ROM drive eject button. | Insert a pin into the CD-ROM emergency eject hole and eject the CD-ROM tray.  |
| The compact disc cannot be read.   | Make sure that: <ul style="list-style-type: none"><li>• The compact disc is not dirty. If it is, clean it with a CD-ROM cleaner kit.</li><li>• The compact disc is not defective. If it is, try another compact disc.</li><li>• The compact disc is placed in the tray with the label side up.</li><li>• The compact disc format conforms with one of the following:<ul style="list-style-type: none"><li>– Music CD</li><li>– CD-ROM or CD-ROM XA</li><li>– Multisession photo CD</li><li>– Video CD</li></ul></li></ul> |

## Troubleshooting charts

### Audio Problems

| Problem           | Action   |
|-------------------|--|
| General problems. | <p>Problems may be due to such factors as:</p> <ul style="list-style-type: none"><li>• The audio volume control is not adjusted to the desired level.<br/>Press <b>Fn+PgUp</b> and <b>Fn+PgDn</b> to increase and decrease the volume respectively.</li><li>• The audio volume in Windows is muted or not adjusted to the desired level.<br/>Press <b>Fn+Backspace</b> to turn sounds off and on.</li><li>• The audio cable configuration is not correct for your application.</li><li>• The audio cable is defective.</li><li>• The audio equipment is defective.</li></ul> |

### Universal Serial Bus (USB) problems

| Problem  | Action  |
|--|---|
| A device connected to the USB connector does not work. | <ol style="list-style-type: none"><li>1. Make sure that the USB device is connected correctly.</li><li>2. Open the "Device Manager" window, and make sure that the USB device setup is correct, and that computer resource assignment and device driver installation are correct.<br/><b>Note:</b> To open the "Device Manager" window, click <b>Start</b> and move the cursor to <b>Settings</b> and click <b>Control Panel</b>. Double-click <b>System</b>; then click the <b>Device Manager</b> tab in the "System Properties" window.</li></ol> |
| The computer does not recognize your USB device.       | <p>Unplug and plug in the USB device.</p> <p><b>Note:</b> If your computer is in standby mode, your system might not recognize USB devices when operation resumes. Resume operation first, then plug in the USB device.</p>   |

## Modem problems

| Problem  | Action   |
|--|--|
| <p>Your modem application does not work with the ThinkPad modem.</p> | <p>Make sure that the internal modem port is enabled by opening the "Device Manager" window and running the Modem Wizard.</p> <p>If the modem does not work correctly, see the <i>Online User's Guide</i> and correct the resource conflict. If the modem works correctly, set the following modem settings by doing the following:</p> <ol style="list-style-type: none"> <li>1. Double-click <b>My Computer</b>, <b>Control Panel</b>, and <b>Modem</b>. The <b>Lucent Win Modem</b> is highlighted.</li> <li>2. Click <b>Properties</b>, <i>not</i> <b>Dialing Properties</b>.</li> <li>3. Click the <b>Connection</b> tab.</li> <li>4. If there is a check mark (✓) in the <b>Wait for dial tone before dialing</b> box, click and remove it.</li> <li>5. Click <b>Advanced</b>.</li> <li>6. If there is a check mark (✓) in the <b>Use error control</b> box, click and remove it.</li> <li>7. Add a check mark (✓) to the <b>Use flow control</b> box by clicking on the box and make sure that <b>Hardware (RTS/CTS)</b> is selected.</li> <li>8. Click <b>OK</b> to close the window.</li> <li>9. Click <b>OK</b> and return to the "Modem Properties" window.</li> <li>10. Click <b>Dialing Properties</b> and fill in all boxes and click either <b>Tone dialing</b> or <b>Pulse dialing</b>. <ul style="list-style-type: none"> <li><b>Note:</b> Most telephones today use tone dialing, where each button produces a different tone, instead of pulse dialing.</li> </ul> </li> <li>11. Click <b>OK</b>.</li> <li>12. Click <b>Close</b> to close the window.</li> <li>13. Close all active windows.</li> </ol> <p>Run your modem application again.</p> |

## Troubleshooting charts

### PC Card problems

| Problem  | Action   |
|--|--|
| The PC Card shows "Ready", but it does not work correctly.   | Make sure that: <ul style="list-style-type: none"><li>• The system resources reserved for the PC Card do not conflict with other system devices.</li><li>• Refer to "Resolving System Resource Conflicts" in the Online User's Guide.</li><li>• The resources reserved for the PC Card match the settings in the application program.</li><li>• If you are using a network card, check the I/O port address, IRQ level, and memory window address.</li></ul>   |
| A system resource conflict occurred when a PC Card was used.   | See "Resolving System Resource Conflicts" in the <b><i>Online User's Guide</i></b> .   |
| PC Card support software does not recognize your PC Card.  | Make sure that: <ul style="list-style-type: none"><li>• If the PC Card is not a modem, an ATA, a Flash, or an SRAM card, you have the proper client device driver for the card. In Windows, the PC Card must have an INF file associated with it.</li><li>• Your PC Card supports PCMCIA Release 2.0, 2.01, and 2.10. Refer to the manual that came with your PC Card. If your PC Card does not support those releases of PCMCIA, you cannot use the PC Card support software. Contact your PC Card supplier.</li><li>• Your PC Card is working by following the diagnostic instructions for your PC Card, if any.</li></ul> |
| The PC Card is recognized by PC Card support software, but the "Not Ready" or "Not Configured" message is shown. | Make sure that: <ul style="list-style-type: none"><li>• If the PC Card is not a modem, an ATA, a Flash, or an SRAM card, you have the proper client device driver for the card. In Windows, the PC Card must have an INF file associated with it.</li><li>• The resources for the PC Card are correctly reserved. Refer to "Resolving System Resource Conflicts" in the <b><i>Online User's Guide</i></b>.</li></ul>   |

## Printer problems

| Problem                    | Action  |
|----------------------------|---|
| The printer does not work. | <p>Make sure that:</p> <ul style="list-style-type: none"><li>• The parallel port is enabled.<ol style="list-style-type: none"><li>1. Save your work and quit any program you are using.</li><li>2. Shutdown and restart your computer.</li><li>3. While the ThinkPad logo is being displayed, wait for the BIOS Utility prompt to appear, then press <b>F1</b>.</li><li>4. Select <b>Onboard Devices Configuration</b> and press <b>Enter</b>.</li><li>5. Verify if the <b>Parallel Port</b> is enabled.</li><li>6. Save the changes and exit the BIOS Utility.</li></ol></li><li>• The printer is turned on and ready to print.</li><li>• The printer signal cable is connected to the correct connector of your computer.</li></ul> <p>If these items are correct and the printer still does not work, run the tests described in the printer manual. If the tests show that the printer is OK, have the computer serviced.</p> |

## Troubleshooting charts

### External monitor problems

| Problem   | Action  |
|---|---|
| The external monitor is blank.  | <p>Do the following:</p> <ol style="list-style-type: none"><li>1. Connect the external monitor to another computer and make sure it works.</li><li>2. Reconnect the external monitor to your computer.</li><li>3. Press <b>Fn+F7</b>.</li></ol> <p><b>Note:</b> You can also change the display output location using the Notebook Manager:</p> <ol style="list-style-type: none"><li>a. Start the Notebook Manager program.</li><li>b. Click the <b>Display Device</b> tab.</li><li>c. Click <b>External monitor</b> or <b>Both</b> radio button.</li><li>d. Click <b>OK</b>.</li></ol> <p>If nothing appears on the external monitor, have the computer serviced.</p>   |
| You cannot set a higher resolution than the present one on your external monitor. | <p>Make sure that:</p> <ul style="list-style-type: none"><li>• The ThinkPad display driver is installed correctly.<ol style="list-style-type: none"><li>1. Click <b>Start</b> and move the cursor to <b>Settings</b>; then click <b>Control Panel</b>.</li><li>2. Double-click <b>Display</b>.</li><li>3. Select the <b>Settings</b> tab in the "Display Properties" window.</li><li>4. Click <b>Advanced...</b>; then click the <b>Adapter</b> tab.</li></ol><p>Make sure that the ThinkPad display driver is installed.</p><p>If you are not sure that the ThinkPad display driver is installed correctly, reinstall it.</p></li><li>• An appropriate display type is selected.<ol style="list-style-type: none"><li>1. Click <b>Start</b> and move the cursor to <b>Settings</b>; then click <b>Control Panel</b>.</li><li>2. Double-click <b>Display</b>.</li><li>3. Make sure the settings in the "Display Properties" window are correct.</li><li>4. Click <b>OK</b> to close the window.</li></ol></li></ul> |

## Troubleshooting charts

| Problem                                | Action   |
|--|--|
| The screen is unreadable or distorted. | <p>Make sure that:</p> <ul style="list-style-type: none"><li>• The ThinkPad display driver is installed correctly.<ol style="list-style-type: none"><li>1. Click <b>Start</b> and move the cursor to <b>Settings</b>; then click <b>Control Panel</b>.</li><li>2. Double-click <b>Display</b>.</li><li>3. Select the <b>Settings</b> tab in the "Display Properties" window.</li><li>4. Click <b>Advanced...</b>; then click the <b>Adapter</b> tab.<p>Make sure that the ThinkPad display driver is installed.</p></li></ol></li></ul> <p>If you are not sure that the ThinkPad display driver is installed correctly, reinstall it.</p> <ul style="list-style-type: none"><li>• The display is set correctly.<ol style="list-style-type: none"><li>1. Click <b>Start</b> and move the cursor to <b>Settings</b>; then click <b>Control Panel</b>.</li><li>2. Double-click <b>Display</b>.</li><li>3. Make sure the settings in the "Display Properties" window are correct.</li><li>4. Click <b>OK</b> to close the window.</li></ol></li></ul> <p>If the settings are correct, run the tests described in the manual supplied with the external monitor. If the tests show that the external monitor is OK, have the computer serviced.</p> |
| Wrong characters appear on the screen. | <p>Did you install the operating system or application program with the correct procedure?</p> <p>If you did, have the external monitor serviced.</p>  |

## Troubleshooting charts

### Other option problems

| Problem  | Action  |
|--|---|
| An IBM option that you just installed does not work. | <p>Make sure that:</p> <ul style="list-style-type: none"><li>• The option is designed for your computer.</li><li>• The option was installed following the instructions supplied with the option or this book.</li><li>• Other installed options or cables are not loose.</li><li>• There is no I/O address or interrupt level (IRQ) DMA channel conflict. To see the system resource status, double-click Device Manager from the Control Panel. (See also "Resolving System Resource Conflicts" in the <i>Online User's Guide</i>).</li></ul> <p>If the test program for the option did not find the problem, have the computer and option serviced.</p> |
| An IBM option that used to work no longer works.     | <p>Make sure that:</p> <ul style="list-style-type: none"><li>• The option is securely connected to your computer.</li><li>• If the option came with its own test instructions, use those instructions to test the option.</li><li>• There is no system resource conflict (see "Resolving System Resource Conflicts" in the <i>Online User's Guide</i>).</li></ul> <p>If these items are correct and the test program did not find the problem, have the computer and the option serviced.</p>   |



## Software problems

| Problem                                | Action   |
|--|--|
| An application does not run correctly. | <p>Check the following to make sure that the problem is not being caused by the application:</p> <ul style="list-style-type: none"><li>• Your computer has the minimum required memory to run the application. Refer to the manuals supplied with the application.</li><li>• The application is designed to operate with the Windows operating system.</li><li>• Other applications run correctly on your computer.</li><li>• The necessary device drivers are installed. See the <i>Online User's Guide</i>.</li><li>• The application works OK when it is run on some other computer.</li></ul> <p>If an error message appears when you are using the application program, refer to the manuals supplied with the application. If these items are correct and you still have a problem, contact your place of purchase or the service representative for help.</p> |
| The Windows Safe Mode screen appears.  | <p>Your computer may not have shutdown properly the last time. In Safe Mode, shutdown and restart your computer.</p> <p>If you still have a problem, contact your place of purchase or the service representative for help.</p>  |

## Troubleshooting charts

### Other problems

| Problem   | Action  |
|---|---|
| The computer locks or does not accept any input.            | <ul style="list-style-type: none"><li>• Push and hold the power switch for about five seconds, then release it to turn off the computer. Restart the computer.</li></ul>  |
| The computer does not turn off with the power switch.       | <p>If the standby lamp is on and you are working under battery power, change the battery to a fully charged one or change your power source to ac power.</p> <p>If you still have a problem, push and hold the power switch for about five seconds, then release it to turn off the computer. Restart the computer.</p> |
| The computer does not start from a diskette.                | Make sure that the startup sequence in the BIOS Utility is set so that the computer starts up from the diskette drive (see "Startup Configuration" on page 21).   |
| Performance degrades when the computer gets hot during use. | <p>The processor speed might decrease under the following conditions:</p> <ul style="list-style-type: none"><li>• Use in a hot environment</li><li>• High-powered processing that requires high-power consumption</li></ul> <p>This is not a defect.</p>  |

## Recovering lost or damaged software

### Recovering lost or damaged software

This section describes how to recover lost or damaged software. The following table shows what is needed to recover your system.

| Problem   | Tools Provided                           | For More Information   |
|---|--|--|
| You need to diagnose the computer.                                      | Use the PC-Doctor** program.             | See "Using the PC-Doctor program" for general information.   |
| You need to recover a lost or damaged device driver.                    | Use the ThinkPad Software Selections CD. | See "Using the ThinkPad Software Selections CD" for general information. The CD-ROM also contains online help for detailed instructions. |
| You need to recover (reinstall) a lost or damaged software application. | Use the ThinkPad Software Selections CD. | See "Using the ThinkPad Software Selections CD" for general information. The CD-ROM also contains online help for detailed instructions. |
| You need to recover your entire hard disk.                              | Use the Recovery CD.                     | See "Using the Recovery CD" on page 110 for general information.   |

#### Using the PC-Doctor program

The PC-Doctor program allows you to run diagnostics tests on your computer. You have the option to run test sets, or individual tests. To run PC-Doctor, do as follows:

1. Click **Start**.
2. Move the cursor to **Programs, PC-Doctor**; then click **PC-Doctor for Windows**.
3. Follow the instructions on the screen.

#### Using the ThinkPad Software Selections CD

The ThinkPad Software Selections CD is provided for your installation convenience. If you need to reinstall a software application or a hardware device driver, put the ThinkPad Software Selections CD in your CD-ROM drive. The menu of the features appears automatically.

## ***Recovering lost or damaged software***

Your Software Selections CD contains telephone numbers for some software vendors. These vendors can help you with questions about their software. See the CD for details.

The following features are included:

- **Welcome**

This main page describes the Software Selections CD and its features.

- **Install Software**

Use this page to do the following:

- Reinstall a software application
- Reinstall hardware device drivers

- **Uninstall Software**

Use this page to remove software installed on your computer.

- **Advanced Functions**

Use this page to do the following:

- Change language and location settings for the ThinkPad Software Selections program.
- Create a Software Selections CD image on your computer.

- **Read the License Agreement**

This page contains the license agreement for using the ThinkPad Software Selections CD.

- **Help**

Use this page to learn how to use the ThinkPad Software Selections program.

## **Using the Recovery CD**

You can restore the contents of your hard disk to what it was at the time of purchase.

**Attention:** The Recovery program erases your entire hard disk, including the operating system, software, and personal data. It then

## ***Recovering lost or damaged software***

restores your operating system and hard disk to its factory-shipped configuration.

The Recovery CD consists of the original preinstalled software and device drivers.

The recovery process might take up to 2 hours.

Your computer supports startable (or bootable) CDs. To use the Recovery CD, do as follows:

1. Insert the Recovery CD into the CD-ROM drive.
2. Power off the computer; then turn on the computer.

### **Notes:**

- a. Make sure that the boot priority for CD-ROM is higher than the hard disk drive. See "Startup Configuration" on page 21.
  - b. While the ThinkPad logo is being displayed, the message "Press F12 to choose temporary device" appears. Press **F12** and select CD-ROM.
3. Follow the instructions on the screen.
  4. When a completion message appears, remove the Recovery CD from the CD-ROM drive.
  5. Restart the computer.

The computer restarts with the preinstalled configuration.

## **ThinkPad Web site or Bulletin Board**

IBM supplies all of the latest hardware device drivers and system BIOS for your computer on the ThinkPad Web site at:

**<http://www.pc.ibm.com/support>**

You can also use the IBM bulletin board service.

For more information about online support services, see "Online support services" on page 116.



## Getting service

---

### Preparations

If you need further assistance, you can call your IBM reseller or IBM marketing representative.

You will need to know the following information when requesting repair service:

- Identification number of your computer
- Options installed in your system

**Note:** Use the record sheet on "Option list" on page 114.

- Error message or problem

**Note:** Error messages can help identify which service action is required and help the service representative provide quick and efficient service.

Use the record sheet on "Problem recording sheet" on page 115.

### About Your Warranty

During the warranty period, you might be responsible for repair costs if the product damage was due to misuse, accident, modification, unsuitable physical or operating environment, or improper maintenance.

For full information on product warranties, see Appendix B, "Product warranties and notices" on page 129.

For your convenience, write the service phone numbers here:

---

---

*Information on your computer*

## Information on your computer

### Option list

- |   |                                       |
|---|---------------------------------------|
| <input type="checkbox"/> DIMM                     | <input type="checkbox"/> PC Cards     |
| _____ MB  | _____                                 |
| _____ MB  | _____                                 |
| <input type="checkbox"/> _____ GB Hard Disk Drive | <input type="checkbox"/> Battery Pack |

### Identification numbers

The serial number label is on the bottom of your computer. Write down the machine type and serial number (S/N) in the following box.

|                     |                             |
|---------------------|-----------------------------|
| IBM Product Name    | ThinkPad i Series 1200/1300 |
| Machine Type        | 1611-/1711-_____            |
| Serial Number (S/N) | _____                       |

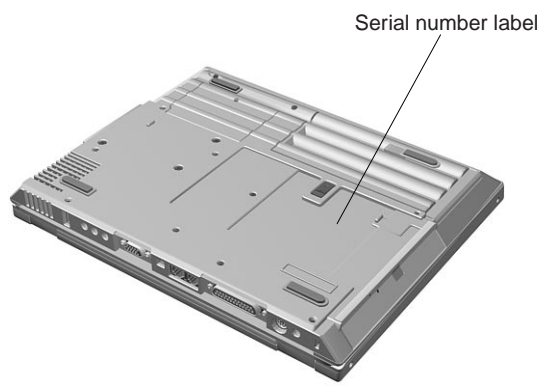



## **Problem recording sheet**

- Computer information:

Machine type: \_\_\_\_\_

Serial number: \_\_\_\_\_

Date of purchase: \_\_\_/\_\_\_/\_\_\_

- Type of problem:

Continuous problem

Intermittent problem

- Error code:

- The operating system and its version number, if available:

Windows 98 Version \_\_\_\_\_

Windows 2000 Version \_\_\_\_\_

- Application programs running at the time of the problem:

---

---

- Problem symptom:

Describe the problem more specifically:

---

---

---

- Can the problem be reproduced?

Yes

No

If yes, describe how it can be reproduced:

---

---

## **Customer service and support**

Purchasing an IBM PC hardware product entitles you to receive support and services during the limited warranty period. If you need additional support and services, a wide variety of extended solutions that addresses most needs are available for purchase.

### **Online support services**

You can contact us on the Internet for answers to your technical support questions. If you link to our support home page, you can search for technical tips, download update drivers, and find out about many other things. You can visit the site at the following URL:

**<http://www.pc.ibm.com/thinkpad>**

Personalized web-based site PC support provides PC users easy access to online support, including personalized IBM web site tailored to their machine type, computing environment, and individual interests such as business applications or games. Customers profile once with IBM and are thereafter greeted by name and presented targeted information selected specifically to meet their particular needs. For example, a corporate ThinkPad user might receive information on Microsoft Windows NT and remote connectivity. IBM customers can also elect to receive proactive e-mail, alerting them to time-saving hints and tips and product-specific update such as modem speed and BIOS files. Interactive web-based forums are monitored around the clock by IBM specialists, complementing its support on all the major internet service providers. You can set up your profile at:

**<http://www.pc.ibm.com/support>**

### **Fax information**

In the U.S. and Canada, if you have a touch-tone telephone and access to a fax machine, you can receive marketing and technical information on such topics as computer hardware, operating systems, and local area networks (LANs) by fax. You can call the IBM PC Company Automated Fax System 24 hours a day, 7 days a

## ***Customer service and support***

week. Follow the recorded instructions, and the information that you request will be sent to your fax machine.

To access the IBM PC Company Automated Fax System, call:

- In the U.S., 1-800-426-3395.
- In Canada, 1-800-465-3299.

## **Help by telephone**

You can get support and information by telephone during the limited warranty period at no additional charge, through the IBM PC Support Line. Experienced technical-support representatives will be on hand to assist you in answering any questions you might have, such as:

- How to set up your computer
- How to install and set up your IBM options purchased directly from IBM or through an IBM reseller
- How to use the 30-day support for the preloaded operating system
- How to get service

Please have the following information ready when you call:

- Serial number of your computer and proof of purchase
- Description of the problem
- Exact wording of the error message
- Hardware and software configuration information for your system

Before you call, run PC-Doctor diagnostics to help identify the cause of your computer problem. See "Using the PC-Doctor program" on page 109 for more information about PC-Doctor.

If possible, be at your computer when you call.

- In the U.S. and Puerto Rico, call 1-800-772-2227.
- In Canada, call 1-800-565-3344.

## ***Customer service and support***

These lines are available 24 hours a day, 7 days a week. The answering technical-support representative can also fax or mail you technical or product information, such as:

- Sales information
- Product brochures
- Locations of IBM resellers
- Services available from IBM

## **EasyServ**

ThinkPad EasyServ is a courier repair service for IBM mobile products whereby your ThinkPad computer will be picked up, sent to IBM for repair, and then returned to the location of your choice. This service is available at no additional charge during the limited warranty period. Most computers can be repaired the day that it arrives at the IBM repair location.

Support personnel first try to solve your problem over the phone. If they are unsuccessful, you can arrange for EasyServ service by calling the PC Support Line.

If possible, you should use the original ThinkPad shipping materials that your computer came in, for re-sending it to IBM. If the box is not available, the courier will deliver a shipping carton and will return later to pick it up. This service is available only in the U.S. and Canada.

## **Getting help around the world**

If you make frequent overseas trips or you are residing abroad, you can register with the International Warranty Service Office. The office will issue an International Warranty Service Certificate, which you can use wherever IBM or IBM resellers sell and service IBM PC products.

For more information on registering with the International Warranty Service Office, call 1-800-497-7426 in the U.S. or Canada.

## **Purchasing additional services**

During and after the limited warranty period, you can purchase additional services, such as:

- Support for IBM and non-IBM hardware, operating systems, and application programs
- Network setup and configuration
- Upgraded or extended hardware repair services
- Custom installation

The availability of the service and its name might vary by country.

## **Enhanced PC support line**

Enhanced PC Support is available for desktop and mobile IBM computers that are not connected to a network. Technical support is provided for IBM computers and IBM or non-IBM options, operating systems, and application programs on the supported products list. This service includes technical support for the following:

- Installing and configuring your out-of-warranty IBM computer
- Installing and configuring non-IBM options in IBM computers
- Assistance with the preloaded operating system
- Using selected application software and games
- Tuning performance, such as memory management
- Installing device drivers remotely
- Setting up and using multimedia devices
- Identifying system problems
- Interpreting documentation

You can purchase this service for a single incident or multiple incidents. For more information about purchasing Enhanced PC Support, see "Ordering support line services" on page 120.

## *Purchasing additional services*

### **Ordering support line services**

The Enhanced PC Support Line, Client Support Line, and Network and Server Support Line services are available for products on the Supported Products list.

To receive a Supported Products list:

- In the U.S.:
  - Call 1-800-772-2227.
  - Select the automated fax system option.
  - Select the service for which you would like a Supported Products list:
    - For the Enhanced PC Support Line, select document 11682.
    - For the Network and Server Support Line, select document 11683.
- In Canada
  - Call 1-800-465-7999 or 1-800-465-7999.
- In other countries, contact your IBM reseller or IBM marketing representative.

For more information on how to purchase the Support Line Services:

- In the U.S.: call 1-800-772-2227.
- In Canada: call 1-800-465-7999.
- In other countries, contact your IBM reseller or IBM marketing representative.

### **Warranty and repair services**

You can extend your period of ThinkPad EasyServ warranty service.

- In the U.S., for more information on warranty extensions, call 1-888-426-4343.

For more information on service offerings in the U.S. only, please refer to the following web page:

<http://www.pc.ibm.com/us/infobrf/ibserv1.html#info>

### ***Purchasing additional services***

- In Canada, for more information on warranty extensions: call 1-800-465-7999.
- In other countries, contact your IBM reseller or IBM marketing representative.

***Purchasing additional services***



## **Appendix A. Features and specifications**

---

This appendix describes the features and specifications for the computer.

## *Features*

# Features

### **Processor**

Intel® Mobile Celeron™ processor with on-die external cache

### **Memory**

Base: 32MB or 64MB

Option: 32/64/128MB DIMM

Total: Max. 192 MB

### **Storage devices**

2.5-inch hard disk drive

### **Display**

The color display uses TFT technology or HPA technology

Up to 1024-by-768 resolution on the 13.3-inch TFT LCD

Up to 800-by-600 resolution on the 12.1-inch TFT/HPA LCD or 13.0-inch HPA LCD

Up to 1280-by-1024 resolution on the external monitor

Brightness control

Contrast control (available only on HPA models)

### **Keyboard**

87-key, 88-key, or 92-key

TrackPoint

Easy Launch buttons

Fn key function

Windows keys

### **External diskette drive**

## **Features**

To get the best performance from your diskette drive, use high-quality diskettes (such as IBM diskettes) that meet or exceed the following standards:

### **1–MB, 3.5–inch, unformatted diskette:**

- ANSI (American National Standards Institute) X3.137
- ISO (International Standards Organization) 8860
- ECMA (European Computer Manufacturers Association) 100

### **2–MB, 3.5–inch, unformatted diskette:**

- ANSI X3.171
- ISO 9529
- ECMA 125

### **Internal CD-ROM drive**

24X max. speed

### **External interface**

Parallel connector (IEEE 1284A)

External-input-device connector (PS/2)

External-monitor connector

PC Card slot (one Type I, Type II, or Type III PC Card)

Headphone jack

Microphone jack (supports a self-battery-powered condenser microphone)

Stereo line-in jack

Universal Serial Bus (USB) connector (two)

Telephone connector

Network connector (Ethernet 10BaseT or 100BaseT) — available on select models

FireWire connector (IEEE 1394) — available on select models

## Specifications

# Specifications

### Size

Width: 310 mm (12.20 in.)

Depth: 250 mm (9.84 in.)

Height: 35 mm (1.38 in.)

### Environment

Temperature (at altitudes less than 2438 m 8000 ft.):

- Operating with no diskette: 5°C to 35°C (41°F to 95°F)
- Operating with a diskette: 10°C to 35°C (50°F to 95°F)
- Nonoperating: -20°C to 60°C (-4°F to 140°F)

**Note:** When you charge the battery pack, its temperature must be at least 10°C (50°F).

Relative humidity:

- Operating with no diskette: 8% to 95%
- Operating with a diskette: 8% to 80%

Maximum altitude: 3048 m (10000 ft.) in unpressurized conditions

- Maximum temperature at 3048 m (10000 ft.): 31.3°C (88°F)

### Heat output

Approximately 48 Kcal per hour

### Electrical (AC Adapter)

Sine-wave input, at 50 to 60 Hz is required

The input rating of the AC Adapter: 100–240 V ac, 50/60 Hz

### Battery Pack

Nickel Metal Hydride

- Nominal voltage: 9.6 V dc
- Capacity: 4.5 AH

## IBM power cords

To use the AC Adapter outside the country where you purchased your computer, you need an ac power cord that is certified for the country or region you are visiting. You can purchase one through an IBM authorized reseller or IBM marketing representative in that country or region.

**Attention:** Using an incompatible power cord might cause severe damage to your computer.

**For 2-pin power cords:**

| <b>IBM power cord part number</b> | <b>Used in these countries or regions</b>  |
|-----------------------------------|--|
| 13H5264                           | Bahamas, Barbados, Bermuda, Bolivia, Canada, Cayman Islands, Colombia, Costa Rica, Dominican Republic, Ecuador, El Salvador, Guatemala, Guyana, Haiti, Honduras, Jamaica, Korea (South), Mexico, Netherlands Antilles, Nicaragua, Panama, Peru, Philippines, Saudi Arabia, Suriname, Taiwan, Thailand, Trinidad (West Indies), United States of America, Venezuela |
| 13H5267                           | Abu Dhabi, Albania, Antigua, Bahrain, Brunei, Dubai, Fiji, India, Ireland, Kenya, Kuwait, Macao, Malaysia, Nigeria, Oman, People's Republic of China (including Hong Kong), Qatar, Singapore, United Kingdom   |
| 13H5270                           | Austria, Bosnia-Herzegovina, Belgium, Bulgaria, Chile, Croatia, Czech Republic, Denmark, Egypt, Finland, France, Germany, Greece, Hungary, Iceland, Indonesia, Israel, Italy, Macedonia, Netherlands, Norway, Poland, Portugal, Romania, Slovakia, Slovenia, Spain, Sweden, Switzerland, Turkey, Yugoslavia  |
| 13H5273                           | Japan  |
| 13H5276                           | Argentina, Australia, New Zealand, Papua New Guinea, Paraguay, Uruguay   |
| 13H5279                           | Bangladesh, Pakistan, South Africa, Sri Lanka  |

## IBM power cords

For 3-pin power cords:

**Note:** The grounded adapter is required for full MPRII compliance. If a 3-pin power cord came with your computer, see “Safety information” on page vii.

| IBM power cord part number | Used in these countries or regions  |
|----------------------------|---|
| 02K0539                    | People's Republic of China (other than Hong Kong)   |
| 76H3514                    | Argentina, Australia, New Zealand, Papua New Guinea, Paraguay, Uruguay  |
| 76H3516                    | Aruba, Bahamas, Barbados, Bermuda, Bolivia, Brazil, Canada, Cayman Islands, Colombia, Costa Rica, Curacao, Dominican Republic, Ecuador, El Salvador, Guatemala, Guyana, Haiti, Honduras, Jamaica, Korea (South), Liberia, Mexico, Netherlands Antilles, Nicaragua, Panama, Peru, Philippines, Saudi Arabia, Suriname, Taiwan, Thailand, Trinidad (West Indies), United States of America, Venezuela |
| 76H3518                    | Austria, Belgium, Bosnia-Herzegovina, Bulgaria, Croatia, Czech Republic, Egypt, Finland, France, Germany, Greece, Hungary, Iceland, Indonesia, Macao, Macedonia, Netherlands, Norway, Poland, Portugal, Romania, Slovakia, Slovenia, Spain, Sweden, Turkey, Yugoslavia  |
| 76H3520                    | Denmark   |
| 76H3522                    | Bangladesh, Myanmar, Pakistan, South Africa, Sri Lanka  |
| 76H3524                    | Abu Dhabi, Albania, Antigua, Bahrain, Brunei, Dubai, Fiji, Hong Kong, India, Ireland, Kenya, Kuwait, Malaysia, Nigeria, Oman, Qatar, Singapore, United Kingdom  |
| 76H3528                    | Liechtenstein, Switzerland  |
| 76H3530                    | Chile, Ethiopia, Italy, Libya   |
| 76H3532                    | Israel  |
| 76H3535                    | Korea   |

## Appendix B. Product warranties and notices

---

International Business Machines  
Corporation

Armonk, New York 10504

### Statement of Limited Warranty

*The warranties provided by IBM in this Statement of Limited Warranty apply only to Machines you originally purchase for your use, and not for resale, from IBM or your reseller. The term "Machine" means an IBM machine, its features, conversions, upgrades, elements, or accessories, or any combination of them. The term "Machine" does not include any software programs, whether pre-loaded with the Machine, installed subsequently or otherwise. Unless IBM specifies otherwise, the following warranties apply only in the country where you acquire the Machine. Nothing in this Statement of Limited Warranty affects any statutory rights of consumers that cannot be waived or limited by contract. If you have any questions, contact IBM or your reseller.*

**Machine:** IBM ThinkPad i Series 1200/1300 and the Battery Pack

**Warranty Period\*:** One Year

*\*Elements and accessories are warranted for three months. Contact your place of purchase for warranty service information. Some IBM Machines are eligible for On-site warranty service depending on the country where service is performed.*

### The IBM Warranty for Machines

IBM warrants that each Machine 1) is free from defects in materials and workmanship and 2) conforms to IBM's Official Published Specifications. The warranty period for a Machine is a specified, fixed period commencing on its Date of Installation. The date on your sales receipt is the Date of Installation, unless IBM or your reseller informs you otherwise.

During the warranty period IBM or your reseller, if approved by IBM to provide warranty service, will provide repair and exchange service for the Machine, without charge, under the type of service designated for the Machine and will manage and install engineering changes that apply to the Machine.

If a Machine does not function as warranted during the warranty period, and IBM or your reseller is unable to either 1) make it do so or 2) replace it with one that is at least functionally equivalent, you may return it to your place of purchase and your money will be refunded. The replacement may not be new, but will be in good working order.

#### **Extent of Warranty**

The warranty does not cover the repair or exchange of a Machine resulting from misuse, accident, modification, unsuitable physical or operating environment, improper maintenance by you, or failure caused by a product for which IBM is not responsible. The warranty is voided by removal or alteration of Machine or parts identification labels.

THESE WARRANTIES ARE YOUR EXCLUSIVE WARRANTIES AND REPLACE ALL OTHER WARRANTIES OR CONDITIONS, EXPRESS OR IMPLIED, INCLUDING, BUT NOT LIMITED TO, THE IMPLIED WARRANTIES OR CONDITIONS OF MERCHANTABILITY AND FITNESS FOR A PARTICULAR PURPOSE. THESE WARRANTIES GIVE YOU SPECIFIC LEGAL RIGHTS AND YOU MAY ALSO HAVE OTHER RIGHTS WHICH VARY FROM JURISDICTION TO JURISDICTION. SOME JURISDICTIONS DO NOT ALLOW THE EXCLUSION OR LIMITATION OF EXPRESS OR IMPLIED WARRANTIES, SO THE ABOVE EXCLUSION OR LIMITATION MAY NOT APPLY TO YOU. IN THAT EVENT, SUCH WARRANTIES ARE LIMITED IN DURATION TO THE WARRANTY PERIOD. NO WARRANTIES APPLY AFTER THAT PERIOD.

#### **Items Not Covered by Warranty**

IBM does not warrant uninterrupted or error-free operation of a Machine.



Unless IBM specifies otherwise, IBM provides non-IBM machines WITHOUT WARRANTIES OF ANY KIND.

Any technical or other support provided for a Machine under warranty, such as assistance via telephone with "how-to" questions and those regarding Machine set-up and installation, will be provided WITHOUT WARRANTIES OF ANY KIND.

### **Warranty Service**

To obtain warranty service for the Machine, you should contact your reseller or call IBM. In the United States, call IBM at **1-800-IBM-SERV (426-7378)**. In Canada, call IBM at **1-800-465-6666**. You may be required to present proof of purchase.

IBM or your reseller provides certain types of repair and exchange services, either at your location or at a service center, to keep Machines in, or restore them to, conformance with their Specifications. IBM or your reseller will inform you of the available types of service for a Machine based on its country of installation. IBM may repair the failing Machine based on its country of installation. IBM may repair the failing Machine or exchange it at its discretion.

When warranty service involves the exchange of a Machine or part, the item IBM or your reseller replaces becomes its property and the replacement becomes yours. You represent that all removed items are genuine and unaltered. The replacement may not be new, but will be in good working order and at least functionally equivalent to the item replaced. The replacement assumes the warranty service status of the replaced item.

Any feature, conversion, or upgrade, IBM or your reseller services must be installed on a Machine which is 1) for certain Machines, the designated, serial-numbered Machine and 2) at an engineering-change level compatible with the feature, conversion, or upgrade. Many features, conversions, or upgrades involve the removal of parts and their return to IBM. A part that replaces a removed part will assume the warranty service status of the removed part.

Before IBM or your reseller exchanges a Machine or part, you agree to remove all features, parts, options, alterations, and attachments not under warranty service.

You also agree to:

1. ensure that the Machine is free of any legal obligations or restrictions that prevent its exchange.
2. obtain authorization from the owner to have IBM or your reseller service a Machine that you do not own; and
3. where applicable, before service is provided
  - a. follow the problem determination, problem analysis, and service request procedures that IBM or your reseller provides,
  - b. secure all programs, data, and funds contained in a Machine,
  - c. provide IBM or your reseller with sufficient, free, and safe access to your facilities to permit them to fulfill their obligations, and
  - d. inform IBM or your reseller of changes in a Machine's location.

IBM is responsible for loss of, or damage to, your Machine while it is 1) in IBM's possession or 2) in transit in those cases where IBM is responsible for the transportation charges.

Neither IBM nor your reseller is responsible for any of your confidential, proprietary or personal information contained in a Machine which you return to IBM or your reseller for any reason. You should remove all such information from the Machine prior to its return.

### **Production Status**

Each IBM Machine is manufactured from new parts, or new and used parts. In some cases, the Machine may not be new and may have been previously installed. Regardless of the Machine's production status, IBM's appropriate warranty terms apply.

### **Limitation of Liability**

Circumstances may arise where, because of a default on IBM's part or other liability, you are entitled to recover damages from IBM. In each such instance, regardless of the basis on which you are entitled to claim damages from IBM (including fundamental breach, negligence, misrepresentation, or other contract or tort claim), IBM is liable for no more than:

1. damages for bodily injury (including death), and damage to real property and tangible personal property; and
2. the amount of any other actual direct damages, up to the greater of \$100,000 (or equivalent in local currency) or the charges (if recurring, 12 months' charges apply) for the Machine that is the subject of the claim.

This limit also applies to IBM's suppliers and your reseller. It is the maximum for which IBM, its suppliers, and your reseller are collectively responsible for.

UNDER NO CIRCUMSTANCES IS IBM LIABLE FOR ANY OF THE FOLLOWING: 1) THIRD-PARTY CLAIMS AGAINST YOU FOR LOSSES OR DAMAGES (OTHER THAN THOSE UNDER THE FIRST ITEM LISTED ABOVE); 2) LOSS OF, OR DAMAGE TO, YOUR RECORDS OR DATA; OR 3) ECONOMIC CONSEQUENTIAL DAMAGES (INCLUDING LOST PROFITS OR SAVINGS) OR INCIDENTAL DAMAGES, EVEN IF IBM, ITS SUPPLIERS OR YOUR RESELLER IS INFORMED OF THEIR POSSIBILITY. SOME JURISDICTIONS DO NOT ALLOW THE EXCLUSION OR LIMITATION OF INCIDENTAL OR CONSEQUENTIAL DAMAGES, SO THE ABOVE LIMITATION OR EXCLUSION MAY NOT APPLY TO YOU.

## Notices

## Notices

References in this publication to IBM products, programs, or services do not imply that IBM intends to make these available in all countries in which IBM operates. Any reference to an IBM product, program, or service is not intended to state or imply that only IBM's product, program, or service may be used. Any functionally equivalent product, program, or service that does not infringe any of IBM's intellectual property rights may be used instead of the IBM product, program, or service. Evaluation and verification of operation in conjunction with other products, except those expressly designated by IBM, are the user's responsibility.

IBM may have patents or pending patent applications covering subject matter in this document. The furnishing of this document does not give you any license to these patents. You can send license inquiries, in writing, to the IBM Director of Licensing, IBM Corporation, 500 Columbus Avenue, Thornwood, NY 10594, U.S.A.

## Year 2000 readiness and instructions

A product is Year 2000 Ready if the product, when used in accordance with its associated documentation, is capable of correctly processing, providing and/or receiving date data within and between the 20th and 21st centuries, provided all other products (for example, software, hardware, and firmware) used with the product properly exchange date data with it.

This IBM PC hardware product has been designed to process four-digit date information correctly within and between the 20th and 21st centuries.

This IBM PC product cannot prevent errors that might occur if software you use or exchange data with is not ready for the Year 2000. IBM software that comes with this product is Year 2000 Ready. However, software from other companies might come with this IBM PC product. Although IBM cannot take responsibility for the readiness of that software, these companies have stated that it is ready. You should contact the software developers directly if you wish to verify readiness, understand limitations, or look for any software updates.

## Notices

To learn more about IBM PC products and the Year 2000, visit our Web site at <http://www.pc.ibm.com/year2000>. The information and tools there can help you with your Year 2000 transition plan, especially if you have multiple IBM PCs. IBM encourages you to check periodically for updated information.

## Trademarks

The following terms, in this publication, are trademarks of the IBM Corporation in the United States or other countries or both:

IBM  
PS/2  
ThinkPad  
TrackPoint IV

Microsoft, Windows, Windows NT, and the Windows 95 flag logo are trademarks or registered trademarks of Microsoft Corporation.

Pentium®, Celeron™ and MMX™ are trademarks or registered trademarks of Intel Corporation in the U.S. and other countries.

FireWire™ is a trademark of Apple Computer, Inc.

Other company, product, and service names, which may be denoted by a double asterisk (\*\*), may be trademarks or service marks of others.

## Electronic emission notices

### *Federal Communications Commission (FCC) statement*

ThinkPad i Series 1200/1300

This equipment has been tested and found to comply with the limits for a Class B digital device, pursuant to Part 15 of the FCC Rules. These limits are designed to provide reasonable protection against harmful interference in a residential installation. This equipment generates, uses, and can radiate radio frequency energy and, if not installed and used in accordance with the instructions, may cause harmful interference to radio communications. However, there is no guarantee that interference will not occur in a particular installation. If this equipment does cause harmful interference to radio or television

## Notices

reception, which can be determined by turning the equipment off and on, the user is encouraged to try to correct the interference by one or more of the following measures:

- Reorient or relocate the receiving antenna.
- Increase the separation between the equipment and receiver.
- Connect the equipment into an outlet on a circuit different from that to which the receiver is connected.
- Consult an IBM authorized dealer or service representative for help.

Properly shielded and grounded cables and connectors must be used in order to meet FCC emission limits. Proper cables and connectors are available from IBM authorized dealers. IBM is not responsible for any radio or television interference caused by using other than recommended cables and connectors or by unauthorized changes or modifications to this equipment.

Unauthorized changes or modifications could void the user's authority to operate the equipment. This device complies with Part 15 of the FCC Rules. Operation is subject to the following two conditions: (1) this device may not cause harmful interference, and (2) this device must accept any interference received, including interference that may cause undesired operation.

Responsible party:

International Business Machines Corporation  
New Orchard Road  
Armonk, NY 10504  
Telephone 1-919-543-2193

 Tested To Comply  
With FCC Standards  
FOR HOME OR OFFICE USE

### *Canadian Department of Communications compliance statement*

This equipment does not exceed Class B limits per radio noise emissions for digital apparatus, set out in the Radio Interference Regulation of the Canadian Department of Communications.

## Notices

### *Avis de conformité aux normes du ministère des Communications du Canada*

Cet équipement ne dépasse pas les limites de Classe B d'émission de bruits radioélectriques pour les appareils numériques, telles que prescrites par le Règlement sur le brouillage radioélectrique établi par le ministère des Communications du Canada.

### *European Community Directive conformance statement*

This product is in conformity with the protection requirements of EC Council Directive 89/336/EEC on the approximation of the laws of the Member States relating to electromagnetic compatibility.

A declaration of Conformity with the requirements of the Directive has been signed by IBM United Kingdom Limited, PO BOX 30 Spango Valley Greenock Scotland PA160AH.

This product satisfies the Class B limits of EN 55022.

## Telecommunication notice

### *Federal Communications Communication (FCC) and Telephone Company Requirements (Part 68 of the FCC Rules)*

1. The Telephone Consumer Protection Act of 1991 makes it unlawful for any person to use a computer or other electronic device to send any message via a telephone fax machine unless such message clearly contains in a margin at the top or bottom of each transmitted page or on the first page of the transmission, the date and time it is sent, and an identification of the business or other entity, or other individual sending the message and the telephone number of the sending machine or such business, other entity, or individual. In order to program this information into your computer, you should be sure to follow the installation instructions for your fax software package.
2. The built-in modem is built into the ThinkPad computer. It complies with Part 68 of the FCC Rules. A label is affixed to the bottom of the computer that contains, among other things, the FCC registration number, USOC, and Ringer Equivalency Number (REN) for this equipment. If these numbers are requested, look at the label and provide this information to your telephone company.

## Notices

3. The REN is useful to determine the quantity of devices you may connect to your telephone line and still have those devices ring when your number is called. IN most, but not all, areas, the sum of the RENs of all devices should not exceed five (5.0). To be certain of the number of devices you may connect to you line, as determined by the REN, you should call your local telephone company to determine the maximum REN for your calling area.
4. If the built-in modem causes harm to the telephone network, the telephone company may discontinue your service temporarily. If possible, they will notify you in advance. But, if advance notice isn't practical, you will be notified as soon as possible. You will be advised of your right to file a complaint with the FCC.
5. Your telephone company may make changes in its facilities, equipment, operations, or procedures that could affect the proper operation of your equipment. If they do, you will be given advance notice so as to give you an opportunity to maintain uninterrupted service.
6. If you experience trouble with this built-in modem, contact your IBM Authorized Seller, or the IBM Corporation, 500 Columbus Avenue, Thornwood, NY 10594, 1-800-772-2227, for repair/warranty information. The telephone company may ask you to disconnect this equipment from the network until the problem has been corrected, or until you are sure the equipment is not malfunctioning.
7. No customer repairs are possible to the modem. If you experience trouble with this equipment, contact your Authorized Seller or the IBM Corporation for information.
8. The modem may not be used on coin service provided by the telephone company. Connection to party lines is subject to state tariffs. Contact your state public utility commission or corporation commission for information.
9. When ordering network interface (NI) service from the Local Exchange Carrier, specify service arrangement USOC RJ11C.

### *Fax branding*

The Telephone Consumer Protection Act of 1991 makes it unlawful for any person to use a computer or other electronic device, including fax machines, to send any message unless such message



## **Notices**

clearly contains in a margin at the top or bottom of each transmitted page or on the first page of the transmission, the date and time it is sent and an identification of the business or other entity, or other individual sending the message and the telephone number of the sending machine or such business, other entity, or individual. (The telephone number provided may not be a 900 number or any other number for which charges exceed local or long-distance transmission charges.)

In order to program this information into your fax machine, follow the setup instructions for **RingCentral\*\***.

### *Notice for Australia*

The following notice applies when using the telephony functions:

**FOR SAFETY REASONS, ONLY CONNECT AUSTEL PERMITTED OR CERTIFIED EQUIPMENT.**

## **Industry Canada requirements**

### *Notice*

The Industry Canada label identifies certified equipment. This certification means that the equipment meets certain telecommunications networks protective, operational, and safety requirement. The Department does not guarantee the equipment will operate to the user's satisfaction.

Before installing this equipment, users should ensure that it is permissible to be connected to the facilities of the local telecommunications company. The equipment must also be installed using an acceptable method of communication. In some cases, the company's inside wiring associated with a single line individual service may be extended by means of a certified connector assembly (telephone extension cord). The customer should be aware that compliance with the above conditions may not prevent degradation of service in some situations.

Repairs to certified equipment should be made by an authorized Canadian maintenance facility designated by the supplier. Any repairs of alterations made by the user to this equipment, or equip-

## Notices

ment malfunctions, may give the telecommunications company cause to request the user to disconnect the equipment.

Users should ensure for their own protection that the electrical ground connections of the power utility, telephone lines and internal metallic water pipe system, if present, are connected together. This precaution may be particularly important in rural areas.

### *Caution*

Users should not attempt to make such connections themselves, but should contact the appropriate electric inspection authority, or electrician, as appropriate.

The **Ringer Equivalent Number** (REN) assigned to each terminal device provides an indication of the maximum number of terminals allowed to be connected to a telephone interface. The termination on an interface may consist of any combination of devices subject only to the requirement that the sum of the Ringer Equivalence Number of all the devices does not exceed 5.

### *Avis*

L'étiquette du ministère de l'Industrie Canada identifie le matériel homologué. Cette étiquette certifie que le matériel est conforme à certaines normes de protection, d'exploitation et de sécurité des réseaux de télécommunications. Le Ministère n'assure toutefois pas que le matériel fonctionnera à la satisfaction de l'utilisateur.

Avant d'installer ce matériel, l'utilisateur doit s'assurer qu'il est permis de le raccorder aux installations de l'entreprise locale de télécommunication. Le matériel doit également être installé en suivant une méthode acceptée de raccordement. Dans certains cas, les fils intérieurs de l'entreprise utilisés pour un service individuel à ligne unique peuvent être prolongés au moyen d'un dispositif homologué de raccordement (cordon prolongateur téléphonique interne). L'abonné ne doit pas oublier qu'il est possible que la conformité aux conditions énoncées ci-dessus n'empêche pas la dégradation du service dans certaines situations. Actuellement, les entreprises de télécommunication ne permettent pas que l'on raccorde leur matériel à des jacks d'abonné, sauf dans les cas précis prévus par les tarifs particuliers de ces entreprises.

## **Notices**

Les réparations de matériel homologué doivent être effectuées par un centre d'entretien canadien autorisé désigné par le fournisseur. La compagnie de télécommunications peut demander à l'utilisateur de débrancher un appareil à la suite de réparations ou de modifications effectuées par l'utilisateur ou à cause de mauvais fonctionnement.

Pour sa propre protection, l'utilisateur doit s'assurer que tous les fils de mise à la terre de la source d'énergie électrique, des lignes téléphoniques et des canalisations d'eau métalliques, s'il y en a, sont raccordés ensemble. Cette précaution est particulièrement importante dans les régions rurales.

### ***Avertissement***

L'utilisateur ne doit pas tenter de faire ces raccordements lui-même; il doit avoir recours à un service d'inspection des installations électriques, ou à un électricien, selon le cas.

L'indice de charge (IC) assigné à chaque dispositif terminal indique, pour éviter toute surcharge, le pourcentage de la charge totale qui peut être raccordée à un circuit téléphonique bouclé utilisé par ce dispositif. La terminaison du circuit bouclé peut être constituée de n'importe quelle combinaison de dispositifs, pourvu que la somme des indices de charge de l'ensemble des dispositifs ne dépasse pas 5.

## **Regions where ThinkPad i Series 1200/1300 has ThinkPad modem integrated**

Your ThinkPad i Series 1200/1300 computer does not include a modem if it was not purchased within one of the following regions:

Australia  
Austria  
Belgium  
Canada  
Denmark  
Finland  
France  
Germany  
Hong Kong  
Ireland (tone only, no pulse dialing)

## Notices

Italy  
Latin America  
Netherlands  
New Zealand  
Norway  
Portugal (tone only, no pulse dialing)  
Singapore  
Sweden  
Switzerland  
UK  
US

### **Notice to European Users of the IBM ThinkPad Modem**

This equipment has been approved to Council Decision 98/ 482/EC - "CTR 21" for pan-European single terminal connection to the Public Switched Telephone Network (PSTN). However, due to differences between the individual PSTNs provided in different countries, the approval does not, of itself, give an unconditional assurance of successful operation on every PSTN termination point. In the event of problems, you should contact your equipment supplier in the first instance.

### **Warning notice to New Zealand users of the IBM ThinkPad modem**

- The grant of a Telepermit for a device in no way indicates Telecom acceptance of responsibility for the correct operation of that device under all operating conditions.

In particular the higher speeds at which this modem is capable of operating depend on a specific network implementation which is only one of many ways of delivering high quality voice telephony to customers. Failure to operate should not be reported as a fault to Telecom.

In addition to satisfactory line conditions a modem can only work properly if:

1. it is compatible with the modem at the other end of the call  
and

## Notices

2. the application using the modem is compatible with the application at the other end of the call - e.g. accessing the Internet requires suitable software in addition to a modem.
- Some parameters required for compliance with Telecom's Telepermit requirements are dependent on the equipment (PC) associated with this device. The associated equipment shall be set to operate within the following limits for compliance with Telecom's Specifications:
    1. There shall be no more than 10 call attempts to the same number within any 30 minute period for any single manual call initiation.
    2. The equipment shall go on-hook for a period of not less than 30 seconds between the end of one attempt and the beginning of the next attempt.
    3. Where automatic calls are made to different numbers, the equipment shall go on-hook for a period of not less than 5 seconds between the end of one attempt and the beginning of the next attempt.
    4. The equipment shall be set to ensure that calls are answered between 3 and 30 seconds of receipt of ringing (S0 set between 2 and 10). This ensures:
      - a. a person calling your modem will hear a short burst of ringing before the modem answers. This confirms that the call has been successfully switched through the network.
      - b. caller identification information (which occurs between the first and second ring cadences) is not destroyed.
  - The preferred method of dialling is to use DTMF tones (ATDT...) as this is faster and more reliable than pulse (decadic) dialling. If for some reason you must use decadic dialling, your communications program must be set up to record numbers using the following translation table as this modem does not implement the New Zealand "Reverse Dialling" standard.

|                                  |   |   |   |   |   |   |   |   |   |   |
|----------------------------------|---|---|---|---|---|---|---|---|---|---|
| Number to be dialled:            | 0 | 1 | 2 | 3 | 4 | 5 | 6 | 7 | 8 | 9 |
| Number to program into computer: | 0 | 9 | 8 | 7 | 6 | 5 | 4 | 3 | 2 | 1 |

## **Notices**

Note that where DTMF dialling is used, the numbers should be entered normally.

NOTE THAT FAULT CALLOUTS CAUSED BY ANY OF THE ABOVE CAUSES MAY INCUR A CHARGE FROM TELECOM.

## Numerics

1394 connector, location 4

## A

attaching 69  
audio CD  
    next track 13  
    play/pause 13  
    previous track 13  
    stop/eject 13  
audio problems 100

## B

battery life, extending 42  
battery pack  
    latch location 6  
    location 6  
    maximizing the battery life 85  
    replacing 39  
battery problems 98  
battery status 8  
    location 7  
BIOS Utility 18  
    Basic System Settings menu 21  
    Load Default Settings menu 25  
    Onboard Devices Configuration  
        menu 23  
    starting 18  
    Startup Configuration menu 21  
    System Security menu 25  
built-in microphone, location 3

## C

caps lock lamp 8  
care and maintenance 40  
carrying the computer 42

## CD-ROM

    inserting 16  
    problems 99  
    removing 16  
CD-ROM drive 2, 16  
    using 16  
CD-ROM eject button, location 2  
CD-ROM eject hole, location 2  
changing the startup sequence 21  
cleaning the computer 42

## D

diskette drive, location 5  
diskette standards 125  
display 124  
    changing output location 63  
    modes 65  
drive-in-use lamp 8  
dual display 66

## E

Easy Launch buttons  
    location 3  
EasyServ 118  
enhanced PC support line 119  
error codes 90  
error messages 90  
external keyboard  
    attaching 58  
external keypad  
    attaching 58  
external monitor  
    attaching 62  
    location 4  
    problems 104  
    setting 83  
external mouse  
    attaching 58

external-input-device connector  
location 4

## F

facsimile assistance 116  
FAQ 82  
features 124  
FireWire connector, location 4  
Fn key  
location 3  
Fn key functions 12  
Frequently Asked Questions 82

## G

getting service 116

## H

handling the computer 40  
hard disk drive 56  
installing 57  
removing 56  
replacing 56  
upgrading 56  
hard disk drive, location 5  
hard disk password 74  
hard disk screw  
location 6  
hardware specifications 126  
headphone jack, location 4  
hibernation mode  
problems 95  
hints 87  
hot keys 12

## I

identification numbers 114  
indicator location 2  
information  
where to get 43  
input problems 93  
installing 70  
International Warranty Service 118

## K

key combinations 12  
keyboard, specifications 124

## L

LCD  
display modes 65  
latch location 2  
problems 97  
switching output location 63  
limitations 87  
line-in jack, location 5  
list of options 114  
location 2  
lock 80

## M

magnifying glass 50  
mechanical lock 80  
memory 52  
calculating 54  
installing 52  
removing 54  
size 54  
slot location 6  
specifications 124  
microphone-in jack, location 5  
microphone, location 3  
modem problems 101  
modem, location 4

## N

network connector, location 4  
Notebook Manager program 26  
notices and warranties  
product 129  
numeric keypad, using 15  
numeric lock lamp 8



## O

- online support services 116
- online user's guide 37
- options
  - hard disk drive, upgrade 56
  - memory, increase 52

## P

- parallel port
  - location 4
- password
  - changing 78
  - entering 77
  - removing 78
  - setting 75
  - types 74
  - using 74
- PC Card 70, 71
  - problems 102
- PC Card eject button, location 5
- PC Card slot, location 5
- PC-Doctor, using 109
- power cords 127
- power jack, location 4
- Power Management Properties 14
- power meter 14
- power switch
  - location 2
- power-on lamp 8
- power-on password 74
- press-to-select 47
- printer 69
- printer problems 103
- problems, recording 115
- PS/2 mouse and keyboard connector
  - location 4

## R

- Recovery CD, using 110
- reinstalling software 38
- removing 71
- repair services 114, 116

## S

- safety notice vii
- scroll lock lamp 8
- scrolling 49
- security
  - mechanical lock 80
  - passwords 74
- security keyhole, location 4
- sensitivity 46
- service
  - how to get 116
- setup password 74
- size, machine specifications 126
- Sleep button 14
- Sleep Manager program 31
- software problems 107
- speakers, location 2
- specifications 124, 126
  - battery pack 126
  - environment 126
  - heat output 126
  - input voltage 126
  - power cords 127
  - size 126
  - temperature 126
- standards, diskettes 125
- standby lamp 8
- standby status, location 7
- startup sequence, changing 21
- status indicators 7
- status indicators, location 2

## T

- technical support 116
  - web 116
- telephone assistance 117
- temperature, machine
  - specifications 126
- ThinkPad Software Selections CD,
  - using 109
- tips 87
- TrackPoint 9
  - changing button assignments 50
  - changing cap 11
  - customizing 46

TrackPoint (*continued*)  
  disabling 61  
  location 2  
  magnifying glass 50  
  press-to-select 47  
  scrolling 49  
  sensitivity 46  
  tips on using 10  
  using 9  
TrackPoint, setting 83  
troubleshooting  
  audio problems 100  
  battery problems 98  
  CD-ROM problems 99  
  charts 89  
  error codes 90  
  error messages 90  
  external monitor problems 104  
  guide 88  
  hibernation problems 95  
  indicator problems 98  
  input problems 93  
  LCD problems 97  
  LED problems 98  
  modem problems 101  
  no error codes 92  
  no error messages 92  
  option problems 106  
  other problems 108  
  PC Card problems 102  
  printer problems 103  
  software problems 107  
  standby problems 95  
  USB problems 100

## U

USB  
  location 5  
  problems 100

## V

volume  
  decrease 13  
  increase 13

volume (*continued*)  
  turning off 13

## W

warranty  
  extensions and upgrades 120  
  product 129  
  service, international 118  
Web site 38

## Free Manuals Download Website

<http://myh66.com>

<http://usermanuals.us>

<http://www.somanuals.com>

<http://www.4manuals.cc>

<http://www.manual-lib.com>

<http://www.404manual.com>

<http://www.luxmanual.com>

<http://aubethermostatmanual.com>

Golf course search by state

<http://golfingnear.com>

Email search by domain

<http://emailbydomain.com>

Auto manuals search

<http://auto.somanuals.com>

TV manuals search

<http://tv.somanuals.com>