



Color Monitor

Monitor Couleur

Farbmonitor

Monitor en Color

Monitor a Colori

User Guide

Guide de l'utilisateur

Benutzerhandbuch

Manual del usuario

Manuale per l'utente

C50

Edition 1

This publication could contain technical inaccuracies or typographical errors. Changes are made periodically to the information herein; these changes will be made in later editions. IBM may make improvements and/or changes in the product(s) and/or program(s) at any time.

It is possible that this publication may contain reference to, or information about, IBM products (machines and programs), programming, or services that are not announced in your country.

Requests for copies of this publication and for technical information about IBM products should be made to your IBM Authorized Dealer or IBM Retailer.

No part of this publication may be reproduced or distributed in any form or by any means without prior permission in writing from the International Business Machines Corporation.

References in this publication to IBM products, programs, or services do not imply that IBM intends to make these available in all countries in which IBM operates. Any reference to an IBM product, program or service is not intended to state or imply that only IBM's product, program, or service may be used. Any functionally equivalent product, program, or service that does not infringe any of IBM's intellectual property rights or other legally protectable rights may be used instead of the IBM product, program, or service. Evaluation and verification

of operation in conjunction with other products, programs, or services, except those expressly designated by IBM, are the user's responsibility.

IBM may have patents or pending patent applications covering subject matter in this document. The furnishing of this document does not give you any license to these patents.

Trademarks

The following terms, used in this publication, are trademarks or service marks of the IBM Corporation in the United States or other countries:

IBM HelpCenter

© Copyright International Business Machines Corporation 1997.

All rights reserved.

Contents

Content	1
Setup	2
User controls	5
Further information	9
Specifications	11
Troubleshooting	12
Compliances	A1
Warranty	A2

Setup

Important: Before connecting the monitor, turn off the computer and attached devices. Also ensure the power at the electrical outlet matches the power requirements of the monitor. Refer to the **Specifications** section on page 11 for more details.

Attaching the Stand

The tilt swivel stand is fitted as follows:

1. Place the monitor face down on a soft surface to prevent the screen being scratched.
2. Insert the hooks (1) into the matching slots on the underside of the monitor (2).
3. Slide the base towards the front of the monitor until the latch (3) clicks into the locked position.

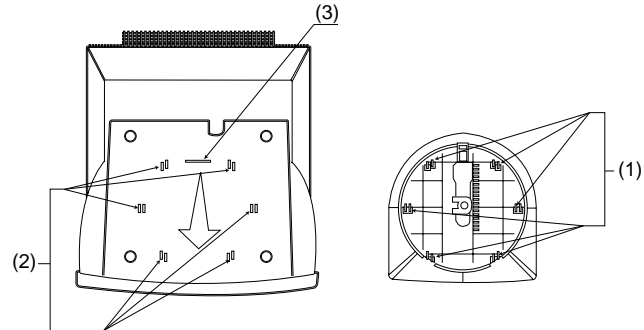

Connecting your monitor

1. Connect the signal cable to your computer (figure A). Your computer may have a video adapter card installed. In this case, attach the signal cable to the connector on the video adapter card (figure B).
2. Connect the power cord to the monitor first, then firmly insert the plug into a properly grounded electrical outlet.
3. Turn on the monitor, and then the computer.

If your monitor does not seem to be working correctly, refer to the **Troubleshooting** section on page 12 for help.

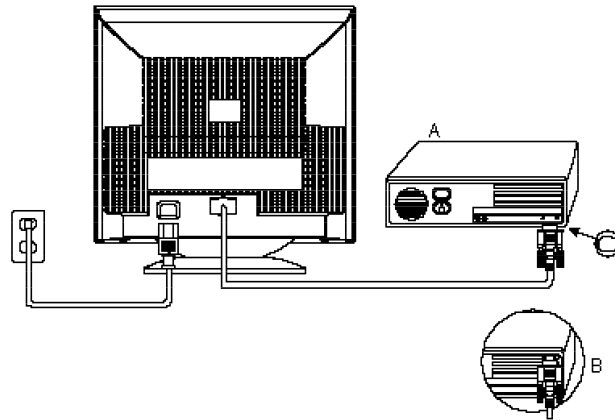

Workplace preparation

This section gives advice on the things that you should consider before you set up your monitor.

Positioning the Monitor

Choose a suitable place to position the monitor where it is not near fluorescent desk lighting or any equipment that produces magnetic fields that could cause interference. Ensure that the furniture or equipment can support the weight of the monitor. Allow at least 2 inches (50mm) ventilation space around the monitor.

Height

The monitor should be positioned so that the top of the screen is slightly below your eye level when you sit at your workstation.

Orientation

Choose a position that gives the least reflection from lights and windows, usually at a right angle to any windows. The monitor should be positioned directly in front of you so that you do not have to twist your body. Tilt the monitor to a comfortable viewing angle.

Working Practices

Rest

Take regular breaks. Vary your posture, and stand up and stretch occasionally as prolonged use of computer workstations can be tiring.

Back

You should sit back in the chair and use the back rest.

Hands

Use a light touch on the keyboard, keeping your hands and fingers relaxed. Allow a space in front of the keyboard to rest your wrists when not typing. Consider using a wristpad.

Eyesight

Working with monitors, in common with any prolonged close work, can be visually demanding. Look away from the screen periodically and have your eyesight checked regularly.

Screen settings

Set the screen brightness and contrast to a comfortable level. You may have to adjust this as the lighting changes during the day. Many application programs let you select colour combinations which can help you to view in comfort.

User controls



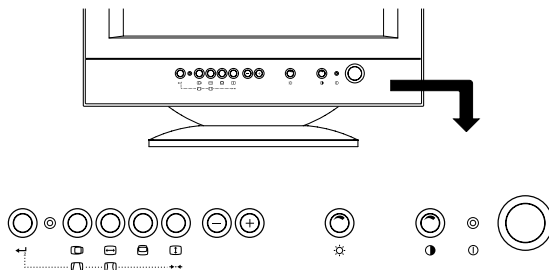



The image is already optimised for many display modes. However, the controls can be used to adjust the image to your liking.



Icon	Control	Description
①	Power switch	Switches the monitor on and off.
-	Minus button	Decrease the value of the control.
+	Plus button	Increase the value of the control.
← ₂	Shift button	Selects and deselects secondary controls.

Brightness and Contrast













These functions are adjusted directly using the rotary controls. Press the control and it will pop out so that it can be rotated. Press again to return the control flush to the bezel.

Function	Effect of Control		Description
	-	+	
 Brightness			Adjusts background brightness
 Contrast			Adjusts contrast between foreground and background











Primary Controls

If the LED indicator is lit, press shift button () to turn it off.

Press the control button once to select the primary function, then press the " - " and " + " buttons to adjust.







Function	Effect of Control		Description
	-	+	
 Horizontal Position			Moves image left or right
 Horizontal Size			Adjusts image width
 Vertical Position			Moves image up or down
 Vertical Size			Adjusts image height

Secondary controls

Control buttons ,  and  have dual functions, ,  and . To make adjustments to the secondary controls press shift button . The LED indicator will light up to show secondary controls are active. To revert back to primary controls (   ) press shift button again and the LED indicator will go off.

To adjust secondary controls :

1. Press shift button  to select secondary controls.
2. Press control button you wish to adjust.
3. Press - and + buttons to adjust the image.

Function	Effect of Control		Description
	-	+	
 Trapezoid			Equalizes the length of the top and bottom edges
 Side Pincushion			Adjusts the amount of curvature on the vertical edges
 Memory Recall			Recalls the preset image settings if operating in any one of the factory set display modes (see Table 1 on page 9)

Further information

Display modes

The display mode the monitor uses is controlled by the computer. Therefore you should refer to your computer documentation for details on how to change display modes.

The image size, position and shape may change when the display mode changes. This is normal and the image can be readjusted using the monitor controls.

To ensure flicker-free operation, select the highest (non-interlaced) refresh rate both the computer and the monitor can support, (generally 72 Hz or higher), for the addressability that your application requires.

For the display modes listed below, the screen image has been optimised during manufacture.

Addressability	Refresh Rate	Horizontal Frequency
720 x 400	70 Hz	31.5 kHz
640 x 480	60 Hz	31.5 kHz
640 x 480	72 Hz	37.9 kHz
640 x 480	75 Hz	37.5 kHz
640 x 480	85 Hz	43.3 kHz
800 x 600	75 Hz	46.9 kHz
800 x 600	85 Hz	53.7 kHz
1024 x 768	60 Hz	48.4 kHz

Table 1. Factory Set Display Modes.

Power Management

To benefit from power management, the monitor must be used in conjunction with a computer that implements the Video Electronics Standards Association (VESA) Display Power Management Signalling (DPMS) Standard.

The power management feature is invoked when the computer recognizes that you have not used your mouse or keyboard for a user-definable period of time. There are several states as described in the table below.

As an Energy Star Partner, IBM has determined that this product meets Energy Star guidelines for energy efficiency.

State	Power indicator	Screen	Restoring Operation	Compliance
On	Steady Green	Normal		
VESA Standby	Steady Yellow	Blank	Press a key or move the mouse.	
VESA Suspend	Steady Yellow	Blank	Press a key or move the mouse.*	Energy Star
VESA Off	Steady Amber	Blank	Press a key or move the mouse.*	NUTEK

* There may be a slight delay before the picture returns

Specifications

The C50 (M/T 2235) color monitor uses a 15 inch CRT with a viewable image size of 13.7 inches (348 mm)

Dimensions	Width: Depth: Height:	14.6 inch (370 mm) 16.5 inch (419 mm) 15.1 inch (383 mm)
Weight		29.7 lb (13.5 Kg)
Tilt Swivel	Forward tilt: Backward tilt: Swivel:	5° 13° +/- 90°
Image	Maximum Height: Maximum Width: Dot Pitch:	8.3 inch (210 mm) 11.0 inch (280 mm) 0.28 mm
Power input	Supply Voltage: Max Supply Current:	100 -240 Vac 50/60 Hz 1.5A at 100 Vac
Video input	Input Signal: Horiz. Addressability: Vert. Addressability: Clock Rate:	Analogue Direct Drive, 75 ohm 0-0.7v 1024 pels (max.) 768 lines (max.) 65 Mpels/sec

Communications	VESA DDC	1 / 2 B
Synchronization Range	Horiz. Frequency: Vert. Frequency:	30 kHz - 54 kHz 50 Hz - 120 Hz
Power Consumption (Typical)	Normal Operation: VESA Standby: VESA Suspend: VESA Off:	< 90 W < 15 W < 15 W < 8 W
Environment	Operating Temperature: Storage Temperature: Shipping Temperature: Operating Humidity: Storage Humidity: Shipping Humidity: Emissions:	10 to 35° C 1 to 60° C -20 to 60° C 20 to 80% 20 to 80% 20 to 90% MPR-II

Troubleshooting

If you have a problem setting up or using your monitor, you may be able to solve it yourself. Before calling your retailer or IBM you should try the suggested actions that are appropriate to your problem.

Problem	Possible Cause	Suggested Action	Reference
Screen is blank and power indicator is off.	No power to monitor.	<ul style="list-style-type: none">• Ensure the electrical outlet and the monitor are both switched on.• Check power cord is firmly plugged into the monitor and the electrical outlet.• If the power cord plug has a removable fuse, replace it.• Try another power cord.• Try another electrical outlet.	Setup section starting on page 2
Screen is blank and power indicator is steady green.	Brightness and Contrast may be too low.	<ul style="list-style-type: none">• Adjust brightness and contrast.	User controls section starting on page 5
	Display mode of the computer is outside the range of the monitor.	<ul style="list-style-type: none">• Reconfigure the computer to use a supported display mode.	Further information section starting on page 9
	No video signal from the computer.	<ul style="list-style-type: none">• Check the signal cable is firmly connected to the computer.• Check no pins are bent in the signal cable connector.	

Problem	Possible Cause	Suggested Action	Reference
Screen is blank and power indicator is steady yellow or steady amber.	The monitor is in Power Management Standby / Suspend or Off state.	<ul style="list-style-type: none"> ● Press any key on the keyboard or move the mouse to restore operation. 	
	No video signal from the computer.	<ul style="list-style-type: none"> ● Check the computer is powered on. ● Check the signal cable is firmly connected to the computer. ● Check no pins are bent in the signal cable connector. 	
Image appears to be flickering.	The monitor is operating in an interlaced or low refresh rate display mode.	<ul style="list-style-type: none"> ● Reconfigure the computer to use a non-interlaced display mode with a refresh rate of at least 72 Hz. 	Further information section starting on page 9
	The monitor may be affected by interference from nearby equipment.	<ul style="list-style-type: none"> ● Move fluorescent desk lighting or any equipment that produces magnetic fields further away from the monitor. ● If another monitor is close by, a separation distance of at least 12 inches (300mm) is recommended. 	
Image appears to be discolored.	The monitor may be affected by interference from nearby equipment.	<ul style="list-style-type: none"> ● Move any equipment that produces magnetic fields (e.g. sub woofer loud speakers) further away from the monitor. 	
	Magnetization of monitor components has built up.	<ul style="list-style-type: none"> ● Degauss the monitor by switching it off and on again after 20 minutes. 	

Further help

If you are unable to correct the problem yourself, you may seek further help as follows:

Call IBM HELPCENTER.
In the US call 1-800-772-2227
In Canada call 1-800-565-3344

In other countries, contact your dealer, retailer, or other IBM authorized servicer.

Before calling, please have available as much of the following information as possible:

1. Model and serial number from the label on the back of your monitor.
2. Purchase receipt.
3. Description of problem.
4. Computer type and model.
5. System configuration (hardware fitted etc.).
6. System BIOS version number.
7. Operating System and version number.
8. Display driver version number.

If possible, stay by your computer system. Your technical support representative might want to go through the problem with you during the call.

Compliances

Federal Communications Commission (FCC) Statement

This equipment has been tested and found to comply with the limits for a Class B digital device, pursuant to Part 15 of the FCC Rules. These limits are designed to provide reasonable protection against harmful interference in a residential installation. This equipment generates, uses, and can radiate radio frequency energy and, if not installed and used in accordance with the instructions, may cause harmful interference to radio communications. However, there is no guarantee that interference will not occur in a particular installation.

If this equipment does cause harmful interference to radio or television reception, which can be determined by turning the equipment off and on, the user is encouraged to try to correct the interference by one or more of the following measures:

- Reorientate or relocate the receiving antenna.
- Increase the separation between the equipment and receiver.
- Connect the equipment into an outlet on a circuit different from that to which the receiver is connected.
- Consult an IBM authorized dealer or service representative for help.

Properly shielded and grounded cables and connectors must be used in order to meet FCC emission limits. Proper cables and connectors are available from IBM authorized dealers. IBM is not responsible for any radio or television interference caused by using other than recommended cables and connectors or by unauthorized changes or modifications to this equipment. Unauthorized changes or modifications could void the user's authority to operate the equipment.

This device complies with Part 15 of the FCC Rules. Operation is subject to the following two conditions: (1) this device may not cause harmful interference, and (2) this device must accept any interference received, including interference that may cause undesired operation.

Power Cords

For your safety, IBM provides a power cord with a grounded attachment plug to use with this IBM product. To avoid electrical shock, always use the power cord and plug with a properly grounded power outlet.

IBM power cords used in the United States and Canada are listed by the Underwriters Laboratories (UL) and certified by the Canadian Standards Association (CSA).

For units intended to be operated at 115 volts: Use a UL listed and CSA certified cord set consisting of a minimum 18 AWG, type SVT or SJT, three conductor cord, a maximum of 4.5

metres (15 feet) in length and a parallel blade, grounding type attachment plug rated 15 amperes, 125 volts.

For units intended to be operated at 230 volts (U.S. use): Use a UL listed and CSA certified cord set consisting of a minimum 18 AWG, type SVT or SJT, three conductor cord, a maximum of 4.5 metres (15 feet) in length and a tandem blade, grounding type attachment plug rated 15 amperes 250 volts.

For units intended to be operated at 230 volts (outside the U.S.): Use a cord set with a grounding type attachment plug rated 13 amperes (minimum), 250 volts. The cord set should be marked <HAR> and have the appropriate safety approvals for the country in which the equipment will be installed.



As an ENERGY STAR Partner, IBM Corporation has determined that this product meets the ENERGY STAR guidelines for energy efficiency.

MPRII

This product complies with Swedish National Council for Metrology (MPR) standards issued in December 1990 (MPRII) for very low frequency (VLF) and extremely low frequency (ELF).

Hinweise

Gemäß der Amtsblätter des BMPT Nm. 61/1991 und 6/1992 wird der Betreiber darauf aufmerksam gemacht, daß die von ihm mit diesem Gerät zusammengestellte Anlage auch den technischen Bestimmungen dieser Amtsblätter genügen muß.

Aus ergonomischen Gründen wird empfohlen, die Grundfarbe Blau nicht auf dunklem Untergrund zu verwenden (schlechte Erkennbarkeit, Augenbelastung bei zu geringem Zeichenkontrast).

Aus ergonomischen Gründen sollten nur Darstellungen auf dunklem Hintergrund bei Vertikalfrequenzen ab 60 Hz (ohne Zeilensprung) benutzt werden.

Die Konvergenz des Bildes kann sich auf Grund des Magnetfeldes am Ort der Aufstellung aus der korrekten Grundeinstellung verändern. Zur Korrektur empfiehlt es sich deshalb, die Regler an der Frontseite für H STAT und V STAT so einzustellen, daß die getrennt sichtbaren Farblinien für Rot, Grün und Blau bei z.B. der Darstellung eines Buchstabens

zur Deckung (Konvergenz) gelangen. Siehe hierzu auch die Erklärungen zu H STAT und V STAT.

European Union (EU) Statement

This product has been tested and found to comply with the limits for Class B Information Technology Equipment according to CISPR 22 / European Standard EN 55022. The limits for Class B equipment were derived for typical residential environments to provide reasonable protection against interference with licensed communication devices.

Properly shielded and grounded cables and connectors must be used in order to reduce the potential for causing interference to radio and TV communications and to other electrical or electronic equipment. Such cables and connectors are available from IBM authorised dealers.

In accordance with EN 50082-1 1992, Performance Criterion A; it should be noted that in the presence of certain electromagnetic fields, some screen jitter may be observed.

Spécifications de la CEE

Ce produit a été testé et déclaré conforme aux limites de la Classe B définies pour les équipements informatiques conformément à la norme européenne CISPR 22/EN 55022. Les limites imposées aux équipements de Classe B visent à

garantir une protection raisonnable, dans des environnements résidentiels, contre toute interférence avec des équipements de communication agréés.

Des câbles blindés et correctement reliés à la terre doivent être utilisés pour réduire les risques d'interférence avec des communications radio et télévisées, ainsi qu'avec des équipements électriques ou électroniques. Ces câbles et connecteurs sont disponibles auprès de vos revendeurs IBM agréés.

Conformément à la norme EN 50082-1 1992, Performance Criterion A, veuillez noter qu'en présence de certains champs électromagnétiques l'image de l'écran peut être instable.

Erklärung für die Europäische Union (EU)

Dieses Produkt wurde getestet, und dabei wurde festgestellt, daß es gemäß CISPR 22 / Europäische Norm EN 55022 die Grenzwerte für Ausrüstung der Informationstechnik, Klasse B, einhält. Die Grenzwerte für Ausrüstung der Klasse B wurden für eine typische Wohnumgebung erarbeitet, um einen angemessenen Schutz vor Störungen im Zusammenhang mit zugelassenen Kommunikationsgeräten zu gewährleisten.

Es sind ordnungsgemäß abgeschirmte und geerdete Kabel und Stecker zu verwenden, um das Störungspotential in bezug auf Radio- und Fernsehempfang oder andere

elektrische oder elektronische Geräte zu reduzieren. Solche Kabel und Stecker sind bei autorisierten IBM-Fachhändlern erhältlich.

In Übereinstimmung mit EN 50082-1 1992, Leistungskriterium A wird darauf hingewiesen, daß bestimmte elektromagnetische Felder ein Flattern auf dem Bildschirm hervorrufen können.

Declaración de la Unión Europea (UE)

Este producto ha sido probado y cumple con las limitaciones estipuladas para la Clase B ITE (Information Technology Equipment), de conformidad con CISPR 22 / Estándar Europeo EN 55022. Las limitaciones de los equipos de Clase B se establecieron para que los entornos residenciales típicos a fin de proporcionar una protección razonable contra interferencias con dispositivos de comunicación autorizados.

Se deben utilizar conectores y cables debidamente protegidos y conectados a tierra a fin de reducir las posibilidades de que se produzcan interferencias con comunicaciones por radio o televisión y otros equipos eléctricos o electrónicos. Este tipo de cables y conectores pueden adquirirse en concesionarios autorizados de IBM.

De acuerdo con la norma EN 50082-1 1992, Performance Criterion A, habría que destacar que en

presencia de determinados campos electromagnéticos, podría observarse una marcada inestabilidad e la imagen.

Dichiarazione di conformità dell'Unione Europea (UE)

Questo prodotto è stato collaudato e trovato conforme ai limiti di Classe B relativi agli apparecchi informatici secondo quanto dispone la normativa europea CISPR 22 / EN 55022. I limiti degli apparecchi di Classe B sono stati definiti per i normali ambienti domestici al fine di fornire un'adeguata protezione con dispositivi di comunicazione autorizzati.

Utilizzare cavi e connettori collegati a terra per ridurre il rischio potenziale di interferenza delle comunicazioni radiotelevisive e di altri apparecchi elettrici o elettronici. I cavi sono disponibili presso i rivenditori autorizzati IBM.

In accordo con quanto previsto nel documento EN 50082-1 1992, Performance Criterion A, è importante sottolineare che in presenza di determinati campi elettromagnetici è possibile che si verifichi un certo tremolio delle immagini.

Europeiska unionen (EU)

Denna produkt har testats och följer gränsvärdena för Klass B Information Technology Equipment enligt CISPR 22 /

Europeisk standard EN55022. Gränsvärden för Klass B-utrustning utgår från vanliga bostadsområden för att ge ett rimligt skydd mot störningar i kommunikationsenheter.

Korrekt avskärmade och jordade kablar och kontakter måste användas för att minska risken för störningar i kommunikationsenheter.

TV-kommunikationer och annan elektrisk utrustning. Sådana kablar och kontakter finns tillgängliga hos auktoriserade IBM-återförsäljare.

I enlighet med EN 50082-1 1992, Performance Criterion A påpekas följande: I närheten av en del elektromagnetiska fält kan vissa bildstörningar uppstå på skärmen.

Warranty

Statement of Limited Warranty

The warranties provided by IBM in this Statement of Limited Warranty apply only to Machines you originally purchase for your use, and not for resale, from IBM or your reseller. The term "Machine" means an IBM machine, its features, conversions, upgrades, elements, or accessories, or any combination of them. Unless IBM specifies otherwise, the following warranties apply only in the country where you acquire the Machine. If you have any questions, contact IBM or your reseller.

Machine: M/T 2235

Warranty Period*: 1 year

* Contact your place of purchase for warranty service information.

Production Status

Each Machine is manufactured from new parts, or new and used parts. In some cases, the Machine may not be new and may have been previously installed. Regardless of the Machine's production status, IBM's warranty terms apply.

The IBM Warranty for Machines

IBM warrants that each Machine 1) is free from defects in materials and workmanship and 2) conforms to IBM's Official Published Specifications. The warranty period for a Machine is a specified, fixed period commencing on its Date of Installation. The date on your receipt is the Date of Installation, unless IBM or your reseller informs you otherwise.

During the warranty period IBM or your reseller, if authorized by IBM, will provide warranty service under the type of service designated for the Machine and will manage and install engineering changes that apply to the Machine. For IBM or your reseller to provide warranty service for a feature, conversion, or upgrade, IBM or your reseller may require that the Machine on which it is installed be 1) for certain Machines, the designated, serial-numbered Machine and 2) at an engineering-change level compatible with the feature, conversion,

or upgrade. Many of these transactions involve the removal of parts and their return to IBM. You represent that all removed parts are genuine and unaltered. A part that replaces a removed part will assume the warranty service status of the replaced part.

If a Machine does not function as warranted during the warranty period, IBM or your reseller will repair it or replace it with one that is at least functionally equivalent, without charge. The replacement may not be new, but will be in good working order. If IBM or your reseller is unable to repair or replace the Machine, you may return it to your place of purchase and your money will be refunded.

If you transfer a Machine to another user, warranty service is available to that user for the remainder of the warranty period. You should give your proof of purchase and this Statement to that user. However, for Machines which have a life-time warranty, this warranty is not transferable.

Warranty Service

To obtain warranty service for the Machine, you should contact your reseller or call IBM. In the United States, call IBM at 1-800-772-2227. In Canada, call IBM at 1-800-565-3344. You may be required to present proof of purchase. IBM or your reseller will provide certain types of repair and exchange service, either at your location or at IBM's or your reseller's service center, to restore a Machine to good working order.

When a type of service involves the exchange of a Machine or part, the item IBM or your reseller replaces becomes its property and the replacement becomes yours. You represent that all removed items are genuine and unaltered. The replacement may not be new, but will be in good working order and at least functionally equivalent to the item replaced. The replacement assumes the warranty service status of the replaced item. Before IBM or your reseller exchanges a Machine or part, you agree to remove all features, parts, options, alterations, and attachments not under warranty service. You also agree to ensure that the Machine is free of any legal obligations or restrictions that prevent its exchange.

You agree to:

1. obtain authorization from the owner to have IBM or your reseller service a Machine that you do not own; and

2. where applicable, before service is provided -
 - a. follow the problem determination, problem analysis, and service request procedures that IBM or your reseller provide,
 - b. secure all programs, data, and funds contained in a Machine, and
 - c. inform IBM or your reseller of changes in a Machine's location.

IBM is responsible for loss of, or damage to, your Machine while it is 1) in IBM's possession or 2) in transit in those cases where IBM is responsible for the transportation charges.

Extent of Warranty

IBM does not warrant uninterrupted or error-free operation of a Machine.

The warranties may be voided by misuse, accident, modification, unsuitable physical or operating environment, improper maintenance by you, removal or alteration of Machine or parts identification labels, or failure caused by a product for which IBM is not responsible.

THESE WARRANTIES REPLACE ALL OTHER WARRANTIES OR CONDITIONS, EXPRESS OR IMPLIED, INCLUDING, BUT NOT LIMITED TO, THE IMPLIED WARRANTIES OR CONDITIONS OF MERCHANTABILITY AND FITNESS FOR A PARTICULAR PURPOSE. THESE WARRANTIES GIVE YOU SPECIFIC LEGAL RIGHTS AND YOU MAY ALSO HAVE OTHER RIGHTS WHICH VARY FROM JURISDICTION TO JURISDICTION. SOME JURISDICTIONS DO NOT ALLOW THE EXCLUSION OR LIMITATION OF EXPRESS OR IMPLIED WARRANTIES, SO THE ABOVE EXCLUSION OR LIMITATION MAY NOT APPLY TO YOU. IN THAT EVENT SUCH WARRANTIES ARE LIMITED IN DURATION TO THE WARRANTY PERIOD. NO WARRANTIES APPLY AFTER THAT PERIOD.

Limitation of Liability

Circumstances may arise where, because of a default on IBM's part or other liability you are entitled to recover damages from IBM. In each such instance, regardless of the basis on which you are entitled to claim damages from IBM (including fundamental breach, negligence, misrepresentation, or other contract or tort claim), IBM is liable only for:

1. damages for bodily injury (including death) and damage to real property and tangible personal property; and
2. the amount of any other actual direct damages or loss, up to the greater of U.S. \$100,000 or the charges (if recurring, 12 months' charges apply) for the Machine that is the subject of the claim.

UNDER NO CIRCUMSTANCES IS IBM LIABLE FOR ANY OF THE FOLLOWING: 1) THIRD-PARTY CLAIMS AGAINST YOU FOR LOSSES OR DAMAGES (OTHER THAN THOSE UNDER THE FIRST ITEM LISTED ABOVE); 2) LOSS OF, OR DAMAGE TO, YOUR RECORDS OR DATA; OR 3) SPECIAL, INCIDENTAL, OR INDIRECT DAMAGES OR FOR ANY ECONOMIC CONSEQUENTIAL DAMAGES (INCLUDING LOST PROFITS OR SAVINGS), EVEN IF IBM OR YOUR RESELLER IS INFORMED OF THEIR POSSIBILITY. SOME JURISDICTIONS DO NOT ALLOW THE EXCLUSION OR LIMITATION OF INCIDENTAL OR CONSEQUENTIAL DAMAGES, SO THE ABOVE EXCLUSION OR LIMITATION MAY NOT APPLY TO YOU.

For European warranty terms and conditions refer to enclosed IBM warranty statement Part Number 72H9622.

Référez-vous à la garantie IBM N° de référence 72H9622 pour les conditions de garantie européennes.

Die europäischen Garantiebedingungen finden Sie in der beigefügten IBM- Gewährleistungserklärung, Teilenummer 72H9622.

Los términos y condiciones de las garantías en Europa se recogen en la declaración de garantía adjunta del número de pieza IBM 72H9622.

Per le condizioni e i termini di garanzia relativi ai paesi europei, consultare l'apposita dichiarazione IBM (numero di matricola 72H9622).

Garantivillkorea framgår av den bilogade garantihandlingen (IBM warranty statement) med artikelnummer 72H9622.

Free Manuals Download Website

<http://myh66.com>

<http://usermanuals.us>

<http://www.somanuals.com>

<http://www.4manuals.cc>

<http://www.manual-lib.com>

<http://www.404manual.com>

<http://www.luxmanual.com>

<http://aubethermostatmanual.com>

Golf course search by state

<http://golfingnear.com>

Email search by domain

<http://emailbydomain.com>

Auto manuals search

<http://auto.somanuals.com>

TV manuals search

<http://tv.somanuals.com>