

BROOKFIELD R/S RHEOMETER

Operating Instructions

Manual No. **M/02-212**



SPECIALISTS IN THE
MEASUREMENT AND
CONTROL OF VISCOSITY

BROOKFIELD ENGINEERING LABORATORIES, INC.
11 Commerce Boulevard, Middleboro, MA 02346-1031 USA
TEL 508-946-6200 or 800-628-8139 FAX 508-946-6262
www.brookfieldengineering.com

Operating Manual for R/S Rheometer

Version 1.10 E,
valid for firmware version 4.02
All rights reserved, the translation included.

Any part of this Operation Manual cannot be reproduced in any form (as printed matter, photocopies, microfilms or in any other form) or processed, copied or disseminated using electronic system without written consent of Brookfield Viscometers Ltd.

Brookfield Viscometers Ltd bears no responsibility for any technical or print technical errors or incomplete information in this Operation Manual.

We reserve the right to change this Operation Manual without previous announcement.

The reproduction of users' names, trade names, trade marks and so on in this Operation Manual does not create the necessary prerequisites for their use by anybody; frequently it is a question of protected by law registered trade marks, even if they are not marked as such.

© Copyright 1998 by

Brookfield Viscometers Ltd
1 Whitehall Estate
Flex Meadow
Pinnacles West
Harlow, Essex U.K. CM19 5TJ

® MS-WINDOWS - Copyright by Microsoft

® IBM, IBM-PC - Registered trade marks of International Business Machines Corporation

All rights reserved

Revision

10/9

CONTENTS

| | | |
|-------------|---|-----------|
| I. | GENERAL DESCRIPTION | 5 |
| I.1 | Use of the Rheometer | 5 |
| I.2 | Measuring Principle | 5 |
| II. | SYSTEM CONFIGURATION | 6 |
| II.1 | R/S Rheometer | 6 |
| II.2 | Measuring Devices | 8 |
| II.3 | Computer System | 8 |
| III. | INSTRUMENT INSTALLATION | 9 |
| III.1 | Stand Mounting | 9 |
| III.2 | Electrical Connections | 10 |
| III.2.1 | Temperature Sensor Pt100 | 10 |
| III.2.2 | AC-Adaptor | 11 |
| III.2.3 | Printer Connection | 11 |
| III.2.4 | Computer Connection | 11 |
| III.3 | Mounting of temperature controlled measuring devices | 12 |
| III.3.1 | Mounting of temp control device FTK-CC with and without cooling device KE | 12 |
| III.3.2 | Mounting of the measuring device ME-CP/PP | 14 |
| III.3.3 | Mounting of the cooling device KE | 17 |
| IV. | ENVIRONMENT, HANDLING, CLEANING AND MAINTENANCE | 18 |
| IV.1 | Operating environment, Storage | 18 |
| IV.2 | Handling | 18 |
| IV.3 | Cleaning | 18 |
| IV.4 | Maintenance | 19 |
| V. | MEASURING SYSTEMS | 20 |
| V.1 | Measurement directly in the substance | 20 |
| V.2 | Measurement with substance in measuring system | 21 |
| V.3 | Measurement with temperature control device FTK-CC | 22 |
| V.4 | Measurement with cone/plate and plate/plate measuring systems | 23 |
| VI. | OPERATION AND MENUE SYSTEM | 25 |
| VI.1 | Keyboard | 26 |
| VI.2 | Menu System of R/S Rheometer | 28 |
| VI.3 | Selecting from Lists | 29 |
| VI.4 | Input of numerical values and alphanumeric texts | 30 |
| VI.5 | Menue entries (MAIN menue) | 32 |
| VI.5.1 | MAIN-Menue → Run Single | 32 |
| VI.5.2 | MAIN-Menue → Run Program | 34 |
| VI.5.3 | MAIN menue → Remote | 36 |
| VI.5.4 | MAIN menue → Utilities | 36 |
| VI.5.5 | MAIN menue → Configuration | 36 |
| VI.6 | Menue entries in the Utilities-Menue | 37 |
| VI.6.1 | Utilities → Zero Calibration | 37 |
| VI.6.2 | Utilities → Edit Programs | 37 |
| VI.6.3 | Utilities → Print Programs | 41 |
| VI.6.4 | Utilities → Measuring systems | 41 |
| VI.6.5 | Utilities → Print memory | 42 |
| VI.6.6 | Utilities → Clear memory | 43 |
| VI.6.7 | Utilities → Measure temperature | 43 |

| | | |
|-----------------|---|----|
| VI.7 | Menu entries of the CONFIGURATION menu | 44 |
| VI.7.1 | Configuration → Set output mode | 44 |
| VI.7.2 | Configuration → MeasCount mode | 45 |
| VI.7.3 | Configuration → Reset meascount | 45 |
| VI.7.4 | Configuration → Set Time/Date | 45 |
| VI.7.5 | Configuration → Set RS232 Parameter | 46 |
| VI.7.6 | Configuration → Language | 47 |
| VI.7.7 | Configuration → Service, Service 2 | 47 |
| VI.8 | Serial Data transfer via Interface RS232 | 47 |
| VII. | MEASUREMENTS | 50 |
| VII.1 | Measuring in manual mode | 50 |
| VII.2 | Measuring in Remote-mode | 51 |
| VIII. | TECHNICAL DATA | 52 |
| IX. | GUARANTEE | 54 |
| APPENDIX | | |
| A1 | Data sheets of standard measuring systems | 55 |
| A2 | Error messages | 58 |
| A3 | Pin-layout of the serial data cable | 61 |
| A4 | Requirements to the mains connecting cables | 62 |
| A5 | Language cross reference | 63 |

I. General Description

In this chapter you get general information concerning use and measurement principle of your R/S Rheometer.

I.1 Use of the Rheometer

The R/S Rheometer system provides possibility of Newtonian fluids viscosity measurements, recording of flow curves as well as determination of viscosity functions of non-Newtonian fluids in steady shear flows. Furthermore, it assures carrying out of measurements in non-stationary shear flows and the measurements of viscoelastic substances values in creep processes. The R/S Rheometer is used in quality control, production control and researches

I.2 Measuring Principle

The R/S Rheometer is a rotational-shear rate /shear stress-rheometer.

Concentric cylinders, measuring cones and plates are available as measuring system. The measuring-sample is positioned in measuring gap between the stationary measuring cup and the rotating measuring bob (Searle-principle), respectively between the rotating cone or plate and the stationary lower plate (cone/plate-, cone/cone-measuring-system).

The measuring drive developed for this instrument operates with a high dynamic precision-drive-system with optical encoder without gearing and without mechanical force transducers, so torque is measured without deflection.

The R/S Rheometer measuring drive is applicable for carrying out rotational measurements with pre-set of speed (shear rate) and pre-set of torque (shear stress).

In case of shear rate pre-set the torque acting on rotating measuring bob/cone/plate by measuring substance flow resistance is measured (shear stress is measured).

In case of shear stress pre-set resulting speed of rotating measuring bob/cone/plate is measured (shear rate).

Shear stress measurements can be carried out with R/S Rheometer in order to determine flow behavior of plastic substances and enables exact measurement of yield point without shearing the measuring substance.

The types of measurements

- rotation measurement with controlled shear rate (CSR)
- rotation measurement with controlled shear stress (CSS)

can be carried out in manual (without PC support) or in connection with a computer system with the software RHEO 2000.

The creep measurements requires computer system with software RHEO 2000.

II. System Configuration

In this chapter you get information concerning system configuration, temperature control device, optional computer system and data- and signal flow of your Rheometer system.

The Rheometer system R/S Rheometer consists of:

- electronic unit with measuring drive integrated in one housing
- stand with working surface
- AC-adaptor

as accessories are supplied:

- **printer**
- **coaxial cylinder measuring system (see Appendix A)**
- **temperature measuring sensor Pt100**
- standard measuring device ME-CP/PP for cone/plate and plate/plate measuring systems
- cone/plate- and plate/plate measuring systems
- temperature control device "FTK-CC"
- cooling device "KE"
- fluids circulation thermostat
- computer system
- software RHEO 2000

bold printed accessories are necessary for minimal configuration

II.1 R/S Rheometer

The Rheometer electronics with measuring drive are built-in in one housing.

The R/S Rheometer system can serve due to consequent use of microelectronics with special capacities:

- ⇒ digital control of rotational speed and torque
- ⇒ automatic matching of control parameters during measurement
- ⇒ direct indication of measured and calculated values of speed, shear rate, torque, shear stress, viscosity, temperature, time etc.
- ⇒ internal measuring values storage
- ⇒ measuring values output to a printer (parallel centronics)
- ⇒ user support by dialog mode at LCD-display with clear text output
- ⇒ built-in system interface with serial standard interface (RS-232-C) for the direct connection of a computer or other serial data-loggers.
- ⇒ printing and serial data-transmission while measuring possible

The R/S Rheometer is operated manually using foil keyboard at the front panel or under computer control. The power supply of the R/S Rheometer with direct current is carried out by AC-adaptor.

R/S Rheometer main instrument (minimum configuration)

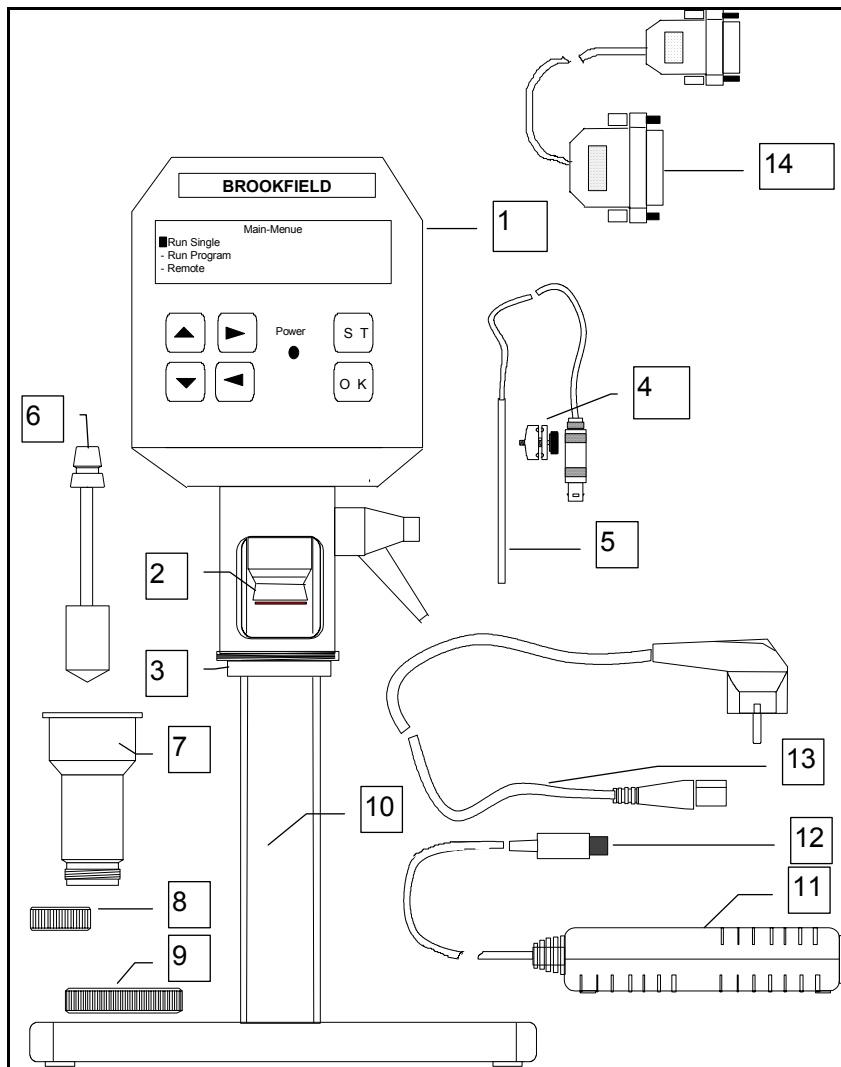

- 1 R/S Rheometer
- 2 Measuring bob coupling
- 3 Mounting flange
- 4 Pt100-clamp fixture (accessory)
- 5 Pt100 (accessory)
- 6 Standard measuring bob (accessory)
- 7 Standard measuring cup (accessory)
- 8 Measuring cup bottom, or thread protection (accessory)
- 9 Measuring cup screw fitting
- 10 Stand
- 11 AC-adaptor
- 12 Direct current coupling
- 13 Mains connection cable
- 14 Data transmission cable (accessory)

II.2 Measuring Devices

Measuring devices are not included in **the main delivery volume** of R/S Rheometer and must be ordered in accordance with your measuring requirements.

As measuring devices are optional supplied:

- coaxial standard measuring systems for R/S Rheometer (see Appendix A) with and without built-in temperature sensor Pt100
- temperature control device "FTK-CC" for use of cylinder measuring system in temperature range -10°C ... +90°C
- cooling device "KE" for use of cylinder measuring system in temperature range -20°C ... +180°C
- measuring device "ME-CP/PP" for use of cone/plate or plate/plate measuring systems (see Appendix A) in temperature range -10°C ... +90°C

II.3 Computer System

The computer system is optional and provides automatic measuring, graphical representation of measuring results, printing of report as well as analysis of measuring data and quality control.

The computer system consists of:

- IBM-compatible PC with the following minimal system requirements:
 - CPU 486 DX2 66 MHz
 - 8 MB RAM (main memory)
 - 10 MB free hard disk drive capacity
 - operating system Microsoft Windows version 3.x, Microsoft Windows 95 or Microsoft Windows 98
 - mouse and keyboard
 - VGA-graphic card and monitor
 - 1 free serial interface RS-232
 - Printer
 - user software program package RHEO 2000

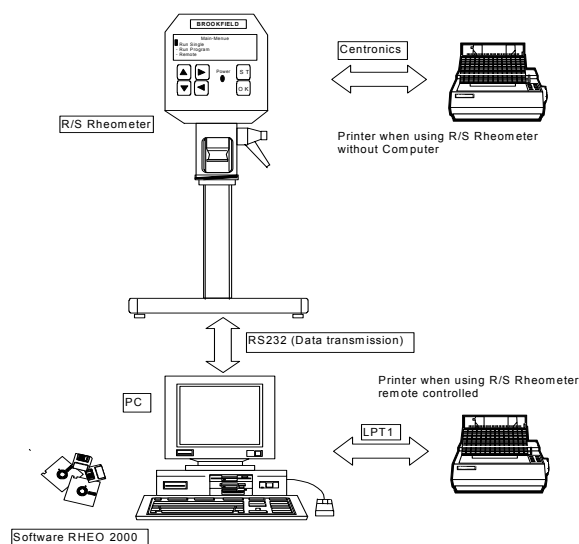

Fig. 1.: Computer system for R/S Rheometer

III. Instrument Installation

In this chapter you will know how to prepare your R/S Rheometer for the first measurements.

You will know particularly,

- how to mount the R/S Rheometer,
- details about the electric connections
- installation of accessories such as temperature control device, cooling device, measuring system
- hose connections.

III.1 Stand Mounting

The stand consists of:

- the stand base plate
- the stand column with Rheometer
- the shelf

Hex-nut wrench size 6 and bolt DIN 912 M8x40 are supplied for mounting.

1. The stand column is joined with the stand base plate by the supplied bolt. It is necessary to check during this operation that the parallel pin at the down side of the stand column fits into the corresponding drilled hole at the base plate.
2. Lay the shelf on the stand base plate.

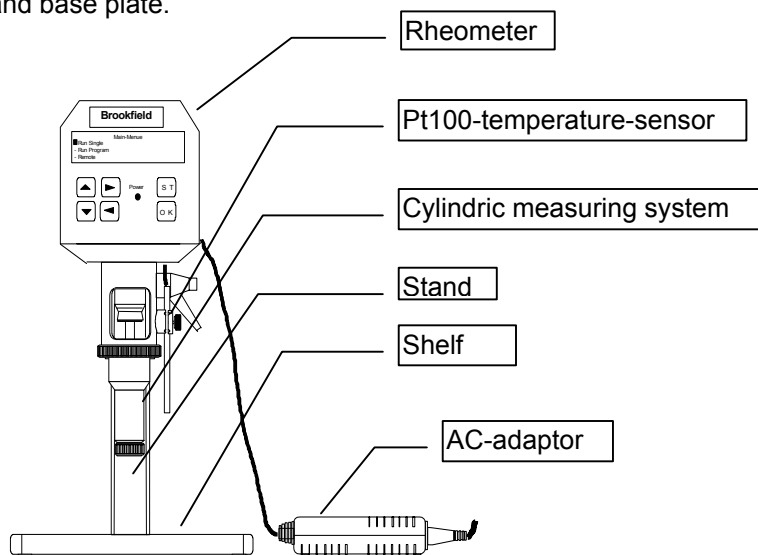
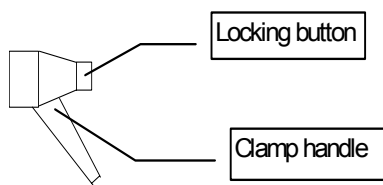

Fig. 2.: R/S Rheometer (minimum configuration)

Hints for height adjustment of the stand:



In order to change the height adjustment of the stand you must release the clamp handle and move the stand to the desired height. **Caution: Hold tight the R/S Rheometer as you release the clamp handle!** You can press the locking button to change the clamp handle position without screw/unscrew the thread. After adjustment of the height screw tight the clamp handle thread again with hand

III.2 Electrical Connections

Connections for the electrical components of the R/S Rheometer are located at the instrument back side:

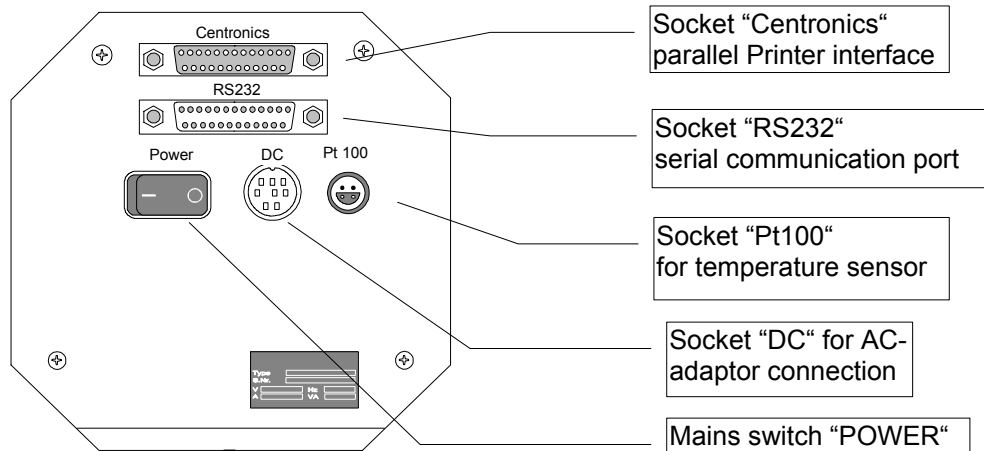

Any cables from and to R/S Rheometer can be connected or disconnected only when instrument is switched off!

III.2.1 Temperature Sensor Pt100

The connecting cable of the temperature sensor Pt100 is inserted into connector "Pt100" at the back side of the R/S Rheometer.

The Pt100 used is dependent upon measuring system device.

If you use standard cylindric measuring cups (MB-CC45...CC8) for measurements, put the sensor Pt100 into Pt100 clamp fixture and fix it parallel to the measuring system at mounting flange of the R/S Rheometer with the help of knurled-head screw.

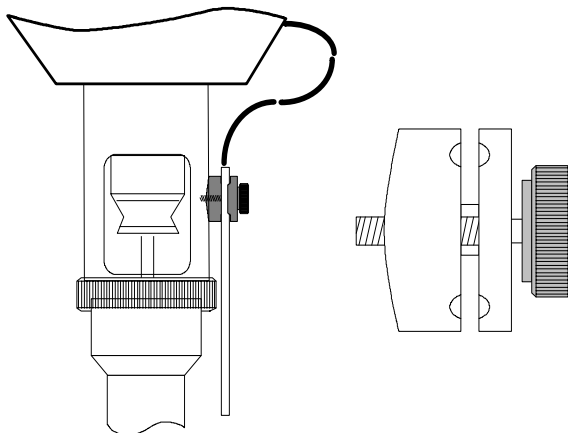

Fig. 3: Pt100 connection and mounting

Insert the plug of Pt100 temperature sensor into the connector "Pt100" at the back side of the Rheometer.

As the viscosity is a function of the temperature, the temperature should be measured preferably in the measuring substance. For this purpose, the standard measuring systems CC45...CC8 DIN can be equipped with a Pt100 in measuring cup bottom (only in connection with FTK-CC). If you use a measuring system with built-in Pt100, insert the cable "VK-MB" there. With this option you can measure the substance temperature directly.

III.2.2 AC-Adaptor

The AC adaptor supplies R/S Rheometer with power.

Only the AC-adaptor delivered by BROOKFIELD with your Rheometer may be used for power supply of R/S Rheometer.



The AC-adaptor may be inserted to the socket with corresponding grounding only. Connect the AC adaptor only using the plug in a proper way grounded to avoid electric shocks or damage of the system components. Pay attention also to "Requirements to the mains cable" (see Appendix).

Connecting the AC-adaptor:

- be sure that R/S Rheometer is switched off (mains switch "POWER" at the back side of the instrument);
- insert the instrument connector of the mains cable into AC adaptor;
- insert the plug of DC cable into the connector "DC" at the back side of R/S Rheometer;
- insert the mains plug of the mains cable into a grounded socket;
- turn on the R/S Rheometer again.

The AC-adaptor should not remain connected to the mains socket during long time with disconnected plug of the DC cable from the connector "DC" at the back side.

Before disconnecting R/S Rheometer from mains supply be sure that the Rheometer is switched off.

III.2.3 Printer Connection

Printer can be connected directly to the interface connector of the R/S Rheometer when measuring without PC support. You must preset "Printer" as output device to print the measuring values during measurement (see Chapter 6).

You should use obligatory a printer with parallel "CENTRONICS" interface.

- Turn off the R/S Rheometer with the mains switch "POWER" at the back side.
- Insert the printer connecting cable into the connector "CENTRONICS" at the back side of rheometer.
- Turn on R/S Rheometer again.

Standard printer cable (Printer ↔ PC) can be used as printer connecting cable. This cable is supplied with the printer in most cases.

To print data-values from R/S Rheometer all printers can be used which are printing text in ASCII-mode.

III.2.4 Computer Connection

If the R/S Rheometer has to be used in "REMOTE" mode with PC support (Rheo-program package) or with serial data-terminal for data logging it is necessary to connect the data link with the plug "RS232" at the instrument back side.

- Turn off the R/S Rheometer with the mains switch "POWER" at the back side.
- Turn off your computer system.
- Insert the data link into the plug "RS232" at the back side of the rheometer.
- Connect the other end of the data link with a free serial interface RS-232 (f.e. "COM2") of your computer.
- Turn on the R/S Rheometer and your computer system again.

Use data link cable of BROOKFIELD delivery only!

Please read information concerning installation of the computer system in this Operation Manual.

III.3 Mounting of temperature controlled measuring devices

In this chapter you get information concerning mounting and attachment of the following accessories components:

- **FTK-CC temperature control device** for use of **cylinder measuring system** in the temperature range $-10^{\circ}\text{C} \dots +90^{\circ}\text{C}$ (liquid's temperature control)
- **KE cooling device** in conjunction with FTK-CC temperature control device or ME-CP/PP measuring device to rise the temperature range up to $-20^{\circ}\text{C} \dots +180^{\circ}\text{C}$
- **ME-CP/PP measuring device** for use of **cone/plate and plate/plate measuring system** in the temperature range $-10^{\circ}\text{C} \dots +90^{\circ}\text{C}$ (liquid's temperature control)

III.3.1 Mounting of temperature control device FTK-CC with and without cooling device KE

As temperature control device is available **optionally**:

- **FTK-CC**

for use of cylinder measuring system in the temperature range $-10^{\circ}\text{C} \dots +90^{\circ}\text{C}$ (liquid's temperature control).

| | |
|---|---|
|  | <p>The temperature control device "FTK-CC" should be used only in the temperature range $-10^{\circ}\text{C} \dots +90^{\circ}\text{C}$. The cooling device "KE" is necessary additionally for temperature range of $-20^{\circ}\text{C} \dots +180^{\circ}\text{C}$!</p> |
|---|---|

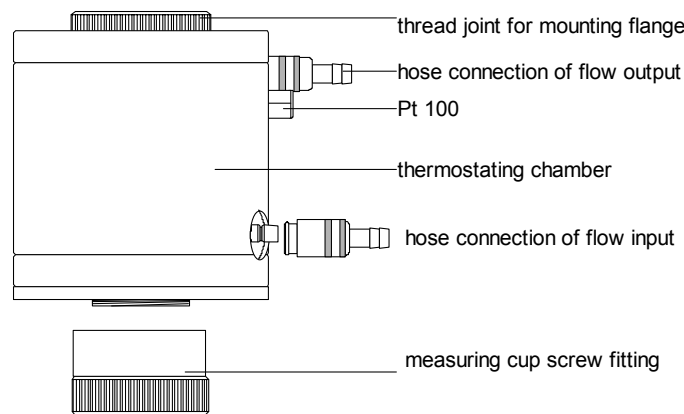

Fig.: 4.: Temperature control device FTK-CC

Mounting of the temperature control device "FTK-CC"

- Turn off the R/S Rheometer with the mains switch "POWER" at the instrument back side.
- When using cooling device KE mount cooling device first (see chapter 3.3.3)
- Set the "FTK-CC" from below on the mounting flange of R/S Rheometer and tighten the thread.
- Fix the hoses of liquid circulation thermostat at the "FTK-CC" as described below.
- Connect the FTK-CC's built-in Pt100 cable with the connector "PT100" at the instrument back side of the R/S Rheometer.

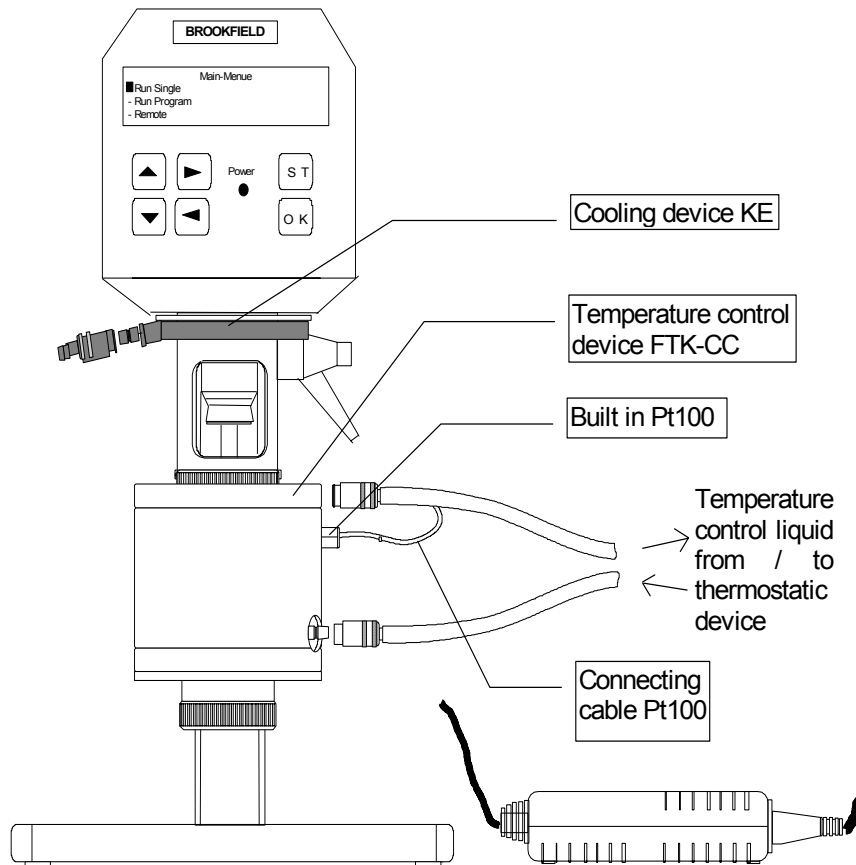

Fig. 5.: Operation with FTK-CC and cooling device KE

Thermostat connection to temperature control device FTK-CC

Hoses' connections are necessary to join a liquid circulation thermostat by operation of the R/S Rheometer with liquid circulation temperature control device "FTK-CC".

The hoses of liquid circulation thermostat are connected with the help of quick fitting couplings with the temperature control device "FTK-CC" (below: inlet; above: outlet). For this purpose it is necessary to move back the coupling's bush, insert the hose and release the coupling. It fixes the hose (without screwing or rotation) by groove. Check by pulling gently whether the hoses' connections are securely fixed.



The temperature control device "FTK-CC" without cooling device KE must only be used in the temperature range -10°C ...+90°C.

The temperature control device "FTK-CC" can be used in the temperature range -20°C...+180°C in case of using **optionally obtainable** cooling device "KE".

It is recommended urgently to preset at liquid circulation thermostat the upper temperature limitation: when using water at 90°C and when using oil at 180°C (only with cooling device KE).

As thermostatic liquids are usually used:

| | |
|------------------|------------------------------------|
| -10 °C to +90 °C | water (deionized) - glycol-mixture |
|------------------|------------------------------------|

| | |
|-------------------|----------------|
| -20 °C to +250 °C | thermostat oil |
|-------------------|----------------|

Thermostatic fluids can be ordered from **BROOKFIELD**.

| | |
|---|---|
|  | During measurements in the temperature range below -10°C and above +90°C the temperature control device “FTK-CC” may be put into operation only if the cooling liquid flows through the “KE” in order to prevent overheat of the measuring sensor. |
|---|---|

III.3.2 Mounting of the measuring device ME-CP/PP

- Turn off the R/S Rheometer with the mains switch “POWER” at the instrument back side.
- When using cooling device KE mount cooling device first (see chapter 3.3.3)
- Set the “ME-CP/PP” from below on the mounting flange of measuring cup and tighten the thread. Check that before tightening the guide pin of the measuring device must be in the slot of the R/S Rheometer mounting flange!
- Fix the hoses of liquid circulation thermostat at the “ME-CP/PP” (see below).
- Insert the cable “VK-MB” supplied to the “ME-CP/PP” in the built-in Pt100 and in the connector “PT 100” at the instrument back side of the R/S Rheometer.
- For mounting the cone/plate or plate/plate measuring systems to measuring device refer to chapter 5.

Thermostat connection to temperature control device FTK-CC

Hoses’ connections are necessary to join a liquid circulation thermostat by operation of the R/S Rheometer with liquid circulation measuring device “ME-CP/PP”.

The hoses of liquid circulation thermostat are connected with the help of quick fitting couplings with the measuring device “ME-CP/PP” (below: inlet; above: outlet). For this purpose it is necessary to move back the coupling’s bush, insert the hose and release the coupling. It fixes the hose (without screwing or rotation) by groove. Check by pulling gently whether the hoses’ connections are securely fixed.

| | |
|---|---|
|  | The measuring device “ME-CP/PP” without cooling device KE must only be used in the temperature range -10°C ...+90°C. |
|---|---|

The measuring device “ME-CP/PP” can be used in the temperature range **-20°C ... +180°C** in case of using optionally **obtainable** cooling device “KE”.

It is recommended urgently to preset at liquid circulation thermostat the upper temperature limitation: when using water at 90°C and when using oil at 180°C (only with cooling device KE).

As thermostatic liquids are usually used:

| | |
|--------------------|------------------------------------|
| -10 °C ... +90 °C | Water (deionized) - glycol-mixture |
| -20 °C ... +180 °C | Thermostat oil |

The proper thermostatic liquids can be ordered from **BROOKFIELD**.



During measurements in the temperature range below -10°C and above $+90^{\circ}\text{C}$ the measuring device “ME-CP/PP” may be put into operation only if the cooling liquid flows through the “KE” in order to prevent overheat of the measuring sensor.

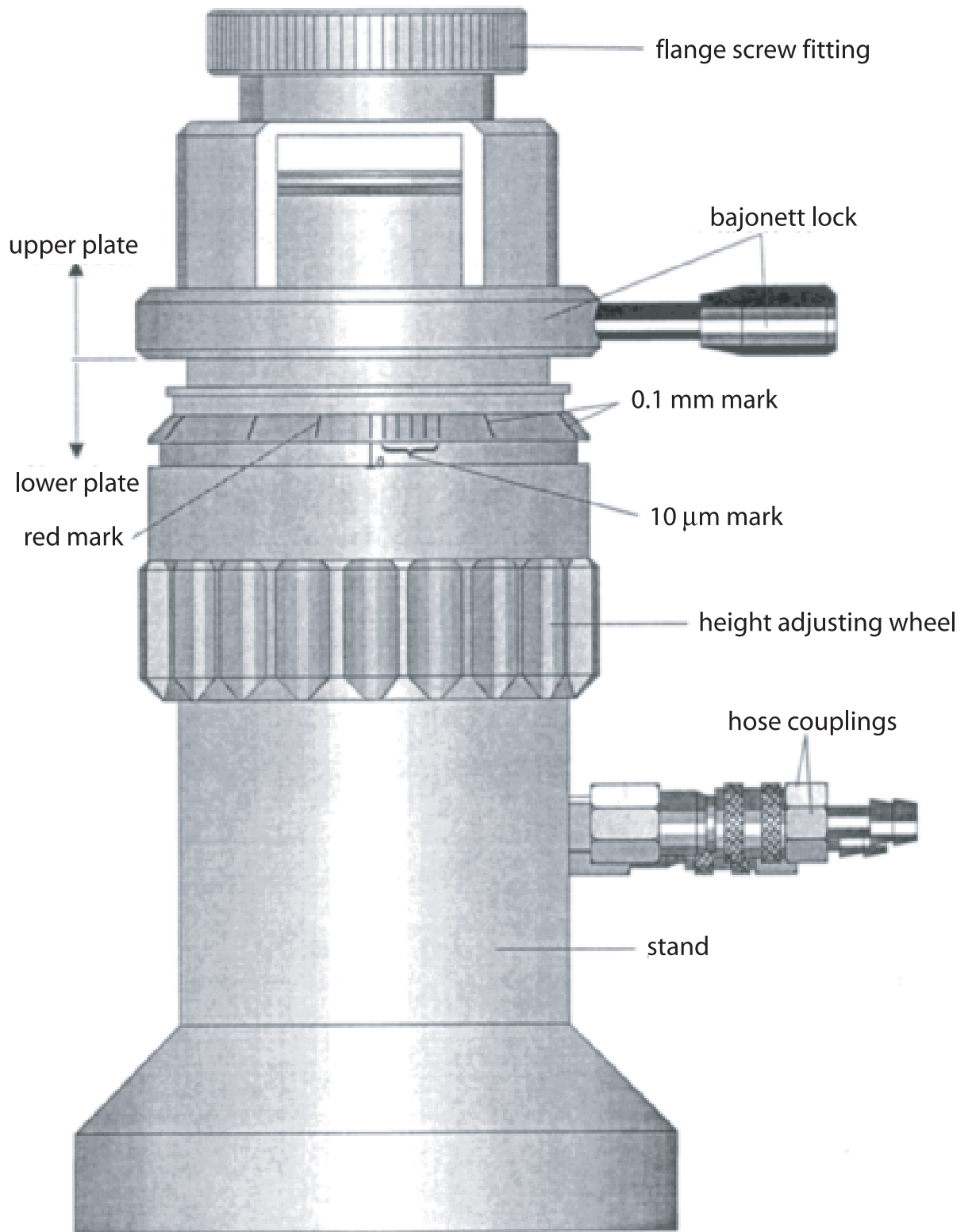

Measuring device for cone/plate and plate/plate measuring systems ME CC/CP

III.3.3 Mounting of the cooling device KE

The optionally supplied cooling device "KE" must be used in case of the R/S Rheometer operation with the liquid temperature control device "FTK-CC" or measuring device "ME-CP/PP" in the temperature range below -10°C and above $+90^{\circ}\text{C}$. When using cooling device KE temperature range of temperature control device "FTK-CC" and measuring device "ME-CP/PP" is expanded to $-20^{\circ}\text{C}... +180^{\circ}\text{C}$.

The cooling liquid flows through the cooling channel of the cooling device KE and prevents the heat transfer from the liquid's tempered chamber of temperature control device "FTK-CC" or measuring device "ME-CP/PP" to the R/S Rheometer.

Mounting

- Turn off the R/S Rheometer with the mains switch "POWER" at the instrument back side.
- Lift the "KE" from below to the R/S Rheometer and tighten the thread.
- Fix the hoses of the cooling loop at the "KE" (see below "Cooling water connection to cooling device KE").

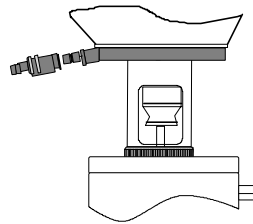

Fig. 6: cooling device KE

Cooling water connection to cooling device KE

The hoses of cooling circulation loop are connected with by quick fitting couplings the cooling device "KE". For this purpose it is necessary to move back the coupling's bush, insert the hose and release the coupling. It fixes the hose (without screwing or rotation) by groove. Check by easy pull if the hoses' connections are firm.



During measurements in the temperature range below -10°C and above $+90^{\circ}\text{C}$ the "FTK-CC" / "ME- CP/PP" may be put into operation only if the cooling liquid flows through the "KE" in order to prevent overheat of the measuring sensor.

IV. Environment, handling, cleaning and maintenance

In this chapter you get information concerning environment, handling, cleaning and maintenance of your R/S Rheometer.

IV.1 Operating environment, Storage

Find comfortable, convenient working place where you install your R/S Rheometer. It must be enough room for installation of the stand, measuring system, measuring substances and peripheral devices (for example printer, computer and thermostat).

You need a grounded socket for operation of the R/S Rheometer. You need also a socket for connection of the peripheral devices.

Your operating environment and the place for storage of the R/S Rheometer should not be extremely hot, extremely cold or moist.

Also avoid places where temperature and air humidity fluctuate strongly. Moreover check that the R/S Rheometer is not subjected to

- dirt or dust,
- direct sun radiation,
- objects that emit strong heat (e.g. heating radiators),
- objects with strong electromagnetic field (e.g. loudspeakers, motors etc.),
- liquids or corrosive chemicals.

IV.2 Handling

The R/S Rheometer is designed in such way that even by easy kicks or vibrations its' performance is failure-free. However, pay attention to absence of strong kicks or falls.



Never lift your R/S Rheometer at the measuring bob coupling or a built-in measuring bob and avoid everything that could influence free and concentric rotation of the measuring bob coupling (e.g. a shock).

If the measuring torque is exceeded, e.g. by shut-down of the measuring drive at full load or due to viscosity raise in solidification process, the safety device in electronic operates and prevents a failure. The R/S Rheometer could be under the load unlimited time also in such extreme cases.

IV.3 Cleaning

The paint of the R/S Rheometer resists attack by usual solvents and weak acids. Use dry, clean, soft and nap-free cloth to clean the housing. Use neutral detergent liquids at a soft cloth in case of severe contamination of the housing.



Do not use any chemical products such as strong solvents or strong acids to clean the housing, especially the operating fields with the foil keyboard.



Check that any liquid does not penetrate into the housing (e.g. through the instrument connecting plugs) and into the bearings of the measuring drive. It results in the instrument damage!

IV.4 Maintenance

The R/S Rheometer is designed for long-term operation.

Nevertheless we recommend a regular maintenance in one-year cycle by a service engineer of BROOKFIELD or of corresponding representation.



Works on control electronics, all accessories, measuring drive as well as with the AC-adaptor and all electric circuits and connections may only be carried out by authorized service personnel trained by us.

Check of the measurements' accuracy by the customer is possible any time. We recommend the measurement with the standard oils (normal oils).

Type: standard oil 2000 A, viscosity approx. 1.9 Pas

The measurement is carried out preferably with the temperature control device "FTK-CC" with measuring system CC25 DIN with Pt100 built-in in the bottom of the measuring cup. The standard oil is thermostatted for at least 20 minutes at $20^{\circ}\text{C} \pm 0.05^{\circ}\text{C}$.

Select the appropriate measuring system.

Carry out measurements at the following preset values of shear rates:

10 s⁻¹, 25 s⁻¹, 50 s⁻¹ and 100 s⁻¹.

Print viscosities or read off viscosities from display.

In case of the instrument failure (or severe deviation from the preset value), please, apply to the service department of BROOKFIELD.

V. Measuring Systems

In this chapter you get information concerning use of the measuring system.

At present the following measuring system types are supplied:

- a) Standard measuring systems MS-CC48...CC8 DIN/RC and DG-DIN/RC for measurement without temperature control device FTK-CC consists of:
 - measuring cup for R/S Rheometer (MB-CC48...MB-CC8/RC and MB-DG/RC) depending on measuring-system
 - measuring cup bottom
 - measuring bob (MK-CC48...CC8/RC and MK-DG/RC) depending on measuring system
 - thread protection
 -
- b) Standard measuring systems MS-CC48...CC8 DIN/FTK and DG-DIN/FTK for measurement **with** temperature control device FTK-CC consists of:
 - measuring cup for R/S Rheometer (MB-CC48 ...CC8 DIN/FTK u. MB-DG DIN/FTK) depending on measuring system
 - bottom screw
 - measuring bobs (MK-CC48...CC8 DIN and MK-DG DIN) depending on measuring system
 - optionally Pt100 temperature sensor in measuring cup bottom or in temperature control device
- c) One-way measuring system EWS-CC48...CC8 DIN/FTK for measurement **with** temperature control device FTK-CC consists of:
 - measuring cup mounting MBA-CC48...CC8 DIN/FTK depending on measuring system (holder for disposable one-way cups)
 - one-way measuring cup (aluminum) EMB-CC48...CC8 DIN/FTK depending on measuring system
 - measuring cup ejector
 - measuring bob (MK-CC48...CC8 DIN)
- d) Cone/plate measuring system C25-1...C50-2 for measurement **with** measuring device ME-CP/PP consists of:
 - measuring cone (C25-1...C50-2) depending on measuring system
- e) Plate/plate measuring system P25, P50 for measurement with measuring device SM-KP consists of:
 - measuring plate (P25, P50) depending on measuring system

Please select a suitable measuring system for the desired measuring range to carry out measurements. (for details of measuring systems ranges refer to Appendix A)

V.1 Measurement directly in the substance

If necessary remove in case of measuring systems CC48...CC8-DIN the bottom from measuring cup and screw on the thread protection.

Attention when using DG-DIN!

When using the measuring system DG-DIN remove very carefully the O-ring seal between the measuring cup case and inner part. To do this open the measuring system below and take out the inner part. Take care not to damage or stretch the O-ring seal during removal! Insert the inner part again and screw the measuring system.

Lift the coupling sleeve of the measuring bob coupling (ring visible).

Insert carefully the measuring bob into the measuring bob coupling. Pay attention to insert the measuring bob shaft into the measuring bob coupling without impact.

Move down the coupling sleeve of the measuring bob coupling (ring covered).
Fasten the measuring cup at the measuring cup mounting flange with the help of measuring cup thread.

By moving down the stand, immerse the measuring cup into the substance up to the ring mark or up to the point where diameter of measuring cup increases.

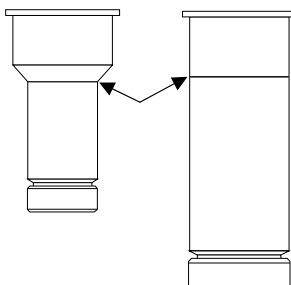

Fig. 7.: Depth of immersion

Pay attention to the fact that any substance or solvent does not ingress into measuring bob coupling, measuring drive or electronics.

Now the measurement can be carried out.

After the end of measurement unscrew the measuring cup thread and remove measuring cup. Then open the measuring bob coupling and remove the measuring bob.

Clean measuring cup and measuring bob carefully. Do not use hard objects, **always prevent scratches!**

Store measuring bobs on a soft pad. \

V.2 Measurement with substance in measuring system

Fill the measuring cup with substance (sample filling quantity see Appendix A1 “Data sheets of the standard measuring system”).

Avoid air bubbles when filling in the substance as they result in non-reproducibility of the measured values.

Place the measuring bob in measuring cup. Lift the coupling sleeve of the measuring bob coupling (ring visible). Insert the complete measuring system from below into the measuring cup mounting flange and screw tight using the measuring cup thread. Insert the measuring bob shaft into the measuring bob coupling without impact. Now insert the measuring bob shaft completely into the measuring bob coupling and move down the coupling sleeve of the measuring bob coupling (ring is covered).

In this case of measurement the substance temperature control can be carried out by immersing the measuring system into a thermostat (delivery as special accessory). It is necessary to pay attention to the immersion depth (Chapter 5.1).



Temperature range max.: 0°C ... +90°C.

The cooling device “KE” is required to expand the temperature range to -20°C ...+180°C



The temperature sensor Pt100 may be immersed in medium only at 2/3 of the metal rod length! Cable must be always outside the medium.

If you want to measure with temperature control, the thermostat must be pre-set at the desired temperature and you should wait till the necessary temperature of the substance is reached (e.g. temperature measurements through the Pt100 menu point “Utilities → Meas.-Temperature”, see Chapter 6).

Now the measurement can be carried out.

To remove the measuring system after the measurement first open the measuring bob coupling and then unscrew the measuring cup thread.



Attention: If you have carried out measurements at higher or very low temperatures please take care: Some accessible surfaces can become very hot or cold. Before removing measuring system please wait till the system-surface-temperature equalized to nearly room temperature and allows you to touch the system without danger.



When unscrewing the measuring cup, you must hold the measuring system tightly with one hand! Due to its own weight measuring system would fall downwards.

Clean measuring cup and measuring bob carefully, do not use hard objects, always prevent scratches!
Store measuring bobs on a soft pad.

V.3 Measurement with temperature control device FTK-CC

In case of one-way measuring systems insert the one-way measuring cup into the measuring cup mounting.

Fill the measuring cup with substance (sample filling quantity see Appendix A1 “Data sheets of the standard measuring system”).

Avoid air bubbles when filling in the substance as they result in non-reproducibility of the measured values.

Place the measuring bob in measuring cup. Lift the coupling sleeve of the measuring bob coupling (ring visible). Insert the complete measuring system from below into the temperature control device and screw tight using the measuring cup screw. Insert the measuring bob shaft into the measuring bob coupling without impact. Now insert the measuring bob shaft completely into the measuring bob coupling and move down the coupling sleeve of the measuring bob coupling (ring is covered).

The thermostat must now be pre-set at the desired temperature and you should wait till the necessary temperature of the substance is reached (e.g. temperature measurements through the Pt100 menu point “Utilities → Meas.-Temperature”, see Chapter 6).

Now the measurement can be carried out.

To remove the measuring system after the measurement first open the measuring bob coupling and then unscrew the measuring cup screw of temperature control device.



Attention: If you have carried out measurements at higher or very low temperatures please take care: Some accessible surfaces can become very hot or cold. Before removing measuring system please wait till the system-surface-temperature equalized to nearly room temperature and allows you to touch the system without danger.



When unscrewing the measuring cup, you must hold the measuring system tightly with one hand! Due to its own weight measuring system would fall downwards.

In case of one-way measuring cups eject the one-way measuring cup with the measuring cup ejector.

Clean the measuring bob carefully, do not use hard objects, always prevent scratches!
Store measuring bobs on a soft pad.

V.4 Measurement with cone/plate and plate/plate measuring systems

Insert and adjustment of the measuring cone or measuring plate

To install the measuring bob the bayonet lock must be released (position “opened”) and the lower measuring plate must be displaced down. **Caution:** during release of the bayonet lock the measuring device has to be hold tight at height adjustment ring.

Lift the coupling sleeve of the measuring bob coupling (ring visible). Insert the measuring bob (cone or plate) from below into measuring coupling. Move down the coupling sleeve of the measuring bob coupling (ring covered).

Loosen the inner hexagon screw at measuring bob shaft.

Press measuring plate upward again and close bayonet lock (position “closed”).

Loosen scale clamp screw at height adjustment ring.

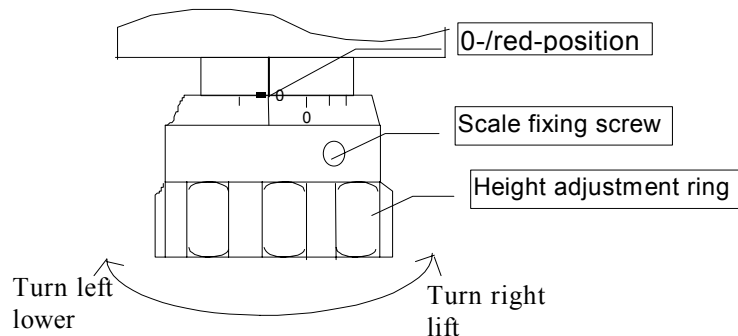

The upper marker (“0”) and the lower red marker (red mark) are brought into coincidence rotating the height adjustment ring (=0-/red position, see picture).

In order to avoid thread backlash, the height adjustment ring must be now obligatory turn through to "0.4" (turn to the right = lift) and then again return back to the 0/red position.

Now screw on the inner hexagon screw at measuring bob shaft finger-tight ; this fixes the measuring bob in this position.

After rotating the scale mark from 0-/red position to the 0/0 position the cone/plate measuring device is ready for measurements.

To protect lower plate against accidental turning please fasten scale fixing screw finger-tight .

Open the bayonet lock and lower the lower plate. Apply the desired measuring substance to the lower plate.

Lift up carefully the lower plate again and fix the bayonet lock.

Caution: Excess of medium at plate edge must be removed (error influence!)

The thermostat must now be pre-set at the desired temperature and you should wait till the necessary temperature of the substance is reached (e.g. temperature measurements through the Pt100 menu point "Utilities → Meas.-Temperature", see Chapter 6).

VI. Operation and Menu System

In the following chapter you will get overview on operations, menu system of R/S Rheometer and measurements, both in manual and PC controlled modes.

The menu-system of R/S Rheometer (firmware-version 4.02) is a dual-language system. Following languages are software selectable:

- English
- German

Desired language can be selected via menu item **Configuration→Language** (if English language is active) or **Configuration→Sprache** (if German language is active).

More details on language selection see chapter 6.7.6.

The following chapter will describe instrument handling with ENGLISH language active.

After switching on the R/S Rheometer, LCD indicates the following information for few seconds:

- * Name of the Rheometer;
- * Software firmware-version installed in the instrument (Brand name);
- * Serial number of the instrument (xxxxxx);
- * Date and time;

Example:

```
R/S Rheometer
Ver.: 4.02 #xxxxxx
07.05.98    15.12
© Brookfield
```

After about 5 sec the instrument checks voltages of the Power Supply Unit. Displayed voltages are to lie in the range from 14.9 to 16 V. Otherwise, some technical fault has occurred (→ Repairs).

Beispiel:

```
Voltage check:
VCC:15.25 V
```

This message is displayed for about 3 seconds. Then the **MAIN menu** is displayed.





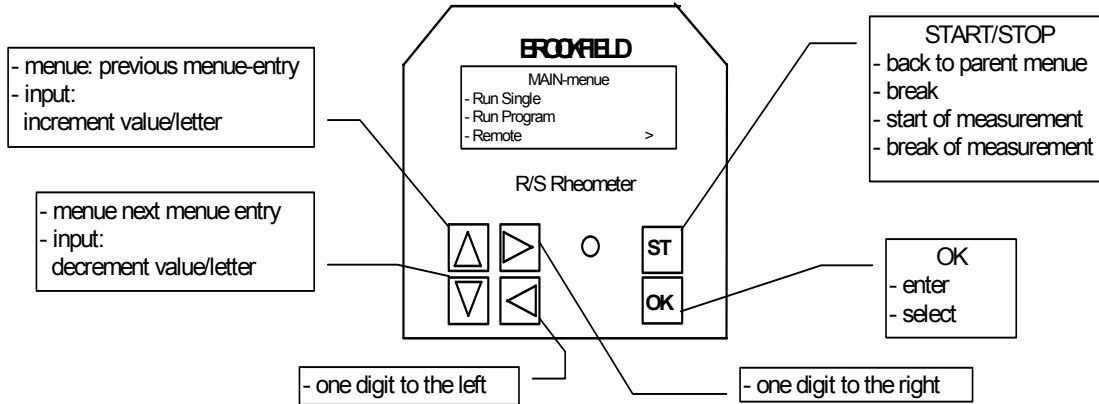

Before you will get overview of the menu system of R/S Rheometer (Chapter 6.4), at this place it is worth to make a brief summary on the rheometer keyboard and corresponding rheometer functions.

VI.1 Keyboard



All user inputs are made with help of 6 keys located below LCD-Display. Some of the keys are of multiple use, i.e. their function depends on actual executed operation. The following table shows detailed overview on keyboard functions.

Key-function dependent to executed operation

| key | operation | Function of key | example |
|---|---------------------|---|--|
|  | Menue | goto previous menue-entry (above active one) | „Utilities“ → „Remote“ |
| | Value-input | increment | „8“ → „9“ „A“ → „B“ |
| | Selection from List | list entry above active entry (previous) | Select Meas.system „CC45“ → „CC48“ |
|  | Menue | goto next menue-entry (below active one) | „Remote“ → „Utilities“ |
| | Value-input | decrement | „5“ → „4“ „F“ → „G“ |
| | Selection from List | list entry below active entry (next) | Select Meas.system „CC48“ → „CC45“ |
|  | Menue | goto previous menue-entry (above active one) | „Utilities“-> „Remote“ |
| | Value-input | one digit to the right | „100.00“-> „100.00“ „Test“-> „Test“ |
| | Selection from List | list entry above active entry (previous) | Select Meas.system „CC45“ -> „CC48“ |
|  | Menue | goto next menue-entry (below active one) | „Remote“->Utilities“ |
| | Input | one digit to the left | „100.00“-> „100.00“ „Test“-> „Test“ |
| | Selection from List | list entry below active entry (next) | Select Meas.system „CC45“ -> „CC48“ |
|  | Menue | return to parent-menue | „UTILITY“-> „MAIN“ |
| | Value-input | Input break (only if possible) | |
| | Selection from List | Selection break (only if possible) | Select Meas.system ->back to menue |
| | Messung | START and BREAK of measurement | break while measuring Messung |
| | Remote active | Break of measurement Back to MAIN-menue | |
|  | Menue | execute Menue item (open sub-menue) | |
| | Value-input | End of input / enter value | |
| | Selection from List | select active item | |

A novice might perceive this keyboard layout excessively complicated, however, even after your first experiments, you will surely come to the conclusion, that you do not need the layout Table for reference and multi-function keys ensure major simplification of the operations.

VI.2 Menu System of R/S Rheometer

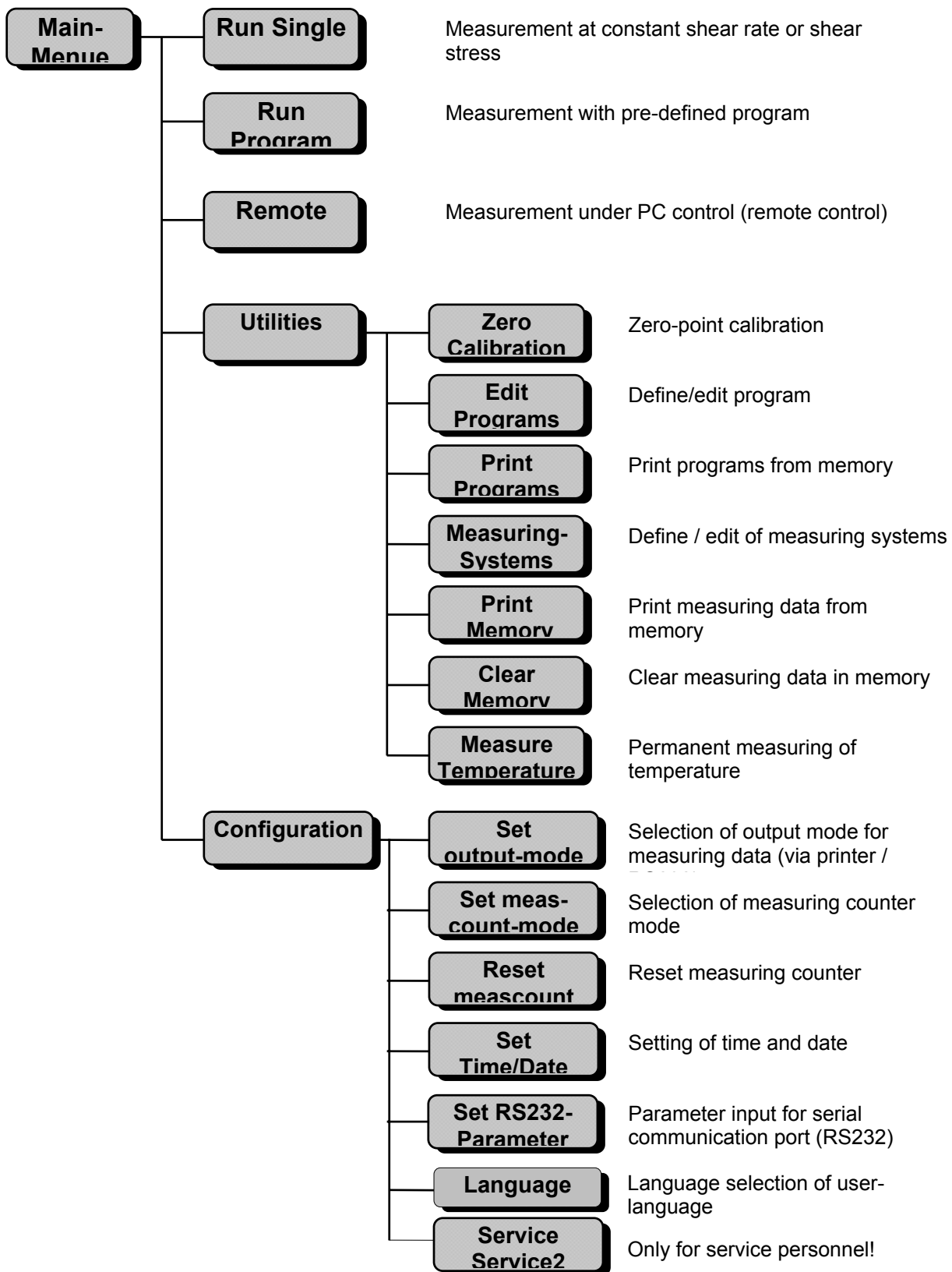

This page demonstrates organization of R/S Rheometer menu system.



Menu handling

Because LCD display of R/S Rheometer cannot show simultaneously all menu items, only part of the menu (three entries) is always displayed. Two arrows ">" at the right side of display inform you, if there are still entries in the menu, either above (the arrow in the 2nd line), or below (the arrow in the 4th line).

Currently active (but still not selected) entry is marked by blinking black field (cursor) at the left part of LCD.

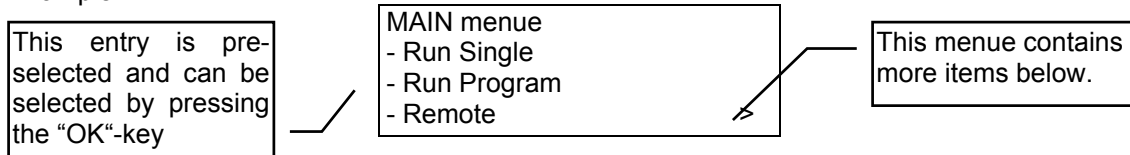
Example:



Using  and  keys you can move cursor upwards and downwards in the menu until desired menu item is reached.

Note: If there are more menu entries in the menu and you are reaching the end of the display, next part of menu is opened automatically (scrolling).

You can "start" the pre-set menu entry or open with  key.

The major menu (getting active ca. 10 seconds after switching on the instrument) is the MAIN menu.

In the case, you are in a submenu and wish to return to upper menu, press  key.

Example:

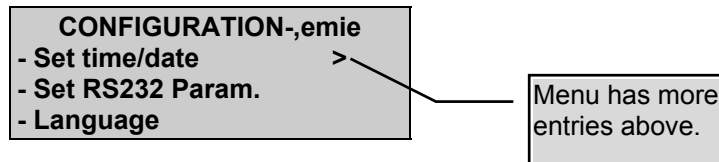

Press , you return back to MAIN-menu.

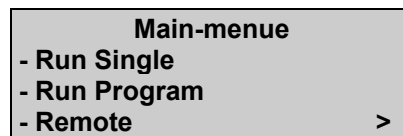

If you push  key now, the "Run Single" function is started.





Before we come to detailed description of this functions like "Run Single" (see Chapter 6.5), it is worth to explain, how to input numbers and alphanumeric texts as well as select from a list, because majority of the Rheometer functions require such actions from the user before execution of a desired function.

VI.3 Selecting from Lists

If the Rheometer wants you to select an entry of a list, there are the same rules and functions of LCD and keyboard as in menu operations.

- Selection from a list is requested, for example at:
- Selection of a measuring system for measurements in "Run Single" or "Edit Program";
- Selection of pre-set values for measurements in "Run Single" or "Edit Program";

- Selection of a program or a measuring system you want to edit in “Edit Program” and “Meas. systems”;
- Answering a request “YES” ↔ “NO”.
- Selection of a program to start in “Run Program”

Keys  and  move cursor (= pre-selected entry) in the list upwards and downwards.
Key  selects the pre-set entry from the list and  key interrupts selection from the list (only if possible).

As well as in the menu, an arrow in the right part of LCD display shows if there are still more elements of the list above or below the marked element.

Example for selection from a list: Selection of a measuring system.

```

Select Measuring system:
1) CC48 >
2) DG
3) CC45 >
  
```

VI.4 Input of numerical values and alphanumeric texts

Majority of inputs, requested from user, are input of numbers. Pre-set values (e.g. start and end values of a slope), times, number of measurement points, factors, time, date, etc. are set as numbers with or without decimal digits.

If LCD display shows the decimal point “.” in a number to be entered, input of floating point number is requested.

However, number of digits after decimal point is fixed to number of displayed decimal digits, the decimal point cannot be moved.

Cursor (= the digit to be changed) is here a bar under the digit.



In the following example, the set value for Single Program measurement is to be adjusted by Digit Input. We want to enter the value 290.00 s⁻¹ for Shear Rate.

```

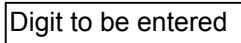
Input Values:
Val.[1/s]: 0100.00
Nr. of MP: 010
Time[s]: 0100
  
```





The cursor is located under “1” in the value of shear rate to be set (currently 100.00 s⁻¹).

Using  and  keys one can change “1” (increment or decrement).

We push 1x  and get:

```



Input Values:
Val.[1/s]: 0290.00
Nr. of MP: 010
Time[s]: 0100
  
```

Using  and  keys you can move cursor leftwards (rightwards). To process the next digit we push now  key and get:

```
Input Values:
Val.[1/s]:0200.00
Nr. of MP: 010
Time[s]:0100
```

Now we can process the next digit. In order to insert here “9” it’s advisable to decrement once current “0”, rather than to increment it nine times. So, we push  key and get:

```
Input Values:
Val.[1/s]:0290.00
Nr. of MP: 010
Time[s]:0100
```

Note: In the case, you push and hold one of the keys  or  the cursor-underlined digit will first increment or decrement for +/- 1 only. However, after short period of time, the digit is automatically changed. This corresponds to the **Repeat Function** of the computer keyboard. In our example you could also push and hold  key until “9” will be displayed.

Now, when the desired number is displayed we can enter it by pressing  key. In our example cursor now jumps to the first digit of the next value of user input (here Number of Measpnts).

```
Input Values:
Val.[1/s]:0290.00
Nr. of MP: 010
Time[s]:0100
```

Alphanumeric inputs

(= text with or without numeric digits) are identical to digit inputs. However, in this case, currently selected digit could not only be changed from “0” to “9”, but also to “A” to “Z” and to blank symbol “ ”.

Selectable values for alphanumeric input digit in order of increase:

“ ABCDEFGHIJKLMNOPQRSTUVWXYZ1234567890”

If for example, your current digit is “B” and you want to input “7”, you have to hold  key until desired “7” will appear at the display.

Alphanumeric inputs are requested for example to give a program, measuring system or measurement a name.

VI.5 Menu entries (MAIN menu)

Menu entries (see Menu System in Chapter 6.2) may either contain submenus (e.g. “Utilities” or “Configuration”) or directly executing of one of the Rheometer’s functions.

At Tree Chart in Chapter 6.2 all gray fields without further right branches serve to call functions. Those ones with right branches are submenus.

Let us remind keyboard layout from Chapter 6.2. Using Δ and ∇ keys we move cursor (black rectangle) upwards and downwards, and OK key we start (activate) function (if the current selection is a submenu, we open it, otherwise the function of the Rheometer starts). Functions of R/S Rheometer are described in detail elsewhere in this Chapter.

VI.5.1 MAIN-Menue \rightarrow Run Single

This function carries out a measurement of shear stress or shear rate at constant preset values. The physical units of preset values may be selected from:

| | |
|----------------|-------------------------------------|
| - shear rate | D [s^{-1}] |
| - speed | n [rpm] |
| - shear stress | Tau [Pa] |
| - torque | M[‰] [1000 ‰ correspond ca. 50 mNm] |

Before you start the measurement itself you have to input the following values:

- Selection of the measuring system used at the instrument (selection from the list, operation - see Chapter 6.3)
- Selection of physical units of preset value (see above, selection from the list, operation, see Chapter 6.3). Here you have to decide, if you want to carry out a shear rate measurement (shear rate, speed) or a shear stress measurement (shear stress, torque).
- Input of preset values (input of numbers, operation, see Chapter 6.4) D [s^{-1}] The range of the value depends on the measuring system
- n [rpm] 0.7... 800 rpm (U/min)
- Tau [Pa] The range of the value depends on the measuring system
- M[‰] 0 ... 999 ‰
- Input of desired number of measured points (input of numbers, operation, see Chapter 6.4) Input of the measurement duration in seconds. Here it is necessary to take into account, that minimal duration of the measurement depends on kind of the measurement and on number of desirable measurement points. For minimal duration between 2 measurement points it is valid
- Shear stress measurement $t_{MP} \geq 1$ s
- Shear rate measurement $t_{MP} > = 4$ s

Note: The more is the time period between 2 measured values, the more is the precision of physical values determined!

(input of numbers, operation, see Chapter 6.4)

- Input of ID (identification text of the measurement). Here you can input textual notes of the measurement (max. 15 characters). (Alphanumeric input, operation - see Chapter 6.4)

If you have passed these points, before starting a measurement, the Rheometer will indicate, where the measure points will be written to.

Output of MPs to:
-No output device
-Memory
<^> Menu <ST> Start

At this point you either can start a measurement by pressing **[ST]** key, or return back to Main menu using **[Δ]** key.

In this example, we see that the measurement data will be saved in Memory only. No other output device is defined. Output devices are printer or serial interface RS232 of the Rheometer. Selection of these devices is described in Chapter "Configuration -> Set output mode".

In case, the Memory is full with measurement data, you have to cancel function Run Single, print out the measurement data from the memory or send data to a PC via serial interface (see Chapter "Utilities → Print Memory") and then delete measurement data from the Memory (see Chapter "Utilities → Delete Memory").

However, you can start a measurement even with full Memory, in this case measurement results will be shown only at LCD display and will be lost after completion of the measurement (because no output device archives measured data).

If you start the measurement, the instrument shows:

Prog. Running...
Wait for 1.MP
#1

This message will be displayed until the first measurement point is calculated.

First Measure point is displayed like this:

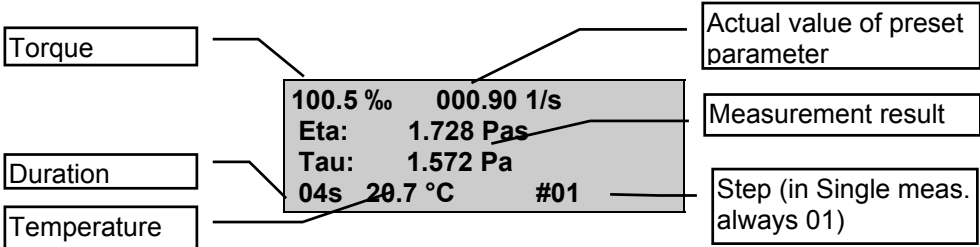

If torque is less than 10 ‰ measurement results are often of low precision. In this case, preset values are to be changed in such a manner, that the torque is higher than 10 ‰.

If the display field for the torque indicates: "M low!", these values are outside the range of resolution of the Rheometer.

If the temperature is not to displayed, the measuring sensor is not connected.

At printout, the temperature is printed as **1000.0°C!**

The display is updated on every new measure point. Current measurement can be canceled at any time by pushing **[ST]** key.

After measurement, or after a break, the display field for Step indicates “END” or “BREAK”. The Display toggles in intervals of about 4 seconds between last displayed measure point and a measuring end information like this: angezeigt:

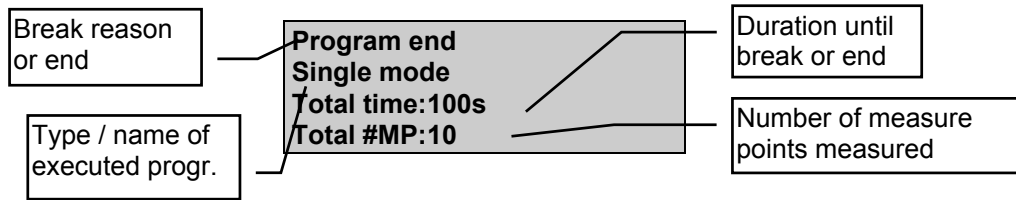

By pressing **OK** key you return to the MAIN-Menu.

Note: The last selected program parameters remain nonvolatile in the instrument memory also after switching off the Rheometer.

VI.5.2 MAIN-Menue → Run Program

This function starts measurements, which were previously defined as a program. Contrary to “Run Single”, here you can also set values as a linear function of time, for example $D[s^{-1}] = f(t)$. It is advisable to use function Run Program always when you want to carry out repeating measurement series with the same preset values and with the same measuring system. The second option is used when a user can carry out measurement without large previous information of rheology. Actually, not every person, starting a measurement, has unlimited possibilities to determine correct preset values and measurement system for a medium under study (optimal use of measurement range, irreversible rheological changes of the substance studied, etc.). 4 standard programs can be defined. How to define or to edit program is described in Chapter “Utilities → Edit Program”.

Function Run Program starts one of the programs defined in memory. If there is no program available, the following error message is displayed:

**No valid program!
Enter program first!**

In such a case, you first have to define a program (“Utilities → Edit Program”). Use **OK** key you return back to the Main menu.

However, if programs are available, the list for selection of programs, stored in the memory, appears. Here you must select the program to start (selection from the list, operation see Chapter 6.3).

Select program
1) Prog xyz
2) Test
3) Prog Öl 2000>

Press **OK** key to select the preselected program (here the program named “Test”), this operation will be followed by ID input (identification text of the measurement).

You can give your measurement a name (max. 15 characters) (alphanumerical input, operation see Chapter 6.4).

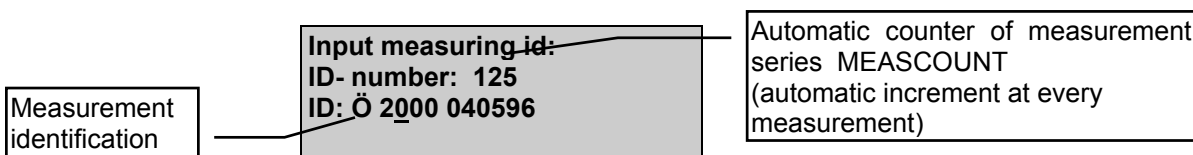

If you have passed these points, before starting a measurement, the Rheometer will indicate, where the measure points will be written to.

Output of MPs to:
-Printer
-Memory
<^> Menue <ST> Start

At this point you either can start a measurement by pressing **[ST]** key, or return back to Main menu using **[Δ]** key.

In this example we see, that measurement points will be saved in the memory and will be printed at the printer, so be sure that printer is connected to the Rheometer and ready for operation (=output device). Output devices are printer or serial interface RS232 of the Rheometer or no device (no output device). Their preliminary selection is described in Chapter “Configuration → Set Output Mode”.

In case, the Memory is full with measurement data, you have to cancel function Run Single, print out the measurement data from the memory or send data to a PC via serial interface (see Chapter “Utilities → Print Memory”) and then delete measurement data from the Memory (see Chapter “Utilities → Delete Memory”).

However, you can start a measurement even with full Memory, in this case measurement results will be shown only at LCD display and will be lost after completion of the measurement (because no output device archives measured data).

If you start the measurement, the instrument shows:

Prog. running...
Wait for 1.MP
#1

This message will be displayed until the first measurement point is calculated.

First Measure point is displayed like this:

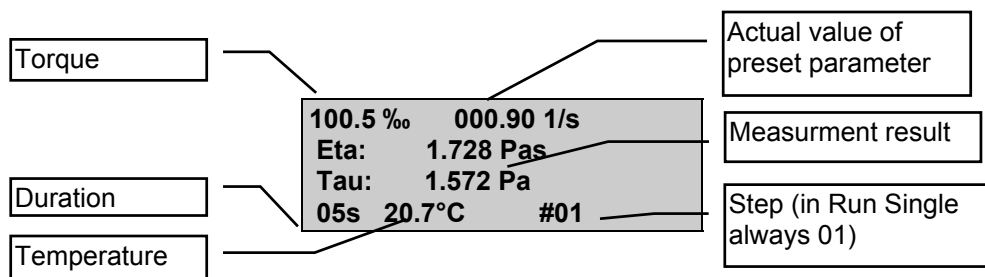

If torque is less than 10 ‰ measurement results are often of low precision. In this case, preset values are to be changed in such a manner, that the torque is higher than 10 ‰.

If the display field for the torque indicates: “M low!”, these values are outside the range of resolution of the Rheometer.

If the temperature is not to displayed, the measuring sensor is not connected.

At printout, the temperature is printed as **1000.0°C!**

The display is updated on every new measure point. Current measurement can be canceled at any time by pushing **[ST]** key.

After measurement, or after a break, the display field for Step indicates “END” or “BREAK”. The Display toggles in intervals of about 4 seconds between last displayed measure point and a measuring end information like this:

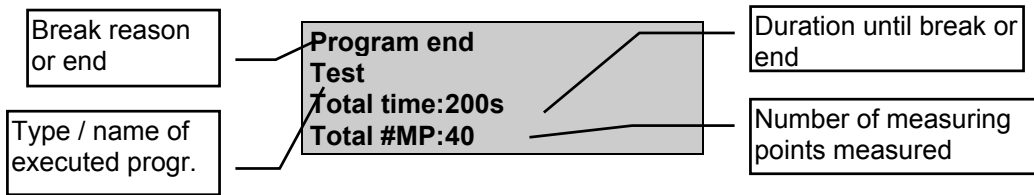

By pressing **OK** key you return to the MAIN-Menu.

VI.5.3 MAIN menu → Remote

Function Remote serves measurement under PC control. In this operation mode all functions of the R/S Rheometer are controlled by a PC. In order to carry out PC-controlled measurements, you need program package RHEO 2000 for R/S Rheometer. This software operates under operational systems Microsoft™ “Windows 3.x and Windows 95 or 98.

More detailed information of RHEO 2000 software you will get from your supplier.

After selection of menu option “Remote”, the Rheometer shows following display:

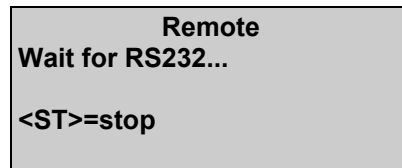

Now the Rheometer waits for communication with a PC. The data between a PC and the Rheometer is transferred via serial interface RS232 of the R/S Rheometer.

If you have RHEO program package, you can start now the MEASURE/ANALYSIS program on PC.

At any time you can cancel REMOTE operation with **ST** key. But caution: current measurements are also canceled by **ST** key in REMOTE operation.

After completion of communication with the PC, LCD display shows: “Remote done ...” and you can again return back to the Main menu with **ST** key.

During measurement with PC in REMOTE operation LCD display of the Rheometer indicates some of preset values. These values, however, are not relevant for the user and serve for information in case of occurring problems.

VI.5.4 MAIN menu → Utilities

Entry to open “Utilities” submenu - see Chapter 6.6.

VI.5.5 MAIN menu → Configuration

Entry to open “Configuration” submenu - see Chapter 6.7.

VI.6 Menu entries in the Utilities-Menu

Utilities menu, as its title presumes, contains several useful functions corresponding to measurements.

The entries:

| | |
|----------------------------|---|
| • Zero Calibration | Executes zero-calibration of the Rheometer |
| • Edit Programs | input and editing of programs (which can be started with Run Program) |
| • Print Programs | prints all parameters of all programs in memory at the printer |
| • Measuring Systems | input of measuring system's parameters or generation of new measuring systems |
| • Print Memory | output of measurement data from memory to the printer or to serial interface |
| • Delete Memory | clears measurement data in memory |
| • Measuring Systems | Measures temperature without rheological measurements |

Chapters below explain these functions more detailed.

VI.6.1 Utilities → Zero Calibration

The function “Zero calibration” serves to calibrate the Rheometer zero point. This function continues for approximately 10 minutes and should be done once a week.



Before starting this function, ensure that R/S Rheometer was warmed-up for not less than 10 minutes and that no measuring system is connected to RC20's measuring bob coupling.

The requirement, that a measuring system is removed, is confirmed after checking once more by pressing **OK** key (= start of zero point calibration) or pre **ST** key to return back to Utilities menu.

Zero point calibration is performed automatically. The progress of calibration is shown as executed step of total steps to be executed.

In the case of an error message occurs while calibrating you should start zero point calibration again. In the case, the error message is displayed again, there is a critical system fault (=>Repairs).

After a successful calibration, the message on its completion is displayed and values of the zero point are saved internally. These values are saved till the next calibration.

Push **OK** key to save values or any other key to return back to Utilities menu without saving.

Note:

At any time you can cancel zero point calibration by **ST** key. Zero point values, determined up to this moment will be ignored.

VI.6.2 Utilities → Edit Programs

This function is for input of new or for edition of already existing programs. The programs can be started after successful installation via the menu entry “Run Program” in the main menu.

The following values are preset in a program:

- measuring system to be used in the measurement
- Number of steps
- start and end value of each step
- Number of measurement points for each step
- Duration of each step

preset value as a function of time:

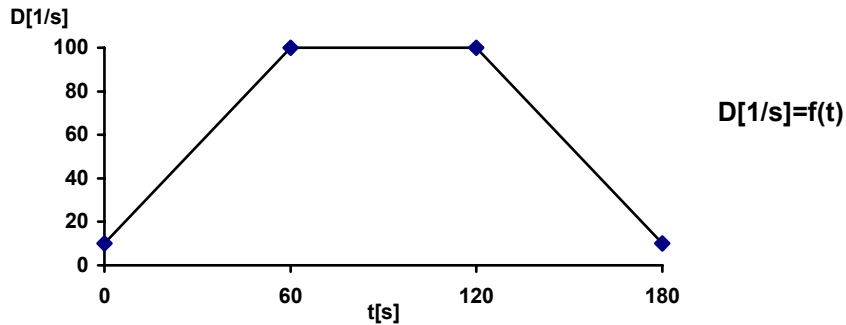

As an example, we would like to consider a standard measurement.

1. Step: shear rate increases within 60 sec from 10.00 to 100.00 s⁻¹.
2. Step: shear rate remains at the level of 100.00 s⁻¹ for 60 sec.
3. Step: shear rate decreases again within 60 sec from 100.00 to 10.00 s⁻¹.

This measurement consists of 3 steps.

This example might be used to consider program input.

However, besides the shear rate $D [s^{-1}] = f(t)$, preset value can also be defined as:

Speedn[rpm]=f(t)
 TorqueM[%]=f(t)
 Shear stressTau[Pa]=f(t)

Slopes and plain parts of the preset values are linear, measurement point is also defined linear, i.e. there is no possibility to define logarithmic measurements. For logarithmic measurement you need RHEO program package.

Preset value substeps in a defined step according to the following equation:

$$\Delta \text{Preset Value} = \text{End Value} - \text{Start Value} / (\text{Number of Measuring points} - 1)$$

where $\Delta \text{Preset Value}$ is the difference between preset value of measurement point n and measurement point n+1.

The first **preset value** (=the first measurement point) is always the start value of the slope, the last measurement point is determined by the end value. As for our example, in order to reach the values $D=10, 20, 30, \dots, 100 [s^{-1}]$ we need $\Delta \text{Preset Value}$ of $10 [s^{-1}]$. So we need 10 measurement points. Sample: $100-10/(10-1)=10$.

$$\text{Number of Measurement Points} = (\text{End Value} - \text{Start Value}) / \Delta \text{Preset Value} + 1$$

(for slopes only)

Let's return back to the example.

After selection of the menu point "Edit Program" you will be requested to select a program from the list of all programs available, which you want to generate or to edit.

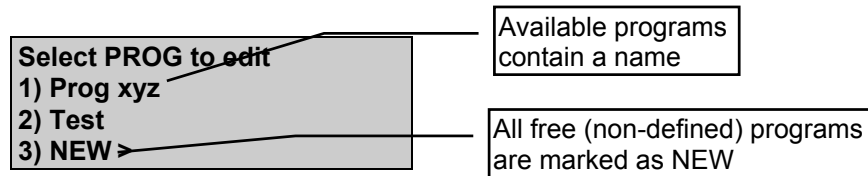

All free memory parts are marked as NEW. In order to avoid overwriting of already available programs, please, select a NEW program to be edited.

After selection of the program with **OK** key you will be requested to select a measuring system.

Attention: the program has to be executed later with the same measuring system, otherwise senseless measurement results will be calculated.

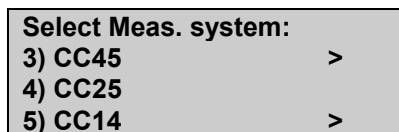

After selection of the measurement system, input of number of steps requested (=number of slopes and planes of the function).

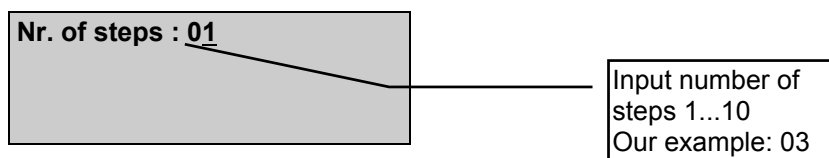

Number of steps can be from 1 to **maximum 10 steps**.

In our example we need 3 steps. So, number "01" must be changed to "03". (Input of numbers - see Chapter 6.4).

If you try to input numbers <1 or >10, an error message "Range-Error" will appear.

After successful input of number of steps, selection of kind of measurement is carried out:

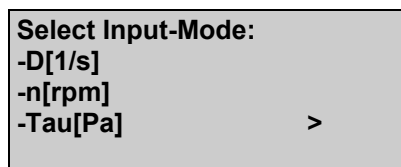

| Possible types of measurement | | Range of parameters preset |
|-------------------------------|----------------------|-------------------------------|
| Shear rate | D [s ⁻¹] | Depending on measuring system |
| Speed | n [rpm] | 0.7 ... 800 rpm |
| Shear stress | Tau [Pa] | Depending on measuring system |
| Torque | M [‰] | 0 ... 999 promille |

So selectent (in our example) "D[1/s]" and press **OK** key. Now, you have to define each step.

For every step, there are the following inputs:

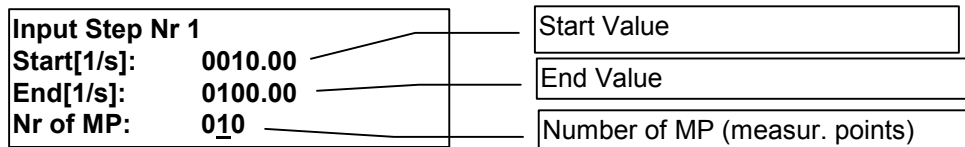

(input of numbers: see Chapter 6.4)

Minimum- and maximum-values of start values and end values depend on selected measuring system for shear rate ($D[s^{-1}]$) and shear stress ($\tau[Pa]$). At input the Rheometer checks start and end values (if these values lie within due range) and indicates error message "Range-Error" if out of range:

Range-Error

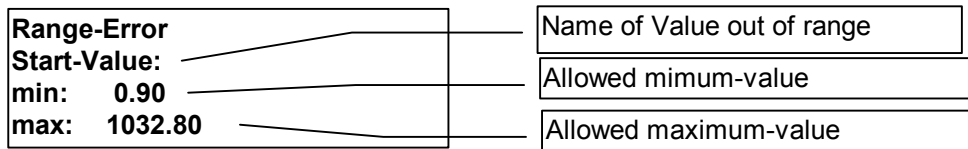

This message will be indicated, for example, at input of the start value $D[s^{-1}]$ with measuring system CC25, which lies outside the range of 0.9 ... 1032.8 s^{-1} .

However, in the case, start value, end value and number of measurement points were input correctly, the request for input of step duration will be indicated:

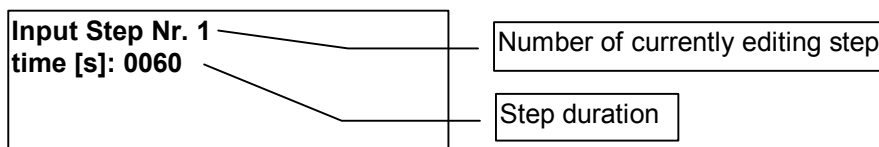

Minimum step duration:

| | |
|----------------------|---|
| D [s ⁻¹] | tmin = number of measurement points * 4 s |
| n [rpm] | tmin = number of measurement points * 4 s |
| Tau [Pa] | tmin = number of measurement points * 1 s |
| M [%] | tmin = number of measurement points * 1 s |

Maximum step duration allowed is: **3600 s**

The duration value is automatically checked for the correct range (dependent on number of meas. points). At wrong input, the "Range-Error" message will be indicated, accompanied by allowed values.

Attention: The more time between two measuring points, the higher precision of determination of physical parameters!

This procedure of input Start-, End-Value, Number of MP, time is repeated for each step.

Finally the Program must be named and saved:

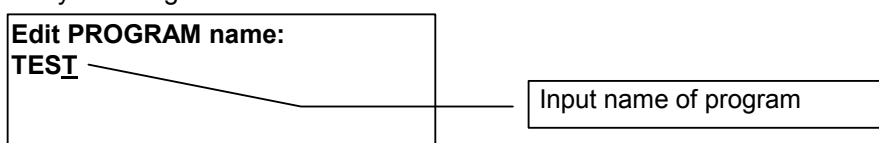

(for input of alpha-numerical texts see Chapter 6.4)

Saving of the Program:

(2) TEST
Press <OK> to save

If you push **OK** key now, the Program will be saved. If you push any other key, the entries are abandoned and previous parameters remain (the current ones, before the edit).

VI.6.3 Utilities → Print Programs

This function prints the parameters of defined programs in memory at the printer. Be sure that printer is connected to the Rheometer and ready for operation.

In the case, the printer is not ready for operation at launching “Print Programs” function, the error message will be indicated:

ERROR #1
Printer not ready!
<OK> cont. <ST> stop

In case, this error message appears, please ensure, that the printer is ready and its sheet feeder contains paper.

Press **OK** key to try printing again or push **ST** key to return back to the Menue.

VI.6.4 Utilities → Measuring systems

With this function you can create new measuring system or change already defined measuring systems.

Measuring systems are represented by following values. This values might be edited:

- Name of measuring system
- Shear rate factor K_γ [min/s](k_gamma)
- Shear stress factor $\tau_{\%}$ [Pa](tau_prom)



Only authorized personnel is permitted to change constants of the measuring system!

After starting the function you will be prompted to select the measuring system you want to edit. Select the list item “NEW” to generate a new measuring system.

Select Meas. system:
3) CC45 >
4) CC25
5) CC14 >

After selection of the measuring system, you will be requested to input sequentially: its name, tau_prom and k_gamma.

```
Enter Meas. Sys. #4
Name: CP25
tau_prom: 01.1418
k_gamma: 01.2910
```

The measuring system name is a alpha-numerical entry, factors tau_prom and k_gamma are input as numerical entries (see Chapter 6.4).

When done, a security request follows, if you really want to save new parameters.

```
PRESS <OK> to save
Name: CC25
tau_prom: 01.1418
k_gamma: 01.2990
```

Using **OK** key you can save the changes, otherwise, using **ST** key you can return to the Menu, without saving.

VI.6.5 Utilities → Print memory

This function serves output of measuring values from internal memory to the printer, connected to the Rheometer, or to the serial interface RS232 of the Rheometer.

First, you will be requested to select the output device, where you want to transfer the measuring values to.

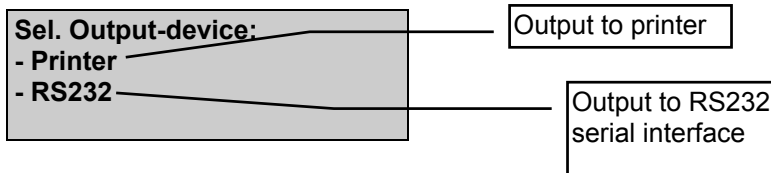

- a) Output to printer:
The printer must be connected to the Rheometer and be ready for operation.
- b) Output to the serial interface RS232:

Data receiving device (mostly a PC) must be adjusted to same data transfer parameters as R/S Rheometer and be ready for receiving data, because the data transfer of the Rheometer to the receiving device is carried out without handshaking. If the receiving side is not ready or is not adequately tuned, the data will be transmitted “into emptiness”. (See also Chapter 6.8 “Serial data transfer”).

If you have chosen the output device, you have to select the measuring series to transfer. All available data is displayed in a list.

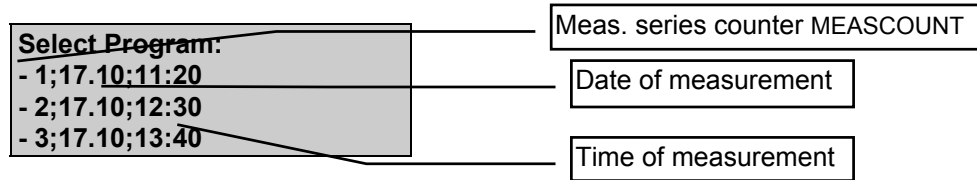

After selection of a measurement series, the data of the series will be printed as Table or transferred via the serial interface.

After completion of data transfer the Rheometer returns to Utilities Menue.

VI.6.6 Utilities → Clear memory

This function deletes all measured data stored in the memory of the R/S-CPS Rheometer.

Before deleting, please ensure that the measurement data have been archived on printer or PC. (see Print Memory, the last chapter).

Before the final deleting from the memory the following security request is indicated:

A rectangular box with a black border containing the text: "Clear Memory?" followed by two bullet points: "- NO" and "- YES".

If you select "YES" entry, the memory of measuring results will be erased, otherwise you will return back to the Menue without deleting.

VI.6.7 Utilities → Measure temperature

This function serves measurement of temperature with the temperature sensor, connected to the Rheometer.

After starting this function, permanent temperature measurement is performed:

A rectangular box with a black border containing the text: "Temperature:" followed by "20.5 °C" on the next line, and "<OK> return" on the third line.

Pressing key you return back to Utilities-Menue

VI.7 Menu entries of the CONFIGURATION menu

The Entries:

- **Set output-mode** sets output-mode of measuring data at the time of measurement into the printer or into the serial interface.
- **Set meascount-mode** sets the counter mode (if the MEASCOUNT counter of measuring series will be daily cleared or not).
- **Reset meascount** reduces the MEASCOUNT counter of measuring series by 1.
- **Set time/date** Input of date and time
- **Set RS232 Param.** Sets data transfer parameters for the serial interface RS232
- **Language** Selects user language of Rheometer (English/German)
- **Service, Service2 for service personnel only**

In the following chapters these functions are explained in more details.

VI.7.1 Configuration → Set output mode

This function serves definition of output device (printer, serial interface) which will receive measurement results while measuring. These settings do not depend on measuring values, being saved in the inner memory of measurement data, i.e. when you set the output device, measuring points are saved nevertheless in the inner memory of measurement results (if there is available memory). Selection of an output device is the additional output of measurement values to the printer or the serial interface RS232 at the time of a measurement.

At starting this function you may choose between possible output devices:

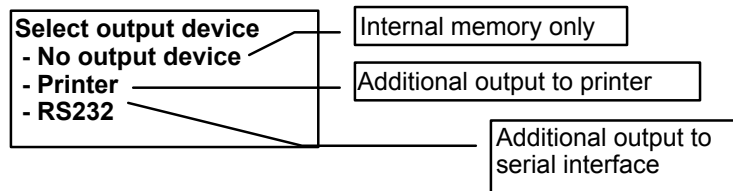

If you have selected an output device, your selection is saved in the instrument by pressing **OK** key.

This selection remains stored even after switching off the instrument!

Currently set output device is indicated before start of every measurement (see also “Main → Run Single” and “Main → Run Program”).

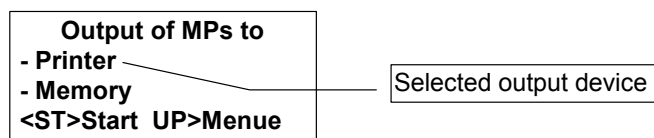

After selecting an output device you have to make sure before the start of every measurement that:

- a) for output to a printer, the printer is connected to the Rheometer and is ready for operation. If the printer is not ready, you cannot start the measurement.

b) for output to the serial interface (RS232), the receiving device (normally a PC) is set to the data transfer parameters of the Rheometer (see chapter 6.7.5 "RS232 Parameters") and ready to receive data. If the receiving side is not ready, the data will not be transmitted or will be transmitted to Null. (See also chapter 6.8 "Serial data transfer").

VI.7.2 Configuration → MeasCount mode

Measurement series counter MEASCOUNT is a counter, increasing its count by 1 when starting a measurement. Measurement series counter serves, as well as ID of the measurement for identification of a measurement series. Counters' count rises until automatic or manual reset ("Reset meascount") will be performed.

Using the function "Set meascount-mode" you set the counter mode (if the measurement series counter will be daily reset or not).

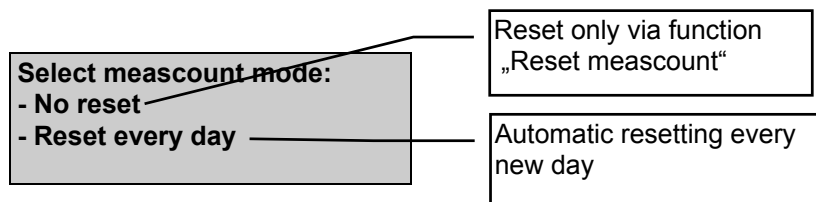

After choosing one of two reset modes you again come to the Configuration-Menu.

VI.7.3 Configuration → Reset meascount

This function resets the measurement series counter (regardless a MEASCOUNT mode set) = manual reset of the measurement series counter.

No further selections or settings are required.

VI.7.4 Configuration → Set Time/Date

This function allows the user to set the internal clock and internal calendar.

Setting of time is carried out in 24 hour format.

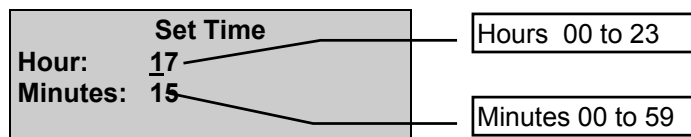

Setting of date is carried out as dd.mm.yy. :



After setting time and date you will be requested if you want to set clock for new time.

```
New Time/Date
17:15 17.03.01

Press <OK> to save
```

Using key, you can set new time, or using key you can return back to the menu without saving.

Note: New time is input into the clock only after pressing key. When pressing the key, time starts running with seconds=00.

VI.7.5 Configuration → Set RS232 Parameter

This function allows changing communication parameters of the serial interface.
The serial interface operates **without handshake**.
Data are transferred as **ASCII-texts**.

Parameters to set:

| | |
|-------------------|---|
| Baud rate [Baud]: | 110, 150, 300, 600, 1200, 2400, 4800, 9600, 19200 |
| Parity: | n(=no parity), e(=even), o(=odd) |
| Stopbits [Bit]: | 1 or 2 |
| Databits [Bit]: | 7 or 8 |

The standard setting is:

Baud rate= 4800
Parity= n
Stopbits= 1
Databits= 8

Caution: If you changed these settings, you have also to set new transfer parameters of the receiving device!

After starting the function "Set RS232 Param." you will be requested to input the baudrate:

```
RS232: 4800,8,n,1

Change RS232-Par.?
<OK>YES  <ST>NO
```

With key you start change of parameters.

You have to select following parameters:

- Baudrate [Baud] : 10, 150, 300, 600, 1200, 2400, 4800, 9600, 19200
- Databits [Bit]: or 8
- Parity: (=none), e(=even), o (=odd)

- Stopbits [Bit]: 1 or 2

Choose the requested parameter from the list of available values and select it by pressing **OK** key.

Example Baudrate:

```
Baudrate:
-4800
_9600
-19200
```

After selecting all parameters, new setting of communication parameters is displayed:

```
RS232: 19200,8,n,1
<OK>=storing
```

with **OK** key you transfer this parameters to nonvolatile memory of R/S Rheometer.

These changed transfer settings will be saved into memory and will remain in the memory also after switching off the instrument.

VI.7.6 Configuration → Language

This function selects the user-language of R/S Rheometer. Languages available are:

- English
- German

Choose desired language and press **OK** .

VI.7.7 Configuration → Service, Service 2

This function is only for service-personnel. Password protected!

VI.8 Serial Data transfer via Interface RS232

Serial data transfer has to be used only in the case, when a user has basics of knowledge on data processing and is capable to change data transfer parameters of sending and receiving sides, by him/herself.

Successful data transfer can be achieved only in the case, when a transmitter (=R/S Rheometer) and the receiver (e.g. a PC) comply to the following:

1. Instruments are connected with supplied interface cable. Caution: While making the connection, both instruments must be switched off! (Pin layout: see Appendix to this documentation).
2. The transmitter (R/S Rheometer) and the receiver are configured to identical data transfer parameters (for R/S Rheometer see Chapter 6.7.5. "Set RS232 Parameter").

3. The receiver is ready for reception and can (due to sufficient PC and memory capacity) receive or save received data at selected baudrate.

It is worth to demonstrate reception with the help of Terminal program under Microsoft™ Windows.

1. Switch off the Rheometer and PC.
2. Connect the Rheometer (connector RS232 at the instrument back side) and one of free serial interface (e.g. COM2) of the PC. Here use only the data link (supplied by BROOKFIELD as an accessory).
3. Switch on the PC and the Rheometer.
4. Set data transfer parameters at the Rheometer (see Chapter 6.7.5). Here: Standard setting 4800 Baud, Parity n, Stopbit 1, Databit 8
5. Select RS232 interface as the output device at the Rheometer (see Chapter 6.7.1).
6. Start WINDOWS operating system at your PC.
7. Open "Accessories" program group.
8. Start "Terminal" program.
9. Choose menu option "Settings" → "Data transfer"

First the window appears, where you can input data transfer parameters:

- select under "Connection" the COM-port, connected to the Rheometer.
- set "Baudrate" to "4800"
- set "Databits" to "8"
- set "Stopbits" to "1"
- set "Parity" to "no parity"
- set "Protocol" to "no"
- deactivate "Parity check" checkbox (if crossed)
- deactivate "Carrier signal detection" checkbox (if crossed)
- finish input by "OK"

10. Select the Menu option "Settings" → "Terminal Settings"

The window appears, where the terminal functions are set:

- scroll and select "Germany" option
- activate "IBM in ANSI" (if not crossed yet)

11. Now you can save parameters of Terminal program, changed up to this time, under the Menu option "File" → "Save" and set the file name, e.g. "RC20.TRM".

(At the next start of the Terminal program, you can open this file with "File" → "Open" and load data transfer parameters for the R/S Rheometer.)

12. Now select the Menu option "Transfer" → "Text file reception".
 - input the file name, under which you want to save the data sent from the Rheometer (e.g. "TEST.TXT").
 - In the status line of the Terminal program, the message appears now "receiving: TEST.TXT"
13. The Terminal program is now ready to receive data (for more detailed instructions or troubleshooting on the Terminal program - please read your Windows-documentation).

14. Start measurement at the Rheometer.

Measurement points must now be seen as text at the PC display after a short period of time.

15. After completed data transfer of one or several measurements into the selected text file, break the data transfer and end the Terminal Program.

If it is necessary to select some other receiver for serial data transfer (not a PC), pin layout of this receiver must be checked before the connection. You can find pin layout of the serial interface plug and pin layout of the data link in the Appendix to this documentation.

VII. Measurements

VII.1 Measuring in manual mode

To carry out measurements in manual mode you can act in correspondence with the following brief instructions:

Measurement control:

- Fasten the R/S Rheometer at stand (see Chapter 3).
- Connect the AC adaptor (see Chapter 3).
- Connect, if necessary, the printer (see Chapter 3).
- Fill and mount the standard measuring system (see Chapter 5).

Point to the fact that any substance or solvent do not ingress into measuring bob coupling, measuring drive or electronics.

- Wait for temperature control till the attainment of the desired temperature in the measuring substance.
- Start a program or a single measurement (see Chapter 6).
- After ending of the measurement and switching off of the temperature control wait till the cooling/warming of the medium to room temperature.
- Remove and clean the measuring system.

Measurement with “FTK-CC”

- Fasten the R/S Rheometer at stand (see Chapter 3).
- Connect the AC adaptor (see Chapter 3).
- Connect, if necessary, the printer (see Chapter 3).
- Mount the temperature control device “FTK-CC” and connect, if desired, the built-in Pt100 (see Chapter 3).
- Fill and mount the standard measuring system (see Chapter 5).

Point to the fact that any substance or solvent do not ingress into measuring bob coupling, measuring drive or electronics.

- Check the presence of temperature control medium and cooling liquid (if cooling device is used).
- Wait for temperature control till the attainment of the desired temperature in the measuring substance.
- Start a program or a single measurement (see Chapter 6).
- After ending of the measurement and switching off of the temperature control wait till the cooling/warming of the medium to room temperature.
- Remove and clean the measuring system.

Measurement with cone/plate measuring device “ME-CP/PP”

- Fasten the R/S Rheometer at stand (see Chapter 3).
- Connect the AC adaptor (see Chapter 3).
- Connect, if necessary, the printer (see Chapter 3).
- Mount the cone/plate measuring device “ME-CP/PP” and connect the built-in Pt100 (see Chapter 3).
- Mount, adjust and fill the standard measuring system (see Chapter 5).

Point to the fact that any substance or solvent do not ingress into measuring bob coupling, measuring drive or electronics.

- Check the presence of the temperature control liquid.
- Wait for temperature control till the attainment of the desired temperature in the measuring substance.
- Start a program or a single measurement (see Chapter 6).
- After ending of the measurement and switching off of the temperature control wait till the cooling/warming of the medium to room temperature.
- Remove and clean the measuring system.

VII.2 Measuring in Remote-mode

Measurement in remote control mode:

- Fasten the R/S Rheometer at stand (see Chapter 3).
- Connect the AC-adaptor (see Chapter 3).
- Connect the data link cable between Rheometer and PC.
- Switch on the R/S Rheometer and select the menu point "**Remote**".
- Switch on computer and all peripheral devices.
- Start the RHEO 2000 Software.
- Load a program in the RHEO 2000 Software
- Fill and mount your measuring system standard measuring system (see Chapter 5).

Point to the fact that any substance or solvent do not ingress into measuring bob coupling, measuring drive or electronics.

- Check the presence of the temperature control medium and cooling liquid (if cooling device is used).
- Wait for temperature control till the attainment of the desired temperature in the measuring substance.
- Start the program.
- After ending of the measurement and switching off of the temperature control wait till the cooling/warming of the medium to room temperature.
- Remove and clean the measuring system.

VIII. Technical data

| R/S Rheometer | |
|--|--|
| Dimensions | 480 mm x 300 mm x 290 mm |
| Weight | 8 kg |
| Nominal operating voltage Power consumption (average) Power consumption (maximum) | +/- 15 V, 5 V 12 W 22 W |
| Ambience conditions Temperature in operation out of operation Relative humidity (not condensable) in operation out of operation | 10° to 40°C 10° to 45°C 20% to 80% 10% to 90% |
| Accuracy | ± 1.0 % of maximum range value ± 1 digit |
| Torque range Mains operation | 0.05 to 50 mNm |
| Torque resolution | 0.01 mNm |
| Speed range | 0.7 min ⁻¹ to 800 min ⁻¹ |
| Angle resolution | 0.8 mrad |
| Temperature range | Depending on temperature control device used -20°C to +180°C |
| Shear rate range | Depending on measuring system used 0.9 s ⁻¹ to 4 × 10 ³ s ⁻¹ |
| Shear stress range | Depending on measuring system used 0.7 Pa to 3.4 × 10 ⁴ Pa |
| Viscosity range The given range is a standard value (not maximum value) | Depending on measuring system used 1 × 10 ⁻³ Pas to 3 × 10 ³ Pas |

| AC-Adaptor | |
|---|--|
| Dimensions | 160 mm x 85 mm x 35 mm |
| Weight | 0.5 kg |
| Power supply Mains voltage secondary voltages (Output) output-current output power | from 100 up to 240 V AC 5 V, +/- 15 V DC 2 A, 0.9 / -0.2 A 20 W |
| Frequency range of mains voltage | 50 bis 60 Hz |
| Environment conditions Temperature in operation out of operation Relative humidity (not condensable) in operation out of operation | +10°C to +40°C +10°C to +45°C 20% to 80% 10% to 90% |

| | |
|---|-----------------------------------|
| FTK-CC | |
| Dimensions (Width x Height x Depth) | 94 mm x 55 mm x 170 mm |
| Weight | 600 g |
| Temperature range standard range with cooling device | -10°C to +90°C -20°C to +180°C |

Measured or evaluated values

The preset values and measured values are listed below as well as all evaluated values:

| Value | Symbol | Physical Unit |
|---|----------------|----------------------|
| Speed | n | [min ⁻¹] |
| Torque (relative) (1000 % _o $\hat{=}$ 50 mNm) | M | [1] |
| Temperature | T | [°C] |
| Time | t | [s] |
| Shear rate | $\dot{\gamma}$ | [s ⁻¹] |
| Shear stress | τ | [Pa] |
| Dynamic viscosity | η | [Pas] |

IX. Guarantee

Brookfield Engineering Laboratories guarantees the faultless functioning of this instrument insofar as it is Brookfield Viscometers Ltd guarantees the faultless functioning of this instrument as far as it is used, maintained, connected and handled in accordance with this Operation Manual.

The guarantee period is 1 year from the date of delivery.

Place of the guarantee fulfillment is Brookfield Viscometers Ltd, Harlow, U.K.

All claims of the Customer concerning guarantee and damages forfeited if he has improperly handled, worked on, opened or changed the delivery goods or gave it to a third party without our prior approval.

The total liability of Brookfield Viscometers Ltd and your exclusive claim is on Brookfield's choice

either

(a) the refund of the price paid

or

in repair or replacement

of the instrument, when the instrument does not meet the requirements stated in the limited guarantee of Brookfield Viscometers Ltd. This instrument should then be returned with a copy of receipt-formular to Brookfield Viscometers Ltd, Harlow, U.K.

This limited guarantee is not valid if instrument's failure is result of accident, misuse or incorrect application. For a replacement delivery Brookfield gives guarantee only for the rest of the original guarantee period or for 30 days, the more long time period is decisive.

Brookfield Viscometers Ltd suspends any further guarantee concerning the instrument and related manuals and written materials.

Neither Brookfield Viscometers Ltd nor the Suppliers of Brookfield are responsible for any damages (lost profit, production interruption, losses of trade information or data or any other financial losses) that arise due to usage of this Brookfield product or from the inability of use of this Brookfield product, even when Brookfield Viscometers Ltd was informed of possibility of such damages.

In any case the liability of Brookfield Viscometers Ltd is limited to the amount which was paid for this product. This exception is not valid for damages which were caused due to intention or negligence from the side of Brookfield. Also the claims remain valid that are based on the laws concerning products quality responsibility.

Furthermore the guarantee conditions of "General Delivery Conditions of supply and delivery for products and services of the Electric Industry" are valid.

APPENDIX

A1 Data sheets of standard measuring systems

Table Standard cylinder measuring systems according to DIN 53019 / ISO 3219
(consists of measuring bob and measuring cup)

For R/S Rheometer three types of measuring bobs are available:

- MB-CC48 ... CC8 DIN/RC
- MB-CC48 ... CC8 DIN/FTK
- MBA-CC48...CC8 DIN/FTK with EMB-CC48...CC8

| Measuring system | CC48 | CC45 | CC25 | CC14 | CC8 |
|---|-----------------|-----------------|------------------|------------------|-------------------|
| Shear rate range [s ⁻¹] | 0 ... 4,114 | 0 ... 1,032 | 0 ... 1,032 | 0 ... 1,032 | 0 ... 1,032 |
| Shear stress range [Pa] | 0 ... 206 | 0 ... 195 | 0 ... 1141 | 0 ... 6501 | 0 ... 34,844 |
| Viscosity range [Pas] | 0.005 ... 32 | 0.020 ... 15 | 0.118 ... 100 | 0.672 ... 500 | 3.60 ... 3,000 |
| Filling volume [ml] | 70 | 100 | 17 | 3 | 0.5 |
| Shear rate factor $K_{\dot{\gamma}}$ [min/s] | 5.142 | 1.291 | 1.291 | 1.291 | 1.291 |
| Shear stress factor $\tau_{\%}$ [Pa] | 0.1900 | 0.1958 | 1.1418 | 6.501 | 34.844 |
| Radius of measuring bob R_i [mm] | 23.9 | 22.5 | 12.5 | 7 | 4 |
| Radius of measuring cup R_a [mm] | 24.4 | 24.4 | 13.56 | 7.59 | 4.34 |
| Radius of shaft R_s [mm] | 3.5 | 3.5 | 3.5 | 2.1 | 1.2 |
| Angle of measuring bob cone α [°] | 120 | 120 | 120 | 120 | 120 |
| Distance between lower edge of meas. bob and meas. cup bottom L' [mm] | 35 | 35 | 15.5 | 13 | 12 |
| Immersion of measuring shaft L'' [mm] | 22.5 | 22.5 | 12.5 | 7 | 4 |
| Length of meas. bob L [mm] | 67.5 | 67.5 | 37.5 | 21 | 12 |
| Ratio of Radii $\delta = \text{Error!}$ | 1.0209 | 1.0844 | 1.0848 | 1.0843 | 1.0850 |
| Resistance coefficient c_L | 1.1 | 1.1 | 1.1 | 1.1 | 1.1 |

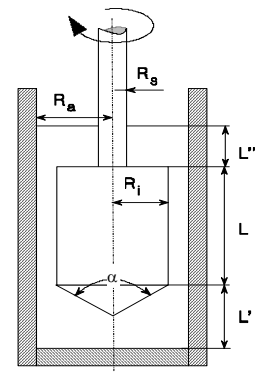

Measuring geometrie
DIN 53019

The given ranges are standard values (not maximum values).

**Table Double Gap cylinder measuring system according to DIN 53453
(consists of measuring bob and measuring cup)**

| Measuring system | DG DIN |
|---|----------------|
| Shear rate range [s ⁻¹] | 0 ... 4,031 |
| Shear stress range [Pa] | 0 ... 67 |
| Viscosity range [Pas] | 0.001 ... 1.30 |
| Filling volume [ml] | 22.5 |
| Shear rate factor $K_{\dot{\gamma}}$ [min/s] | 5.039 |
| Shear stress factor τ_{∞} [Pa] | 0.067 |
| Inner radius of measuring bob R_2 [mm] | 22.75 |
| Outer radius of measuring bob R_3 [mm] | 23.5 |
| Inner radius of measuring cup R_1 [mm] | 22.25 |
| Outer radius of measuring cup R_4 [mm] | 24 |
| Length of measuring bob L [mm] | 111 |
| Ratio of radii $\delta = \text{Error!} = \text{Error!}$ | 1.021 |
| Resistance coefficient c_L | 1 |

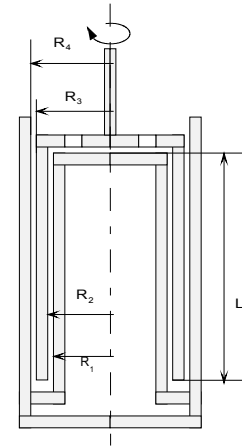

Measuring geometry
DIN 53453

The given ranges are standard values (not maximum values).

Table Cone/Plate measuring systems (DIN 53018)
(consists of measuring cone and measuring device ME-CP/PP)

| Measuring system | C25-1 | C25-2 | C50-1 | C50-2 | C75-1 | C75-2 |
|--|----------------|---------------|--------------|--------------|--------------|--------------|
| Shear rate range [s ⁻¹] | 0 ... 4,800 | 0 ... 2,400 | 0 ... 4,800 | 0 ... 2,400 | 0 ... 4,800 | 0 ... 2,400 |
| Shear stress range [Pa] | 0 ... 12,223 | 0 ... 12,223 | 0 ... 1,528 | 0 ... 1,528 | 0 ... 452 | 0 ... 452 |
| Viscosity range [Pas] | 0.25 ... 1,629 | 0.5 ... 3,259 | 0.03 ... 203 | 0.06 ... 407 | 0.009 ... 60 | 0.02 ... 120 |
| Filling volume [ml] | 0.08 | 0.3 | 0.7 | 1.5 | 2.0 | 3.9 |
| Shear rate factor $K_{\dot{\gamma}}$ [min/s] | 6.00 | 3.00 | 6.00 | 3.00 | 6.00 | 3.00 |
| Shear stress factor $\tau_{\%}$ [Pa] | 12.223 | 12.223 | 1.528 | 1.528 | 0.4527 | 0.4527 |
| Radius of measuring cone R [mm] | 12.5 | 12.5 | 25 | 25 | 37.5 | 37.5 |
| Angle of measuring cone α [°] | 1 | 2 | 1 | 2 | 1 | 2 |
| Cone truncation [μ m] | 50 | 50 | 50 | 50 | 50 | 50 |

Table Plate/Plate measuring systems (DIN 53018)
(consists of measuring plate and measuring device ME-CP/PP)

The following data is valid for a measuring gap of 1 mm. For other measuring gaps please calculate $K_{\dot{\gamma}}$ with formula:

$$K_{\dot{\gamma}} = (2\pi/60) * (R/H) R = \text{radius}, H = \text{gap}$$

| Measuring system | P25 | P50 | P75 |
|--|----------------|---------------|--------------|
| Shear rate range [s ⁻¹] | 0 ... 1,047 | 0 ... 2,094 | 0 ... 3,141 |
| Shear stress range [Pa] | 0 ... 16,298 | 0 ... 2,037 | 0 ... 603 |
| Viscosity range [Pas] | 1.56 ... 9,960 | 0.097 ... 623 | 0.02 ... 122 |
| Filling volume [ml] | 0.5 | 2.0 | 4.5 |
| Shear rate factor $K_{\dot{\gamma}}$ [min/s] | 1.309 | 2.6175 | 3.927 |
| Shear stress factor $\tau_{\%}$ [Pa] | 16.2975 | 2.037 | 0.6036 |
| Radius of measuring plate R [mm] | 12.5 | 25 | 37.5 |

A2 Error messages

The R/S Rheometer is rather error resistive, when errors occur they are determined and the user is informed on the LCD display.

The most frequent error messages are explained in this Chapter.

Range Error

| | |
|-----------------|---|
| Cause: | User's error at input. The user has tried to input a value that is less than the allowed minimum value or is more than the allowed maximum value. |
| Message: | Example of error input of a preset value |

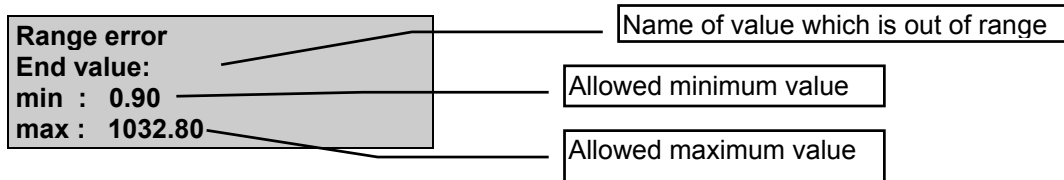

| | |
|--------------------|---|
| What to do: | Input the value again. Be sure that new value is inside of the allowed value range. |
|--------------------|---|

Printer Error

| | |
|-----------------|--|
| Cause: | The printer is selected as output device and is not ready for printing. a) Printer cable is not connected to the Rheometer b) Paper out, printer not on line, other printer errors |
| Message: | Example: printer not ready |

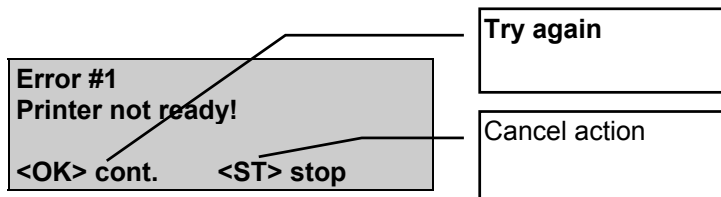

| | |
|--------------------|---|
| What to do: | Check if the printer cable is connected to the Rheometer. Check if paper is in the feed sheeder of the printer. Check if the "Ready" LED lights on printer. Remove the error cause at printer and push <input type="button" value="OK"/> key at Rheometer. If you cannot find the error cause, push <input type="button" value="ST"/> key in order to break the action that is carrying out now. |
|--------------------|---|

Zero Calibration Error

| | |
|---------------|---|
| Cause: | An impermissible high value was measured during carrying out of zero point calibration of the Rheometer |
|---------------|---|

| | |
|-----------------|--|
| Message: | |
|-----------------|--|

| |
|--|
| Error #3 Zero cal. error! Please retry cal. <OK> cont. <ST> stop |
|--|

| | |
|--------------------|--|
| What to do: | Push ST key. Check if the measuring system has been really removed from the Rheometer. Retry zero point calibration. If the error is presented again, that means that there is a fault in the measuring instrument |
|--------------------|--|

BREAK: MOMMAX

| | |
|---------------|--|
| Cause: | Maximum torque has been exceeded during carrying out of a measurement. a) You have selected inappropriate measuring range load for the measuring medium. b) Rotation bob distorted in the measuring cup. |
|---------------|--|

| | |
|-----------------|--|
| Message: | |
|-----------------|--|

| |
|---|
| BREAK: torque max! Single mode total MP: 10 total time: 60 |
|---|

| | |
|--------------------|---|
| What to do: | Push OK key. Check if the measuring system is fixed at the Rheometer properly. If so, select for this measurement smaller shear rates or speed or use a measuring system with higher shear stress factor. |
|--------------------|---|

BREAK: SPEED MAX

| | |
|---------------|---|
| Cause: | Maximum speed exceeded during carrying out a measurement. a) You have selected too high shear stress or too high torque value for the measuring substance. b) You have started torque- or shear stress measurement without substance in measuring system. |
|---------------|---|

| | |
|-----------------|--|
| Message: | |
|-----------------|--|

BREAK: Speed max!
Single mode
total MP: 10
total time: 60

| | |
|--------------------|---|
| What to do: | Push <input type="button" value="OK"/> key. Select smaller shear stress or torque values for this measurement. |
|--------------------|---|

A3 Pin-layout of the serial data cable

The Rheometer is provided with a serial interface with 25 pin Sub-D-connector (male) at the back side of the instrument. The serial interface is marked as RS232.

The signal level in accordance with RS232 is in the range between +12 V and -12 V.

Pin-connection of the serial data cable to the serial data transfer to a PC:

Rheometer side:

25-pin Sub-D-connector (female)
View on soldered joints
All other pin must not be connected!

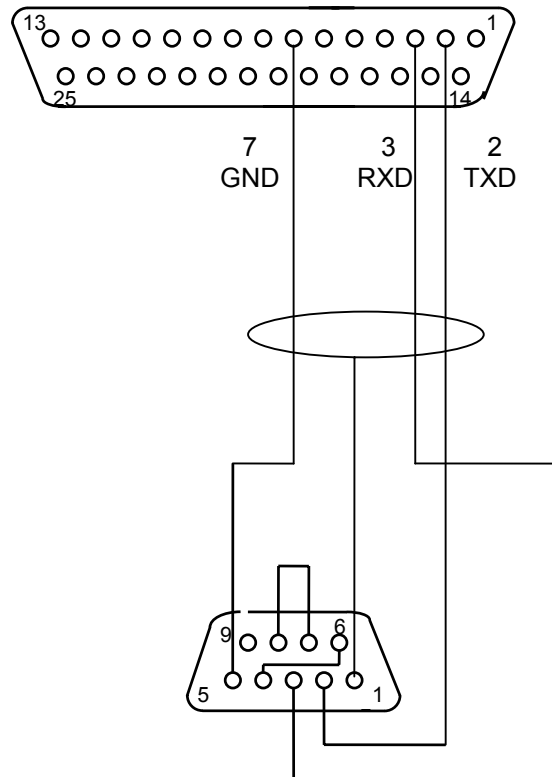

PC Side

9-pin Sub-D-connector (female)

A4 Requirements to the mains connecting cables

The AC-adaptor unit of the R/S Rheometer enables operation of the Rheometer with supply voltage in the range of 100 to 240 V AC with frequencies from 50 to 60 Hz.

The mains connecting cable that you have received with your R/S Rheometer in some cases may not meet with the requirements of the country in which you are using this Rheometer. You must obligatory use a mains connecting cable that meets the specific requirements of the relevant country.

The following information explains the requirements that are to taken into account when choosing the mains connecting cable.

General information

- The connecting cable must be permitted (authorized) in the country where it is used.
- The AC-adaptor plug connector (that is the connection with the AC adaptor itself, not the mains plug) must suitable for the input socket type CEE22/IEC 320 (data sheet C14).
- The mains cable must be at least 2 m and at the most 3 m long.

USA and Canada

- The mains connecting cable must correspond to the UL-permission and CSA Certificate.
- The following minimal requirements are valid for the cable:
 - No. 18 AWG
 - Type SV or similar
 - 3-phase
- The cable must have a nominal load-capacity of at least 10 A.
- The mains plug of type NEMA 5-15P (15A, 125V) or NEMA 6-15P (15A, 250V) must have plug protection.

Other countries

- The connectors of the mains connecting cable must have approval certificate for the corresponding country in which this Rheometer is used. These places are:

| | |
|-----------------------|-------------------|
| - BSI (Great Britain) | NEMKO (Norway) |
| - CEBEC (Belgium) | OVE (Austria) |
| - DEMKO (Denmark) | SEMKO (Sweden) |
| - EANSW (Australia) | SETI (Finland) |
| - IMQ (Italy) | SEV (Switzerland) |
| - KEMA (Netherlands) | UTE (France) |
| - VDE (Germany) | |

- The cable must be three-phase HAR-cable of type HO5VV-F3 with a minimal phase diameter-section of 1.0 mm².

The mains connecting cable must be permitted for a current load of at least 10 A and, depending on country, a nominal voltage of 125 V or 250 V AC.

Japan

In Japan the following cable types and connections values are required:

- All parts of the cables (cable, socket and plug) must have brand name and registration number according to the Dentori law.
- The following minimal requirements are valid for the cable:
 - 0.75 mm², 2-phase
 - Type VCT or VCTF
 - 3-phase
- The cable must have nominal current load capacity of 7 A.

- The mains plug must be 2-pin shockproof plug according to the Japanese Industrial Standard C8303 (15A,125V).

A5 Language cross reference

English German English German

!M low! !M ->0!
 BREAK ABBR.
 Break:speed max! Abbruch Drehz. max!
 Break:torque max! Abbruch Mom. max!
 Change RS232 Param.?Aendern RS232-Par.?
 Clear memory? Speicher loeschen?
 continue weiter
 Edit Meas.-Sys. Eing. Mess-Sys.
 Edit programm first! Zuerst Eingabe Prog!
 Edit PROGRAM-NameEing. Programmname
 End-Value: Endwert:
 ERROR FEHLER
 Input measuring-id Eingabe Mess-ID
 Input Step Nr. Eingabe Schritt#
 Input Values: Eingabe Werte:
 Meascount Messzaehler
 Meascount-mode Messzaehler-Modus
 Measuring-systems Messsysteme
 Memory cleared! Speicher geloescht!
 Memory Speicher
 No free memory! Kein Speicher frei!
 no output-device kein Ausgabegeraet
 no reset nicht ruecksetzen
 no valid data!keine guelt. Daten!
 No valid programm!Kein guelt. Progr.!
 NO NEIN
 not valid nicht gueltig
 Nr. of stepsAnzahl Schritte
 Output of MPs to: Ausgabe Messwerte:
 Please do DAC-CAL!DAC-Kal. notwendig!
 Please do ZERO-CAL!ZERO-Kal. notwendig!
 please wait... bitte warten...
 Press any key... Taste druecken...
 Printer not ready!Drucker n. bereit!
 Printer Drucker
 Printer-Error!Drucker-Fehler!

Program end Programmende
 Program running... Programm laeuft...
 Range-Error Eingabe-Fehler
 Remove Meas.-System!Messsystem entfernen!
 reset every daytaeglich ruecks.
 Reset Meascount? Messzaehler=0?
 return zurueck
 rpm U/min
 RS232 RS232
 run without mem. Start o.Speicher
 save Speichern
 Sel. output-device: Wahl Ausgabe-Geraet:
 Select Input-Mode: Auswahl Einheit:
 Select Meas.system:Auswahl Messsystem:
 Select PROG to edit Welches PROG bearb.?
 Select PROG to run Auswahl Programm
 Select Program: Auswahl Programm:
 Single mode Einzelmessung
 Start-Value: Startwert:
 stop Stop
 Temperature Temperatur
 time Zeit
 Time/Date Uhrzeit/Datum
 Todays date Heutiges Datum:
 total #MP: Gesamt #MP:
 total time: Gesamtzeit:
 User-Break! Abbruch Benutzer!
 User-defined ProgramsBenutzerdef. Programme
 Voltage-Control Spannungsversorgung
 Wait for 1.MP Warte auf 1.MP
 Wait for RS232... Warte auf RS232...
 YES JA
 Zero-Cal. done... Abgleich fertig...
 Zero-Cal.running... Abgleich laeuft...
 Zero-calibration Nullpkt.abgleich

German menu system of RC20

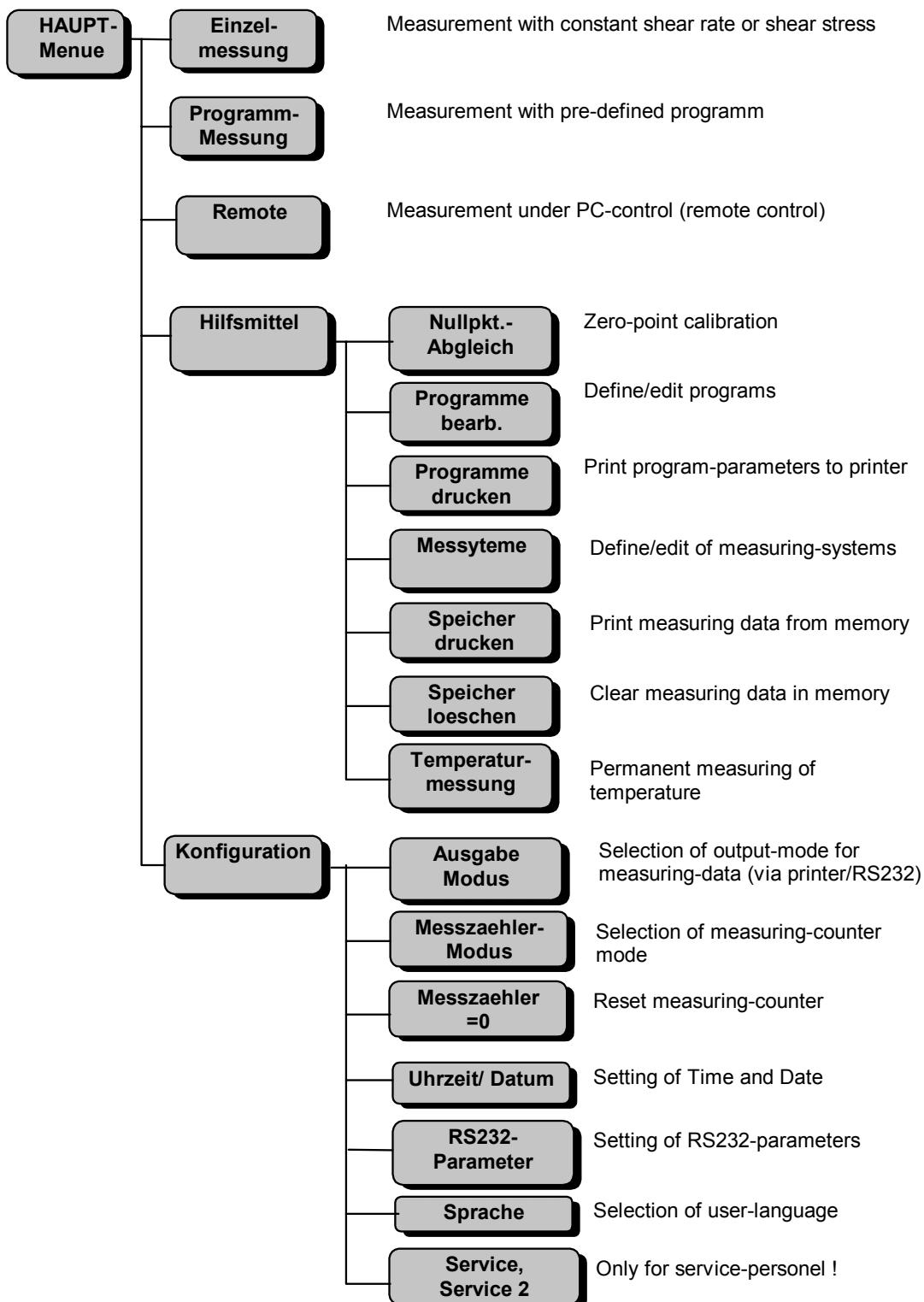

Index

C

cleaning, 18
computer system, 6, 8, 11
cooling device, 12

D

Date, setting, 45

E

electrical connections, 10
Error messages, 58

F

FTK-CC, 6, 8, 12, 22

G

General description, 5
guarantee, 54

I

Immersion-measuring, 20
input of numeric values, 30
Installation, 9
instrument handling, 18

K

KE, 12

L

language, 47

M

mains cable, 11
mains connecting cable, 62
maintenance, 19
measurement counter, 45
measurement ID, 45
measurements, 50
measuring counter, 44
measuring system, 6, 12, 20
measuring system, create, 41
measuring system, edit, 41
measuring system, one-way, 20
Measurement Remote, 36
Measurement Single, 32

ME-CP/PP, 23
ME-CP/PP measuring device, 6, 8, 12, 14, 17
memory, 33, 35
memory, clear, 43
memory, internal, 44
memory, print data, 42
Menü-System, 25

O

output mode, 44

P

power supply, 11
printer, 44
Printer, 11
Program, edit, 37
Program, print, 41
PT 100, 10
Pt 100-clamp fixture, 10
Pt100, 8

Q

quick fitting couplings, 13, 14

R

Remote, 51
REMOTE, 11
RS 232, 11
RS232 data cable, 61
RS232 parameter, 46, 47

S

serial data cable, 61
serial interface, 44
Stand, 9
System configuration, 6

T

technical data, 52
temperature control, 22
temperature control device, 6, 8, 12
temperature, permanent measuring, 43
thermostat, 6
thermostatic liquids, 13, 14, 18
Time, setting, 45

U

user language, 47

Free Manuals Download Website

<http://myh66.com>

<http://usermanuals.us>

<http://www.somanuals.com>

<http://www.4manuals.cc>

<http://www.manual-lib.com>

<http://www.404manual.com>

<http://www.luxmanual.com>

<http://aubethermostatmanual.com>

Golf course search by state

<http://golfingnear.com>

Email search by domain

<http://emailbydomain.com>

Auto manuals search

<http://auto.somanuals.com>

TV manuals search

<http://tv.somanuals.com>