



SuperStack® II Switch 1100 User Guide

3C16950, 3C16951

<http://www.3com.com/>

Part No. DUA1695-0AAA04
Published April 1999

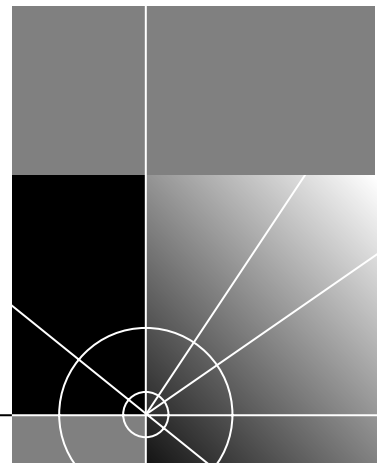

3Com Corporation
5400 Bayfront Plaza
Santa Clara, California
95052-8145

Copyright © 1999, 3Com Technologies. All rights reserved. No part of this documentation may be reproduced in any form or by any means or used to make any derivative work (such as translation, transformation, or adaptation) without written permission from 3Com Technologies.

3Com Technologies reserves the right to revise this documentation and to make changes in content from time to time without obligation on the part of 3Com Technologies to provide notification of such revision or change.

3Com Technologies provides this documentation without warranty, term, or condition of any kind, either implied or expressed, including, but not limited to, the implied warranties, terms or conditions of merchantability, satisfactory quality, and fitness for a particular purpose. 3Com may make improvements or changes in the product(s) and/or the program(s) described in this documentation at any time.

If there is any software on removable media described in this documentation, it is furnished under a license agreement included with the product as a separate document, in the hard copy documentation, or on the removable media in a directory file named LICENSE.TXT or !LICENSE.TXT. If you are unable to locate a copy, please contact 3Com and a copy will be provided to you.

UNITED STATES GOVERNMENT LEGEND

If you are a United States government agency, then this documentation and the software described herein are provided to you subject to the following:

All technical data and computer software are commercial in nature and developed solely at private expense. Software is delivered as "Commercial Computer Software" as defined in DFARS 252.227-7014 (June 1995) or as a "commercial item" as defined in FAR 2.101(a) and as such is provided with only such rights as are provided in 3Com's standard commercial license for the Software. Technical data is provided with limited rights only as provided in DFAR 252.227-7015 (Nov 1995) or FAR 52.227-14 (June 1987), whichever is applicable. You agree not to remove or deface any portion of any legend provided on any licensed program or documentation contained in, or delivered to you in conjunction with, this User Guide.

Unless otherwise indicated, 3Com registered trademarks are registered in the United States and may or may not be registered in other countries.

3Com, the 3Com logo, Net Age, SmartAgent, SuperStack and Transcend are registered trademarks of 3Com Corporation. CoreBuilder and PACE are trademarks of 3Com Corporation. 3ComFacts is a service mark of 3Com Corporation.

All other company and product names may be trademarks of the respective companies with which they are associated.

Environmental Statement

It is a 3Com policy to be environmentally friendly in all operations. This manual is printed on paper that comes from sustainable, managed European forests. The production process for making the pulp has a reduced AOX level (adsorbable organic halogen) resulting in elemental chlorine-free paper.

The paper is fully biodegradable and recyclable.

CONTENTS

ABOUT THIS GUIDE

Conventions	8
Related Documentation	9
Year 2000 Compliance	10
Documentation Comments	10

1 INTRODUCING THE SWITCH 1100

About the SuperStack II Switch 1100	12
Summary of Features	12
Switch 1100 — Front View Detail	13
Port Connections	13
LEDs	14
Switch 1100 — Rear View Detail	15
Unit Information Label	15
Power Socket	15
Redundant Power System Socket	15
Console Port	15
Expansion Module Slot	16
Transceiver Module Slot	16
Matrix Port	16
Network Configuration Examples	17
Network Segmentation I	17
Network Segmentation II	18
Desktop Switching	19
Configuration Rules for Fast Ethernet	20
Configuration Rules with Full Duplex	21

2 INSTALLING THE SWITCH

Choosing a Suitable Site	24
Rack-mounting	24

Placing Units On Top of Each Other	25
Stacking Units	26
Stacking Two Units	26
Stacking Up To Four Units	27
The Power-up Sequence	29
Connecting a Redundant Power System	29
Powering-up the Switch 1100	29
Checking for Correct Operation	29
Choosing the Correct Cables	30
Solving Problems Indicated by LEDs	31
Managing the Switch	32

A SAFETY INFORMATION

Important Safety Information	34
L'information de Sécurité Importante	36
Wichtige Sicherheitsinformationen	38

B PIN-OUTS

Null Modem Cable	39
PC-AT Serial Cable	39
Modem Cable	40
RJ45 Pin Assignments	40

C TECHNICAL SPECIFICATIONS

D TECHNICAL SUPPORT

Online Technical Services	43
World Wide Web Site	43
3Com Knowledgebase Web Services	43
3Com FTP Site	44
3Com Bulletin Board Service	44
3Com Facts Automated Fax Service	45
Support from Your Network Supplier	45
Support from 3Com	45
Returning Products for Repair	47

GLOSSARY

INDEX

3COM CORPORATION LIMITED WARRANTY

EMC STATEMENTS

ABOUT THIS GUIDE

This guide provides all the information you need to install and use a SuperStack® II Switch 1100 unit with default settings. If you want to change the way the Switch works using management software, refer to the “SuperStack II Switch Management Guide” (part number DUA1695-0BAA0x).

The guide is intended for use by network administrators who are responsible for installing and setting up network equipment; consequently, it assumes a basic working knowledge of LANs (Local Area Networks).



This guide is intended for use with both Switch 1100 models:

- 3C16950 — 24 10BASE-T ports
- 3C16951 — 12 10BASE-T ports

All pictures and example screens show the 24-port model, however, all procedures apply to the 24-port model and the 12-port model.



If the information in the release notes that are shipped with your product differs from the information in this guide, follow the instructions in the release notes.

Most user guides and release notes are available in Adobe Acrobat Reader Portable Document Format (PDF) or HTML on the 3Com World Wide Web site:

<http://www.3com.com/>

Conventions

Table 1 and Table 2 list conventions that are used throughout this guide.

Table 1 Notice Icons



Icon	Notice Type	Description
	Information note	Information that describes important features or instructions
	Caution	Information that alerts you to potential loss of data or potential damage to an application, system, or device
	Warning	Information that alerts you to potential personal injury

Table 2 Text Conventions

Convention	Description
Screen displays	This typeface represents information as it appears on the screen.
Syntax	<p>The word "syntax" means that you must evaluate the syntax provided and then supply the appropriate values for the placeholders that appear in angle brackets. Example:</p> <p>To enable RIPIP, use the following syntax:</p> <pre>SETDefault !<port> -RIPIP CONTROL = Listen</pre> <p>In this example, you must supply a port number for <port>.</p>
Commands	<p>The word "command" means that you must enter the command exactly as shown and then press Return or Enter. Commands appear in bold. Example:</p> <p>To remove the IP address, enter the following command:</p> <pre>SETDefault !0 -IP NETaddr = 0.0.0.0</pre>
The words "enter" and "type"	When you see the word "enter" in this guide, you must type something, and then press Return or Enter. Do not press Return or Enter when an instruction simply says "type."
Keyboard key names	<p>If you must press two or more keys simultaneously, the key names are linked with a plus sign (+). Example:</p> <p>Press Ctrl+Alt+Del</p>

Table 2 Text Conventions (continued)

Convention	Description
Words in <i>italics</i>	<p>Italics are used to:</p> <ul style="list-style-type: none"> ■ Emphasize a point. ■ Denote a new term at the place where it is defined in the text. ■ Identify menu names, menu commands, and software button names. Examples: <p>From the <i>Help</i> menu, select <i>Contents</i>.</p> <p>Click <i>OK</i>.</p>

Related Documentation

In addition to this guide, each Switch 1100 document set includes the following:

- *Management Guide (Part Number DUA1695-0BAA0x)*
This guide contains all the management information for the Switch.
- *Quick Reference Guide (Part Number DQA1695-0AAA0x)*
This guide contains a quick summary of the hardware and software information for the Switch
- *Quick Installation Guide (Part Number DIA1695-0AAA0x)*
This guide contains a summary of the package contents, and a quick summary of the installation information for the Switch.
- *Release Notes (Part Number DNA1695-0AAA0x)*
These notes provide information about the current software release, including new features, modifications, and known problems.
- *SuperStack II Switch Help*
This help provides information about the web interface software of the Switch. It is supplied on the SuperStack II Switch CD-ROM.
- *SuperStack II Switch README File*
This file provides information about the current software release, including new features, modifications, and known problems.

In addition, there are other publications you may find useful:

- Documentation accompanying the Expansion Modules.
- Documentation accompanying the Transceiver Modules.
- Documentation accompanying the Advanced Redundant Power System.

Year 2000 Compliance

For information on Year 2000 compliance and 3Com products, visit the 3Com Year 2000 Web page:

<http://www.3com.com/products/yr2000.html>

Documentation Comments

Your suggestions are very important to us. They will help make our documentation more useful to you. Please e-mail comments about this document to 3Com at:

pddtechpubs_comments@3com.com

Please include the following information when commenting:

- Document title
- Document part number (on the title page)
- Page number (if appropriate)

Example:

- SuperStack II Switch 1100 User Guide
- Part Number DUA1695-0AAA03
- Page 21

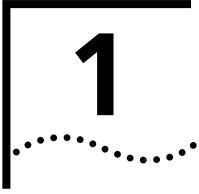

INTRODUCING THE SWITCH 1100

This chapter contains introductory information about the Switch and how it can be used in your network. It covers the following topics:

- [About the SuperStack II Switch 1100](#)
- [Switch 1100 — Front View Detail](#)
- [Switch 1100 — Rear View Detail](#)
- [Network Configuration Examples](#)
- [Configuration Rules for Fast Ethernet](#)
- [Configuration Rules with Full Duplex](#)

About the SuperStack II Switch 1100

The SuperStack® II system solves the problem of growth in dynamic network environments and provides everything you need for successful workgroup networking. Much more than a collection of stackable components, the system comprises a complete, integrated architecture of modular parts that are easy to install and use.

As part of this SuperStack II system, the Switch 1100 meets the challenge of modern LANs and allows you to add features and capacity as your network expands.

Summary of Features

The Switch has the following hardware features:

- 12 or 24 Ethernet 10BASE-T ports
- Two Fast Ethernet auto-negotiating 10BASE-T/100BASE-TX ports
- Matrix port for connecting units in the Switch 1100/3300 family to form a stack:
 - Connect two units back-to-back using a single Matrix Cable
 - Connect up to four units using Matrix Cables linked to a Matrix Module
- Slot for an Expansion Module
- Slot for a Transceiver Module (10Mbps Ethernet)
- SuperStack II architecture:
 - Connects to Redundant Power System / Uninterruptible Power System
 - 19-inch rack or stand-alone mounting



For information about the software features of the Switch, refer to the "SuperStack II Switch Management Guide" (DUA1695-0BAA0x).

Switch 1100 — Front View Detail

Figure 1 Switch 1100 — Front view

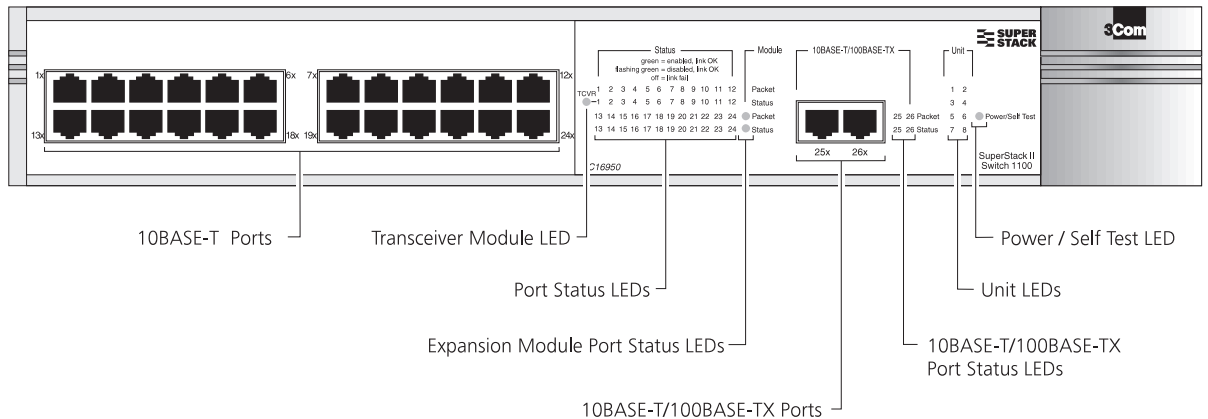

Port Connections **10BASE-T Ports**

The Switch has 12 or 24 10BASE-T ports configured as MDIX (cross-over). The maximum segment length is 100m (328ft) over Category 3, 4, or 5 twisted pair cable.



As these ports are configured as MDIX (cross-over), you need to use a cross-over cable to connect to devices whose ports are MDIX-only. See ["Choosing the Correct Cables"](#) on page 30 for more information.

10BASE-T/100BASE-TX Ports

The Switch has two auto-negotiating 10BASE-T/100BASE-TX ports configured as MDIX (cross-over). These ports can be set to 10BASE-T half duplex, 10BASE-T full duplex, 100BASE-TX half duplex, 100BASE-TX full duplex, or they can automatically detect the speed and duplex mode of a link and provide the appropriate connection. The maximum segment length is 100m (328ft) over Category 5 twisted pair cable.



As these ports are configured as MDIX (cross-over), you need to use a cross-over cable to connect to devices whose ports are MDIX-only. See ["Choosing the Correct Cables"](#) on page 30 for more information.

LEDs [Table 3](#) lists the LEDs visible on the front of the Switch, and their states according to color. For information on using the LEDs for problem solving, see [“Checking for Correct Operation”](#) on page 29.

Table 3 LED behavior

LED	Color	Indicates
TCVR	Yellow	Port 1 is a Transceiver Module fitted to the rear of the Switch.
	Off	Port 1 is operating as a 10BASE-T port.
Port Status LEDs		
Packet	Yellow	Packets are being transmitted/received on the port.
	Off	No packets are being transmitted/received on the port.
Status	Green	A link is present, and the port is enabled.
	Green flashing	A link is present, but the port is disabled.
	Off	No link is present.
Expansion Module Port Status LEDs		
Packet	Yellow	Packets are being transmitted/received on the Expansion Module port(s).
	Off	No packets are being transmitted/received on the Expansion Module port(s).
Status	Yellow	A valid Expansion Module is installed.
	Yellow flashing	An unrecognized Expansion Module is installed.
	Off	No Expansion Module is installed.
Unit LEDs		
1–8	Green	The Switch forms a stack with other Switch units; the LED indicates the position of the Switch in the stack and that a link is present. Note that although there are eight LEDs, only four Switch units can be stacked at present.
	Off	The Switch is stand-alone.
Power/Self Test LED		
	Green	The Switch is powered-up.
	Green flashing	The Switch is either downloading software or is initializing (which includes running a Power On Self Test).
	Yellow	The Switch has failed its Power On Self Test.
	Off	The Switch is not receiving power.

Switch 1100 — Rear View Detail

Figure 2 Switch 1100 — Rear view

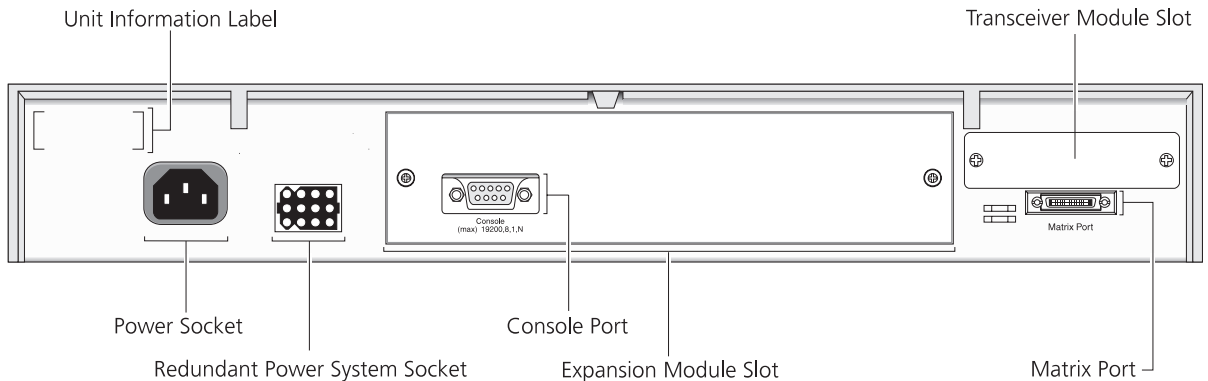

Unit Information Label

This label shows the following:

- The 3Com product name of the Switch
- The 3Com 3C number of the Switch
- The unique MAC address (Ethernet address) of the Switch
- The serial number of the Switch

You may need this information for fault reporting purposes.

Power Socket

The Switch automatically adjusts its power setting to any supply voltage in the range 90–240V A.C.

Redundant Power System Socket

To protect against internal power supply failure, you can use this socket to connect a SuperStack II Advanced Redundant Power System (RPS) to the Switch. See [“Connecting a Redundant Power System”](#) on page 29.

Console Port

The console port allows you to connect a terminal and perform remote or local out-of-band management. The console port uses standard null modem cable and is set to auto-baud, 8 data bits, no parity and 1 stop bit.

Expansion Module Slot

You can use this slot to install an Expansion Module; for example, a 100BASE-FX Module that provides an additional high-speed link, or a Matrix Module that provides four matrix ports for stacking Switch units together. 3Com provides a range of Expansion Modules; contact your supplier for availability. For more information about Matrix Modules, see [“Stacking Units”](#) on page 26.



When an Expansion Module is not installed, ensure the blanking plate is secured in place.

Transceiver Module Slot

You can use this slot to install a Transceiver Module. When a Transceiver Module is installed, the Transceiver Module port becomes port 1 and the port labelled 1 on the front panel becomes inactive. The Transceiver Module can provide a 10Mbps Ethernet half duplex link to the rest of your network using various media such as fiber and coaxial cabling.



When a Transceiver Module is not installed, ensure the blanking plate is secured in place.

Matrix Port

The matrix port allows you to:

- Stack the Switch with another unit in the Switch 1100/3300 family using a single Matrix Cable
- Stack the Switch with up to three other units in the Switch 1100/3300 family, if one of the units has a Matrix Module installed

For more information about the role of the matrix port, see [“Stacking Units”](#) on page 26.

Network Configuration Examples

Network Segmentation I

The following illustrations show some examples of how the Switch can be placed on your network.

[Figure 3](#) shows how the Switch 1100 fits into a large corporate network with a Fast Ethernet infrastructure. A Switch is positioned on each floor and servers are centralized in the basement.

Figure 3 Using the Switch 1100 to segment your network

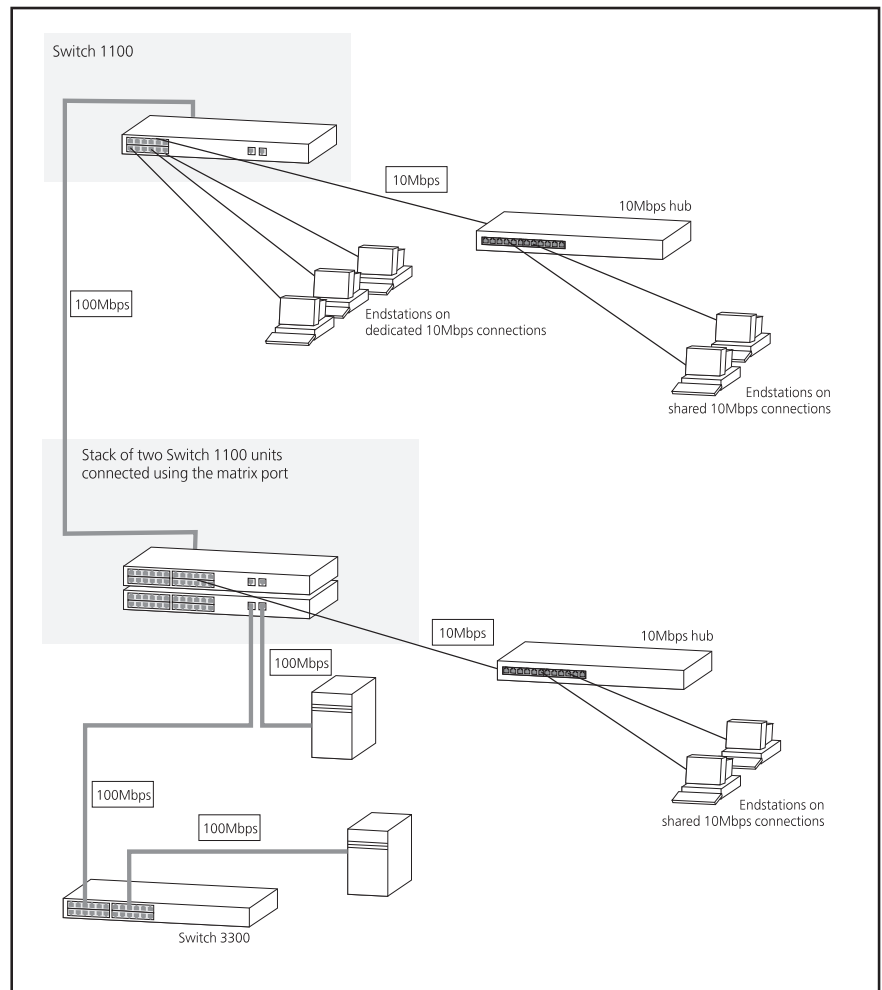

Network Segmentation II

[Figure 4](#) shows the Switch 1100 in a second workgroup situation. This setup could be that of a small office within a large corporation, or part of a larger corporate network. Most of the switch ports have multiple endstations.

Figure 4 Using the Switch 1100 to segment your network

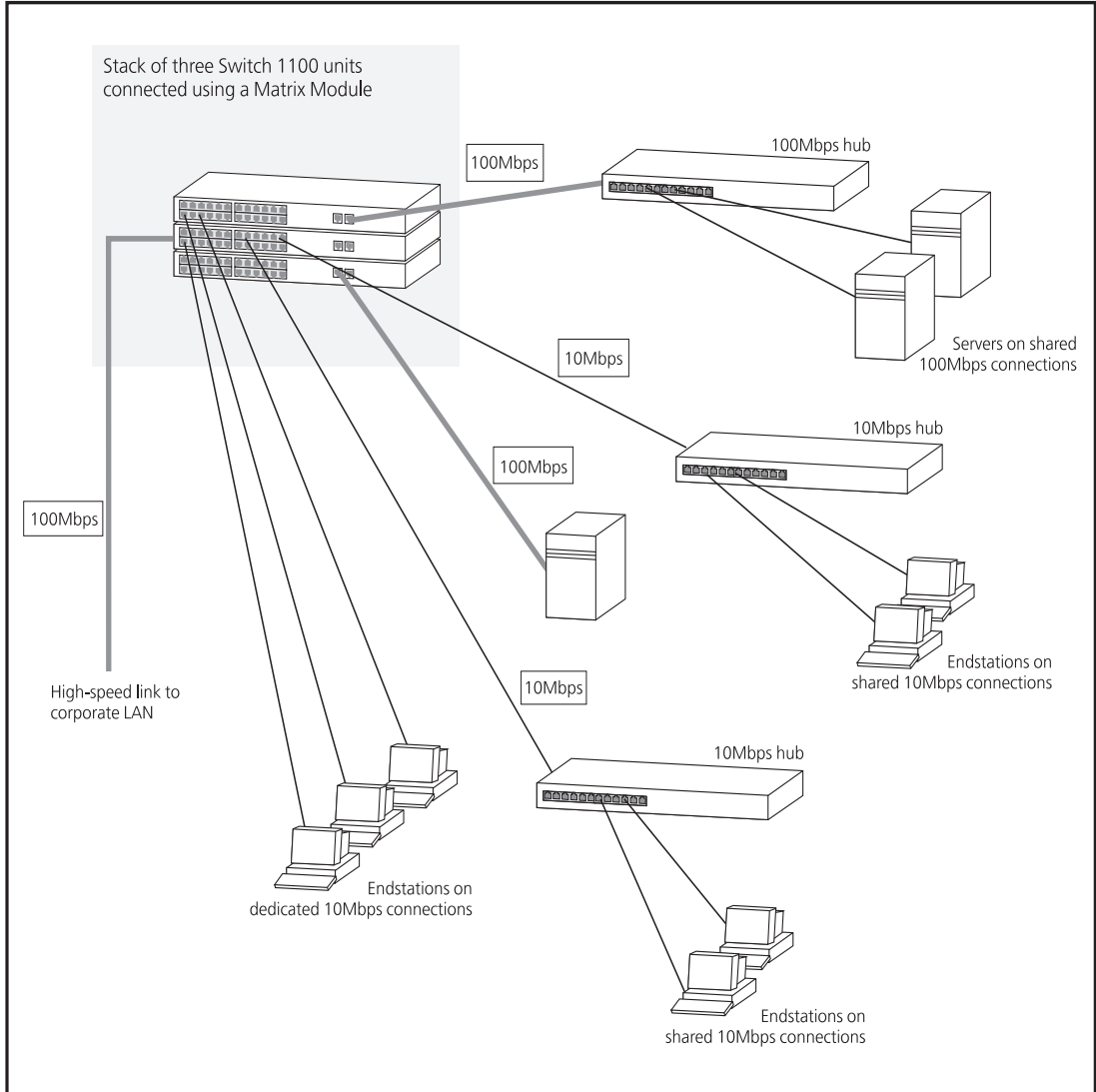

Desktop Switching [Figure 5](#) shows the Switch 1100 used for a group of users in a large corporate network. Here switching is brought to the desktop with a single endstation per port. Local servers are connected via 100Mbps Fast Ethernet links.

Figure 5 Using the Switch 1100 in a desktop environment

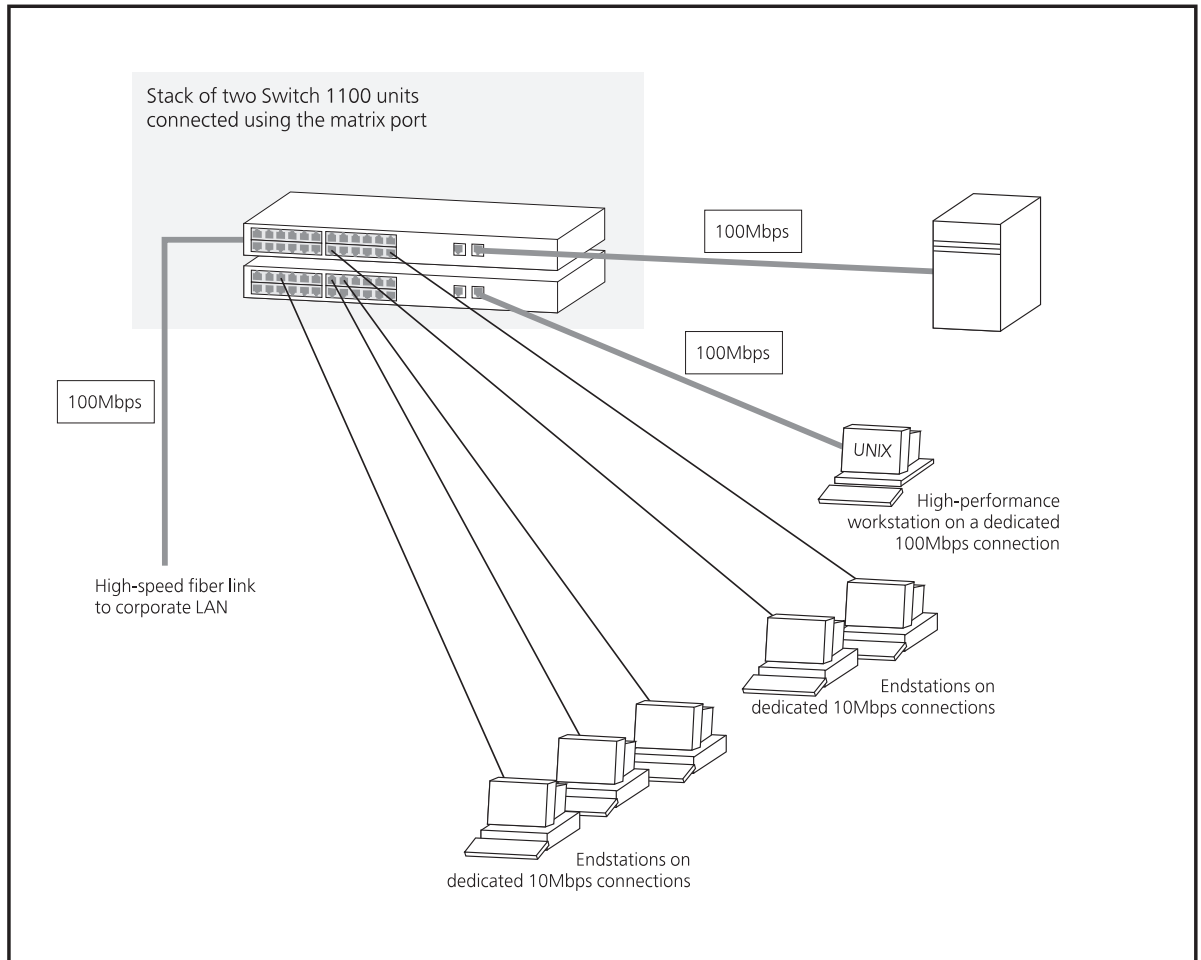

Configuration Rules for Fast Ethernet

The topology rules for 100Mbps Fast Ethernet are slightly different to those for 10Mbps Ethernet. [Figure 6](#) illustrates the key topology rules and provides examples of how they allow for large-scale Fast Ethernet networks.

Figure 6 Fast Ethernet configuration rules

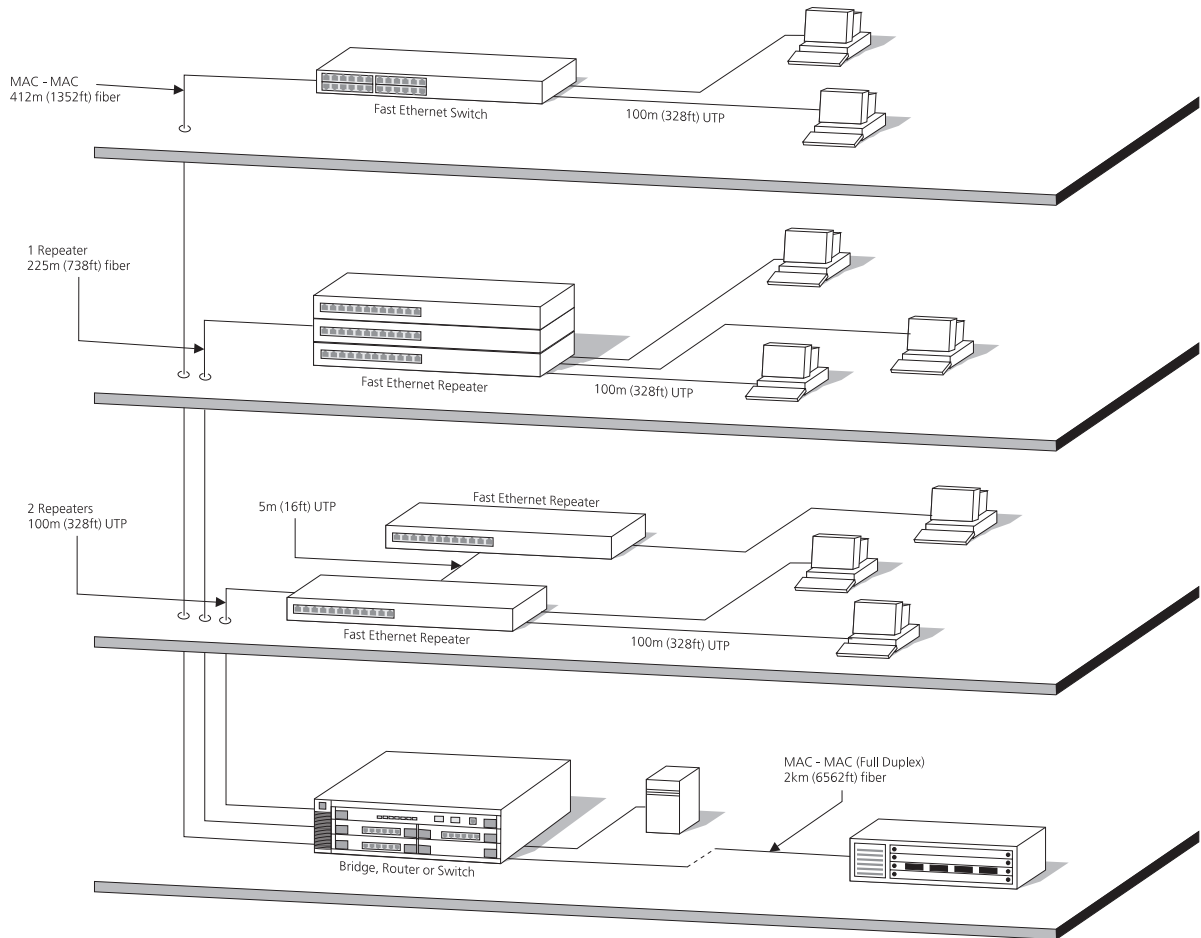

The key topology rules are:

- Maximum UTP cable length is 100m (328ft) over Category 5 cable.
- A 412m (1352ft) fiber run is allowed for connecting switch-to-switch, or endstation-to-switch, using half-duplex 100BASE-FX.
- A total network span of 325m (1066ft) is allowed in single-repeater topologies (one hub stack per wiring closet with a fiber run to the collapsed backbone); for example, a 225m (738ft) fiber link from a repeater to a router or switch, plus a 100m (328ft) UTP link from a repeater out to the endstations.

Configuration Rules with Full Duplex

The Switch provides full duplex support for all its fixed ports, including Expansion Module ports. Full duplex allows packets to be transmitted and received simultaneously and, in effect, doubles the potential throughput of a link.

With full duplex, the Ethernet topology rules are the same, but the Fast Ethernet rules are:

- Maximum UTP cable length is 100m (328ft) over Category 5 cable.
- A 2km (6562ft) fiber link is allowed for connecting switch-to-switch, or endstation-to-switch.

2

INSTALLING THE SWITCH

This chapter contains the information you need to install and set up the Switch. It covers the following topics:

- [Choosing a Suitable Site](#)
- [Rack-mounting](#)
- [Placing Units On Top of Each Other](#)
- [Stacking Units](#)
- [The Power-up Sequence](#)
- [Choosing the Correct Cables](#)
- [Solving Problems Indicated by LEDs](#)
- [Managing the Switch](#)



WARNING: Safety Information. Before installing or removing any components from the Switch 1100 or carrying out any maintenance procedures, you must read the safety information provided in [Appendix A](#) of this guide.



AVERTISSEMENT: Consignes de sécurité. Avant d'installer ou d'enlever tout composant du Switch 1100 ou d'entamer une procédure de maintenance, lisez les informations relatives à la sécurité qui se trouvent dans l'Appendice A de ce guide.



WARNHINWEIS: Sicherheitsinformationen. Bevor Sie Komponenten aus dem Switch 1100 entfernen oder dem Switch 3300 hinzufügen oder Instandhaltungsarbeiten verrichten, lesen Sie die Sicherheitsanweisungen, die in Appendix A (Anhang A) in diesem Handbuch aufgeführt sind.

Choosing a Suitable Site

The Switch is suited for use in an office environment where it can be mounted in a standard 19-inch equipment rack, or free standing. Alternatively, the Switch can be rack-mounted in a wiring closet or equipment room. A rack-mounting kit, containing two mounting brackets and six screws, is supplied with the Switch.

When deciding where to position the Switch, ensure that:

- You are able to meet the configuration rules detailed in [“Configuration Rules for Fast Ethernet”](#) on [page 20](#).
- The Switch is accessible and cables can be connected easily.
- Cabling is away from:
 - Sources of electrical noise such as radios, transmitters and broadband amplifiers
 - Power lines and fluorescent lighting fixtures
- Water or moisture cannot enter the case of the Switch.
- Air-flow is not restricted around the Switch or through the vents in the side of the Switch. We recommend that you provide a minimum of 25mm (1in.) clearance.
- No more than four Switch units are placed on top of one another, if the units are free standing.

Rack-mounting

The Switch is 1.5U high and fits in most standard 19-inch racks.



CAUTION: *Disconnect all cables from the Switch before continuing. Remove all self adhesive pads from the underside of the Switch if they have been fitted.*

- 1 Place the Switch the right way up on a hard flat surface, with the front facing towards you.
- 2 Locate a mounting bracket over the mounting holes on one side of the Switch, as shown in [Figure 7](#).

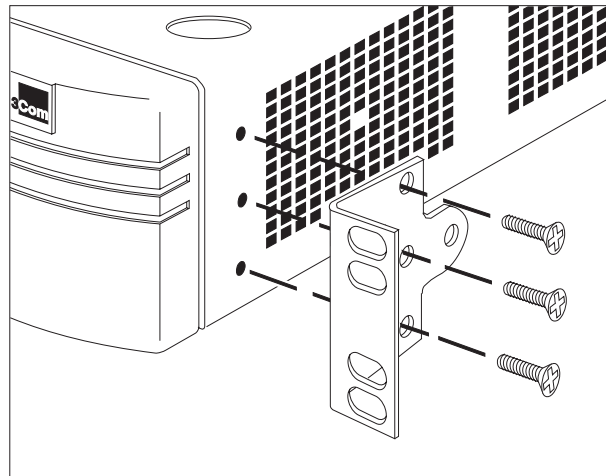
Figure 7 Fitting a bracket for rack mounting

- 3 Insert the three screws and tighten with a suitable screwdriver.



You must use the screws supplied with the mounting brackets. Damage caused to the unit by using incorrect screws invalidates your warranty.

- 4 Repeat steps 2 and 3 for the other side of the Switch.
- 5 Insert the Switch into the 19-inch rack and secure with suitable screws (not provided). Ensure that ventilation holes are not obstructed.
- 6 Connect network cabling.

Placing Units On Top of Each Other

If the Switch units are free-standing, up to four units can be placed one on top of the other. If you are mixing a variety of SuperStack II Switch and Hub units, the smaller units must be positioned at the top.

If you are placing Switch units one on top of the other, you must use the self-adhesive rubber pads supplied. Apply the pads to the underside of each Switch, sticking one in the marked area at each corner. Place the Switch units on top of each other, ensuring that the pads of the upper unit line up with the recesses of the lower unit.

Stacking Units

Units in the Switch 1100/3300 family can be stacked together and then treated as a single manageable unit with one IP address.

You can stack Switch units together in two ways:

- The matrix port on the rear of the Switch allows you to connect two Switch units back-to-back. For this you need a Matrix Cable (part number 3C16965). Contact your supplier for details.
- The Expansion Module slot at the rear of the Switch allows you to install a Matrix Module (part number 3C16960). The Matrix Module provides four ports and allows you to interconnect up to four Switch units using Matrix Cables.

Stacking Two Units

You can stack two Switch units with a single Matrix Cable. To do this:

- 1 Power-off both units.
- 2 Arrange the units as required. They can be rack-mounted or free-standing; if you choose to have them free-standing, remember to position the rubber feet as detailed in [“Placing Units On Top of Each Other”](#) on [page 25](#). When positioning the units, note that Matrix Cables are 1 m (3.28ft) long.
- 3 As shown in [Figure 8](#), connect one end of the Matrix Cable to the matrix port of the top Switch, and the other end to the matrix port of the lower Switch.
- 4 If you use the management software of the units:
 - Ensure that both units have the same version of management software
 - Ensure that you re-configure the stack-wide features on both units

For more information about management software, see [“Managing the Switch”](#) on [page 32](#).

Figure 8 A stack of two units

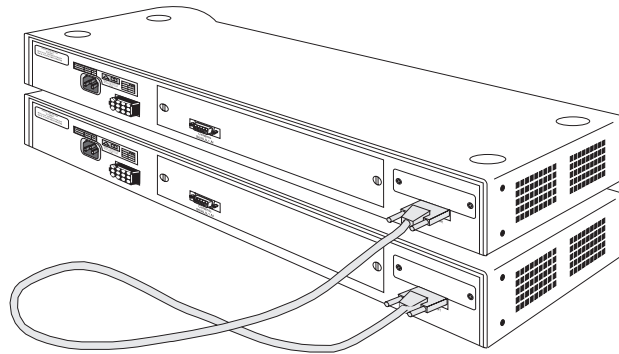

Stacking Up To Four Units

You can stack up to four Switch units with a single SuperStack II Switch Matrix Module and the appropriate number of Matrix Cables.



You only need one Matrix Module for each stack.

To stack up to four Switch units:

- 1 Power-off all the units.
- 2 Arrange the units as required. They can be rack-mounted or free-standing; if you choose to have them free-standing, remember to position the rubber feet as detailed in [“Placing Units On Top of Each Other”](#) on [page 25](#). When positioning the units, note that Matrix Cables are 1m (3.28ft) long.
- 3 Install the Matrix Module into one of the units. You can find instructions for doing this in the documentation that accompanies the Matrix Module. We recommend that for ease of configuration, the Matrix Module should be installed in the *bottom* Switch of your stack.
- 4 Connect the Matrix Cables, as shown in [Figure 9](#):
 - a Connect a Matrix Cable to the port marked Unit 1 on the Matrix Module. Connect the other end of this cable to the matrix port of the Switch that contains the Matrix Module.
 - b Connect a second Matrix Cable to the port marked Unit 2 on the Matrix Module. Connect the other end of this cable to the matrix port of the second Switch.
 - c Repeat steps **a** and **b** for any additional units.

- 5 If you use the management software of the units:
 - Ensure that all the units have the same version of management software
 - Ensure that you re-configure the stack-wide features on all the units

For more information about management software, see [“Managing the Switch”](#) on [page 32](#).

Figure 9 A stack of units with a Matrix Module

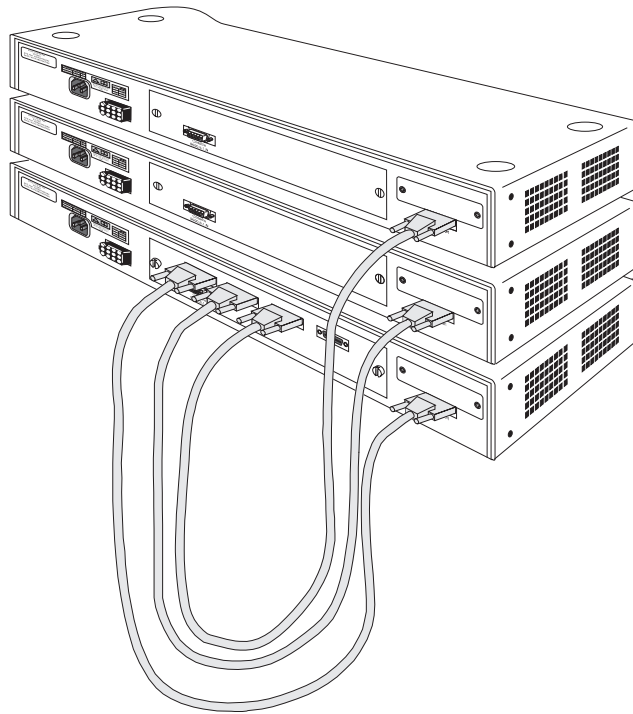

The Power-up Sequence

The following sections describe how to get your Switch 1100 powered-up and ready for operation.

Connecting a Redundant Power System

You can connect a SuperStack II Advanced Redundant Power System (part number 3C16071) to the Switch. This unit, which is also known as an RPS, is designed to maintain the power to your Switch if a power supply failure occurs.

If your Switch has no Expansion Module installed, or has a Matrix Module or 100BASE-FX Module installed, the RPS unit requires one 60W Power Module (part number 3C16072).

If your Switch has another Expansion Module installed, the RPS unit requires one 100W Power Module (part number 3C16073).



CAUTION: *The Switch can only use a SuperStack II Advanced Redundant Power System output.*

Powering-up the Switch 1100



Use the following sequence of steps to power-up the Switch.

CAUTION: *The Switch has no ON/OFF switch; the only method of connecting or disconnecting main power is by connecting or disconnecting the power cord.*

- 1 Plug the power cord into the power socket at the rear of the Switch.
- 2 Plug the other end of the power cord into your power outlet

The Switch powers-up and runs through its Power On Self Test (POST), which takes approximately 12 seconds.

Checking for Correct Operation

During the Power On Self Test, all ports on the Switch are disabled and the LEDs light in the following sequence:

- All unit LEDs light
- Module LEDs light
- Port Status LEDs light in a rapid cycle

When the POST has completed, check the Power/Self Test LED to check that your Switch is operating correctly. [Table 4](#) shows possible colors for the LED.

Table 4 LED colors

Color	State
Green	The Switch is powered-up and operating normally
Yellow	The Switch has failed its Power On Self Test. This occurs if any of the ports fail during power-up.
Off	The Switch is not receiving power.

If there is evidence of a problem, see [“Solving Problems Indicated by LEDs”](#) on [page 31](#).

Choosing the Correct Cables

All of the ports on the front of the Switch 1100 are configured as MDIX (cross-over). If you want to make a connection to another MDIX port, you need a *cross-over* cable. Most of the 10BASE-T and 100BASE-TX ports on 3Com devices are MDIX-only. Many ports on workstations and servers are configured as MDI (straight-through). If you want to make a connection to an MDI port, you need to use a standard *straight-through* cable. This is illustrated in [Figure 10](#).

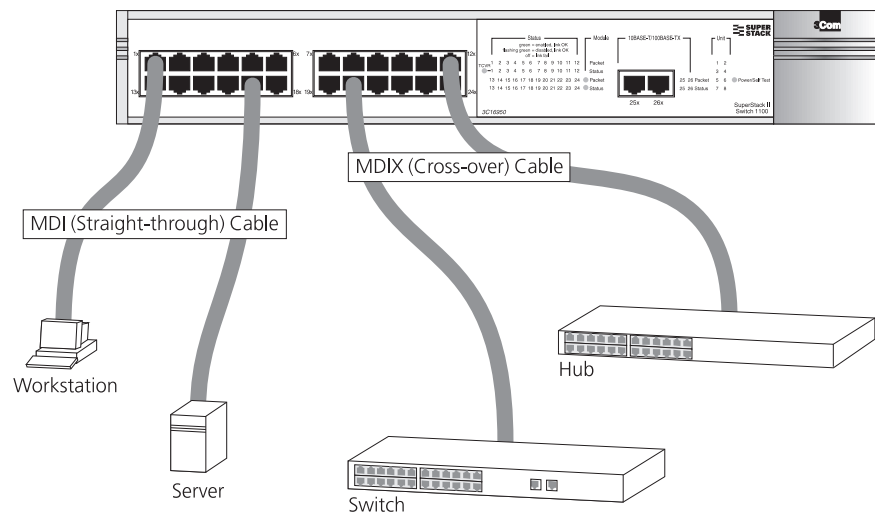
Figure 10 Connecting other devices to the Switch 1100

Solving Problems Indicated by LEDs

If the LEDs on the Switch indicate a problem, refer to [Table 5](#) which contains a list of possible problems and suggested solutions.

Table 5 Problems indicated by LEDs

Problem	Suggested Solution
A Power LED does not light	Check that the power cable is firmly connected to the relevant Switch unit and to the supply outlet. If the connection is secure and there is still no power, you may have a faulty power cord.
On powering-up, the Power/Self Test LED lights yellow and a Unit LED lights green	The relevant Switch unit has failed its Power On Self Test (POST) because of an internal problem. Contact your supplier for advice.
An Expansion Module Status LED flashes yellow	An unrecognized Expansion Module is installed into the relevant Switch unit. You may need to remove the Module, or upgrade the management software used by the Switch to a version that recognizes the Module. Contact your supplier for further advice.
A link is connected and yet the Status LED for the port does not light	Check that: <ul style="list-style-type: none"> ■ All connections are secure. ■ The devices at both ends of the link are powered-up. ■ The connection uses cross-over cable if you are linking a 10BASE-T or 100BASE-TX port with a device that is MDIX-only.
The Packet LED for a 10BASE-T port is lit, but the Status LED for that port does not light	The 10BASE-T port is connected to a 10BASE-T/100BASE-TX port or a 100BASE-TX port. Do one of the following: <ul style="list-style-type: none"> ■ If the 10BASE-T port is connected to a 10BASE-T/100BASE-TX port, enable auto-negotiation on the 10BASE-T/100BASE-TX port, or set the 10BASE-T/100BASE-TX port to 10Mbps. ■ If the 10BASE-T port is connected to a 100BASE-TX port, move the 10BASE-T connection to a 100BASE-TX connection.
The Packet LED for an Expansion Module is flashing even though there is no external traffic on this link	If you have a Matrix Module installed into your Switch, this is normal operation. Management software in the stack passes packets between units even if there is no other traffic activity.

For information about solving problems when managing the Switch, refer to the Problem Solving chapter in the “SuperStack II Switch Management Guide” (DUA1695-0BAA0x).

Managing the Switch

The Switch contains software that allows you to change and monitor the way it works. This *management software* is not required to get the Switch working, but if you do use it, you may improve the efficiency of the Switch and therefore improve the overall performance of your network. For information on managing the Switch using the management software, refer to the “SuperStack II Switch Management Guide” (part number DUA1695-0BAA0x).

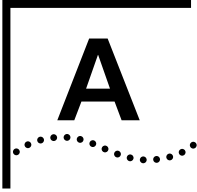

SAFETY INFORMATION

You must read the following safety information before carrying out any installation or removal of components, or any maintenance procedures on the Switch 1100.



WARNING: Warnings contain directions that you must follow for your personal safety. Follow all directions carefully.

You must read the following safety information carefully before you install or remove the unit.



AVERTISSEMENT: Les avertissements présentent des consignes que vous devez respecter pour garantir votre sécurité personnelle. Vous devez respecter attentivement toutes les consignes.

Nous vous demandons de lire attentivement les consignes suivantes de sécurité avant d'installer ou de retirer l'appareil.



WARNHINWEIS: Warnhinweise enthalten Anweisungen, die Sie zu Ihrer eigenen Sicherheit befolgen müssen. Alle Anweisungen sind sorgfältig zu befolgen.

Sie müssen die folgenden Sicherheitsinformationen' sorgfältig durchlesen, bevor Sie das Gerät installieren oder ausbauen.

Important Safety Information

- Installation and removal of the unit must be carried out by qualified personnel only.
- If installing the Switch unit in a stack with SuperStack II Hub units, the Switch 1100 unit must be installed below the narrower Hub units.
- The unit should never be connected to an A.C. outlet (power supply) without an earth (ground) connection.
- The unit must be connected to an earthed (grounded) outlet to comply with European safety standards.
- Power Cord Set:
This must be approved for the country where it is used:
 - USA and Canada
 - The cord set must be UL-approved and CSA certified.
 - The minimum specification for the flexible cord is:
No. 18 AWG
Type SV or SJ
3-conductor
 - The cord set must have a rated current capacity of at least 10A.
 - The attachment plug must be an earth-grounding type with a NEMA 5-15P (15A, 125V) or NEMA 6-15P (15A, 250V) configuration.
 - Denmark
 - The supply plug must comply with section 107-2-D1, standard DK2-1a or DK2-5a.
 - Switzerland
 - The supply plug must comply with SEV/ASE 1011.
- The appliance coupler (the connector to the unit and not the wall plug) must have a configuration for mating with an EN60320/IEC320 appliance inlet.
- The socket outlet must be near to the unit and easily accessible. You can only remove power from the unit by disconnecting the power cord from the outlet.
- This unit operates under SELV (Safety Extra Low Voltage) conditions according to IEC 950. The conditions are only maintained if the equipment to which it is connected also operates under SELV conditions.
- Switzerland only:
The supply plug must comply with SEV/ASE 1011.

- France and Peru only:
This unit cannot be powered from IT+ supplies. If your supplies are of IT type, this unit must be powered by 230V (2P+T) via an isolation transformer ratio 1:1, with the secondary connection point labelled Neutral, connected directly to earth (ground).
†Impédance à la terre.
- UK only:
The Switch 1100 is covered by OfTel General Approval, NS/G/12345/J/100003, for indirect connection to a public telecommunications system. This can only be achieved using the console port on the unit and an approved modem.
- Sockets for Redundant Power System (RPS):
Only connect an *Advanced Redundant Power System (3C16071)* to the *Redundant Power System* socket.



WARNING: RJ45 Ports. *These are shielded RJ45 data sockets. They cannot be used as telephone sockets. Only connect RJ45 data connectors to these sockets.*

Either shielded or unshielded data cables with shielded or unshielded jacks can be connected to these data sockets.

L'information de Sécurité Importante

- L'installation et la dépose de ce groupe doivent être confiés à un personnel qualifié.
- Si vous entassez l'unité Switch avec les unités SuperStack II Hub, l'unité Switch 1100 doit être installée en dessous des unités Hub plus étroites.
- L'unité ne devrait pas être branchée à une prise de courant C.A. (source de courant) sous aucun prétexte sans un branchement mise à la terre (mise à la masse).
- Vous devez raccorder ce groupe à une sortie mise à la terre (mise à la masse) afin de respecter les normes européennes de sécurité.
- Cordon électrique:
Il doit être agréé dans le pays d'utilisation :

Etats-Unis et Canada	<ul style="list-style-type: none"> ■ Le cordon doit avoir reçu l'homologation des UL et un certificat de la CSA ■ Le cordon souple doit respecter, à titre minimum, les spécifications suivantes : <ul style="list-style-type: none"> ■ calibre 18 AWG ■ type SV ou 5J ■ à 3 conducteurs ■ Le cordon doit être en mesure d'acheminer un courant nominal d'au moins 10 A ■ La prise femelle de branchement doit être du type à mise à la terre (mise à la masse) et respecter la configuration NEMA 5-15P (15 A, 125 V) ou NEMA 6-15P (15 A, 250 V)
Danemark	<ul style="list-style-type: none"> ■ La prise mâle d'alimentation doit respecter la section 107-2 D1 de la norme DK2 1a ou DK2 5a
Suisse	<ul style="list-style-type: none"> ■ La prise mâle d'alimentation doit respecter la norme SEV/ASE 1011
- Le coupleur d'appareil (le connecteur du groupe et non pas la prise murale) doit respecter une configuration qui permet un branchement sur une entrée d'appareil EN60320/CEI 320.
- La prise secteur doit se trouver à proximité de l'appareil et son accès doit être facile. Vous ne pouvez mettre l'appareil hors circuit qu'en débranchant son cordon électrique au niveau de cette prise.

- L'appareil fonctionne à une tension extrêmement basse de sécurité qui est conforme à la norme CEI 950. Ces conditions ne sont maintenues que si l'équipement auquel il est raccordé fonctionne dans les mêmes conditions.
- France et Pérou uniquement:
Ce groupe ne peut pas être alimenté par un dispositif à impédance à la terre. Si vos alimentations sont du type impédance à la terre, ce groupe doit être alimenté par une tension de 230 V (2 P+T) par le biais d'un transformateur d'isolement à rapport 1:1, avec un point secondaire de connexion portant l'appellation Neutre et avec raccordement direct à la terre (masse).
- Branchez uniquement un *Advanced Redundant Power System* (3C16071) sur la prise femelle du *Redundant Power System*.



AVERTISSEMENT: Les ports RJ45. Il s'agit de prises femelles blindées de données RJ45. Vous ne pouvez pas les utiliser comme prise de téléphone. Branchez uniquement des connecteurs de données RJ45 sur ces prises femelles.

Les câbles de données blindés ou non blindés, avec les jacks blindés ou non blindés, l'un ou l'autre, peuvent être branchés à ces prises de courant de données.

Wichtige Sicherheitsinformationen

- Die Installation und der Ausbau des Geräts darf nur durch Fachpersonal erfolgen.
- Wenn die Switch 1100 Einheit in einer Stapel mit anderen SuperStack II Hub Einheiten eingebaut werden soll, muß die Switch 1100 Einheit unter die schmalere Hub Einheiten eingebaut werden.
- Das Gerät ist unter keinen Umständen an einen Wechselstrom (A.C.) Netzstecker anzuschließen ohne Erdungsleitung.
- Das Gerät muß an eine geerdete Steckdose angeschlossen werden, die die europäischen Sicherheitsnormen erfüllt.
- Der Anschlußkabelsatz muß mit den Bestimmungen des Landes übereinstimmen, in dem er verwendet werden soll.
- Der Gerätestecker (der Anschluß an das Gerät, nicht der Wandsteckdosenstecker) muß eine passende Konfiguration für einen Geräteeingang gemäß EN60320/IEC 320 haben.
- Die Netzsteckdose muß in der Nähe des Geräts und leicht zugänglich sein. Die Stromversorgung des Geräts kann nur durch Herausziehen des Geräte-Netzsteckdosenkabels aus der Netzsteckdose unterbrochen werden.
- Der Betrieb dieses Geräts erfolgt unter den SELV-Bedingungen (Sicherheitskleinstspannung) gemäß IEC 950. Diese Bedingungen sind nur gegeben, wenn auch die an das Gerät angeschlossenen Geräte unter SELV-Bedingungen betrieben werden.
- Nur ein *Advanced Redundant Power System* (3C16071) an den *Redundant Power System* Anschluß anschließen.



WARNHINWEIS: RJ45 Ports. RJ45-Anschlüsse. Dies sind abgeschirmte RJ45-Datenbuchsen. Sie können nicht als Telefonanschlußbuchsen verwendet werden. An diesen Buchsen dürfen nur RJ45-Datenstecker angeschlossen werden.

Diese Datenstecker können entweder mit abgeschirmten oder unabgeschirmten Datenkabeln mit abgeschirmten oder unabgeschirmten Klinkensteckern verbunden werden.

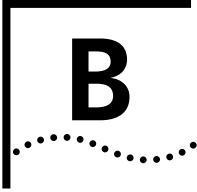

PIN-OUTS

Null Modem Cable 9-pin to RS-232 25-pin

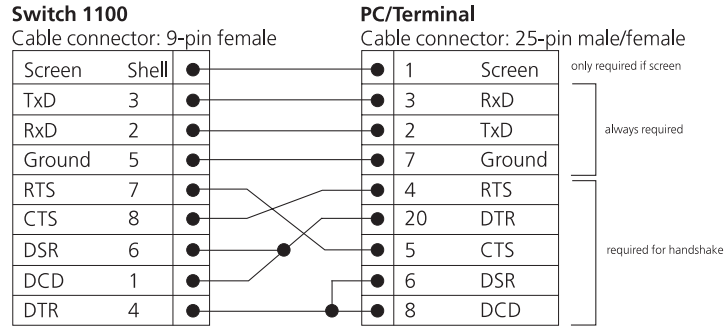

PC-AT Serial Cable 9-pin to 9-pin

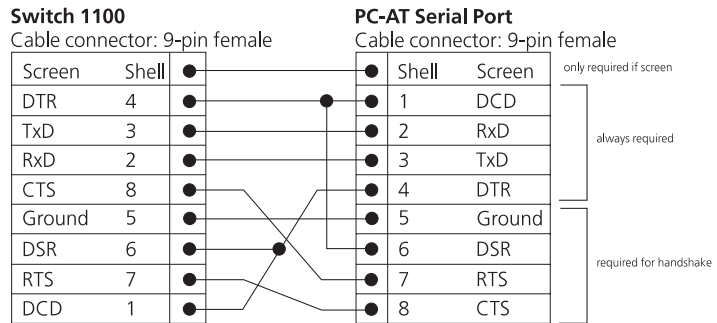

Modem Cable

9-pin to RS-232 25-pin

Switch 1100

Cable connector: 9-pin female

Screen	Shell	●
TxD	3	●
RxD	2	●
RTS	7	●
CTS	8	●
DSR	6	●
Ground	5	●
DCD	1	●
DTR	4	●

RS-232 Modem Port

Cable connector: 25-pin male

●	1	Screen
●	2	TxD
●	3	RxD
●	4	RTS
●	5	CTS
●	6	DSR
●	7	Ground
●	8	DCD
●	20	DTR

RJ45 Pin Assignments

Pin assignments are identical for 10BASE-T and 100BASE-TX RJ45 connectors

Table 6 Pin assignments

Pin Number	Signal	Function
<i>Ports configured as MDI</i>		
1	TxData +	Transmit data
2	TxData –	Transmit data
3	RxData +	Receive Data
4	Not assigned	
5	Not assigned	
6	RxData –	Receive data
7	Not assigned	
8	Not assigned	
<i>Ports configured as MDIX</i>		
1	RxData +	Receive Data
2	RxData –	Receive Data
3	TxData +	Transmit data
4	Not assigned	
5	Not assigned	
6	TxData –	Transmit data
7	Not assigned	
8	Not assigned	

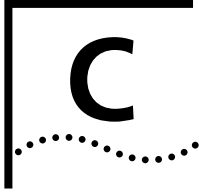

TECHNICAL SPECIFICATIONS

Physical Dimensions	Height: 76mm (3.0 in.) x Width: 483mm (19.0 in.) x Depth 300mm (12.0 in.) Weight: 4.4kg (9.7lbs)
Environmental Requirements	
Operating Temperature	0° to 50°C (32° to 122°F)
Storage Temperature	-10° to +70°C (14° to 158°F)
Operating Humidity	10 to 95% relative humidity, non-condensing
Standards	EN60068 (IEC68)
Safety	
Agency Certifications	UL 1950, EN60950, CSA 22.2 No. 950, IEC 950
EMC	
Emissions	EN55022 Class B*, FCC Part 15 Subpart B Class A, ICES-003 Class A, VCCI Class B*, AS/NZS 3548 Class B*, CNS 13438 Class A * Category 5 screened cables must be used to ensure compliance with the class B requirements of this standard. The use of unshielded cables (category 3 or 5 for 10BASE-T ports or category 5 for 100BASE-TX ports) complies with the class A requirements.
Immunity	EN50082-1
Heat Dissipation	117 watts maximum (400 BTU/hour maximum)
Power Supply	
AC Line Frequency	50/60 Hz
Input Voltage Options	90–240 VAC
Current Rating	3 amps (maximum)

(continued)

Standards Supported	SNMP SNMP protocol (RFC 1157) MIB-II (RFC 1213) Bridge MIB (RFC 1493) Repeater MIB (RFC 1516) VLAN MIB (RFC 1573) RMON MIB (RFC 1271) BOOTP (RFC 951)	Terminal Emulation <ul style="list-style-type: none">■ Telnet (RFC 854) Protocols Used for Administration <ul style="list-style-type: none">■ UDP (RFC 768)■ IP (RFC 791)■ ICMP (RFC 792)■ TCP (RFC 793)■ ARP (RFC 826)■ TFTP (RFC 783)
Year 2000 Compliance	For information on Year 2000 Compliance and 3Com products, visit the 3Com Year 2000 Web page: http://www.3com.com/products/yr2000.html	

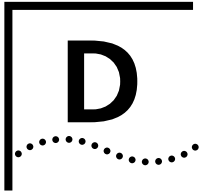

TECHNICAL SUPPORT

3Com provides easy access to technical support information through a variety of services. This appendix describes these services.

Information contained in this appendix is correct at time of publication. For the most recent information, 3Com recommends that you access the 3Com Corporation World Wide Web site.

Online Technical Services

3Com offers worldwide product support 24 hours a day, 7 days a week, through the following online systems:

- World Wide Web site
- 3Com Knowledgebase Web Services
- 3Com FTP site
- 3Com Bulletin Board Service (3Com BBS)
- 3Com FactsSM Automated Fax Service

World Wide Web Site

To access the latest networking information on the 3Com Corporation World Wide Web site, enter this URL into your Internet browser:

<http://www.3com.com/>

This service provides access to online support information such as technical documentation and software, as well as support options that range from technical education to maintenance and professional services.

3Com Knowledgebase Web Services

This interactive tool contains technical product information compiled by 3Com expert technical engineers around the globe. Located on the World Wide Web at <http://knowledgebase.3com.com>, this service gives all 3Com customers and partners complementary, round-the-clock access to technical information on most 3Com products.

3Com FTP Site Download drivers, patches, software, and MIBs across the Internet from the 3Com public FTP site. This service is available 24 hours a day, 7 days a week.

To connect to the 3Com FTP site, enter the following information into your FTP client:

- Hostname: **ftp.3com.com**
- Username: **anonymous**
- Password: **<your Internet e-mail address>**



You do not need a user name and password with Web browser software such as Netscape Navigator and Internet Explorer.

3Com Bulletin Board Service

The 3Com BBS contains patches, software, and drivers for 3Com products. This service is available through analog modem or digital modem (ISDN) 24 hours a day, 7 days a week.

Access by Analog Modem

To reach the service by modem, set your modem to 8 data bits, no parity, and 1 stop bit. Call the telephone number nearest you:

Country	Data Rate	Telephone Number
Australia	Up to 14,400 bps	61 2 9955 2073
Brazil	Up to 28,800 bps	55 11 5181 9666
France	Up to 14,400 bps	33 1 6986 6954
Germany	Up to 28,800 bps	4989 62732 188
Hong Kong	Up to 14,400 bps	852 2537 5601
Italy	Up to 14,400 bps	39 2 27300680
Japan	Up to 14,400 bps	81 3 5977 7977
Mexico	Up to 28,800 bps	52 5 520 7835
P.R. of China	Up to 14,400 bps	86 10 684 92351
Taiwan, R.O.C.	Up to 14,400 bps	886 2 377 5840
U.K.	Up to 28,800 bps	44 1442 438278
U.S.A.	Up to 53,333 bps	1 847 262 6000

Access by Digital Modem

ISDN users can dial in to the 3Com BBS using a digital modem for fast access up to 64 Kbps. To access the 3Com BBS using ISDN, call the following number:

1 847 262 6000

3Com Facts Automated Fax Service

The 3Com Facts automated fax service provides technical articles, diagrams, and troubleshooting instructions on 3Com products 24 hours a day, 7 days a week.

Call 3Com Facts using your Touch-Tone telephone:

1 408 727 7021

Support from Your Network Supplier

If you require additional assistance, contact your network supplier. Many suppliers are authorized 3Com service partners who are qualified to provide a variety of services, including network planning, installation, hardware maintenance, application training, and support services.

When you contact your network supplier for assistance, have the following information ready:

- Product model name, part number, and serial number
- A list of system hardware and software, including revision levels
- Diagnostic error messages
- Details about recent configuration changes, if applicable

If you are unable to contact your network supplier, see the following section on how to contact 3Com.

Support from 3Com

If you are unable to obtain assistance from the 3Com online technical resources or from your network supplier, 3Com offers technical telephone support services. To find out more about your support options, call the 3Com technical telephone support phone number at the location nearest you.

When you contact 3Com for assistance, have the following information ready:

- Product model name, part number, and serial number
- A list of system hardware and software, including revision levels
- Diagnostic error messages
- Details about recent configuration changes, if applicable

Here is a list of worldwide technical telephone support numbers:

Country	Telephone Number	Country	Telephone Number
Asia, Pacific Rim			
Australia	1 800 678 515	P.R. of China	10800 61 00137 or
Hong Kong	800 933 486		021 6350 1590
India	+61 2 9937 5085	Singapore	800 6161 463
Indonesia	001 800 61 009	S. Korea	
Japan	0031 61 6439	From anywhere in S. Korea:	00798 611 2230
Malaysia	1800 801 777	From Seoul:	(0)2 3455 6455
New Zealand	0800 446 398	Taiwan, R.O.C.	0080 611 261
Pakistan	+61 2 9937 5085	Thailand	001 800 611 2000
Philippines	1235 61 266 2602		
Europe			
From anywhere in Europe, call:	+31 (0)30 6029900 phone		
	+31 (0)30 6029999 fax		
Europe, South Africa, and Middle East			
From the following countries, you may use the toll-free numbers:			
Austria	0800 297468	Netherlands	0800 0227788
Belgium	0800 71429	Norway	800 11376
Denmark	800 17309	Poland	00800 3111206
Finland	0800 113153	Portugal	0800 831416
France	0800 917959	South Africa	0800 995014
Germany	0800 1821502	Spain	900 983125
Hungary	00800 12813	Sweden	020 795482
Ireland	1800 553117	Switzerland	0800 55 3072
Israel	1800 9453794	U.K.	0800 966197
Italy	1678 79489		
Latin America			
Argentina	AT&T +800 666 5065	Mexico	01 800 CARE (01 800 2273)
Brazil	0800 13 3266	Peru	AT&T +800 666 5065
Chile	1230 020 0645	Puerto Rico	800 666 5065
Colombia	98012 2127	Venezuela	AT&T +800 666 5065
North America			
	1 800 NET 3Com		
	(1 800 638 3266)		
	Enterprise Customers:		
	1 800 876-3266		

Returning Products for Repair

Before you send a product directly to 3Com for repair, you must first obtain an authorization number. Products sent to 3Com without authorization numbers will be returned to the sender unopened, at the sender's expense.

To obtain an authorization number, call or fax:

Country	Telephone Number	Fax Number
Asia, Pacific Rim	+ 65 543 6500	+ 65 543 6348
Europe, South Africa, and Middle East	+ 31 30 6029900	+ 31 30 6029999
Latin America	1 408 326 2927	1 408 326 3355

From the following countries, you may call the toll-free numbers; select option 2 and then option 2:

Austria	0800 297468	
Belgium	0800 71429	
Denmark	800 17309	
Finland	0800 113153	
France	0800 917959	
Germany	0800 1821502	
Hungary	00800 12813	
Ireland	1800553117	
Israel	1800 9453794	
Italy	1678 79489	
Netherlands	0800 0227788	
Norway	800 11376	
Poland	00800 3111206	
Portugal	0800 831416	
South Africa	0800 995014	
Spain	900 983125	
Sweden	020 795482	
Switzerland	0800 55 3072	
U.K.	0800 966197	
U.S.A. and Canada	1 800 NET 3Com (1 800 638 3266)	1 408 326 7120 (not toll-free)
	Enterprise Customers: 1 800 876 3266	

GLOSSARY

10BASE-T	The IEEE specification for 10Mbps Ethernet over Category 3, 4 or 5 twisted pair cable.
100BASE-FX	The IEEE specification for 100Mbps Fast Ethernet over fiber-optic cable.
100BASE-TX	The IEEE specification for 100Mbps Fast Ethernet over Category 5 twisted-pair cable.
auto-negotiation	A feature on twisted pair ports that allows them to advertise their capabilities for speed, duplex and flow control. When connected to a port that also supports auto-negotiation, the link can automatically configure itself to the optimum setup.
backbone	The part of a network used as a primary path for transporting traffic between network segments.
bandwidth	The information capacity, measured in bits per second, that a channel can transmit. The bandwidth of Ethernet is 10Mbps, the bandwidth of Fast Ethernet is 100Mbps.
baud	The signalling rate of a line, that is, the number of transitions (voltage or frequency changes) made per second. Also known as <i>line speed</i> .
bridge	<p>A device that interconnects two LANs of a different type to form a single logical network that comprises of two network segments.</p> <p>Bridges learn which endstations are on which network segment by examining the source addresses of packets. They then use this information to forward packets based on their destination address. This process is known as filtering.</p>
broadcast	A packet sent to all devices on a network.

- broadcast storm** Multiple simultaneous broadcasts that typically absorb all the available network bandwidth and can cause a network to fail. Broadcast storms can be due to faulty network devices.
- collision** A term used to describe two colliding packets in an Ethernet network. Collisions are a part of normal Ethernet operation, but a sudden prolonged increase in the number of collisions can indicate a problem with a device, particularly if it is not accompanied by a general increase in traffic.
- CSMA/CD** Carrier-sense Multiple Access with Collision Detection. The protocol defined in Ethernet and IEEE 802.3 standards in which devices transmit only after finding a data channel clear for a period of time. When two devices transmit simultaneously, a collision occurs and the colliding devices delay their retransmissions for a random length of time.
- endstation** A computer, printer or server that is connected to a network.
- Ethernet** A LAN specification developed jointly by Xerox, Intel and Digital Equipment Corporation. Ethernet networks use CSMA/CD to transmit packets at a rate of 10Mbps over a variety of cables.
- Ethernet address** See *MAC address*.
- Fast Ethernet** An Ethernet system that is designed to operate at 100Mbps.
- forwarding** The process of sending a packet toward its destination using a networking device.
- filtering** The process of screening a packet for certain characteristics, such as source address, destination address, or protocol. Filtering is used to determine whether traffic is to be forwarded, and can also prevent unauthorized access to a network or network devices.
- flow control** A congestion control mechanism. Congestion is caused by devices sending traffic to already overloaded port on a Switch. Flow control prevents packet loss and inhibits devices from generating more traffic until the period of congestion ends.
- full duplex** A system that allows packets to be transmitted and received at the same time and, in effect, doubles the potential throughput of a link.
- half duplex** A system that allows packets to transmitted and received, but not at the same time. Contrast with *full duplex*.

- hub** A device that regenerates LAN traffic so that the transmission distance of that signal can be extended. Hubs are similar to repeaters, in that they connect LANs of the same type; however they connect more LANs than a repeater and are generally more sophisticated.
- IEEE** Institute of Electrical and Electronics Engineers. This American organization was founded in 1963 and sets standards for computers and communications.
- IEEE 802.1D** A standard that defines the behavior of bridges in an Ethernet network.
- IETF** Internet Engineering Task Force. An organization responsible for providing engineering solutions for TCP/IP networks. In the network management area, this group is responsible for the development of the SNMP protocol.
- IP** Internet Protocol. IP is a layer 3 network protocol that is the standard for sending data through a network. IP is part of the TCP/IP set of protocols that describe the routing of packets to addressed devices.
- IPX** Internetwork Packet Exchange. IPX is a layer 3 and 4 network protocol designed for networks that use Novell® Netware®.
- IP address** Internet Protocol address. A unique identifier for a device attached to a network using TCP/IP. The address is written as four octets separated with periods (full-stops), and is made up of a network section, an optional subnet section and a host section.
- LAN** Local Area Network. A network of endstations (such as PCs, printers, servers) and network devices (hubs and switches) that cover a relatively small geographic area (usually not larger than a floor or building). LANs are characterized by high transmission speeds over short distances (up to 1000m).
- line speed** See *baud*.
- loop** An event that occurs when two network devices are connected by more than one path, thereby causing packets to repeatedly cycle around the network and not reach their destination.
- MAC** Media Access Control. A protocol specified by the IEEE for determining which devices have access to a network at any one time.

- MAC address** Media Access Control address; also called hardware or physical address. A layer 2 address associated with a particular network device. Most devices that connect to a LAN have a MAC address assigned to them as they are used to identify other devices in a network. MAC addresses are 6 bytes long.
- MDI** Medium Dependent Interface. An Ethernet port connection where the transmitter of one device is connected to the receiver of another device.
- MDI-X** Medium Dependent Interface Cross-over. An Ethernet port connection where the internal transmit and receive lines are crossed.
- multicast** A packet sent to a specific group of endstations on a network.
- NIC** Network Interface Card. A circuit board installed in an endstation that allows it to be connected to a network.
- POST** Power On Self Test. An internal test that a Switch carries out when it is powered-up.
- protocol** A set of rules for communication between devices on a network. The rules dictate format, timing, sequencing and error control.
- repeater** A simple device that regenerates LAN traffic so that the transmission distance of that signal can be extended. Repeaters are used to connect two LANs of the same network type.
- router** A device that provides WAN links between geographically separate networks.
- RPS** Redundant Power System. A device that provides a backup source of power when connected to a Switch.
- segment** A section of a LAN that is connected to the rest of the network using a switch or bridge.
- server** A computer in a network that is shared by multiple endstations. Servers provide endstations with access to shared network services such as computer files and printer queues.
- SLIP** Serial Line Internet Protocol. A protocol that allows IP to run over a serial line (console port) connection.

- SNMP** Simple Network Management Protocol. The current IETF standard protocol for managing devices on an TCP/IP network.
- stack** A group of network devices that are integrated to form a single logical device.
- switch** A device that interconnects several LANs to form a single logical LAN that comprises of several LAN segments. Switches are similar to bridges, in that they connect LANs of a different type; however they connect more LANs than a bridge and are generally more sophisticated.
- Switch Database** A database that is stored by a switch to determine if a packet should be forwarded, and which port should forward the packet if it is to be forwarded.
- TCP/IP** Transmission Control Protocol/Internet Protocol. This is the name for two of the most well-known protocols developed for the interconnection of networks. Originally a UNIX standard, TCP/IP is now supported on almost all platforms, and is the protocol of the Internet. TCP relates to the content of the data travelling through a network — ensuring that the information sent arrives in one piece when it reaches its destination. IP relates to the address of the endstation to which data is being sent, as well as the address of the destination network.
- Telnet** A TCP/IP application protocol that provides a virtual terminal service, letting a user log into another computer system and access a device as if the user were connected directly to the device.
- TFTP** Trivial File Transfer Protocol. Allows you to transfer files (such as software upgrades) from a remote device using the local management capabilities of the Switch.
- unicast** A packet sent to a single endstation on a network.
- WAN** Wide Area Network. A communications network that covers a wide area. A WAN can cover a large geographic area, and may contain several LANs within it.

INDEX

Numbers

10BASE-T ports 13
10BASE-T/100BASE-TX ports 13
3C number 15
3Com bulletin board service (3Com BBS) 44
3Com Knowledgebase Web Services 43
3Com URL 43
3ComFacts 45

A

auto-negotiating ports 13

B

bulletin board service 44

C

cable
 choosing the correct 30
 Matrix 16
 maximum length 13, 21
 pin-outs 39
console port 15
conventions
 notice icons, About This Guide 8
 text, About This Guide 8
cross-over configuration 13, 30

E

Ethernet address of the Switch 15
Expansion Module slot 16

F

Fast Ethernet configuration rules 20
fax service (3ComFacts) 45
full duplex configuration rules 21

G

glossary 49

H

hardware features 12

I

installing the Switch 23
 prerequisites 24

L

LEDs 14
Light Emitting Diodes. See LEDs

M

MAC address of the Switch 15
management software 32
managing the Switch 32
Matrix Cable 16
Matrix Module 16
Matrix Module slot 16
matrix port 16
MDI configuration 30
MDIX configuration 13, 30
MIBs 44

N

network configuration examples 17
network supplier support 45

O

online technical services 43

P

pin assignments
 modem cable 40
 null modem cable 39

- RJ45 40
 - serial cable 39
- pin-outs 39
- ports
 - 10BASE-T 13
 - 10BASE-T/100BASE-TX 13
 - auto-negotiating 13
 - console 15
 - matrix 16
- power socket 15
- powering-up a Switch 1100 29
- product name 15

R

- rack mounting a Switch 1100 24
- Redundant Power System. See RPS
- returning products for repair 47
- RPS 15
 - connecting 29
 - socket 15

S

- safety information
 - English 34
 - French 36
 - German 38
- segment, maximum length 13, 21
- serial number of the Switch 15
- serial port. See console port
- socket
 - power 15
 - RPS 15
- specifications, system 41
- stacking a Switch 1100 26
- standards supported 42
- straight-through configuration 30
- Switch 1100
 - 10BASE-T ports 13
 - 10BASE-T/100BASE-TX ports 13
 - 3C number 15
 - console port 15
 - desktop configuration 19
 - dimensions 41
 - Ethernet address 15
 - features 12
 - installation 23, 24
 - MAC address 15
 - power socket 15
 - powering-up 29
 - product name 15
 - rack mounting 24

- rear view 15
- RPS socket 15
- serial number 15
- size 41
- stacking 26
- standards supported 42
- unit information label 15
- weight 41
- workgroup configuration 17, 18

system specifications 41

T

- technical support
 - 3Com Knowledgebase Web Services 43
 - 3Com URL 43
 - bulletin board service 44
 - fax service 45
 - network suppliers 45
 - product repair 47
- topology rules for Fast Ethernet 20
- topology rules with full duplex 21
- Transceiver Module slot 16

U

- unit information label 15
- URL 43

W

- World Wide Web (WWW) 43

Y

- Year 2000 compliance 42

3Com Corporation LIMITED WARRANTY

SUPERSTACK® II SWITCH 1100

HARDWARE

3Com warrants this hardware product to be free from defects in workmanship and materials, under normal use and service, for the following length of time from the date of purchase from 3Com or its authorized reseller:

Lifetime,

except that the Fan and Power Supply hardware (if any) are warranted for five (5) years

3Com's sole obligation under this express warranty shall be, at 3Com's option and expense, to repair the defective product or part, deliver to Customer an equivalent product or part to replace the defective item, or if neither of the two foregoing options is reasonably available, 3Com may, in its sole discretion, refund to Customer the purchase price paid for the defective product. All products that are replaced will become the property of 3Com. Replacement products may be new or reconditioned. 3Com warrants any replaced or repaired product or part for ninety (90) days from shipment, or the remainder of the initial warranty period, whichever is longer.

Advance Replacement is provided for five (5) years, after which time it may be available for a specified fee. 3Com will ship the replacement product not later than five (5) business days after receiving the request for advance replacement, BUT MAY BE DELAYED DUE TO EXPORT OR IMPORT PROCEDURES. When an advance replacement is provided and Customer fails to return the original product to 3Com within fifteen (15) days after shipment of the replacement, 3Com will charge Customer for the replacement, at list price.

SOFTWARE

3Com warrants that each software program licensed from it will perform in substantial conformance to its program specifications, for a period of ninety (90) days from the date of purchase from 3Com or its authorized reseller. 3Com warrants the media containing software against failure during the warranty period. No updates are provided. 3Com's sole obligation under this express warranty shall be, at 3Com's option and expense, to refund the purchase price paid by Customer for any defective software product, or to replace any defective media with software which substantially conforms to applicable 3Com published specifications. Customer assumes responsibility for the selection of the appropriate applications program and associated reference materials. 3Com makes no warranty or representation that its software products will meet Customer's requirements or work in combination with any hardware or applications software products provided by third parties, that the operation of the software products will be uninterrupted or error free, or that all defects in the software products will be corrected. For any third party products listed in the 3Com software product documentation or specifications as being compatible, 3Com will make reasonable efforts to provide compatibility, except where the non-compatibility is caused by a "bug" or defect in the third party's product or from use of the software product not in accordance with 3Com's published specifications or user manual.

YEAR 2000 WARRANTY

In addition to the Hardware Warranty and Software Warranty stated above, 3Com warrants that each product sold or licensed to Customer on and after January 1, 1998 that is date sensitive will continue performing properly with regard to such date data on and after January 1, 2000, provided that all other products used by Customer in connection or combination with the 3Com product, including hardware, software, and firmware, accurately exchange date data with the 3Com product, with the exception of those products identified at 3Com's Web site, <http://www.3com.com/products/yr2000.html>, as not meeting this standard. If it appears that any product that is stated to meet this standard does not perform properly with regard to such date data on and after January 1, 2000, and Customer notifies 3Com before the later of April 1, 2000, or ninety (90) days after purchase of the product from 3Com or its authorized reseller, 3Com shall, at its option and expense, provide a software update which would effect the proper performance of such product, repair such product, deliver to Customer an equivalent product to replace such product, or if none of the foregoing is feasible, refund to Customer the purchase price paid for such product.

Any software update or replaced or repaired product will carry a Year 2000 Warranty for ninety (90) days after purchase or until April 1, 2000, whichever is later.

OBTAINING WARRANTY SERVICE

Customer must contact a 3Com Corporate Service Center or an Authorized 3Com Service Center within the applicable warranty period to obtain warranty service authorization. Dated proof of purchase from 3Com or its authorized reseller may be required. Products returned to 3Com's Corporate Service Center must be pre-authorized by 3Com with a Return Material Authorization (RMA) number marked on the outside of the package, and sent prepaid and packaged appropriately for safe shipment, and it is recommended that they be insured or sent by a method that provides for tracking of the package. The repaired or replaced item will be shipped to Customer, at 3Com's expense, not later than thirty (30) days after 3Com receives the defective product.

Dead- or Defective-on-Arrival. In the event a product completely fails to function or exhibits a defect in materials or workmanship within the first forty-eight (48) hours of installation but no later than thirty (30)

days after the date of purchase, and this is verified by 3Com, it will be considered dead- or defective-on-arrival (DOA) and a replacement shall be provided by advance replacement. The replacement product will normally be shipped not later than three (3) business days after 3Com's verification of the DOA product, but may be delayed due to export or import procedures. When an advance replacement is provided and Customer fails to return the original product to 3Com within fifteen (15) days after shipment of the replacement, 3Com will charge Customer for the replacement product, at list price.

3Com shall not be responsible for any software, firmware, information, or memory data of Customer contained in, stored on, or integrated with any products returned to 3Com for repair, whether under warranty or not.

ADDITIONAL SERVICES:

Telephone Support. This SuperStack II® product comes with telephone technical support for ninety (90) days. The ninety (90) day period begins on the date of Customer's product purchase.

The telephone technical support is available from 3Com from 9 a.m. to 5 p.m., local time, Monday through Friday, excluding local holidays. Telephone technical support is limited to the 3Com products designated above and may include assistance with installation, product specific configuration, and identification of equipment problems. Please refer to the Technical Support appendix in the User Guide for telephone numbers.

Response to requests for telephone technical support will be in the form of a return call from a 3Com representative by close of business the following business day.

To qualify for this 90 days of telephone technical support, you must register on the 3Com Web site at <http://support.3Com.com/index.htm>, and provide your date of purchase, product number, and serial number. 3Com reserves the right to modify or cancel this telephone support offering at any time, without advance notice. This offer is not available where prohibited or restricted by law.

WARRANTIES EXCLUSIVE

IF A 3COM PRODUCT DOES NOT OPERATE AS WARRANTED ABOVE, CUSTOMER'S SOLE REMEDY FOR BREACH OF THAT WARRANTY SHALL BE REPAIR, REPLACEMENT, OR REFUND OF THE PURCHASE PRICE PAID, AT 3COM'S OPTION. TO THE FULL EXTENT ALLOWED BY LAW, THE FOREGOING WARRANTIES AND REMEDIES ARE EXCLUSIVE AND ARE IN LIEU OF ALL OTHER WARRANTIES, TERMS, OR CONDITIONS, EXPRESS OR IMPLIED, EITHER IN FACT OR BY OPERATION OF LAW, STATUTORY OR OTHERWISE, INCLUDING WARRANTIES, TERMS, OR CONDITIONS OF MERCHANTABILITY, FITNESS FOR A PARTICULAR PURPOSE, SATISFACTORY QUALITY, CORRESPONDENCE WITH DESCRIPTION, AND NON-INFRINGEMENT, ALL OF WHICH ARE EXPRESSLY DISCLAIMED. 3COM NEITHER ASSUMES NOR AUTHORIZES ANY OTHER PERSON TO ASSUME FOR IT ANY OTHER LIABILITY IN CONNECTION WITH THE SALE, INSTALLATION, MAINTENANCE OR USE OF ITS PRODUCTS.

3COM SHALL NOT BE LIABLE UNDER THIS WARRANTY IF ITS TESTING AND EXAMINATION DISCLOSE THAT THE ALLEGED DEFECT OR MALFUNCTION IN THE PRODUCT DOES NOT EXIST OR WAS CAUSED BY CUSTOMER'S OR ANY THIRD PERSON'S MISUSE, NEGLIGENCE, IMPROPER INSTALLATION OR TESTING, UNAUTHORIZED ATTEMPTS TO OPEN, REPAIR OR MODIFY THE PRODUCT, OR ANY OTHER CAUSE BEYOND THE RANGE OF THE INTENDED USE, OR BY ACCIDENT, FIRE, LIGHTNING, OTHER HAZARDS, OR ACTS OF GOD.

LIMITATION OF LIABILITY

TO THE FULL EXTENT ALLOWED BY LAW, 3COM ALSO EXCLUDES FOR ITSELF AND ITS SUPPLIERS ANY LIABILITY, WHETHER BASED IN CONTRACT OR TORT (INCLUDING NEGLIGENCE), FOR INCIDENTAL, CONSEQUENTIAL, INDIRECT, SPECIAL, OR PUNITIVE DAMAGES OF ANY KIND, OR FOR LOSS OF REVENUE OR PROFITS, LOSS OF BUSINESS, LOSS OF INFORMATION OR DATA, OR OTHER FINANCIAL LOSS ARISING OUT OF OR IN CONNECTION WITH THE SALE, INSTALLATION, MAINTENANCE, USE, PERFORMANCE, FAILURE, OR INTERRUPTION OF ITS PRODUCTS, EVEN IF 3COM OR ITS AUTHORIZED RESELLER HAS BEEN ADVISED OF THE POSSIBILITY OF SUCH DAMAGES, AND LIMITS ITS LIABILITY TO REPAIR, REPLACEMENT, OR REFUND OF THE PURCHASE PRICE PAID, AT 3COM'S OPTION. THIS DISCLAIMER OF LIABILITY FOR DAMAGES WILL NOT BE AFFECTED IF ANY REMEDY PROVIDED HEREIN SHALL FAIL OF ITS ESSENTIAL PURPOSE.

DISCLAIMER

Some countries, states, or provinces do not allow the exclusion or limitation of implied warranties or the limitation of incidental or consequential damages for certain products supplied to consumers, or the limitation of liability for personal injury, so the above limitations and exclusions may be limited in their application to you. When the implied warranties are not allowed to be excluded in their entirety, they will be limited to the duration of the applicable written warranty. This warranty gives you specific legal rights which may vary depending on local law.

GOVERNING LAW

This Limited Warranty shall be governed by the laws of the State of California, U.S.A. excluding its conflicts of laws principles and excluding the United Nations Convention on Contracts for the International Sale of Goods.

3Com Corporation
5400 Bayfront Plaza
Santa Clara, CA 95054
(408) 326-5000

EMC STATEMENTS

FCC STATEMENT

This equipment has been tested and found to comply with the limits for a Class A digital device, pursuant to part 15 of the FCC rules. These limits are designed to provide reasonable protection against harmful interference when the equipment is operated in a commercial environment. This equipment generates, uses and can radiate radio frequency energy and, if not installed and used in accordance with the instructions, may cause harmful interference to radio communications. Operation of this equipment in a residential area is likely to cause harmful interference to radio communications, in which case the user will be required to correct the interference at their own expense.

CSA STATEMENT

This Class A digital apparatus meets all requirements of the Canadian Interference-Causing Equipment Regulations.

Cet appareil numérique de la classe A respecte toutes les exigences du Règlement sur le matériel brouilleur du Canada.

VCCI STATEMENT

この装置は、情報処理装置等電波障害自主規制協議会（VCCI）の基準に基づくクラスB情報技術装置です。この装置は、家庭環境で使用することを目的としていますが、この装置がラジオやテレビジョン受信機に近接して使用されると、受信障害を引き起こすことがあります。

取扱説明書に従って正しい取り扱いをして下さい。

BCIQ STATEMENT

警告使用者：這是甲類的資訊產品，在居住的環境中使用時，可能會造成射頻干擾，在這種情況下，使用者會被要求採取某些適當的對策。

INFORMATION TO THE USER

If this equipment does cause interference to radio or television reception, which can be determined by turning the equipment off and on, the user is encouraged to try to correct the interference by one or more of the following measures:

- Reorient the receiving antenna.
- Relocate the equipment with respect to the receiver.
- Move the equipment away from the receiver.
- Plug the equipment into a different outlet so that equipment and receiver are on different branch circuits.

If necessary, the user should consult the dealer or an experienced radio/television technician for additional suggestions. The user may find the following booklet prepared by the Federal Communications Commission helpful:

How to Identify and Resolve Radio-TV Interference Problems

This booklet is available from the U.S. Government Printing Office, Washington, DC 20402, Stock No. 004-000-00345-4.

In order to meet FCC emissions limits, this equipment must be used only with cables which comply with IEEE 802.3.

Free Manuals Download Website

<http://myh66.com>

<http://usermanuals.us>

<http://www.somanuals.com>

<http://www.4manuals.cc>

<http://www.manual-lib.com>

<http://www.404manual.com>

<http://www.luxmanual.com>

<http://aubethermostatmanual.com>

Golf course search by state

<http://golfingnear.com>

Email search by domain

<http://emailbydomain.com>

Auto manuals search

<http://auto.somanuals.com>

TV manuals search

<http://tv.somanuals.com>