

# 3M Ranger™ Irrigation Fluid Warming System Model 247 Operator's Manual

- Ⓒ GB Irrigation fluid warming system  
Operator's manual
- Ⓒ FR Manuel de l'utilisateur du système de  
réchauffement pour liquide d'irrigation
- Ⓒ DE Spülflüssigkeitserwärmungssystem  
Benutzerhandbuch
- Ⓒ IT Manuale per l'operatore del sistema di  
riscaldamento dei fluidi di irrigazione
- Ⓒ ES Sistema de calentamiento  
de fluidos de irrigación  
Manual del operador
- Ⓒ NL Gebruikershandleiding verwarmingssysteem  
voor irrigatievloeistoffen
- Ⓒ SE Användarhandbok för  
spolvätskeuppvärmningssystem
- Ⓒ DK Varmesystem til udskylningsvæske  
Brugervejledning
- Ⓒ NO Oppvarmingssystem for irrigasjonsvæske  
brukerveiledning
- Ⓒ FI Huuhtelunesteen lämmitysjärjestelmä  
Käyttöopas
- Ⓒ PT Manual do utilizador do Sistema de  
aquecimento de fluidos de irrigação
- Ⓒ GR Εγχειρίδιο χρήσης συστήματος θέρμανσης υγρών  
καταιόνησης
- Ⓒ PL Instrukcja obsługi systemu do podgrzewania  
płynów stosowanych przy irygacji
- Ⓒ HU Irrigációs folyadék-melegítő rendszer  
Kezelői kézikönyv
- Ⓒ CZ Ohřivací systém pro irigační tekutiny –  
Návod k obsluze
- Ⓒ LT Irigacinio skysčio šildymo sistema  
Operatoriaus vadovas
- Ⓒ RU Руководство по эксплуатации системы для  
подогрева промывочной жидкости
- Ⓒ TR İrigasyon sıvısı ısıtma sistemi  
Kullanım kılavuzu
- Ⓒ JP イリゲーション液加温システム取扱説明書
- Ⓒ CN 灌注液体升温系统操作指南
- Ⓒ AE دليل مستخدم نظام تدفئة سائل الري الجوال



**Ranger™**

Irrigation Fluid Warming System



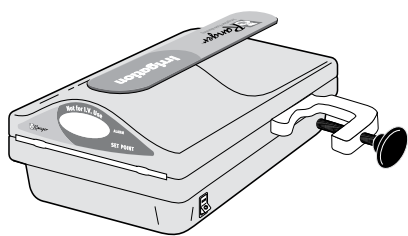

# **3M**

## **Ranger™ Irrigation Fluid Warming System**

### **Model 247**

#### **Operator's Manual**

<b>English</b>	<b>1</b>
<b>Français</b>	<b>15</b>
<b>Deutsch</b>	<b>33</b>
<b>Italiano</b>	<b>49</b>
<b>Español</b>	<b>65</b>
<b>Nederland</b>	<b>81</b>
<b>Svenska</b>	<b>97</b>
<b>Dansk</b>	<b>113</b>
<b>Norsk</b>	<b>129</b>
<b>Suomi</b>	<b>145</b>
<b>Português</b>	<b>161</b>
<b>Ελληνικά</b>	<b>177</b>
<b>Polski</b>	<b>195</b>
<b>Magyar</b>	<b>211</b>
<b>Česky</b>	<b>227</b>
<b>Lietuvių Kalba</b>	<b>243</b>
<b>Русский</b>	<b>259</b>
<b>Türkçe</b>	<b>275</b>
<b>日本語</b>	<b>291</b>
<b>英語</b>	<b>307</b>
<b>اللغة العربية</b>	<b>323</b>



# Table of Contents

- Technical Service and Order Placement .....3**
  - In-warranty Repair and Exchange.....3
  - When You Call for Technical Support .....3
  
- Introduction .....4**
  
- Indications for Use.....4**
  
- Definition of Symbols.....4**
  
- Explanation of Signal Word Consequences .....5**
  
- Warning:.....6**
  
- Caution: .....6**
  
- Notice: .....6**
  
- Product Description .....7**
  - Ranger Irrigation Fluid Warming Unit .....7
  - Ranger Irrigation Fluid Warming Disposable Set.....7
  
- Model 247 Product Safety Features.....8**
  
- Instructions For Use .....9**
  - Preparation and Setup of the Ranger Irrigation Fluid Warming Unit .....9
  - Removing the Irrigation Fluid Warming Set from the Ranger Irrigation Fluid Warming Unit.....9
  
- Troubleshooting .....10**
  
- Maintenance and Storage .....12**
  
- Specifications .....14**



## Technical Service and Order Placement

### Technical Service

#### USA

TEL: +1-952-947-1200  
+1-800-733-7775

FAX: +1-952-947-1400

#### Outside of the USA

Contact your local 3M Patient Warming representative.

### In-warranty Repair and Exchange

To return a device to 3M Patient Warming for service, first obtain a Return Authorization (RA) number from a customer service representative. Please use the (RA) number on all correspondence when returning a device for service. A shipping carton will be delivered to you at no charge, if needed. We will service and ship your device within five (5) working days of our receipt. Call your local supplier or sales representative to inquire about a loaner device while your device is being serviced.

### When You Call for Technical Support

Remember, we will need to know the serial number of your unit when you call us. The serial number label is located on the bottom of the warming unit.

## Introduction

The 3M™ Ranger™ irrigation fluid warming system is designed to warm irrigation fluids and deliver these at flow rates under gravity up to 867 mL/min when the bag is hung 100 cm above the scope. At these flow rates, the device maintains fluid output temperatures ranging from 33°C to 41°C (Note: This is for room temperature fluids only). It takes less than 2 minutes to warm up to the 41°C set point temperature. The alert points on the Model 247 are 48°C and 50°C.

The fluid warming disposable set is sterile, latex-free, single-use-only and is designed to be used with the reusable Model 247 warming unit. For additional information on Ranger disposable sets visit us online at [rangerfluidwarming.com](http://rangerfluidwarming.com). This manual includes operating instructions and unit specifications for the Model 247 irrigation fluid warming system. For information about using Ranger irrigation fluid warming disposable sets with the Model 247 irrigation fluid warming unit, refer to the “Instructions for Use” included with each disposable component. The Ranger irrigation fluid warming system should only be used in healthcare facilities by trained medical professionals.

## Indications for Use

The Ranger irrigation fluid warming system is intended to warm irrigation fluids.

## Definition of Symbols



ON



OFF



Fuse



CAUTION



Type B Applied Part



Voltage, Alternating Current (AC)















An equipotentiality plug (grounded) conductor other than a protective earth conductor or a neutral conductor, providing a direct connection between electrical equipment and the potential equalization busbar of the electrical installation. Please consult IEC 6060-1; 2005 for requirements.

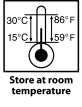

This system is subject to European WEEE Directive 2002/96/EC.

This product contains electrical and electronic components and must not be disposed of using standard refuse collection. Please consult local directives for disposal of electrical and electronic equipment.

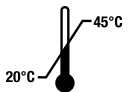

	Protective earth ground
	Consult instructions for use
	Follow instructions for use
	Recycle to avoid environmental contamination. This product contains recyclable parts. For information on recycling - please contact your nearest 3M Service Center for advice.
	Date of manufacture
	Manufacturer
	Sterile, ethylene oxide
	Store at room temperature
	DEHP-free
	Quantity
	Single use
	Latex free
	Keep dry
	Temperature limits

## Explanation of Signal Word Consequences



**WARNING:**

Indicates a hazardous situation which, if not avoided, could result in death or serious injury.



**CAUTION:**

Indicates a hazardous situation which, if not avoided, could result in minor or moderate injury.

**NOTICE:**

Indicates a situation which, if not avoided, could result in property damage only.

**WARNING:**

1. To reduce the risks associated with hazardous voltage and fire and thermal energy hazards:
  - Do not substitute other devices (i.e. Model 245) for the Ranger irrigation fluid warming unit or Ranger irrigation disposable sets.
  - Do not continue use of the unit if the over-temperature alert continues to sound and the temperature does not return to the set point temperature. Immediately stop fluid flow and discard the disposable set. Have the warming unit tested by a biomedical technician or call 3M Patient Warming technical service.
2. To reduce the risks associated with hazardous voltage and fire:
  - Do not modify or service this device, and do not open the warming unit case- there are no user-serviceable parts in the Ranger warming unit.
  - Connect power cord to receptacles marked “Hospital Only,” “Hospital Grade,” or a reliably grounded outlet.
  - Use only the power cord specified for this product and certified for the country of use.
  - Do not allow the power cord to get wet.
  - Do not use the Ranger warming system when it appears the warming unit, power cord, or disposable is damaged. Use only 3M specified replacement parts.
  - Keep power cord visible and accessible at all times. The plug on the power cord serves as the disconnect device. The wall socket outlet shall be as close as practical and shall be easily accessible.
3. To reduce the risks associated with air embolism:
  - Never use fluids if air bubbles are present in the fluid line.

**CAUTION:**

1. Not for I.V. use.
2. To reduce the risks associated with cross-contamination:
  - The cleaning tool provides only superficial cleaning, it does not disinfect or sterilize the interior of the unit.
3. To reduce the risks associated with impact and facility medical device damage:
  - Clamp the Ranger irrigation fluid warming unit to an I.V. pole with a minimum 14” (35.6 cm) radius wheelbase and at a height no higher than 44” (112 cm).
4. To reduce the risks associated with environmental contamination:
  - Follow applicable regulations when disposing of this device or any of its electronic components.

**NOTICE:**

1. Federal law (USA) restricts this device to sale by or on the order of a licensed healthcare professional.
2. To avoid device damage:
  - Do not clean the warming unit with solvents. Damage to the case, label, and internal components may result.
  - Do not immerse the warming unit in cleaning or sterilizing solutions. The unit is not liquid proof.
  - Do not insert metallic instruments in the warming unit.
  - Do not use abrasive materials or solutions to clean the heater plates.
  - Do not allow spills to dry inside the unit, as this may make it more difficult to clean the unit.
3. The Ranger irrigation fluid warming unit meets medical electronic interference requirements. If radio frequency interference with other equipment should occur, connect the unit to a different power source.

## Product Description

The Ranger irrigation fluid warming system consists of a Model 247 warming unit and a sterile disposable fluid warming set.

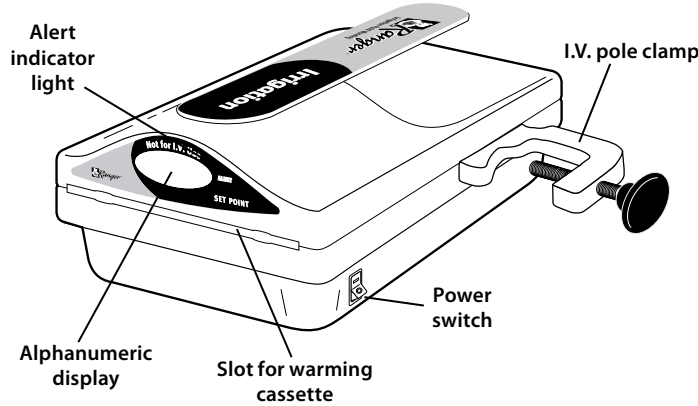

### Ranger Irrigation Fluid Warming Unit

The warming unit is a compact, lightweight, liquid-resistant device with a clamp located on the side for attachment to an I.V. pole. When mounted to the I.V. pole, the unit fits easily above the 3M™ Bair Hugger™ 500 or 700 series warming unit. A carrying handle on the top of the unit makes it easy to transport.

Located on the front panel you will find:

- Alphanumeric display that indicates the heater temperature during normal operation. In an over temperature condition, the display alternately flashes a temperature of 48°C or higher and the word “HI.” An audible alert also sounds. In an under-temperature condition, the display alternately flashes a temperature of 33°C or lower and the word “LO.”
- Alert indicator light that comes on when either an over- or under-temperature condition occurs.

### Ranger Irrigation Fluid Warming Disposable Set

Irrigation fluid warming sets<sup>1</sup> include a cassette, tubing, connectors, flow chamber and clamps.

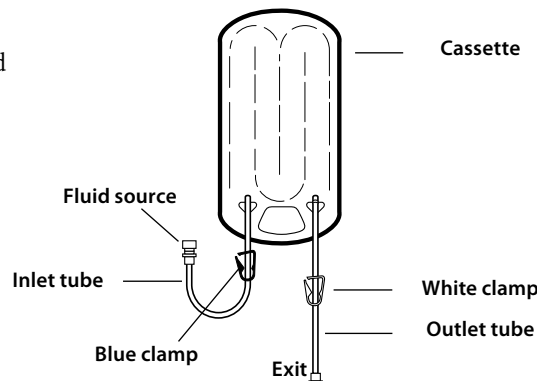

	Flow Rate	Priming Volume	Patient Line Length
Irrigation set	0-867 mL/min <sup>2</sup>	308 mL	213 cm

1. Refer to the instructions provided with each disposable set for information on use.
2. With the bag hung 100 cm above the scope under gravity flow.

## Model 247 Product Safety Features

The following chart describes the safety alarm features of the Ranger irrigation fluid warming unit.

Alert Type	Set-Point	Indication	Description
Primary over-temperature alert system	48°C	LED alternately displays “HI” and temperature, alert sounds, alert light flashes.	Primary Alert: Alert sounds, controller cuts power to the heaters until temperature falls below 48°C. When heater temperature drops below 48°C, audible and visual alerts stop.
Independent back-up over-temperature alert system (cut-off).	50°C	LED displays the temperature or has gone dark, alert sounds.	Primary failure. Temperature will rise to 50°C within a few seconds. The safety backup system is activated at 50°C and power is immediately shut off to the heating plates.
Under-temperature alert	33°C	LED displays “LO” and temperature, alert sounds, alert light flashes.	Heater temperature has fallen to 33°C. Alerts will stop when temperature rises above 33°C. Continue use of unit.

### NOTE:

The difference in over-temperature alert system cut-off points does not indicate any difference in safety and is simply a result of tighter controller tolerances.

The Ranger irrigation fluid warming system is designed with very tight controls to regulate its temperature to the 41°C set-point. The microprocessor controller measures the temperature at the fluid pathway inside the warming plate four times every second, making it very responsive to changes in flow rate.

## Instructions For Use

### Preparation and Setup of the Ranger Irrigation Fluid Warming Unit

1. Attach the Ranger irrigation fluid warming unit to the I.V. pole. Tighten the pole clamp securely.

#### CAUTION:

To prevent tipping, clamp the Ranger irrigation fluid warming unit to an I.V. pole with a minimum 14" (35.6 cm) radius wheelbase and at a height no higher than 44" (112 cm). Failure to do so may result in damage to the product (see Figure 1).

2. Slide the irrigation cassette into the slot in the warming unit. The cassette can only fit into the device one way (see Figure 2).
3. Prime the warming set. For more information about priming the set, refer to instructions provided with the warming sets.
4. Plug the power cord into an appropriate outlet. Turn the unit ON. In a few seconds the alpha-numeric display will illuminate. It takes less than 2 minutes to warm up to the 41°C set point temperature.
5. Begin flow. When flow is completed, remove the warming set and discard according to institutional protocol.

### Removing the Irrigation Fluid Warming Set from the Ranger Irrigation Fluid Warming Unit

1. Close the inlet clamp proximal to the fluid warming cassette and open all clamps distal to the cassette.
2. Disconnect the warming set from the fluid source, if applicable.
3. Allow a small amount of fluid to drain from the end of the patient line to reduce pressure in the cassette.
4. Remove the warming set from the warming unit and discard according to institutional protocol.

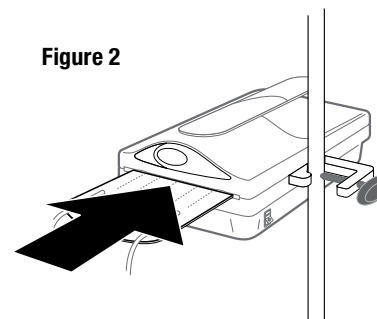
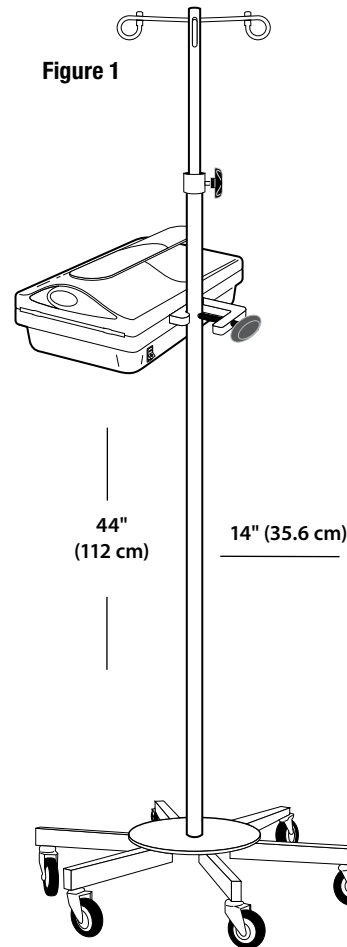

## Troubleshooting

Condition	Cause	Solution
Nothing illuminates on the warming unit panel.	<ul style="list-style-type: none"> <li>Unit is not turned on, plugged in, or power cord is not plugged into an appropriate outlet.</li> <li>Unit failure.</li> </ul>	<ul style="list-style-type: none"> <li>Turn unit on. Make sure the power cord is plugged into the power entry module of the warming unit. Make sure the warming unit is plugged into a properly grounded outlet.</li> <li>Call 3M Patient Warming technical support.</li> </ul>

Condition	Cause	Solution
Alert indicator illuminates and alert sounds, alpha-numeric display alternately flashes a temperature of 48°C or higher and the word "HI."	<p>Temporary over-temperature condition because:</p> <ul style="list-style-type: none"> <li>An extreme change in flow rates occurred (e.g., from 500 ml/min to stop flow).</li> <li>Unit was turned on and reached set point temperature before warming cassette was inserted.</li> <li>Fluids were prewarmed to above 42°C before being run through the warming unit.</li> </ul>	<ul style="list-style-type: none"> <li>Open flow to reduce temperature. Alerts will stop when the temperature drops below 48°C. The unit is ready to use.</li> <li>Alerts will stop when the temperature drops below 48°C. The unit is ready to use.</li> <li>Turn off unit and unplug it. Discontinue infusion of fluids. Do not warm fluids before infusing them through the Ranger irrigation fluid warming unit.</li> </ul>

Condition	Cause	Solution
Alert sounds, alpha-numeric display and alert indicator light go dark.	Primary controller failure. Unit will no longer operate.	Power to heating plates will shut off if temperature rises to 50°C. Turn unit off and unplug it. Discontinue use of unit. Discard disposable set. Alert will continue to sound if you do not unplug unit. Call 3M Patient Warming technical support.

Condition	Cause	Solution
Unit alerts soon after plugging it in (unit does not have to be turned on for this condition to occur). Heater temperature rises to 50°C and unit shuts down soon after plugging it in (unit does not have to be turned on for this condition to occur).	Test screw on bottom of unit is loose or missing.	Make sure test screw is completely tightened. If it is missing, turn unit off and unplug it. Call 3M Patient Warming technical support.

Condition	Cause	Solution
Alert sounds but warming unit has been turned off.	Independent backup safety system has been activated.	Unplug unit. Call 3M Patient Warming technical support.

Condition	Cause	Solution
Cannot remove cassette from unit.	<ul style="list-style-type: none"> <li>Cassette is too full, fluids are still being infused, or clamp is open proximal to the warming cassette.</li> <li>Warming unit is below patient level, creating excessive back pressure.</li> </ul>	<ul style="list-style-type: none"> <li>Make sure fluid is drained from warming cassette before sliding out the cassette, that fluids are no longer infusing, and that clamp is closed proximal to the warming cassette.</li> <li>Raise unit above patient level.</li> </ul>

Condition	Cause	Solution
Alerts indicator light illuminates and alert sounds, alpha-numeric display alternately flashes a temperature of 33°C or below and the word "LO."	Under temperature condition caused by very high flow using very cold fluid, or defective heater/relay.	Alerts should stop when temperature rises above 33°C. If alerts continue, turn off unit, unplug unit, and discontinue use. Call 3M Patient Warming technical support.

Condition	Cause	Solution
Alpha-numeric display reads "Er 4" or "Open."	Open wire on temperature sensor.	Do not use unit. Call 3M Patient Warming technical support.

Condition	Cause	Solution
Alpha-numeric display reads "Er 5" or "Open."	Electrical interference.	Remove the unit. Refer to biomedical technician or call 3M Patient Warming technical support.

## Maintenance and Storage

### Cleaning the Ranger Irrigation Fluid Warming Unit

Clean the Ranger irrigation fluid warming unit on an as-needed basis.



#### CAUTION

1. To reduce the risks associated with cross-contamination:
  - The cleaning tool provides only superficial cleaning, it does not disinfect or sterilize the interior of the unit.

#### NOTICE

1. To avoid device damage:
  - Do not immerse the warming unit in cleaning or sterilizing solutions. The unit is not liquid proof.
  - Do not clean the warming unit with solvents. Damage to the case, label, and internal components may result.
  - Do not insert metallic instruments in the warming unit.
  - Do not use abrasive materials or solutions to clean the heater plates.
  - Do not allow spills to dry inside the unit, as this may make it more difficult to clean the unit.

#### TO CLEAN THE EXTERIOR OF THE WARMING UNIT:

1. Disconnect the Ranger irrigation fluid warming unit from the power source.
2. Wipe the outside of the unit with warm, soapy water, nonabrasive cleaning solutions, dilute bleach, or cold sterilants. Do not use abrasive materials.
3. Wipe with a dry, soft cloth.

#### TO CLEAN THE HEATING PLATES:

The Ranger hardware cleaning tool, is intended to clean both heating plates of the warming unit. It is not necessary to disassemble the warming unit to use the tool.



**METHOD**

1. Unplug the irrigation fluid warming unit.
2. Unfold the cleaning tool. Wet the foam pads with a nonabrasive solution, such as Alconox™ brand detergent.
3. Insert the tool from the back of the unit and pull the tool all the way out from the front.
4. Rinse the tool with water and repeat 3 times. Discard the tool according to institutional protocol.
5. Wipe off the unit to remove excess fluid.

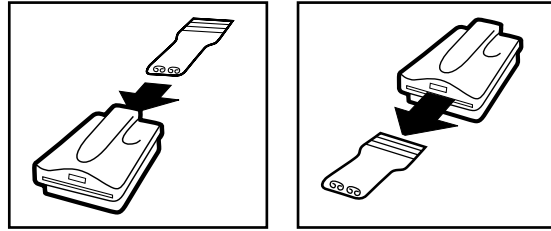
**TO CLEAN RESISTANT, DRIED-ON FLUIDS:**

1. Spray a nonabrasive solution inside the slot of the warming unit and let sit for 15-20 minutes.
2. Clean the unit by using the cleaning tool.

**NOTE:** You may use a nonmetal instrument, such as a cotton swab, to clean the upper channels. If you are unable to adequately clean the unit, call 3M Patient Warming technical service.

**Storage**

Store all components in a cool, dry place when not in use.

**Servicing**

There are no user-serviceable parts in the Ranger irrigation fluid warming unit. All service must be performed by 3M Patient Warming or an authorized service technician.

**Call 3M Patient Warming technical service at 800-733-7775 or 952-947-1200 for service information.**

Alconox is a trademark of Alconox, Inc.

## Specifications

### Physical Characteristics

#### WARMING UNIT

4.5 in. (11 cm) high x 7.5 in. (19 cm) wide x 10 in. (25 cm) long;

wt.: 7 lb. 7 oz. (3.4 kg)

#### CERTIFICATIONS

IEC/EN 60601-1; CAN/CSA-C22.2, No.601.1

#### CLASSIFICATION

**MEDICAL — GENERAL MEDICAL EQUIPMENT AS TO ELECTRICAL SHOCK, FIRE AND MECHANICAL HAZARDS ONLY IN ACCORDANCE WITH UL 60601-1; CAN/CSA-C22.2, No.601.1; ANSI/AAMI ES60601-1:2005 CSA-C22.2 No. 60601-1:08; Control No.4HZ8**

Classified under IEC 60601-1 Guidelines (and other national versions of the Guidelines) as Class I, Type B, Ordinary equipment, Continuous operation. Classified by Underwriters Laboratories Inc. with respect to electric shock, fire and mechanical hazards only, in accordance with IEC/EN 60601-1 and in accordance with Canadian/CSA C22.2, No. 601.1. Classified under the Medical Device Directive as a Class IIb device.



### Electrical characteristics

#### INPUT VOLTAGE

100-120 or 220-240 VAC

#### OPERATING FREQUENCY

100-120 VAC, 50/60 Hz  
220-240 VAC, 50/60 Hz

#### MAXIMUM HEATING POWER

900 W

#### FUSE

2 x T10A-H (250V) for 100-120 VAC  
2 x T6.3A-H (250V) for 220-240 VAC

#### FUSE TYPE

Time delay, high breaking

### Leakage Current

Meets leakage current requirements in accordance with UL/IEC 60601-1.

### Environmental Conditions

#### OPERATING TEMPERATURE RANGE

15° to 40°C (59° to 104°F)

#### STORAGE TEMPERATURE RANGE

-20° to 45°C (-4° to 113°F)

#### OPERATING HUMIDITY

10 to 85% RH, noncondensing

#### ATMOSPHERIC PRESSURE RANGE

50 kPa to 106 kPa

### Temperature characteristics

#### SET POINT TEMPERATURE

41°C

#### OVER-TEMPERATURE ALERT

48°C

#### UNDER-TEMPERATURE ALERT

33°C

#### OVER-TEMPERATURE CUTOFF

50°C



3M is a trademark of 3M Company. RANGER, BAIR HUGGER and the BAIR HUGGER logo are trademarks of Arizant Healthcare Inc., used under license in Canada. ©2013 Arizant Healthcare Inc. a 3M company. All rights reserved.



3M Deutschland GmbH, Health Care Business  
Carl-Schurz-Str. 1, 41453 Neuss, Germany



3M Health Care, 2510 Conway Ave., St. Paul, MN 55144 USA  
TEL 800-228-3957 | [www.rangerfluidwarming.com](http://www.rangerfluidwarming.com)  
202456B 08/13

## Free Manuals Download Website

<http://myh66.com>

<http://usermanuals.us>

<http://www.somanuals.com>

<http://www.4manuals.cc>

<http://www.manual-lib.com>

<http://www.404manual.com>

<http://www.luxmanual.com>

<http://aubethermostatmanual.com>

Golf course search by state

<http://golfingnear.com>

Email search by domain

<http://emailbydomain.com>

Auto manuals search

<http://auto.somanuals.com>

TV manuals search

<http://tv.somanuals.com>