

## SC & FC/PC3 Pull-Proof Fiber Optic Connectors

Termination Procedures for  
Single-mode and Multimode  
Field-Mountable Connectors  
using Epoxy

**Contents:**

A) Warnings, Recommendations and Overview ..... 3

B) Jacketed Cable Preparation ..... 5

C) Mounting ..... 8

D) Scoring ..... 12

E) Standard Polishing Process for Single-mode and Multimode Connectors (>30dB) ..... 13

F) Polishing Process for Single-mode Connector Return Loss >40dB ..... 16

G) Final Cleaning ..... 20

H) Mounting Unjacketed/900  $\mu$ m Buffered Fiber ..... 20

I) Connector Assembly and Installation ..... 22

J) 3M SC and FC/PC3 Epoxy Field Termination Kits ..... 24

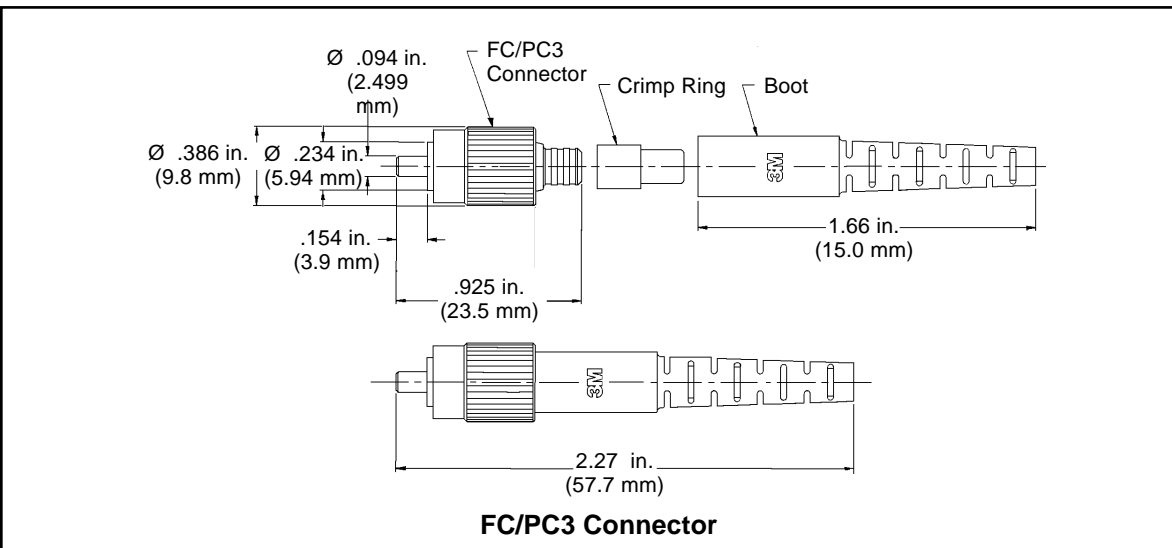
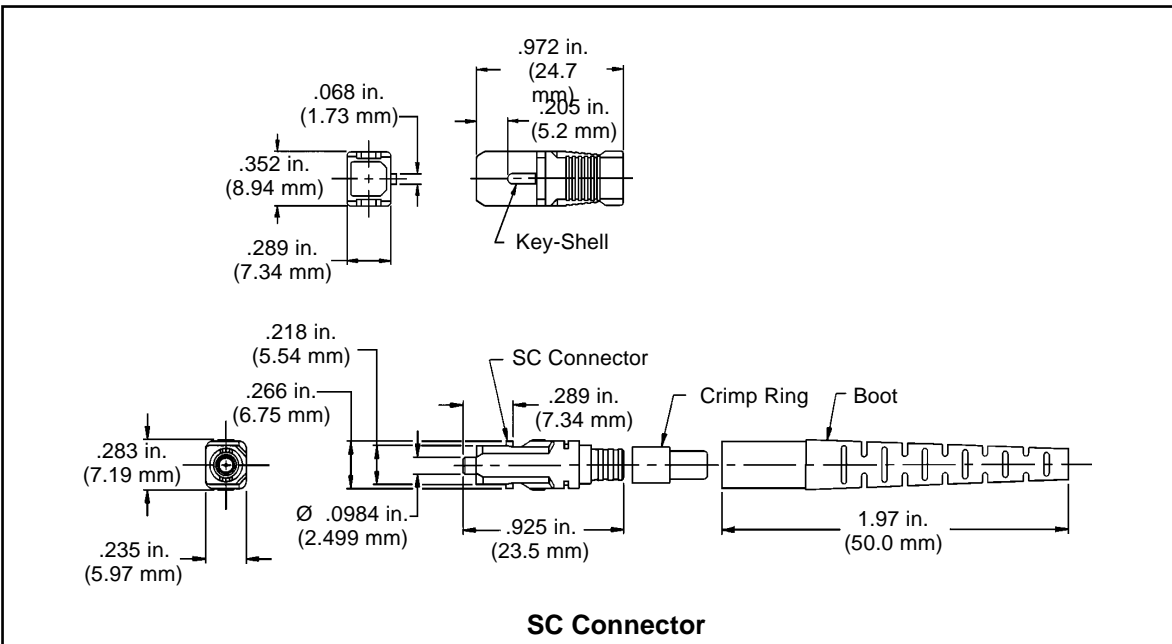

## SECTION A

### Warnings, Recommendations and Overview

1. Most fibers can be mechanically stripped without the aid of chemicals or heat. If the fiber is not mechanically strippable, contact 3M's Training Department or the cable manufacturer for their recommendations.
2. The recommended cleaning solvent for connectors and tools is isopropyl alcohol (reagent grade, 99% or better). It may be purchased from laboratory supply companies. Isopropyl alcohol may also be used to clean the lapping acetate and stripping tool when necessary. **Do not use acetone for cleaning.**
3. For safety reasons, no chemicals have been shipped with the 3M brand Field Termination Kit. We have, however, included bottles for the alcohol and water.

**Note:** *Carefully follow safety, health and disposal information on container label or Material Safety Data Sheet for isopropyl alcohol being used.*

4. Please contact the 3M Telecom Systems Training Department if you have any questions concerning chemicals or procedures.

**Warning:** *Do not view fiber ends if they are laser illuminated. Eye damage may result. Illuminate fiber ends with white light only.*

5. The connectors described in this manual have pre-radiused PC "domed" ferrule ends to ensure low attenuation and the best reflection performance. All polishing should be done **on the soft polishing pad only**, as described in this manual.
6. The 3M brand connectors with PC finishes are completely intermateable with flat finished connectors. PC to flat terminations actually provide improved performance over flat to flat terminations. PC to PC terminations as produced while using this manual, however, offer the best performance.
7. Safety glasses should be worn when working with optical fibers.
8. Appropriate containers of clean, dry, compressed air may be obtained from photographic supply stores. Do not use types that leave a residue.

## SECTION A

### Warnings, Recommendations and Overview

This manual is for terminating the following field mountable connectors:

		<b>Identification</b>		
<u>SC Single-mode</u>	<u>Product Number</u>	<u>Housing (Color)</u>	<u>Ferrule Collar</u>	<u>Strain Relief Boot</u>
125 $\varnothing$ m	8305	Blue	Black	White
126 $\varnothing$ m	8306	Blue	Yellow	White
127 $\varnothing$ m	8307	Blue	Silver	White
<u>SC Multimode</u>				
125 $\varnothing$ m	6306	Beige	Black	Beige
<u>FC Single-mode</u>				
125 $\varnothing$ m	8202	Gray	Black	White
126 $\varnothing$ m	8203	Gray	Yellow	White
127 $\varnothing$ m	8204	Gray	Silver	White
<u>FC Multimode</u>				
125 $\varnothing$ m	6202	Beige	Black	Beige
<u>Field Termination Kits</u>				
Field Termination Kit for SC & FC/PC3 Connectors (110V)			8350	
Field Termination Kit for SC & FC/PC3 Connectors (220V)			8351	
(See section J for kit listing)				

**SC Connector**

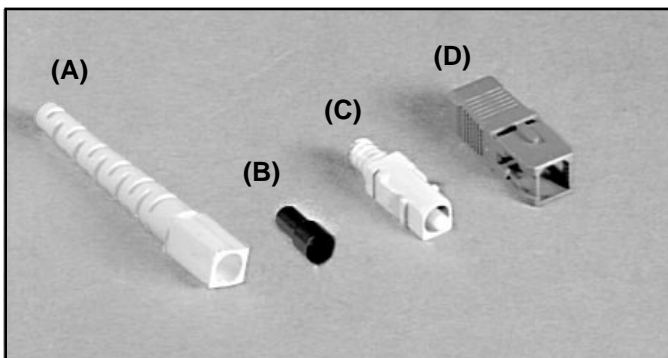

**FC/PC3 Connector**

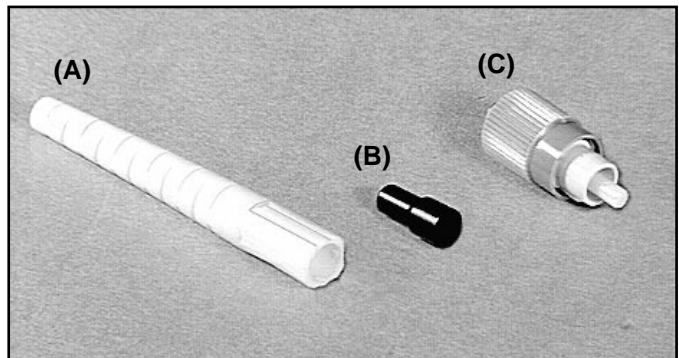

- (A) - Strain Relief Boot
- (B) - Crimp Ring
- (C) - Connector
- (D) - Housing

## SECTION B

### Jacketed Cable Preparation

This section is for mounting the 3M brand SC and FC/PC3 field-mountable connectors on 2.4 mm cable and 3.0 mm cable.

The process for mounting on 900  $\mu$ m buffered fiber can be found in Section H.

#### 1. TURN THE OVEN ON

When the oven is heated to the proper temperature the heater light will go off.

#### 2. ASSEMBLE THE CURING STAND ACCORDING TO FIGURE B11

#### 3. PREPARE CONTAINERS AS LABELED

- a. Fill one bottle with isopropyl alcohol (reagent grade).
- b. Fill one bottle with water.

**Note:** *Carefully follow safety, health and disposal information on container label or Material Safety Data sheet for isopropyl alcohol being used.*

#### 4. PREPARE THE CRIMP TOOL

Included in the field termination kit is a crimp tool set. The package includes a base tool and three die sets to be used as follows:

<u>Die Marking</u>	<u>Cavity Marking</u>	<u>Application</u>
BIC/ST	.151	ST* Bayonet, FC-1 & Biconic
	.213	TECS 200/230 connector
	.178	Not used
SC / FC3	.120	2.4 mm Jacketed Cable
	.137	3.0 mm Jacketed Cable
	.190	Kevlar crimp
PPST (Push-Pull ST)	.120	2.4 mm Jacketed Cable
	.137	3.0 mm Jacketed Cable
	.226	Kevlar crimp

Select the jaw labeled "SC/FC3." Secure the jaws loosely with the thumb screws. Close the jaws to the fully closed position allowing the jaws to align, then tighten the screws (Fig. B1).

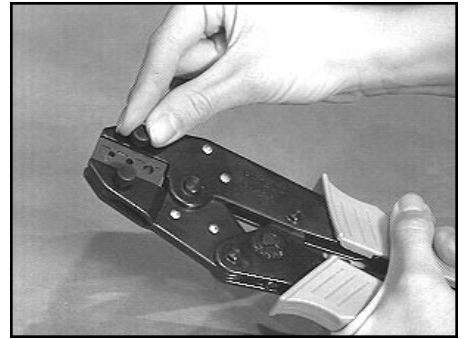

Fig. B1

## SECTION B

### Jacketed Cable Preparation

5. SLIP THE STRAIN RELIEF BOOT AND THE CORRECT CRIMP RING ONTO THE CABLE

**DO NOT FORGET TO DO THIS STEP.** The boot will not fit over a mounted connector assembly so it is essential that it be slipped onto the cable at this time. Slip the smaller diameter of the boot onto the cable first.

Red crimp rings for 2.4 mm cable and black crimp rings for 3.0 mm cable are provided with each connector. Slide the appropriate crimp ring onto the cable, small opening first (Fig. B2).

6. CUT AND REMOVE 1 3/16" (30 mm) OF THE CABLE'S OUTER JACKET

Adjust the yellow handled stripper to cut the jacket and not the Kevlar<sup>1</sup>.

Using the ruler supplied in the field kit, measure and mark the cable 1 3/16" (30 mm) from the end of the jacket. Close the yellow handled stripper on the cable until the outer jacket is cut (Fig. B3). Remove the jacket with your fingers.

7. CUT AND FLARE THE STRENGTH MEMBERS

Gather the Kevlar and pull it off to one side giving it a slight twist. Using the serrated scissors cut the Kevlar leaving about 5/16" (8 mm) sticking out of the outer jacket (Fig. B4). Slip the smaller hole of the blue stripping collar over the buffer and flare out all of the Kevlar evenly (Fig. B5). Reverse the collar and slide the larger hole over the buffer and outer jacket. Push down gently until the stripping collar folds the Kevlar back and seats.

8. HOLD THE CABLE SECURELY

Before stripping the buffer it is important to hold the cable in a configuration which will prevent the buffered fiber from being pulled out of the outer jacket.

Grasp the end of the outer jacket between your thumb and forefinger. Wind the cable between your fingers (Fig. B6). Squeezing with all fingers will clamp the buffered fiber in the outer jacket (Fig. B6).

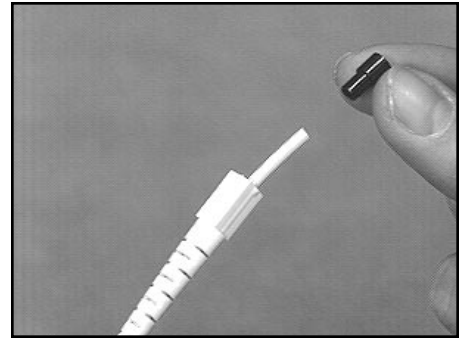

Fig. B2

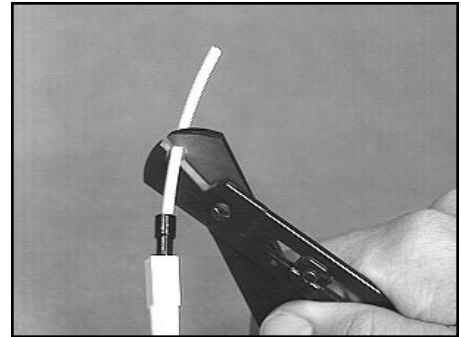

Fig. B3

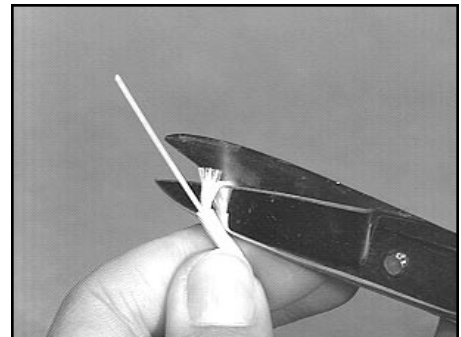

Fig. B4

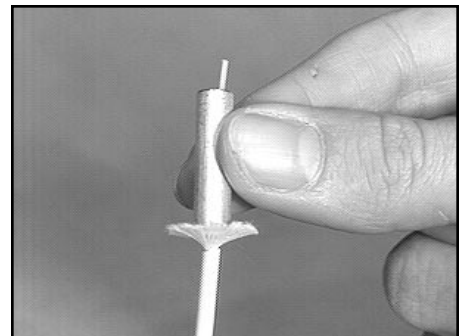

Fig. B5

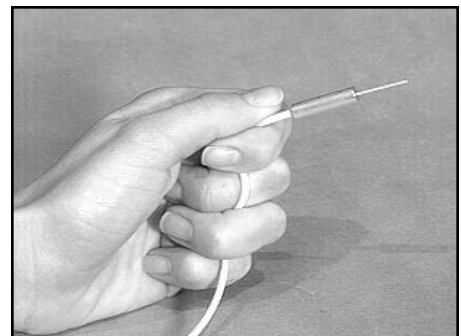

Fig. B6

## SECTION B

### Jacketed Cable Preparation

#### 9. BUFFER REMOVAL

With the modified No-Nik tool's arrow pointing in the direction of the stripping, remove the fiber's buffer in small bites, about 3/16" (5 mm).

Be sure to remove the stripped material from the tool after each incremental cut. When stripping the last increment, the end of the stripping collar should gently rest against the fiber guide inside of the clearance hole of the No-Nik (Fig. B7). This will ensure the correct

#### 10. CLEAN THE FIBER WITH ALCOHOL

With the collar still in place, moisten a lint free cloth with isopropyl alcohol from the bottle and wipe the fiber clean (Fig. B8). Make sure there is absolutely no buffer residue or dirt on the fiber by holding it to a light and inspecting for a smooth shiny surface. If necessary, wipe the fiber a second time to be sure that it is clean.

#### 11. REMOVE THE STRIPPING COLLAR

Remove the stripping collar and position the cut Kevlar so that it is evenly distributed around the buffer. At this time, verify the strip length dimensions. **It is very important that the exposed buffer measures 9/16" (14 mm) from the end of the cut jacket as shown in Fig. B9. (Figure not to scale).** Confirm all dimensions using the ruler provided (Fig. B10).

#### 12. PROTECT PREPARED FIBERS

Clip the cable in the curing stand where the fiber end will not touch anything (Fig. B11). When mounting more than one connector, prepare all fiber ends before mixing the epoxy.

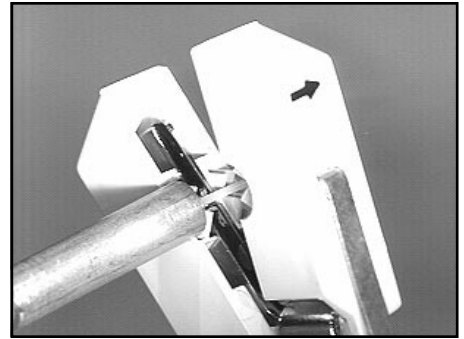

Fig. B7

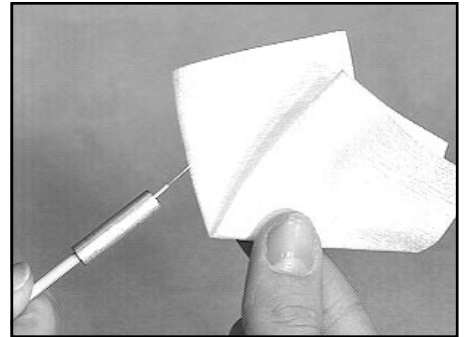

Fig. B8

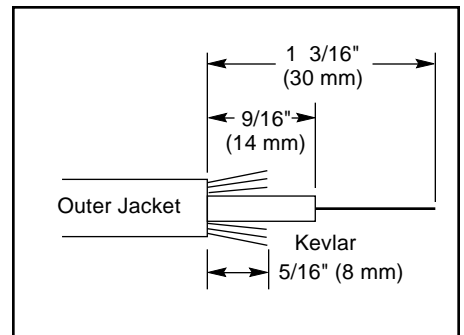

Fig. B9

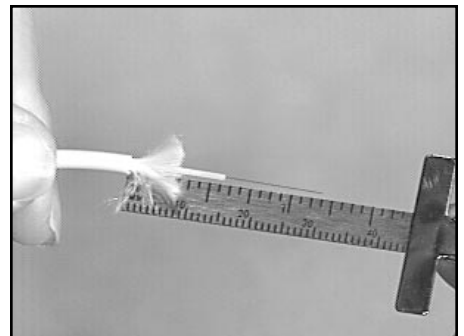

Fig. B10

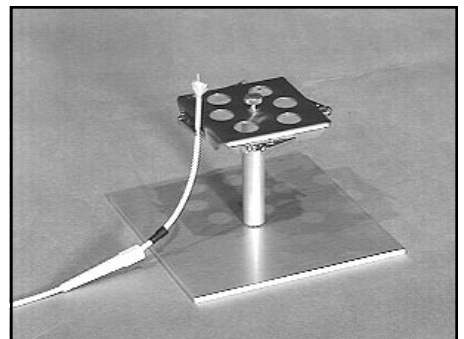

Fig. B11

## SECTION C

### Mounting

#### 1. INSPECT THE CONNECTOR

Before mounting, hold the connector up to a light to ensure that the capillary hole of the ceramic ferrule is clear. If the hole is obstructed, blow it clear with air or use a piece of stainless steel wire supplied with the kit. To clear simply insert a wire through the back end of the connector so that the wire forces any debris through the front end of the ceramic ferrule (Fig. C1).

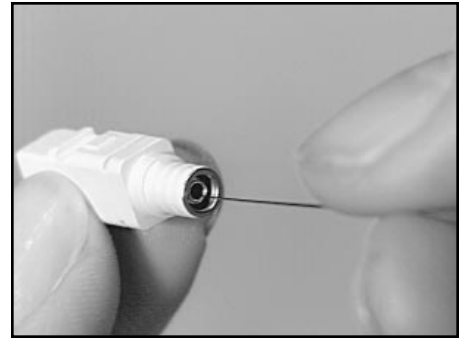

Fig. C1

#### 2. MULTIMODE CONNECTOR MOUNTING

The 125  $\mu\text{m}$  size connector will fit standard 125  $\mu\text{m}$  multimode fibers. Since dry fitting is therefore not necessary, advance to C3 in this section.

For 140  $\mu\text{m}$  size fibers contact your local 3M sales representative.

#### SINGLE-MODE CONNECTOR FITTING

In order to achieve the lowest attenuation, it is important to dry fit single-mode connectors onto individual fibers.

Single-mode connectors are available in three closely toleranced ferrules sizes for mounting on single-mode fiber. Refer to page 4 for connector identification.

Select a 125  $\mu\text{m}$  size connector. Line up the connector straight with the fiber and thread it onto the fiber while slightly rotating the connector between thumb and forefinger (Fig. C2). Do not try to force the connector onto the fiber. If the ferrule is too tight, the fiber will begin to buckle. If this is the case, carefully remove the 125  $\mu\text{m}$  size and select a 126  $\mu\text{m}$  size connector. Check to see that the ferrule hole is clear and dry fit. If the 126  $\mu\text{m}$  size is too tight then a 127  $\mu\text{m}$  connector should be used. If the connector cannot be threaded onto the fiber, re-inspect the fiber and the connector. Re-clean if necessary.

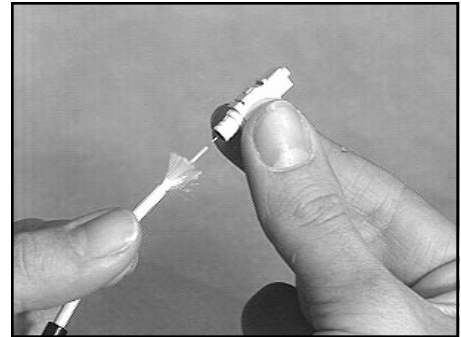

Fig. C2

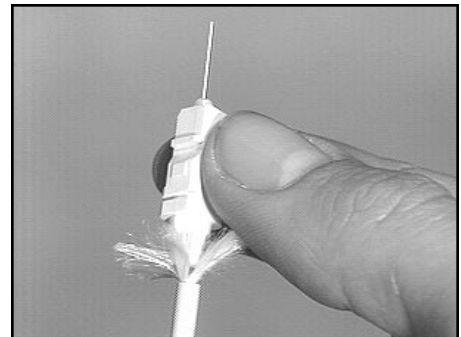

Fig. C3

**Note:** *At times when fitting connectors, a fiber particle may become lodged in the ferrule. In order to clear the ferrule it may be necessary to insert a stainless steel wire through the front of the ferrule and push the fiber out through the rear. Be sure to blow the connector clean after using the wire.*

Slide the correct size connector all the way onto the fiber until the buffer bottoms against the ferrule. At this point, there should be no more than 1/16" (2 mm) space between the end of the cable and the back end of the connector (Fig. C3). After the fit is confirmed, carefully remove the connector from the fiber and place the fiber in the curing stand.

#### 3. INSTALL THE LOAD ADAPTER ONTO THE CONNECTOR

After the connector has been fitted, insert it into the load adapter (Fig. C4) and place the connector in the stand with its matching fiber.



Fig. C4



## SECTION C

### Mounting

#### 4. PREPARE THE SYRINGE AND EPOXY

Remove the plunger and protective cap from the syringe and place both parts on a clean convenient surface along with the dispensing tip. The epoxy supplied has been specifically designed for use with fiber optic connectors and is packaged in premeasured 2 gram bi-packs.

- Working time is 45 minutes.
- Cure time is 20 minutes, in 3M epoxy oven.
- Cure time is 18 hours at room temperature of 70°F (22°C).
- Shelf life is 9 months at 25°C. (Packages are dated).  
(Refrigeration will prolong shelf life). If epoxy is stored at a higher temperature, shelf life will be shortened.
- Each bi-pack will mount up to 30 connectors per mounter.  
Bi-packs can be shared between 2 or 3 syringes, if desired.

Remove the separating bar by pulling the bi-pack ends. Mix the two components together for one full minute by massaging the package and rubbing it back and forth over the smooth edge of a table (Fig. C5). Make sure that the epoxy is thoroughly mixed and is a uniform blue color.

**Note:** Carefully follow safety, health and disposal information on epoxy label or Material Safety Data Sheet.

#### 5. LOAD THE SYRINGE WITH EPOXY

When thoroughly mixed, cut a small corner off of the package and squeeze the contents into the syringe while holding the syringe diagonally (Fig. C6).

Insert the plunger only about 3/8" (10 mm) and hold the syringe pointing straight upward. After the epoxy settles on the plunger, push in gently to expel any air through the tip of the syringe.

#### 6. ATTACH THE EPOXY DISPENSING TIP

The mint green dispensing tips included in the field termination kit are **required** for use with the 3M SC, FC3 and ST Push-Pull connectors.

Push and twist-lock the dispensing tip onto the syringe body. Depress the plunger and eject the epoxy until there are no air pockets remaining.

#### 7. INJECT EPOXY INTO THE CERAMIC FERRULE

Each time you inject a new connector, wipe the needle tip clean to be sure that it is completely free of epoxy.

Insert the syringe tip into the back end of the connector until it seats. Maintain pressure and slowly inject epoxy until a bead appears on the end of the ceramic tip (Fig. C7 and Fig. C7a). Continue to inject epoxy until the bead covers about one third of the ferrule end face. Release the pressure on the plunger and withdraw the needle straight back. **DO NOT ALLOW EPOXY TO FILL THE INSIDE OF THE CONNECTOR.**

**Note:** Unlike other mounting procedures, do not place epoxy on the fiber or in the back end of the connector.

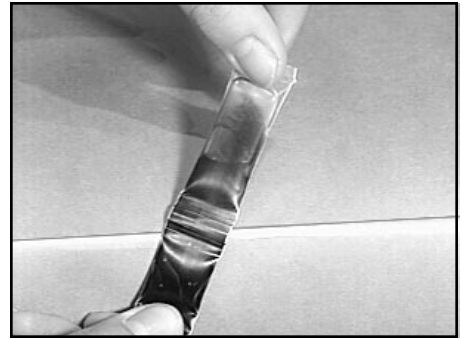

Fig. C5

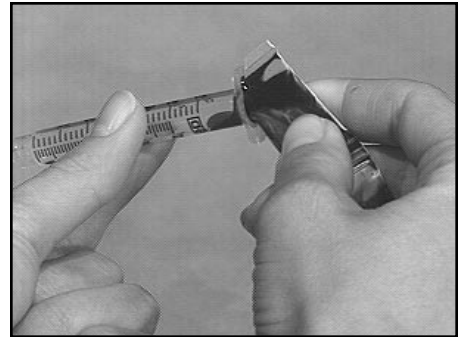

Fig. C6

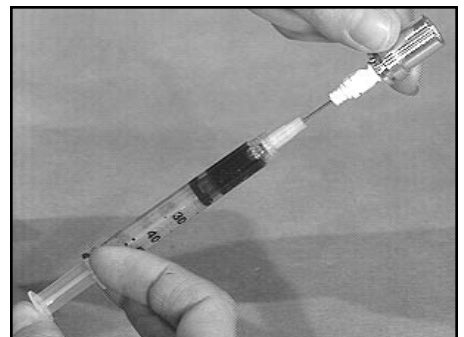

Fig. C7

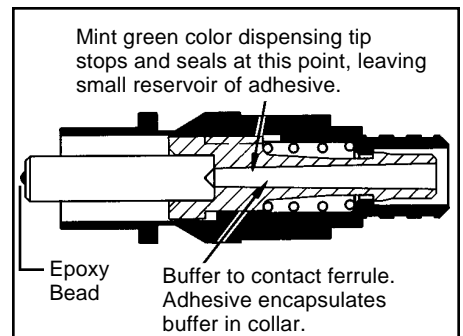

Fig. C7a

## SECTION C

### Mounting

#### 8. THREAD THE CONNECTOR ONTO THE FIBER

Slide the crimp ring up the cable within 1/2" (13 mm) of the end of the jacket. Hold the cable in one hand directly behind the crimp ring and hold the connector in the other hand. Rest your hands on the table or against each other and carefully thread the connector straight onto the fiber. Slowly rotate the connector between thumb and forefinger in order to ease the funneling of the fiber into the guide hole of the ferrule (Fig. C8). Carefully observe that the fiber is moving through the ferrule while threading the connector. This ensures that the fiber hasn't broken during the mounting process.

While rotating the connector, maintain a continuous light inward pressure in order to assist entry alignment. Slowly slide the connector onto the fiber until the buffer seats at the base of the ferrule. The Kevlar must flare around the backbone of the connector (Fig. C9).

Once the buffer is seated, do not pull on the fiber. Keeping the fiber forward will ensure that the epoxy does not deposit anywhere inside the body of the connector. Hold the connector in place and carefully slide the crimp ring up over the Kevlar until the ring is seated with the back end of the connector (Fig. C10).

#### 9. CRIMP THE RING ONTO THE CONNECTOR BACKBONE.

Make sure that the crimp ring is fully seated over the back of the connector. Hold the connector in place with your forefinger and middle finger. Be sure that the crimp cavity marked .190 completely covers the upper portion of the ring and crimp the ring to the connector, securing the Kevlar (Fig. C11).

Next, crimp the smaller diameter of the crimp ring to retain the cable's jacket. Use cavity .137 for 3.0 mm and .120 for 2.4 mm. Be careful not to pinch the cable between the jaws.

#### 10. EXAMINE THE EPOXY BEAD

The correct epoxy bead height at the fiber should be between 2 to 4 fiber diameters (0.10" to 0.020") above the ceramic tip. If this is not the case, additional epoxy must be applied around the fiber base to build the bead to the proper height. A short piece of buffered fiber with about 1/4" (6 mm) of exposed fiber makes a good applicator.

To apply: Carefully deposit epoxy on the end of the ferrule through the opening in the load adapter using a short piece of buffered fiber .

**Important:** *The outside diameter of the ceramic ferrule must be free of epoxy. Excess epoxy will adhere the load adapter to the ferrule during the curing process.*

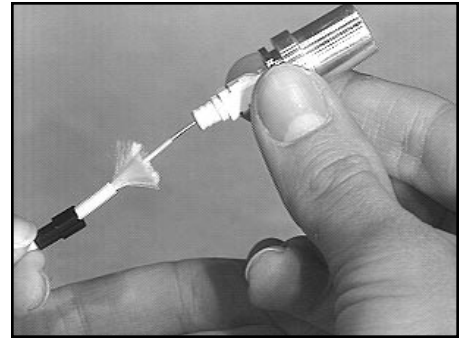

Fig. C8

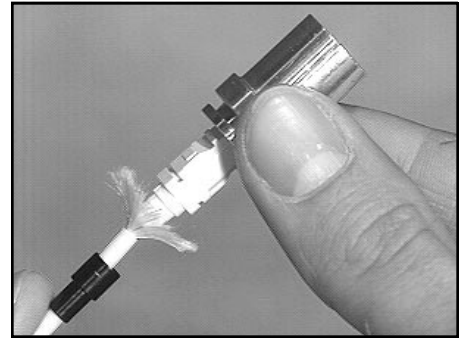

Fig. C9

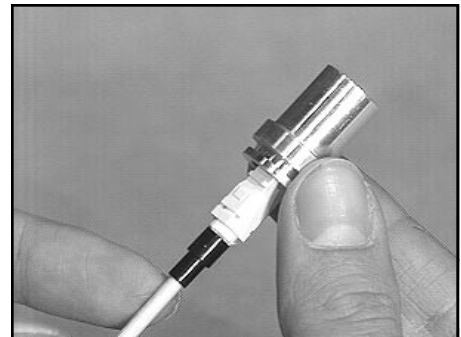

Fig. C10

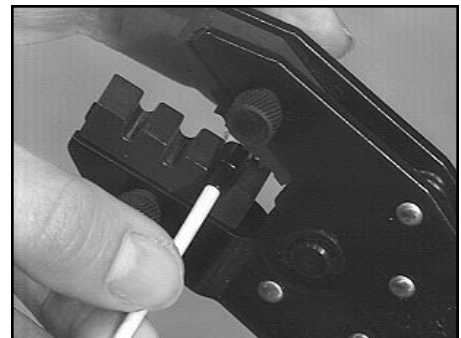

Fig. C11

## SECTION C

### Mounting

#### 11. SECURE THE STRAIN RELIEF BOOT

Use the syringe to apply two dabs of epoxy onto the larger half of the crimp ring (Fig. C12). While holding the load adapter, slide the boot up over the crimp ring and rotate it to evenly distribute the epoxy.

The boot should cover only the crimp ring, not the plastic body of the connector.

**Note:** *Be sure to wipe away any excess epoxy using a dry lint-free cloth.*

#### For SC Connectors

Be sure to align the key on the boot with the flat, smooth side of the connector (Fig. C13). Attach an alignment clip over the boot and connector body to hold the boot in alignment while the epoxy cures. The back of the alignment clip should cover the key on the boot (Fig. C14). (If the clips spread with use, pinch them closed while warm.)

#### 12. EPOXY CURING

When the oven is heated to the proper temperature, the heater light will go off. Place the connector and load adapter into one of the oven's ports (Fig. C15). After 20 minutes, remove the connector from the oven and place it in the curing stand to cool.

**Note:** *Do not score the fiber before the epoxy is cool and hard.*

**Note:** *Heat curing this epoxy in the 3M oven is **required** in order to meet the Bellcore temperature requirement of +85°C as outlined in TR-NWT-000326 Issue 3. If compliance to this specification is not necessary, the 3M epoxy can also be cured overnight at room temperature.*



Fig. C12



Fig. C13



Fig. C14



Fig. C15

## SECTION D

### Scoring

1. CAREFULLY REMOVE THE LOAD ADAPTER
2. SCORE THE FIBER

Hold the connector in a vertical position with the fiber pointing upward. Score the fiber by drawing the scoring blade lightly against the fiber, just above the epoxy bead (Fig. D1). The fiber should merely be touched and not severed.

3. DETACH THE SCORED FIBER

Using your fingers, carefully remove the fiber by pulling straight up from the ferrule. If the fiber is too short, use the scoring tool to gently press against the fiber from the scored side until it breaks along the score mark.

**Note:** *Be sure to dispose of all fiber ends per company practice. If the fiber should break off accidentally without the benefit of proper scoring, polishing should still be attempted.*

4. CHECK THE FIBER END

Check the quality of the score using the jeweler's loupe. The fiber should not protrude from the epoxy bead more than one fiber diameter (Fig. D2). If the fiber is longer than one diameter, proceed as follows: Hold the connector in one hand and a sheet of brown

5  $\mu$ m acetate in the other. Using small circular strokes, shorten the fiber to an acceptable length (Fig. D3).

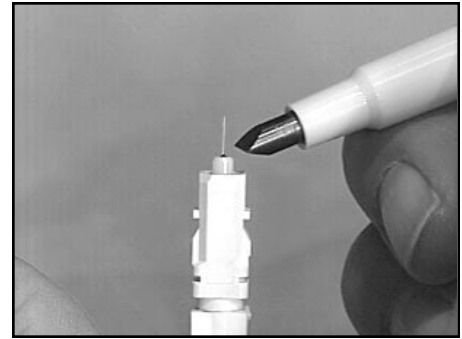

Fig. D1

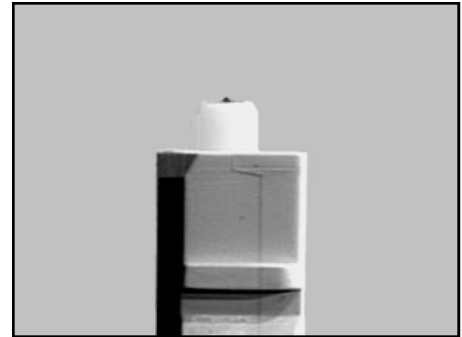

Fig. D2

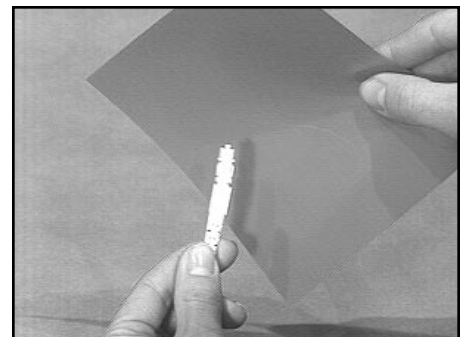

Fig. D3

## SECTION E

### Standard Polishing Process for Single-mode and Multimode Connectors (>30dB)

**Note:** See Section F to achieve >40 dB Return Loss.

#### 1. PREPARE THE 5 $\mu$ m POLISHING SURFACE

Clean the surface of the soft polishing pad with a lint-free cloth dampened with isopropyl alcohol. Blow clean both sides of a sheet of brown 5  $\mu$ m lapping acetate. Place the acetate shiny side down onto the soft pad.

**Note:** Carefully follow safety, health and disposal information on container label or Material Safety Data Sheet for isopropyl alcohol being used.

#### 2. PREPARE THE POLISHING JIG AND CONNECTOR

Wipe the polishing surface of the jig with a lint-free cloth moistened with isopropyl alcohol. Blow the entire jig clean with compressed air. Clean the connector with compressed air only, since wiping it may break the fiber.

**Note:** The polishing jig used in these procedures is designed with three "wear indicators" on its polishing surface (Fig. E1). Each indicator is 0.002" deep. As polishing is done, the surface of the jig will be worn away. Uniform pressure across the jig's surface during polishing will result in the areas surrounding the "indicators" to wear evenly. Non-uniform pressure will result in one or two indicators disappearing, thereby requiring the jig to be replaced.

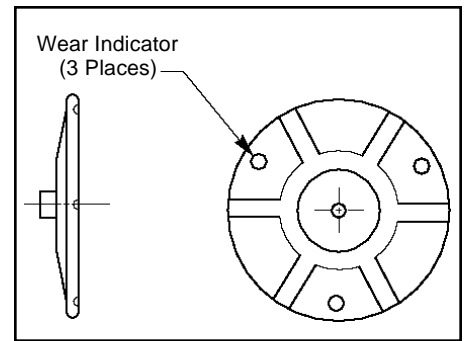

Fig. E1

## SECTION E

### Standard Polishing Process for Single-mode and Multimode Connectors

#### 3. PERFORM THE 5 $\mu$ m FINISH

While holding the polishing jig in your hand, insert the connector so that the ferrule end does not protrude past the bottom of the polishing jig. This is to ensure that the extended fiber from the ferrule will not be broken off below the epoxy level upon initial contact with the lapping film.

**Note:** *The ferrule must be inserted straight into the jig hole. If the ferrule tip is wiggled upon entering the composite jig, the composite jig may be damaged.*

**Note:** *If the connector does not fit easily into the jig, examine the sides of the ceramic ferrule for epoxy. Any excess epoxy can be removed with a razor blade.*

While holding both the connector and the polishing jig in one hand, slowly place the jig on the lapping film and begin to polish in a figure 8 motion without applying pressure on the connector (Fig. E2). Light scratch marks should begin to appear on the acetate surface.

Continue to polish until the fiber is flush with the epoxy bead (approximately 6 figure 8's) (Fig. E3). Once the fiber is supported by the epoxy bead, begin applying light pressure on the connector while polishing in a figure 8 motion. Continue to polish on the 5  $\mu$ m acetate until a thin layer of light blue color epoxy remains on the ceramic tip (Fig. E4). Stop when the outer edges of the epoxy layer start to break up and feather. This can be seen using the 7X jewelers loupe.

**Note:** *Until familiar with the process from this point, inspect the remaining epoxy after each single figure 8 until a thin feathered edge remains. DO NOT REMOVE ALL EPOXY WITH THE 5  $\mu$ m ACETATE.*

**Note:** *The 5  $\mu$ m lapping acetate can be cleaned with isopropyl alcohol and blown dry for reuse. The sheet can be used to polish 2 to 4 connectors.*

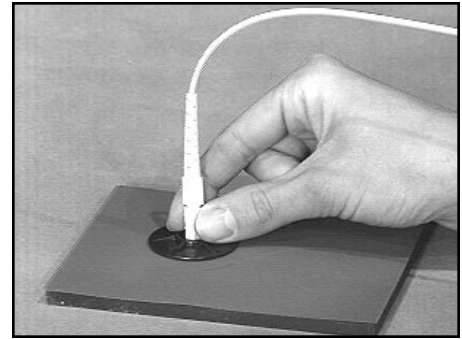

Fig. E2

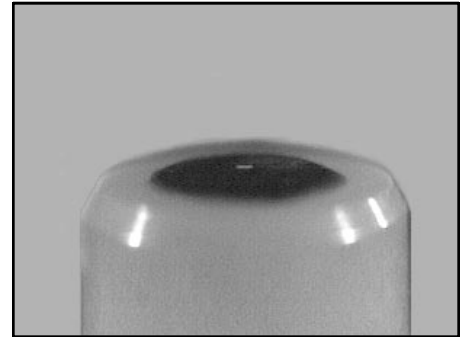

Fig. E3

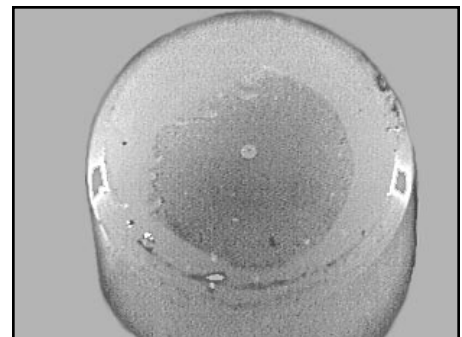

Fig. E4

## SECTION E

### Standard Polishing Process for Single-mode and Multimode Connectors

#### 4. PREPARE TO PERFORM THE 1 $\mu$ m FINISH

Using an isopropyl alcohol dampened lint-free cloth, clean the ferrule, the polishing jig, and the 5  $\mu$ m lapping acetate. Blow all pieces dry with compressed air.

Clean a sheet of the green 1  $\mu$ m lapping acetate and place it shiny side down directly on top of the 5  $\mu$ m acetate which remains on the polishing pad. Place three to four drops of water on the 1  $\mu$ m acetate (Fig. E5).

#### 5. PERFORMING THE 1 $\mu$ m FINISH

Insert the ferrule into the jig and lower it gently on to the moistened green 1  $\mu$ m acetate.

Lightly polish until all the epoxy is removed (15 to 20 figure 8's). Inspect with the jewelers loupe (Fig. E6).

Do not overuse the 1  $\mu$ m lapping acetate. Always attempt to polish on fresh areas of the acetate. After the entire surface of the acetate has been used it can be cleaned with isopropyl alcohol and reused to polish several more connectors and then discarded. If deep scratches appear on the fiber, discard the 1  $\mu$ m acetate at that time.

#### 6. FINAL INSPECTION

After polishing, remove the connector from the polishing jig, clean the ferrule and insert it into the fiber view scope (Fig. E7). The fiber should be free of epoxy and scratches and be flush with the domed end of the ceramic ferrule (Fig. E8). If scratches or epoxy are present (Fig. E9) clean the 1  $\mu$ m acetate surface and repeat step 5 with frequent inspections.

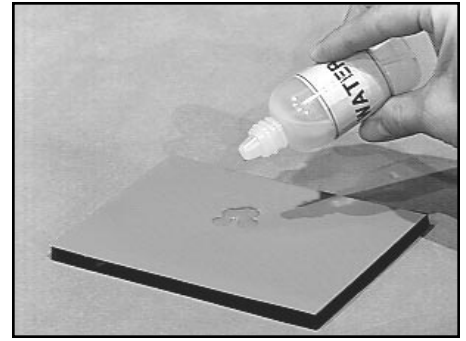

Fig. E5

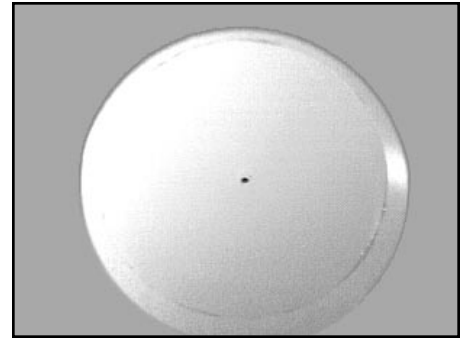

Fig. E6



Fig. E7

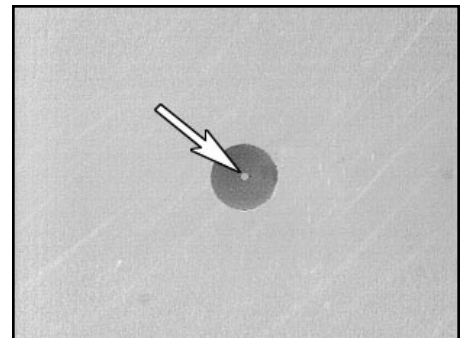

Fig. E8

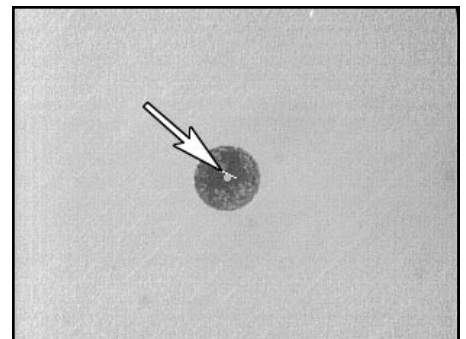

Fig. E9

## SECTION F

### Polishing Process for Single-mode Connector Return Loss >40dB

This process will need to be used for single-mode finishes with a reflection requirement of 40dB or better. This specification is outlined in Bellcore TR-NWT-00326 Issue 3.

#### 1. PREPARE THE POLISHING SURFACE

Clean the surface of the soft polishing pad with a lint-free cloth moistened with isopropyl alcohol. Blow clean both sides of a sheet of brown 5  $\mu$ m lapping acetate. Place the acetate shiny side down onto the soft pad.

**Note:** *Carefully follow safety, health and disposal information on container label or Material Safety Data Sheet for isopropyl alcohol being used.*

#### 2. PREPARE THE POLISHING JIG

Wipe the polishing surface of the composite jig with a lint-free cloth moistened with isopropyl alcohol. Blow the entire jig clean with compressed air.

**Note:** *The polishing jig used in these procedures is designed with three "wear indicators" on its polishing surface (Fig. F1). Each indicator is 0.002" deep. As polishing is done, the surface of the jig will be worn away. Uniform pressure across the jig's surface during polishing will result in the areas surrounding the "indicators" to wear.*

**Note:** *The composite polishing jig must be used when following the >40dB process. The stainless steel jig, which is available separately, can be used with the standard polishing process only.*

#### 3. CHECK THE FERRULE HOLE IN THE POLISHING TOOL

In order to achieve greater than -40dB reflection on single-mode connectors, it is extremely important that the polishing tool accurately holds the ceramic ferrule radius on center during the polishing procedure. This is accomplished by the squareness and tight dimensional clearance of the polishing jig.

Periodically, check the ferrule hole in the jig using the NO/GO gauge pin provided in the Field Termination Kit. The NO/GO pin should not even start into the hole if the polishing jig is within tolerance. To check the ferrule hole, gently insert the gauge pin through the hole on the top of the polishing tool (Fig. F2). **DO NOT TRY TO FORCE THE PIN THROUGH THE OPENING.** If the pin does not pass through the hole, continue to use the tool to polish single-mode connectors. If the pin does pass through the opening of the tool, the tool has worn and should be used for **multimode finishes only**.

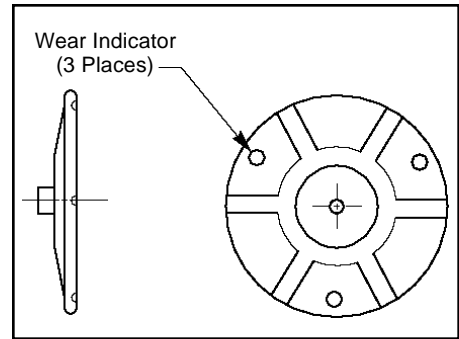

Fig. F1

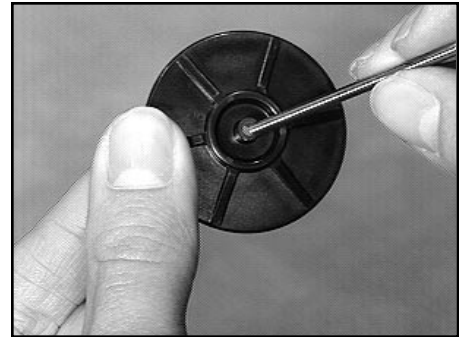

Fig. F2



## SECTION F

### Polishing Process for Single-mode Connector Return Loss >40dB

#### 4. PERFORM THE 5 $\mu$ m FINISH

While holding the polishing jig in your hand, insert the connector so that the ferrule end does not protrude past the bottom of the polishing jig. This is to ensure that the extended fiber from the ferrule will not be broken off below the epoxy level upon initial contact to the lapping film.

**Note:** *The ferrule must be inserted straight into the jig hole. If the ferrule tip is wiggled upon entering, the composite jig may be damaged.*

**Note:** *If the connector does not fit easily into the jig, examine the sides of the ceramic ferrule for epoxy. Any excess epoxy can be removed with a razor blade.*

While holding both the connector and the polishing jig in one hand, slowly place the jig on the lapping film and begin to polish in a figure 8 motion without applying pressure on the connector (Fig. F3). Light scratch marks should begin to appear on the acetate surface.

Continue to polish until the fiber is flush with the epoxy bead (approximately 6 figure 8's) (Fig. F4). Once the fiber is supported by the epoxy bead, begin applying light pressure on the connector while polishing in a figure 8 motion. Continue to polish on the 5  $\mu$ m acetate until a thin layer of light blue color epoxy remains on the ceramic tip (Fig. F5). Stop when the outer edges of the epoxy layer start to break up and feather. This can be seen using the 7X jewelers loupe.

**Note:** *Until familiar with the process from this point, inspect the remaining epoxy after each single figure 8 until a thin feathered edge remains. DO NOT REMOVE ALL OF THE EPOXY WITH THE 5  $\mu$ m ACETATE.*

**Note:** *The 5  $\mu$ m lapping acetate can be cleaned with isopropyl alcohol and blown dry for reuse. The sheet can be used to polish 2 to 4 connectors.*

#### 5. PREPARE TO PERFORM THE 1.5 $\mu$ m FINISH

Using an isopropyl alcohol dampened lint-free cloth, clean the ferrule and the polishing jig. Blow both parts dry with compressed air.

Clean a sheet of the 1.5  $\mu$ m diamond lapping acetate and place it shiny side down directly onto the clean polishing pad.

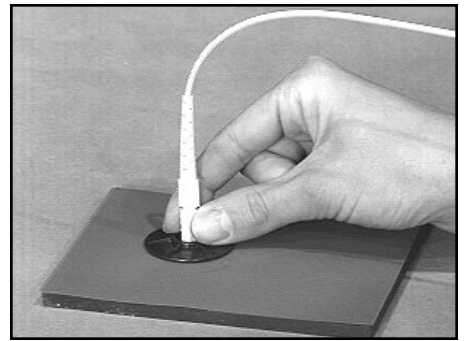

Fig. F3

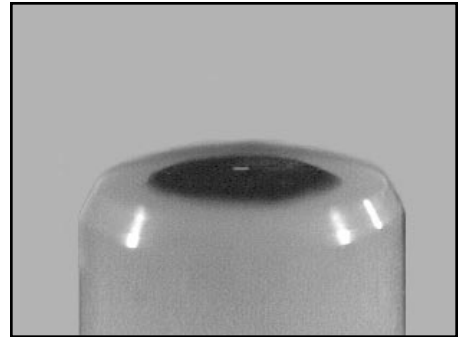

Fig. F4

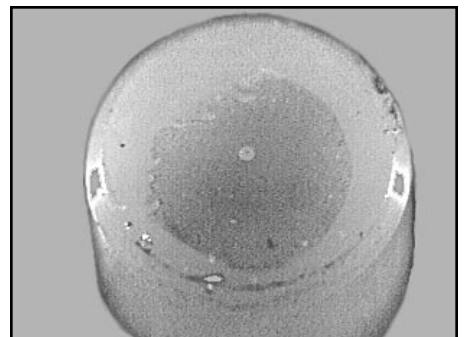

Fig. F5

## SECTION F

### Polishing Process for Single-mode Connector Return Loss >40dB

#### 6. PERFORM THE 1.5 $\mu$ m FINISH

Insert the ferrule into the jig and lower it gently onto the 1.5  $\mu$ m acetate.

Using medium pressure (equivalent to 1 lb of force), perform four figure 8 strokes. Rotate the ferrule in the jig 180° (Fig. F6) and perform another four figure 8's. Continue to follow this sequence rotating 180° every 4 strokes until 6 sets of 4 figure 8's (24 total) have been performed.

**Note:** *Without rotating the ferrule the radius center may drift. Rotating effectively eliminates this.*

Clean the ferrule with a lint-free cloth moistened with isopropyl alcohol and inspect the fiber using the 100X view scope. The fiber should be completely smooth and all the epoxy removed as in Fig. F7. If epoxy remains or scratches or rough edges are present on the fiber as in Fig. F8, perform a few more figure 8 strokes on each 180° orientation.

**Note:** *If all of the epoxy was removed from the fiber during the first step of polishing, the fiber surface may be heavily scratched and pitted. If this is the case, perform another set of figure 8's on each 180° orientation and inspect again.*

**Note:** *The 1.5  $\mu$ m diamond film can be cleaned with isopropyl alcohol and blown dry for reuse. The sheet can be used to polish up to 15 connectors.*

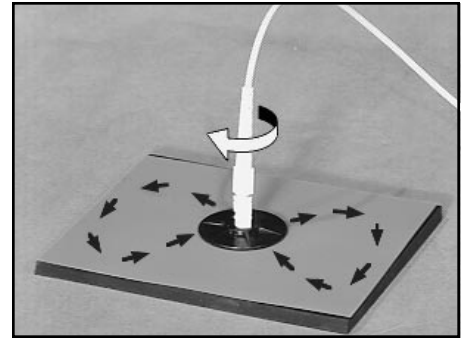

Fig. F6

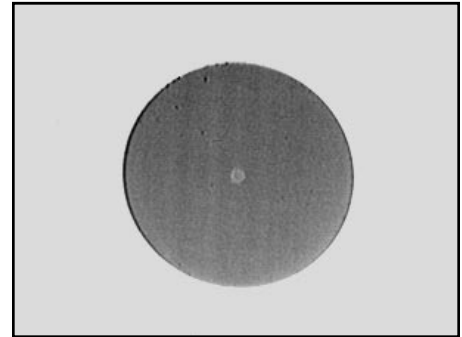

Fig. F7

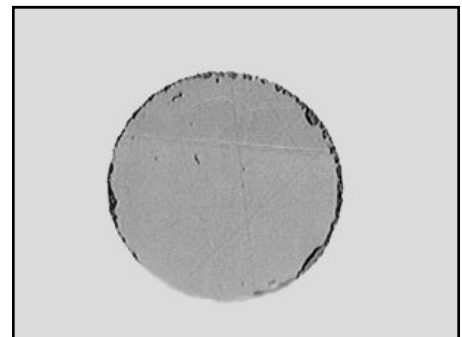

Fig. F8

## SECTION F

### Polishing Process for Single-mode Connector Return Loss >40dB

#### 7. PREPARE TO PERFORM THE FINAL POLISH

Using an isopropyl alcohol dampened lint-free cloth, clean the ferrule and the polishing jig.

Clean a sheet of the final polishing film and place it shiny side down onto the clean polishing pad. Section the film into four (4) quarters. Mark the section 1, 2, 3 and 4. Place a few drops of water on section 1 of the film (Fig. F9).

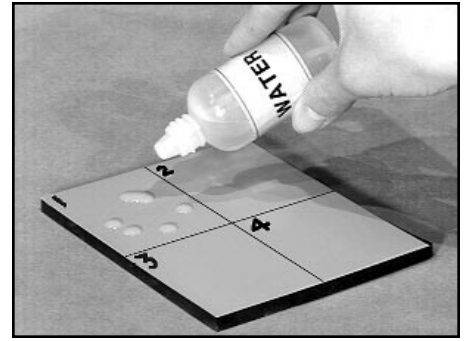

Fig. F9

#### 8. PERFORM THE FINAL POLISH

Insert the ferrule into the jig and lower it gently onto the moistened polishing film.

Using the same medium pressure as in step 6, perform small circles in a spirograph pattern as shown in (Fig. F10). Perform 25 circular strokes. Wipe the ferrule dry with a lint-free cloth and inspect the ferrule end using the 100X microscope. The fiber should be completely smooth and free of any scratches (Fig. F11). If scratches are present in the fiber, perform an additional 3 to 5 strokes on an unused area of the film and inspect again. If necessary a final lapping of 3 to 5 strokes can be performed.

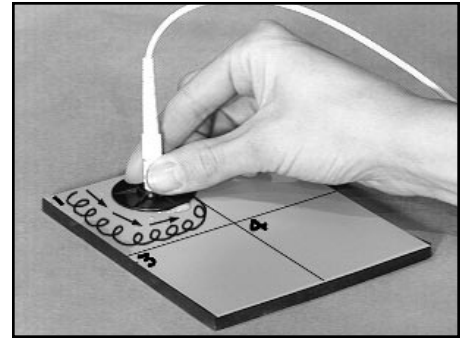

Fig. F10

**Note:** *The final polishing film can be used to polish up to 4 ferrule ends. Be sure to use a fresh area of the polishing film each time a new connector is to be polished.*



Fig. F11

## SECTION G

### Final Cleaning

1. BLOW THE DUST CAP WITH COMPRESSED AIR
2. WIPE THE CERAMIC FERRULE WITH AN ISOPROPYL ALCOHOL DAMPENED LINT-FREE CLOTH (Fig. G1)

Be sure to wipe the entire length of the ferrule and the ferrule tip.

**Note:** *Carefully follow safety, health and disposal information on container label or Material Safety Data Sheet for isopropyl alcohol being used.*

3. BLOW THE FERRULE WITH THE COMPRESSED AIR
4. IMMEDIATELY COVER THE FERRULE WITH THE DUST CAP

## SECTION H

### Mounting Unjacketed/900 m Buffered Fiber

**Note:** *General instructions for preparation for mounting may be found in Section B steps 1 - 4.*

1. SLIP THE STRAIN RELIEF BOOT ONTO THE BUFFERED FIBER, SMALL END FIRST (Fig. H1)

2. PLACE THE CRIMP RING ONTO THE STRAIN RELIEF TUBE

Measure and mark the clear strain relief tube 3/16" (5 mm) from its end. Slide the smaller diameter of the black 3.0 mm crimp ring onto the tube until the end of the ring aligns with the mark on the tube (Fig. H2).

3. PLACE THE CLEAR TUBE WITH THE CRIMP RING ONTO THE BUFFERED FIBER (Fig. H3)

The larger diameter of the crimp ring MUST be towards the end of the fiber.

4. REMOVE 3/4" (19 mm) OF BUFFER USING THE NO-NIK TOOL (Fig. H4)

(Refer to Section B, step 9).

5. CLEAN THE FIBER WITH ISOPROPYL ALCOHOL

(See Section B, step 10).

**Note:** *Carefully follow safety, health and disposal information on container label or Material Safety Data Sheet for isopropyl alcohol being used.*

6. CONTINUE WITH STEPS C1 - C7

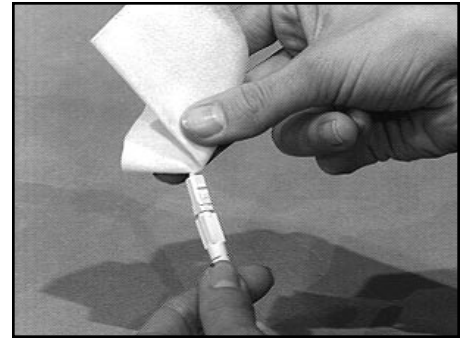

Fig. G1

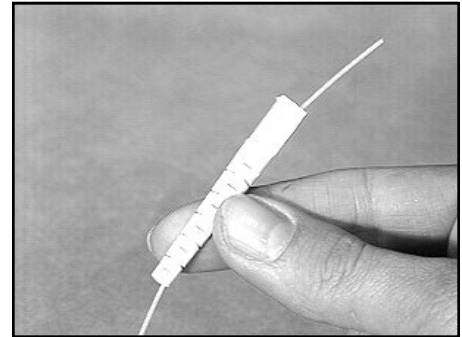

Fig. H1

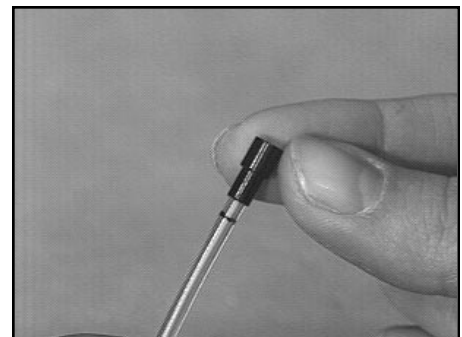

Fig. H2

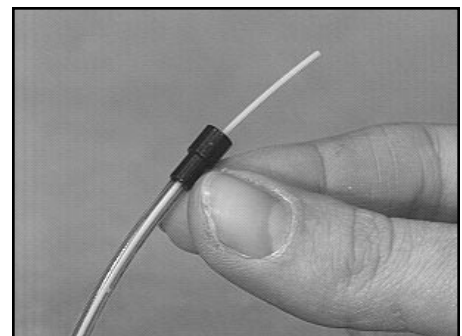

Fig. H3

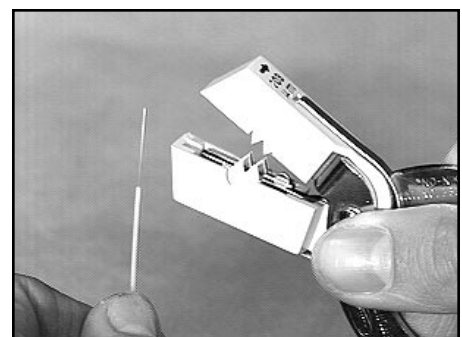

Fig. H4

## SECTION H

### Mounting Unjacketed/900 m Buffered Fiber

#### 7. THREAD THE CONNECTOR ONTO THE FIBER

Slide the strain relief tube with the crimp ring within 1/2" (13 mm) of the buffer. While holding the fiber directly behind the strain relief tube, slowly thread the connector straight onto the fiber until the buffer seats at the base of the ferrule (Fig. H5). While holding the connector in place, slide the strain relief tube and the crimp ring up the buffer until the crimp ring is seated on the back end of the connector. The mark on the clear tube **MUST** align with the end of the crimp ring before crimping the ring to the connector and tube (Fig. H6).

#### 8. CRIMP THE RING TO THE CONNECTOR AND TUBE

While holding the connector and strain relief tube in place, crimp the upper portion of the ring to the back end of the connector using the cavity marked .190 in the crimp tool (Fig. H7). Reposition the connector to the center cavity .137, securing the ring to the tube.

#### 9. CONTINUE WITH TERMINATION PROCEDURE FOR JACKETED CABLE, SECTION C10-12 AND SECTIONS D THROUGH G

**Note:** *After placing the connector in the curing oven, gently push down on the buffered fiber to be sure that it is seated.*

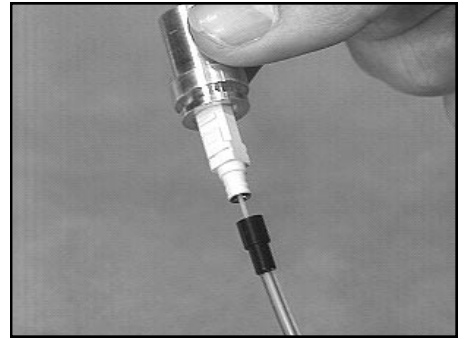

Fig. H5

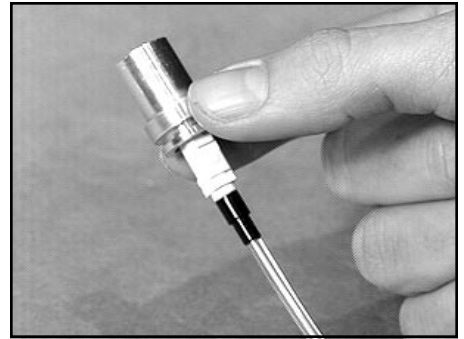

Fig. H6

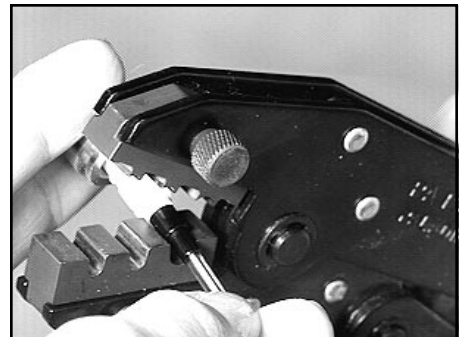

Fig. H7

## SECTION I

### Connector Assembly and Installation

#### 1. CONNECTOR ASSEMBLY

Once the SC connector has been mounted and polished, the housing can be installed onto the body.

##### A. Standard Density Applications

While holding the connector firmly by the boot, align the chamfers on both the connector and housing and snap into place (Fig. 11). A positive click will be heard when the housing is fully engaged.

##### B. High Density Applications

This application does not require the housing to be placed onto the connector body. The high density coupling is used without the sliding housing.

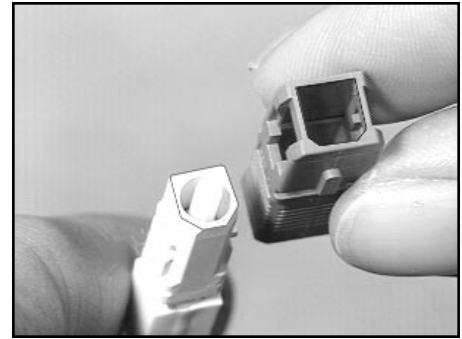

Fig. 11

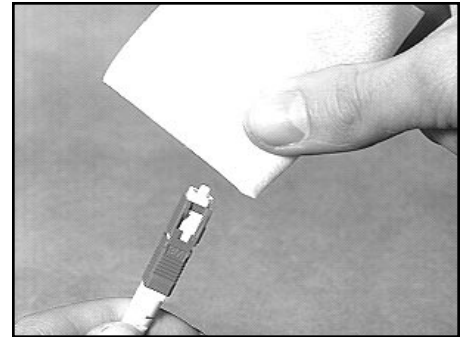

Fig. 12

#### 2. CONNECTOR COUPLING CLEANING

Only one connection should be made at a time and the dust caps should not be removed until immediately prior to mating.

A. Clean the ceramic ferrule of the connector with an isopropyl alcohol dampened lint-free cloth (Fig. 12) and immediately blow with compressed air.

**Note:** *Carefully follow safety, health and disposal information on container label or Material Safety Data Sheet for isopropyl alcohol being used.*

B. Insert an isopropyl alcohol dampened pipe cleaner into the coupling to remove any foreign particles (Fig. 13). Blow with compressed air.

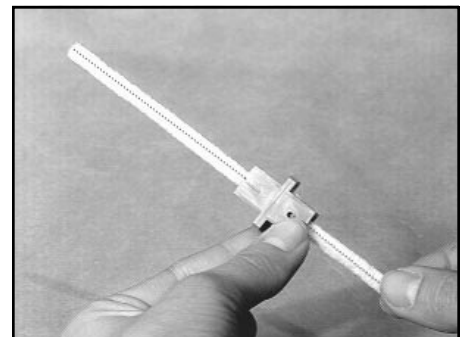

Fig. 13

#### 3. SC CONNECTOR - STANDARD DENSITY MATING

##### Installation

A. Hold the connector by the housing. Align the key on the connector housing with the slot of the coupling (Fig. 14) and push into place with a positive click. (The white line or slot in the housing will not be visible when fully latched).

B. Uncap, clean and install the second connector as described above.

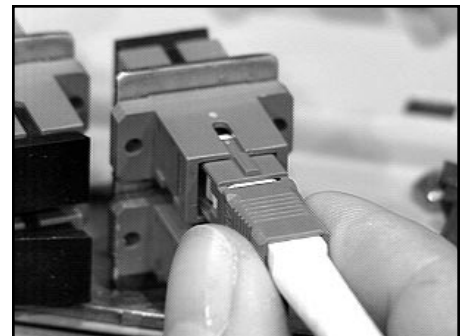

Fig. 14

##### Removal

A. To release the connector from the coupling, pull back on the connector housing.

B. Cover connector and coupling ends with dust caps when not being used.

## SECTION I

### Connector Assembly and Installation

#### 4. SC CONNECTOR - HIGH DENSITY MATING

##### Installation

- A. Clean the connector and coupling as described above.
- B. Hold the connector by the boot.
- C. Align the connector chamfers with the coupling (Fig. I5) and push into place.

##### Removal

**Note:** *This connector requires a tool to remove it from a coupling.*

- A. Depress the buttons on the tool to raise pulling fingers.
- B. Position tool prongs over connector and insert into the coupling.
- C. Release the buttons on the tool to engage the fingers and pull firmly back to release the connector.

#### 5. FC/PC3 CONNECTOR - MATING

##### Installation

- A. Clean the connector and coupling as described above.
- B. Engage the key in the slot while holding the connector by the boot (Fig. I6). Make sure that the key remains engaged while tightening the threaded nut.

##### Removal

- A. To release the connector from the coupling, unscrew the connector and cover all parts with dust caps.

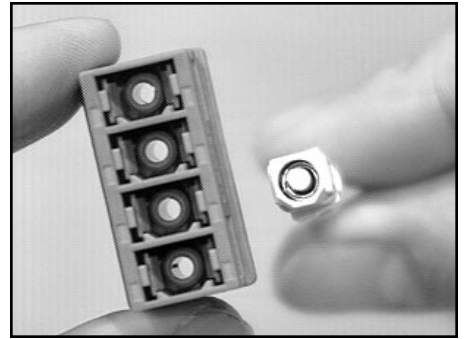

Fig. I5



Fig. I6

## SECTION J

### 3M brand SC and FC/PC3 Epoxy Field Termination Kits

<u>DESCRIPTION</u>	<u>QTY</u>	<u>PRODUCT #</u>
3M brand SC and FC/PC3 Epoxy Field Termination Kit (110V)	1	8350
3M brand SC and FC/PC3 Epoxy Field Termination Kit (220V)	1	8351

<u>KIT COMPONENTS</u>	<u>QTY</u>	<u>PART #</u>
Scissors	1	80-6104-4754-4
Cable Stripper	1	80-6104-4314-7
Modified No-Nik Stripper (175 m)	1	80-6104-5332-8
Scribe - blade	1	80-6106-2590-9
Fiber View Scope with Adapter	1	80-6104-4344-4
Lint Free Cloths (Pkg.)	1	80-6104-4324-6
Ferrule Connector Polishing Jig	2	78-8073-7527-0
Alcohol Bottle	1	80-6104-4329-5
Water Bottle	1	80-6104-5334-4
Pipe Cleaners (Pkg.)	1	80-6104-4349-3
Jewelers Loupe (7X)	1	80-6104-4353-5
Pocket Ruler	1	80-6104-5337-7
Crimp Tool	1	78-8073-8169-0
Stripping Collar SC and FC/PC3	4	78-8073-8168-2
Manual	1	34-7033-9144-0
Dispensing Tips	25	78-8073-7596-5
Syringes	25	80-6104-4347-7
Curing Stand	1	80-6104-4334-5
Polishing Pad	1	80-6104-5375-7
5um Acetate (Pkg.)	1	80-6104-4346-9
1um Acetate (Pkg.)	1	80-6104-4323-8
1.5um Diamond Acetate (Pkg.)	1	78-8073-8167-4
SM Final Polish Acetate (Pkg.)	1	78-8073-8166-6
Cleaning Wires 12/vial	1	80-6104-4345-1
Epoxy (8692)	10	80-6107-7202-4
SC and FC/PC3 Load Adapters	6	78-8073-8165-8
Curing Oven, 110V (8350 Kit)	1	80-6104-4351-9
Curing Oven, 220V (8351 Kit)	1	80-6104-4354-3
Pin Gauge, Jig	1	78-8073-7965-2
Alignment clips (pkg)	1	78-8073-8179-9

"Kevlar" is a trademark of DuPont Co. "ST" is a trademark of AT&T.

#### Important Notice

All statements, technical information and recommendations related to the Seller's products are based on information believed to be reliable, but the accuracy or completeness thereof is not guaranteed. Before utilizing the product, the user should determine the suitability of the product for its intended use. The user assumes all risks and liability whatsoever in connection with such use.

Any statements or recommendations of the Seller which are not contained in the Seller's current publications shall have no force or effect unless contained in an agreement signed by an authorized officer of the Seller. The statements contained herein are made in lieu of all warranties, express or implied, including but not limited to the implied warranties of merchantability and fitness for a particular purpose which warranties are hereby expressly disclaimed.

SELLER SHALL NOT BE LIABLE TO THE USER OR ANY OTHER PERSON UNDER ANY LEGAL THEORY, INCLUDING BUT NOT LIMITED TO NEGLIGENCE OR STRICT LIABILITY, FOR ANY INJURY OR FOR ANY DIRECT OR CONSEQUENTIAL DAMAGES SUSTAINED OR INCURRED BY REASON OF THE USE OF ANY OF THE SELLER'S PRODUCTS THAT WERE DEFECTIVE.  
34-7033-9144-0

© 1993 3M

Litho in U.S.A.

#### 3M Telecom Systems Group

6801 River Place Blvd.  
Austin, TX 78726-9000  
800/426-8688





## Free Manuals Download Website

<http://myh66.com>

<http://usermanuals.us>

<http://www.somanuals.com>

<http://www.4manuals.cc>

<http://www.manual-lib.com>

<http://www.404manual.com>

<http://www.luxmanual.com>

<http://aubethermostatmanual.com>

Golf course search by state

<http://golfingnear.com>

Email search by domain

<http://emailbydomain.com>

Auto manuals search

<http://auto.somanuals.com>

TV manuals search

<http://tv.somanuals.com>