



**3M 7000 Series  
Respirator Full Facepiece**

*User Instructions for 3M™ Silicone, Small 7800S, Silicone,  
Medium 7800S, Silicone, Large 7800S Full Facepieces*

Important: Keep these *User Instructions* for reference.

## GENERAL SAFETY INFORMATION

### Intended Use

The 3M™ 7000 Series Full Facepiece Respirators are NIOSH approved and designed to help provide respiratory protection against certain airborne contaminants when used in accordance with all use instructions and limitations and applicable safety and health regulations.



### WARNING

This respirator helps protect against certain airborne contaminants. **Misuse may result in sickness or death.** For proper use, see supervisor, or *User Instructions*, or call 3M

These *User Instructions* provide information about facepiece use only. Important information is provided in the *User Instructions* with each of the air filtration/supplied air systems. Failure to follow the *User Instructions* for the air filtration/supplied air systems being used **may result in sickness or death.**

**Do not clean respirator with solvents.** Cleaning with solvents may degrade some respirator components and reduce respirator effectiveness. Inspect all respirator components before each use to ensure proper operating conditions.

---

### CAUTION:

This product contains natural rubber latex which may cause an allergic reaction.

---

# USE INSTRUCTIONS AND LIMITATIONS

## Important

Before use, the wearer must read and understand these *User Instructions*. Keep these instructions for reference.

## Use For

Respiratory protection from certain airborne contaminants according to NIOSH approvals, OSHA limitations, in Canada CSA standard Z94.4 requirements, other applicable regulations and 3M instructions.

## Do Not Use For

Concentrations of contaminants which are immediately dangerous to life or health, are unknown or when concentrations exceed 10 times the permissible exposure limit (PEL) in air-purifying mode when qualitatively fit tested, 50 times the PEL in air-purifying mode when quantitatively fit tested, 1000 times the PEL in powered air-purifying or supplied air mode, or according to specific OSHA standards or applicable government regulations, whichever is lower.

## Use Instructions

1. Failure to follow all instructions and limitations on the use of this respirator and/or failure to wear this respirator during all times of exposure can reduce respirator effectiveness and **may result in sickness or death**.
2. Before using this respirator, a written respiratory protection program must be implemented meeting all the requirements of OSHA 29 CFR 1910.134 such as medical evaluation, training and fit testing and applicable OSHA substance specific standards. In Canada, CSA standard Z94.4 requirements must be met.
3. The airborne contaminants which can be dangerous to your health include those that are so small you cannot see them.
4. Leave contaminated area immediately and contact supervisor if you smell or taste contaminants or if dizziness, irritation, or other distress occurs.
5. Store respirator away from contaminated areas when not in use.
6. Dispose of used product in accordance with applicable regulations.

## Use Limitations

1. This respirator does not supply oxygen when used in air-purifying mode. Do not use in atmospheres containing less than 19.5% oxygen.
2. Do not use when concentrations of contaminants are immediately dangerous to life and health, are unknown or when concentrations exceed 10 times the permissible exposure limit (PEL) in air-purifying mode when qualitatively fit tested, 50 times the PEL in air-purifying mode when quantitatively fit tested, 1000 times the PEL in powered air-purifying or supplied air mode, or according to specific OSHA standards or applicable government regulations, whichever is lower.
3. Do not alter, abuse or misuse this respirator.
4. Do not use with beards or other facial hair or other conditions that prevent a good seal between the face and the faceseal of the respirator.

## Time Use Limitations

1. If respirator becomes damaged, leave the contaminated area immediately and repair or replace the respirator.
2. Replace filters in accordance with the filter Time Use Limitation.

3. Replace cartridges in accordance with an established change schedule or earlier if smell, taste or irritation from contaminants is detected.

## **NIOSH Cautions and Limitations**

The following restrictions may apply. See NIOSH approval label.

- A- Not for use in atmospheres containing less than 19.5 percent oxygen.
- B- Not for use in atmospheres immediately dangerous to life or health.
- C- Do not exceed maximum use concentrations established by regulatory standards.
- D- Air-line respirators can be used only when the respirators are supplied with respirable air meeting the requirements of CGA G-7.1 Grade D or higher quality.
- E- Use only the pressure ranges and hose lengths specified in the User's Instructions.
- F- Do not use powered air-purifying respirators if airflow is less than four cfm (115 lpm) for tight fitting facepieces or six cfm (170 lpm) for hoods and/or helmets.
- G- If airflow is cut off, switch to filter and/or cartridge or canister and immediately exit to clean air.
- H- Follow established cartridge and canister change schedules or observe ESLI to ensure that cartridges and canisters are replaced before breakthrough occurs.
- I- Contains electrical parts which have not been evaluated as an ignition source in flammable or explosive atmospheres by MSHA/NIOSH.
- J- Failure to properly use and maintain this product could result in injury or death.
- L- Follow the manufacturer's User's Instructions for changing cartridges, canisters and/or filters.
- M- All approved respirators shall be selected, fitted, used, and maintained in accordance with MSHA, OSHA, and other applicable regulations.
- N- Never substitute, modify, add, or omit parts. Use only exact replacement parts in the configuration as specified by the manufacturer.
- O- Refer to User's Instructions, and/or maintenance manuals for information on use and maintenance of these respirators.
- P- NIOSH does not evaluate respirators for use as surgical masks.
- S- Special or critical User's Instructions and/or use limitations apply. Refer to User's Instructions before donning.

## **S-Special or Critical User's Instructions**

3M™ Mercury Vapor Cartridge (6009 and 60929) are equipped with passive 3M™ End of Service Life Indicators (ESLI). The color change indicator must be readily visible when wearing the respirator without manipulation. If you cannot readily see the ESLI, do not use. Mercury vapor cartridges must be discarded when the ESLI changes color; or within 30 days of opening packaging; or when the ESLI becomes dirty or damaged; or when odors of vapors or gases become noticeable, whichever occurs first. Mercury vapor has no odor.

3M™ Nose Cup Assembly 7881S or 7981S must be used in all 7000 Series Full Facepiece applications except for Face-Mounted Power Air-Purifying Systems.



U.S. OSHA Standard 29 CFR 1910.134 requires that employers provide breathing air for supplied air respirator systems which shall "meet at least the requirements of the specification for Grade D breathing air as described in the Compressed Gas Association Commodity Specification ANSI/CGA G-7.1-1997." Testing of output air from a compressor against this standard is required prior to using with a supplied air respirator. In Canada, breathing air systems must be supplied with air which meets at least the requirements in Table 1 of CSA Standard Z180.1-00. **Failure to do so may result in sickness or death.**

## Cartridge and Filter Selection and Approvals

Before using any of these products, the user must read the specific use for, use limitations and warning information or call OH&ESD Technical Service at 1-800-243-4630. In Canada, call Technical Service at 1-800-267-4414. Do not exceed maximum use concentrations established by local regulatory agencies. Cartridges/filters are approved as assemblies for use with 3M™ 7800S (S), 7800S (M) or 7800S (L) facepieces. For NIOSH approval refer to NIOSH approval label packaged with facepiece.

## LIST OF PRODUCTS

### 3M™ 7800S Full Facepiece Respirator Parts, Filters, Chemical Cartridges, or Airline Accessories

#### 3M™ Facepiece

Facepieces do not include filters, chemical cartridges, retainers or airline accessories.

Number	Description	Button Color (7989)
7800S (S)	silicone, small	red
7800S (M)	silicone, medium	yellow
7800S (L)	silicone, large	green

Number	Description
7884	(a) Lens
7914	(b) Band Clamp
7916	(c) Breathing Room Assembly
7999	(d) Air Inlet Gasket
7890	(e) Full Face Plug
7283	(f) Exhalation Valve
7918	(g) Exhalation Valve Cover
7891	(h) Cartridge Holder
7893S	(i) Head Strap Assembly, Silicone
7886	(j) Removable DIN Connector
7887	(k) Inhalation Valve Gasket
701	(l) Cartridge/Filter Adapter for 3M™ 6000 Series Cartridges or 3M™ 2000 Series Filters
6895	(n) Inhalation Gasket (included in 701)
7287	(o) Cartridge Retainer for 3M™ 7000 Series Cartridges
	(p) 3M™ 2000 Series Filters
	(q) 3M™ 6000 Series Cartridge
	(r) 3M™ 7000 Series Cartridge
7881S	(s) Nose Cup Assembly, Silicone (includes Nose Cup Valve Assembly 7882), or
7981S	Nose Cup Assembly, Silicone, Small (includes Nose Cup Valve Assembly 7882)

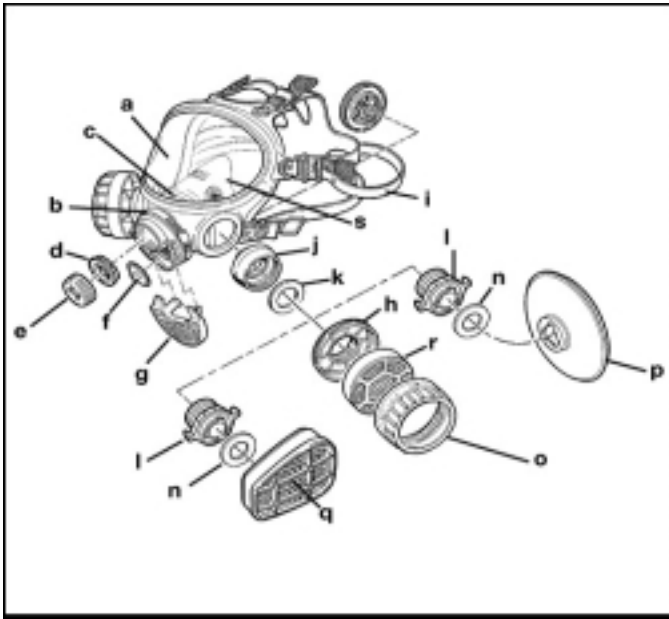

### 3M™ Accessories and Parts

Number	Description
Not Pictured	
601	Fit Test Adapter (for quantitative fit testing with 3M™ P100 Filters 2091 or 7093)
7282	Inhalation Valve
7288	Filter Retainer for Filters 7090
7289	Filter Retainer for Filters 7N11
7882	Nose Cup Valve Assembly
7883	Neckstrap Assembly
7885	Lens Frame Kit
7891	Cartridge Holder (round)
7894	Eyeglass Frame and Mount with case
7895	Speaking Diaphragm Kit (includes Diaphragm, Gasket, Retainer Ring, Tool)
7899-25	Lens Cover (25 pack)
7899-100	Lens Cover (100 pack)
7915	Tyvek® Shroud
7925	Spectacle Kit
7930	Fit Test Adapter (for quantitative fit testing with 3M™ P100 Filter 7090)
7986	Tinted Lens Cover (25 pack)
7989	Buttons
7990	Clip-on Welding Shield Kit
7991	Electronic Lens Assembly
7993	Welder's Shroud

### CAUTION

Failure to properly dispose of spent cartridges, filters, or respirators contaminated by hazardous materials can result in environmental harm. Handling, transportation and disposal of spent cartridges, filters, or respirators must comply with all applicable federal, state, and local laws and regulations.

### 3M™ 2000 Series Filters and 3M™ Filter 7093 and 3M™ Adapter 502

(3M™ Cartridge/Filter Adapter 701 is required. May also be used with 3M™ Adapter 502 as prefilters on 3M™ 6000 Series Cartridges).

<b>Number</b>	<b>Description</b>
502	Filter Adapter for 3M™ 2000 Series or Filters 7093
2071	P95 Particulate Filter
2076HF	P95 Particulate Filter, hydrogen fluoride, with acid gas nuisance relief <sup>1</sup>
2078	P95 Particulate Filter, 3M recommended ozone protection <sup>2</sup> , with organic vapor/acid gas nuisance relief <sup>1</sup>
2091	P100 Particulate Filter
2096	P100 Particulate Filter with acid gas nuisance relief <sup>1</sup>
2097	P100 Particulate Filter, 3M recommended ozone protection <sup>2</sup> , with organic vapor nuisance relief <sup>1</sup>
7093	P100 Particulate Filter

<sup>1</sup>3M recommended for relief against nuisance levels of acid gas or organic vapors. Nuisance levels refers to concentrations not exceeding OSHA PEL or applicable exposure limits, whichever is lower. Do not use for respiratory protection against acid gas/organic vapor.

<sup>2</sup> 3M recommended for ozone protection up to 10 times the OSHA PEL or applicable government occupational exposure limits, whichever is lower (not NIOSH approved for use against ozone).

3M particulate filters should be changed when increased breathing resistance is noticed.

### **3M™ 5000 Series Filters and Retainer**

(Use with 3M™ 6000 Series Cartridges and 3M™ Filter Retainer 501)

<b>Number</b>	<b>Description</b>
501	Filter Retainer for 3M™ Filters 5N11 and 5P71
5N11	N95 Particulate Filter
5P71	P95 Particulate Filter

### **3M™ 6000 Series Cartridges**

(701 cartridge/filter adapter is required)

<b>Number</b>	<b>Description</b>	<b>NIOSH Approved for respiratory protection against the following contaminants up to fifty times the permissible exposure limit with Quantitative Fit Test</b>
6001	Organic Vapor	Certain organic vapors
6002	Acid Gas	Chlorine, hydrogen chloride, and sulfur dioxide or chlorine dioxide or hydrogen sulfide (escape only)
6003	Organic Vapor/Acid Gas	Certain organic vapors, chlorine, hydrogen chloride, and sulfur dioxide or hydrogen sulfide (escape only) or hydrogen fluoride
6004	Ammonia and Methylamine	Ammonia and methylamine
6005	Formaldehyde and Organic Vapor	Formaldehyde and certain organic vapors
6006	Multi-Gas and Vapor	Certain organic vapors, chlorine, hydrogen chloride, chlorine dioxide, sulfur dioxide, ammonia, methylamine, formaldehyde, hydrogen fluoride, or hydrogen sulfide (escape only)
6009	Mercury Vapor/Chlorine Gas	Mercury vapor or chlorine gas
60921	Organic Vapor/P100	Certain organic vapors and particulates
60922	Acid Gas/P100	Chlorine, hydrogen chloride, and sulfur dioxide or chlorine dioxide or hydrogen sulfide (escape

60923	Organic Vapor/Acid Gas/P100	only) and particulates Certain organic vapors, chlorine, hydrogen chloride, and sulfur dioxide or hydrogen sulfide (escape only) or hydrogen fluoride, and particulates
60924	Ammonia/Methylamine/P100	Ammonia and methylamine and particulates
60925	Formaldehyde/Organic Vapor/P100	Formaldehyde and certain organic vapors and particulates
60926	Multi-Gas/Vapor/P100	Certain organic vapors, chlorine, hydrogen chloride, chlorine dioxide, sulfur dioxide, hydrogen sulfide (escape only), ammonia/methylamine, formaldehyde or hydrogen fluoride and particulates
60928	Organic Vapor/Acid Gas/P100	Certain organic vapors, chlorine, hydrogen chloride, and sulfur dioxide or hydrogen sulfide (escape only) or hydrogen fluoride and particulates <sup>1</sup>
60929	Mercury Vapor/Chlorine Gas/P100	Mercury vapor or chlorine and particulates

<sup>1</sup>3M recommended for use against methylbromide or radioiodine up to 5 ppm with daily cartridge replacement.

### 3M™ 7000 Series Chemical Cartridges and Filters

(Use 3M™ Retainer 7287 for all cartridge or cartridge/filter combinations)

Number	Product Name	Description
7N11	N95 Particulate Filter	Particulate filter, N95 (use Retainer 7289 when used alone)
7090	P100 Particulate Filter	Particulate filter, P100 (use Retainer 7288 when used alone)
7251	Organic Vapor	Certain organic vapors
7252	Acid Gas	Chlorine, hydrogen chloride, and sulfur dioxide or chlorine dioxide or hydrogen sulfide (escape only)
7253	Organic Vapor/Acid Gas	Certain organic vapors, chlorine, hydrogen chloride, and sulfur dioxide or hydrogen sulfide (escape only) or hydrogen fluoride
7254	Ammonia/Methylamine	Ammonia and methylamine
7275	Formaldehyde	Formaldehyde or certain organic vapors
7276	Multi-Gas and Vapor	Certain organic vapors, chlorine, hydrogen chloride, chlorine dioxide, sulfur dioxide, ammonia, methylamine, formaldehyde, hydrogen fluoride or hydrogen sulfide (escape only)

### 3M™ Responder Cartridge and Canister

Number	Product Name	Description
450-02-11R06	CP3N Canister	Alpha chloroacetophenone (CN), ortho chlorobenzylidene malonitrile (CS); and P100
FR-64	Cartridge	Certain organic vapors, chlorine, hydrogen chloride, chlorine dioxide, sulfur dioxide, ammonia, methylamine, formaldehyde, hydrogen fluoride, hydrogen sulfide (escape only), alpha chloroacetophenone (CN), ortho chlorobenzylidene malonitrile (CS) or phosphine; and P100



## Service Life of Chemical Cartridges and Filters

3M™ 6000 Series Chemical Cartridges should be used before the expiration date on cartridge packaging. The useful service life of these cartridges will depend upon activity of wearer (breathing rate); specific type, volatility and concentration of contaminants; and environmental conditions such as humidity, pressure, and temperature. Cartridges must be replaced in accordance with an established change schedule or earlier if smell, taste or irritation from contaminants is detected.

Filters must be replaced if they become damaged, soiled or if an increase in breathing resistance occurs. N-series filters should not be used in environments containing oils. R-series filters may be limited to 8 hours of continuous or intermittent use if oil aerosols are present. In environments containing only oil aerosols, P-series filters should be replaced after 40 hours of use or 30 days, whichever is first.

## ASSEMBLY INSTRUCTIONS

The 3M™ 7800S can be used in many different configurations. It can be used as a positive or negative pressure air-purifying respirator or in systems that are air supplied. The following assembly instructions include negative pressure air-purifying, air supplied or combinations of both air supplied and air-purifying. Separate assembly instructions are required for assembly in powered air-purifying systems (PAPR) and supplied air systems.

### 3M™ Air-Purifying Assembly

The facepiece is pre-assembled with 3M™ Cartridge/Filter Adapters 701. When the cartridge/filter adapter 701 is used, the bayonet style filters/cartridges can be attached directly to the facepiece. If round retainer style filter/cartridges are used, the cartridge/filter adapter 701 needs to be replaced with cartridge holders 7891.

### 3M™ 2000 Series and 3M™ Filters 7093

3M™ 2000 Series Filters and 3M™ P100 Filter 7093 can be attached directly to the cartridge/filter adapters 701.

Align bayonet fittings and secure the filters with a clockwise twisting motion (1/4 turn). (Fig. 1)

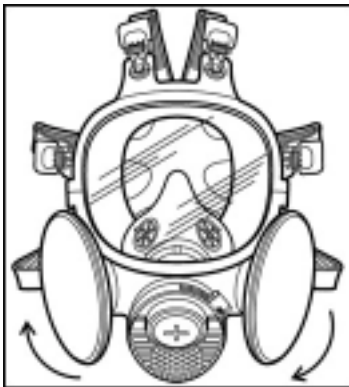

Fig. 1

### 3M™ 6000 Series Cartridges

3M™ 6000 Series Cartridges can be attached directly to the 3M™ Cartridge/Filter Adapters 701. Align the cartridge notch with the small solid bayonet lug and push together. Turn the cartridge clockwise to stop (1/4 turn). Repeat with second cartridge. Loosen the adapter nuts and position cartridge to desired location. **Note:** If 3M™ Mercury Vapor Cartridges 6009 or 60929 are being used, position the cartridge at the location that allows the greatest visibility of the ESLI. If the wearer cannot see the ESLI, do not use for Mercury Vapor exposures. **Hold** cartridge in place and tighten nuts. (Fig. 2 and 3)

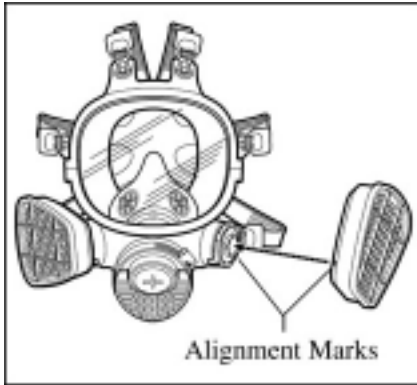

Fig. 2

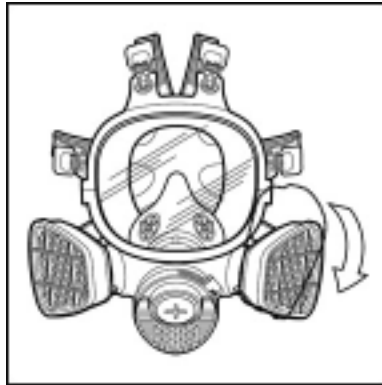

Fig. 3

### Filter Assembly (for 3M™ Filters 5N11 and 5P71)

1. Place filter into 3M™ Retainer 501 so printed side of filter faces the cartridge.
2. Press cartridge into filter retainer. It should snap securely into filter retainer. When correctly installed, filter should completely cover face of cartridge. (Fig. 4)
3. To replace filter, remove retainer by lifting on TAB.

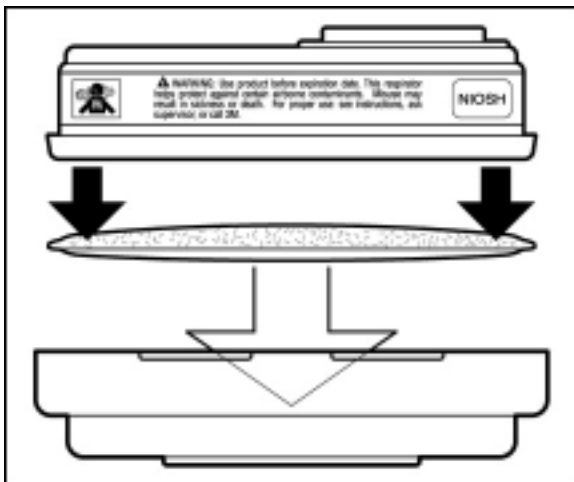

Fig. 4

### 3M™ Adapter Assembly 502

1. Align adapter over cartridge. Engage front snap by squeezing front of cartridge and adapter together, placing thumbs of both hands over top of adapter and fingers along bottom sides of cartridge. (Fig. 5)
2. Engage back snap by squeezing back side of cartridge and adapter together using the same hand positions. An audible click should be heard as each snap is engaged. (Fig. 6) **The 3M adapter assembly 502 should not be removed or reused once engaged. It is not designed for reuse. Removal or reuse may result in leakage, over exposure, sickness or death.**

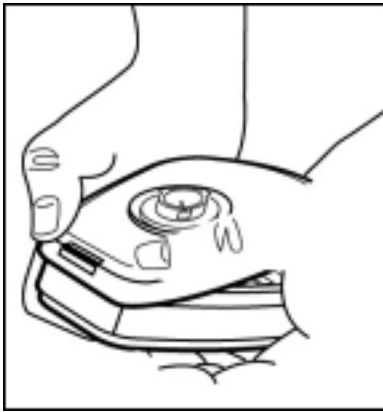

Fig. 5

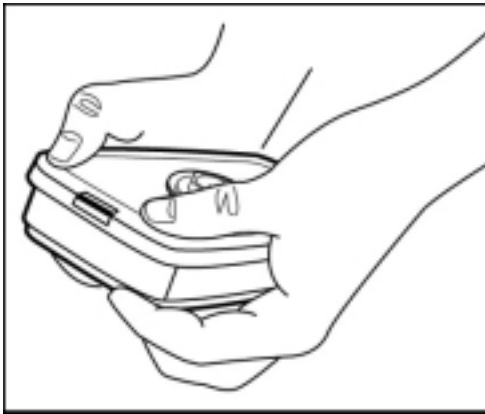

Fig. 6

### 3M™ 2000 Series and Filters 7093/3M™ Adapter Assembly 502

Place filter onto the filter holder so that filter comes into even contact with gasket. Twist clockwise one quarter, turn until it is firmly seated and filter cannot be turned further. Repeat for second filter.

**Note: The adapter assembly 502, once installed on a 3M™ 6000 Series Cartridge, is not to be removed or reused. Removal and reuse may result in leakage over exposure, sickness or death.**

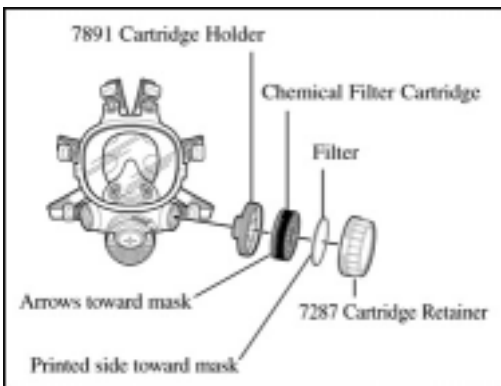

Fig. 7

### 3M™ 7000 Series Retainers, Filters, and Cartridges

3M™ 7000 Series Filters/Cartridges can be attached directly to the 3M™ Cartridge Holder 7891 using appropriate retainers.

1. 3M™ 7000 Series Chemical Cartridge arrows must point towards the facepiece. If the 3M™ N95 Filter 7N11 is needed, place the filter on top of the cartridge with the printed side towards the cartridge. If the 3M™ P100 Filter 7090 is needed, place the filter 7090 on top of the cartridge with the black gasket towards the cartridge. Secure assembly with 3M™ Cartridge Retainer 7287. (Fig. 7)
2. When used alone, the P100 Filter 7090 must be placed with the gasket facing the facepiece. Secure the filter with the 3M™ Retainer 7288. (Fig. 8)
3. When used alone, the N95 filter 7N11 must be placed into cartridge holder 7891S with printed side towards the facepiece. Secure the filter with a 3M™ Retainer 7289.

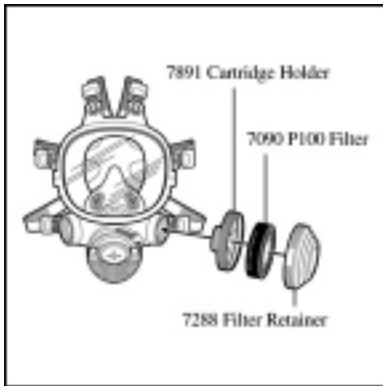

Fig. 8

### 3M™ Responder Cartridge and Canister Assembly

Important *User Instructions* on proper use and use limitations are included with the CP3N Canister 450-02-11R06 and Cartridge FR-64. Remove the Cartridge Holders 7891 or Cartridge/Filter Adapters 701 from facepiece. Before installing the canister/cartridge, check that the gasket is in place and in good condition. Screw the responder canister/cartridge into the DIN Port Adapter and tighten with moderate hand pressure.

In the remaining inlets, ensure that gaskets have been properly installed and are not warped or torn. Securely fasten 3M™ Plugs 7890 on top of the gaskets.

### 3M™ Powered Air-Purifying Systems

Refer to the appropriate PAPR System *User Instructions* for proper assembly.

### 3M™ Supplied Air Systems



U.S. OSHA Standard 29 CFR 1910.134 requires that employers provide breathing air for supplied air respirator systems which shall “meet at least the requirements of the specification for Grade D breathing air as described in the Compressed Gas Association Commodity Specification ANSI/CGA G-7.1-1997.” Testing of output air from a compressor against this standard is required prior to using with a supplied air respirator. In Canada, breathing air systems must be supplied with air which meets at least the requirements in Table 1 of CSA Standard Z180.1-00. **Failure to do so may result in sickness or death.**

### 3M™ Airline/Air-Purifying Assembly

If required, attach 3M™ 2000, 6000 or 7000 Series Cartridges/Filters according to previous instructions. If cartridges/filters are not required, remove Adapters 701 or Cartridge Holders 7891. Screw 3M™ Full Face Plugs 7890 into both sides of the facepiece.

### 3M™ Breathing Tube Assembly W-3188

1. Remove 3M™ Full Face Plug 7890 and screw in 3M™ Adapter W-3187 into center opening. (Fig. 9)

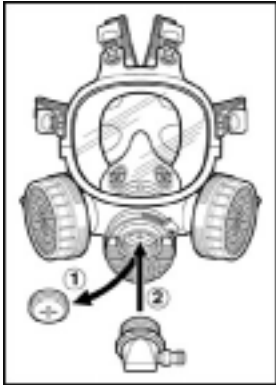

Fig. 9

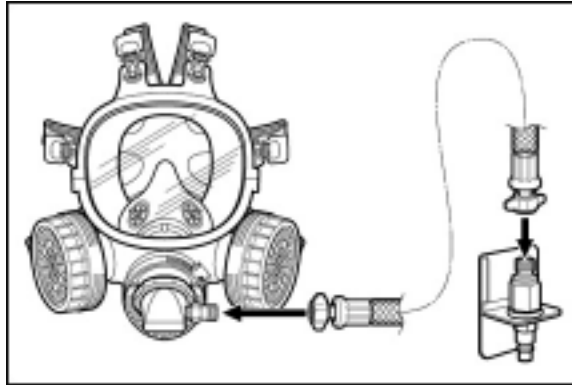

Fig. 10

2. Connect 3M™ Breathing Tube W-3188 to adapter. (Fig. 10)
3. Connect 3M™ Breathing Tube W-3188 to air regulator valve. (Fig. 10)
4. Check all attachments for secureness. See *User Instructions* included with air regulating valves for further information.

### 3M™ Breathing Tube Assembly W-3264

1. Remove Full Face Plug 7890 and screw in 3M™ Breathing Adapter Tube W-3264 into center opening. (Fig. 11)

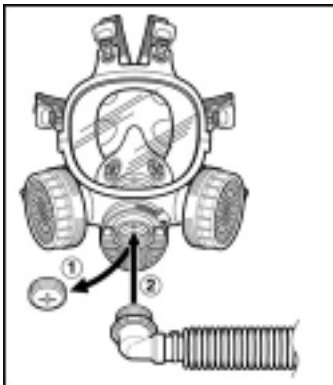

Fig. 11

2. Connect the other end of breathing tube to either the 3M™ W-2909CV (high pressure) or 3M™ W-3032CV Regulator and secure with clamp. (Fig. 12)

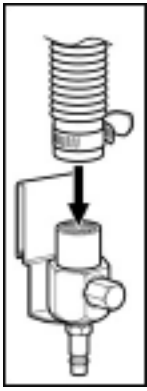

Fig. 12

3. Check all attachments for secureness prior to each use. See *User Instructions* included with air regulating valves for further information.

### 3M™ Dual Airline System

**Note:** See the Dual Airline *User Instructions* for complete details on use, cleaning, and maintenance.

#### **⚠ WARNING**

To meet the U.S. National Institute for Occupational Safety and Health (NIOSH) requirement for minimum (4cfm/115 lpm) and maximum (15cfm/424 lpm) airflow, the air control valves approved for use with the 3M™ 7000 Series Respirators must be operated within the supply pressure ranges and hose lengths stated in *User Instructions* with air regulating valves. **Failure to do so may result in sickness or death.**

## FITTING INSTRUCTIONS

**Must be followed each time respirator is worn.**

### Donning Respirator



Fig. 13

1. Fully loosen all six headstraps, place facepiece on face and pull head harness to back of head. (Fig. 13)

2. Pull the ends of the six straps to adjust tightness, starting with the neck straps first followed by the temple straps and finally forehead straps. Do not overtighten the headstraps. (Fig. 14)
3. Perform a positive and/or negative pressure user seal check each time the respirator is donned.

## **User Seal Checks**

**Always check the seal of the respirator on your face before entering a contaminated area.**

### **Positive Pressure User Seal Check**

1. Place the palm of the hand over the exhalation valve cover and exhale gently. (Fig. 15)
2. If the facepiece bulges slightly and no air leaks are detected between the face and facepiece, a proper fitting has been obtained.
3. If air leakage is detected, reposition the respirator on your face and/or readjust the tension of the straps to eliminate leakage, and recheck seal.

**If you cannot achieve a proper seal, DO NOT enter the contaminated area. See your supervisor.**

### **Negative Pressure User Seal Checks**

#### **3M™ 6000 and 7000 Series Cartridges/Filters**

1. Place palms of hands to cover face of cartridge or open area of filter retainers and inhale gently. If you feel facepiece collapse slightly and pull closer to your face with no leaks between the face and facepiece, a proper seal has been obtained. (Fig. 16)
2. If faceseal air leakage is detected, reposition the respirator on your face and/or readjust the tension of the straps to eliminate leaking, and recheck seal.

**If you cannot achieve a proper seal, DO NOT enter the contaminated area. See your supervisor.**

#### **3M™ 2000 Series Filters**

1. Place your thumbs onto the center portion of the filters, restricting airflow through filters and inhale gently. If you feel facepiece collapse slightly and pull closer to your face with no leaks between the face and facepiece, a proper seal has been obtained. (Fig. 17)
2. If faceseal air leakage is detected, reposition the respirator on your face and/or readjust the tension of the straps to eliminate the leakage, and recheck seal.

**If you cannot achieve a proper seal, DO NOT enter the contaminated area. See your supervisor.**

#### **3M™ Filter 7093**

1. Using both hands press or squeeze filter covers toward facepiece and inhale gently. If you feel facepiece collapse slightly and pull closer to your face with no leaks between the face and facepiece a proper seal has been obtained.
2. If faceseal air leakage is detected, reposition the respirator on your face and/or readjust the tension of the straps to eliminate the leakage.

**If you cannot achieve a proper seal, DO NOT enter contaminated area. See your supervisor.**

**Note:** Before assigning any respirator to be worn in a contaminated area, a qualitative or quantitative fit test must be performed per the local requirements or OSHA Standard 1910.134.

### **3M™ GVP and Face-Mounted PAPR**

User must follow *User Instructions* for PAPR units.

### **3M™ Dual Airline**

User must follow *User Instructions* for Dual Airline Supplied Air Respirators.



Fig. 14



Fig. 15



Fig. 16



Fig. 17

## FIT TESTING

**Note:** Fit testing is a U.S. OSHA and Canadian CSA Z94.4 standard requirement. Therefore, either quantitative or qualitative fit testing must be conducted prior to the respirator being issued.

Quantitative Fit Testing (QNFT) can be conducted using a 3M™ Fit Test Adapter 601 and 42 CFR 84 P100 filters such as the 3M™ P100 Particulate Filters 2091 or 7093.

Qualitative Fit Testing (QLFT) with the 3M™ Qualitative Fit Test Apparatus FT-10 or FT-30 can be conducted using any of the NIOSH approved 42 CFR 84 Particulate filters.

**Note:** For further information concerning fit testing, contact 3M OH&ESD Technical Service at 1-800-243-4630 or a 3M location in your region. In Canada call Technical Service at 1-800-267-4414.

To conduct QNFT with round retainer type filters, the 3M™ Fit Test Adapter 7930 is needed.

## INSPECTION, CLEANING AND STORAGE

### Inspection Procedure

This respirator must be inspected before each use to ensure it is in good operating condition. Any damaged or defective parts must be replaced before use. The following procedure can be used as a guideline.



1. Check the faceseal for cracks, tears and dirt. Examine the inhalation valves for signs of distortion, cracking or tearing.
2. Check that the headstraps are intact and have good elasticity.
3. Examine all plastic parts and gaskets for signs of cracking or fatiguing and replace if necessary.
4. Remove the exhalation valve cover and examine the exhalation valve and seat for signs of dirt, distortion, cracks or tears.
5. Replace the valve if necessary. Secure the valve cover prior to use. (Fig. 18) Examine the lens for signs of cracking or other damage. Replace if necessary.

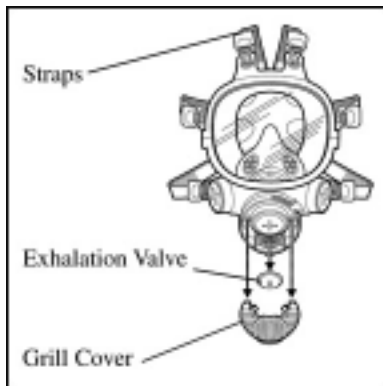

Fig. 18

## Cleaning and Storage

Cleaning is recommended after each use.

### WARNING

**Do not clean respirator with solvents.** Cleaning with solvents may degrade some respirator components and reduce respirator effectiveness. Inspect all respirator components before each use to ensure proper operating condition. **Failure to do so may result in sickness or death.**

1. Remove cartridges, filters and/or breathing tubes. The center adapter, lens and faceseal can also be removed if necessary.
2. Clean facepiece (excluding filters and cartridges), by immersing in warm cleaning solution, water temperature not to exceed 120° F (49° C), and scrub with soft brush until clean. Add neutral detergent if necessary. Do not use cleaners containing lanolin or other oils.
3. Disinfect facepiece by soaking in a solution of quaternary ammonia disinfectant or sodium hypochloride (1 oz [30 ML] household bleach in 2 gallons [7.5 L] of water), or other disinfectant.
4. Rinse in fresh, warm water and air dry in noncontaminated atmosphere.
5. Respirator components should be inspected prior to each use. A respirator with any damaged or deteriorated components should be repaired or discarded before use.
6. The cleaned respirator should be stored away from contaminated areas when not in use.

## **REPLACEMENT PART INSTRUCTIONS**

Respirator parts should be inspected prior to each use. Replace worn or deteriorated parts with new parts.

### **3M™ Lens 7884**

The lens should be inspected for cracking or crazing. Replace if necessary. Replace as follows: Remove two screws on either side of lens with a Phillips screwdriver, remove the top and bottom lens frame and remove the lens. To reassemble, first align the center of the lens with the centerline of the facepiece. The center of the lens is marked by two small lines, one at the top center and second at the bottom center of the lens. Place the lens into the facepiece and then reattach the lens frame. Replace the two center screws and tighten.

### **3M™ Exhalation Valve Cover 7918 and Exhalation Valve 7283**

Remove the 3M™ Exhalation Valve 7918 cover by lifting out on the two top prongs on either side of the center opening and sliding down. Remove the exhalation valve by grasping and pulling on the edges of the valve. Replace the valve if it is warped, distorted, cut, split or if it will not seal tightly on the valve seat. Replace by pushing the valve onto the exhalation valve post.

### **3M™ Speaking Diaphragm Kit 7895**

Remove the nose cup. Using the diaphragm removal tool, turn diaphragm retaining ring counter clockwise and remove. Push diaphragm assembly out of the facepiece from underneath using the eraser end of a pencil or a similar object. Check the speaking diaphragm gasket for damage or deformation. To replace the diaphragm, follow the steps in reverse.

**Note:** The grill pattern with deep indentation in the center should be visible from inside the respirator.

### **3M™ Removable DIN Connector 7886**

Hold the inside part of the connector secure, grasp the outside of the connector and twist counter clockwise to remove. To replace the connector, press the inner section into the facepiece until the end of the threads are flush with the facepiece exterior, then screw on the outer piece by turning clockwise.

### **3M™ Inhalation Valves 7282**

Grasp the edges of the valve and pull away from the plastic post. Replace if the valve is distorted, cut, split or cannot be sealed on the valve seat. If the valve seat is damaged, replace the 3M 7886.

### **3M™ Air Inlet Gasket 7999**

Remove the gasket from the air inlet opening base. Replace the gasket if it is warped, distorted, cut, split or cannot be reassembled into the air inlet. To replace, position the gasket so the small cut-out on the gasket is pointing toward the lens. Push the gasket groove onto the plastic bar and seat the gasket.

### **3M™ Inhalation Valve Gaskets 7887**

Remove the gaskets from each side of the facepiece. Replace the gaskets if they are warped, distorted, cut or split. Replace one gasket on each side of the facepiece. Be sure the gasket is flat and seated correctly.

### **3M™ Nose Cup Valves**

The nose cup valves are supplied as a complete 3M™ Nose Cup Valve Assembly 7882. Remove the nose cup valves if they become warped, torn or otherwise damaged. Replace the valves in the nose cup such that the post points away from the nose.

### **3M™ Cartridge Holder Gasket**

Replace 3M™ 7891 Cartridge Holder if gasket is warped, distorted, cracked or split.

### **3M™ Inhalation Port Gasket Replacement 6895**

Replace if gasket is warped, distorted, cracked or split.

#### **NBC Safety**

World Leaders in Defense Technology

fax: (858) 488-6320 tel: (858)488-3300 sales@NBCsafety.com www.NBCsafety.com

Download from [www.Somanuals.com](http://www.Somanuals.com). All Manuals Search And Download.

## Free Manuals Download Website

<http://myh66.com>

<http://usermanuals.us>

<http://www.somanuals.com>

<http://www.4manuals.cc>

<http://www.manual-lib.com>

<http://www.404manual.com>

<http://www.luxmanual.com>

<http://aubethermostatmanual.com>

Golf course search by state

<http://golfingnear.com>

Email search by domain

<http://emailbydomain.com>

Auto manuals search

<http://auto.somanuals.com>

TV manuals search

<http://tv.somanuals.com>