

ACCU-CHEK™ Spirit

INSULIN PUMP SYSTEM

Pump User Guide



ACCU-CHEK™ Spirit
insulin pump



Dear ACCU-CHEK™ Spirit insulin pump owner,

Thank you for choosing the ACCU-CHEK Spirit insulin pump.

This guide will help you to get the most from your ACCU-CHEK Spirit insulin pump. Even if you have used an insulin pump before, it's important that you do these things before you use the ACCU-CHEK Spirit insulin pump:

- ▶ *read this guide carefully*
- ▶ *work with your doctor or healthcare team to understand how to use the pump*
- ▶ *test your blood glucose level often to find your personal settings and to avoid getting the wrong dosage of insulin. (An ACCU-CHEK blood glucose meter is one way to test blood glucose levels; talk to your doctor or healthcare team to decide the best way for you.)*

It's a good idea to inform family members or friends about diabetes and pump therapy so that they can help you in an emergency.

*Disetronic Medical Systems is proud to help you manage your diabetes therapy. However, Disetronic Medical Systems cannot recommend specific diabetes therapy. Always follow the instructions given to you by your doctor or healthcare team. If you have questions about your pump, or problems with it, refer to this guide and talk to your doctor or healthcare team. We also invite you to contact Pump Support at **1-800-688-4578**.*

Note:

Your insulin pump is a valuable medical device. Consider adding your pump to your homeowner's insurance policy to protect you in case it is damaged or lost. Ask your insurance agent for details.

How to use this guide

This guide is for version 2.XX of the ACCU-CHEK Spirit insulin pump.

Note:

This user guide presents you with sample screens. The screens in this user guide may look slightly different from your pump screens. If you have questions about what you see on your pump, contact Pump Support at 1-800-688-4578.

When you become familiar with your pump, you can quickly refer to the back of this user guide for tables and definitions that can help you to understand pump alerts and warnings, and the symbols on the pump screen. There is also a glossary at the back that defines terms used in this guide, and a table that lists the technical specifications for your pump. All of this information can help you and your doctor or healthcare team to understand the pump and use it to best manage your insulin pump therapy.

Warnings and Cautions

Read all warnings and cautions in this guide before you use the pump. This information is important to protect your health and the function of your pump. If you have any questions about a warning or caution, contact Pump Support at 1-800-688-4578. Warnings and Cautions are indicated by triangles.



WARNING

WARNINGS are indicated by a triangle and the word **WARNING**.



CAUTION

CAUTIONS are indicated by a triangle and the word **CAUTION**.

Working safely with your ACCU-CHEK Spirit insulin pump

Your ACCU-CHEK Spirit insulin pump meets the safety requirements of national medical device legislation and meets or exceeds the international standards for Electromagnetic Compatibility regarding the pump's use. This section introduces you to the intended use of the ACCU-CHEK Spirit insulin pump, to its safety features, and to warnings and safety information you need to know while using your pump.

While your pump is in use, two internal safety systems monitor and control the pump's functioning. The pump performs more than nine million safety checks every day. If your pump detects a change from its normal state, an alert or an error message is delivered.

See the sections "Alerts and Errors" (page 147) and "Appendix A: Technical Data" (page 165) for information on how to address errors and alerts.

Intended use of your ACCU-CHEK Spirit insulin pump

The ACCU-CHEK Spirit insulin pump is intended for the subcutaneous continuous delivery of insulin, at set and variable rates, for the management of diabetes mellitus in persons requiring insulin as prescribed by a physician.

The ACCU-CHEK Spirit insulin pump is intended for the use of U100 rapid-acting insulin.

Guarantee

Any changes or modifications to the ACCU-CHEK Spirit insulin pump that are not expressly approved by Disetronic Medical Systems, Inc. could void the pump warranty. Do not try to fix the device yourself.

Contents

Chapter 1: Understanding Your New System	9
The ACCU-CHEK Spirit Insulin Pump	9
Display	9
Backlight	10
Keys and Key Combinations	11
Screens	13
STATUS Screen Messages, Beeps, and Vibrations	15
Alarm Signals	16
Accessories and Disposables	17
Emergency Kit	23
Chapter 2: Getting Started	25
Inserting (or Changing) the Battery	25
System Check Start-Up Process	28
Setting Time and Date	32
Your Personal Settings	35
Your Basal Rate Profile	36
Programming Your Basal Rate Profile	37
Preparing the Cartridge	42
Connecting the Cartridge, Adapter, and Infusion Set	47
Inserting the Cartridge	49
Priming the Infusion Set	53
Preparing the Infusion Site and Inserting the Infusion Set	56
Chapter 3: Using Your Pump	59
Before Using	59
Wearing Your Pump	59
When Not to Wear Your Pump	61
Your Insulin Pump and Water	63
Starting Insulin Delivery	65
Stopping Insulin Delivery	66
Interruption of Insulin Pump Therapy	68

Changing the Infusion Set	70
Changing the Cartridge and Infusion Set	73

Chapter 4: Boluses and Temporary Basal Rates 75

Understanding Boluses	75
Programming a Standard Bolus	77
Programming an Extended Bolus	83
Programming a MultiWave Bolus	88
Programming a Temporary Basal Rate (TBR)	93

Chapter 5: User Menus 99

Selecting a User Menu	100
STANDARD User Menu	103
Data Transfer	104
Setup for Data Transfer	105
Reviewing Pump Data	107
SETUP MENU Standard	113
ADVANCED User Menu	122
Basal Rate Profiles	123
Alarm Clock	127
SETUP MENU Advanced	129
CUSTOM User Menu	136

Chapter 6: Care and Maintenance 137

Care of Your ACCU-CHEK Spirit Insulin Pump	137
System Inspection Checklist	137
What to Do When You Drop Your Pump	139
Storing Your ACCU-CHEK Spirit Insulin Pump	140
Disposal	140
Maintenance	141
Repair	142
Troubleshooting	143

Chapter 7: Alerts and Errors	147
Confirming an Alert or Error	148
List of Alerts	149
List of Errors	154
Appendixes	165
Appendix A: Technical Data	165
Appendix B: Configuration Parameters	177
Appendix C: Abbreviations	180
Appendix D: Beeps and Melodies	181
Appendix E: Vibrations	182
Appendix F: Symbols	183
Appendix G: Sterile Products and Accessories	188
Appendix H: Glossary	190
Warranty	194
Index	195
Diagram of User Menus	198
Quick Reference Table for Alerts	199
Quick Reference Table for Errors	200

This page left blank intentionally.

Chapter 1: Understanding Your New System

The ACCU-CHEK Spirit Insulin Pump

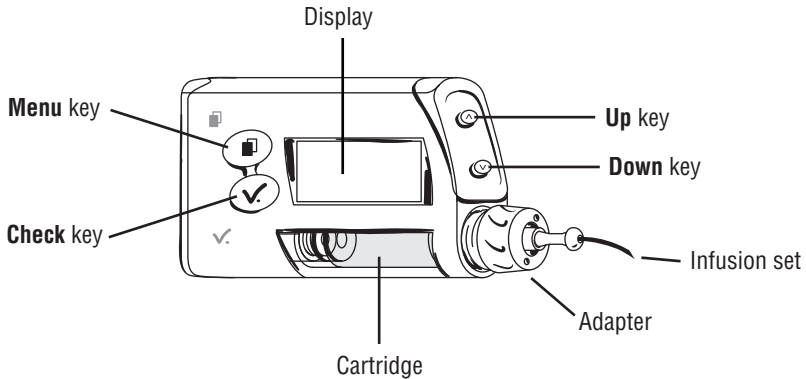

CAUTION

Check your insulin pump and its sterile products, like an infusion set and accessories, at least every three hours. Immediately inspect your insulin pump if it is dropped. Do not use your insulin pump if chips or cracks are visible. Chips and cracks may allow water, dust, insulin, or other foreign substances to enter your insulin pump and lead to malfunction.

Display

Your insulin pump has a Liquid Crystal Display (LCD) screen that displays important information. Check the display at least every three hours during the day, before you go to sleep, and if you are not able to hear the beeps or alerts or feel the vibrations. This is the only way you will be aware of important changes in your pump.



CAUTION

If you discover incomplete characters, numbers, or symbols on the display, put your insulin pump into **STOP** mode and perform a system check by simply removing the battery for a few seconds. When you reinsert the battery the system check will occur. If the incomplete characters, numbers, or symbols remain, your insulin pump may need to be returned since you may not receive the correct information for operating your pump. Put your insulin pump into **STOP** mode and contact Pump Support at 1-800-688-4578 immediately.

Note:

To make the display easier to read, you can flip the display orientation by 180° and adjust the display contrast lighter or darker. See the sections “Display Orientation” (page 120) and “Display Contrast” (page 135) for more information.

Backlight

The backlight helps you to see the display in poorly lighted areas. You can turn on the backlight from the **RUN** screen, from the **STOP** screen, or when you are browsing the menus. Press the  key to turn on the backlight. The backlight turns itself on when an alert or an error message appears. The backlight turns itself off after 30 seconds if no keys are pressed.

Hint:

Start programming with the  key in areas of poor lighting as this will also turn on the backlight.

Keys and Key Combinations

The pump will beep each time a key is pressed, unless the beep tone is set to 0.



CAUTION

Never press any of the keys with a sharp or pointed item such as the tip of your fingernail. This could damage the casing of your insulin pump. Use the pad of your fingertip instead to avoid puncturing the keys.

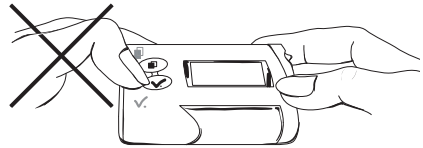
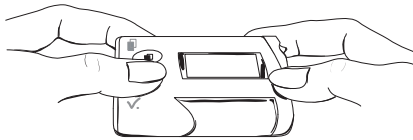







Single Keys

Each key has a specific function when it is pressed by itself. The following table describes the function of each.

Key	Name	Function
	Menu	scrolling through menus, functions, and information screens
	Check	<ul style="list-style-type: none">• selecting a menu• saving changes and exiting screen• viewing the QUICK INFO screen
	Up	<ul style="list-style-type: none">• increasing a setting• moving forward in the information screens• turning on the backlight
	Down	<ul style="list-style-type: none">• decreasing a setting• moving backward in the information screens







Either or can be used for programming or cancelling a Standard bolus. Pressing either key for 3 seconds (until you hear a melody) will also temporarily turn off the STOP-Warning.

Note:

Increase or decrease the values by pressing the  or  keys. If you want to make large changes to a value, in most cases you can do this faster by pressing and holding down the  or  key (scrolling) until the number you want is displayed. If needed, the value can still be corrected by a single press of the  or . Your pump will beep once when you start scrolling.

Key Combinations

Keys can be pressed in pairs for additional functions. In the following table, a plus symbol (+) between 2 keys means that both keys must be pressed simultaneously.

Combination	Function
 + 	<ul style="list-style-type: none">• exiting menus, function screens, and information screens without saving• moving backwards to a previous menu
 + 	unlocking the keys (press and hold both keys until you hear three beeps in RUN mode and one beep in STOP mode.)
 + 	copying an hourly basal rate to the next hour(s)



WARNING

If the keys on your pump are not functioning properly, or you are not able to identify them correctly, disconnect your insulin pump and contact Pump Support at 1-800-688-4578.

Locking Keys Using KeyLock Feature

The KeyLock feature lets you lock all four keys on your pump as a safety measure against accidentally activating functions. You may want to use this function while sleeping, or during sports, for example. The KeyLock function is turned on in the STANDARD SETUP MENU. All instructions in this user guide are given on the assumption that the KeyLock is off. For more information see the section “Turning KeyLock On or Off” (page 113).

Screens

Your pump displays various screens on its display for you to access information and functions.

RUN Screen

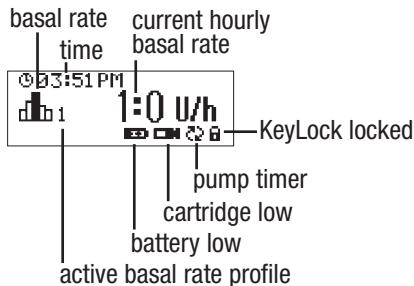

During normal use, your pump is in **RUN** mode and insulin is delivered into your body based on the basal rate you have programmed. The **RUN** screen is the “home” screen and is displayed when the pump is in **RUN** mode. After you program or review information, the pump returns to the **RUN** screen. This screen shows the current time, the current basal rate profile, and the current hourly basal rate in units per hour. The **RUN** screen will also display reminder information (such as “cartridge low”) and special functions (such as KeyLock locked or unlocked) in the form of symbols.

See the sections “Starting Insulin Delivery” (page 65) for instructions on starting your pump and “Appendix F: Symbols” (page 183) for more information about the symbols.

STOP Screen

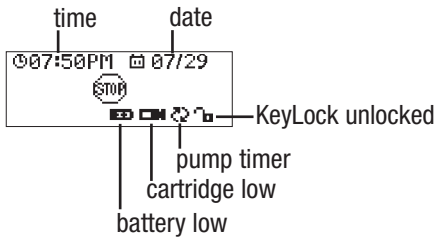

The **STOP** screen shows the current time and date, the **STOP** symbol, reminder information (such as “battery low”), and special functions (such as KeyLock locked or unlocked). Some functions must be programmed while your pump is in **STOP** mode, when insulin is not being delivered. Your pump must also be in **STOP** mode before you can change cartridges. Additionally, always disconnect your pump from the infusion site and place the pump in **STOP** mode when you prime the infusion set and/or when you transfer data. See the section “Stopping Insulin Delivery” (page 66) for instructions on stopping your pump.

QUICK INFO Screen

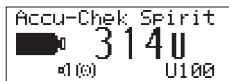







If you press the  key from the **RUN** or **STOP** screen, your pump displays the remaining cartridge content in units. Symbols for activated functions and features (like the beep and vibration alarm signals) are displayed. Your pump will return to the **RUN** or **STOP** screen after 8 seconds.

Information, Function, and Setup Screens





You will need to access various screens so you can view stored information, program the pump, perform a function, or change a setting. You can reach these screens from either the **RUN** or **STOP** screen.

Follow the steps below to navigate through the screens.

1. Press the  key to move to a screen displaying your first choice. Think of these screens as menu choices.
2. Press the  key again to see your next choice on the menu. After you reach the last menu choice you will “loop” back to the first menu choice.
3. When you reach the screen displaying the choice you want (e.g., SET THE TIME AND DATE), press . The next set of screens are called function screens. They all relate to the choice you made. There may be only one function screen or multiple screens.
4. Press the  or  key to increase or decrease the selected value. Or, press the  key again to move to the next function screen you want to change. After you reach the last function screen you will “loop” back to the first function screen.
5. Press  to save your changes. The pump returns to the **RUN** or **STOP** screen and the changes are saved.

Note:

The menu choices that appear depend on the menu that is selected. Your pump can display a Standard, Advance, or Custom user menu. See the section “User Menus” (page 99) for more information.

Pressing  +  simultaneously lets you move backwards in the menu structure or to return to menus you just skipped. If you are within a function screen, pressing  +  simultaneously lets you move up to the corresponding menu without saving the current changes.

STATUS Screen Messages, Beeps, and Vibrations

Beeps, vibrations, and messages on the display inform you of the status of your insulin pump. Beeps and/or vibrations are used as alarm signals. Your insulin pump also beeps when a key is pressed unless the beep volume is turned off. The beep volume can be turned up or down.



WARNING

Check the display of your insulin pump at least every three hours during the day and before you go to sleep, especially if for any reason you are unable to hear the beeps or feel the vibrations. This is the only way you will be notified of changes in your insulin pump in a suitable amount of time.



Alarm Signals

Your pump gives alerts and errors using beeps and vibrations. You can turn off either the beep or the vibrations but for your safety you cannot turn off both at the same time for the initial alarm signal. See the sections “Alerts and Errors” (page 147), “Adjusting the Beep Volume” (page 116), and “Setting Up Alarm Signals” (page 117) for more information.

STOP-Warning

The STOP-Warning is turned on by the pump each time your pump switches from **RUN** mode to **STOP** mode, and when a battery is inserted. The STOP-Warning is a long beep and a vibration occurring every minute. This warns you that insulin delivery has been interrupted.

To Turn Off the STOP-Warning

Press either  or  for 3 seconds to turn off the STOP-Warning. A melody plays indicating the STOP-Warning is turned off.

Note:

The volume of the STOP-Warning cannot be changed. It is independent of the programmed beep volume.

Accessories and Disposables

Sterile products and accessories are a crucial part of the ACCU-CHEK Spirit insulin pump system and therapy. These products are designed for safe and simple insulin pump therapy. Always follow the instructions given by your doctor or healthcare team for the use of all system components.

Use your ACCU-CHEK Spirit insulin pump, sterile products, and accessories for the first time in the presence of your doctor or healthcare team.

Sterile Products

Each sterile product should be used only once. Reusing these products could lead to infection or could damage your pump. Do not use a sterile product if the package is damaged or opened.

Sterility is guaranteed up to the indicated expiration date for all ACCU-CHEK sterile products that are in the original, unopened packaging.



WARNING

Your insulin pump was designed for use with U100 insulin. Only use sterile products and accessories that are designed for use with your insulin pump. The proper functionality of your insulin pump can only be guaranteed if you use ACCU-CHEK brand sterile products and ACCU-CHEK Spirit accessories. All ACCU-CHEK brand sterile products and accessories designed for the ACCU-CHEK Spirit insulin pump have been thoroughly tested and approved for use with your insulin pump. Other sterile products and accessories have not been tested for compatibility with your insulin pump and, if used, may therefore endanger your health or void your warranty.



CAUTION

Always have extra sterile products and accessories with you. This allows you to exchange components when needed. Materials designed for single use (such as cartridges and infusion sets) should not be reused due to the increased risk of infections, malfunctions, and/or incorrect insulin delivery.

See Disetronic Medical Systems' sterile products and accessories catalogs and brochures for more information. Or, contact Pump Support at 1-800-688-4578.



WARNING

Your insulin pump and its sterile products and accessories include small component pieces that could pose a choking hazard to children. Keep sterile products and accessories out of the reach of children.

Cartridges

Your pump is designed to use ACCU-CHEK 3.15 ml plastic cartridges to hold insulin. Do not reuse a cartridge. Reusing sterile products could lead to infection or could damage your pump.

ACCU-CHEK 3.15 ml plastic cartridges come with a protective cartridge cap, as well as a filling needle and plunger rod to aid in filling.

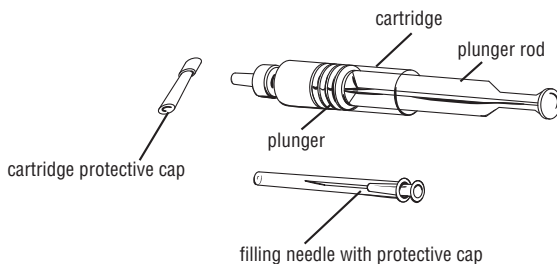



The cartridges are sterile products intended for single use only.

WARNING

Infusion Set

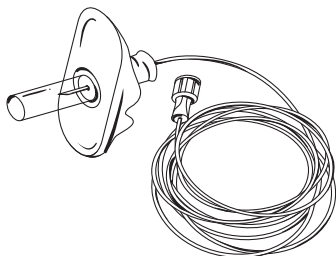

An ACCU-CHEK infusion set connects your pump to your body to deliver insulin. The insulin travels from the cartridge in your insulin pump through the infusion set into your body. The cannula or needle of the infusion set is placed under the skin, usually in the abdominal area.

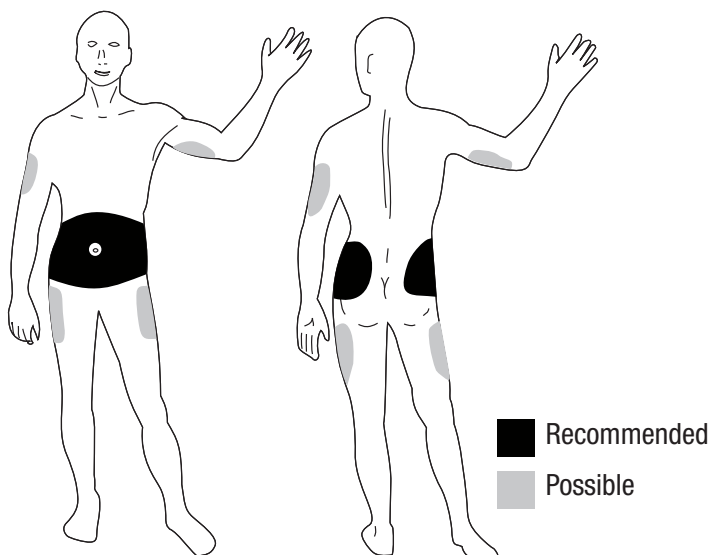

Use only infusion sets that have a luer-lock connector. All current ACCU-CHEK infusion sets have luer-lock connectors and are the preferred choice for use with your ACCU-CHEK Spirit insulin pump. All ACCU-CHEK infusion sets are PVC free, are skin-friendly, and do not affect insulin. The diameter of the ACCU-CHEK infusion set tubing is small for fast priming and minimal waste of insulin.

ACCU-CHEK infusion sets come in a wide range of lengths from 60 cm (24 inches) to 110 cm (43 inches). Choose your tubing length based on how you wear your pump. Please refer to the infusion set instructions for proper usage and priming volumes.

Adapter

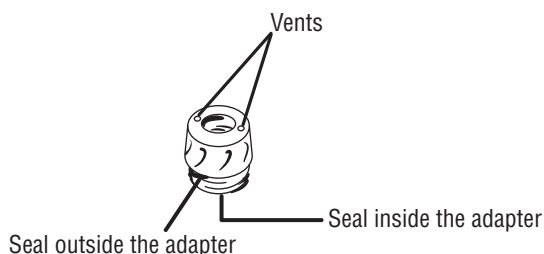

The adapter connects the cartridge to the infusion set. It has two seals to keep water from getting into the cartridge compartment. Two vents on the adapter allow air pressure to equalize. The adapter will not work properly if the vents are plugged, dirty, or if the seals are worn or missing.

Change the adapter with at least every 10th cartridge change. Also change the adapter if the seals become worn, lost, or if the vents become plugged.

Battery



Your pump runs on one AA battery. Use **AA alkaline** batteries that have a minimum capacity of **2500 mAh**. Do not use lithium, carbon zinc, or nickel cadmium (NiCd) batteries. If you prefer to use **rechargeable batteries**, use **NiMH** batteries that have a minimum capacity of **1500 mAh**. If you use rechargeable batteries, always use a battery charger recommended by the battery manufacturer. Keep extra batteries on hand.



CAUTION

Using batteries other than those recommended by Disetronic Medical Systems may significantly reduce battery usage time. Batteries other than those recommended could leak and corrode the battery contacts within your insulin pump. Therefore, using batteries not supplied or recommended by Disetronic Medical Systems, Inc. may void the warranty.

The operating temperature of the battery must be between 41°F and 104°F (+5°C and +40°C). The life of any battery is affected by how you use your insulin pump, your personal settings, delivery rates, temperature and other factors. With typical pump use [50 U/day using U100 insulin; operating temperature 72°F ± 6°F (22°C ± 3°C)], pump battery life is about four weeks using alkaline batteries and one week using rechargeable batteries.

Note:

You must set the battery type to match the kind of battery you are using. If you do not set the correct battery type on your pump, the alert A2: BATTERY LOW may not give you enough time to replace your battery. If you change from using regular batteries to rechargeable batteries, or from rechargeable batteries to regular batteries, you must change the battery type setting in the Standard setup menu (SETUP MENU STANDARD).



CAUTION

Always make sure that you remove the battery if your insulin pump is not in use for a long time period in order to preserve the battery lifetime. To prevent water from entering the casing, change the battery only in a dry area. Make sure that the seal of the battery cover is not worn out or missing, and that the battery is properly inserted.

Battery Cover

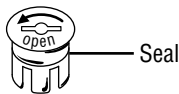

The battery cover seals the battery compartment. Change the battery cover with at least every 4th battery change.

- Remove the battery cover only in a dry area to prevent water from getting inside the pump.
- Make sure that the seal is not worn or missing and that the battery is properly inserted into the pump.
- Tighten or loosen the battery cover using only the ACCU-CHEK Spirit insulin pump battery key. Knives, screwdrivers, or other sharp objects may harm your pump.
- Do not over-tighten the battery cover. The battery cover is correctly inserted and tightened when it is even with the pump casing.

Battery Key

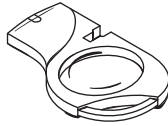

The battery key tightens and loosens the battery cover. It can also loosen the luer-lock connection between the infusion set and adapter if it cannot be loosened by hand. However, never use the battery key to attach or to tighten an infusion set.

The battery key has a notch that fits all ACCU-CHEK infusion set luer-lock connectors. The battery key should be replaced if it cracks, becomes worn, or if it is lost.

Emergency Kit

It is a good idea to carry supplies in case of an emergency so that you can exchange parts if you need to. An emergency kit might contain:

- A new ACCU-CHEK infusion set
- A new AA alkaline battery
- A new ACCU-CHEK 3.15 ml plastic cartridge
- A pen or syringe for alternate therapy
- A vial of insulin
- A filling aid
- Treatment for low blood glucose levels
- Blood glucose monitoring supplies (such as an ACCU-CHEK blood glucose monitor)
- A disinfectant for skin
- A new site dressing
- The battery key

This list is only an example of what an emergency kit might contain. Ask your doctor or healthcare team what supplies you should keep in your personal emergency kit.

This page left blank intentionally.

Chapter 2: Getting Started

Inserting (or Changing) the Battery

Your pump turns on when you insert the battery. When you remove the battery, your pump still tracks the time and date for about 1 hour. The pump will always store your pump settings (such as the hourly basal rates, bolus increment and active user menu) and event memory (bolus and alarm history, history of daily insulin totals and Temporary Basal Rates) even if the battery power dies and no matter how long your pump is without power.

See the section “Accessories and Disposables – Battery” (page 21) for information on recommended batteries.



WARNING

Keep the Time/Date Settings Correct

Always check that the time and date of your insulin pump are set correctly. The time and date are displayed on the STOP screen. Incorrect programming of the time and date may cause incorrect insulin delivery. If you, your doctor, or healthcare team store and analyze your therapy data electronically and the time and date of the devices used are not set identically, the gathered data might not be meaningful. See the section “Setting Time and Date” (page 32) for more information.



CAUTION

To prevent water from entering the casing, change the battery only in a dry environment. Make sure that the battery seal is not worn out or missing and that the battery is properly inserted. Tighten or loosen the battery cover with the ACCU-CHEK Spirit insulin pump battery key (knives, screwdrivers or other sharp objects may harm your insulin pump). Do not over-tighten as this may cause damage to the battery cover and to the casing. The battery cover is correctly inserted and tightened when the battery cover is level with the insulin pump casing.

Follow the steps below:

1. Press  to move to the STOP YOUR ACCU-CHEK screen.



Press  to select and put the pump in **STOP** mode. Your pump returns to the **STOP** screen and insulin delivery stops.

2. Remove or disconnect your infusion tube set from the headset so that insulin cannot accidentally be delivered.

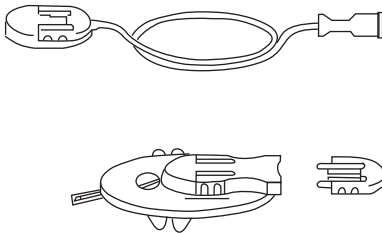

3. Remove the battery cover.

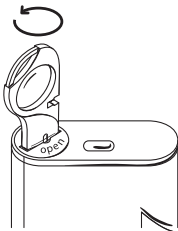

Use the battery key to turn the battery cover as indicated by the arrow on the battery cover. Make sure that the opening of the battery compartment and the seal are clean and undamaged. Remove the old battery if necessary.

4. Put the battery cover on the positive (+) end of the battery.

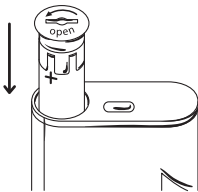

Hold the cover on the positive (+) end of the battery, and insert the battery negative (-) end first into the battery compartment.

5. Use the cover to gently push the battery all the way in.

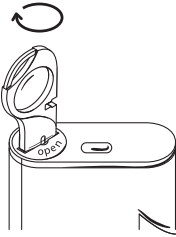

Turn the battery cover clockwise to tighten it. The battery cover is correctly tightened when the outside of it is even with the casing. Do not over-tighten the battery cover.

The pump begins its start-up process.

Note:

If your pump was in **RUN** mode before you removed the battery, an error E8: POWER INTERRUPT will occur when a new battery is inserted. Press  twice to confirm and turn off the error. Check the time and date in the **STOP** screen and correct them, if necessary. See the section “Setting Time and Date” (page 32) for instructions. Put your pump into **RUN** mode if necessary.



CAUTION

Using AA batteries other than those recommended by Disetronic Medical Systems may significantly reduce the battery usage time. Batteries other than those recommended may leak and corrode the battery contacts within your insulin pump. Therefore, using batteries not recommended by Disetronic Medical Systems may void the warranty. Do not insert old or used batteries into your insulin pump as this may cause a failure at the insulin pump start-up.

System Check Start-Up Process

Your pump performs internal tests at start-up when you insert a battery and when you change the cartridge. When you insert a battery the whole start-up process is performed. When only the cartridge is changed, the start-up process begins at the SELF-TEST screen.



WARNING

Do not interrupt the start-up process by pressing keys or by handling the insulin pump. Interruption of the start-up process may lead to malfunctions of your insulin pump.

If your insulin pump does not beep and vibrate as described, or if individual numbers, letters, symbols or lines are shown incompletely or not at all, contact Pump Support at 1-800-688-4578.

Note:

While you are using the pump, its safety system monitors it continuously. If the safety system detects a change from the normal state, an alert (warning instruction) or an error (error message) occurs.

1. Put the pump in **STOP** mode.
2. The ACCU-CHEK logo appears.



3. SELF-TEST appears.



4. Your pump beeps and BEEP TEST appears.

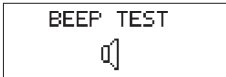

Listen for the beeps.



CAUTION

If you cannot hear the beeps from your insulin pump, you may not be notified of changes with your insulin pump in a suitable amount of time. If you cannot hear the beeps, contact Pump Support at 1-800-688-4578.

5. Your pump vibrates and VIBRATION TEST appears.

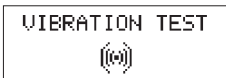

Check for vibrations.



CAUTION

If you cannot feel the vibration alert, you may not be notified of any changes of your insulin pump in a suitable amount of time. If you cannot feel the vibration alert, contact Pump Support at 1-800-688-4578.

6. The display goes blank. Check that the display is empty. (The backlight turns on during this step.)



7. The display shows a pattern. Check that the pattern is even.

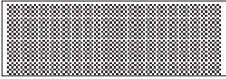



8. The display turns black. Check that the display is completely black.

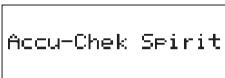

9. You will also see an INFORMATION screen.



10. If your pump detects an alert or error during the start-up process, it signals the error or alert at this point. See the section “Alerts and Errors” (page 147) for more information.

11. A melody signals the end of the start-up process, and the pump shows the **STOP** screen. The STOP-Warning occurs every minute by giving a long beep and a vibration to remind you that no insulin is being delivered in **STOP** mode. Press and hold  or  until you hear a melody to turn the STOP-Warning off.



Note:

If the voltage of the battery is too low, the start-up procedure cannot finish.

Your pump beeps five tones and keeps restarting the start-up procedure until you remove the battery or until the battery is dead.



CAUTION

If you discover incomplete characters, numbers, or symbols on the display, put your insulin pump into STOP mode and perform a system check again by simply removing the battery for a few seconds. When you reinsert the battery the system check will occur. If the incomplete characters, numbers, or symbols remain, your insulin pump may need to be returned since you may not receive the correct information for operating your pump. Put your insulin pump into STOP mode and contact Pump Support at 1-800-688-4578 immediately.

Setting Time and Date

Be careful to set the time and date correctly, because the basal rates and all history information are stored on the basis of time and date set in the pump.

When you travel across time zones, make sure that the time and date are set correctly.

The time format can be either American or European/Military Time.

American	European/Military Time
12-hour clock month/day/year	24-hour clock day/month/year



WARNING

Incorrect setting of time and date can lead to incorrect insulin delivery. Make sure that the time and date of your insulin pump is programmed correctly to ensure the correct insulin delivery and data memory. Do not make therapy decisions based upon a single result in the insulin pump's memory.

If you, your doctor, or healthcare team reviews your therapy data electronically, it is essential that the time and date of your insulin pump, your blood glucose measurement system (such as an ACCU-CHEK blood glucose meter), the PC, and other devices used are set identically. If they are not, the gathered data might not be meaningful. Check these devices regularly to ensure that the time and date settings are identical.

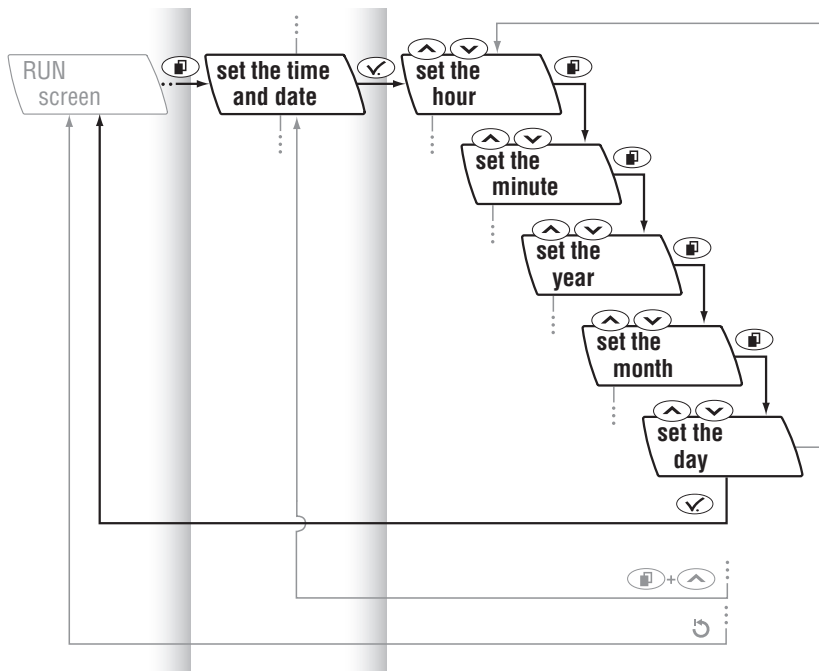

Follow the steps below to set the Time and Date:

1. Press to move to the SET TIME AND DATE screen.



Press to select.

2. The SET HOUR screen displays.

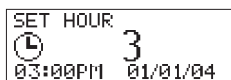

Press or to set the hour.

3. Press to move to the SET MINUTE screen.

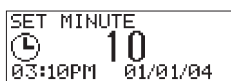

Press or to set the minutes.

4. Press  to move to the SET YEAR screen.



Press  or  to set the year.

5. Press  to move to the SET MONTH screen.



Press  or  to set the month.

6. Press  to move to the SET DAY screen.

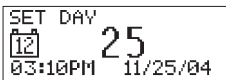

Press  or  to set the day.

7. Press  to save and exit.

Your Personal Settings



WARNING

Your new ACCU-CHEK Spirit insulin pump must be programmed with your personal settings prior to starting insulin pump therapy. Work with your doctor or healthcare team to understand how to use the pump.

Always check your personal settings before using your new pump in order to avoid incorrect insulin delivery. Record your personal settings from your current insulin pump and ensure that they are correctly programmed into a new ACCU-CHEK Spirit insulin pump. Incorrect programming of your insulin pump may cause incorrect insulin delivery.

Do not operate your insulin pump without knowing your personal settings. If you are not sure about your personal settings or you are less experienced, have your doctor or healthcare team check them. Work with your doctor or healthcare team to determine the timing as well as the amount and type of bolus you need to deliver. Make sure you know your personal carbohydrate to insulin ratio and your correction bolus ratio.

Change your personal settings only after consulting with your doctor or healthcare team and always follow their instructions.

Your Basal Rate Profile

Your pump delivers insulin every 3 minutes, in 20 equal doses each hour, 24 hours a day. This flow of insulin, measured in international units per hour (U/h), is called the basal rate and is calculated to meet your basic insulin needs.

An ACCU-CHEK Spirit insulin pump basal rate profile consists of up to 24 different hourly basal rates. Each hourly rate may be changed independently. The total of all 24 hourly basal rates in one basal rate profile is called the (daily) basal rate total.

Your basal rate profile should be reviewed:

- after any programming changes are made to your pump,
- after a new battery is inserted, and
- after confirming an error E7: ELECTRONIC ERROR.

Programming Your Basal Rate Profile

Note:

Insulin delivery does not stop or pause during basal rate programming.

The insulin amounts and other values used in this user guide are examples only. Your personal values may differ.

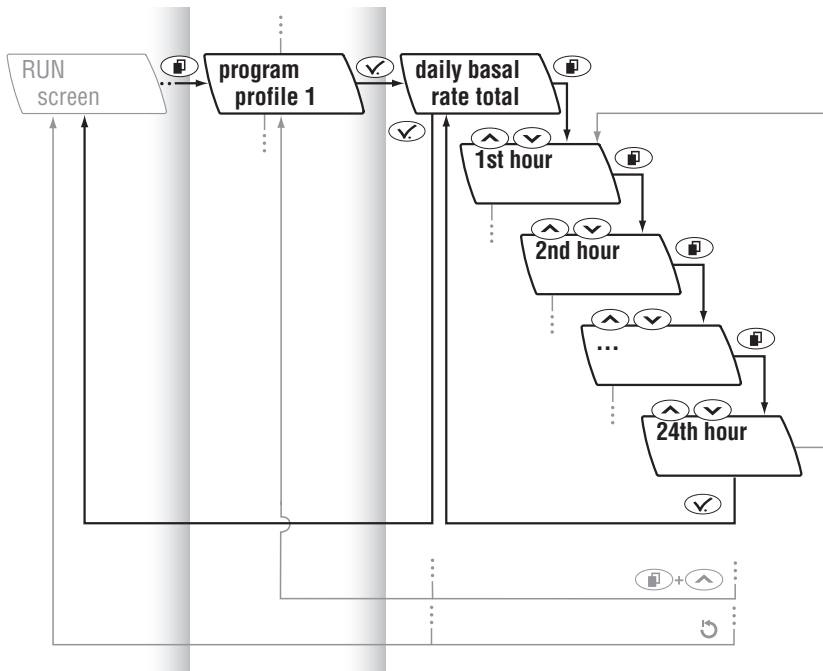

Note:

For your safety and convenience during programming, your insulin pump returns itself to the **RUN** or **STOP** screen if no key is pressed within 20 seconds. The changes you made before your insulin pump “times out” will not be saved.

Follow the steps below:

1. Press  to move to the PROGRAM BASAL RATE PROFILE 1 screen.



2. Press  to select.

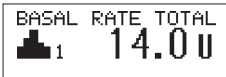

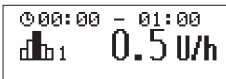

The daily BASAL RATE TOTAL is displayed.

3. Press  to move to the first hour.





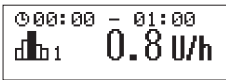

The first hour, which always begins at midnight, 00:00 – 01:00 (12:00 AM – 01:00 AM if the American time format is used), is shown.

4. Press  or  or scroll to set the hourly basal rate given by your doctor or healthcare team.

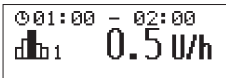

5. Press  to move to the next hour.



6. Continue using  and the  and  keys to set the hourly basal rates for the remaining hours. This lets you program your individual basal rate profile hour-by-hour. Continue until all 24 hours are programmed.

7. Press  to confirm.

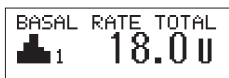

The new daily BASAL RATE TOTAL is displayed. Check the new daily BASAL RATE TOTAL.



8. Press  to save and exit.

If the current active basal rate profile is the same as the new programmed basal rate, it is active immediately.



Note:

At any screen you have three options to exit:

If you want to **save the changes**

- Press . Check the new daily basal rate total.
- Press . Your pump returns to the **RUN** screen.

If you want to **undo the changes**

- Wait for your ACCU-CHEK Spirit insulin pump to return to the **RUN** screen (timeout), or
- Press  +  simultaneously (exit feature) to exit the function screen.

Copying an Hourly Basal Rate

If your basal rate is the same for multiple hours in a row, you can save time programming by copying an hourly basal rate to one or more hours.

Follow the steps below:

1. Press  to move to the PROGRAM BASAL RATE PROFILE 1 screen.



2. Press  to select.

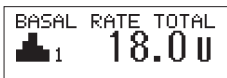

The daily BASAL RATE TOTAL is displayed.

3. Press  to move to the hourly basal rate you want to copy.

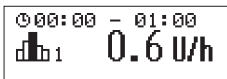

4. Press  +  simultaneously.

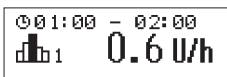

A special beep confirms that you are pressing the keys correctly. The same hourly basal rate is copied to the next hour.

5. If you want to copy the rate to multiple hours, press  +  repeatedly or press and hold  +  (scroll).

6. Press  to confirm.

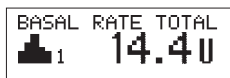

Check the new daily BASAL RATE TOTAL.

7. Press  to save and exit.

If the current active basal rate profile is the same as the new programmed basal rate, it is active immediately.

Basal Rate and Bolus

During normal use, your pump is in **RUN** mode and insulin is continuously delivered (basal rate).

A bolus can be programmed when it is needed. A bolus is the amount of insulin delivered (in addition to the basal rate) to cover the intake of food and correct high blood glucose levels. The bolus amount is determined by your doctor or healthcare team's guidelines, your blood glucose level, your food intake, and your activity level as well as stress and illness. See the section "Understanding Boluses" (page 75) for more information.

Preparing the Cartridge



WARNING

Your insulin pump is designed to use an ACCU-CHEK 3.15 ml plastic cartridge. The cartridge is a sterile product intended for single use only. Sterility is guaranteed for unopened packaging up to the indicated expiration date.

- **Do not use sterile products if the package is damaged.**
- **Do not reuse single use materials. Reusing single use materials might lead to a malfunction of your insulin pump and to incorrect insulin delivery and/or an infection.**
- **Always handle the items with clean hands.**
- **Use specified cartridges only. Using other cartridges can endanger your health and may void the warranty.**

Filling the Cartridge

Note:

A filling aid, an optional accessory by Disetronic Medical Systems, helps you fill an empty ACCU-CHEK 3.15 ml plastic cartridge from your vial of insulin. Read the instructions that are included with the filling aid to learn how to use it.

To fill a cartridge, have the following materials ready:

- ***A new 3.15 ml plastic cartridge with protective cap, plunger rod, filling needle, and***
- ***Insulin at room temperature to minimize formation of air bubbles***

Follow the steps below:

1. Wash your hands.



2. Set the insulin vial on a hard, flat surface, such as a table.



Clean the rubber membrane of the vial using an antiseptic wipe.

3. Remove the cartridge, the cartridge protective cap, and the filling needle with its protective cap from their packaging.
4. Place the filling needle with protective cap onto the cartridge tip and make sure the connection is tight.

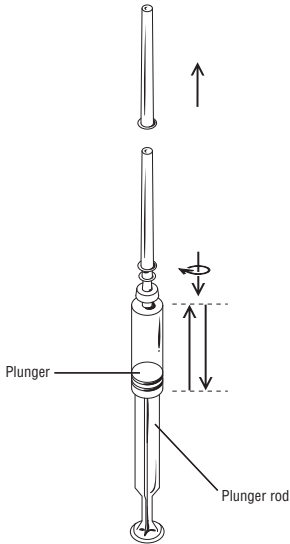

Move the plunger rod back and forth twice in the cartridge to distribute the lubricant.

Pull the plunger back to fill the cartridge with air.

5. Remove the protective cap from the needle. Do not touch anything with the needle.

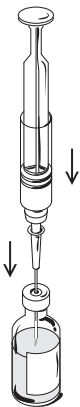

Push the tip of the filling needle into the center of the insulin vial's rubber membrane.

Push the plunger rod down so that all air from the cartridge enters the insulin vial.

6. Hold steady pressure against the plunger rod with your thumb, and at the same time turn the insulin vial over so that the filling needle and cartridge are pointing upwards into the insulin vial.

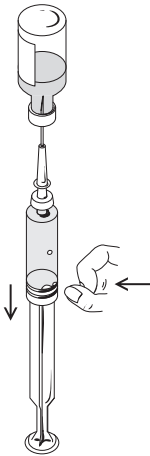

Make sure that the tip of the filling needle stays in the insulin.

Slowly release the pressure against the plunger rod and let the insulin flow into the cartridge.

Do not pull or push the plunger rod while it is moving on its own (this could lead to air bubbles in the insulin).

Slowly pull the plunger rod straight down to fill the cartridge.

Remove any air bubbles by tapping on the cartridge. Push the air bubbles back into the insulin vial using the plunger rod.

The cartridge is full when there are no air bubbles in it and the plunger is at the bottom of the cartridge.

7. Remove the filling needle from the insulin vial.
8. Place the protective cap on the filling needle.

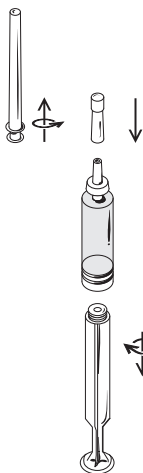

Remove the plunger rod by turning it counter-clockwise out of the plunger.

Remove the filling needle with its protective cap from the cartridge by turning counter-clockwise. Dispose of properly.

Push the cartridge protective cap tightly onto the cartridge tip until it clicks.

The cartridge is now ready to use.

Note:

Do not pull or push the plunger rod during removal.



CAUTION

Air bubbles in the cartridge and infusion set may cause the infusion of air instead of insulin. In this case, your body does not receive the required amount of insulin and an error E4: OCCLUSION may be displayed. Remove bubbles while filling the cartridge and priming the infusion set and without having the infusion set connected to your body.

Cold insulin may release air when warmed. Use only insulin at room temperature when filling the cartridge and priming the infusion set. Inspect the cartridge and the infusion set for air bubbles at least every three hours during the day and before you go to sleep. Remove any air bubbles and change system components if needed.

Connecting the Cartridge, Adapter, and Infusion Set

Note:

Before you change the cartridge, adapter, and infusion set, check that your pump is in good, working order. See the section “System Inspection Checklist” (page 137).

Insulin can flow freely from the cartridge or infusion set if the cartridge plunger and the piston rod are not properly connected and the pump is positioned at a higher level than the infusion site. Prevent free flow of insulin by correctly inserting the cartridge: move the piston rod to the proper position and twist the adapter until the cartridge plunger sits flush with the end plate of the piston rod.

Have the following materials ready:

- ***A filled ACCU-CHEK 3.15 ml plastic cartridge with a luer-lock connection***
- ***An ACCU-CHEK Spirit insulin pump adapter***
- ***A new ACCU-CHEK infusion set***



The cartridge and infusion set are ***sterile products intended for single use only***. Sterility is guaranteed for unopened packaging up to the indicated expiration date. ***Do not use sterile products if the packaging is damaged.***

Do not reuse single use materials because this might lead to a malfunction of your insulin pump, to incorrect insulin delivery, and/or an infection. Always handle the items with clean hands. Avoid any contact of the infusion set and the connecting parts of your insulin pump with antiseptics, antibiotic creams, soaps, perfumes, deodorants, body lotions, or any other cosmetics. They may contaminate these parts.

Follow the instructions below:

Remove the protective cap from the cartridge. Do not touch the cartridge tip.

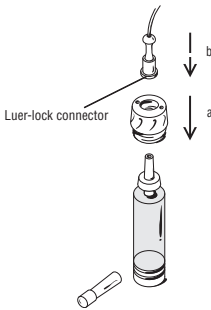

Push the adapter all the way onto the cartridge tip to the stop (a).

Hold the adapter and twist the infusion set luer-lock connection by hand, clockwise into the adapter (b). Carefully prepare a new ACCU-CHEK infusion set for use, priming and insertion, following its instructions for use.

Do not over-tighten.



CAUTION

To avoid leakage, properly tighten the infusion set to the adapter. Turn the infusion set luer-lock connector until it stops. Do not turn it any further and do not use any auxiliary tools as this may crack the infusion set luer-lock connector and result in leakage.

Note:

Your pump cannot detect infusion set leakage. You must check all parts of the infusion set at least every three hours during the day and before you go to sleep. If you detect any loss of insulin and all parts are correctly tightened, immediately replace the leaking component. Because insulin delivery has been interrupted, check your blood glucose level and take appropriate actions according to your doctor's or healthcare team's instructions.

Inserting the Cartridge



Do not perform the **CHANGE THE CARTRIDGE** function if the cartridge compartment is not completely dry. During the rewinding of the piston rod, insulin or water might enter your insulin pump and could lead to malfunction. If necessary, use a soft cloth to dry the compartment.

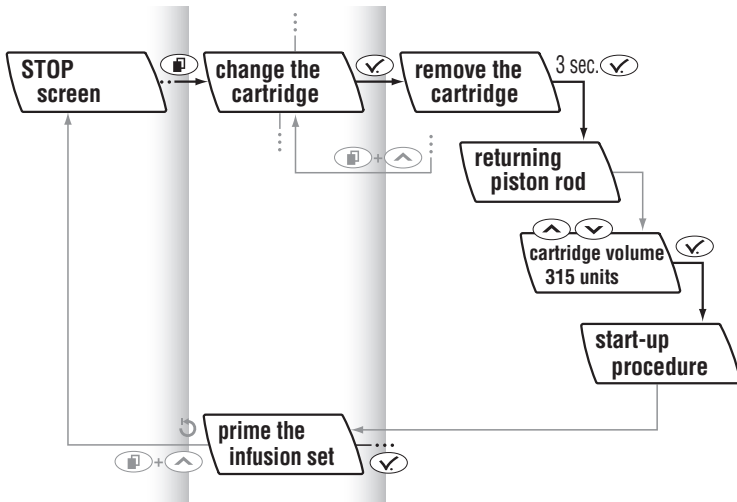

Have the following materials ready:

- *Your insulin pump*
- *A filled ACCU-CHEK 3.15 ml plastic cartridge with a connected ACCU-CHEK Spirit insulin pump adapter*
- *A new ACCU-CHEK infusion set*

Follow the steps below:

1. Press  to move to the STOP YOUR ACCU-CHEK screen.



2. Press  to select and put the pump in **STOP** mode.



Your pump displays the **STOP** screen, and insulin delivery stops.

3. Press  to move to the CHANGE THE CARTRIDGE screen.



4. Press  to select.



Remove the current cartridge, if there is one.

5. Press and hold  (for 3 seconds) until you hear a melody.



The piston rod begins its return. Do not touch or disturb the piston rod while it is rewinding. Doing so may potentially damage your pump.

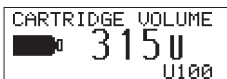

When the piston rod returns completely, the CARTRIDGE VOLUME screen displays the maximum cartridge volume, 315U.

6. Hold your pump upright. Hold the new filled cartridge so that the connected adapter and infusion tube set point upwards, parallel, and close to the cartridge compartment.

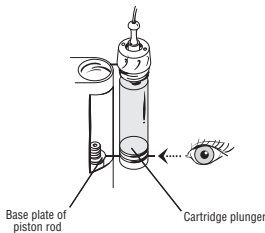

Make sure that the bottom edge of the colored part of the adapter is level with the top of the cartridge compartment.

7. Press  or  to move the plunger rod forward until the end plate of the piston rod is level with the bottom of the cartridge plunger.

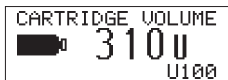

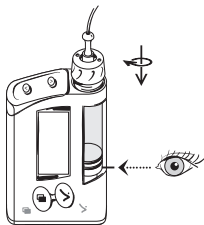

The cartridge volume decreases accordingly on the display.

8. Position your insulin pump upright (with the adapter pointing upwards). Insert the cartridge into the cartridge compartment.
9. Twist (do not push) the adapter clockwise until it sits flush with the cartridge compartment.



It is not necessary to apply pressure. Twisting will properly position the cartridge. Do not over-tighten the adapter or it will be difficult to remove the cartridge, adapter and cartridge plunger and may potentially cause damage to your pump. The cartridge is correctly inserted when the end plate of the piston rod sits flush against the cartridge plunger. This flush fit is an extra safety measure to prevent the free flow of insulin and to minimize occlusions (blockages).

If the end plate of the piston rod does not sit flush against the cartridge plunger, remove the cartridge from the cartridge compartment. Hold the cartridge and adapter next to the cartridge compartment. Press  or  to move the piston rod forward until its base plate and the cartridge plunger are level. The displayed cartridge volume decreases accordingly. Re-insert the cartridge into the cartridge compartment.

– If needed, repeat this step until the cartridge is correctly inserted (the end plate of the piston rod sits flush against the cartridge plunger).

10. Press  after correctly inserting the cartridge.



Your pump performs a self test. See the section “System Check Start-Up Process” (page 28).

11. Check that the infusion set luer-lock connector is still correctly connected to the adapter. Tighten the infusion set by hand clockwise until it sits tightly in the adapter.

12. When the system check start-up process is finished, the PRIME THE INFUSION SET screen is displayed.

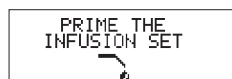

See the section “Priming the Infusion Set” (page 53) for more information. Start from the point in those instructions where the pump screen matches the screen above.

Priming the Infusion Set



WARNING

Never prime an infusion set that is connected to your body. You risk uncontrolled insulin delivery into your body. Always follow the instructions for the infusion set you are using.

The ACCU-CHEK Spirit insulin pump stops priming after 25 units of insulin. If no insulin has emerged from the tube set needle after priming, repeat the priming function. When insulin comes from the tip of the needle, press any pump key to stop priming. The amount of insulin used in priming is not added to the pump's history of daily insulin totals.

During priming your pump should be upright, with the adapter pointing upwards to help let air bubbles out of the cartridge and the infusion set.



WARNING

Air bubbles in the cartridge and infusion set may cause the infusion of air instead of insulin. If this happens, your body will not receive the required amount of insulin. Inspect the cartridge and the infusion set for air bubbles at least every three hours during the day and before you go to sleep. Remove bubbles while filling the cartridge and priming the infusion set and without having the infusion set connected to your body.

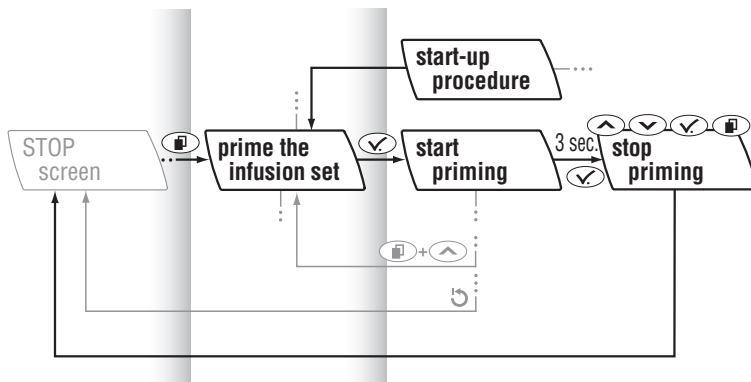

Follow the steps below:

1. Press to move to the STOP YOUR ACCU-CHEK screen.



2. Press to select and put the pump in **STOP** mode.

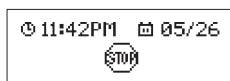



Your pump displays the **STOP** screen, and insulin delivery stops.

3. Prepare the tubing or cannula/needle for priming per infusion set instructions for use.

4. Press to move to the PRIME THE INFUSION SET screen.



5. Press  to select. The priming amount of 25 units of insulin is shown on the display.
6. When START PRIMING is displayed, press and hold  until you hear a melody and the piston rod moves forward.

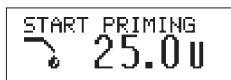

The priming process begins and a count-up is shown on the display. Your pump stops priming after 25 units.



When the priming process is finished, your pump returns to **STOP**.

The infusion tubing set is properly primed when there are no air bubbles visible in the tubing and a drop of insulin has come out of the connector or cannula.

Stopping the Priming Process

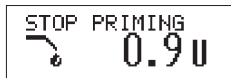

You can stop the priming process at any time by pressing any key. Your pump displays the STOP PRIMING screen.

Preparing the Infusion Site and Inserting the Infusion Set

Always follow the instructions given to you by your doctor or healthcare team and the instructions for the infusion set you are using.

Change your infusion set as frequently as recommended by the manufacturer.

Infusion Site Selection

Your doctor or healthcare team will help you select your infusion site areas according to a planned rotation pattern. Avoid your waistline, bones, scar tissue, recent infusion sites, bruises, and sores. Choose an infusion site at least one inch (2.5 cm) away from the navel and previous infusion sites.

Infusion Site Preparation

It is important to prepare the infusion site properly to reduce the risks of infection. Your doctor or healthcare team will give you infusion site preparation guidelines.

Have the following materials ready:

- *Your ACCU-CHEK Spirit insulin pump*
- *A disinfectant for your skin*
- *A new ACCU-CHEK infusion set*

Follow the steps below:

1. Make sure your pump is correctly set up (including cartridge, adapter and infusion set) and is programmed with your personal settings.

2. Wash your hands thoroughly.

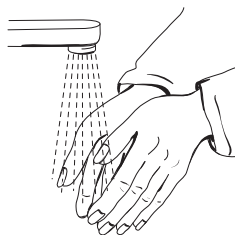

3. Disinfect the infusion site and let it dry completely.

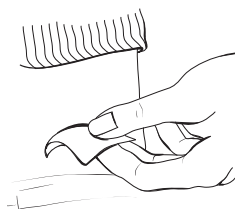

4. Make sure your pump is in **STOP** mode.

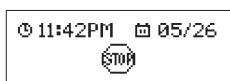

5. Insert your ACCU-CHEK infusion set according to the instructions for its use.

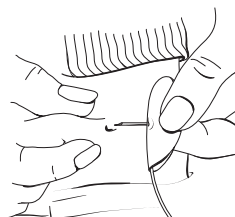

Note:

If you use a soft cannula-type infusion set, you must proceed with a bolus to fill the air space in the cannula after removing the introducer needle according to the instructions for the infusion set you are using. Failure to do so could result in missed insulin dosing. See the section “Programming a Standard Bolus” (page 77) for more information.



CAUTION

Inspect your infusion site at least once or twice each day for irritation or infection. Signs of infection may include, but are not limited to, pain, lumps, redness, heat, or discharge.

If you see redness or swelling, change your infusion headset and infusion site immediately and contact your doctor or healthcare team.

Change your infusion headset according to the instructions for the infusion set you are using and your doctor or healthcare team’s recommendations.

If you have read and followed all instructions, cautions, warnings, and notes found in this chapter, your pump should now be ready to use. However, please read the complete manual before starting.

Chapter 3: Using Your Pump

Before Using



CAUTION

Training and using your insulin pump requires the support of an experienced doctor or healthcare team. Regular visits to your doctor or healthcare team are absolutely essential during insulin pump therapy.

Always follow the instructions given by your doctor or healthcare team.

Successful insulin pump therapy requires you to check your blood glucose levels often. It is a good idea to check your blood glucose (using an ACCU-CHEK blood glucose monitor) at least four times a day, or as often as you are directed by your doctor or healthcare team.

Wearing Your Pump



CAUTION

When wearing your insulin pump make sure to prevent any contact with objects that may damage or accidentally press the keys of your insulin pump (e.g., keychains, keys, pocket knives, and coins).

Attach your pump safely to your body or clothes to prevent damage. Special carrying systems let you carry your pump on or under your clothes. All specified accessories have been tested and approved for use with your ACCU-CHEK Spirit insulin pump. The proper functioning of your pump can only be guaranteed if you use it with ACCU-CHEK Spirit insulin pump accessories.

See Disetronic Medical Systems sterile products and accessories catalogs and brochures for more information. Or, contact Pump Support at 1-800-688-4578.

Wear your pump under your clothes or directly on your body in cold or rainy weather. If you have concerns about the weather affecting your pump, check the operating conditions of your pump and contact Pump Support at 1-800-688-4578. See the section “Appendix A: Technical Data” (page 165) for more information on operating conditions.



CAUTION

Do not place your insulin pump in direct sunlight. Overheating of the insulin and your insulin pump must be avoided. Protect your insulin pump from direct exposure to cold wind and temperatures over 104°F (40°C) and below 41°F (5°C). These conditions may damage the insulin and the electronics of your insulin pump and may cause a malfunction of the battery.

See the instructions for the insulin you are using to determine the acceptable temperature range.

When Not to Wear Your Pump

Electromagnetic Fields and Hazardous Areas

Do not use your pump around electromagnetic fields such as radar or antenna installations, high-voltage sources, X-Ray sources, MRI, CAT scan, and all other sources of electrical current as they may cause your pump not to work. Insulin delivery may stop and an error E7: ELECTRONIC ERROR may occur.

Always stop and remove your pump before you enter these areas.

See “Appendix A: Technical Data” (page 165) for more information about electromagnetic fields.



WARNING

Your insulin pump has not been tested with cardiac pacemakers. Do not use the ACCU-CHEK Spirit insulin pump if you have a cardiac pacemaker.

Your pump has been tested and complies with the regulations regarding unintentional electromagnetic interference. Security systems in airports as well as anti-theft monitoring devices, such as those in department stores, should not affect the functioning of your pump.

Because there are so many devices, such as *cellular phones*, that give off electromagnetic radiation, the influence of some such devices on your pump cannot be ruled out. It is a good idea to keep your pump at least 4 inches (10 cm) away from such devices while the other devices are turned on.

Do not use your pump in hyperbaric chambers and in hazardous areas of any kind, such as areas where explosive or flammable gases or vapors could exist. This could affect insulin delivery and/or lead to harm.

Your pump is designed to work in normal barometric conditions (from 700 to 1,060 mbar).

Do not exceed 10,000 feet (3,000 meters) above sea level. Your pump has not been tested for use above this level.

Always stop and remove your pump before you enter these areas. If you have questions, contact Pump Support at 1-800-688-4578.

Sports and Exercise

Exercise is an important part of diabetes management. Disetronic Medical Systems designed the ACCU-CHEK Spirit insulin pump to let you safely perform many sporting activities while you wear your pump. It is important that you protect your pump before you start exercise or sports activities. Do not wear your pump during sports that involve body contact such as boxing, football, or hockey since rough contact could damage your pump.

Consult our sterile products brochures and accessories catalog for more information regarding carrying systems or contact Pump Support at 1-800-688-4578 for more information.

Traveling

Ask your doctor or healthcare team about any special actions you need to take before you travel. Take extra blood-glucose testing and pump supplies when you travel and find out where to get supplies while you are traveling.

When you travel across time zones, make sure that the time and date on your pump are set correctly to the local time.

The ACCU-CHEK insulin pump has not been tested at altitudes in excess of 10,000 feet (3,000 meters) above sea level. If your travels take you to an area in excess of 10,000 feet (3,000 meters) above sea level, stop and remove your pump. This does not apply to use in airplanes with pressurized cabins.

If you have questions, contact Pump Support at 1-800-688-4578.

Your Insulin Pump and Water



CAUTION

Avoid deliberate contact with water. Check daily that your insulin pump is not chipped, cracked, or damaged in any way and that the battery cover and the adapter are correctly closed. In the presence of chips and cracks, water, dust, insulin, or other foreign substances may enter your insulin pump and lead to malfunction. Prior to contact with water, disconnect and take off your insulin pump.

Disconnect and remove your pump before entering a bathtub, Jacuzzi or whirlpool, shower, or swimming pool. Avoid exposing your pump to high humidity, such as in a sauna, as this could damage your pump. To make it easy to remove your pump, use disconnectable ACCU-CHEK infusion sets.

Consult your doctor or healthcare team to find out how long your insulin pump therapy can safely be interrupted.

Accidental Contact with Water

Your insulin pump is protected against accidental short-term water contact. Examples of accidental short-term water contact include:

- rain, snow;
- water that splashes while you are biking, jogging, or hiking;
- accidental brief immersion into the sink or bathtub.

What to Do After Any Water Contact

Put your pump into **STOP** mode. Disconnect the pump from your body before inspecting it. Use a soft cloth to dry the outside of the pump. Check the battery compartment and the cartridge compartment for water. If the battery compartment or cartridge compartment are wet, turn your pump upside down to let the water run out and let it air dry. Do not use warm air such as a hair dryer to dry the pump as this could damage the pump's electronics. Do not re-insert the battery or the cartridge until the compartments are completely dry.

See the section “Cleaning Your ACCU-CHEK Spirit Insulin Pump” (page 141) for more information.

Other Liquids

You do not have to worry about contact between your pump and:

- sweat
- saliva

You must check your pump immediately after contact with other liquids or chemicals such as:

- cleaning solutions
- alcohol
- beverages

See the section “Cleaning Your ACCU-CHEK Spirit Insulin Pump” (page 141) for more information.



CAUTION

Avoid any contact of your insulin pump, the infusion set, and the connecting parts of your insulin pump with health and beauty items (for example, antiseptics, antibiotic creams, soaps, perfumes, deodorants, body lotions, or any other cosmetics). These items may discolor your pump or fog your display.

Starting Insulin Delivery

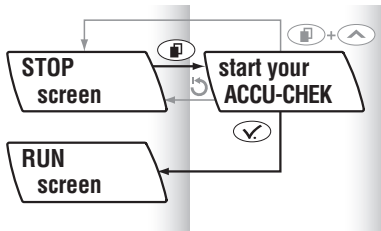

Follow the steps below:

1. Start from the **STOP** screen.



2. Press to move to the START YOUR ACCU-CHEK screen.



3. Press to select. Your pump shows the **RUN** screen.

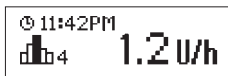

Insulin delivery begins within 3 minutes.

Note:

Check the amount of insulin remaining in the cartridge at least once a day. If you press the key from the **RUN** or **STOP** screen, your pump displays the remaining cartridge content in units. Before going to sleep, make sure that:

- the cartridge contains enough insulin to last through the night, and
- the time and date are set correctly.

Stopping Insulin Delivery



CAUTION

When your insulin pump is in STOP mode, it does not deliver any insulin. You will need to put your insulin pump into RUN mode to continue insulin delivery.

There are functions and actions, for your safety, that you can only perform when the pump is in **STOP** mode. These functions and actions include:

- changing the cartridge
- connecting and disconnecting the adapter and/or infusion set, and
- priming the infusion set

Follow the steps below:

1. Press  to move to the STOP YOUR ACCU-CHEK screen.



2. Press  to select.



Your pump returns to the **STOP** screen and insulin delivery stops.

3. Press  (QUICK INFO screen) to review activated functions and features (like the beep and vibration alarm signals) indicated by icons and messages on the screen.

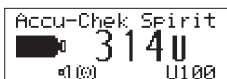



Note:

When an Extended Bolus, a MultiWave Bolus, and/or a Temporary Basal Rate (TBR) is/are active and you put your pump into **STOP** mode, an alert A6: TBR CANCELLED and/or an alert A8: BOLUS CANCELLED occur(s). Press  twice for each appearing alert to confirm and turn off. See the sections “Alert A6: TBR CANCELLED” (page 152) and “Alert A8: BOLUS CANCELLED” (page 153) for more information.

STOP-Warning

The STOP-Warning is turned on by the pump each time your pump switches from **RUN** mode to **STOP** mode, and when a battery is inserted. The STOP-Warning is a long beep and a vibration occurring every minute. It warns you that insulin delivery has stopped. If you are aware of the situation and don't wish to be reminded, you can turn off the STOP-Warning.

To Turn Off the STOP-Warning

Press either  or  for 3 seconds to turn off the STOP-Warning. A melody plays indicating the STOP-Warning is turned off.

Note:

The volume of the STOP-Warning cannot be changed. It is independent of the programmed beep volume.

Interruption of Insulin Pump Therapy

Consult with your doctor or healthcare team about when and for how long your insulin pump therapy can be interrupted.

Measure your blood glucose level regularly during any insulin interruption. Use a syringe or insulin pen to inject insulin according to the instructions of your doctor or healthcare team.



WARNING

Since only rapid-acting insulin is used for insulin pump therapy, there is only a small insulin reserve in the body. If insulin is interrupted for any reason, such as:

- **if you stop the pump**
- **there is a technical problem with the pump**
- **there is leakage in the cartridge**
- **there is occlusion in the infusion tube set or in the infusion headset**
- **the cannula has slipped out of the infusion site**

you must be ready to replace the missing insulin immediately.

Always carry spare sterile products and accessories (infusion set, insulin cartridge, batteries), an insulin pen/syringe, and insulin.

Without insulin, diabetic ketoacidosis may develop and may require in-patient hospital treatment.

Short Interruption

1. Put your pump in **STOP** mode.
2. Remove or disconnect the infusion tube set from the infusion headset. When using a disconnectable infusion set, disconnect it at your infusion site and use the protective covers that came with the infusion set.

Resuming Insulin Pump Therapy

1. Attach a new ACCU-CHEK infusion set and prime it before inserting it.
2. Follow the instructions to prepare the infusion set you are using, and put your pump into **RUN** mode.

Measure your blood glucose level within 2 hours of restarting pump therapy to check the function of the system and to ensure insulin delivery.

Interruption of Use of Your Insulin Pump for a Long Period of Time

There may be times when you may need to interrupt your pump therapy for more than one day. Follow the steps below.



CAUTION

Contact your doctor or healthcare team for an alternate therapy plan when you interrupt the insulin pump therapy for a long period of time.

1. Put your pump into **STOP** mode.
2. Remove the cartridge, adapter, and infusion set.
3. Reinsert the adapter.
4. Remove the battery and reinsert the battery cover.
5. Store your pump properly. See the section “Storing Your ACCU-CHEK Spirit Insulin Pump” (page 140) for more information.

Changing the Infusion Set

When you change the infusion set, keep the following points and warnings in mind:

- *Infusion sets are sterile products intended for single use only. Sterility is guaranteed for unopened packaging up to the indicated expiration date. Do not use sterile products if the package is damaged.*
- *Properly tighten the infusion set to the adapter to avoid leakage. Turn the infusion set luer-lock connector until it stops. Do not turn it any further and do not use any auxiliary tools as this may crack the infusion set luer-lock connector and result in leakage.*
- *Your pump cannot detect infusion set leakage. You must inspect all parts of your infusion set at least every three hours during the day and before you go to sleep. If there seems to be any loss of insulin and all parts are correctly tightened, immediately replace the leaking component. Immediately check your blood glucose level, because insulin delivery has been interrupted. Take appropriate actions according to your doctor's or healthcare team's instructions.*
- *Always disconnect your infusion set before changing a cartridge or priming. You risk uncontrolled insulin delivery into your body. Always follow the instructions for the infusion set you are using.*

Have the following materials ready:

- ***Your ACCU-CHEK Spirit insulin pump***
- ***A disinfectant for your skin***
- ***A new ACCU-CHEK infusion set***

Follow the steps below:

1. Wash your hands thoroughly.

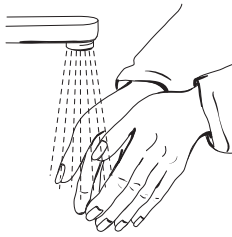

2. Make sure your pump is in **STOP** mode.



3. Remove the infusion tube set from the headset.
4. Remove the infusion tube set from the adapter and dispose of it properly.

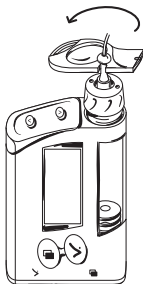

Note:

The battery key has a notch that fits all ACCU-CHEK infusion set luer-lock connectors. You may use the battery key to loosen the luer-lock connector between your infusion set and adapter if it cannot be loosened by hand.

5. Carefully prepare a new ACCU-CHEK infusion set for use.
6. Turn the ACCU-CHEK infusion set by hand clockwise into the adapter.
7. Properly tighten the luer-lock connector by hand.

8. Prime the infusion set following all the instructions and warnings found in the section “Priming the Infusion Set” (page 53).
9. Insert a new infusion set following the instructions found in the section “Preparing the Infusion Site and Inserting the Infusion Set” (page 56).
10. Remove the old infusion headset and dispose of it properly.
11. Place the pump in **RUN** mode. See the section “Starting Insulin Delivery” (page 65).

Note:

If you use a soft cannula-type infusion set, you must proceed with a bolus to fill the air space in the cannula after removing the introducer needle according to the instructions for the infusion set you are using. Failure to do so could result in missed insulin dosing. See the section “Programming a Standard Bolus” (page 77) for more information.

Inspect your infusion site at least once or twice each day for irritation or infection. Signs of infection may include, but are not limited to, pain, lumps, redness, heat, or discharge.

If you see redness or swelling, change the infusion headset and the infusion site immediately and contact your doctor or healthcare team.

Change the infusion headset according to the instructions for the infusion set you are using and your doctor or healthcare team’s recommendations.

Changing the Cartridge and Infusion Set

Have the following materials ready:

- *Your ACCU-CHEK Spirit insulin pump*
- *A disinfectant for your skin*
- *A new ACCU-CHEK infusion set*
- *A filled ACCU-CHEK 3.15 ml plastic cartridge with a luer-lock connection*
- *A new adapter (must be changed at least with every 10th cartridge)*

1. Wash your hands thoroughly.



2. Make sure your insulin pump is in **STOP** mode.



3. Remove your infusion tube set from the headset.

4. Remove the infusion tube set from the adapter and dispose of it properly.

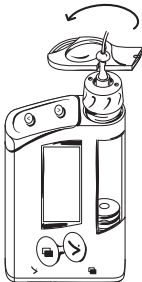

Note:

The battery key has a notch that fits all ACCU-CHEK infusion set luer-lock connectors. You may use the battery key to loosen the luer-lock connector between your infusion set and adapter if it cannot be loosened by hand.

5. Hold your ACCU-CHEK Spirit insulin pump with the adapter pointing downwards.

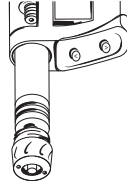

6. Remove the adapter and cartridge from your pump by unscrewing the adapter from the pump casing. Pulling the adapter from the pump casing without completely unscrewing it may result in the plunger staying attached to the piston rod. If this should happen, please call Pump Support at 1-800-688-4578.
7. Remove the cartridge from the adapter and dispose of the cartridge properly.
8. Hold the adapter up to the light to check for signs of wear or dirt (especially on the seals inside and outside of the adapter). It is recommended that you replace the adapter at least every 10th insulin cartridge change.
9. If needed, clean the adapter using water and dry it. If it shows signs of wear or dirt, replace it immediately.
10. Install a new cartridge and a new infusion set. See the following sections for instructions: “Changing the Infusion Set” (page 70), “Preparing the Cartridge” (page 42), “Connecting the Cartridge, Adapter, and Infusion Set” (page 47), “Inserting the Cartridge” (page 49), “Priming the Infusion Set” (page 53), “Preparing the Infusion Site and Inserting the Infusion Set” (page 56), and “Starting Insulin Delivery” (page 65).

Note:

Check the amount of insulin remaining in the cartridge at least once a day. Press the  key from the **RUN** or **STOP** screen to display the remaining cartridge content in units. Before going to sleep, make sure that:

- the cartridge contains enough insulin to last through the night, and
- that the time and date are set correctly.

Chapter 4: Boluses and Temporary Basal Rates

Understanding Boluses

A bolus is the amount of insulin delivered (in addition to the basal rate) to cover the intake of food and correct high blood glucose levels. The bolus type and amount is determined by your doctor or healthcare team's guidelines, your blood glucose level, your food intake, your health condition, and your activity level. Discuss the timing and the amount and type of bolus you need with your doctor or healthcare team. You can review the time, date, and amount of the last 30 boluses in the bolus history. See the section "Review the Bolus History" (page 107) for more information.

Your pump can deliver three types of boluses:

- Standard Bolus** fast delivery

- Extended Bolus** delivery over a programmed period of time

- MultiWave Bolus** combines fast delivery with delivery over a programmed period of time









WARNING



- **Incorrect programming of your insulin pump may cause inappropriate insulin delivery.**
- **Your insulin pump must be programmed with your personal settings prior to starting insulin pump therapy.**
- **Do not operate your insulin pump without knowing your personal settings.**
- **If you are not sure about your personal settings or you are less experienced, have your doctor or healthcare team check your personal settings.**
- **Work with your doctor or healthcare team to determine the timing, amount, and type of bolus you need to deliver.**
- **Make sure you know your personal carbohydrate to insulin ratio and your correction bolus ratio.**

Programming a Standard Bolus





There are two ways to program a Standard Bolus:

“Quick” Standard Bolus	“Scroll” Standard Bolus
Using  and  on your insulin pump, with bolus increments determined by the user	Menu-guided using  and  with  and  for programming of the amount

The bolus amount per delivery is limited to 25 units using U100 insulin.

After you program a Standard Bolus there is a delay of 5 seconds before the bolus delivery starts. This delay lets you cancel the bolus before delivery starts by pressing the  or  key. Alert A8: BOLUS CANCELLED will occur. Press  twice to confirm and turn off the alert. See the section “Alert A8: BOLUS CANCELLED” (page 153) for more information.

Programming a “Quick” Standard Bolus

The following process involves only the  and  keys. You can start with either key. The recommended steps below are those described with the first key appearing without parenthesis, such as . For the alternative step press the key in the parenthesis, such as (.

Note:

Because your pump beeps and vibrates to guide you safely through the programming, you may program the “Quick” STANDARD Bolus using one finger. After the bolus is programmed, you can count the beeps and vibrations of your pump to verify the correct programming.

The bolus increment for the “Quick” Standard Bolus is initially set to 0.5 units.

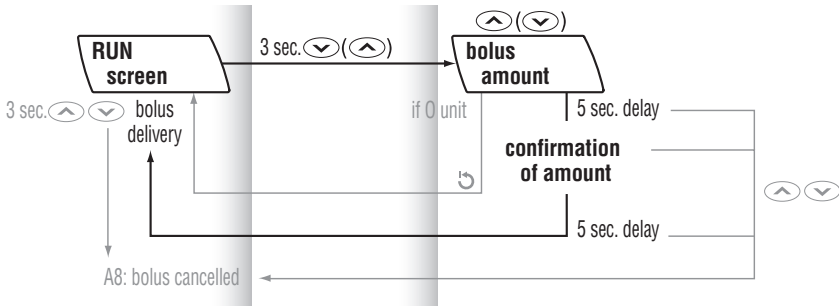

Follow the steps below:

1. From the **RUN** screen press and hold ▼ (▲) until you hear a beep sequence and feel a vibration.

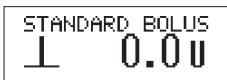

This activates the “Quick” STANDARD BOLUS function.

Hint:

Start programming with the ▲ (▼) key in areas of poor lighting, as this will also turn on the backlight.

2. Press ▲ (▼) repeatedly until the bolus amount is reached.

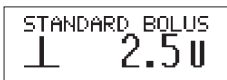

Each press of the ▲ (▼) key adds one bolus increment to the bolus amount. Your pump beeps and vibrates simultaneously once for each programmed bolus increment.



Five seconds after the last press of ▲ (▼), your pump confirms the total bolus amount with one beep and vibration for each bolus increment programmed.

The Standard Bolus symbol (L) blinks for 5 seconds (the bolus delivery start delay).

After this bolus delivery start delay, the pump beeps three times and then begins to deliver the total bolus amount programmed. The countdown of the remaining bolus amount appears on the display.





WARNING



The bolus increment that can be programmed into your insulin pump determines the Standard Bolus amount using the  and  keys of your insulin pump. Incorrect programming of the bolus increment may cause inappropriate insulin delivery. See the section “Bolus Increment” (page 131) for more information.

Canceling a “Quick” Standard Bolus



– *during programming* (the bolus amount blinks):

- Press the key  or  you used to enter the “Quick” Standard Bolus programming option. This will reset the bolus amount to 0.0 units. A melody will play. If no new bolus is programmed, your pump returns to the **RUN** screen and beeps three times after five seconds.
No bolus is delivered.

– *during confirmation* (when the beeps and vibrations occur), or *during the start delay* ( blinks):

- Press  or . A melody plays. Your pump returns to the **RUN** screen. An alert A8: BOLUS CANCELLED occurs. Press  twice to confirm and turn off the alert. See the section “Alert A8: BOLUS CANCELLED” (page 153) for more information.
No bolus is delivered.



– *during bolus delivery* (countdown of bolus amount):

- Press and hold  or  for 3 seconds until you hear a melody. An alert A8: BOLUS CANCELLED occurs. Press  twice to confirm and turn off the alert.
Bolus delivery is interrupted.
See the section “Alert A8: BOLUS CANCELLED” (page 153) for more information.

You can view the actual bolus amount delivered prior to the cancellation by looking at the bolus history. See the section “Review the Bolus History” (page 107) for more information.

Make sure that the cancellation was intended, and then program a new Standard Bolus, if needed.

Programming a Menu-Guided “Scroll” Standard Bolus

Regardless of the bolus increment setting, the bolus increments for the “Scroll” Standard Bolus are fixed to 0.1 unit. You can program this bolus in the STANDARD BOLUS screen by holding the  or  key (scrolling) until the bolus amount is displayed.

Follow the steps below:

1. Press  to move to the STANDARD BOLUS screen.



2. Press  to select. The BOLUS AMOUNT screen appears.

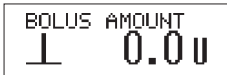

3. Press or scroll  to increase or  to decrease the bolus amount.

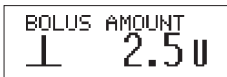

4. Press  to confirm the bolus amount.

The Standard Bolus symbol (**⏏**) blinks for five seconds (the bolus delivery start delay).

After this bolus delivery start delay, your pump beeps three times and begins to deliver the total bolus amount programmed. The countdown of the remaining bolus amount appears on the display.

Cancelling a Menu-Guided “Scroll” Standard Bolus

– **during programming** (the bolus amount blinks):

You have three options for cancelling a “Scroll” Standard Bolus during programming:

- If you do not press any key for 20 seconds, your pump returns to the **RUN** screen (timeout).
- Exit to the STANDARD BOLUS menu by pressing **⏏** + **⏏** simultaneously.
- Set the bolus amount to 0.0 units. Press **⏏** to exit.

No bolus is delivered.

– **during the start delay** (**⏏** is blinking):

- Press **⏏** or **⏏**. A melody plays. Your pump returns to the **RUN** screen. An alert A8: BOLUS CANCELLED occurs. Press **⏏** twice to confirm and turn off the alert.

No bolus is delivered.

Please refer to section “Alert A8: BOLUS CANCELLED” (page 153) for more information.

– **during bolus delivery** (countdown of bolus amount):

- Press and hold **⏏** or **⏏** for 3 seconds until you hear a melody. An alert A8: BOLUS CANCELLED occurs. Press **⏏** twice to confirm and turn off the alert.

Bolus delivery is interrupted.

Please refer to section “Alert A8: BOLUS CANCELLED” (page 153) for more information.

You can view the actual bolus amount delivered prior to the cancellation by looking at the bolus history. Please refer to the section “Review the Bolus History” (page 107) for more information.

Make sure that the cancellation was intended and then program a new Standard Bolus, if needed.

Programming an Extended Bolus

The Extended Bolus is available in the ADVANCED and CUSTOM user menus. The Extended Bolus function lets you program a bolus to be delivered over a period of time. This function is helpful during long meals, dinners, or receptions, or when you have meals that are digested slowly. The Extended Bolus may also be appropriate for people who have gastroparesis (delayed digestion).

The duration of bolus delivery can be programmed in 15-minute intervals up to 24 hours and begins immediately after confirmation.

Note:

You can add a Standard Bolus to an ongoing Extended Bolus. If you cancel the Standard Bolus, the Extended Bolus continues to run.

During the delivery of an Extended Bolus, the programming of another Extended Bolus or a MultiWave Bolus is blocked. If you want to program a different Extended Bolus, put the pump in **STOP** mode to cancel the current bolus and to program a new one.

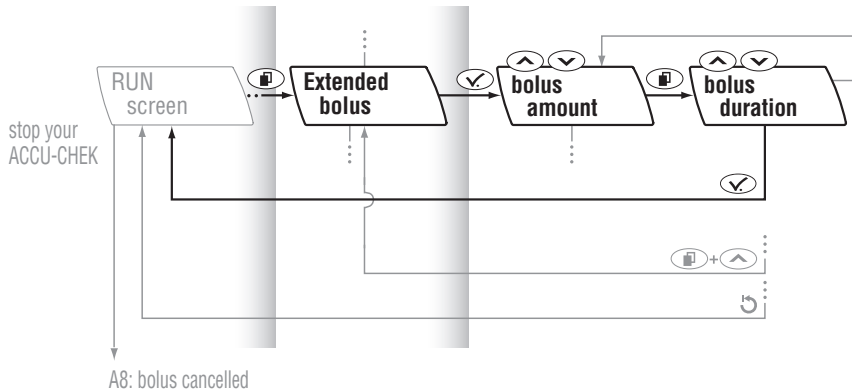

Follow the steps below:

1. Press  to move to the EXTENDED BOLUS screen.



2. Press  to select. The BOLUS AMOUNT screen appears.

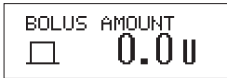

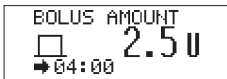

3. Press  to increase or  decrease the bolus amount.

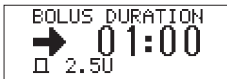

The duration of the last Extended Bolus delivered appears, or when using your pump for the first time, a default value appears.

4. Press  to move to the BOLUS DURATION screen.



Press  to increase or  decrease the bolus duration.

Note:

Press  to loop between programming the bolus amount and bolus duration.

5. Press  to confirm the bolus amount and duration. You will hear a melody when the bolus delivery begins within the next 3 minutes.



Note:

At any function screen you have three options to exit:

If you want to **deliver the bolus**

- Press . Your pump returns to the **RUN** screen.

If you want to **cancel the bolus**

- Wait for your pump to return to the **RUN** screen (timeout), or
- Press + simultaneously (exit feature) to exit the function screen.
- Set the bolus amount to 0.0 units and press .

Note:

During the entire bolus delivery, the remaining time and amount of the Extended Bolus and the current hourly basal rate are displayed in the **RUN** screen.

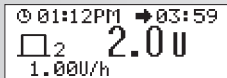

Note:

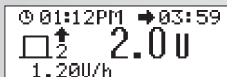

If a Temporary Basal Rate is active at the same time as the Extended Bolus, the remaining time and amount of the bolus and the amount of the increased or decreased hourly basal rate are displayed in the **RUN** screen.



Cancelling an Extended Bolus

– **during programming** (the bolus amount or bolus duration blinks):

You have three options for cancelling an Extended Bolus during programming:

- If you do not press any key for 20 seconds, your pump returns to the **RUN** screen (timeout).
- Exit to the EXTENDED BOLUS menu by pressing + simultaneously.
- Set the bolus amount to 0.0 units and press .
No bolus is delivered.

– **during bolus delivery:**

- If the Extended Bolus delivery has begun, it can be cancelled by putting your pump into **STOP** mode. This cancels the bolus delivery and an alert A8: BOLUS CANCELLED occurs. Press  twice to confirm and turn off the alert. See the section “Alert A8: BOLUS CANCELLED” (page 153) for more information.

Bolus delivery is interrupted.

The bolus amount delivered up to the cancellation can be reviewed in the BOLUS HISTORY screen. See the section “Review the Bolus History” (page 107) for more information.





CAUTION

When your insulin pump is in STOP mode, it does not deliver any insulin. Put the pump in RUN mode to continue the insulin delivery.

Note:

If a Temporary Basal Rate is active at the same time, it is also cancelled when your pump is put into **STOP** mode. An alert A8: BOLUS CANCELLED and an alert A6: TBR CANCELLED occur.

Press  twice to confirm and turn off the first alert. The second alert appears on the display. Press  twice to confirm and turn off the second alert. Both alerts are recorded in the alarm history.

See the sections “Alert A6: TBR CANCELLED” (page 152) and “Alert A8: BOLUS CANCELLED” (page 153) for more information.

Make sure that the cancellation was intended and then program a new Extended Bolus (and/or Temporary Basal Rate), if needed.

Programming a MultiWave Bolus

The MultiWave Bolus function is available in the ADVANCED user menu. It is designed to better simulate a body's insulin delivery. It combines an immediate bolus delivery followed by an Extended Bolus delivery. This function can be helpful when you have meals that include both rapid and slowly absorbed carbohydrates.

The duration of bolus delivery can be programmed in 15-minute intervals for up to 24 hours.

Note:

- The MultiWave Bolus is available in the ADVANCED user menu.
- You can add a Standard Bolus to an ongoing MultiWave Bolus. If you cancel the Standard Bolus, the MultiWave Bolus remains running.
- During the delivery of a MultiWave Bolus, the programming of a second MultiWave Bolus or an Extended Bolus is blocked. If you need a different MultiWave Bolus, put your pump in **STOP** mode to cancel the current bolus and program a new one.

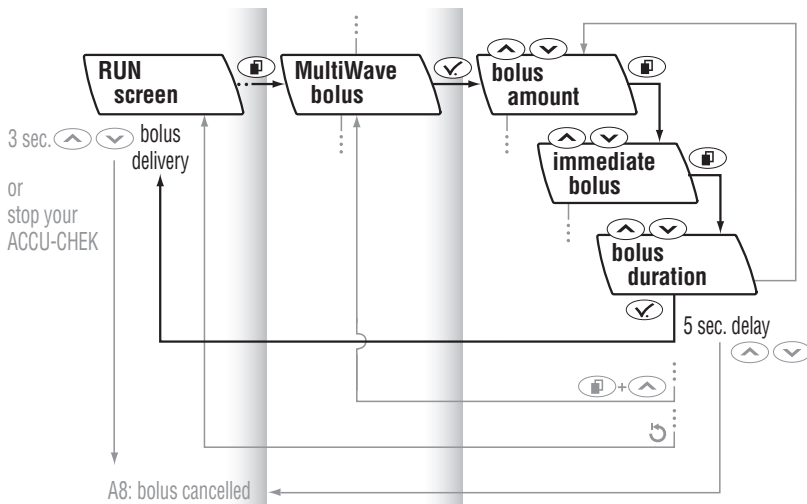

Follow the steps below:

1. Select the **ADVANCED** user menu or turn on the **MULTIWAVE BOLUS** menu choice in the **CUSTOM** user menu. Also, your pump must be in **RUN** mode.
2. Press to move to the **MULTIWAVE BOLUS** screen.

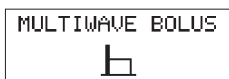

3. Press to select.

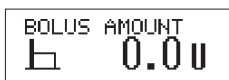

The **BOLUS AMOUNT** screen appears.

4. Press or to increase or decrease the total bolus amount.

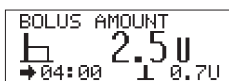



The first time you press , the bolus duration of the last MultiWave Bolus appears, except when you are using your pump for the first time, in which case, a default value appears.

As you increase or decrease the total bolus amount, the suggested immediate bolus amount increases or decreases proportionally.

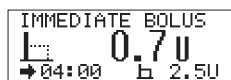

5. Press  to move to the IMMEDIATE BOLUS screen.

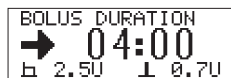

Press  or  to correct and set the immediate bolus amount.

6. Press  to move to the BOLUS DURATION screen.



Press  or  to correct and set the Extended Bolus duration in increments of 15 minutes for up to 24 hours.

Note:

Press  to loop between programming the total bolus amount, immediate bolus amount, and Extended Bolus duration.

7. Check the total and immediate bolus amounts and the extended bolus duration programmed on the display. The set values can be viewed in the BOLUS AMOUNT, IMMEDIATE BOLUS, and BOLUS DURATION screens.
8. Press  to confirm both bolus amounts and the bolus duration.

The MultiWave Bolus symbol () blinks for 5 seconds (bolus delivery start delay).

The pump beeps three times and the immediate bolus delivery begins. The countdown of the remaining bolus continues to appear on the display.

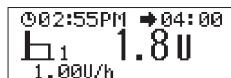

Note:



Once the immediate bolus is delivered, the remaining time, bolus amount, and the current hourly basal rate are displayed on the **RUN** screen.

If a Temporary Basal Rate is active at the same time, the remaining time and amount of the bolus and the amount of the increased or decreased hourly basal rate are displayed on the **RUN** screen.



Canceling a MultiWave Bolus

– **during programming** (a bolus amount or the bolus duration blinks):



There are three ways to cancel a MultiWave Bolus during programming:

- Do not press any key for 20 seconds. The pump returns to the **RUN** screen (timeout).
- Exit to the MULTIWAVE BOLUS screen by pressing  +  simultaneously.
- Set the total bolus amount to 0.0 units and press .
No bolus is delivered.

– **during the start delay** ( blinks):

- Press  or . The pump beeps and vibrates. The pump returns to the **RUN** screen. An alert A8: BOLUS CANCELLED occurs. Press  twice to confirm and turn off the alert.
No bolus is delivered. See the section “Alert A8: BOLUS CANCELLED” (page 153) for more information

– **during bolus delivery**:

- You can cancel the **immediate delivery** by pressing and holding  or  for 3 seconds until you hear a melody. This cancels the whole bolus (immediate and Extended Bolus delivery). An alert A8: BOLUS CANCELLED occurs.

Note:

If the alert A8: BOLUS CANCELLED does not occur, the bolus delivery was not cancelled. Cancel the extended delivery (see below).

- You can cancel the **extended delivery** by putting the pump in **STOP** mode. This cancels the Extended Bolus. An alert A8: BOLUS CANCELLED occurs. Press  twice to confirm and turn off the alert.

Bolus delivery is interrupted.

See the section “Alert A8: BOLUS CANCELLED” (page 153) for more information.

You can review the actual bolus amount delivered before the cancellation by looking at the bolus history. See the section “Review the Bolus History” (page 107) for more information.





CAUTION

When your insulin pump is in STOP mode, it does not deliver any insulin. Put your insulin pump in RUN mode to continue the insulin delivery.

Note:

If a Temporary Basal Rate is active at the same time, it is also cancelled when your pump is put in **STOP** mode. An alert A8: BOLUS CANCELLED and an alert A6: TBR CANCELLED occur.

Press  twice to confirm and turn off the first alert. The second alert appears on the display. Press  twice to confirm and turn off the second alert. Both alerts are recorded in the alarm history.

See the sections “Alert A6: TBR CANCELLED” (page 152) and “Alert A8: BOLUS CANCELLED” (page 153) for more information.

Make sure that the cancellation was intended and then program a new MultiWave Bolus (and/or Temporary Basal Rate), if needed.

Programming a Temporary Basal Rate (TBR)

Your pump lets you temporarily increase or decrease your basal rate. This lets you match changing insulin needs from increased or decreased activity level, illness, or stress.



Incorrect programming of your insulin pump may cause incorrect insulin delivery. Your insulin pump must be programmed with your personal settings prior to starting insulin pump therapy.

Do not operate your insulin pump without knowing your personal settings. If you are not sure about your personal settings or if you are less experienced, have your doctor or healthcare team check your personal settings.

Typically, a basal rate is set to 100%, but you can:

- ***Increase it to 200% for up to 24 hours***
- ***Decrease it to 0% for up to 24 hours***

When you increase or decrease your basal rate, each hourly basal rate for the duration you program is increased or decreased. The characteristic shape of your basal rate profile remains and does not become a flat curve, if the change is larger than 0%. For 0% the basal rate profile becomes a flat curve and no insulin (except boluses) is delivered during the programmed duration.

Discuss programming a Temporary Basal Rate with your doctor or healthcare team.

Note:

A running Temporary Basal Rate increase or decrease remains active, even if you changed the basal rate profile.

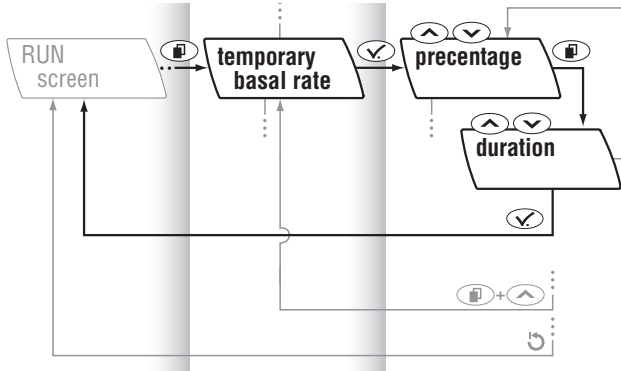

Follow the steps below:

1. Put your pump in **RUN** mode.
2. Press to move to the TEMPORARY BASAL RATE (TBR) screen.

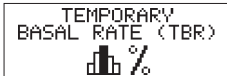

3. Press to select.

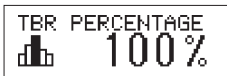

The TBR PERCENTAGE screen appears.

Note:

If no Temporary Basal Rate is currently active, the percentage is set to 100%. If a Temporary Basal Rate is active, its duration and percentage appear on the **RUN** screen.

4. Press or to increase or decrease the basal rate.

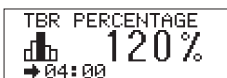

Note:

When you increase (or decrease) the Temporary Basal Rate the duration of your previous Temporary Basal Rate increase (or decrease) appears. When you use your pump for the first time, a default value appears.

5. Press  to move to the TBR DURATION screen.

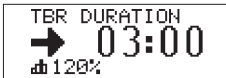

Press  or  to correct and set the duration.

Note:

Press  to loop between programming the basal rate percentage and duration.

6. Press  to save and exit.

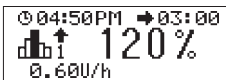

The new Temporary Basal Rate is immediately activated.



Note:

At any function screen you have three options to exit:

if you want to **save the changes**

- Press . Your pump returns to the **RUN** screen.

if you want to **undo the changes**

- Wait for your pump to return to the **RUN** screen (timeout), or
- Press  +  simultaneously (exit feature) to exit the function screen.
- Set volume to 100% and press .

Note:

During the Temporary Basal Rate delivery, the increase or decrease in percentage, the increased or decreased hourly basal rate (hourly basal rate plus TBR percentage), and the remaining time are displayed in the **RUN** screen. An arrow pointing up symbolizes a Temporary Basal Rate increase; an arrow pointing down symbolizes a Temporary Basal Rate decrease.

Note:

If an Extended Bolus or a MultiWave Bolus is active at the same time, the remaining time and amount of the bolus and the amount of the increased or decreased hourly basal rate are displayed in the **RUN** screen.



TBR OVER Alert

At the end of a Temporary Basal Rate, an alert A7: TBR OVER occurs. Press  twice to confirm and turn off the alert. See the section “Alert A7: TBR OVER” (page 153) for more information.

Cancelling a Temporary Basal Rate

– during programming:

There are three ways to cancel a Temporary Basal Rate during programming:

- Do not press any key for 20 seconds. The pump returns to the **RUN** screen (timeout).
- Exit to the TEMPORARY BASAL RATE (TBR) screen by pressing  +  simultaneously.
- Set the TBR percentage to 100%. Press  to save and exit.
No Temporary Basal Rate is delivered.

– during delivery:

There are two ways to cancel a Temporary Basal Rate during delivery:

- Set the TBR percentage to 100%:

1. Press  to move to the TEMPORARY BASAL RATE (TBR) screen.

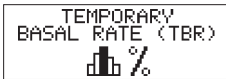

2. Press  to select.

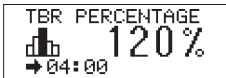

The TBR PERCENTAGE screen appears.

3. Press  or  to return the basal rate to 100%.

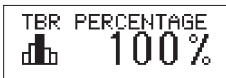

Press  to save and exit.

- Or, put your pump in **STOP** mode.

The Temporary Basal Rate delivery is interrupted.

An alert A6: TBR CANCELLED occurs. Press  twice to confirm and turn off the alert.





CAUTION

When your insulin pump is in **STOP** mode, it does not deliver any insulin. Put your insulin pump in **RUN** mode to continue the insulin delivery.

Note:

If an Extended Bolus or a MultiWave Bolus is active at the same time, it is also cancelled when your pump is put into **STOP** mode. An alert A8: BOLUS CANCELLED and an alert A6: TBR CANCELLED occur.

Press  twice to confirm and turn off the first alert. The second alert appears on the display. Press  twice to confirm and turn off the second alert. Both alerts are recorded in the alarm history.

See the sections “Alert A6: TBR CANCELLED” (page 152) and “Alert A8: BOLUS CANCELLED” (page 153) for more information.

Make sure that the cancellation was intended and then program a new Temporary Basal Rate (and/or an Extended or MultiWave Bolus), if needed.

Chapter 5: User Menus

You will need to access various screens so you can view stored information, program the pump, perform a function, or change a setting. Your pump offers a choice of three different user menus:

- **The STANDARD User Menu**

This menu offers all the functions you need for successful insulin pump therapy and lets you change between the user menus. If you are new to pump therapy, start with this menu. Later, as your comfort with pump therapy grows, you may choose the features offered in the ADVANCED user menu.

- **The ADVANCED User Menu**

This menu offers the full range of the ACCU-CHEK Spirit insulin pump functions. It includes all functions from the STANDARD user menu, plus a wide range of functions for the more experienced user.

- **The CUSTOM User Menu**

Because the ACCU-CHEK Spirit insulin pump has many features, you may want to choose the screens that you see when you scroll through the menu choices. This menu lets you display or hide other screens.

Note:

At the end of this user guide you will find diagrams for the STANDARD and ADVANCED user menus.

For your safety and convenience during programming, your insulin pump returns itself to the **RUN** or **STOP** screen if no key is pressed within 20 seconds. For your safety, the changes you made before your insulin pump “times out” will not be saved.

Selecting a User Menu

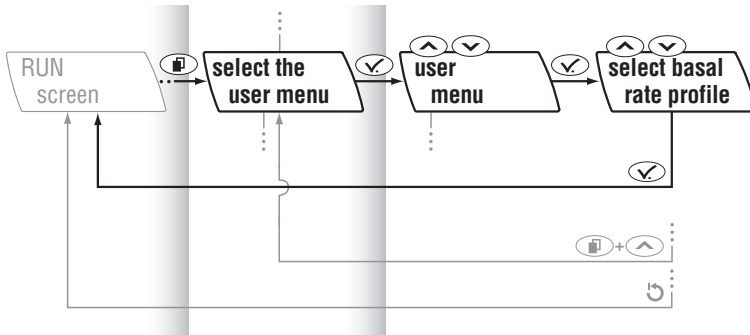

Note:

When you change the user menu, your current basal rate profile will not appear if it is not activated. Make sure that your desired basal rate profile number(s) is/are activated. This can be done through the previous user menu or the ADVANCED user menu.

Follow the steps below:

1. Press  to move to the SELECT USER MENU screen.



Press  to select.

2. The current user menu is selected on the SELECT USER MENU screen.



Press  or  to select a different user menu.

3. Press  to confirm.

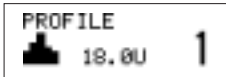

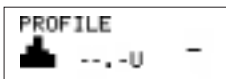

The selected basal rate profile and its daily insulin total appear,

or



if the previous basal rate profile is not available from the selected user menu, dashes appear instead.

4. Press  or  to select a basal rate profile, if needed.

Check the (new) basal rate profile and its daily insulin total.

5. Press  to save and exit. The new user menu and basal rate profile are active immediately.





CAUTION

A running increased or decreased Temporary Basal Rate will remain active, even if you changed the basal rate profile. The temporary basal rate is based on the new basal rate.

Note:

At any function screen you have three options to exit:

- If you want to **confirm** and **save the changes** press  until your pump returns to the **RUN** screen,
- If you want to **undo the changes** press  +  simultaneously to exit the function screen, or
- Wait for your pump to return to the **RUN** screen (timeout).

STANDARD User Menu

The following is a list of menu choices for the STANDARD user menu as they are addressed in the manual. To view the order in which they appear on the pump, refer to the menu diagrams at the back of the manual. Some of the functions have already been described earlier in the manual. The remaining functions are described following this list.

SET TIME AND DATE—See the section “Setting Time and Date” (page 32)

PROGRAM BASAL RATE PROFILE - See the section “Programming your Basal Rate Profile” (page 37)

CHANGE THE CARTRIDGE—See the section “Inserting the Cartridge” (page 49)

PRIME THE INFUSION SET—See the section “Priming the Infusion Set” (page 53)

START YOUR ACCU-CHEK—See the section “Starting Insulin Delivery” (page 65)

STOP YOUR ACCU-CHEK—See the section “Stopping Insulin Delivery” (page 66)

STANDARD BOLUS—See the section “Programming a Standard Bolus” (page 77)

EXTENDED BOLUS—See the section “Programming an Extended Bolus” (page 83)

TEMPORARY BASAL RATE (TBR)—See the section “Programming a Temporary Basal Rate (TBR)” (page 93)

COMMUNICATION—See the section “Data Transfer” (page 104)

INFORMATION—See the section “Reviewing Pump Data” (page 107)

SETUP MENU STANDARD—See the section “SETUP MENU Standard” (page 113)

SELECT USER MENU—See the section “Selecting a User Menu” (page 100)

Data Transfer

The pump memory stores up to 4,500 pump events (about 90 days of usage). Pump events include alerts and errors, programming operations, and insulin delivery records. Some or all of the pump memory may be transferable to compatible software.

The built-in infrared interface inside the bottom cover of your insulin pump allows for wireless data transfer.

Setup for Data Transfer

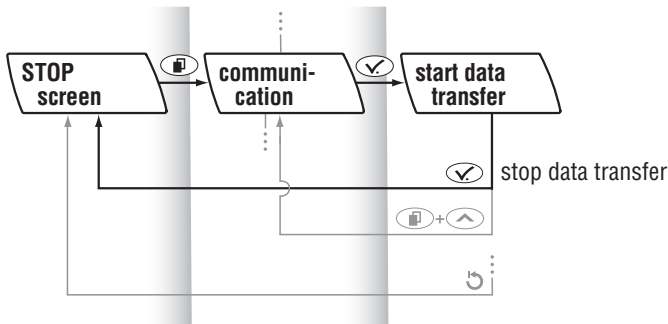

Follow the steps below:

1. Put your pump in **STOP** mode.



2. Press to move to the COMMUNICATION screen.





3. Press . The DATA TRANSFER screen appears and a melody signals that your pump is ready to deliver data.



When the data transfer is finished, press to return to the **STOP** screen. Set up your pump with a cartridge, adapter, and a new infusion set and put it in the **RUN** mode, if necessary.

Note:

Your pump returns to **STOP** mode 15 minutes after the last data transfer when the DATA TRANSFER screen is selected.

You may press  +  simultaneously to exit while data is being transferred. The data transfer is interrupted and an error E12: DATA INTERRUPTED occurs. See the section, “Error E12: DATA INTERRUPTED” (page 163) for more information.

Reviewing Pump Data

The pump memory lets you review specific data such as:

- Bolus history last 30 boluses
- Alarm history last 30 alerts and errors
- History of daily insulin totals last 30 daily totals of insulin delivered
- Temporary Basal Rate history last 30 increases and decreases
- Maintenance (pump timer) remaining time in days until the pump timer expires

Review the Bolus History

The bolus history lets you review up to the last 30 boluses delivered beginning with the most recent entry and working backward in time.

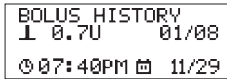

```
BOLUS HISTORY
└ 0.7U 01/08
⊙ 07:40PM 11/29
```

Each BOLUS HISTORY screen displays the:

- bolus type (└ Standard Bolus, □ Extended Bolus or └ MultiWave Bolus),
- bolus duration (→ only displayed if an Extended or a MultiWave Bolus),
- time (⊙)
- date (11/29) and
- entry number (01 is the most recent) of total entries (example 01/30) of a delivered bolus.

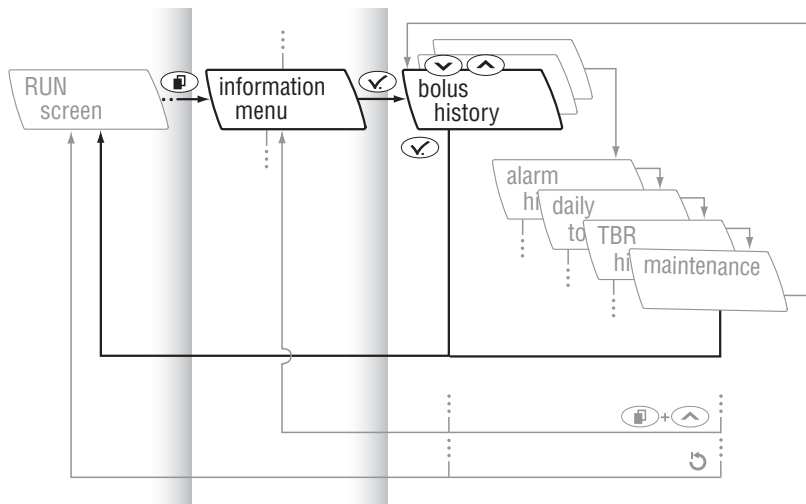

1. Press to move to the INFORMATION screen.



2. Press to select.

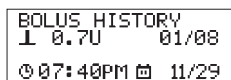

The BOLUS HISTORY screen appears. The most recent bolus information is displayed.

3. Press or to review the entries.

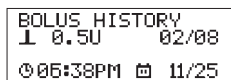





Press to exit.

Review the Alarm History

The alarm history lets you review the last 30 alerts or errors, beginning with the most recent entry and working backward in time.

Each alarm history screen displays the:

- number and type of the alert or error (example  A6),
- alert or error (example TBR CANCELLED),
- time () ,
- date () and
- entry number (01 is the most recent) of total entries (example: 01/30) of an alert or error.

1. Press  to move to the INFORMATION screen.



Press  to select.

2. Press  to move to the ALARM HISTORY screen.

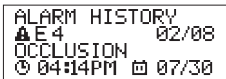

3. Press  or  to review the entries.

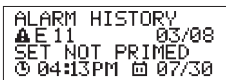

Press  to exit.

Review the History of Daily Insulin Totals

This history lets you review the last 30 daily totals of insulin delivered (from midnight to midnight; basal rate plus boluses), starting with the most recent entry and working backward in time.

Each daily insulin total screen displays the following history:

- daily total of insulin delivered (Σ),
- its date (11/29), and
- entry number (01 is the most recent) of total entries (example 01/30) of a daily insulin total.

Follow the steps below:

1. Press  to move to the INFORMATION screen.



Press  to select.

2. Press  to move to the DAILY TOTALS screen.

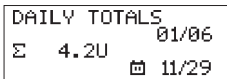

3. Press  or  to review the entries.

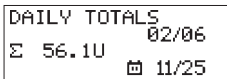

Press  to exit.

Review the Temporary Basal Rate History

The Temporary Basal Rate (TBR) history lets you review the last 30 TBR increases or decreases starting with the most recent entry and working backward in time.

Each TBR history screen displays the:

- TBR increase (↑) or decrease (↓) in percentage,
- TBR duration (→),
- time (⌚)
- date (📅) and
- entry number (01 is the most recent) of total entries (example 01/30) of a delivered Temporary Basal Rate.

Follow the steps below:

1. Press  to move to the INFORMATION screen.



Press  to select.

2. Press  to move to the TBR HISTORY screen.

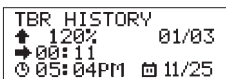

3. Press or scroll  or  to review the entries.

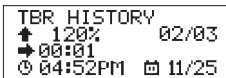

Press  to exit.

Review the Time Remaining

Your pump is designed to be a highly reliable system that will give you worry-free performance for a long time. For best performance, a pump timer limits the operating time of the pump. This timer counts the number of days of operation remaining for the ACCU-CHEK Spirit insulin pump.

Before the pump timer expires, an alert will remind you of the upcoming end of operating time so that you can arrange to get a new one. The pump timer symbol (🕒) appears in the **RUN** screen or **STOP** screen as a reminder. When the timer expires, an error occurs and your pump goes into **STOP** mode. It can no longer be put into **RUN** mode. See the sections “Alert A5: PUMP TIMER” (page 151) and “Error E5: END OF OPERATION” (page 158) for more information.

Review the number of days left until the pump timer expires in the INFORMATION menu.

Follow the steps below:

1. Press  to move to the INFORMATION screen.



Press  to select.

2. Press  to move to the PUMP TIMER screen.

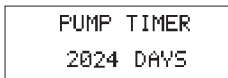

The days until the pump timer expires is shown.

3. Press  to exit.

SETUP MENU Standard

The SETUP MENU Standard should not be confused with the STANDARD user menu. The SETUP MENU Standard is a menu choice that appears in STANDARD and ADVANCED user menus. The SETUP MENU Standard allows you to “set up” certain features and settings. The following features and settings can be changed using the SETUP MENU Standard menu choice.

Turning KeyLock On or Off

The KeyLock function lets you lock the four keys of your pump and serves as an extra safety measure against activating functions by accident (for example, while sleeping, during contact sports). To use the KeyLock function, it must be turned on. See the section “Keys and Key Combinations” (page 11) for more information.

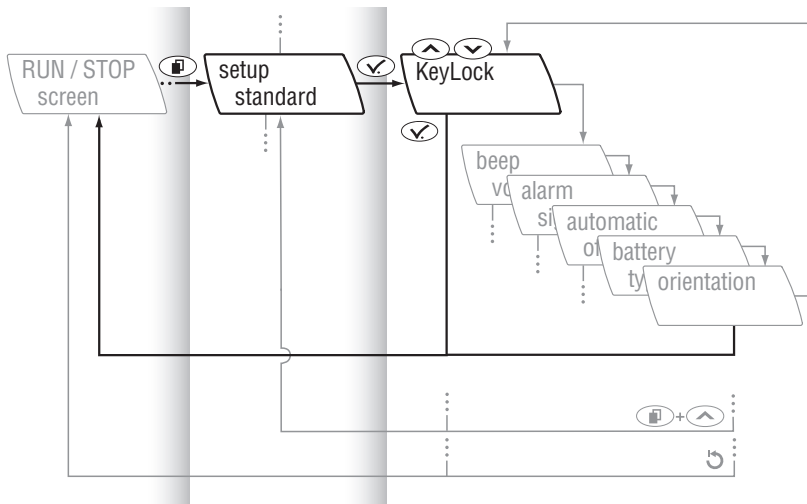

Follow the steps below:

1. Press  to move to the SETUP MENU STANDARD screen.

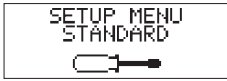

Press  to select.

2. The current KeyLock status (ON or OFF) appears.



3. Press  or  to turn the KeyLock ON or OFF.



Press  to save and exit.

If no key is pressed for 10 seconds after your pump has returned to the **RUN** screen or **STOP** screen and if the KeyLock is turned on, all four keys are locked.

Unlocking the KeyLock

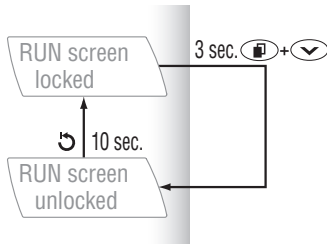

Follow the steps below:

1. From the **RUN** or the **STOP** screen, press + simultaneously (you hear three beeps in **RUN** mode one beep in **STOP** mode) and hold for 3 seconds until you again hear three beeps (in **RUN** mode) one beep (in **STOP** mode) to confirm that the KeyLock is unlocked.

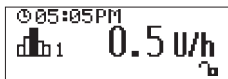

2. If no key is pressed for 10 seconds after your pump has returned to the **RUN** or the **STOP** screen, all four keys are automatically locked.

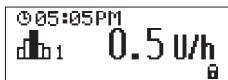

Adjusting the Beep Volume

Your pump beeps when a key is pressed or when an alert or error occurs.

Follow the steps below:

1. Press  to move to the SETUP MENU STANDARD screen.



Press  to select.





2. Press  to move to the BEEP VOLUME screen.



The active beep volume is displayed.

3. Press  or  to adjust the beep volume.

There are five volume levels:

-  no beeps (beeps are turned off)
-  very low
-  low
-  normal
-  maximum

4. Press  to save and exit.



Note:

The volume of the STOP-Warning is independent of the programmed beep volume. It always occurs at the maximum level. When the beeps are turned off and an alert or error occurs, the beeps will become active again after a short period of time to make sure that you are aware of the alarm or error. These beeps will steadily increase in volume until the maximum level is reached if the alert or error is not cancelled.

Setting Up Alarm Signals

The ACCU-CHEK Spirit insulin pump lets you choose how you want your pump to alert you when an alarm occurs.

You have three options:

-  beep only
-  vibrate only
-  beep and vibrate

Follow the steps below:

1. Press  to move to the SETUP MENU STANDARD screen.



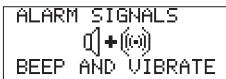

Press  to select.

2. Press  to move to the ALARM SIGNALS screen.



The active alarm signals are displayed.

3. Press  or  to set the alarm signals.

4. Press  to save and exit.

Automatic Off



Discuss using the automatic off function with your doctor or healthcare team.

CAUTION

Automatic off is a safety feature that stops insulin delivery and triggers an error E3: AUTOMATIC OFF if no keys are pressed within a programmed time period in **RUN** mode.

The automatic off can either be set to OFF or programmed up to 24 hours in 1-hour intervals in the SETUP MENU STANDARD screen.

Follow the steps below:

1. Press  to move to the SETUP MENU STANDARD screen.



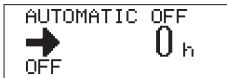

Press  to select.

2. Press  to move to the AUTOMATIC OFF screen.



The current status is displayed at the bottom left of the screen.

3. Press or scroll  to increase or  to decrease the duration for the automatic off in 1-hour intervals.

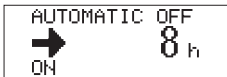

4. If you would like to set the automatic off function to OFF, press or scroll  until 0 hours and OFF appears on the display.

5. Press  to save and exit.

Battery Type



WARNING

If you do not set the correct battery type on your insulin pump, the alert A2: BATTERY LOW may not occur in time to provide you sufficient warning to replace your battery.

Your pump lets you choose between using 1.5 volt AA alkaline batteries or rechargeable AA NiMH batteries. If you change from one battery type to the other, you must also change the battery type setting.

See the section “Accessories and Disposables–Battery” (page 21) for more information on recommended batteries.

Follow the steps below:

1. Press  to move to the SETUP MENU STANDARD screen.



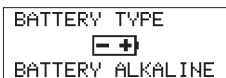

Press  to select.

2. Press  to move to the BATTERY TYPE screen.



The current battery type is displayed.

3. Press  or  to select the battery type ALKALINE or NiMH (rechargeable) battery.

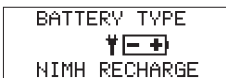

Press  to save and exit.

Display Orientation

Your pump lets you flip the display orientation by 180° so that you can view it more conveniently depending on how you are wearing the pump.

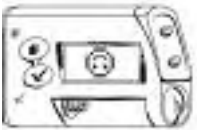

Follow the steps below:

1. Press  to move to the SETUP MENU STANDARD screen.



Press  to select.

2. Press  to move to the ORIENTATION screen.





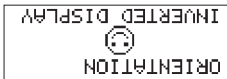





3. Press  or  to select the display orientation.



4. Press  to save and exit.



If you flip the display orientation of your insulin pump by 180°, the  and  keys will also reverse their functions. In comparison to the display orientation, the upper key will be the  and the lower key will be . This change applies for all  and  functions including turning on the backlight. The  and  will not change in their function, but will remain the same, regardless of your screen orientation.

ADVANCED User Menu

The ADVANCED user menu offers the full range of the ACCU-CHEK Spirit insulin pump functions. The ADVANCED user menu includes all functions from the STANDARD user menu, plus a wide range of functions for the more experienced user.

The following is a list of additional menu choices that appear in the ADVANCED user menu. Some of the functions have already been discussed earlier in the manual. The remaining functions are described below.

EXTENDED BOLUS—See the section “Programming an Extended Bolus” (page 83)

MULTIWAVE BOLUS—See the section “Programming a MultiWave Bolus” (page 88)

CHANGE BASAL RATE PROFILE—See the section “Selecting a Basal Rate Profile” (page 125)

PROGRAM BASAL RATE PROFILE—See the section “Programming Additional Basal Rate Profiles” (page 124)

ALARM CLOCK—See the section “Alarm Clock” (page 127)

SETUP MENU ADVANCED—See the section “SETUP MENU Advanced” (page 129)

Basal Rate Profiles

Your pump can store up to five different basal rate profiles to match your changing insulin needs (for example, Monday-Friday versus Exercise Day versus Sleeping Late Day).

Discuss additional basal rate profiles with your doctor or healthcare team. Consult with your doctor or healthcare team before changing basal rate profiles, as this may change how you use your pump.

Programming Additional Basal Rate Profiles



WARNING

Incorrect programming of your insulin pump may cause incorrect insulin delivery. Your insulin pump must be programmed with your personal settings prior to starting insulin pump therapy. Do not operate your insulin pump without knowing your personal settings. If you are not sure about your personal settings or you are less experienced, have your doctor or healthcare team check your personal settings.

Follow the steps below:

1. Press  to move to the PROGRAM BASAL RATE PROFILE screen.

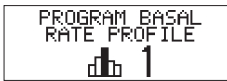

Note:

Only basal rate profiles that are accessible in your current user menu are available.

2. The hourly basal rates for each additional basal rate profile are set in the same way as for basal rate profile 1. See the section “Programming your Basal Rate Profile” (page 37) for more information.

Selecting a Basal Rate Profile

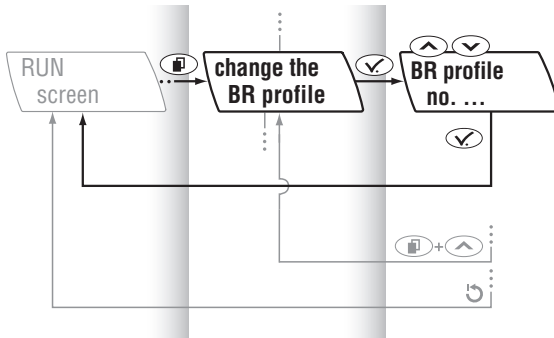

Follow the steps below:

1. Press to move to the CHANGE BASAL RATE PROFILE screen.



2. Press to select.

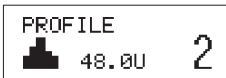

The current basal rate profile is displayed.

Note:

Only basal rate profiles that are accessible in your current user menu are available.

3. Press or to select a basal rate profile. The selected basal rate profile and its daily insulin total appear.
4. Press to select. The new basal rate profile is active immediately.

Note:

When you change your user menu your current basal rate profile may not appear.

If the basal rate profile number(s) you want does not appear,

- Select the **ADVANCED** user menu, or
- Program the basal rate profile to an available basal rate profile number

A running Temporary Basal Rate increase or decrease stays active, even if you change the basal rate profile on your pump.

Alarm Clock

You can set the alarm clock for a single alarm or for multiple alarms. Multiple alarms repeat at the set time every day. Alarms can be set to remind you of blood glucose testing or other important events.

Set Single or Multiple Alarms

1. Press  to move to the ALARM CLOCK screen.



2. Press  to select. The current alarm clock status (OFF, ONCE, or EVERY DAY) and alarm time appear.

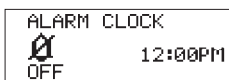

3. Press  or  to change the alarm clock to OFF, ONCE () or EVERY DAY ().

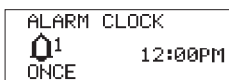

4. Press  to move to the SET ALARM HOUR screen.

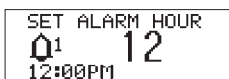

Press  or  to set the hour.

5. Press  to move to the SET ALARM MINUTE screen.

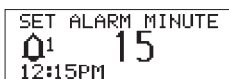

Press  or  to set the minute.

6. Press  to save and exit.

Turning Off the Alarm Clock

When the alarm clock goes off, an alert A4: ALARM CLOCK occurs. Press  twice to confirm and turn off the alert.

See the section “Alert A4: ALARM CLOCK” (page 151) for more information.

SETUP MENU Advanced

The SETUP MENU Advanced should not be confused with the ADVANCED user menu. The SETUP MENU Advanced is a menu choice that appears in the ADVANCED user menu. The SETUP MENU Advanced allows you to “set up” certain features and settings. The following features and settings can be changed using the SETUP MENU Advanced menu choice.

Time Format

You can set the time in either of the following formats:

American: 12-hour clock (AM/PM), example 1:39 PM
European/Military: 24-hour clock (00:00-23:59), example 13:39

Follow the steps below:

1. Press  to move to the SETUP MENU ADVANCED screen.



Press  to select.

2. The TIME FORMAT screen appears.

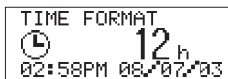

Press  or  to select a time format.

3. Press  to save and exit.

Date Format

You can set the date in the following formats:

American: mm/dd/yyyy, example 04/26/06

European: dd.mm.yyyy, example 26.04.06

Follow the steps below:

1. Press  to move to the SETUP MENU ADVANCED screen.



Press  to select.

2. Press  to move to the DATE FORMAT screen.





Press  or  to select a date format.



3. Press  to save and exit.

Bolus increment



WARNING

The bolus increment that can be programmed into your insulin pump determines the “Quick” Standard Bolus amount using the  and  keys of your insulin pump. Incorrect programming of the bolus increment may cause inappropriate insulin delivery.

To address patients who may need large or small amounts of insulin, the bolus increment for the ACCU-CHEK Spirit insulin pump is adjustable. The “Quick” Standard Bolus is initially set to 0.5 units per key press but can be changed in the SETUP MENU ADVANCED to 0.1, 0.2, 0.5, 1.0, or 2.0 units. Units for the scroll “Standard” bolus, which may be adjusted by simply holding down the  or  keys, will move at a constant 0.1 units. See the section “Programming a Standard Bolus” (page 77) for more information.

Follow the steps below:

1. Press  to move to the SETUP MENU ADVANCED screen.



Press  to select.

2. Press  to move to the BOLUS INCREMENT screen.

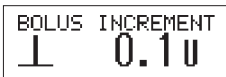

Press  or  to select a bolus increment.

3. Press  to save and exit.

Prime Quantity

The prime quantity needed to fill an infusion set depends on the length of the infusion set tubing being used. The shorter your infusion set tubing, the less insulin will be required to prime the infusion set. The default setting for the prime quantity is 25 units of U100 insulin.

Note:

The amount of insulin used for the priming is not added to the history of daily insulin totals. You can press any of your pump's keys to stop priming.

Follow the steps below:



1. Press  to move to the SETUP MENU ADVANCED screen.

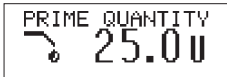

Press  to select.

2. Press  to move to the PRIME QUANTITY screen.



Press  or  to select a prime quantity between 0.0 and 30.0 units.

3. Press  to save and exit.

Lock Basal Rate Profiles

Your pump lets you change your hourly basal rates as needed. You may lock your basal rate profiles to provide extra protection against accidentally changing a basal rate during normal operation. When this function is activated, your hourly basal rates cannot be changed.

Follow the steps below:

1. Press  to move to the SETUP MENU ADVANCED screen.



Press  to select.



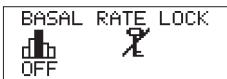





2. Press  to move to the BASAL RATE LOCK screen.



Press  or  to turn the basal rate lock ON or OFF.

3. Press  to save and exit.

Note:

If the basal rate lock is set to ON (), the programming of the basal rate profiles 1, 2, 3, 4, and 5 is blocked. To check if the basal rate lock is ON, press  to move to the PROGRAM BASAL RATE screen and press  to select. The  symbol in the BASAL RATE TOTAL screen indicates the lock of the basal rate programming. (The  symbol appears in the BASAL RATE TOTAL screen only.) Press  to view the hourly basal rates. The  and  functions are blocked.

Language

Your pump is programmed in several languages. These languages include Italian, English, German, French, Spanish, Portuguese, Czech, Dutch, Swedish, Norwegian, Polish, and Greek.

To choose a language, do the following:



1. Press  to move to SETUP MENU ADVANCED screen.



Press  to select.

2. Press  to move to the LANGUAGE screen.



Press  or  to select a language.

3. Press  to save and exit.

Display Contrast

Your pump lets you adjust the display contrast.

Follow the steps below:



1. Press  to move to the SETUP MENU ADVANCED screen.



Press  to select.

2. Press  to move to the DISPLAY CONTRAST screen.



Press  or  to select a contrast level.

3. Press  to save and exit.

CUSTOM User Menu

The CUSTOM user menu contains the 11 most commonly used functions according to a customer survey.

The following is a list of the functions included in the CUSTOM user menu. All of these functions have been addressed in detail in STANDARD and ADVANCED user menu sections.

- STANDARD BOLUS
- EXTENDED BOLUS
- TEMPORARY BASAL RATE (TBR)
- INFORMATION
- CHANGE BASAL RATE PROFILE
- PROGRAM BASAL RATE PROFILE 1
- PROGRAM BASAL RATE PROFILE 2
- ALARM CLOCK
- SET DATE AND TIME
- SETUP MENU STANDARD
- SELECT USER MENU

Chapter 6: Care and Maintenance

Care of Your ACCU-CHEK Spirit Insulin Pump



CAUTION

Do not perform any servicing or repair on your insulin pump. For servicing or repairs contact Pump Support at 1-800-688-4578.

Disetronic Medical Systems, as the manufacturer, guarantees the functions of your pump according to its specifications only if all servicing of your pump is done and/or authorized by Disetronic Medical Systems.

System Inspection Checklist

Your pump must be well maintained to guarantee accurate insulin delivery.

Check the pump display at least every three hours during the day and before you go to sleep, and especially if for any reason you might not be able to hear the beeps or to feel the vibrations. Use only sterile products and accessories designed to be used with your pump. Replace and discard these items according to your doctor's or healthcare team's recommendations and the instructions that come with these items.

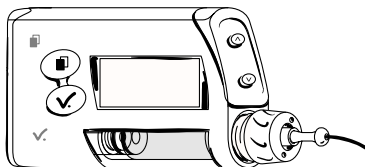

Check your pump daily. Make sure that:

- The pump casing, the display, and the cartridge are not chipped or cracked and that the display doesn't show incomplete or abnormal letters or symbols.
- You visually inspect the cartridge. Make sure that the actual amount of insulin in the cartridge equals the displayed cartridge amount on the QUICK INFO screen.
- **You inspect all parts of your pump and infusion set at least every three hours during the day and before you go to sleep.** If you detect any loss of insulin, immediately replace the leaking component.
- The battery cover is correctly tightened and positioned even with the pump casing.
- The adapter is inserted properly.
- Your infusion set is primed, free of air bubbles, and tight in the adapter.
- Your infusion set is inserted according to the instructions for its use.
- Your infusion site is secure, comfortable, and free of irritation or infection.
- The cartridge is free of air bubbles.
- Your pump is in **RUN** mode.
- The basal rates are set correctly according to your doctor's or healthcare team's recommendations.
- The time and date are set correctly.
- The Temporary Basal Rate changes are set according to your doctor's or healthcare team's recommendations.
- The beeps and/or vibrations are set.
- You have your personal emergency kit.

What to Do When You Drop Your Pump

If the pump is dropped it could be harmed or the seal that protects it against water could be damaged. Be careful not to drop your pump. Use the proper ACCU-CHEK Spirit insulin pump carrying system to help avoid dropping your pump. See Disetronic Medical Systems sterile products and accessories catalogs and brochures for more information. Or, contact Pump Support at 1-800-688-4578.

If your pump is dropped:

- Check that all connections in your infusion set are still tight, and if they are not, reconnect or tighten them
- Check your pump, its sterile products, and accessories for chips and cracks, and
- Change the cartridge if it is damaged.



CAUTION

Check your insulin pump and its sterile products and accessories at least every three hours. Immediately inspect your insulin pump if it is dropped. Do not use your insulin pump if chips or cracks are visible. Chips and cracks may allow water, dust, insulin, or other foreign substances to enter your insulin pump and lead to malfunction.

If you have questions or are not sure whether your pump has been damaged, contact Pump Support at 1-800-688-4578.

Storing Your ACCU-CHEK Spirit Insulin Pump



CAUTION

When your insulin pump will not be in use for a long period of time, it should be properly stored, to prevent a malfunction.

To store your pump, place in STOP mode, then:

- Remove the battery to preserve the battery life
- Remove the cartridge
- Insert the battery cover and the adapter
- Store your pump in its shipping case

Storage Conditions

Temperature	41°F to 113°F (+5°C to +45°C)
Air humidity	5 to 85% relative air humidity
Barometric pressure	700 to 1060 mbar

Disposal

Your ACCU-CHEK Spirit Insulin Pump

If you need to dispose of your insulin pump, return it to Disetronic Medical Systems for professional disposal.

Battery

Properly dispose of dead batteries.

Cartridge, Infusion Set, Adapter, and Accessories

Dispose of these items in your normal garbage. Remember to dispose of the introducer needle safely (needle container). To prevent injury to others, replace the needle protective cap or insert the needle of the infusion set into a disposable object, or put it in a hard shell container.

Maintenance

Cleaning Your ACCU-CHEK Spirit Insulin Pump

The best time to clean your pump is when you change the cartridge. Use a soft, dry cloth for cleaning. If the pump compartments are very dirty, contact Pump Support at 1-800-688-4578 for more instructions.



CAUTION

Always remove the cartridge and adapter and place your insulin pump in STOP mode while cleaning. Avoid pressing the keys of your insulin pump during cleaning, as this may accidentally change your settings. Do not use alcohol, solvents, strong detergents, bleaching agents, scouring pads, or sharp instruments for cleaning as they may damage the pump.

Battery Information

It is important to change your battery regularly and to have spare batteries ready. The life of any battery is affected by how you use your insulin pump, your personal settings, delivery rates, temperature, and other factors. With typical pump use [50 U/day using U100 insulin; operating temperature 72°F ± 6°F (22°C ± 3°C)], pump battery life is about four weeks using alkaline batteries and one week using rechargeable batteries. See the section “Accessories and Disposables—Battery” (page 21) for more information on recommended batteries. See the section “Inserting (or Changing) the Battery” (page 25) for instructions on how to change your battery.

Repair



CAUTION

Do not perform any servicing or repair on your insulin pump. Do not use any lubricants on the pump mechanism. If you have questions, contact Pump Support at 1-800-688-4578.

If you have problems with your pump, contact Pump Support at 1-800-688-4578. Pump Support can help you and answer many questions over the telephone. Pump Support may direct you to return your pump to Disetronic Medical Systems for repair. For example, you might need to return your pump if an alert or error could not be cleared by following the procedures described in “Alerts and Errors.” (page 147). If Pump Support directs you to return your pump, they will give you a Return Material Authorization (RMA) number that you must include with the pump when you send it.

If you must ship your pump, carefully pack the pump and the used cartridge, battery, battery cover, adapter, and infusion set to avoid damage to them during transportation. Place your pump back in the shipping case and put the case in a package that will not rip or tear. It is best to send your pump using a shipping method and carrier that tracks the shipment.

When you return your pump, include the following:

- a description of the reason for returning your pump
- your name and address
- your daytime phone
- the serial number of your pump, and
- any RMA (Return Material Authorization) number received from Pump Support.

By returning your pump to Disetronic Medical Systems, you allow Disetronic Medical Systems to undertake any testing on your infusion pump that is needed for a proper inspection, and understand that your pump may not be returned to you.

Troubleshooting

This section describes problems that may occur while using your ACCU-CHEK Spirit insulin pump. See “Alerts and Errors” (page 147) for more information.

Note:

The solutions in this guide are only suggestions. Do not use these procedures without approval of your doctor or healthcare team. Always follow your doctor’s or healthcare team’s recommendations, and contact them if you have any concerns about your insulin pump therapy.

You need to know that the interruption of insulin delivery (due to a leak, occlusion, or loss of insulin potency, for example) or the malfunction of your insulin pump can result in a rapid rise of your blood glucose level. Although your pump has an internal security check system, it cannot alert you if your infusion set is leaking or if the insulin you are using has lost its potency.

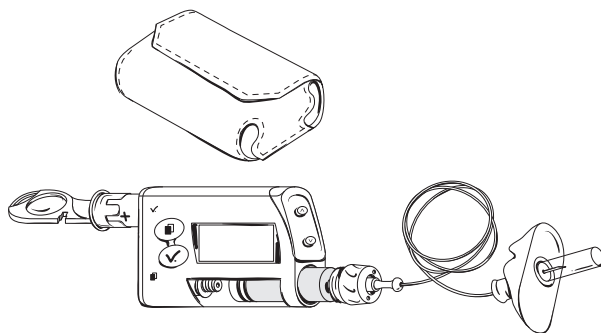

Therapy-Related Issues

Many factors, such as alcohol consumption, medications other than insulin, ineffective or expired insulin, decreased activity, illness, and stress can affect blood glucose levels. Contact your doctor or healthcare team for advice on how to manage these or any other therapy related issues.

Troubleshooting Table

Problem	Recommended Actions
Individual characters, numbers, or symbols on the display are shown incompletely or not at all.	Contact Pump Support at 1-800-688-4578.
Your insulin pump does not beep or vibrate.	Check that the beep volume and alarm signals are turned on. Check and change the battery. If your insulin pump still does not beep or vibrate, contact Pump Support at 1-800-688-4578.
Self-test incomplete (after an error E7: ELECTRONIC ERROR).	Remove the battery, wait a few seconds, and insert it again. If the self-test remains incomplete, contact Pump Support at 1-800-688-4578.
Incorrect insulin delivery due to incorrect time setting.	The correct hourly basal rate cannot be delivered if the time is not set correctly. Check and reset the time if it is wrong. Do the same check when you change the battery.
Incorrect insulin delivery due to incorrect basal rate programming.	Always review changes made in basal rate programming. Confirm that you are using your correct basal rate profile.

Problem	Recommended Actions
Air bubbles in the cartridge and/or infusion set	<p>Check blood glucose level. <i>In the cartridge:</i> Disconnect the infusion tube set from the headset and re-prime your infusion tube set. If the air bubbles remain, replace the cartridge. Make sure to fill the cartridge with insulin at room temperature. <i>In the infusion set:</i> Disconnect and prime your infusion set.</p> <p>Reconnect and make sure all connections are tight and secure.</p>
Blood in the infusion set tubing	Change your infusion set and infusion site.
Empty cartridge	Replace the cartridge. Cartridges are for single use only .
Disconnected or dislodged infusion set	Make sure all connections are tight. Inspect connections for leaking insulin. Check your blood glucose level. Change your infusion set and infusion site.
Leak in system	Check for leaking insulin at all connections and on the skin. Change your infusion set, infusion site, cartridge, and adapter. Check your blood glucose level.

Problem	Recommended Actions
Occlusion in system	Disconnect and re-prime your infusion set. Check your blood glucose. If the occlusion remains, prime the pump without the cartridge inserted. See the section “Error E4: OCCLUSION” (page 156).
Failure to complete prime	Re-prime the infusion set. Always prime until a bubble-free insulin flow emerges from the tip of the needle. Make sure the tubing is free of air.
Poor absorption of insulin	Choose infusion sites that do not have scar tissue, bruises, or tissue build-up. Do not use the same infusion set or infusion site longer than your doctor or healthcare team recommends.
Infusion site becomes sore, red, or swollen.	Change your infusion headset and infusion site immediately. Use proper insertion technique. Check blood glucose level. Follow the planned infusion site rotation pattern and advice given by your doctor or healthcare team.

Chapter 7: Alerts and Errors

A safety system monitors and controls the function of your pump. This safety system performs more than 9 million safety checks every day. If it detects a change from the pump's normal state, it will trigger an alert (warning instruction) or an error (error message). Beeps, vibrations, and messages on the pump display indicate the cause of an alert or error. Alerts and errors are the only way you will be quickly notified of any changes in your pump.



CAUTION

Check the pump display at least every three hours during the day, and before you go to sleep, and especially if you might be not be able to hear the beeps or feel the vibrations.

Your pump gives alerts and errors using beeps and vibrations. You can turn off either the beeps or the vibrations, but for your safety you cannot turn off both at the same time for the initial alarm signal.



If you do not confirm an alert or error within 60 seconds, it will signal again. When the beep is turned off or programmed at lower than maximum volume level, the beep volume will rise to the loudest volume level if not confirmed. The beep and vibration will continue at this level until confirmed.

Note:

The volume of the STOP-Warning is separate from the programmed beep volume and cannot be changed. It always occurs at the maximum level.

KeyLock is unlocked by the system each time an alert or error occurs.

Confirming an Alert or Error



When you confirm A1: CARTRIDGE LOW , E1: CARTRIDGE EMPTY, A2: BATTERY LOW , E2: BATTERY DEPLETED, A5: PUMP TIMER  or E5: END OF OPERATION, the symbol for that alert or error stays in the **RUN** screen or **STOP** screen as a reminder. For other alerts or errors, alarm information is cleared from the display but stays in the alarm history and the event memory.

Follow the steps below to confirm an alert or error:

1. Press  to turn off the beeps and vibrations.



The alert or error code stays on the display.

2. As soon as you understand the reason for the alert, error code, or message, confirm by pressing  again.
3. Take the appropriate action, if any.
4. If more than one alert and/or error occurs simultaneously, press  twice for each alert or error to confirm and turn each off.
5. After an alert or error, make sure that your pump is returned to **RUN** mode.

List of Alerts



WARNING

After an alert occurs, your insulin pump may be in **STOP** mode and the insulin delivery may be interrupted. In order to maintain insulin delivery, you must act immediately according to the instructions given for each error code or put your insulin pump in **RUN** mode to continue the insulin delivery.

Alert A1: CARTRIDGE LOW

The contents of the insulin cartridge have dropped to 20 units of insulin. Be prepared to replace the cartridge as soon as possible. The cartridge low symbol () appears in the **RUN** or **STOP** screen as a reminder until you change the cartridge.

1. Press  twice to turn off and to confirm the alert.





Change the cartridge before it is empty.

2. If necessary, put your pump in **RUN** mode.

See the section “Changing the Cartridge and Infusion Set” (page 73) for more information.

Alert A2: BATTERY LOW

The battery power is low. Be prepared for a battery change as quickly as possible. The battery low symbol () appears in the **RUN** or **STOP** screen as a reminder until you change the battery.

1. Press  twice to turn off and to confirm the alert.



Replace the battery as soon as possible (within a few hours). Failure to change the battery within a few hours of receiving the alert could result in additional error messages.

2. If necessary, put your pump in **RUN** mode.

See the section “Accessories and Disposables–Battery” (page 21) for more information on recommended batteries. See the section “Inserting (or Changing) the Battery” (page 25) for instructions on how to change your battery.

Alert A3: REVIEW TIME AND DATE

The pump was without power for more than one hour. The ACCU-CHEK Spirit insulin pump settings and history data are saved in memory regardless of power loss. However, it may be necessary to enter the time and date again.

1. Press  twice to turn off and to confirm the alert.

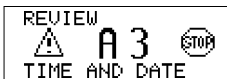

Review the time and date and correct them, if they are wrong.

2. If necessary, put your pump in **RUN** mode.

See the section “Setting Time and Date” (page 32) for more information.

Alert A4: ALARM CLOCK

An alarm clock reminder was programmed into the pump.

1. Press  twice to turn off and to confirm the alert.



2. If necessary, put your pump in **RUN** mode.

Note:

If you have set the alarm occurrence to EVERY DAY, the same alert occurs every 24 hours. Turn the alarm clock function OFF if you do not want the alarm to go off again at that same time every day.

See the section “Alarm Clock” (page 127) for more information.

Alert A5: PUMP TIMER

Your pump’s operating time will expire soon. It is recommended that you replace your pump after a period of four years of running time. After the alert A5: PUMP TIMER occurs, the ACCU-CHEK Spirit insulin pump will display the symbol  to remind you to check the timer.

1. Press  twice to turn off and to confirm the alert.



2. Put your pump in **RUN** mode.
3. Go to the INFORMATION screen on your pump.



4. Move to the PUMP TIMER screen.

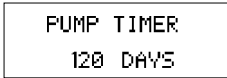

The days until the pump timer expires are shown.

When the PUMP TIMER reaches zero, the pump will change to **STOP** mode and no longer operate. An error, E5: END OF OPERATION, will appear on the display. Contact Pump Support at 1-800-688-4578 to discuss your options for further use of your ACCU-CHEK Spirit insulin pump.

Note:

The alert A5: PUMP TIMER ALERT and the error E5: END OF OPERATION are based on running time (the total time the pump is in **RUN** mode) and not calendar years. However, the warranty is based on the date the pump was purchased.

See the section “Review the Time Remaining” (page 112) for more information.

Alert A6: TBR CANCELLED (Temporary Basal Rate Cancelled)

A temporary increase or decrease of the basal rate has been cancelled.

1. Press  twice to turn off and to confirm the alert.



2. If necessary, put your pump in **RUN** mode.

3. Make sure that the cancellation was intended and then program a new Temporary Basal Rate if needed.

Alert A7: TBR OVER (Temporary Basal Rate Over)

A Temporary Basal Rate has ended. The original basal rate (100%) will resume automatically once the alert has been confirmed.

1. Press  twice to turn off and confirm the alert.



2. Decide whether a further Temporary Basal Rate change is needed. If necessary, program a new Temporary Basal Rate.

Alert A8: BOLUS CANCELLED

A bolus was cancelled during the start delay or after delivery began.

1. Press  twice to turn off and to confirm the alert.

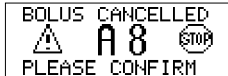

2. If necessary, put your pump in **RUN** mode.
3. Make sure that the cancellation was intended and then program a new bolus if needed.

Note:

The actual bolus amount that was delivered before the cancellation can be reviewed in the bolus history. See the section “Review the Bolus History” (page 107) for more information.

List of Errors



WARNING

After the occurrence of an error, your insulin pump will be in **STOP** mode and the insulin delivery is interrupted. In order to maintain insulin delivery, you must act immediately according to the instructions given for each error code.

Error E1: CARTRIDGE EMPTY

The insulin cartridge is empty. Change the cartridge immediately.

1. Press  twice to turn off and to confirm the error.



2. Disconnect or remove the infusion set from your infusion site.
3. Change the cartridge and prime the infusion set.
4. Reconnect the infusion set at your infusion site.
5. Put your pump in **RUN** mode.

See the section “Changing the Cartridge and Infusion Set” (page 73) for more information.

Error E2: BATTERY DEPLETED

The battery is out of power. Replace it immediately.



WARNING

After inserting a new battery, always check that the time and date of your insulin pump are set correctly. Incorrect programming of the time and date may cause incorrect insulin delivery. If you, your doctor, or healthcare team store and analyze your therapy data electronically and the time and date of the devices used are not set identically, the gathered data might not be meaningful.

1. Press  twice to turn off and to confirm the error.



2. Replace the battery.
3. Put your pump in **RUN** mode.

Note:

Your pump stores the settings you saved before the battery power ran out. If your pump is without power for more than one hour, check the time and date.

See the section “Accessories and Disposables–Battery” (page 21) for more information on recommended batteries. See the section “Inserting (or changing) the Battery” (page 25) for instructions on how to change your battery.

Error E3: AUTOMATIC OFF

Automatic off is a safety feature that stops insulin delivery and triggers an error E3: AUTOMATIC OFF if no keys are pressed within a programmed time period in **RUN** mode.

1. Press  twice to turn off and to confirm the error.



2. Put your pump in **RUN** mode.

Error E4: OCCLUSION



WARNING

If an error E4: OCCLUSION occurs, immediately check your blood glucose level, and check again in about 2 hours, because insulin delivery has been interrupted. If your blood glucose level is high, take appropriate actions according to your doctor's or healthcare team's instructions.

Insulin (a maximum of 3.5 units of U100 insulin) was not delivered. This may be due to:

- a blocked infusion set,
- a reused cartridge, or
- a dirty or damaged piston rod.

Note:

The display of this error depends on several factors including your current hourly basal rate and boluses. For example, a blocked infusion set with a basal rate of 2.0 U/h (U100 insulin and no additional boluses) would trigger an error E4: OCCLUSION in approximately three hours or less, depending on the type and severity of the blockage.

If the occlusion (blockage) was inside your infusion set, follow the steps below.

1. Press  twice to turn off and to confirm the error.

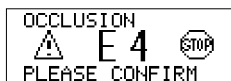

2. Disconnect or remove the infusion set from your infusion site.
3. Change the infusion set and prime it.
4. Reconnect the infusion set (tubing) at your infusion site.
5. Put your pump in **RUN** mode.

In rare cases, the cartridge itself can be the cause of the occlusion. If an error E4: OCCLUSION occurs again, you must change the cartridge. Follow the steps below:

1. Press  twice to turn off and to confirm the error.
2. Disconnect or remove the infusion set from your infusion site.
3. Change the cartridge and prime the infusion set.
4. Reconnect the infusion set (tubing) at your infusion site.
5. Put your pump in **RUN** mode.

If the error E4: OCCLUSION occurs again, prime your pump without a cartridge. Follow the steps below:

1. Press  twice to turn off and to confirm the error.
2. Disconnect or remove the infusion set from your infusion site.
3. Remove the cartridge, adapter and infusion set from your pump.
4. Carry out the PRIME THE INFUSION SET function without the cartridge, adapter, and infusion set inserted.
5. Insert a new cartridge with connected adapter and infusion set.
6. Prime the infusion set.
7. Reconnect the infusion set (tubing) at your infusion site.
8. Put your pump in **RUN** mode.

If the error E4: OCCLUSION continues to occur, contact your doctor or healthcare team for an alternate therapy plan. Contact Pump Support at 1-800-688-4578 for more assistance.

Error E5: END OF OPERATION

Your pump timer has reached zero. The pump will change to **STOP** mode and will no longer operate. An error E5: END OF OPERATION will appear on the display. It is recommended that you replace your pump after four years. Before this error occurs, an alert A5: PUMP TIMER will remind you to replace your pump soon.

1. Press  twice to turn off and to confirm the error.

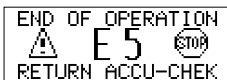

2. Contact Pump Support at 1-800-688-4578 to discuss your options for further use of the ACCU-CHEK Spirit insulin pump.

Note:

The alert A5: PUMP TIMER ALERT and the error E5: END OF OPERATION are based on running time (the total time the pump is in **RUN** mode) and not calendar years. However, the warranty is based on the date the pump was purchased.

Error E6: MECHANICAL ERROR

A mechanical error was discovered during a routine automatic system check and insulin delivery has stopped.

1. Press  twice to turn off and to confirm the error.



2. Remove or disconnect the infusion set from your infusion site.
3. Remove the cartridge, adapter, infusion set (tubing), and battery from your pump. Insert a new battery.
4. Rewind the piston rod.
5. Install a new cartridge and infusion set.
6. Prime the infusion set.
7. Reconnect the infusion set (tubing) at your infusion site.
8. Put your pump in **RUN** mode.

If the error E6: MECHANICAL ERROR occurs again in spite of these actions, contact your doctor or healthcare team for an alternate therapy plan. Contact Pump Support at 1-800-688-4578 for more assistance.

Error E7: ELECTRONIC ERROR

An electronic error was discovered during a routine automatic system check and the insulin delivery has stopped. You **cannot** turn off and confirm an error E7: ELECTRONIC ERROR by pressing . You must remove the battery instead.

1. Remove or disconnect the infusion set from your infusion site.



2. Insert a new battery into the pump.

3. Prime the infusion set.

4. Reconnect the infusion set (tubing) at your infusion site.

5. Put your pump in **RUN** mode.

If an error E7: ELECTRONIC ERROR occurs during programming (i.e., basal rate, time and date) check your settings.

If the error E7: ELECTRONIC ERROR occurs again, contact Pump Support at 1-800-688-4578 for assistance. Contact your doctor or healthcare team if you need an alternate therapy plan.

Error E8: POWER INTERRUPT

A power interrupt error occurs when you insert a new battery without first placing the pump in **STOP** mode. See the section “Inserting (or Changing) the Battery” (page 25) for instructions on how to change your battery. The error can also occur if the pump was dropped. If the pump was dropped, see the section “What to Do When You Drop Your Pump” (page 139) for more information.

1. Press  twice to turn off and to confirm the error.



2. Your pump goes in **STOP** mode.
3. Check the time and date and correct them if they are wrong. See the section “Setting Time and Date” (page 32) for more information.
4. If a bolus and/or a Temporary Basal Rate was interrupted by the error, review the bolus and/or the Temporary Basal Rate history for the delivered amount and duration. See the section “Reviewing Pump Data” (page 107) for instructions.
5. Put your pump in **RUN** mode.
6. Program a new bolus and/or Temporary Basal Rate if you need them. See “Boluses and Temporary Basal Rates” (page 75).

If an error E8: POWER INTERRUPT occurs during programming, check your settings.

Error E10: CARTRIDGE ERROR

The CHANGE THE CARTRIDGE function was not correctly carried out.

1. Press  twice to turn off and to confirm the error.



2. Remove or disconnect the infusion set from your infusion site.
3. Start the CHANGE THE CARTRIDGE menu.
4. Prime the infusion set.
5. Reconnect the infusion set (tubing) at your infusion site.
6. Put your pump into **RUN** mode.
7. If an error E10: CARTRIDGE ERROR occurs during the winding of the piston rod, insert a new battery into the pump and repeat steps 1-6.

Error E11: SET NOT PRIMED



WARNING

Never prime an infusion set that is connected to your body. You risk uncontrolled insulin delivery into your body. With detachable infusion sets, make sure you have disconnected the tubing from your site prior to priming. Always follow the instructions provided with your infusion set.

The cartridge was changed but the infusion set was not primed. The error will display when you try to put your pump in **RUN** mode.

1. Press  twice to turn off and to confirm the error.



2. Remove or disconnect the infusion set from your infusion site.
3. Prime the infusion set.
4. Reconnect the infusion set (tubing) at your infusion site.
5. Put your pump in **RUN** mode.

See the sections “Changing the Cartridge and Infusion Set” (page 73) and “Priming the Infusion Set” (page 53) for more information.

Error E12: DATA INTERRUPTED



CAUTION

If data transfer between compatible software and your insulin pump is disrupted in any way, the configuration may be incomplete and an error E12: DATA INTERRUPTED occurs. The data transfer must be completed successfully before you can put your insulin pump into RUN mode.

Data transfer between your pump and a PC was interrupted before it was completed.

1. Press  twice to turn off and to confirm the error.



2. Restart the data transfer.

Before you can put your pump in **RUN** mode, the data transfer must be successful.

See the section “Data Transfer” (page 104) for more information.

Error E13: LANGUAGE ERROR

The language setting needs to be checked.

1. Press  twice to turn off and to confirm the error.



2. Follow the steps in the section “SETUP MENU Advanced–Language” (page 134) to change the language.

3. Put your pump in **RUN** mode.

Appendixes

Appendix A: Technical Data

General Technical Data

Air humidity	<ul style="list-style-type: none">• During operation: 20 to 90% relative humidity• Stored in its shipping case: 5 to 85% relative humidity
Barometric pressure	During operation or stored in its shipping case: 700 to 1,060 mbar [do not exceed 10,000 feet (3,000 meters) above sea level].
Basal rate	Minimum 0.1 U/h; maximum 25 U/h There are 24 hourly basal rates adjustable in 0.1 unit increments.
Battery life	If used in a typical usage pattern [50 U/day using U100 insulin; operating temp. of 72°F ± 6°F (22°C ± 3°C)] the battery life is approx. four weeks for alkaline and one week for rechargeable batteries.

Bolus	The max. bolus amount per delivery is 25 units when using U100 insulin. The bolus amount for the “Quick” Standard Bolus is adjustable in increments of 0.1, 0.2, 0.5, 1.0, and 2.0 units. For the “Scroll” Standard Bolus, the Extended Bolus, and the MultiWave Bolus, the amount is adjustable in fixed increments of 0.1 units. The duration of the Extended Bolus and the MultiWave Bolus is adjustable in intervals of 15 minutes (15 minutes up to 24 hours).
Cartridge	ACCU-CHEK 3.15 ml plastic cartridge with luer-lock connection.
Data storage time	The time and date is safely stored in the memory for about 1 hour after the battery has been removed. Your insulin pump’s settings (the hourly basal rates, remaining cartridge content, bolus increments, and active user menu) and the event memory (bolus history, history of daily insulin totals, Temporary Basal Rate history, alarm history) are saved, regardless of battery voltage and time the insulin pump has been without a battery.
Data transfer	Infrared interface
Delivery	1/20th of the current hourly basal rate in 3-minute intervals.
Dimensions (maximum) without adapter	Approx. 3.2 x 2.2 x 0.8 inches (81 x 55 x 20 mm)

Flow (delivery rate)	0.2 U/sec during infusion set priming and bolus when using U100 insulin.
Infusion sets	ACCU-CHEK infusion sets with luer-lock connector.
IPX 8	Protected against the effects of temporary immersion in water under standardized conditions [up to 60 minutes and 8 feet (2.5 meters)].
Maximum time for an error E4: OCCLUSION	Plastic cartridges* <ul style="list-style-type: none"> • at med. basal rate 1.0 U/h using U100 insulin ≤ 5h • at min. basal rate 0.1 U/h using U100 insulin ≤ 50h
Maximum volume* before error	U100 insulin ≤ 3.5 U
Maximum pressure	400kPa (4.0 bar)
Maximum quantity delivered at a single fault condition	U100 insulin ≤ 1.0 U
Power supply	One 1.5 volt AA Alkaline battery or one rechargeable Nickel Metal Hydride (NiMH) AA battery. Alkaline batteries should have a minimum capacity of 2500 mAh and NiMH AA rechargeable batteries a minimum capacity of 1500 mAh. Use only a battery charger officially recommended by the battery manufacturer.
Pump casing	Shock, scratch, pharmaceutical resistant plastic. All edges are rounded.

*Determined using measurement methods according to IEC 60601-2-24-1998.

Safety system

Alert system, beeps, information on the display, vibrations, dual microprocessor. The insulin pump is controlled by two microprocessors. The safety concept is based on one processor (supervisor processor) supervising the other (main processor). Whenever a defect or fault occurs in the main processor, as identified by the supervisor processor, the motor is immediately switched off and an error E7: ELECTRONIC ERROR occurs. Conversely, the main processor can also determine at any time whether the supervisor is working correctly. The brushless motor also constitutes an important safety component. It provides the best possible reliability and accuracy in insulin delivery.

Temperature ranges

- During operation: 41°F to 104°F (5°C to 40° C)
- Stored in its shipping case: 41°F to 113°F (5°C to 45° C)

Temporary Basal Rate

Adjustable in 10% increments, 0-90% for decreases, 110-200% for increases. The duration is adjustable in 15-minute intervals, up to a maximum of 24 hours. The last programmed duration is given by default for the next temporary basal rate change programmed.

Weight

- Empty: approx. 2.8 oz. (80 g)
 - Pump w/battery, full plastic cartridge, and infusion set: approx. 4 oz. (110 g)
-

Technical Standards on Electromagnetic Emissions

The standard concerning electromagnetic compatibility of medical equipment (IEC 60601-1-2) requires the concrete specification of the corresponding levels which refer to specified electromagnetic interferences. The following is *Guidance and manufacturer's declaration on electromagnetic emissions*.

Emissions Test	Compliance	Electromagnetic Environment – Guidance
RF emissions CISPR11	Group 1	The ACCU-CHEK Spirit insulin pump uses RF energy only for its internal function. Therefore, its RF emissions are very low and are not likely to cause any interference in nearby electronic equipment.
RF emissions CISPR11	Class B	The ACCU-CHEK Spirit insulin pump is suitable for use in establishments, including domestic establishments and those directly connected to the public low-voltage power supply network that supplies buildings used for domestic purposes.
Harmonic emissions IEC 61000-3-2	Not applicable	
Voltage fluctuations/ flicker emissions IEC 61000-3-3	Not applicable	

Note 1 At 80 and 800 MHz, the higher frequency range applies.

Note 2 These guidelines may not apply in all situations. Electromagnetic propagation is affected by absorption and reflection from structures, objects and people.

a Field strengths from fixed transmitters, such as base stations for radio (cellular/cordless) telephones and land mobile radios, amateur radio, AM and FM radio broadcast and TV broadcast, cannot be predicted theoretically with accuracy. To assess the electromagnetic environment due to fixed RF transmitters, an electromagnetic site survey should be considered. If the measured field strength in the location in which the ACCU-CHEK Spirit insulin pump is used exceeds the applicable RF compliance level above, the ACCU-CHEK Spirit insulin pump should be observed to verify normal operation. If abnormal performance is observed, additional measures may be necessary, such as reorienting or relocating the ACCU-CHEK Spirit insulin pump.

b Over the frequency range 150 kHz to 80 MHz, field strengths should be less than 10 V/m.

V_i in V: <input type="text" value="10.00"/>		E_i in V/m: <input type="text" value="10.00"/>	
Rated maximum output power of transmitter W	150 kHz to 80 MHz out of ISM (Industrial, Scientific, Medical Band)	80 MHz to 800 MHz	80 MHz to 2.5 GHz
Separation distance according to frequency of transmitter m			
0.01	0.04	0.04	0.07
0.1	0.11	0.11	0.22
1	0.35	0.35	0.70
10	1.11	1.11	2.21
100	3.50	3.50	7.00

Technical Standards on Electromagnetic Immunity

Guidance and manufacturer's declaration – electromagnetic immunity

The ACCU-CHEK Spirit insulin pump is intended for use in the electromagnetic environment specified below. The customer or the user of the ACCU-CHEK Spirit insulin pump should assure that it is used in such an environment.

Immunity Test	IEC 60601 Test Level	Compliance Level	Electromagnetic Environment – Guidance
Electrostatic discharge (ESD) IEC 61000-4-2	± 6 kV contact ± 8 kV air	± 8 kV contact ± 15 kV air (IEC 60601-2-24)	Avoid any contact with synthetic materials. A relative humidity of 10% will allow ESD to be more likely.
Power frequency (50/60Hz) magnetic field IEC 61000-4-8	3 A/m 400 A/m 400 A/m	(IEC 60601-2-24)	Power frequency magnetic fields should be at levels characteristic of a typical location in a typical commercial or hospital environment.
Conducted RF IEC 61000-4-8	3 Vrms 150 kHz to 80 MHz	Not applicable	

Immunity Test	IEC 60601 Test Level	Compliance Level	Electromagnetic Environment – Guidance
Radiated RF	3 V/m	10 V/m	Portable and mobile RF communications equipment should be used no closer to any part of the ACCU-CHEK Spirit insulin pump, including cables, than the recommended separation distance calculated from the equation applicable to the frequency of the transmitter.
IEC 61000-4-3	80 MHz to 2.5 GHz	80 MHz to 2.5 GHz (IEC 60601-2-24)	

Recommended separation distance:

$$d = 0.4 \cdot \sqrt{P} \quad \begin{array}{l} 80 \text{ MHz} \\ \text{to } 800 \text{ MHz} \end{array}$$

$$d = 0.7 \cdot \sqrt{P} \quad \begin{array}{l} 800 \text{ MHz} \\ \text{to } 2.5 \text{ GHz} \end{array}$$

where P is the maximum output power rating of the transmitter in watts (W) according to the transmitter manufacturer and d is the recommended separation distance in meters (m).

Field strengths from fixed RF transmitters, as determined by an electromagnetic site survey (a), should be less than the compliance level in each frequency range (b).

Interface may occur in the vicinity of equipment marked with the following symbol: $(((\bullet)))$



Accuracy of Flow Rate for Plastic Cartridges

Trumpet curve plotted from data after the end of the stabilization period

The trumpet curve shows the accuracy of the delivery rate in relation to the observation period.

The measurements were made at a medium basal rate of **1.0 U/h** according to IEC 60601-2-24:1998 with a Disetronic Classic infusion set PC 16/110 at room temperature.

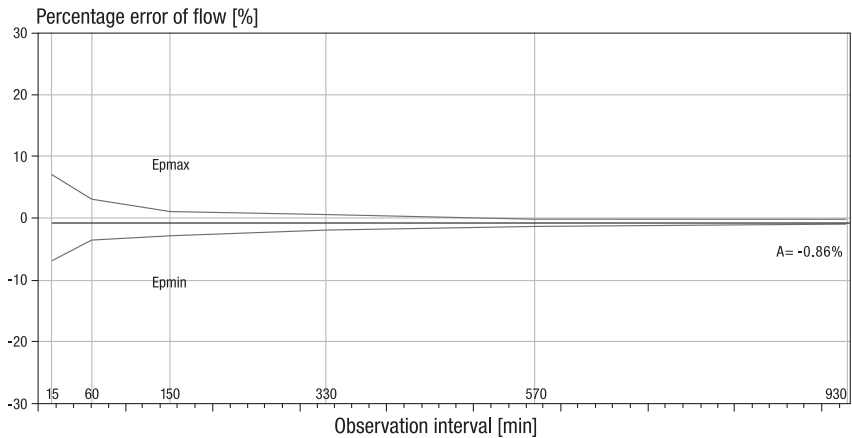

The average deviation of the delivered amount (overall mean percentage flow error) for U100 insulin is $\leq \pm 5\%$.

Start-up graph over the stabilization period

The start-up graph shows changes in the flow rate over the stabilization time.

The measurements were made at a medium basal rate of **1.0 U/h** according to IEC 60601-2-24:1998 with a Disetronic Classic infusion set PC 16/110 at room temperature.

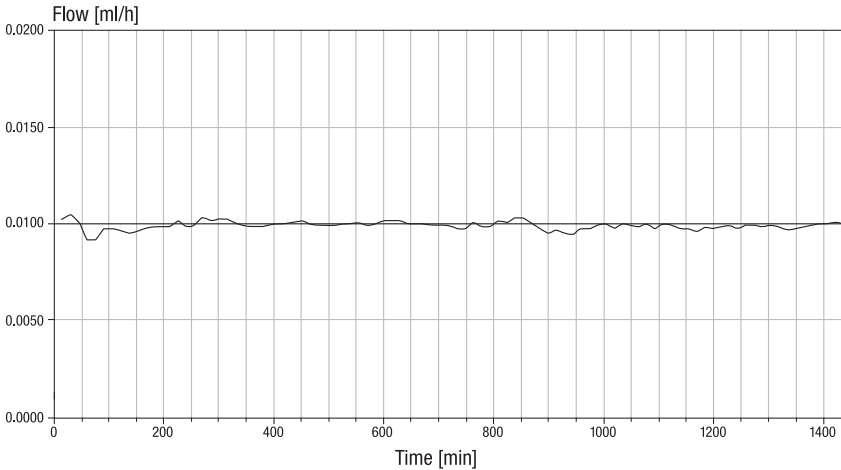

Influence of height on delivery accuracy

The average deviation of the delivered amount (overall mean percentage flow error) for U100 insulin is $\leq \pm 10\%$ when your ACCU-CHEK Spirit insulin pump is located 3.3 feet (1 m) above/below the level of infusion site.

Trumpet curve plotted from data after the end of the stabilization period

The trumpet curve shows the accuracy of the delivery rate in relation to the observation period.

The measurements were made at a medium basal rate of **0.1 U/h** according to IEC 60601-2-24:1998 with a Disetronic Classic infusion set PC 16/110 at room temperature.

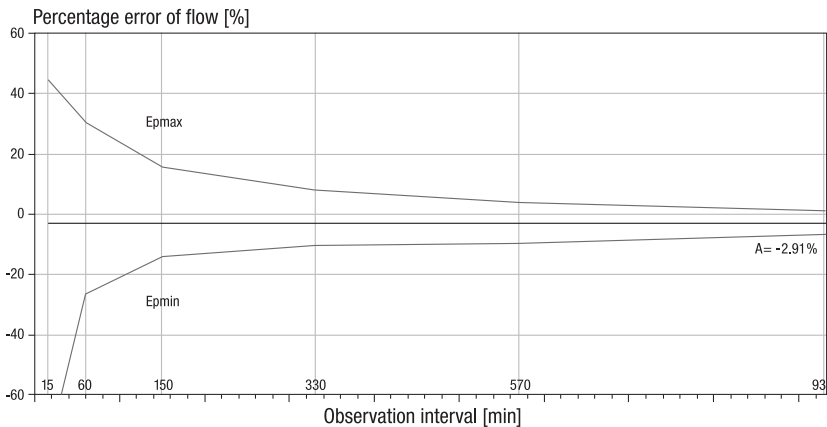

The average deviation of the delivered amount (overall mean percentage flow error) for U100 insulin is $\leq \pm 20\%$.

Start-up graph over the stabilization period

The start-up graph shows changes in the flow rate over the stabilization time.

The measurements were made at a medium basal rate of **0.1 U/h** according to IEC 60601-2-24:1998 with a Disetronic Classic infusion set PC 16/110 at room temperature.

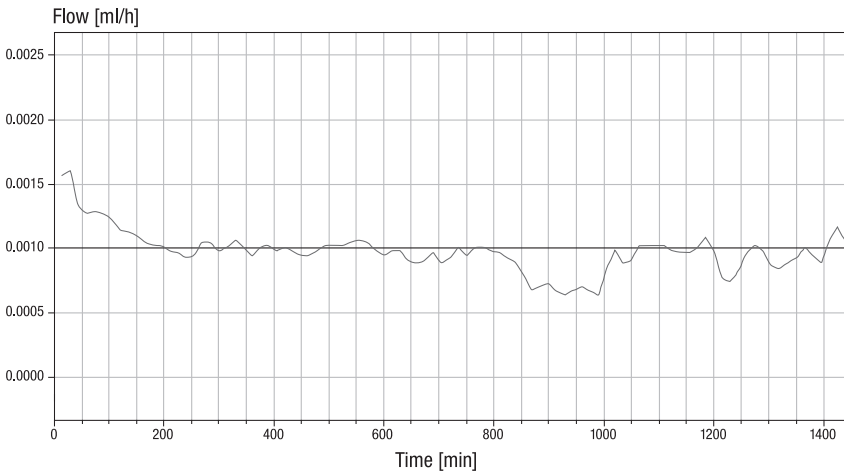

Bolus

For U100 insulin the delivery accuracy of a maximum bolus is $\leq \pm 5\%$ and the delivery accuracy of a minimum bolus is $\leq \pm 30\%$.

The measurements were made according to IEC 60601-2-24:1998 with a Disetronic Classic infusion set PC 16/110 at room temperature.

Delivery Mode	Delivery Rate/Volume	Accuracy	Range
Basal	0.1 U/h	$\pm 20\%$	0.08 - 0.12 U/h
Bolus	0.1 U	$\pm 30\%$	0.07 - 0.13 U

Appendix B: Configuration Parameters

Your pump is built by Disetronic Medical Systems with a standard configuration (factory settings). A list containing the important factory settings is added to the original insulin pump package when your pump is first shipped. You may need to adapt the factory settings to meet your individual needs. Set the configuration parameters directly on your insulin pump. Always consult your doctor or healthcare team before changing parameters.

The list on the next two pages gives you the full range for the adjustable configuration parameters on your pump. Also included are examples of typical range and parameter settings.

	Typical Range and Parameter Settings	Maximum Parameter Range	
Basal Rate			
– hourly basal rate + max. TBR (hourly basal rate combined with temporary basal rate, max. increase)	U100: 62.5 IU/h	<u>Insulin Type</u> U100	<u>Max. Amount</u> 0 – 62.50 IU/h
– hourly basal rates increment	0.1 U		
– hourly basal rates	U100: 10.0 IU/h	<u>Insulin Type</u> U100	<u>Max. Amount</u> 0 – 25.0 IU/h
– temporary basal rate	100%		0 – 200%
– TBR increase or decrease in increments of	10%		10%
– TBR duration	max. 24 h		15 min – 24 h
– TBR duration increments	15 min		15 min, 30 min, 1 h
– basal rate profiles available	5		1 – 5
– basal rate lock	off		on or off
Bolus			
– bolus amount per bolus delivery	U100: 25.0 IU/h	<u>Insulin Type</u> U100	<u>Max. Amount</u> 0 – 25.0 U
– bolus amount increments for “Quick” and “Scroll” Standard Bolus	0.5U	0.1, 0.2, 0.5, 1.0 or 2.0 U	
– bolus duration (Extended bolus, MultiWave bolus)	max. 24 h		15 min – 24 h
– bolus duration increments	15 min		15 min, 30 min, 1h





















	Typical Range and Parameter Settings	Maximum Parameter Range
Prime volume	U100: 25.0 U	<u>Insulin Type</u> U100 <u>Max. Amount</u> 0 – 25.0 IU/h
Display orientation	standard	standard or inverted
Display contrast	medium	13 steps
User menus	STANDARD	3 (STANDARD, ADVANCED or CUSTOM)
Volume (for beeps)	maximum	off, 1 – 4 steps
Alarm signals turned on	beeps and vibrations	beeps, vibrations or both
Battery type	AA battery	AA Alkaline or AA NiMH rechargeable battery
KeyLock	off	turned on or off
Automatic off	off	turned on or off 0.1 – 24h
Alarm clock	off	turned on or off when on: once or every day's occurrence
Time format		American (12 h am/pm) or European (24 h)
Date format		American (mm/dd/yy) or European (dd.mm.yy)

Appendix C: Abbreviations

approx.	Approximately
BR	Basal rate
BRP	Basal rate profile
DDM	Diabetes Data Management
h	Hour(s)
IEC	International Electrotechnical Commission
incl.	Inclusive
IR	Infrared
I.U., IU	International Units in context with biological effectiveness of a certain insulin amount
kPa	Kilo pascals
LCD	Liquid Crystal Display
LED	Light Emitting Diode for infrared communication with, for example, a personal computer (PC)
NiMH	Nickel Metal Hydride (used with rechargeable batteries)
rel.	Relative
sec.	Second(s)
TBR	Temporary Basal Rate
U	see I.U.
U/h	Amount of International Units of insulin delivered per hour
U100	Each milliliter of liquid contains 100 International Units of insulin
mm/dd/yy	American date format: month/day/year
dd.mm.yy	European date format: day.month.year

Appendix D: Beeps and Melodies



You can turn off either the pump beeps or the vibrations, but not both simultaneously. Please refer to sections “Adjust the Beep Volume”(page 116), and “Setting Up Alarm Signals” (page 117) for more information.

	Each press of 
	Each press of 
	Each press of  confirms each programmed bolus increment when programming a “Quick” Standard Bolus
	Each press of  confirms the STOP-Warning
	Temporary Basal Rate is active
	Unlock the KeyLock in RUN mode, enter the RUN or INFO screen, start a Temporary Basal Rate
	Lock the KeyLock in RUN mode
	Unlock the KeyLock in STOP mode, enter STOP screen
	Lock the KeyLock in STOP mode
	Exit a screen
	Cancel a running bolus or stop priming
	Start-up procedure successful
	Copy an hourly basal rate
	Alert and error
	Maximum amount reached
	Minimum amount reached

Appendix E: Vibrations

Your pump signals alerts and errors using beeps and vibrations. You can turn off either the beeps or the vibrations, but you cannot turn off both simultaneously. When you program a “Quick” Standard Bolus, your ACCU-CHEK Spirit insulin pump confirms all programming by vibrating. You cannot turn off these vibrations.

















Your ACCU-CHEK Spirit insulin pump vibrates when

 (Short vibration)	Your ACCU-CHEK Spirit insulin pump performs a start-up procedure
 (Medium vibration)	Your ACCU-CHEK Spirit insulin pump confirms the programmed bolus amount of the “Quick” Standard bolus
 (Long vibration)	You reset the “Quick” Standard Bolus amount to zero, you cancel the “Quick” Standard Bolus, or when the STOP-Warning occurs

See the sections “Programming a Standard Bolus” (page 77) and “Setting Up Alarm Signals” (page 117) for more information.

Appendix F: Symbols

General Symbols

		Read user guide
		Sterilized using ethylene oxide
		Sterilized using radiation
		Sterilized using antiseptics
		Year of manufacture
		Batch number
		Expiration date
		Item number
		Serial number
		Admissible temperature range during operation
		Admissible temperature range
		Admissible humidity range
		Admissible air pressure range
		Fragile – handle with care
		Protect against moisture



Protect from heat and sunlight



For single use only



Does not contain pyrogen



Does not contain PVC



Recycling



Do not throw away



Do not use if the package is damaged



Flammable



See



Electronic device of type BF according to the standard IEC 60601-1. Protection against electrical shock.

IPX8

Symbol for protection against the effect of temporary immersion in water [up to 60 minutes and 2.5 meters (8 feet)], according to IEC 60529.



Marking of conformity according to the European Medical Device Directive MDD 93/42/EEC with the number of the notified body.

Rx only

Federal law (USA) restricts this device to sale by or on the order of a physician.





















FCC ID





















Federal Communications Commission, part 15 on radio frequency devices.















Manufacturer

Symbol Definition

	Start your ACCU-CHEK Spirit insulin pump
	STOP screen and Stop insulin delivery
	Time, and Set the time and date menu
	Date
	Locked keys when the KeyLock function is turned on
	Unlocked keys when the KeyLock function is turned on
	Change the cartridge menu and cartridge content
	Cartridge low warning
	Empty cartridge
	Low battery
	Empty battery
	Alkaline AA battery
	Rechargeable AA battery
	Amount of International Units of insulin delivered per hour
	Basal rate profile
	Temporary Basal Rate
	TBR percentage
	Daily basal rate total
	Basal rate programming unlocked
	Basal rate programming locked

	Standard Bolus and Bolus increment programming
	Extended Bolus and Extended delivery of the MultiWave Bolus
	MultiWave Bolus
	Immediate bolus delivery of MultiWave Bolus
	Decreased Temporary Basal Rate (0–90%)
	Increased Temporary Basal Rate (110–200%)
	Remaining duration of an ongoing Extended Bolus, MultiWave Bolus, TBR, or automatic off
	Daily total of insulin delivered (basal rate plus boluses)
	Prime the infusion set (menu)
	Alert or error occurring
	Alert
	Error
	Information menu
	Pump timer
	Select the user menus STANDARD, ADVANCED or CUSTOM
	SETUP MENU STANDARD menu
	SETUP MENU ADVANCED menu
	Beeps turned on
	Vibrations turned on
	Beeps and vibrations turned on

	Set beep volume
	Screen orientation
EU	European date format
US	American date format
	Alarm clock turned on
	Alarm clock turned off
	Single alarm when setting an alarm clock
	Every day repeat alarm when setting an alarm clock
	PC communication
	Set beep volume
	Check key
	Up key
	Down key
	Timeout of a menu

Appendix G: Sterile Products and Accessories

Sterile Products

Cartridges

Name	Comments
Empty ACCU-CHEK 3.15ml Plastic Cartridge	Plastic cartridges are single-use items. Do not reuse cartridges. Refer to the instructions of the insulin you are using for information of proper use and acceptable temperature range for storage and handling.

ACCU-CHEK infusion sets

Name	Comments
ACCU-CHEK Ultraflex	The ACCU-CHEK Ultraflex infusion set has a specially tapered cannula and reversible connector for easy, comfortable insertion and wearing convenience.
ACCU-CHEK Tender	Variable insertion angle and choice of cannula for maximum control and comfort.
ACCU-CHEK Rapid-D	Ultra-fine stainless needle inserts easily with one hand and is a great option for new pumpers or those with vision or dexterity issues.

Accessories

Name	Comments
Adapter	Replace your adapter with every 10 th cartridge.
Battery <i>One 1.5 AA alkaline battery with a minimum capacity of 2500mAh</i>	If used in a typical usage pattern [50 U/day using U100 insulin; operating temp. of 72°F ± 6°F (22°C ± 3°C)] the battery life is approx. four weeks for alkaline.
Rechargeable Battery <i>One AA NiMH rechargeable battery with a minimum capacity of 1500 mAh</i>	If used in a typical usage pattern [50 U/day using U100 insulin; operating temp. of 72°F ± 6°F (22°C ± 3°C)] the battery life is approx. one week for rechargeable batteries.
Battery Cover	Replace your battery cover with every 4 th battery.
Carrying Systems	Disetronic Medical Systems offers a wide range of carrying system solutions to best fit your lifestyle.

Appendix H: Glossary

Adapter

The adapter connects the cartridge and infusion set. It has two seals for the cartridge compartment of your insulin pump. The two small vents on the adapter let air pressure equalize.

Basal rate

The amount of insulin needed to cover your own basic insulin needs. In insulin pump therapy, your basal rate is determined by your doctor or healthcare team and can be adjusted to meet your body's specific needs throughout the day. Your basal rate is delivered by your insulin pump according to your personal basal rate profile or profiles.

Basal rate profile

Your pump can be set to deliver up to five different basal rate profiles to match changing insulin needs (for example, during the week and on the weekend). A basal rate profile consists of 24 programmed hourly basal rates.

Basal rate total

The sum of all 24 hourly basal rates in one basal rate profile is called the (daily) basal rate total.

Bolus

The amount of insulin delivered (in addition to the basal rate) to cover the intake of food and correct high blood glucose levels. The bolus amount is determined by your doctor or healthcare team's guidelines, your blood glucose level, your food intake, and your activity level.

Carrying system

A variety of special carrying systems made of different materials are designed to suit your individual needs while wearing your pump.

Cartridge

The insulin reservoir of your pump. It holds 3.15 ml of rapid-acting insulin analog. When using U100 insulin, 3.15 ml is equal to 315 International Units of insulin.

Cartridge compartment

The opening in your pump for the cartridge.

Daily insulin total

The total amount of insulin delivered (basal rate plus boluses) in a 24-hour day, beginning at midnight. This amount does not include any insulin needed for the priming of infusion sets.

Diabetes Data Management (DDM)

Diabetes Data Management is the recording of the therapy-relevant data gained from your insulin delivery system and your blood glucose measurement system (such as an ACCU-CHEK blood glucose monitor) in order to analyze and illustrate this data on a PC or other communication device.

Factory settings

The standard configuration (“factory settings”) on a new pump. These settings can be adapted to your individual needs directly on your pump.

Filling aid

An accessory that can be used to help you fill an empty ACCU-CHEK 3.15 ml plastic cartridge from your vial of insulin.

Free flow

Free flow of insulin from the infusion set may occur when two conditions are met: first, if the cartridge with a connected infusion set and the piston rod of your pump are not correctly coupled and second, if you position your pump at a higher level than the infusion site.

Headset (also known as cannula housing)

The part of an infusion set that includes the soft cannula or needle. The infusion set tubing connects either directly to the headset, or connects to a shorter length of tubing permanently attached to the headset.

Hourly basal rate

The amount of insulin delivered by your pump in 3-minute intervals for a given hour.

Infusion set

Connects your pump to your body. The insulin is delivered from the cartridge through the infusion set tubing and cannula or needle into your subcutaneous tissue.

Infusion site

The place where the infusion set cannula or needle is inserted into your subcutaneous tissue to deliver insulin.

Insulin

A hormone that helps cells turn glucose into energy. Insulin is produced in the beta cells of the pancreas (also called islets of Langerhans).

Insulin, rapid-acting (insulin analog)

A type of insulin created using recombinant DNA technology. The onset time of insulin analog is 5 to 15 minutes.

IPX8 according to IEC 60529

Protection against the effects of temporary immersion in water. Ingress of water in quantities causing harmful effects is not possible when the device is temporarily immersed in water under standardized conditions [maximum of 60 minutes a day and 8 feet (2.5 meters) depth].

Luer-lock connector

A standardized fitting at the end of the infusion set, the cartridge, and the adapter that lets them be locked together without leaking.

Personal settings

Your pump must be programmed with your personal settings prior to starting insulin pump therapy. Personal settings include the basal rate profile(s), the correct time and date, and all other variable values that can be tailored to your individual needs on your pump.

RUN mode

During normal use, your pump is in **RUN** mode and insulin is continuously delivered. Boluses, Temporary Basal Rates, and almost all functions can be programmed from **RUN** mode.

RUN screen

The **RUN** screen is the starting point for all functions that can be accessed while your pump delivers insulin. Your pump displays the **RUN** screen during normal use when no programming is currently being performed. The time, current hourly basal rate, basal rate profile, and all functions currently activated appear on the **RUN** screen.

Settings

Settings are individually programmable values and parameters that affect the way your pump works.

Scrolling

Scrolling allows fast and easy programming of larger values.

STOP mode

When your pump is in **STOP** mode, it does not deliver any insulin. The insulin delivery is only stopped if an error occurs or if your pump is put into **STOP** mode (for example, when changing the cartridge, adapter or infusion set, or for data transfer). Functions such as Extended Bolus or Temporary Basal Rate are interrupted by putting your pump into **STOP** mode.

STOP screen

The **STOP** screen is the starting point for all functions that require that your pump does not deliver insulin.

Temporary Basal Rate

Temporary increase or decrease of your basal rate profile in percentages (from 0 – 200%) to match changing insulin needs due to increased or decreased activity level, illness, or stress.

Timeout

For your safety and convenience, your pump returns to the **RUN** or **STOP** screen if no key is pressed within a certain time. Any changes made are not saved.

U100

Each milliliter of liquid contains 100 International Units of insulin. Your pump was developed only to use U100 rapid-acting insulin analogs.

ACCU-CHEK™ Spirit

INSULIN PUMP SYSTEM

LIMITED FOUR-YEAR WARRANTY

DISETRONIC MEDICAL SYSTEMS, INC. (“DISETRONIC”) WARRANTS THE ACCU-CHEK SPIRIT INSULIN PUMP (“INSULIN PUMP”) AGAINST DEFECTS IN MATERIALS AND WORKMANSHIP FOR A PERIOD OF FOUR (4) YEARS FROM THE DATE OF PURCHASE. PROOF OF PURCHASE DATE MAY BE REQUIRED. THIS WARRANTY DOES NOT INCLUDE SUPPLIES AND ACCESSORIES, INCLUDING BUT NOT LIMITED TO, CARTRIDGES, BATTERIES, OR INFUSION SETS.

DURING THE WARRANTY PERIOD, DISETRONIC WILL REPAIR OR REPLACE, IN ITS SOLE DISCRETION, ANY INSULIN PUMP THAT DOES NOT WORK PROPERLY BECAUSE OF A DEFECT IN MATERIALS OR WORKMANSHIP. THE PURCHASER’S SOLE AND EXCLUSIVE REMEDY WITH RESPECT TO THE INSULIN PUMP SHALL BE REPAIR OR REPLACEMENT. THIS WARRANTY APPLIES ONLY TO NEW DEVICES. IN THE EVENT A PUMP IS REPAIRED OR REPLACED, THE WARRANTY PERIOD WILL NOT BE EXTENDED.

THIS WARRANTY IS VALID ONLY IF THE INSULIN PUMP IS USED IN ACCORDANCE WITH THE USER INSTRUCTIONS. THIS WARRANTY WILL NOT APPLY:

1. IF DAMAGE RESULTS FROM CHANGES OR MODIFICATIONS MADE TO THE INSULIN PUMP BY THE USER OR THIRD PERSONS AFTER THE DATE OF MANUFACTURE;
2. IF DAMAGE RESULTS FROM SERVICE OR REPAIRS PERFORMED BY ANY PERSON OR ENTITY OTHER THAN DISETRONIC.
3. IF DAMAGE RESULTS FROM A FORCE MAJEURE OR OTHER EVENT BEYOND THE CONTROL OF DISETRONIC; OR
4. IF DAMAGE RESULTS FROM NEGLIGENCE OR IMPROPER USE, INCLUDING BUT NOT LIMITED TO IMPROPER STORAGE, PHYSICAL ABUSE SUCH AS DROPPING, OR OTHERWISE.

THIS WARRANTY SHALL BE PERSONAL TO THE ORIGINAL PURCHASER. ANY SALE, RENTAL, OR OTHER TRANSFER OR USE OF THE INSULIN PUMP COVERED BY THIS WARRANTY TO OR BY A USER OTHER THAN THE ORIGINAL PURCHASER SHALL CAUSE THIS WARRANTY TO IMMEDIATELY TERMINATE.

THIS WARRANTY IS EXCLUSIVE OF ALL OTHER WARRANTIES, EXPRESS OR IMPLIED INCLUDING WITHOUT LIMITATION THE IMPLIED WARRANTY OF MERCHANTABILITY OR FITNESS FOR A PARTICULAR PURPOSE. IN NO EVENT SHALL DISETRONIC OR ITS SUPPLIERS OR DISTRIBUTORS BE LIABLE FOR ANY INCIDENTAL, CONSEQUENTIAL, INDIRECT, SPECIAL OR PUNITIVE DAMAGES ARISING FROM OR IN ANY WAY CONNECTED WITH THE PURCHASE OR USE OF THE INSULIN PUMP.

Index

- Accessories; 17-23, 189
- Adapter; 9, 20, 47-48, 190
- Advanced User Menu; 99, 122-128
- Air Bubbles; 45, 53, 145
- Alarm Clock; 127-128, 151
- Alarm History; 109
- Alarm Signals; 16, 117
- Alcohol Consumption; 144
- Alerts and Errors; 147-164, 199-200
- Automatic Off; 118, 156

- Backlight; 10
- Basal Rate Profile; 36, 123, 126, 190
 - Lock; 133
 - Programming; 37-41, 124
 - Selecting; 125
 - Temporary; 93-96
- Battery; 21, 141
 - Cover; 22
 - Depleted; 155
 - Inserting or changing; 25-27
 - Key; 23, 71
 - Life; 165, 189
 - Low; 150, 185
 - Type; 119, 167
- Beeps; 15, 116, 181, 186-187
- Bolus; 75
 - Extended; 83-87
 - History; 107-108
 - MultiWave; 88-92
 - “Quick” Standard; 77-80
 - “Scroll” Standard; 80-82
- Cartridge; 9, 18
 - Changing; 73-74
 - Connecting; 47-48
 - Filling; 43-46
 - Inserting; 49-52
 - Low; 149, 185
- CHECK Key; 9, 187
- Cleaning; 141
- Copying Hourly Basal Rate; 40-41

- Data Interrupted; 163
- Data Transfer; 104
- Date; 32-34, 150
- Date Format; 130
- Daily Insulin Totals; 110, 191
- Display; 9-10
 - Contrast; 135
 - Orientation; 120, 187
- Disposal; 140
- DOWN Key; 9, 187

- Electromagnetic; 61, 169-172
- Electronic Error; 160
- Emergency Kit; 23
- Errors; 147-148, 154-164
- Exit Options; 102

- Filling Aid; 43

- Guarantee; 4

- History; 107
 - Alarm; 109
 - Bolus; 107-108
 - Daily Insulin; 110
 - Temporary Basal Rate; 111

Immunity; 171-172
 Infusion Set; 9, 19-20
 Changing the; 70-72
 Not Primed; 162-163
 Priming; 53-55
 Infusion Site; 56-57, 72
 Insulin Delivery;
 Starting; 65
 Stopping; 66
 Insulin Pump Therapy;
 Interruption of; 68-69
 Resuming; 69

 KeyLock; 13
 Turning On; 113-114
 Turning Off; 113-114
 Unlocking; 181, 185
 Keys; 11
 Key Combinations; 12

 Language; 134
 Language Error; 164
 Liquids; 64
 Luer-Lock; 192

 Maintenance; 141
 Mechanical Error; 159-160
 Menus; 99-102
 Advanced; 122
 Custom; 136
 Standard; 103
 MultiWave Bolus;
 Programming; 88-91
 Cancelling; 91-92

 Occlusion; 146
 Error; 156-158, 167
 Orientation; 120

 Power Interrupt; 161
 Prime Quantity; 132
 Priming; 53-55
 Products, Sterile; 17-18, 188
 Profile, See Basal Rate Profile
 Programming;
 Additional Basal Rate
 Profile; 124
 Basal Rate Profile; 37
 Extended Bolus; 83-87
 MultiWave Bolus; 88-92
 “Quick” Standard Bolus;
 77-80
 “Scroll” Standard Bolus;
 80-82
 Temporary Basal Rate; 93-96
 Pump; 9
 Stopping; 66
 Storing; 140
 Wearing; 59-60

 Quick Info Screen; 14
 Quick Information; 30

 Repair; 142
 RUN Screen; 13, 192

 Safety System; 147, 168
 Screen; 9-10
 Scrolling; 193
 Setup Menu;
 Advanced; 129, 186
 Standard; 113, 186
 Standard User Menu; 99, 103
 Start-Up; 28-31
 Status Screen; 15
 Sterile; 17, 188
 Stop-Warning; 16, 67

Quick Reference Table for Errors

No. Error		What You Need to Do
E1	CARTRIDGE EMPTY	Change the cartridge.
E2	BATTERY DEPLETED	Change the battery.
E3	AUTOMATIC OFF	If necessary, put your ACCU-CHEK Spirit in RUN mode.
E4	OCCLUSION	Immediately check your blood glucose level, because insulin delivery has been interrupted. If your blood glucose level is high, take appropriate actions according to your doctor's or healthcare team's instructions. See the section "Error E4: OCCLUSION."
E5	END OF OPERATION	Arrange for immediate replacement of your insulin pump. Contact Pump Support at 1-800-688-4578 to discuss your options for further use of the ACCU-CHEK Spirit insulin pump. Contact your healthcare professional for alternative insulin therapy options.
E6	MECHANICAL ERROR	See the section "Error E6: MECHANICAL ERROR."
E7	ELECTRONIC ERROR	See the section "Error E7: ELECTRONIC ERROR."
E8	POWER INTERRUPT	See the section "Error E8: POWER INTERRUPT."
E10	CARTRIDGE ERROR	See the section "Error E10: CARTRIDGE ERROR."
E11	SET NOT PRIMED	Prime your infusion set.
E12	DATA INTERRUPTED	Restart the data transfer.
E13	LANGUAGE ERROR	See the section "Error E13: LANGUAGE ERROR."

Stopping;
 Insulin Delivery; 66
 Priming; 55
 System Check; 28-31

Temporary Basal Rate;
 Cancelling; 97
 History; 111
 Over; 96, 153
 Programming; 93-96
 Time and Date; 32
 American; 32, 130
 European; 32, 130
 Time and Date, Review; 150

Time Remaining; 112
 Troubleshooting; 143-146
 Tubing; 20, 132

UP Key; 9, 187
 User Menu; 99-102
 Advanced; 122
 Custom; 136
 Standard; 103

Water; 63
 Contact with; 63
 After Contact with; 64

Diagram of User Menus

Your Insulin pump STANDARD MENU

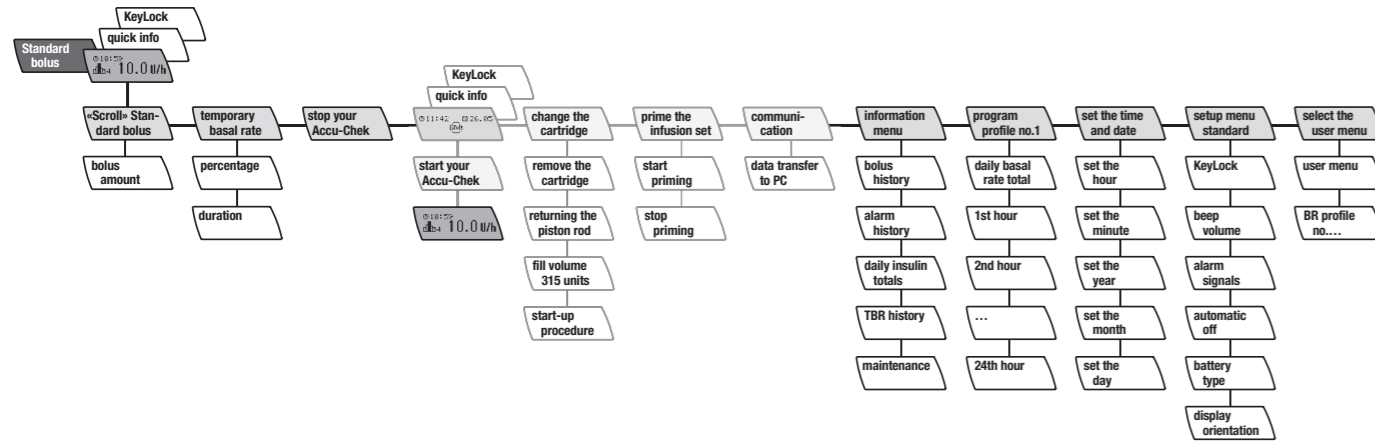

Standard bolus

(A) «Quick» Standard bolus with direct access from the RUN screen using the **a** and **keys** of your insulin pump.

(B) «Scroll» Standard bolus menu-guided using the STANDARD BOLUS menu and the scroll function of the **a** and **keys** for programming the bolus amount.

For a complete review of your insulin pump features as well as the warnings and precautions associated with its use, please refer to your ACCU-CHEK Spirit Insulin Pump User Guide.

Your Insulin pump ADVANCED MENU

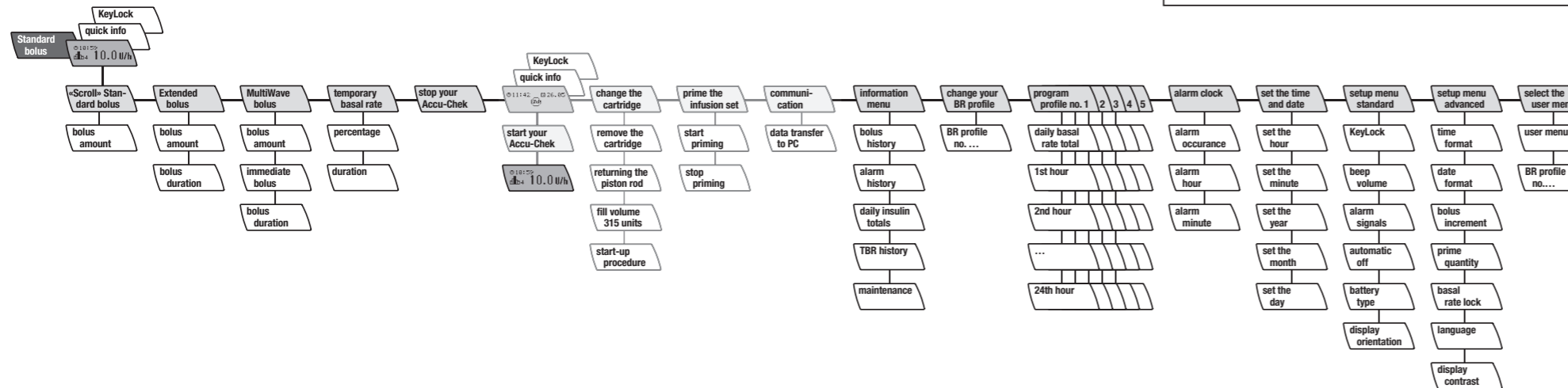

Quick Reference Table for Alerts

In all cases, turn off and confirm the alert prior to addressing the issue.

No. Alert		What You Need to Do
A1	CARTRIDGE LOW	Change cartridge before it is completely empty.
A2	BATTERY LOW	Replace the battery as soon as possible.
A3	REVIEW TIME AND DATE	Set the time and date.
A4	ALARM CLOCK	Put your ACCU-CHEK Spirit in RUN mode, if necessary.
A5	PUMP TIMER	Your pump's operating time will expire soon. Go to the INFORMATION screen on your pump, then move to the PUMP TIMER screen. The days until the pump timer expires is shown. Make arrangements for replacement of the pump before the timer reaches zero days.
A6	TBR CANCELLED	Put your ACCU-CHEK Spirit insulin pump in RUN mode, if necessary. Ensure the cancellation was intended and program a new Temporary Basal Rate, if necessary.
A7	TBR OVER	Decide whether a further Temporary Basal Rate change is appropriate and program one, if necessary.
A8	BOLUS CANCELLED	Put your ACCU-CHEK Spirit insulin pump in RUN mode, if necessary. Ensure that the cancellation was intended and program a new bolus, if necessary.

Rx only



Manufactured by:

Disetronic Medical Systems AG

CH-3401 Burgdorf, Switzerland

Distributed by:

Disetronic Medical Systems, Inc.

11800 Exit 5 Parkway, Suite 120

Fishers, IN 46037

Phone 866-703-3476

Fax 888-810-0758

For technical assistance, call Pump Support at
800-688-4578.

www.accu-chek.com



ACCU-CHEK™ Spirit
INSULIN PUMP SYSTEM

ACCU-CHEK and ACCU-CHEK SPIRIT are trademarks of Roche.

©2005 Disetronic Medical Systems, Inc. All rights reserved. 04632753001/V01/11.05
Swiss made

Free Manuals Download Website

<http://myh66.com>

<http://usermanuals.us>

<http://www.somanuals.com>

<http://www.4manuals.cc>

<http://www.manual-lib.com>

<http://www.404manual.com>

<http://www.luxmanual.com>

<http://aubethermostatmanual.com>

Golf course search by state

<http://golfingnear.com>

Email search by domain

<http://emailbydomain.com>

Auto manuals search

<http://auto.somanuals.com>

TV manuals search

<http://tv.somanuals.com>