



ACCUSPLIT, Inc.  
 3090 Independence Drive, Suite 148  
 Livermore, CA 94551 USA  
 800-935-1996 • 925-290-1900 • FAX 925-290-1930  
[www.ACCUSPLIT.com](http://www.ACCUSPLIT.com) • [support@ACCUSPLIT.com](mailto:support@ACCUSPLIT.com)

*Eat Right! Walk More! Live Well!*  
*The ACCUSPLIT Lifestyle*

970-089  
 Nov 07

# ACCUSPLIT EAGLE

## AE180XL PEDOMETER



### Operating Instructions

#### Functions

- Step counter.
- Automatic Activity Timer.
- Distance in mi or km.
- Clock.

For complete Function Specifications, go to page 26.

2

#### Key Features

- Built around the Japanese-made JW200 PedometerEngine™ Step Sensor, the current gold standard for accuracy.
- Extra Large Digits.
- The ACCUSPLIT exclusive case makes this the slimmest available pedometer built around the JW200 Step Sensor.
- Chromed, Spring Steel clip resists breakage.
- Case includes two leash slots, for attaching safety leash on either side. Made from tough polycarbonate plastic.
- Step filter, can be set from 0-5 steps to further increase accuracy.

3

#### HOW TO OPEN YOUR PEDOMETER

See diagrams at right.

**The cover must be closed for the pedometer to work.**

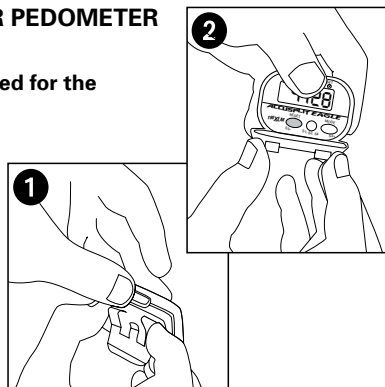

4

#### USE IT NOW!

Your pedometer is preset with standardized settings that allow you to use it now! You can customize the settings later. Skip to pages 15-18 to use it now!

#### SETTING UP YOUR PEDOMETER

It's a good idea to set up your pedometer before first using it. To record your distance accurately, you will need to set your stride length. You may also wish to set the clock to the correct time of day.

See page 9 when you are ready to set up your unit.

5

#### Getting Acquainted

- Press the MODE button to cycle through the display modes (Steps, Activity Time, ...). See page 18 and Specifications for details.
- The RESET button sets your counts back to zero. See page 19 for details.

#### MODES

- STEP: STEP mode shows step count.
- TIME: AUTO ACTIVITY TIMER MODE shows total activity time in min and sec.

6

- DIST: DISTANCE mode shows distance traveled (mi/km).
- ⌚: CLOCK mode shows time of day.

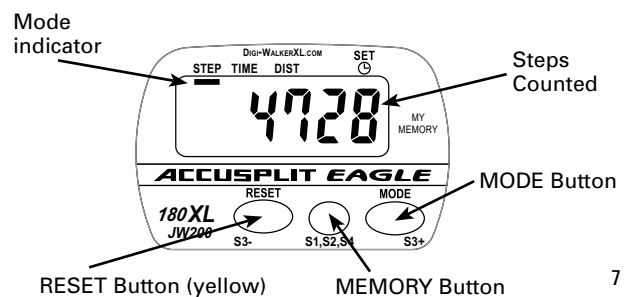

7

### SETTING PROCEDURE

ACCUSPLIT products use a common setting procedure known as "S1- S2-S3-S4." Here's how it works:

Press S1 for 2 seconds: Enter the SET mode

Press S2: Change the field to be set

Press S3: Change the field value

Press S4 for 2 seconds: Exit the SET mode

You can enter and exit Set mode from any of the regular display screens. Once in Set mode, you can cycle through all of these settings by pressing S2 repeatedly:

Set Stride Length → Set Clock Hours → Set Clock Minutes

8

We recommend that you adjust the settings all at once, using the procedure below.

### Entering set mode

Press and hold the S1 button for 2 seconds.

The display will start to flash, showing that you've entered SET mode.

9

"in" indicator for inches

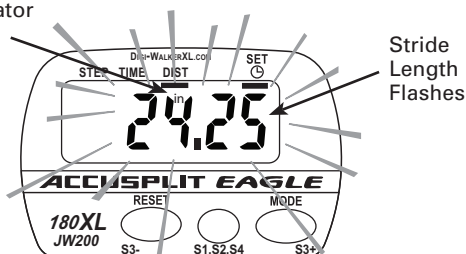

### Setting Stride Length

10

### Setting Stride Length

1. Press S2, repeatedly until the mode indicator bar is underneath DIST and the "in" indicator comes on. The display will show a flashing number, which is your Stride Length set point (in inches).
2. Press the S3 + (MODE) button to increase the Stride Length (in increments of ¼ inch), and press the S3- (RESET) button to decrease the Stride Length. Hold the buttons down to change values quickly.
3. Press the S2 button to adjust the clock.

11

**Finding Your Stride Length:** Your stride length is the length of one of your steps, measured from "toe to toe." To measure, walk 10 steps with your normal stride and measure the TOTAL DISTANCE from the toe of your starting step to the toe of your 10th step (see diagram below). Divide the TOTAL DISTANCE by 10, and multiply the decimal portion by 12 to find your stride length in feet and inches. Example: You walk 23 feet and 6½ inches in 10 steps. Convert to feet only = 23.542 feet ( $6\frac{1}{2} \div 12 = 0.542$ ). Divide by ten to get the stride length in feet = 2.354 feet. Now, convert back to feet and inches to get your stride length = 2 feet 4.25 inches ( $0.354 \times 12 = 4.25$ ).

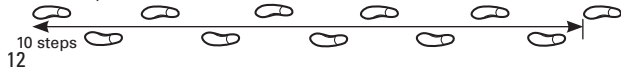

12

### Setting the Clock

1. (Continuing from above) - After pressing S2, you will see the "lb" indicator go out, and the "A" or "P" indicator come on. The display will show the current time of day setting, with the Hours value flashing.
2. As before, press the S3 + (MODE) button to increase Hours, and press the S3 - (RESET) button to decrease Hours. Hold the buttons down to change values quickly. Note: the "A" and "P" indicators indicate AM and PM.
3. Press the S2 button to adjust the Minutes.
4. Press the S3 + (MODE) button to increase Minutes, and press the S3 - (RESET) button to decrease Minutes. Hold the buttons down to change values quickly. Note: the "A" and "P" indicators indicate AM and PM.

13

*Note:* If you need to go back and change some of the values, simply press S2 to cycle through all of the set points until you see the one you want to change.

### Exiting Set Mode

Press and hold the S4 button for 2 seconds. The unit will exit setting mode – no values will be flashing anymore.

*Note:* The unit will save any changes and exit set mode after 30 seconds unattended.

14

### WEARING YOUR Pedometer

Gently slide the pedometer onto your belt or the top edge of your pants or skirt. It should fit snugly and level, above one knee. The strong steel clip makes it easy.

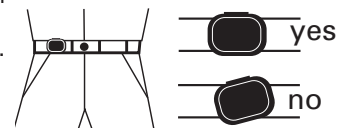

*Note:* The pedometer should be as vertical as possible. Walkers with larger stomachs may find it helpful to wear the pedometer farther back on the body, toward one hip.

**The cover must be closed for the pedometer to work.**

15

To avoid losing or dropping your pedometer, use the included leash and clip to fasten the pedometer securely to your clothing.

### Attaching the Leash

1. Attach the pedometer to the leash by looping the thin side of the leash through one of the leash slots on the sides of the pedometer case, near the bottom of the unit.
2. Put the pedometer onto your clothing as discussed above.
3. Attach the alligator clip to a belt loop or the top edge of the pants or skirt.

*Note:* You can also use a safety pin to fasten the leash to your clothing, loop the leash through your belt or belt loop, or use a badge holder.

16

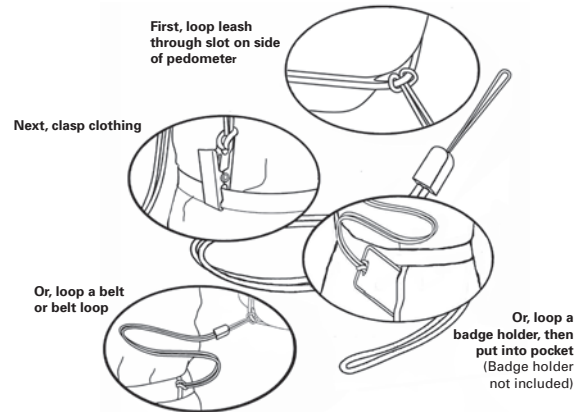

17

### VIEWING YOUR RESULTS

Once you put on your pedometer with the cover closed, it will automatically begin to record your steps, activity time, distance, and calories burned. Repeatedly press the MODE button to cycle through the pedometer modes:

STEPS → TIME → DISTANCE → CLOCK → STEPS

Time and Distance are counted automatically whenever steps are being counted.

- TIME is time spent in step activity.
- DISTANCE is simply stride length x steps.

*Note:* For extra accuracy, the default Step Filter Setting is 1. See page 21 to learn more.

18

### RESETTING YOUR PEDOMETER

Most people prefer to reset counts daily. To reset your counts: From STEP, TIME, or DISTANCE mode, press and hold the yellow RESET button for at least 2 seconds. You'll see the values all go back to zero.

19

### OTHER SETTINGS

The Step Filter and Unit of Measurement settings are accessed through a special "deep set" mode.

To enter this mode, press and hold the S1 button for 4 seconds. The screen will display a single digit. From within Deep Set mode, press the S2 button to cycle back and forth between the Step Filter set point and Choice of Unit System.

### CHANGING STEP FILTER SETTING

While the JW200 PedometerEngine™ Step Sensor is extremely accurate, some people like to have the ability to filter out false steps. Therefore, the unit has a variable setting step filter, to allow fine-tuning to your specific preferences. You can set the value to any value from 0 – 5 steps. For example, if the filter is set to "3", the unit will wait to start counting steps until more than three steps have been taken in less than five seconds.

Press S3+ (MODE) or S3- (RESET) to change the Step Filter Setting.

21

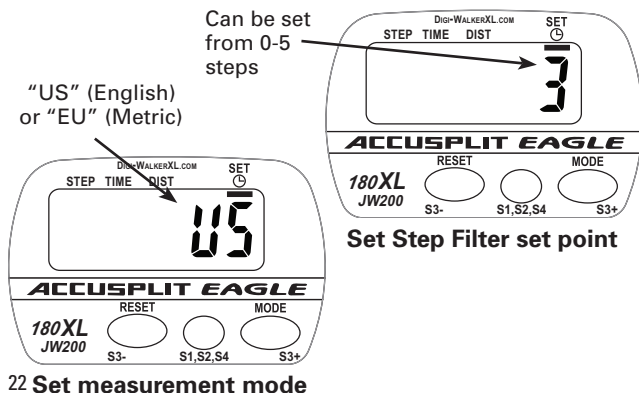

### CHANGING UNITS (English vs. Metric)

The Pedometer can display either in English units (in, mi, and lb - this is the default), or in Metric units (cm, km, and kg). From within Deep Set mode (see pg. 25), press the S2 button to cycle back and forth between setting the Step Filter set point and Choice of Unit System. The unit will show either "US" or "EU" (for European Union) depending on the unit system chosen. If you change units after using the pedometer, the unit will convert all of your data into the new unit system when you exit Deep Set mode. You can check to see which system of units you are using by seeing which measurement units are displayed on the Stride and Weight setting screens.

Press S3+ (MODE) or S3- (RESET) to change the Measurement Mode. Press and hold S4 for 2 seconds to exit Deep Set Mode.

*Note:* The unit will save any changes and exit set mode after 30 seconds unattended.

23

**REPLACING THE BATTERY AND MASTER RESET**

When the display starts to dim or goes blank, it is time to replace the battery.

If the display is not uniformly dim or blank, and appears to display "erroneous data", do a Master Reset by pressing all 3 buttons simultaneously for 3 seconds and then release. The display should go blank, then turn all segments on, then display 0 steps in Step Mode.

Note: All the settings will return to their default setting values. If you need to change the battery, the settings will also revert to default settings.

To replace the battery:

1. Insert a coin into the slot on the bottom of the case, and twist to loosen the faceplate. Remove faceplate and set aside.
2. Locate the battery holder as seen on sketch. Pull out the old battery, and push a new LR-44 battery into the holder, with positive terminal (+) facing up.
3. Snap faceplate back into place, hooking the bottom two tabs first, then closing by pressing together at the top two tabs.

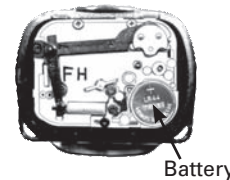

**SPECIFICATIONS, FEATURES, and FUNCTIONS**

**Description of Functions**

- Counts Steps up to 99,999 then rollover.
- Counts Time spent in step activity, up to 999 Min 59 sec, then rollover. Automatically counts whenever step activity is occurring.
- Counts distance traveled during step activity, up to 999.99 mi or km, then rollover. Automatically counts whenever step activity is occurring.
- Adjustable stride length for greater distance accuracy (default setting is 21 in/53 cm, but can be set from 12-72 in (30-180 cm), in 0.25 in / 1 cm increments.

- 12 Hour Clock (default setting is 10.00am).
- Adjustable Step Filter (default setting is 1 step, but can be set from 0-5 steps) to increase step count accuracy.
- Switchable between English and Metric units, without losing data (default setting is English units).

**REGISTER NOW** Please return your AE180XL Registration to the Repair Center address in the warranty, and we will let you know about future products.

Email (preferred) User \_\_\_\_\_

**NO-PROOF-OF-PURCHASE LIMITED WARRANTY**  
 Free service for first year of ownership;  
 \$12 fee for service thereafter. See label inside unit for date.  
 See [www.ACCUSPLIT.com/support](http://www.ACCUSPLIT.com/support) for details

**INDEX**

Battery, replacing . . . . .	25-26	Step Filter Setting, change . . . . .	21-22
Clock, setting . . . . .	13-14	Stride Length, setting . . . . .	10-12
Current day's results, viewing . . . . .	20	Unit of measure, changing . . . . .	23
Setting Mode, exiting . . . . .	14	Wearing pedometer . . . . .	15
Open your pedometer . . . . .	4	Warranty . . . . .	29
Safety Leash . . . . .	18-19		
Setting up pedometer . . . . .	5-12		

## Free Manuals Download Website

<http://myh66.com>

<http://usermanuals.us>

<http://www.somanuals.com>

<http://www.4manuals.cc>

<http://www.manual-lib.com>

<http://www.404manual.com>

<http://www.luxmanual.com>

<http://aubethermostatmanual.com>

Golf course search by state

<http://golfingnear.com>

Email search by domain

<http://emailbydomain.com>

Auto manuals search

<http://auto.somanuals.com>

TV manuals search

<http://tv.somanuals.com>