

TravelMate 5330 Extensa 5230/5630Z Series Service Guide

Service guide files and updates are available on the ACER/CSD web; for more information, please refer to <http://csd.acer.com.tw>

PRINTED IN TAIWAN

Revision History

Please refer to the table below for the updates made on TravelMate 5330/Extensa 5230/5630Z Series service guide.

Date	Chapter	Updates

Copyright

Copyright © 2008 by Acer Incorporated. All rights reserved. No part of this publication may be reproduced, transmitted, transcribed, stored in a retrieval system, or translated into any language or computer language, in any form or by any means, electronic, mechanical, magnetic, optical, chemical, manual or otherwise, without the prior written permission of Acer Incorporated.

Disclaimer

The information in this guide is subject to change without notice.

Acer Incorporated makes no representations or warranties, either expressed or implied, with respect to the contents hereof and specifically disclaims any warranties of merchantability or fitness for any particular purpose. Any Acer Incorporated software described in this manual is sold or licensed "as is". Should the programs prove defective following their purchase, the buyer (and not Acer Incorporated, its distributor, or its dealer) assumes the entire cost of all necessary servicing, repair, and any incidental or consequential damages resulting from any defect in the software.

Acer is a registered trademark of Acer Corporation.

Intel is a registered trademark of Intel Corporation.

Pentium and Pentium II/III are trademarks of Intel Corporation.

Other brand and product names are trademarks and/or registered trademarks of their respective holders.

Conventions

The following conventions are used in this manual:

SCREEN MESSAGES	Denotes actual messages that appear on screen.
NOTE	Gives bits and pieces of additional information related to the current topic.
WARNING	Alerts you to any damage that might result from doing or not doing specific actions.
CAUTION	Gives precautionary measures to avoid possible hardware or software problems.
IMPORTANT	Reminds you to do specific actions relevant to the accomplishment of procedures.

Preface

Before using this information and the product it supports, please read the following general information.

1. This Service Guide provides you with all technical information relating to the BASIC CONFIGURATION decided for Acer's "global" product offering. To better fit local market requirements and enhance product competitiveness, your regional office MAY have decided to extend the functionality of a machine (e.g. add-on card, modem, or extra memory capability). These LOCALIZED FEATURES will NOT be covered in this generic service guide. In such cases, please contact your regional offices or the responsible personnel/channel to provide you with further technical details.
2. Please note WHEN ORDERING FRU PARTS, that you should check the most up-to-date information available on your regional web or channel. If, for whatever reason, a part number change is made, it will not be noted in the printed Service Guide. For ACER-AUTHORIZED SERVICE PROVIDERS, your Acer office may have a DIFFERENT part number code to those given in the FRU list of this printed Service Guide. You MUST use the list provided by your regional Acer office to order FRU parts for repair and service of customer machines.

Table of Contents

Chapter 1	System Specifications	1
Features	1	
System Block Diagram	3	
Your Acer Notebook tour	4	
Right View	7	
Indicators	10	
Easy-Launch Buttons	10	
Touchpad Basics (with fingerprint reader)	11	
Touchpad basics (with two-click buttons)	11	
Using the Keyboard	13	
Lock Keys and embedded numeric keypad	13	
Windows Keys	14	
Hot Keys	15	
Special Key (only for certain models)	16	
Acer Empowering Technology	17	
Launching Acer Empowering Technology	17	
Empowering Technology password	18	
Acer ePower Management	19	
Acer eDataSecurity Management (only for certain models)	20	
Acer eRecovery Management	21	
Acer eSettings Management	23	
Windows Mobility Center	24	
Using the System Utilities	25	
Acer GridVista (dual-display compatible)	26	
Hardware Specifications and Configurations	28	
Chapter 2	System Utilities	35
BIOS Setup Utility	35	
Navigating the BIOS Utility	36	
Information	37	
Main	38	
Security	40	
Boot	44	
Exit	45	
BIOS Flash Utility	46	
Remove HDD/BIOS Utility	47	
Chapter 3	Machine Disassembly and Replacement	51
Disassembly Requirements	51	
General Information	52	
Pre-disassembly Instructions	52	
Disassembly Process	52	
External Module Disassembly Process	53	
External Modules Disassembly Flowchart	53	
Removing the Battery Pack	54	
Removing the SD dummy card	55	
Removing the PC and ExpressCard dummy cards	56	
Removing the Lower Cover	57	
Removing the DIMM	58	
Removing the WLAN Board Modules	59	
Removing the Hard Disk Drive Module	61	
Removing the Optical Drive Module	62	

Table of Contents

Main Unit Disassembly Process	65
Main Unit Disassembly Flowchart	65
Removing the Middle Cover	66
Removing the Power Board	67
Removing the Keyboard	69
Removing the Heatsink Fan Module	70
Removing the CPU and VGA Heatsink Module	71
Removing the CPU	72
Removing the VGA Board (Discrete Model only)	73
Removing the LCD Module	74
Separating the Upper Case from the Lower Case	76
Removing the Speaker Module	80
Removing the Launch Board	81
Removing the Fingerprint and Touchpad Module	82
Removing the Modem Board	85
Removing the USB Board Module	87
Removing the Main Board	88
LCD Module Disassembly Process	91
LCD Module Disassembly Flowchart	91
Removing the LCD Bezel	92
Removing the LCD module with the Brackets	94
Removing the FPC Cable	95
Removing the LCD Brackets	97
Removing the Antennas	98
Removing the Web Camera	99
Chapter 4 Troubleshooting	101
System Check Procedures	102
External Diskette Drive Check	102
External CD-ROM Drive Check	102
Keyboard or Auxiliary Input Device Check	102
Memory check	103
Power System Check	103
Touchpad Check	105
Power-On Self-Test (POST) Error Message	106
Index of Error Messages	107
Phoenix BIOS Beep Codes	110
Index of Symptom-to-FRU Error Message	115
Intermittent Problems	119
Undetermined Problems	120
Chapter 5 Jumper and Connector Locations	121
Top and Bottom View	121
BIOS Recovery by Crisis Disk	124
Chapter 6 FRU (Field Replaceable Unit) List	125
TravelMate 5330 Series Exploded Diagram	126
Extensa 5230/5630Z and TravelMate 5330 Series	134
Appendix A Model Definition and Configuration	134
Extensa 5230/5630Z and TravelMate 5330 Series	134

Table of Contents

Appendix B Test Compatible Components	135
Microsoft® Windows® Vista Environment Test	136
Appendix C Online Support Information	139
Index	141

System Specifications

Features

Below is a brief summary of the computer's many feature:

Platform

- Intel® Celeron® processor
- Mobile Intel® GL40 Express Chipset
- Acer InviLink™ 802.11b/g

System Memory

- Dual-Channel DDR2 SDRAM support
- Up to 2 GB of DDR2 667 MHz memory, upgradeable to 4 GB using two soDIMM modules*

Display and graphics

- 15.4" WXGA 1280 x 800
- Mobile Intel® GL40 Express Chipset

Storage subsystem

- 2.5" hard disk drives
- Optical drive options:
 - DVD-Super Multi double-layer drive
 - DVD/CD-RW combo drive
- 5-in-1 card reader

Special keys and controls

- 88-/89-key keyboard
- Touchpad pointing device
- Empowering Key
- Easy-launch buttons: WLAN, Internet, email, Bluetooth, Acer Arcade™
- Acer MediaTouch keys: play/pause, stop, previous, next
- Volume wheel
- Acer Media Center remote control*

Audio

- Two built-in Acer 3DSonic stereo speakers
- High-definition audio support
- MS-Sound compatible
- Built-in microphones

Communication

- Acer Video Conference, featuring:

-
- Integrated Acer Crystal Eye webcam
 - Optional Acer Xpress VoIP phone
 - WLAN:
 - Acer InviLink™ 802.11b/g
 - WPAN: Bluetooth® 2.0+EDR (Enhanced Data Rate)
 - LAN: Gigabit Ethernet; Wake-on-LAN ready
 - Modem: 56K ITU V.92

I/O Ports

- ExpressCard™/54 slot
- PC Card slot (Type II)
- 5-in-1 card reader (SD/MMC/MS/MS PRO/xD)
- Three USB 2.0 ports
- External display (VGA) port
- Headphones/speaker/line-out jack
- Microphone-in jack
- Line-in jack
- Ethernet (RJ-45) port
- Modem (RJ-11) port
- DC-in jack for AC adapter

Environment

- Temperature:
 - Operating: 5 °C to 35 °C
 - Non-operating: -20 °C to 65 °C
- Humidity (non-condensing):
 - Operating: 20% to 80%
 - Non-operating: 20% to 80%

NOTE: "*" "Only for certain models"

NOTE: The specifications listed above are for reference only. The exact configuration of your PC depends on the model purchased.

System Block Diagram

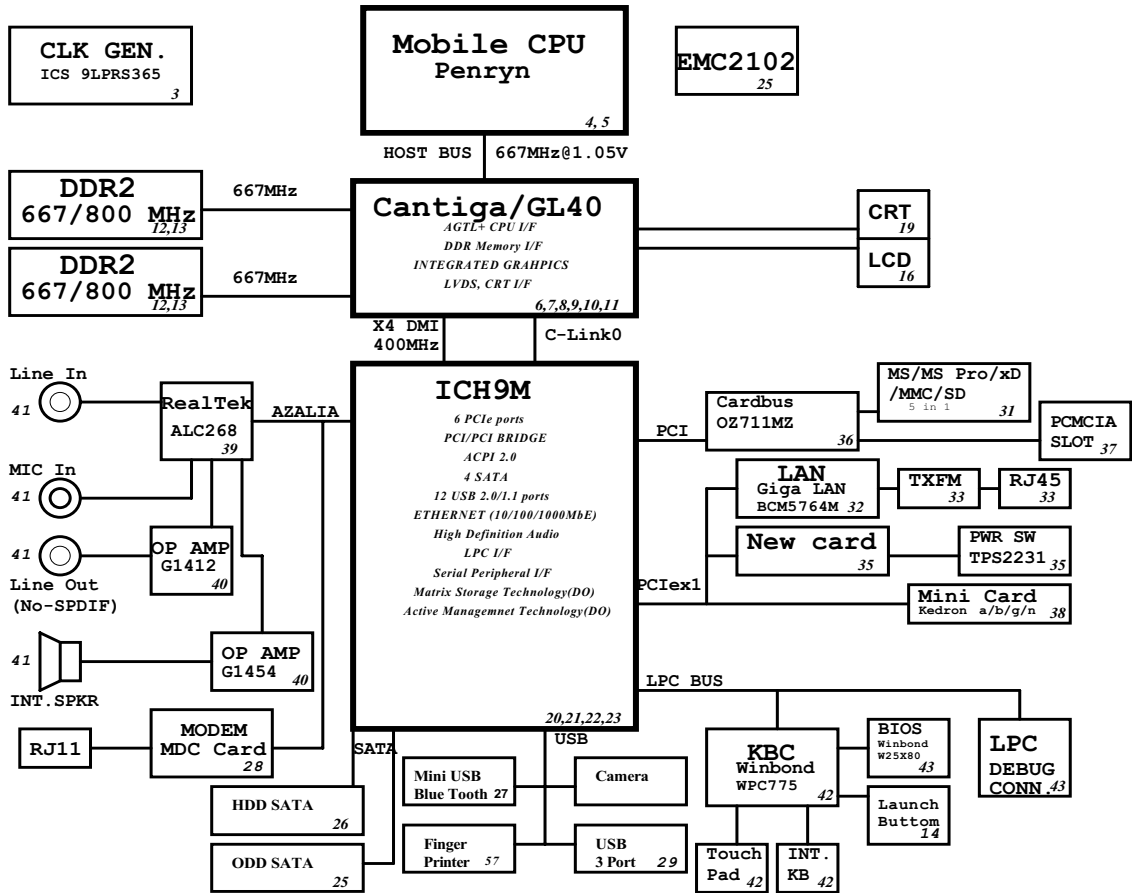

Your Acer Notebook tour

After knowing your computer features, let us show you around your new computer.

Front View







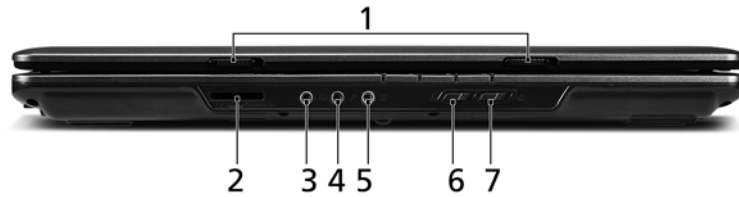

	Icon	Item	Description
1		Acer Crystal Eye	Web camera for video communication (only for certain models).
2		Microphone	Internal microphone for sound recording.
3		Display screen	Also called Liquid-Crystal Display (LCD), displays computer output.
4		Speakers	Left and right speakers deliver stereo audio output.
5		Empowering key	Launch Acer Empowering Technology
6		Productivity keys	Three productivity keys give users one-touch access to protection and manageability features for a more secure, smarter and easier way to work.

	Icon	Item	Description
7		Easy-launch buttons	Buttons for launching frequently used programs.
8		Palmrest	Comfortable support area for your hands when you use the computer.
9		Touchpad	Touch-sensitive pointing device which functions like a computer mouse.
10		Click buttons (left, center* and right)	The left and right buttons function like the left and right mouse buttons. *The center button serves as Acer BioProtect fingerprint reader supporting Acer FingerNav 4-way control function (manufacturing option).
11		Status indicators	Light-Emitting Diodes (LEDs) that light up to show the status of the computer's functions and components.
12		Keyboard	For entering data into your computer.
13		Power button	Turns the computer on and off.





Closed Front View



	Icon	Item	Description
1		Latch	Locks and releases the lid.
2		5-in-1 card reader	Accepts Secure Digital (SD), MultiMediaCard (MMC), Memory Stick (MS), Memory Stick Pro (MS PRO), and xD-Picture Card. Note: Only one card can operate at any given time.
3		Line-in jack	Accepts audio line-in devices (e.g., audio CD player, stereo walkman, mp3 player)
4		Microphone jack	Accepts inputs from external microphones.
5		Headphones/ speaker/line-out jack.	Connects to audio line-out devices (e.g., speakers, headphones).
6		Bluetooth communication switch	Enable/disable the Bluetooth function. (manufacturing option).
7		Wireless communication switch	Enable/disable the wireless function. (manufacturing option).

Left View



#	Icon	Item	Description
1		Kensington lock slot	Connects to a Kensington-compatible computer security lock.
2		External display (VGA) port	Connects to a display device (e.g., external monitor, LCD projector).
3		Ethernet (RJ-45) port	Connects to an Ethernet 10/100/1000-based network.
4		Two USB 2.0 ports	Connect to USB 2.0 devices (e.g., USB mouse, USB camera).
5	ExpressCard / 54	ExpressCard/54 slot	Accepts one ExpressCard/54 module.
6		PC Card slot	Accepts one Type II PC Card.
7		PC Card slot eject button	Ejects the PC Card from the slot.



Right View



	Icon	Item	Description
1		Optical drive	Internal optical drive; accepts CDs or DVDs.
2		Optical disk access indicator	Lights up when the optical drive is active.
3		Optical drive eject button	Ejects the optical disk from the drive.
4		Emergency eject hole	Ejects the optical drive tray when the computer is turned off. Note: Insert a paper clip to the emergency eject hole to eject the optical drive tray when the computer is off.





Rear View

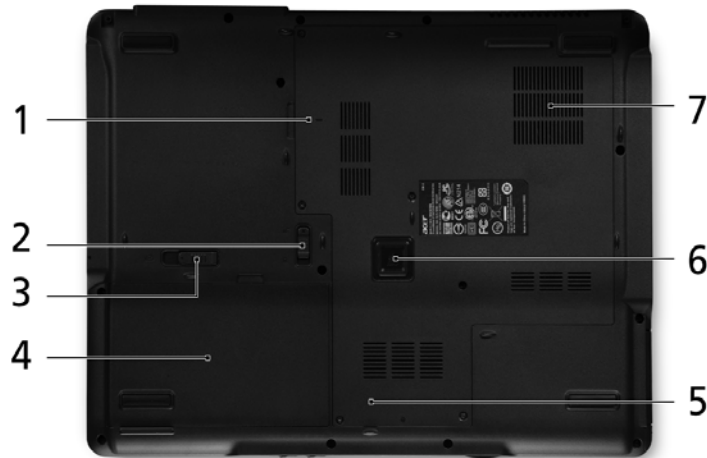

#	Icon	Item	Description
1		USB 2.0 port	Connects to USB 2.0 devices (e.g., USB mouse, USB camera).
2		Modem (RJ-11) port	Connects to a phone line.
3		DC-in jack	Connects to an AC adapter.
4		Ventilation slots	Enable the computer to stay cool, even after prolonged use.







Bottom View



	Icon	Item	Description
1		Memory compartment	Houses the computer's main memory.
2		Battery lock	Locks the battery in position.
3		Battery release latch	Releases the battery for removal.
4		Battery bay	Houses the computer's battery pack.
5		Hard disk bay	Houses the computer's hard disk (secured with screws).
6	6	Acer DASP (Disk Anti-Shock Protection)	Protects the hard disk drive from shocks and bumps (only for certain models).
7		Ventilation slots	Enable the computer to stay cool, even after prolonged use.

Indicators

The computer has several easy-to-read status indicators. The front panel indicators are visible even when the computer cover is closed.



Icon	Function	Description
	HDD	Indicates when the hard disk drive is active.
	Num Lock	Lights up when Num Lock is activated.
	Caps Lock	Lights up when Caps Lock is activated.
	Power	Indicates the computer's power status.
	Battery	Indicates the computer's battery status.
	Bluetooth (Manufacturing option)	Indicates the status of Bluetooth communication.
	Wireless LAN (Manufacturing option)	Indicates the status of wireless LAN communication.

NOTE: 1. **Charging:** The light shows amber when the battery is charging. 2. **Fully charged:** The light shows green when in AC mode.

Easy-Launch Buttons

Located beside the keyboard are application buttons. These buttons are called easy-launch buttons. They are: WLAN, Internet, email, Bluetooth, Arcade and Acer Empowering Technology.

The mail and Web browser buttons are pre-set to email and Internet programs, but can be reset by users. To set the Web browser, mail and programmable buttons, run the Acer Launch Manager. You can access the Launch Manager by clicking on Start, All Programs, and then Launch Manager to start the application.

Icon	Function	Description
	Acer Empowering Technology	Launch Acer Empowering Technology (user-programmable)
	Web browser	Internet browser (user-Programmable)
	Mail	Email application (user-Programmable)
P	Programmable key	User-programmable

Touchpad Basics (with fingerprint reader)

The following items show you how to use the touchpad with Acer Bio-Protection fingerprint reader.

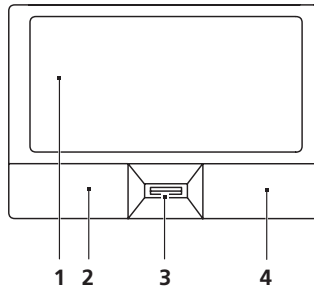

- Move your finger across the touchpad (2) to move the cursor.
- Press the left (1) and right (4) buttons located beneath the touchpad to perform selection and execution functions. These two buttons are similar to the left and right buttons on a mouse. Tapping on the touchpad is the same as clicking the left button.
- Use Acer Bio-Protection fingerprint reader (3) supporting Acer FingerNav 4-way control function (only for certain models) to scroll up or down and move left or right a page. This fingerprint reader or button mimics your cursor pressing on the right scroll bar of Windows applications.

Function	Left button (1)	Right button (4)	Main touchpad (2)	Center button (3)
Execute	Quickly click twice.		Tap twice (at the same speed as double-clicking a mouse button).	
Select	Click once.		Tap once.	
Drag	Click and hold, then use finger on the touchpad to drag the cursor.		Tap twice (at the same speed as double-clicking a mouse button); rest your finger on the touchpad on the second tap and drag the cursor.	
Access context menu		Click once.		
Scroll				Swipe up/down/left/right using Acer FingerNav 4-way control function (Manufacturing option).

Touchpad basics (with two-click buttons)

The following items show you how to use the touchpad with two-click buttons.

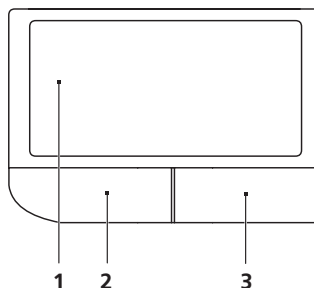

- Move your finger across the touchpad (1) to move the cursor.

- Press the left **(2)** and right **(3)** buttons located beneath the touchpad to perform selection and execution functions. These two buttons are similar to the left and right buttons on a mouse. Tapping on the touchpad is the same as clicking the left button.

Function	Left button (2)	Right button (3)	Main touchpad (1)
Execute	Quickly click twice.		Tap twice (at the same speed as double-clicking a mouse button).
Select	Click once.		Tap once.
Drag	Click and hold, then use finger on the touchpad to drag the cursor.		Tap twice (at the same speed as double-clicking a mouse button); rest your finger on the touchpad on the second tap and drag the cursor.
Access context menu		Click once.	

NOTE: Illustrations for reference only. The exact configuration of your PC depends on the model purchased.

NOTE: When using the touchpad, keep it — and your fingers — dry and clean. The touchpad is sensitive to finger movement; hence, the lighter the touch, the better the response. Tapping harder will not increase the touchpad's responsiveness.

NOTE: By default, vertical and horizontal scrolling is enabled on your touchpad. It can be disabled under Mouse settings in Windows Control Panel.

Using the Keyboard

The keyboard has full-sized keys and an embedded numeric keypad, separate cursor, lock, Windows, function and special keys.

Lock Keys and embedded numeric keypad

The keyboard has three lock keys which you can toggle on and off.



















Lock key	Description
Caps Lock	When Caps Lock is on, all alphabetic characters typed are in uppercase.
Num Lock <Fn> + <F11>	When Num Lock is on, the embedded keypad is in numeric mode. The keys function as a calculator (complete with the arithmetic operators +, -, *, and /). Use this mode when you need to do a lot of numeric data entry. A better solution would be to connect an external keypad. NOTE: <Fn> + <F11> works only for certain models.
Scroll Lock <Fn> + <F12>	When Scroll Lock is on, the screen moves one line up or down when you press the up or down arrow keys respectively. Scroll Lock does not work with some applications.

The embedded numeric keypad functions like a desktop numeric keypad. It is indicated by small characters located on the upper right corner of the key caps. To simplify the keyboard legend, cursor-control key symbols are not printed on the keys.

Desired access	Num Lock on	Num Lock off
Number keys on embedded keypad	Type numbers in a normal manner.	
Cursor-control keys on embedded keypad	Hold <Shift> while using cursor-control keys.	Hold <Fn> while using cursor-control keys.
Main keyboard keys	Hold <Fn> while typing letters on embedded keypad.	Type the letters in a normal manner.

Windows Keys











The keyboard has two keys that perform Windows-specific functions.

Key	Description
 Windows key	<p>Pressed alone, this key has the same effect as clicking on the Windows Start button; it launches the Start menu.</p> <p>It can also be used with other keys to provide a variety of functions:</p> <p><  >: Open or close the Start menu</p> <p><  > + <D>: Display the desktop</p> <p><  > + <E>: Open Windows Explore</p> <p><  > + <F>: Search for a file or folder</p> <p><  > + <G>: Cycle through Sidebar gadgets</p> <p><  > + <L>: Lock your computer (if you are connected to a network domain), or switch users (if you're not connected to a network domain)</p> <p><  > + <M>: Minimizes all windows</p> <p><  > + <R>: Open the Run dialog box</p> <p><  > + <T>: Cycle through programs on the taskbar</p> <p><  > + <U>: Open Ease of Access Center</p> <p><  > + <X>: Open Windows Mobility Center</p> <p><  > + <BREAK>: Display the System Properties dialog box</p> <p><  > + <SHIFT+M>: Restore minimized windows to the desktop</p> <p><  > + <TAB>: Cycle through programs on the taskbar by using Windows Flip 3-D</p> <p><  > + <SPACEBAR>: Bring all gadgets to the front and select Windows Sidebar</p> <p><CTRL> + <  > + <F>: Search for computers (if you are on a network)</p> <p><CTRL> + <  > + <TAB>: Use the arrow keys to cycle through programs on the taskbar by using Windows Flip 3-D</p> <p>Note: Depending on your edition of Windows Vista, some shortcuts may not function as described.</p>
 Application key	<p>This key has the same effect as clicking the right mouse button; it opens the application's context menu.</p>

Hot Keys

The computer employs hotkeys or key combinations to access most of the computer's controls like screen brightness, volume output and the BIOS utility.

To activate hot keys, press and hold the <Fn> key before pressing the other key in the hotkey combination.

Hotkey	Icon	Function	Description
<Fn> + <F1>	?	Hotkey help	Displays help on hotkeys.
<Fn> + <F2>		Acer eSettings	Launches Acer eSettings in Acer Empowering Technology.
<Fn> + <F3>		Acer ePower Management	Launches Acer ePower Management in Acer Empowering Technology.
<Fn> + <F4>	Z ^z	Sleep	Puts the computer in Sleep mode.
<Fn> + <F5>		Display toggle	Switches display output between the display screen, external monitor (if connected) and both.
<Fn> + <F6>		Screen blank	Turns the display screen backlight off to save power. Press any key to return.
<Fn> + <F7>		Touchpad toggle	Turns the internal touchpad on and off.
<Fn> + <F8>		Speaker toggle	Turns the speakers on and off.
<Fn> + <▷>		Brightness up	Increases the screen brightness.
<Fn> + <◁>		Brightness down	Decreases the screen brightness.
<Fn> + <△>		Volume up	Increases the sound volume (only for certain models).
<Fn> + <▽>		Volume down	Decreases the sound volume (only for certain models).

Special Key (only for certain models)

You can locate the Euro symbol and the US dollar sign at the upper-center and/or bottom-right of your keyboard.

The Euro symbol

1. Open a text editor or word processor.
2. Either press <€> at the bottom-right of the keyboard, or hold <Alt Gr> and then press the <5> key at the upper-center of the keyboard.

NOTE: Some fonts and software do not support the Euro symbol. Please refer to www.microsoft.com/typography/faq/faq12.htm for more information.

The US dollar sign

1. Open a text editor or word processor.
2. Either press <\$> at the bottom-right of the keyboard, or hold <Shift> and then press the <4> key at the upper-center of the keyboard.

NOTE: This function varies according to the language settings.

Acer Empowering Technology

The Empowering Technology toolbar makes it easy for you to access frequently used functions and manage your new Acer system. Activated by pressing the Empowering Key, it provides access to the following utilities:

NOTE: The following content is for general reference only. Actual product specifications may vary.

- **Acer eDataSecurity Management** protects data with passwords and encryption (only for certain models).
- **Acer ePower Management** optimizes battery usage via customizable power plans.
- **Acer eRecovery Management** backs up and recovers data flexibly, reliably and completely.
- **Acer eSettings Management** accesses system information and adjusts settings easily.



For more information, right-click on the Empowering Technology toolbar, then select **Help**. For help with a particular utility, launch the utility and click the  icon at the bottom of the active window.

Launching Acer Empowering Technology

To launch Acer Empowering Technology:

1. Press the Empowering Key to display the Acer Empowering Technology toolbar on the desktop.

2. To hide the toolbar, press the Empowering Key again or click the hide button  on the toolbar.

You may also launch Acer Empowering Technology by running the program from the Acer Empowering Technology program group in the Start menu, or by double-clicking the  icon if you have created a desktop shortcut.

To launch Acer Empowering Technology applications:

1. On the Acer Empowering Technology toolbar, click the icon that corresponds to the application you want to launch.

2. When you mouse over an application icon, a quick menu appears below the toolbar. The quick menu allows you to perform certain tasks simply and quickly.



3. You may also run the application by selecting it from the Acer Empowering Technology program group in the Start menu.

Empowering Technology password

You must set the Empowering Technology password to use the password protection feature of Acer eRecovery Management to protect your data.

To set the Empowering Technology password:

1. Launch Acer eRecovery Management.
2. Click the Restore tab.
3. Click **Password settings**. The Empowering Technology Password Center dialogue box pops up.
4. Click **Create a new password**.

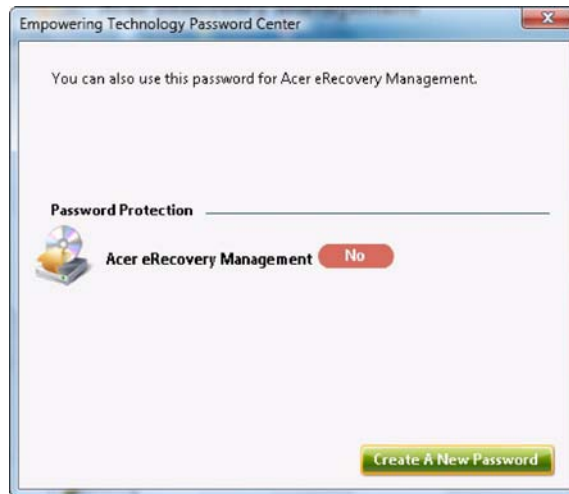

5. In the Create a New Password dialogue box, key in and confirm your password in the appropriate boxes. Your password should have a minimum of 4 and a maximum of 12 characters.
6. Enter a password hint that will help you remember your password.
7. Make sure the box **Use for Acer eRecovery Management** is checked.
8. Click **OK** to set the password.



Acer ePower Management



Acer ePower Management features a straightforward user interface for configuring your power management options. To access this utility, select **Acer ePower Management** from the Empowering Technology toolbar, run the program from the Acer Empowering Technology program group in Start menu, or right-click the Windows power icon in the system tray and select **Acer ePower Management**.

Using power plans

Acer ePower Management comes with three predefined power plans: Balanced, High performance and Power saver. You can also create customized power plans. You can create, switch between, edit, delete and restore power plans, as described below.

View and adjust settings for On Battery and Plugged In modes by clicking the appropriate tabs. For more power options, click  in the Acer ePower Management utility, or right-click the Windows power icon in the system tray and select **Power Options**.

NOTE: You cannot delete the predefined power plans.

To create a new power plan:

Creating customized power plans allows you to save and quickly switch to a personalized set of power options.

1. Click the **New power plan** option or icon .
2. Enter a name for your new power plan.
3. Choose a predefined power plan to base your customized plan on.
4. If necessary, change the display, sleep and hibernation settings you want your computer to use.
5. Click **OK** to save your new power plan.

To switch between power plans:

1. Mouse over the Acer ePower Management application on the Acer Empowering Technology toolbar. The quick menu appears. Select the power plan you want to switch to.
2. You may also switch between power plans by launching the Acer ePower Management application. Select the power plan you wish to switch to, then click **Apply**.

To edit a power plan:

Editing a power plan allows you to adjust system settings like LCD brightness and CPU speed.

1. Switch to the power plan you wish to edit.
2. Adjust settings as required.
3. Click **Apply** to save your new settings.

To delete a power plan:

You cannot delete the power plan you are currently using. If you want to delete the active power plan, switch to another one first.

1. Select the power plan you wish to delete.
2. Click the Delete Power Plan icon. 

Battery status

1. The quick menu shows the remaining battery life based on current usage.
2. You can also launch the Acer ePower Management application and refer to the Battery status panel located just below the power plans.

3. Click the Battery tab to view remaining battery life, battery status, and remaining battery life in standby and hibernate modes.

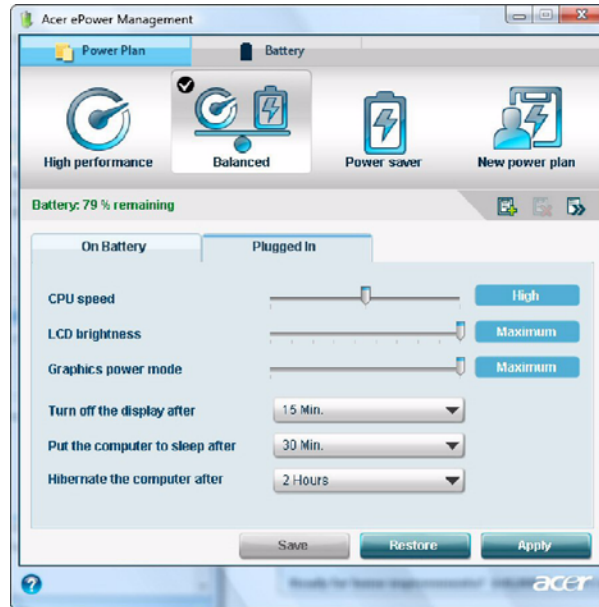

Acer eDataSecurity Management (only for certain models)

Acer eDataSecurity Management is an encryption utility that protects your files from being accessed by unauthorized persons. It is conveniently integrated with Windows Explorer as a shell extension for quick data encryption/decryption and also supports on-the-fly file encryption for Lotus Notes and Microsoft Outlook.

On first use, the Acer eDataSecurity Management setup wizard will prompt you to create the Master Password. You will use this password to access the Personal Secure Disk (PSD). The Master Password may also be used to encrypt/decrypt files by default.

If you set a different password to encrypt a file, but you forgot the encryption password, you can use the Master Password to decrypt the file.

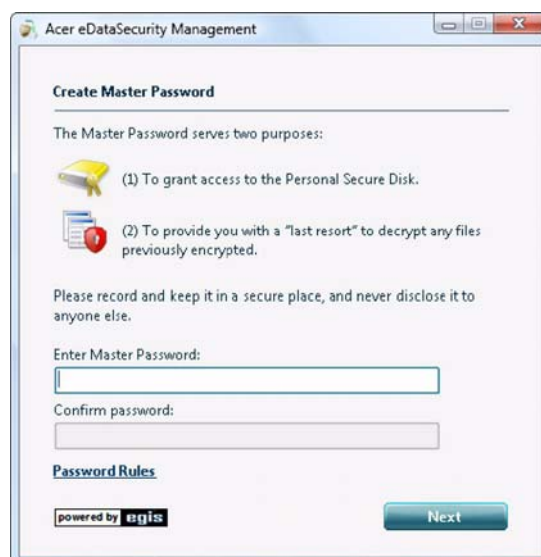

NOTE: The password used to encrypt a file is the unique key that the system needs to decrypt it. If you lose the password, the Master Password is the only other key capable of decrypting the file. If you lose both

passwords, there will be no way to decrypt your encrypted file! **Be sure to safeguard all related passwords!**



Acer eRecovery Management



Acer eRecovery Management is a versatile backup utility. It allows you to create full or incremental backups, burn the factory default image to optical disc, and restore from previously created backups or reinstall applications and drivers. By default, user-created backups are stored to the D:\ drive.

Acer eRecovery Management provides you with:

- Backup:
 - Back up factory default to CD/DVD
 - Back up drivers and applications to CD/DVD
 - Create user backup
 - Manage user backups
- Restore:
 - Restore system to factory default
 - Reinstall applications/drivers
 - Restore system from user backup
 - Password settings

To use the password protection feature of Acer eRecovery Management to protect your data, you must first set the Empowering Technology password. To set the password, refer to the section "**Empowering Technology password**".



NOTE: If your computer did not come with a Recovery CD or System CD, please use Acer eRecovery Management's Backup factory default to CD/DVD feature to burn a backup image to CD or DVD. To ensure the best results when recovering your system using a CD or Acer eRecovery Management, detach all peripherals (except the external Acer ODD, if your computer has one), including your Acer ezDock.

Acer eSettings Management

Acer eSettings Management allows you to inspect hardware specifications, set BIOS passwords and modify boot options.

Acer eSettings Management also:

- Provides a simple graphical user interface for navigation.
- Prints and saves hardware specifications.
- Lets you set an asset tag for your system.

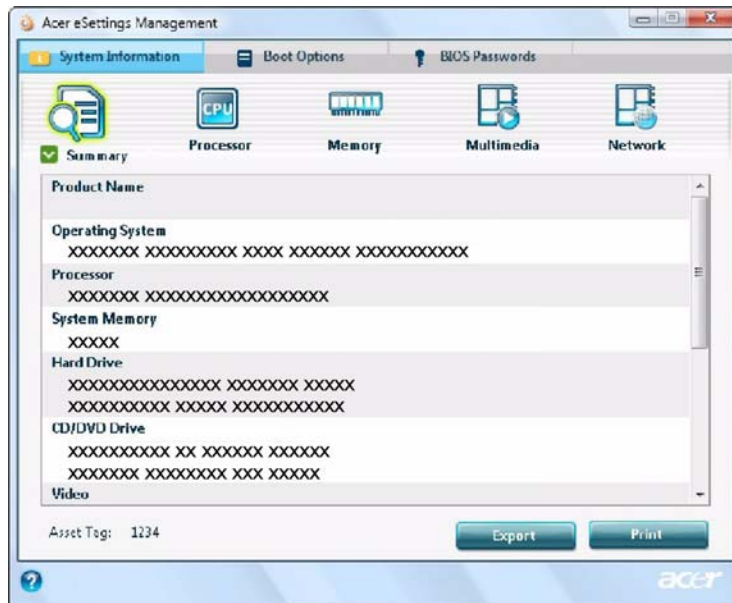

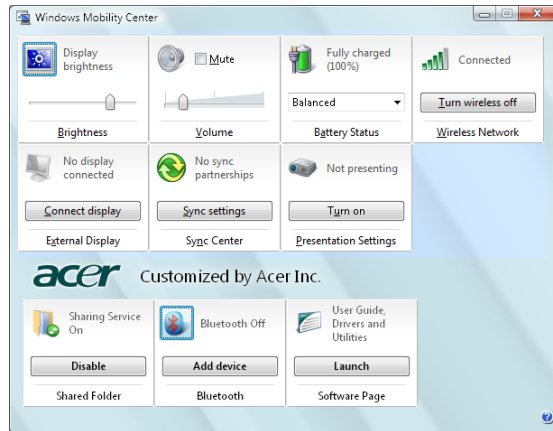

Windows Mobility Center



The Windows Mobility Center collects key mobile-related system settings in one easy-to-find place, so you can quickly configure your Acer system to fit the situation as you change locations, networks or activities. Settings include display brightness, volume, power plan, wireless networking on/off, external display settings, synchronization status and presentation settings.

Windows Mobility Center also includes Acer-specific settings like sharing folders overview/sharing service on or off, Bluetooth Add Device (if applicable), and a shortcut to the Acer user guide, drivers and utilities.

To launch Windows Mobility Center:

- q Use the shortcut key <  > + <X>.
- q Start Windows Mobility Center from the Control panel.
- q Start Windows Mobility Center from the Accessories program group in the Start menu.
- q Launch Windows Mobility Center by right-clicking  in the system tray and select **Windows Mobility Center**.

Using the System Utilities

Acer Bio-Protection (only for certain models)

Acer Bio-Protection Fingerprint Solution is a multi-purpose fingerprint software package integrated with the Microsoft Windows operating system. Utilizing the uniqueness of one's fingerprint features, Acer Bio-Protection Fingerprint Solution has incorporated protection against unauthorized access to your computer with centralized password management with Password Bank, easy music player launching with Acer MusicLaunch, secure Internet favorites via Acer MyLaunch, and fast application/website launching and login with Acer FingerLaunch, while Acer ProfileLaunch can launch up to three applications/websites from a single finger swipe.

Acer Bio-Protection Fingerprint Solution also allows you to navigate through web browsers and documents using Acer FingerNav. With Acer Bio-Protection Fingerprint Solution, you can now enjoy an extra layer of protection for your personal computer, as well as the convenience of accessing your daily tasks with a simple swipe of your finger!

For more information refer to the Acer Bio-Protection help files.

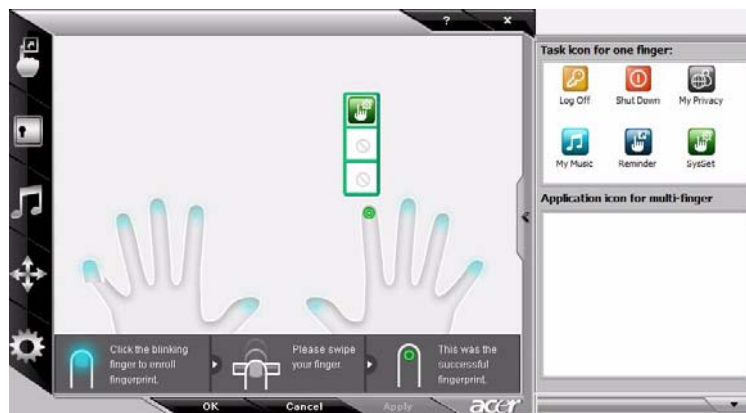

Acer GridVista (dual-display compatible)

NOTE: This feature is only available on certain models.

To enable the dual monitor feature of the notebook, first ensure that the second monitor is connected, then select **Start, Control Panel, Display** and click on **Settings**. Select the secondary monitor (2) icon in the display box and then click the check box **Extend my windows desktop onto this monitor**. Finally, click **Apply** to confirm the new settings and click **OK** to complete the process.

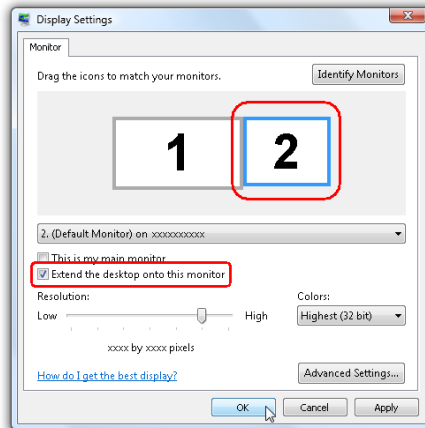

Acer GridVista is a handy utility that offers four pre-defined display settings so you can view multiple windows on the same screen. To access this function, please go to **Start>All Programs** and click on **Acer GridVista**. You may choose any one of the four display settings indicated below:

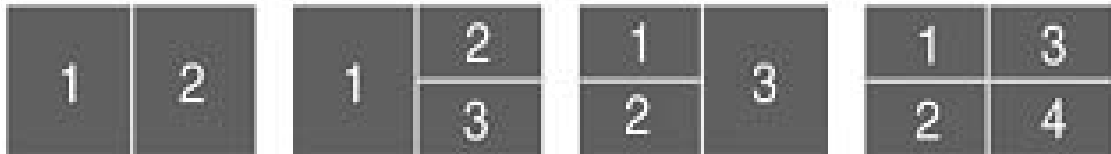

Double (vertical), Triple (primary at left), Triple (primary at right), or Quad Acer Gridvista is dual-display compatible, allowing two displays to be partitioned independently.

Acer Gridvista is dual-display compatible, allowing two displays to be partitioned independently.

AcerGridVista is simple to set up:

1. Run Acer GridVista and select your preferred screen configuration for each display from the task bar.
2. Drag and drop each window into the appropriate grid.
3. Enjoy the convenience of a well-organized desktop.

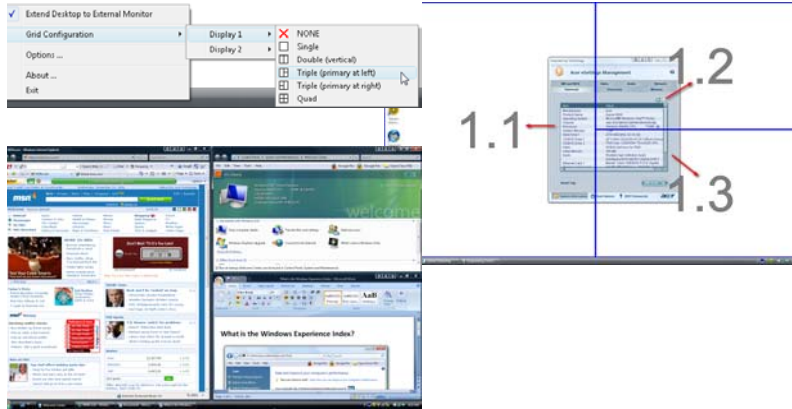

NOTE: Please ensure that the resolution setting of the second monitor is set to the manufacturer's recommended value.

Hardware Specifications and Configurations

Processor

Item	Specification
CPU type	Intel® Core™2 Duo Mobile Processor P7350; Intel® Celeron® Dual-Core T1600; Intel® Celeron® M 575 (for Extensa 5230) Intel® Pentium® dual-core processor T3200/T3400 (for Extensa 5630Z) Intel® Celeron® Dual-Core processor T1600; Intel® Celeron® M 575 (for TravelMate 5330)
Core logic	Mobile Intel® G40 Express Chipset+ICH9M
CPU package	Socket P (478-pin Micro FCPGA)
CPU core voltage	1.0375V to 1.3V 0.762V to 1.3V for Intel® Celeron® Dual-Core T1600

Processor Specification

Processor #	CPU Speed	Cores	Bus Speed	Mfg Tech	Cache Size	Package	Acer PN
P7350	2.0GHz	2	1066MHz	45nm	3MB	socket P	KC.73501.DPP
T3200	2.0GHz	2	667MHz	65nm	1MB	socket P	KC.32001.DTP
T3400	2.16GHz	2	533MHz	65nm	1MB	socket P	KC.34001.DTP
T1600	1.66GHz	2	667MHz	65nm	1MB	socket P	KC.16001.CMT
575	2.0GHz	1	667MHz	65nM	1MB	socket P	KC.N0001.575

Note: The front side bus speed for T3400 is not confirm. Please check hardware propriety on MP unit for more details.

CPU Fan True Value Table

DTS(degree C)	Fan Speed (rpm)	Acoustic Level (dBA)
45-50	0-3000	29
55-66	0-3300	33
68-74	3300-3800	38
78-83	3800-4100	40
86-91	4100-4800	40

Throttling 50%: On= 99° C; OFF=93° C

OS shut down at 105° C; H/W shot down at 110° .C

BIOS

Item	Specification
BIOS vendor	Phoenix
BIOS Version	1.04c

System Memory

Item	Specification
Memory controller	Built-in
Memory size	0MB (no on-board memory)

System Memory

Item	Specification
DIMM socket number	2 sockets
Supports memory size per socket	2048MB
Supports maximum memory size	4G for 64bit OS (with two 2GB SODIMM)
Supports DIMM type	DDR 2 Synchronous DRAM
Supports DIMM Speed	667 MHz
Supports DIMM voltage	1.8V and 0.9V
Supports DIMM package	200-pin soDIMM
Memory module combinations	You can install memory modules in any combinations as long as they match the above specifications.

Memory Combinations

Slot 1	Slot 2	Total Memory
0MB	256MB	256MB
0MB	512MB	512MB
0MB	1024MB	1024MB
0MB	2048MB	2048MB
256MB	256MB	512MB
256MB	512MB	768MB
256MB	1024MB	1280MB
256MB	2048MB	2304MB
512MB	256MB	768MB
512MB	512MB	1024MB
512MB	1024MB	1536MB
512MB	2048MB	2560MB
1024MB	0MB	1024MB
1024MB	256MB	1280MB
1024MB	512MB	1536MB
1024MB	1024MB	2048MB
1024MB	2048MB	3072MB
2048MB	0MB	2048MB
2048MB	256MB	2304MB
2048MB	512MB	2560MB
2048MB	1024MB	3072MB
2048MB	2048MB	4096MB

NOTE: Above table lists some system memory configurations. You may combine DIMMs with various capacities to form other combinations. On above table, the configuration of slot 1 and slot 2 could be reversed.

Item	Specification
LAN Chipset	Broadcom BCM5764/Broadcom BCM5765
Supports LAN protocol	10/100/1000 Mbps
LAN connector type	RJ45
LAN connector location	Left side

Item	Specification
Features	Integrated 10/100 BASE-T transceiver Wake on LAN support compliant with ACPI 2.0 PCI v2.2

Bluetooth Interface

Item	Specification
Chipset	Foxconn Bluetooth FOX_BRM_2.0 F/W 300
Data throughput	723 bps (full speed data rate)
Protocol	Bluetooth 1.1 (Upgradeable to Bluetooth 1.2 when SIG specification is ratified).
Interface	USB 1.1
Connector type	USB

Wireless Module 802.11b/g

Item	Specification
Chipset	WLAN 802.11ABGN SHIRLEYPEAK1*2
Data throughput	11~54 Mbps, up to 270 Mbps for Draft-N
Protocol	802.11b+g, Draft-N
Interface	PCI bus (mini PCI socket for wireless module)

Hard Disk Drive Interface

Item				
Vendor & Model Name	HGST HTS542512K9SA00 BRONCO-B LF SEAGATE ST9120817AS LF TOSHIBA MK1246GSX LF WD1200BEVS- 22UST0 ML125 LF	WD1600BEVT- 22ZCT0 HITACHI HTS541616J9SA00 LF SEAGATE SATA ST9160827AS TOSHIBA MK1646GSX LF	SEAGATE SATA ST9250827AS TOSHIBA MK2546GSX LF HGST HTS542525K9SA00 LF WD WD2500BEVS- 22UST0 ML125	WD WD3200BEVT- 22ZCT0 ML125
Capacity (MB)	120000	160000	250000	320000
Bytes per sector	512	512	512	N/A
Data heads	3	3/4	4	N/A
Drive Format				
Disks	2	2	2	N/A
Spindle speed (RPM)	5400 RPM	5400 RPM	5400 RPM	5400 RPM
Performance Specifications				
Buffer size	8MB	8MB	8MB	8MB
Interface	SATA	SATA	SATA	SATA

Hard Disk Drive Interface

Item				
Max. media transfer rate (disk-buffer, Mbytes/s)	540	540	540	850
DC Power Requirements				
Voltage tolerance	5V(DC) +/- 5%	5V(DC) +/- 5%	5V(DC) +/- 5%	5V(DC) +/- 5%

Optical Disc Drive

Item	Specification	
Vendor & model name	TOSHIBA SUPER-MULTI DRIVE DL 8X TS-L633A LF PIONEER SUPER-MULTI DRIVE 8X DVR-TD08RS LF PANASONIC SUPER-MULTI DRIVE DL 8X UJ-870A LF HLDS SUPER-MULTI DRIVE TRAY DL 8X GSA-T50N LF HLDS SUPER-MULTI DRIVE DL 8X GSA-T50N LF SONY SUPER-MULTI DRIVE DL 8X AD-7560S LF PLDS SUPER-MULTI DRIVE DL 8X DS-8A2S LF	
Performance Specification	With CD Diskette	With DVD Diskette
Transfer rate (KB/sec)	Sustained: Max 3.6Mbytes/sec	Sustained: Max 10.08Mbytes/sec
Buffer Memory	2MB	
Interface	SATA	
Applicable disc format	<p>Applicable disc format</p> <p>CD: CD-DA, CD-ROM, CD-ROM XA, Photo CD (multi-session), Video CD, Cd-Extra (CD+), CD-text</p> <p>DVD: DVD-VIDEO, DVD-ROM, DVD-R (3.9GB, 4.7GB) DVD-R DL, DVD-RW, DVD-RAM, DVD+R, DVD+R DL, DVD+RW</p> <p>CD:</p> <p>CD-DA (Red Book) - Standard Audio CD & CD-TEXT</p> <p>CD-ROM (Yellow Book Mode1 & 2) - Standard Data</p> <p>CD-ROM XA (Mode2 Form1 & 2) - Photo CD, Multi-Session</p> <p>CD-I (Green Book, Mode2 Form1 & 2, Ready, Bridge)</p> <p>CD-Extra/ CD-Plus (Blue Book) - Audio & Text/Video</p> <p>Video-CD (White Book) - MPEG1 Video</p> <p>CD-R (Orange Book Part)</p> <p>CD-RW & HSRW (Orange Book Part Volume1 & Volume 2)</p> <p>Super Audio CD (SACD) Hybrid type</p> <p>US & US+ RW</p> <p>DVD:</p> <p>DVD-ROM (Book 1.02), DVD-Dual</p> <p>DVD-Video (Book 1.1)</p> <p>DVD-R (Book 1.0, 3.9G)</p> <p>DVD-R (Book 2.0, 4.7G) - General & Authoring</p> <p>DVD+R (Version 1.0)</p> <p>DVD+RW</p> <p>DVD-RW (Non CPRM & CPRM)</p> <p>DVD[®]R Dual</p>	

Optical Disc Drive

Item	Specification
Loading mechanism	Load: Manual Release: (a) Electrical Release (Release Button) (b) Release by ATAPI command (c) Emergency Release
Power Requirement	
Input Voltage	5 V +/- 5% (Operating)

Audio Interface

Item	Specification
Audio Controller	Realtek ALC883 Azalia and Amplifier Maxim MAX9710 & MAX4411
Audio onboard or optional	Built-in
Mono or Stereo	Stereo
Resolution	18 bit stereo full duplex
Compatibility	HD audio Interface; S/PDIF output for PCM or AC-3 content
Sampling rate	1Hz resolution VSR (Variable Sampling Rate)
Internal microphone	Yes
Internal speaker / Quantity	Yes/2 (1.5W speakers)

Video Memory

Item	Specification
Chipset	Mobile Intel® GL40 Express Chipset
Memory size	512M GDDR3/

Item	Specification
Chipset	ICH9M
USB Compliancy Level	2.0
OHCI	USB 1.1 and USB 2.0 Host controller
Number of USB port	3
Location	Two on the right side/one on the front
Serial port function control	Enable/Disable by BIOS Setup

System Board Major Chips

Item	Controller
Core logic	Mobile Intel® GL40 + ICH9M Express Chipset
VGA	built-in Mobile Intel® GL40
USB 2.0	Intel ICH9M
Super I/O controller	N/A (these models do not have super I/O function)
MODEM	Intel ICH9M

System Board Major Chips

Item	Controller
Bluetooth	Intel ICH9M
Wireless 802.11 b+g	Intel ICH9M
PCMCIA/ 5 in 1 Card Reader	OZ711MZ
Audio Codec	Audio Azalia(ALC268)
LAN	BCM5764M

Keyboard

Item	Specification
Keyboard controller	Winbond WPC775
Total number of keypads	84-/85-key
Windows logo key	Yes
Internal & external keyboard work simultaneously	Plug USB keyboard to the USB port directly: Yes

Battery

Item	Specification
Vendor	Panasonic/Sanyo/Sony/Simplio
Battery Type	Li-ion
Pack capacity	6Cell 4400 MAH/8Cell 4800 MAH
Number of battery cell	6/8
Package configuration	3 cells in series, 2 series in parallel 4 cells in series, 2 series in parallel

LCD 15.4" inch

Item	Specification
Vendor & model name	CMO/AUO/LG
Screen Diagonal (mm)	15.4 inches
Display resolution (pixels)	1280 x 800 WXGA
Pixel Pitch	0.204 x 0.204
Pixel Arrangement	R.G.B. Vertical Stripe
Display Mode	Normally White
Typical White Luminance (NIT) also called Brightness	220
Luminance Uniformity	1.25 max.
Contrast Ratio	400 typical
Response Time msec	8
Nominal Input Voltage VDD	+3.3V
Viewing Angle (degree) Horizontal: Right/Left Vertical: Upper/Lower	45/45 15/35

LCD 15.4" inch

Item	Specification
Temperature Range(° C) Operating Storage (shipping)	0 to +50 -40 to +60

AC Adaptor

Item	Specification
Input	100-240V~ 1.5A, 50-60Hz/
Output	19V 4.74A 90W/19V 3.42A 65W

System Power Management

ACPI mode	Power Management
Mech. Off (G3)	All devices in the system are turned off completely.
Soft Off (G2/S5)	OS initiated shutdown. All devices in the system are turned off completely.
Working (G0/S0)	Individual devices such as the CPU and hard disc may be power managed in this state.
Suspend to RAM (S3)	CPU set power down VGA Suspend PCMCIA Suspend Audio Power Down Hard Disk Power Down CD-ROM Power Down Super I/O Low Power mode
Save to Disk (S4)	Also called Hibernation Mode. System saves all system states and data onto the disc prior to power off the whole system.

System Utilities

BIOS Setup Utility

The BIOS Setup Utility is a hardware configuration program built into your computer's BIOS (Basic Input/Output System).

Your computer is already properly configured and optimized, and you do not need to run this utility. However, if you encounter configuration problems, you may need to run Setup. Please also refer to Chapter 4 Troubleshooting when problem arises.

To activate the BIOS Utility, press **F2** during POST (when "Press <F2> to enter Setup" message is prompted on the bottom of screen).

Press **F2** to enter setup. The default parameter of F12 Boot Menu is set to "disabled". If you want to change boot device without entering BIOS Setup Utility, please set the parameter to "enabled".

Press <F12> during POST to enter multi-boot menu. In this menu, user can change boot device without entering BIOS SETUP Utility.

```

Phoenix SecureCore(tm) Setup Utility
-----
Information  Main  Security  Boot  Exit

CPU Type:           Intel (R) Core (TM)2 Duo CPU T9400 @ 2.53 GHz
CPU Speed:          2.53 GHz
IDE0 Model Name:    XXXXXXXXXXXX-(XX)
IDE0 Serial Number: XXXXXXXX
ATAPI Model Name:   XXXXXXXXXXXX-XXX XX-XXXX-(XX)
System BIOS Version: VX.XX
VGA BIOS Version:  XX-XXX XXXXXX.XXX.XXX.XXX.XXXXXX
KBC Version:        XX.XX
Serial Number:      XXXXXXXXXXXXXXXXXXXXXXXXXX
Asset Tag Number:   None
Product Name:       Aspire 5930
Manufacturer Name:  Acer
UUID:               XXXxXxXX-xXxX-XXxx-xXXx-xXXxXXxXxxXX

F1 Help  ↑↓ Select Item  -/+ Change Values  F9 Setup Defaults
Esc Exit  ← Select Menu  Enter Select ► Sub-Menu  F10 Save and Exit

```

Navigating the BIOS Utility

There are six menu options: Information, Main, Security, Boot, and Exit.

Follow these instructions:

- q To choose a menu, use the left and right arrow keys.
- q To choose an item, use the up and down arrow keys.
- q To change the value of a parameter, press **F5** or **F6**.
- q A plus sign (+) indicates the item has sub-items. Press **Enter** to expand this item.
- q Press **Esc** while you are in any of the menu options to go to the Exit menu.
- q In any menu, you can load default settings by pressing **F9**. You can also press **F10** to save any changes made and exit the BIOS Setup Utility.

NOTE: You can change the value of a parameter if it is enclosed in square brackets. Navigation keys for a particular menu are shown on the bottom of the screen. Help for parameters are found in the Item Specific Help part of the screen. Read this carefully when making changes to parameter values. **Please note that system information is subject to different models.**

Information

The Information screen displays a summary of your computer hardware information.

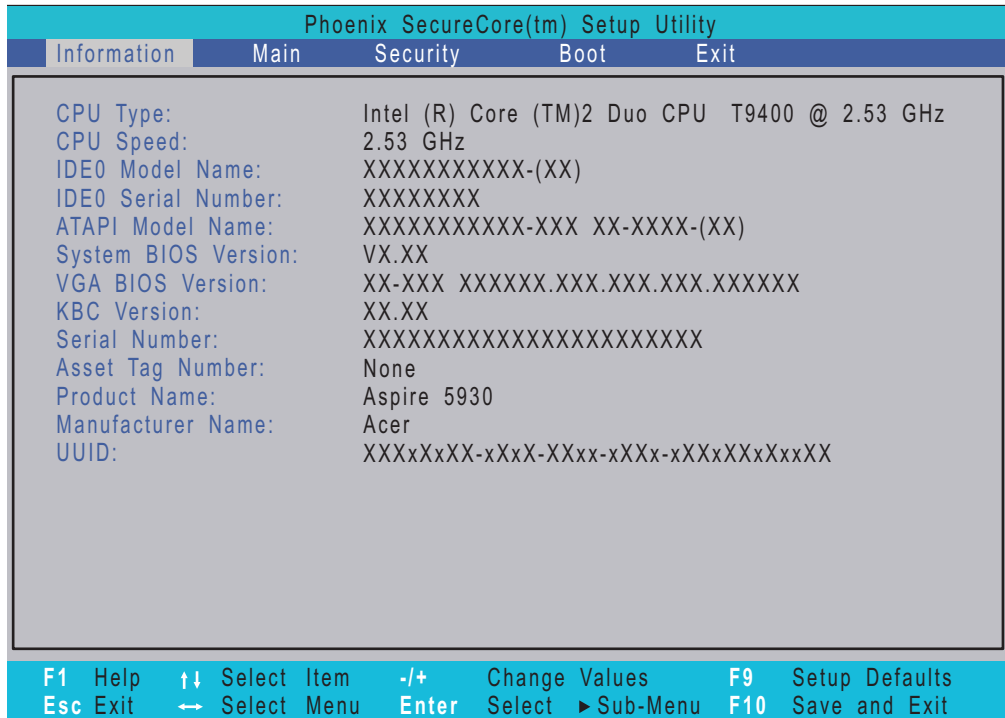

NOTE: The system information is subject to different models.

Parameter	Description
CPU Type	This field shows the CPU type and speed of the system.
CPU Speed	This field shows the speed of the CPU.
IDE0 Model Name	This field shows the model name of HDD installed on primary IDE master.
IDE0 Serial Number	This field displays the serial number of HDD installed on primary IDE master.
ATAPI Model Name	This field shows the model name of the Optical device installed in the system.
System BIOS Version	Displays system BIOS version.
VGA BIOS Version	This field displays the VGA firmware version of the system.
KBC Ver	This field shows the keyboard
Serial Number	This field displays the serial number of this unit.
Asset Tag Number	This field displays the asset tag number of the system.
Product Name	This field shows product name of the system.
Manufacturer Name	This field displays the manufacturer of this system.
UUID Number	Universally Unique Identifier (UUID) is an identifier standard used in software construction, standardized by the Open Software Foundation (OSF) as part of the Distributed Computing Environment (DCE).

Main

The Main screen allows the user to set the system time and date as well as enable and disable boot option and recovery.

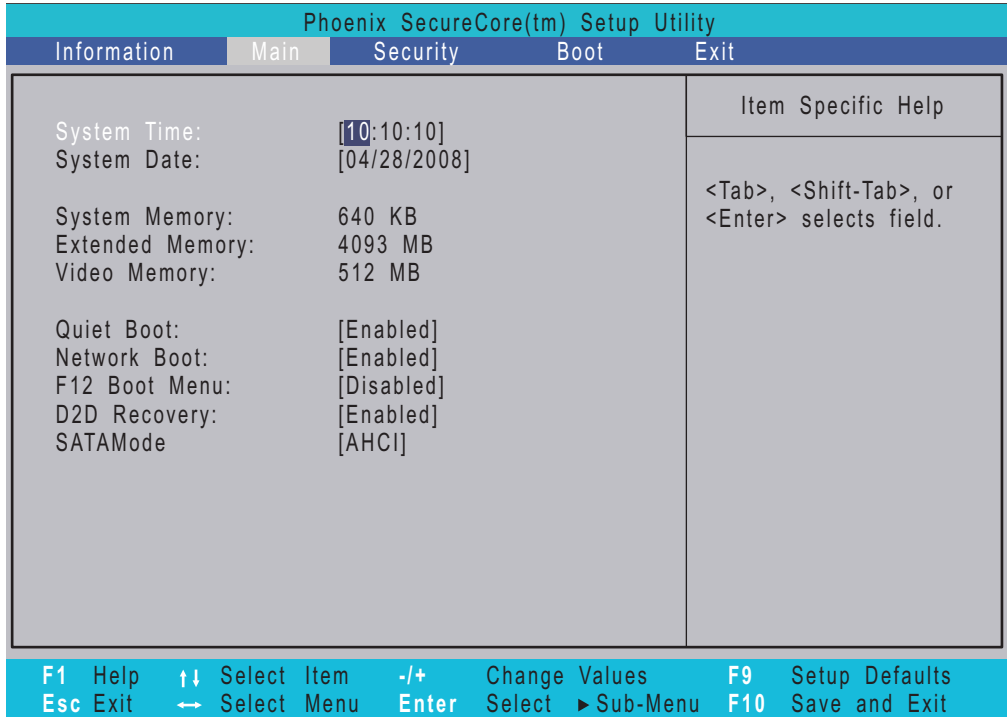

NOTE: The screen above is for your reference only. Actual values may differ.

The table below describes the parameters in this screen. Settings in **boldface** are the default and suggested parameter settings.

Parameter	Description	Format/Option
System Time	Sets the system time. The hours are displayed with 24-hour format.	Format: HH:MM:SS (hour:minute:second) System Time
System Date	Sets the system date.	Format MM/DD/YYYY (month/day/year) System Date
System Memory	This field reports the memory size of the system. Memory size is fixed to 640MB	
Extended Memory	This field reports the memory size of the extended memory in the system. Extended Memory size=Total memory size-1MB	
VGA Memory	Shows the VGA memory size.	
Quiet Boot	Determines if Customer Logo will be displayed or not; shows Summary Screen is disabled or enabled. Enabled: Customer Logo is displayed, and Summary Screen is disabled. Disabled: Customer Logo is not displayed, and Summary Screen is enabled.	Option: Enabled or Disabled
Network Boot	Enables, disables the system boot from LAN (remote server).	Option: Enabled or Disabled
F12 Boot Menu	Enables, disables Boot Menu during POST.	Option: Disabled or Enabled
D2D Recovery	Enables, disables D2D Recovery function. The function allows the user to create a hidden partition on hard disc drive to store operation system and restore the system to factory defaults.	Option: Enabled or Disabled
SATA Mode	Control the mode in which the SATA controller should operate.	Option: AHCI or IDE

NOTE: The sub-items under each device will not be shown if the device control is set to disable or auto. This is because the user is not allowed to control the settings in these cases.

Security

The Security screen contains parameters that help safeguard and protect your computer from unauthorized use.

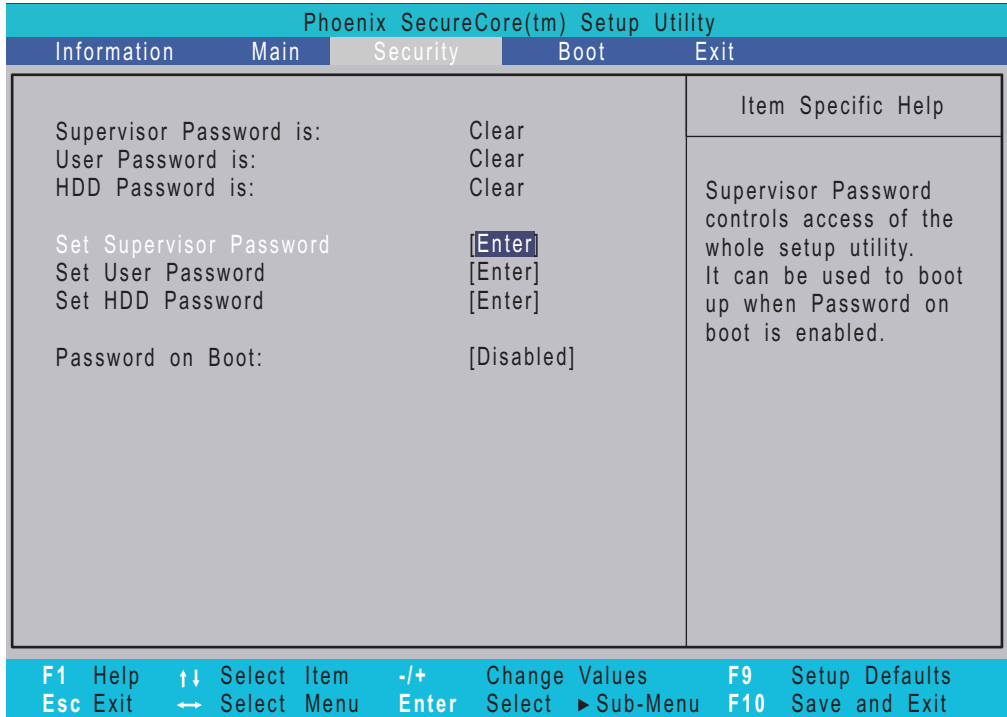

NOTE: Please refer to "Remove HDD/BIOS Password" section if you need to know how to remove HDD/BIOS Password.

The table below describes the parameters in this screen. Settings in **boldface** are the default and suggested parameter settings.

Parameter	Description	Option
Supervisor Password Is	Shows the setting of the Supervisor password	Clear or Set
User Password Is	Shows the setting of the user password.	Clear or Set
HDD Password Is	Shows the setting of the hard disk password.	Clear or Set
Set Supervisor Password	Press Enter to set the supervisor password. When set, this password protects the BIOS Setup Utility from unauthorized access. The user can not either enter the Setup menu nor change the value of parameters.	
Set User Password	Press Enter to set the user password. When user password is set, this password protects the BIOS Setup Utility from unauthorized access. The user can enter Setup menu only and does not have right to change the value of parameters.	
Set HDD Password	Enter HDD Password.	
Password on Boot	Defines whether a password is required or not while the events defined in this group happened. The following sub-options are all requires the Supervisor password for changes and should be grayed out if the user password was used to enter setup.	Disabled or Enabled

NOTE: When you are prompted to enter a password, you have three tries before the system halts. Don't forget your password. If you forget your password, you may have to return your notebook computer to your dealer to reset it.

Setting a Password

Follow these steps as you set the user or the supervisor password:

1. Use the "w" and "y" keys to highlight the Set Supervisor Password parameter and press the e key. The Set Supervisor Password box appears:

Set Supervisor Password

Enter New Password []

Confirm New Password []

2. Type a password in the "Enter New Password" field. The password length can not exceeds 8 alphanumeric characters (A-Z, a-z, 0-9, not case sensitive). Retype the password in the "Confirm New Password" field.

IMPORTANT: Be very careful when typing your password because the characters do not appear on the screen.

3. Press e.
After setting the password, the computer sets the User Password parameter to "Set".
4. If desired, you can opt to enable the Password on boot parameter.
5. When you are done, press u to save the changes and exit the BIOS Setup Utility.

Removing a Password

Follow these steps:

1. Use the `w` and `y` keys to highlight the Set Supervisor Password parameter and press the `e` key. The Set Password box appears:

Set Supervisor Password		
Enter current password	[]
Enter New Password	[]
Confirm New Password	[]

2. Type the current password in the Enter Current Password field and press `e`.
3. Press `e` twice **without** typing anything in the Enter New Password and Confirm New Password fields. The computer then sets the Supervisor Password parameter to "Clear".
4. When you have changed the settings, press `u` to save the changes and exit the BIOS Setup Utility.

Changing a Password

1. Use the `w` and `y` keys to highlight the Set Supervisor Password parameter and press the `e` key. The Set Password box appears:

Set Supervisor Password		
Enter current password	[]
Enter New Password	[]
Confirm New Password	[]

2. Type the current password in the Enter Current Password field and press `e`.
3. Type a password in the Enter New Password field. Retype the password in the Confirm New Password field.
4. Press `e`. After setting the password, the computer sets the User Password parameter to "Set".
5. If desired, you can enable the Password on boot parameter.
6. When you are done, press `u` to save the changes and exit the BIOS Setup Utility.

If the verification is OK, the screen will display as following.

Setup Notice
Changes have been saved.
[continue]

The password setting is complete after the user presses `u`.

If the current password entered does not match the actual current password, the screen will show you the Setup Warning.

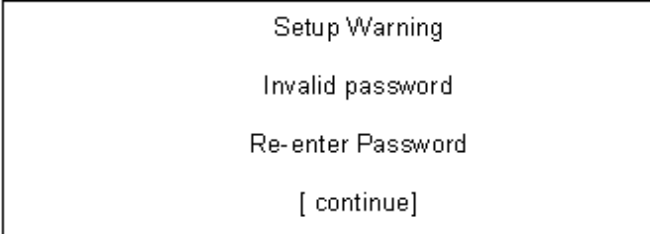

Setup Warning
Invalid password
Re-enter Password
[continue]

If the new password and confirm new password strings do not match, the screen will display the following message.

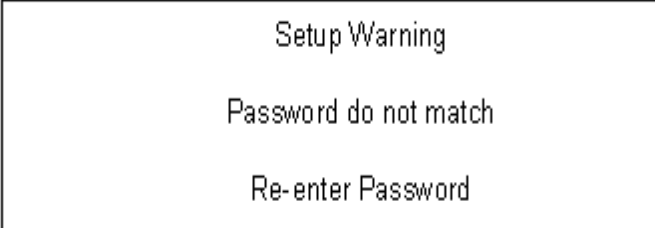

Setup Warning
Password do not match
Re-enter Password

Boot

This menu allows the user to decide the order of boot devices to load the operating system. Bootable devices includes the diskette drive in module bay, the onboard hard disk drive and the CD-ROM in module bay.

Phoenix SecureCore(tm) Setup Utility				
Information	Main	Security	Boot	Exit
Boot priority order: 1: IDE HDD: XXXXXXXXXXXX-(XX) 2: IDE CD: XXXXXXXXXXXX-XXX XX-XXXX-XX 3: PCI LAN: Network Boot 4: USB HDD: 5: USB FDD: 6: USB Key: 7: USB CDROM:				Item Specific Help Use <↑> or <↓> to select a device, then press <F6> to move it up the list, or <F5> to move it down the list. Press <Esc> to escape the menu.
F1 Help	↑↓ Select Item	-/+ Change Values	F9 Setup Defaults	
Esc Exit	←→ Select Menu	Enter Select	▶ Sub-Menu	F10 Save and Exit

Exit

The Exit screen contains parameters that confirmed or discard the changes made to the parameters in the BIOS Setup Utility.

Phoenix SecureCore(tm) Setup Utility					
Information	Main	Security	Boot	Exit	
Exit Saving Changes Exit Discarding Changes Load Setup Defaults Discard Changes Save Changes				Item Specific Help Exit System Setup and save your changes to CMOS.	
F1	Help	↑↓	Select Item	-/+	Change Values
Esc	Exit	←→	Select Menu	Enter	Select ► Sub-Menu
F9	Setup Defaults				
F10	Save and Exit				

The table below describes the parameters in this screen.

Parameter	Description
Exit Saving Changes	Exit System Setup and save your changes to CMOS.
Exit Discarding Changes	Exit utility without saving setup data to CMOS.
Load Setup Default	Load default values for all SETUP item.
Discard Changes	Load previous values from CMOS for all SETUP items.
Save Changes	Save Setup Data to CMOS.

BIOS Flash Utility

The BIOS flash memory update is required for the following conditions:

- q New versions of system programs
- q New features or options
- q Restore a BIOS when it becomes corrupted.

Use the Flash utility to update the system BIOS flash ROM.

NOTE: If you do not have a crisis recovery diskette at hand, then you should create a **Crisis Recovery Diskette** before you use the Flash utility.

NOTE: Do not install memory-related drivers (XMS, EMS, DPMI) when you use the Flash.

NOTE: Please use the AC adaptor power supply when you run the Flash utility. If the battery pack does not contain enough power to finish BIOS flash, you may not boot the system because the BIOS is not completely loaded.

Follow the steps below to run the Flash.

1. Prepare a bootable diskette.
2. Copy the flash utilities to the bootable diskette.
3. Then boot the system from the bootable diskette. The flash utility has auto-execution function.

Remove HDD/BIOS Utility

This section provide you with removing HDD/BIOS method:

Remove HDD Password:

- q If you key in wrong HDD password for three time, "HDD password error code" would display on the screen. See the image below.

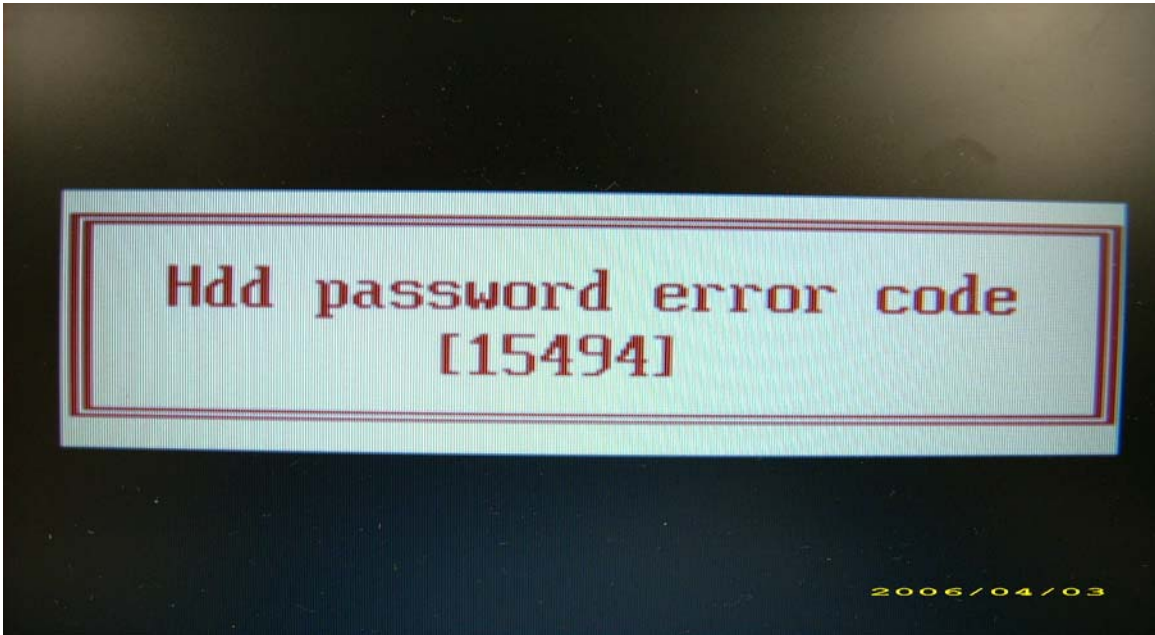

- q If you need to solve HDD password locked problem, you can run HDD_PW.EXE
 1. Key in "hdd_pw 15494 0"
 2. Select "2"
 3. Choose one upper-case string

```
C:\WINDOWS\system32\cmd.exe
F:\>cd password
F:\password>dir/w
Volume in drive F has no label.
Volume Serial Number is D4F6-0236

Directory of F:\password

[.]          [..]      BIOS_PW.EXE  HDD_PW.EXE
 1.          2 File(s)    35,354 bytes
            2 Dir(s)    487,895,040 bytes free

F:\password>hdd_pw 15494 0
unlock6.exe v1.1 2 May 2003

Choice what kind of the password to be generated:
0.) Exit....
1.) Scan Code
2.) Upper case ASCII Code
3.) Lower case ASCII Code
Enter your choice: 2
0KJFN42
UVEIQ96
F:\password>
```

- q Reboot system and key in "0KJFN42" or "UVEIQ96" to HDD user password.

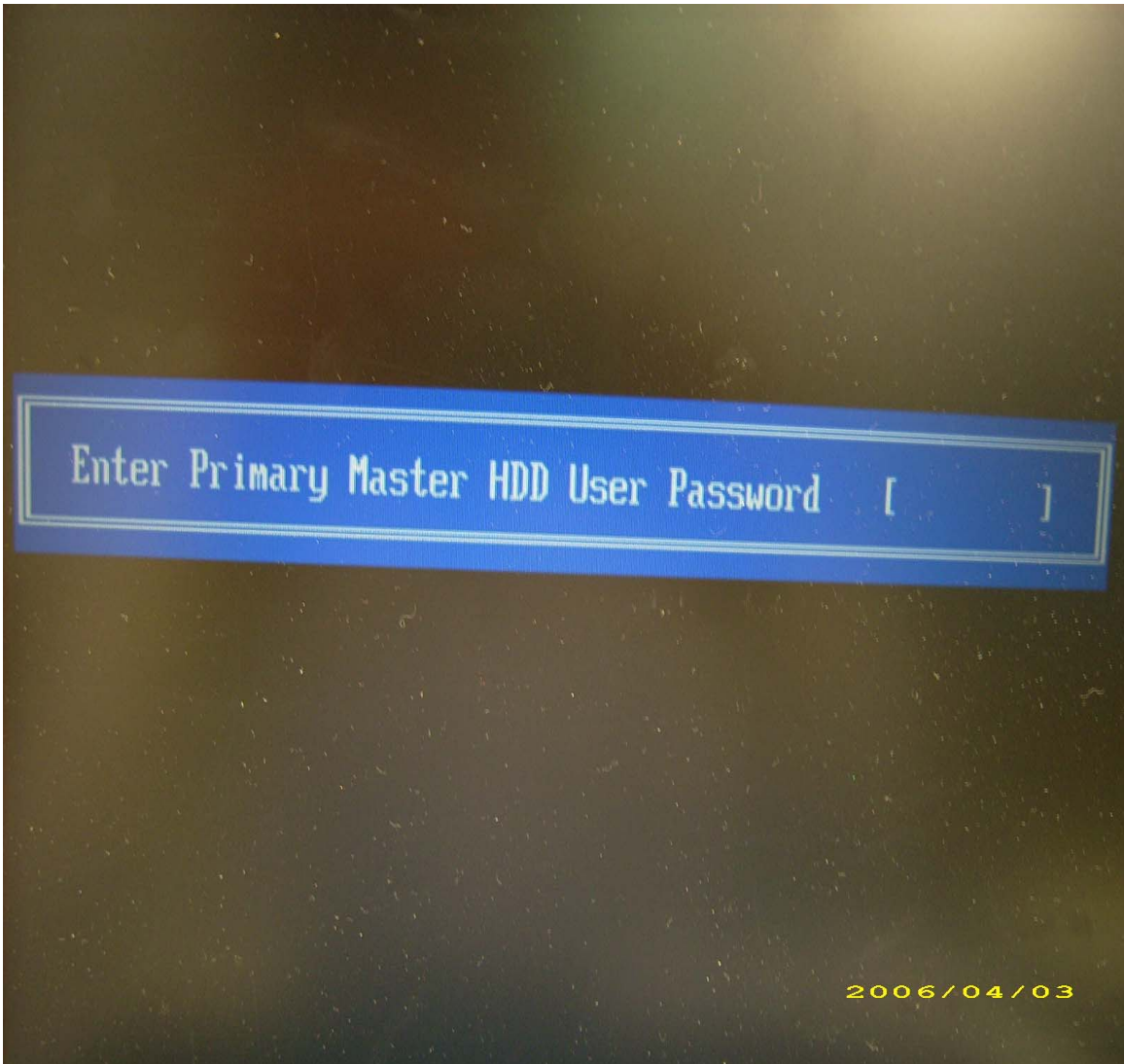

Remove BIOS Password:

- q If you key in wrong Supervisor Password for three time, "System Disabled" would display on the screen. See the image below.

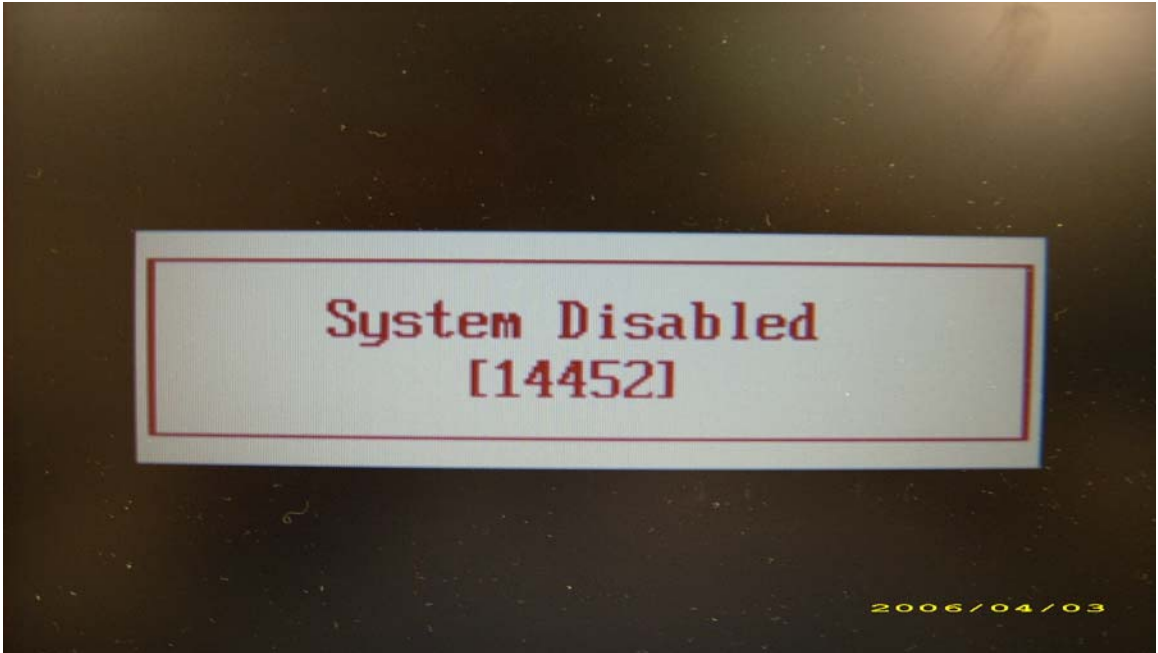

- q If you need to solve BIOS password locked problem, you can run BIOS_PW.EXE
 1. Key in "bios_pw 14452 0"
 2. Choose one upper-case string

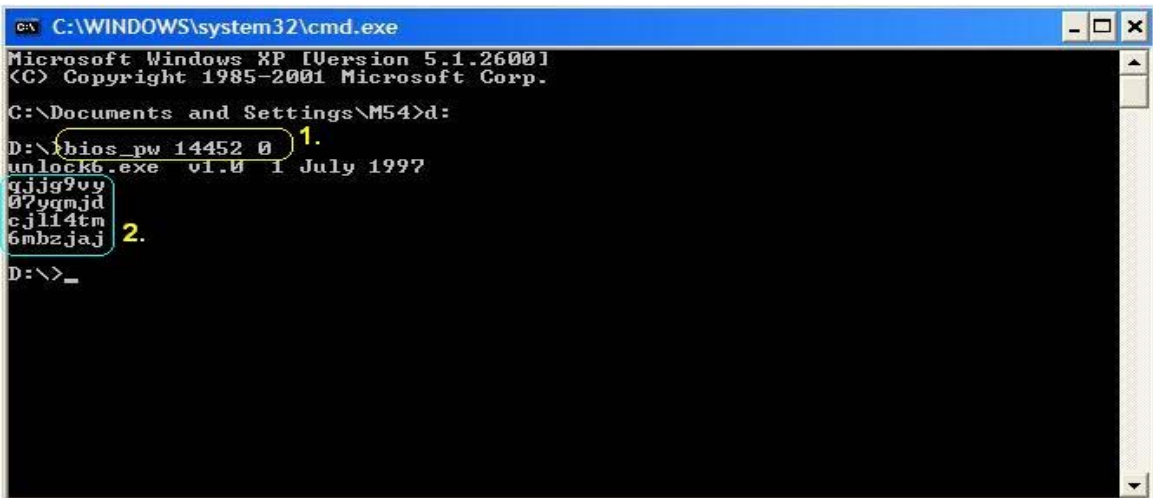

- q Reboot the system and key in "qjjg9vy" or "07yqmjd" to BIOS user password.

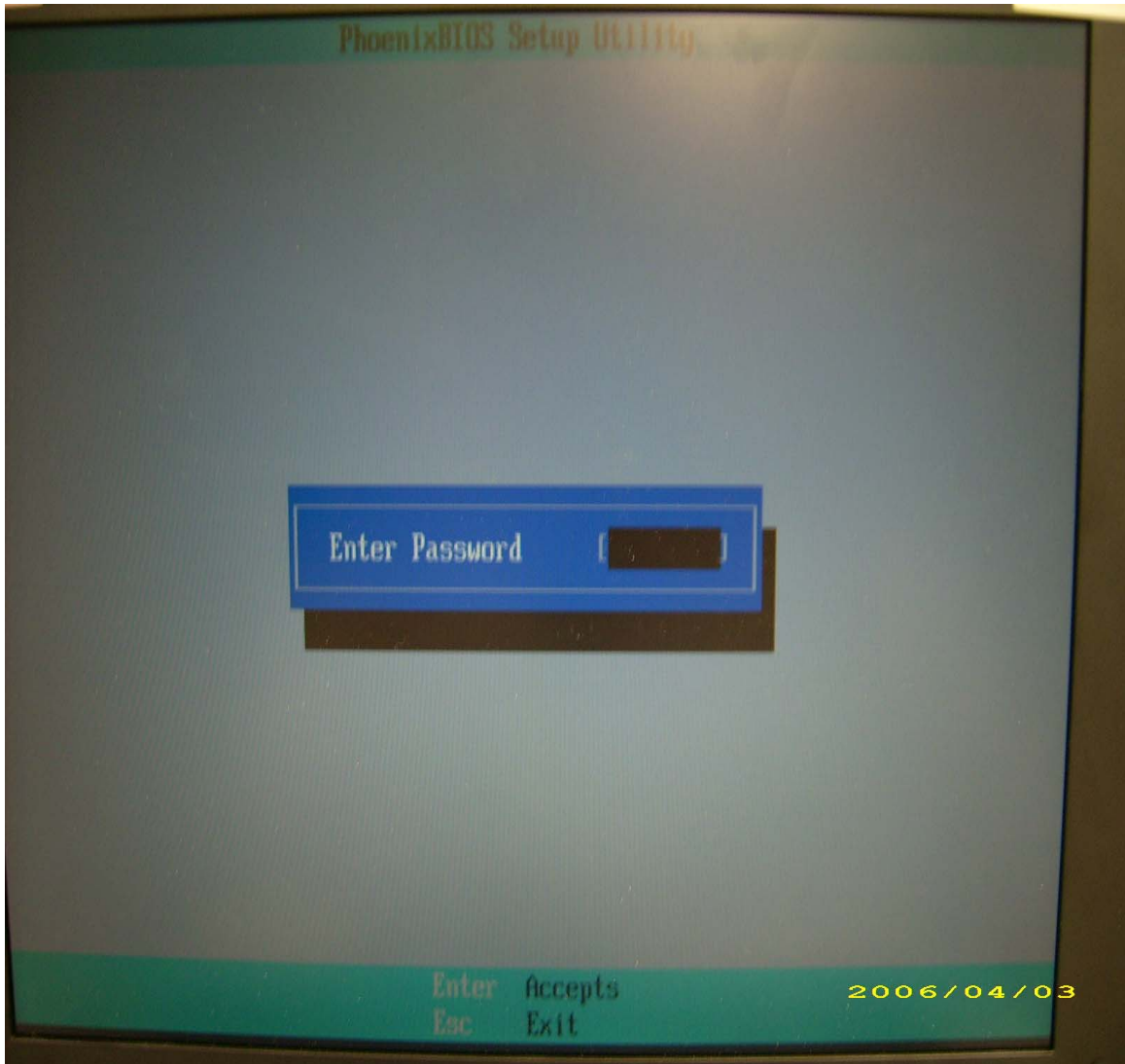

Machine Disassembly and Replacement

This chapter contains step-by-step procedures on how to disassemble the notebook computer for maintenance and troubleshooting.

Disassembly Requirements

To disassemble the computer, you need the following tools:

- Wrist grounding strap and conductive mat for preventing electrostatic discharge
- Flat screwdriver
- Philips screwdriver
- Hex screwdriver
- Plastic flat screwdriver
- Plastic tweezers

NOTE: The screws for the different components vary in size. During the disassembly process, group the screws with the corresponding components to avoid mismatch when putting back the components.

General Information

Pre-disassembly Instructions

Before proceeding with the disassembly procedure, make sure that you do the following:

1. Turn off the power to the system and all peripherals.
2. Unplug the AC adapter and all power and signal cables from the system.



3. Place the system on a flat, stable surface.
4. Remove the battery pack.

Disassembly Process

The disassembly process is divided into the following stages:

- External module disassembly
- Main unit disassembly
- LCD module disassembly

The flowcharts provided in the succeeding disassembly sections illustrate the entire disassembly sequence. Observe the order of the sequence to avoid damage to any of the hardware components. For example, if you want to remove the main board, you must first remove the keyboard, then disassemble the inside assembly frame in that order.

Main Screw List

Item	Screw	Color	Part No.
A	M2 x L3	Black	86.9A552.3R0
B	M2 x L4	Silver	86.9A552.4R0
C	M2.5 x L5	Black	86.00E33.736
D	M2 x L8	Black	86.00E34.738
E	M3 x L4	Silver	86.9A554.4R0
F	M2 x L3	Silver	86.00E13.524
G	M2.5 x L5	Black	86.00F87.735
H	M2 x L3	Silver	86.00C07.220

External Module Disassembly Process

External Modules Disassembly Flowchart

The flowchart below gives you a graphic representation on the entire disassembly sequence and instructs you on the components that need to be removed during servicing. For example, if you want to remove the main board, you must first remove the keyboard, then disassemble the inside assembly frame in that order.

EXTERNAL MODULE DISASSEMBLY

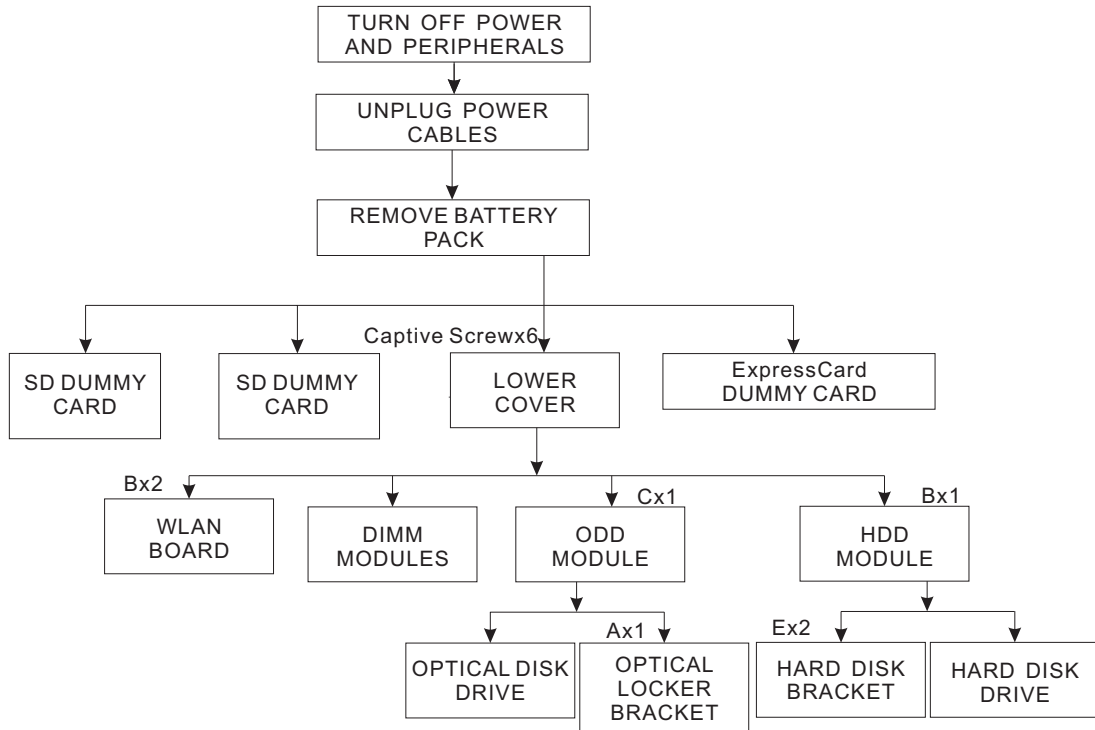

Screw List

Item	Screw	Color	Part No.
A	M2 x L3	Silver	86.9A552.3R0
B	M2 x L4	Silver	86.9A552.4R0
C	M2.5 x L5	Black	86.00E33.736
E	M3 x L4	Silver	86.9A554.4R0

Removing the Battery Pack

1. Turn base unit over.
2. Slide the battery lock/unlock latch to the unlock position.



3. Slide and hold the battery release latch to the release position.



4. Then remove the battery from the main unit.



Removing the SD dummy card

1. Push the SD dummy card all the way in to eject it.



2. Pull it out from the slot.



Removing the PC and ExpressCard dummy cards

1. Press the eject button to pop out the button.



2. Press it again to pop out the PC dummy card.



3. Remove the PC dummy card from the slot.



4. Push the ExpressCard dummy card all the way in to eject it.



5. Pull it out from the slot.



Removing the Lower Cover

1. See “Removing the Battery Pack” on page 54.
2. Remove the six captive screws securing the lower cover.



3. Use a plastic screw driver to carefully pry open the lower cover.



4. Remove the lower cover from the lower case.



Removing the DIMM

1. See “Removing the Battery Pack” on page 54.
2. See “Removing the Lower Cover” on page 57..
3. Push out the latches on both sides of the DIMM socket to release the DIMM.

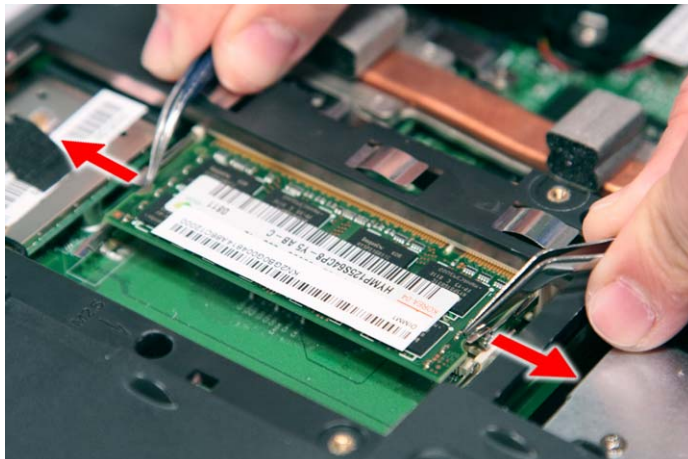

4. Remove the DIMM module.

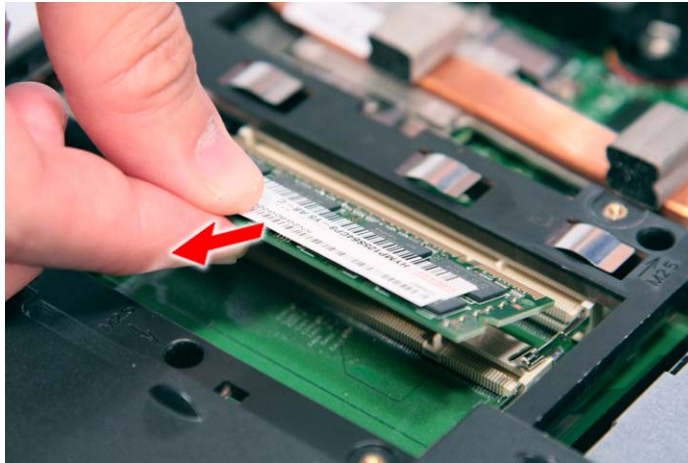

Removing the WLAN Board Modules

1. See “Removing the Battery Pack” on page 54.
2. See “Removing the Lower Cover” on page 57.
3. Disconnect the antenna cables from the WLAN board.



NOTE: There are 2 antenna cables connected to the WLAN board. The Black antenna cable is connected to MAIN connector and the White antenna cable is connected to AUX connector.

4. Remove the Gray antenna that is taped to the WLAN board and move the antenna cables away from the WLAN board.



5. Remove the two screws (B) on the WLAN board to release the WLAN board.



Step	Size (Quantity)	Color	Torque
1~2	M2 x L4 (2)	Silver	1.6 kgf-cm

6. Detach the WLAN board from the WLAN socket.

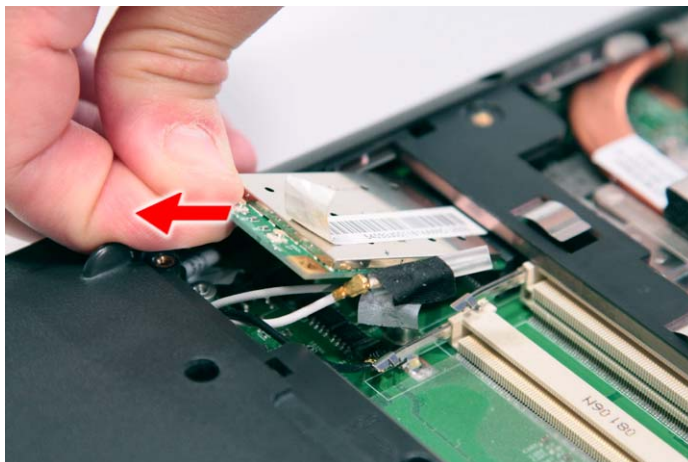

NOTE: When attaching the antenna back to the WLAN board, make sure the cable are arranged properly.

Removing the Hard Disk Drive Module

1. See “Removing the Battery Pack” on page 54.
2. See “Removing the Lower Cover” on page 57.
3. Remove the one screw (B) securing the hard disk drive module.

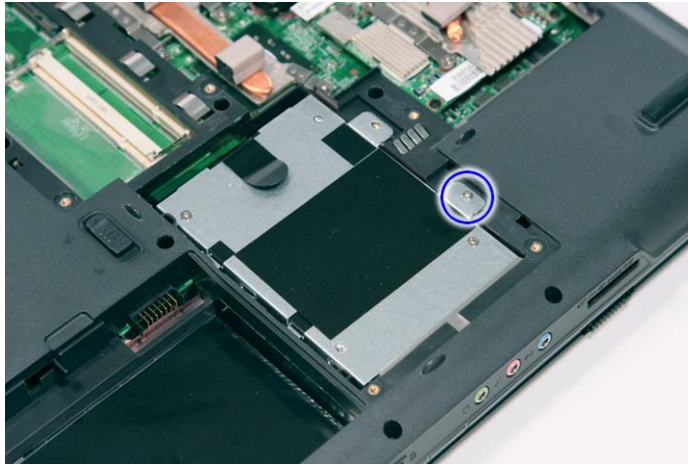

Step	Size (Quantity)	Color	Torque
1	M2 x L4 (1)	Silver	1.6 kgf-cm

4. Using the plastic tab, slide the hard disk drive module away from the connector; lift up the hard disk module to remove from the bay.

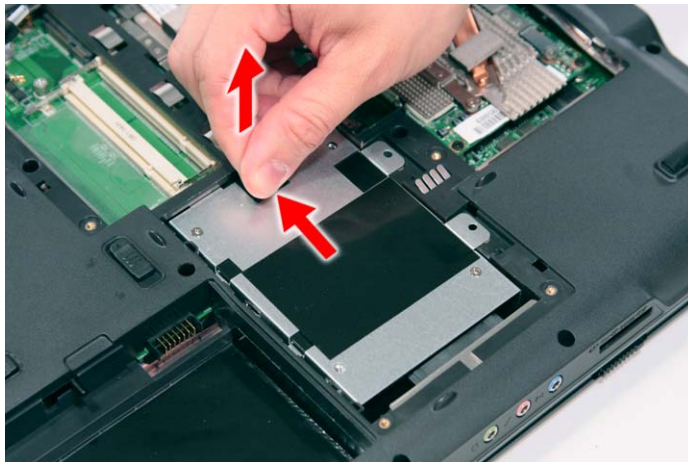

NOTE: To prevent damage to device, avoid pressing down on it or placing heavy objects on top of it.

5. Remove the two screws (E) securing the hard disk to the bracket and remove the hard disk from the bracket.

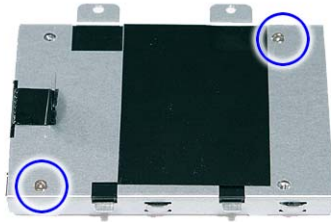

Step	Size (Quantity)	Color	Torque
1~2	M3 x L4 (2)	Silver	3.0 kgf-cm

Removing the Optical Drive Module

1. See "Removing the Battery Pack" on page 54.
2. See "Removing the Lower Cover" on page 57.

3. Remove the one screw (C) from the bottom panel.



Step	Size (Quantity)	Color	Torque
1	M2.5 x L6 (1)	Black	3.0 kgf-cm

4. Use a screw driver to carefully push the odd drive tray out as shown.



5. Slowly pull out the odd module from the odd drive bay.

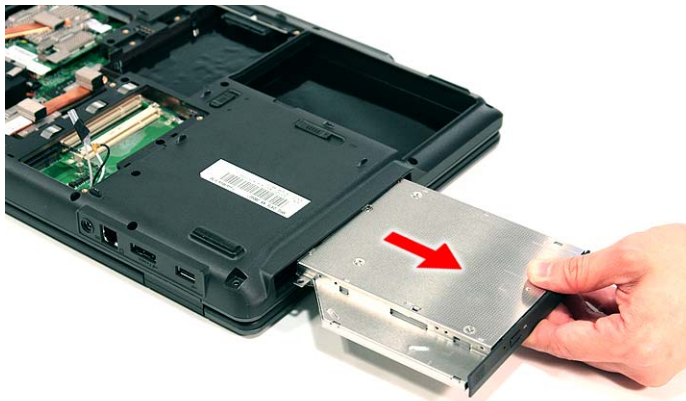

6. Remove the one screw (A) securing the locker bracket and remove the locker bracket from the optical disk drive module.



Step	Size (Quantity)	Color	Torque
1	M2 x L3 (1)	Silver	1.6 kgf-cm

Main Unit Disassembly Process

Main Unit Disassembly Flowchart

MAIN UNIT DISASSEMBLY

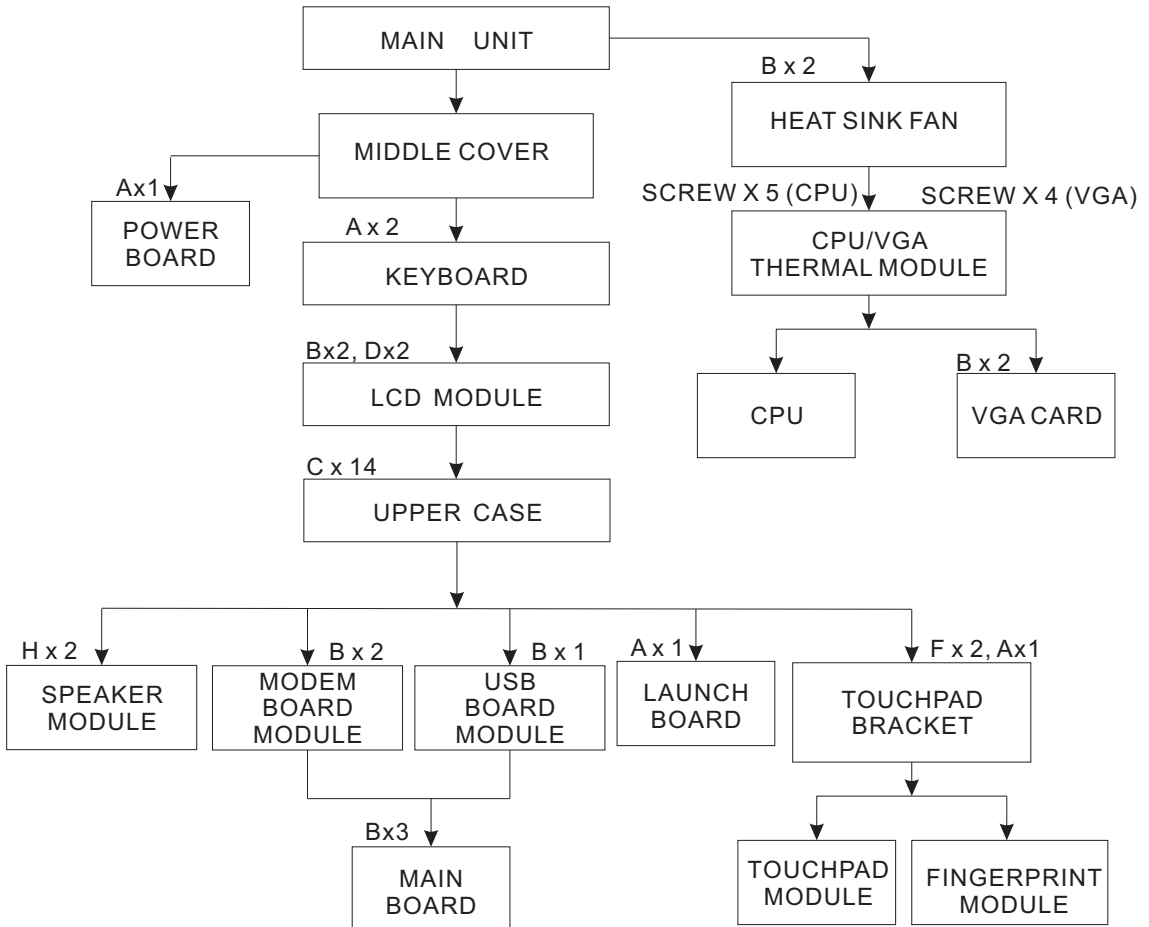

Screw List

Item	Screw	Color	Part No.
A	M2 x L3	Silver	86.9A552.3R0
B	M2 x L4	Silver	86.9A552.4R0
C	M2.5 x L5	Black	86.00E33.736
D	M2 x L8	Black	86.00E34.738
F	M2 x L3	Silver	86.00E13.524
H	M2 x L3	Silver	86.00C07.220

Removing the Middle Cover

1. See “Removing the Battery Pack” on page 54.
2. Use a plastic screw driver to pry loose the side of the middle cover.



3. Carefully pry loose the middle cover from the latches securing it and turn it over on the keyboard to gain access to the cable connected to the power board.



4. Disconnect the cable connected to the power board and remove the middle cover from the system.



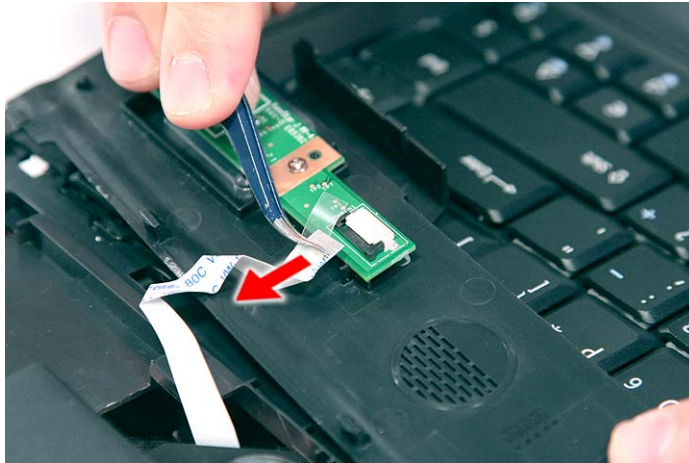

Removing the Power Board

1. See “Removing the Battery Pack” on page 54.
2. See “Removing the Middle Cover” on page 66.

3. Remove the one screw (A) securing the power board to the middle cover.



Step	Size (Quantity)	Color	Torque
1	M2 x L3 (1)	Silver	1.6 kgf-cm

4. Release the power board from the latches and remove it from the middle cover.

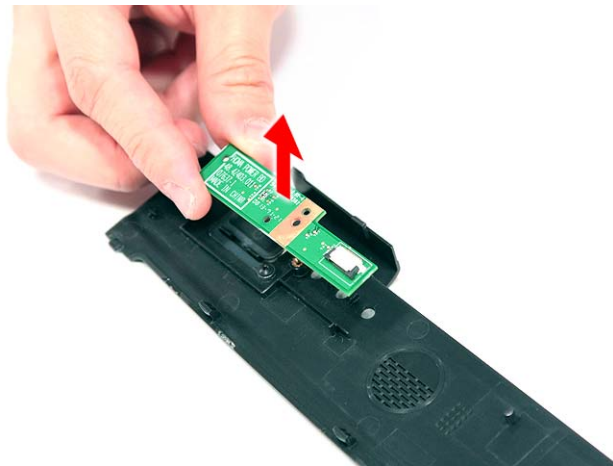

Removing the Keyboard

1. See “Removing the Battery Pack” on page 54.
2. See “Removing the Middle Cover” on page 66.
3. Remove the two screws (A) securing the keyboard.

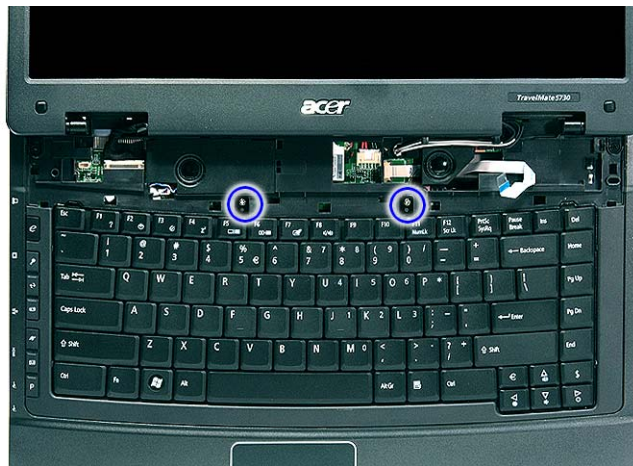

Step	Size (Quantity)	Color	Torque
1~2	M2 x L3 (2)	Silver	1.6 kgf-cm

4. Carefully pry loose the keyboard and turn it over on the touchpad area.



5. Disconnect the keyboard cable from the main board to remove the keyboard.

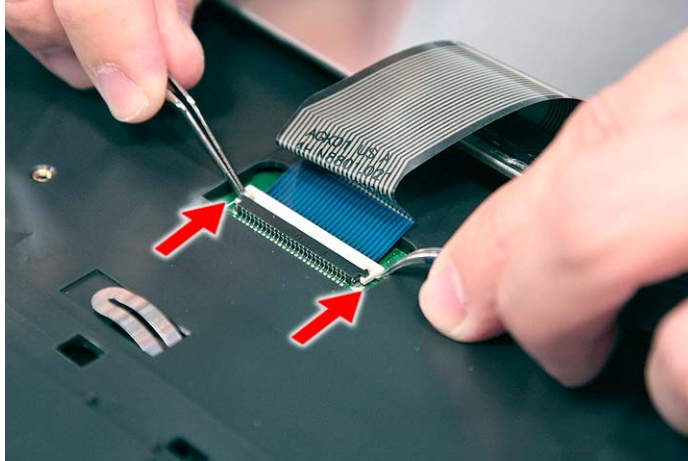

Removing the Heatsink Fan Module

1. See “Removing the Battery Pack” on page 54.
2. See “Removing the Lower Cover” on page 57.
3. Disconnect the heat sink fan connector from the main board.



4. Remove the two screws (B) securing the heatsink fan module in place.

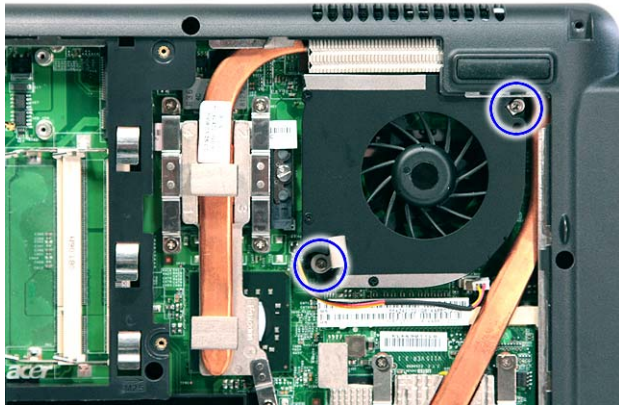

Step	Size (Quantity)	Color	Torque
1~2	M2 x L4 (2)	Silver	1.6 kgf-cm

5. Carefully lift up the heatsink fan module.

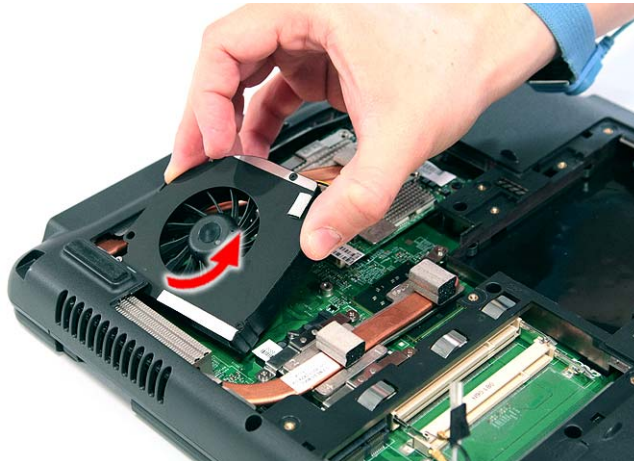

Removing the CPU and VGA Heatsink Module

1. See “Removing the Battery Pack” on page 54.
2. See “Removing the Lower Cover” on page 57.
3. See “Removing the Heatsink Fan Module” on page 70.

4. Remove the four screws securing the VGA board heatsink module (Discrete Model only) and the five screws securing the CPU heatsink module.

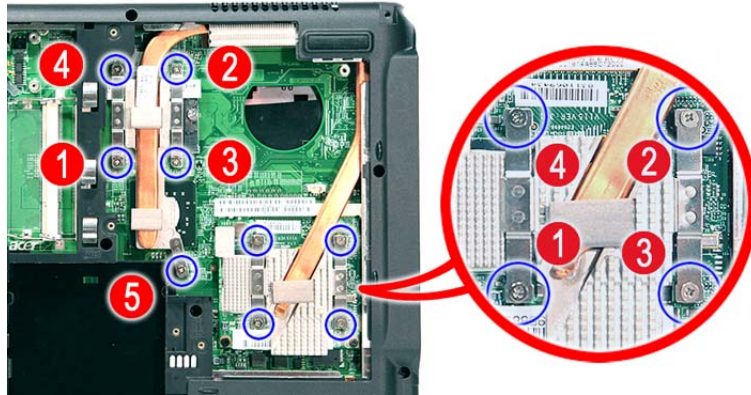

5. Carefully remove the heatsink module from the system.

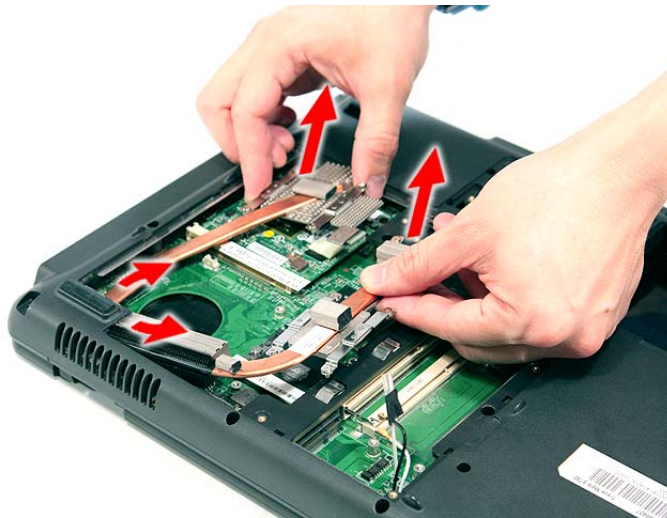

Removing the CPU

1. See “Removing the Battery Pack” on page 54.
2. See “Removing the Lower Cover” on page 57.
3. See “Removing the Heatsink Fan Module” on page 70.
4. See “Removing the CPU and VGA Heatsink Module” on page 71.

- Using a flat screwdriver, turn the CPU socket latch counter-clockwise to release the CPU.



- Lift up carefully to remove the CPU.

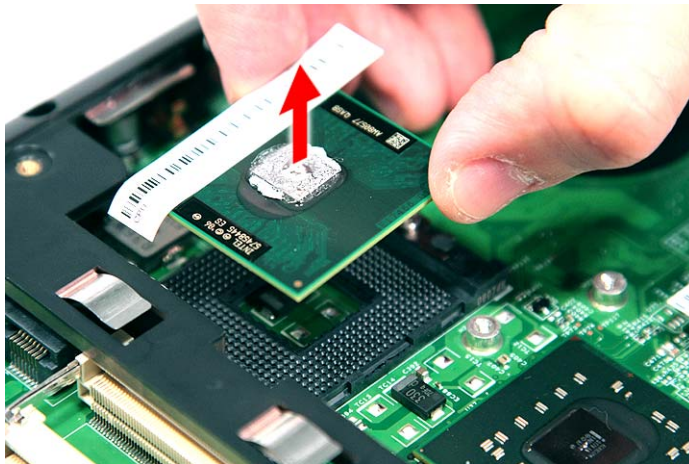

NOTE: When installing the CPU, make sure to install the CPU with PIN 1 at the corner as shown.



Removing the VGA Board (Discrete Model only)

- See "Removing the Battery Pack" on page 54.
- See "Removing the Lower Cover" on page 57.

3. See “Removing the Heatsink Fan Module” on page 70.
4. See “Removing the CPU and VGA Heatsink Module” on page 71.
5. Remove the two screws (B) securing the VGA board to the main board.



Step	Size (Quantity)	Color	Torque
1~2	M2 x L4 (2)	Silver	1.6 kgf-cm

6. Remove the VGA board from the main board.



Removing the LCD Module

1. See “Removing the Battery Pack” on page 54.
2. See “Removing the SD dummy card” on page 55.
3. See “Removing the PC and ExpressCard dummy cards” on page 56.
4. See “Removing the Lower Cover” on page 57.
5. See “Removing the WLAN Board Modules” on page 59.
6. See “Removing the Middle Cover” on page 66.
7. See “Removing the Keyboard” on page 69.

8. Turn over the system and remove the two screws (B) from the bottom of the left and right hinges.



Step	Size (Quantity)	Color	Torque
1~2	M2.5 x L6 (2)	Black	3.0 kgf-cm

9. Carefully pull out the wireless antenna cables from the hole and release the cables from the latches.



10. Disconnect the LCD cable connector from the main board.



11. Remove the two screws (D) from the left and right hinge of the LCD module.

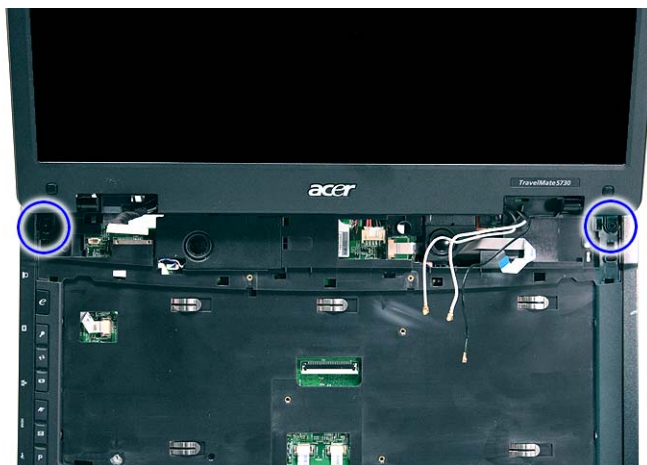

Step	Size (Quantity)	Color	Torque
1~2	M2 x L8 (2)	Black	4.0 kgf-cm

12. Carefully remove the LCD module from the base unit.



NOTE: When connecting the cable back to the unit, please note that the cable should be routed well.

Separating the Upper Case from the Lower Case

1. See “Removing the Battery Pack” on page 54.
2. See “Removing the SD dummy card” on page 55.
3. See “Removing the PC and ExpressCard dummy cards” on page 56.
4. See “Removing the Lower Cover” on page 57.
5. See “Removing the DIMM” on page 58.
6. See “Removing the WLAN Board Modules” on page 59.
7. See “Removing the Hard Disk Drive Module” on page 61.
8. See “Removing the Optical Drive Module” on page 62.
9. See “Removing the Middle Cover” on page 66.
10. See “Removing the Keyboard” on page 69.
11. See “Removing the Heatsink Fan Module” on page 70.
12. See “Removing the CPU and VGA Heatsink Module” on page 71.

13. See “Removing the CPU” on page 72.
14. See “Removing the VGA Board (Discrete Model only)” on page 73.
15. See “Removing the LCD Module” on page 74.
16. Disconnect the touchpad cable from the TPAD1 connector on the main board.

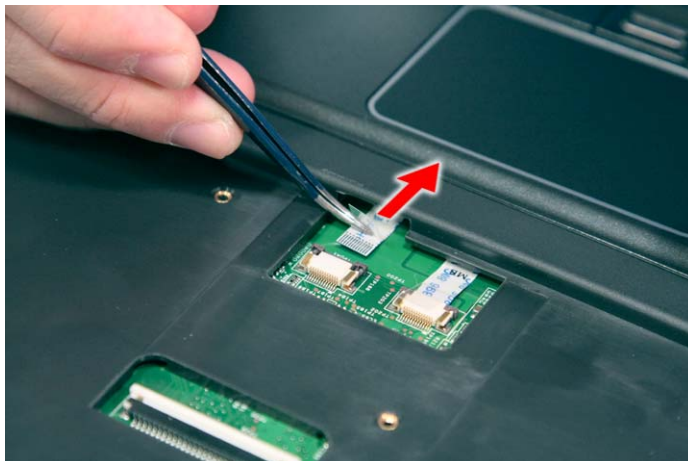
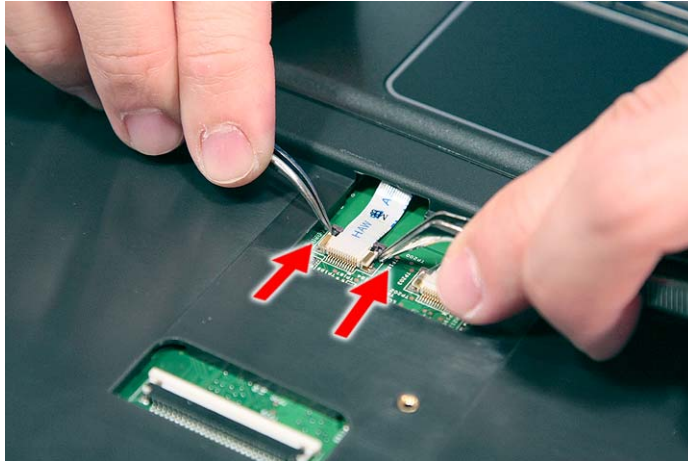

17. Disconnect the fingerprint cable from the FPCN1 connector on the main board.

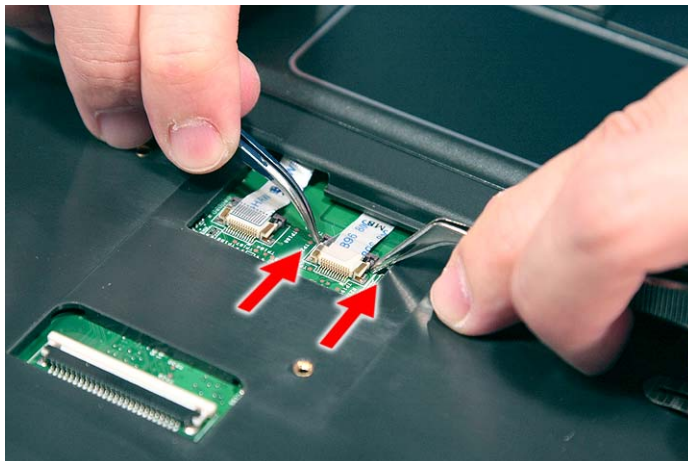

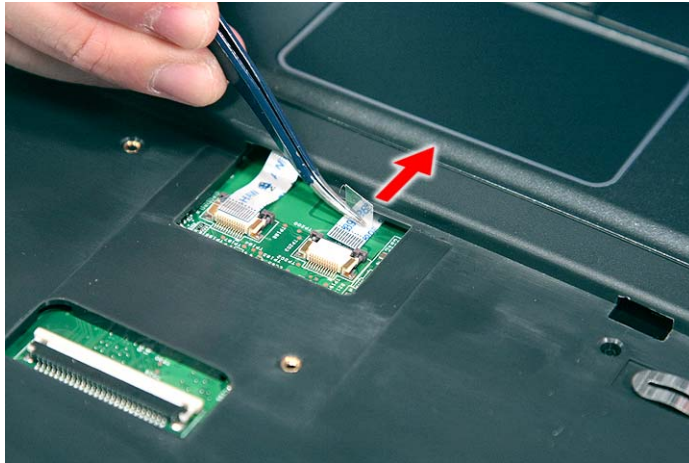

18. Disconnect the launch board cable from the SWITCHCN1 connector on the main board.

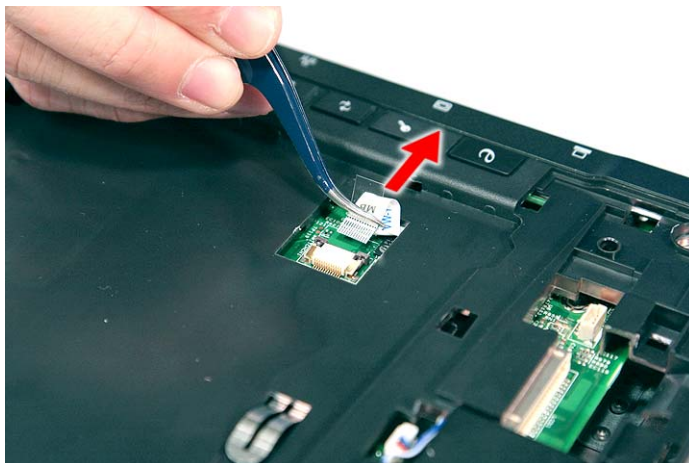

19. Disconnect the speaker cable from the INTSPK1 connector on the main board.

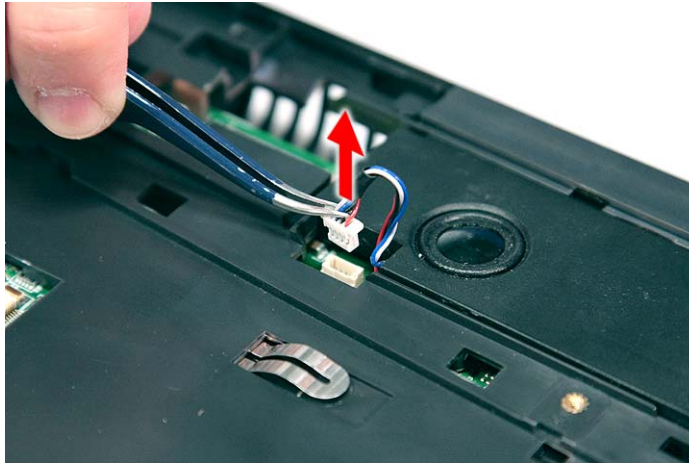

20. Remove the fourteen screws (14 x C) from the bottom panel.

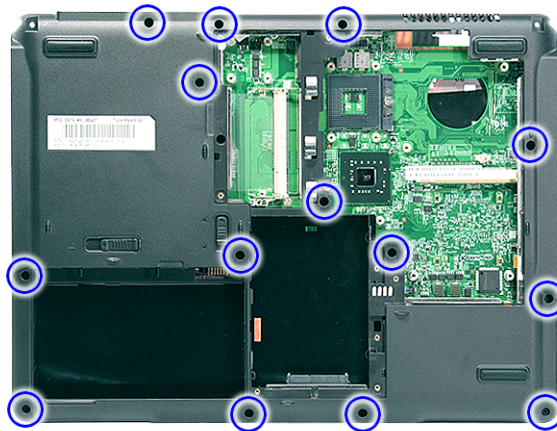

Step	Size (Quantity)	Color	Torque
1~14	M2.5 x L5 (14)	Black	2.5 kgf-cm

21. Turn the unit over and gently remove the upper case from the lower case.

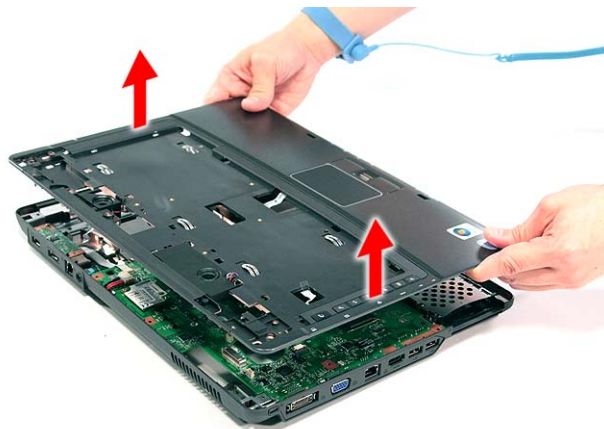

Removing the Speaker Module

1. See “Removing the Battery Pack” on page 54.
2. See “Removing the SD dummy card” on page 55.
3. See “Removing the PC and ExpressCard dummy cards” on page 56.
4. See “Removing the Lower Cover” on page 57.
5. See “Removing the DIMM” on page 58.
6. See “Removing the WLAN Board Modules” on page 59.
7. See “Removing the Hard Disk Drive Module” on page 61.
8. See “Removing the Optical Drive Module” on page 62.
9. See “Removing the Middle Cover” on page 66.
10. See “Removing the Keyboard” on page 69.
11. See “Removing the Heatsink Fan Module” on page 70.
12. See “Removing the CPU and VGA Heatsink Module” on page 71.
13. See “Removing the CPU” on page 72.
14. See “Removing the VGA Board (Discrete Model only)” on page 73.
15. See “Removing the LCD Module” on page 74.
16. See “Separating the Upper Case from the Lower Case” on page 76.
17. Remove the two screws (2 x H) securing the left and right speaker modules.

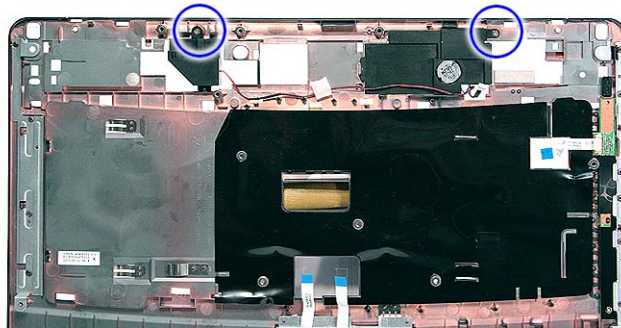

Step	Size (Quantity)	Color	Torque
1~2	M2 x L3 (2)	Silver	1.6 kgf-cm

-
18. Remove the left and right speaker modules from the upper case.

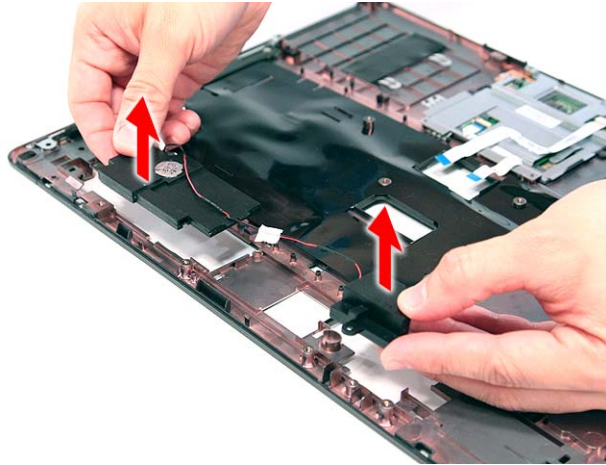

Removing the Launch Board

1. See "Removing the Battery Pack" on page 54.
2. See "Removing the SD dummy card" on page 55.
3. See "Removing the PC and ExpressCard dummy cards" on page 56.
4. See "Removing the Lower Cover" on page 57.
5. See "Removing the DIMM" on page 58.
6. See "Removing the WLAN Board Modules" on page 59.
7. See "Removing the Hard Disk Drive Module" on page 61.
8. See "Removing the Optical Drive Module" on page 62.
9. See "Removing the Middle Cover" on page 66.
10. See "Removing the Keyboard" on page 69.
11. See "Removing the Heatsink Fan Module" on page 70.
12. See "Removing the CPU and VGA Heatsink Module" on page 71.
13. See "Removing the CPU" on page 72.
14. See "Removing the VGA Board (Discrete Model only)" on page 73.
15. See "Removing the LCD Module" on page 74.
16. See "Separating the Upper Case from the Lower Case" on page 76.

17. Remove the one screw (1 x A) securing the launch board module.



Step	Size (Quantity)	Color	Torque
1	M2 x L3 (1)	Silver	1.6 kgf-cm

18. Remove the launch board module from the upper case.

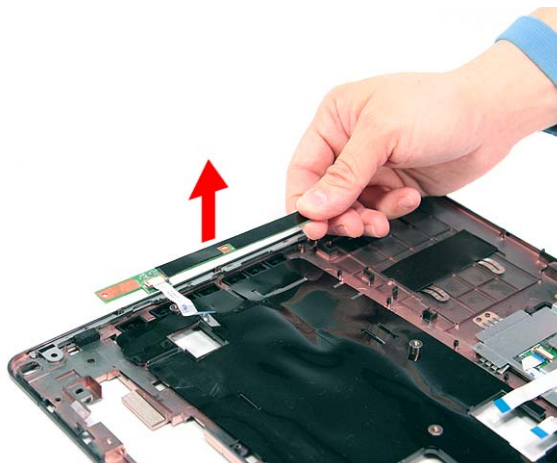

Removing the Fingerprint and Touchpad Module

1. See “Removing the Battery Pack” on page 54.
2. See “Removing the SD dummy card” on page 55.
3. See “Removing the PC and ExpressCard dummy cards” on page 56.
4. See “Removing the Lower Cover” on page 57.
5. See “Removing the DIMM” on page 58.
6. See “Removing the WLAN Board Modules” on page 59.
7. See “Removing the Hard Disk Drive Module” on page 61.
8. See “Removing the Optical Drive Module” on page 62.
9. See “Removing the Middle Cover” on page 66.
10. See “Removing the Keyboard” on page 69.
11. See “Removing the Heatsink Fan Module” on page 70.
12. See “Removing the CPU and VGA Heatsink Module” on page 71.
13. See “Removing the CPU” on page 72.

14. See “Removing the VGA Board (Discrete Model only)” on page 73.
15. See “Removing the LCD Module” on page 74.
16. See “Separating the Upper Case from the Lower Case” on page 76.
17. Disconnect the touchpad cable from the touchpad board.

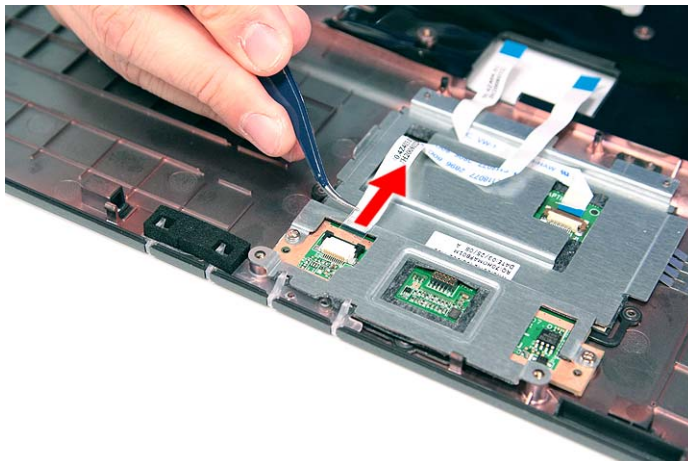
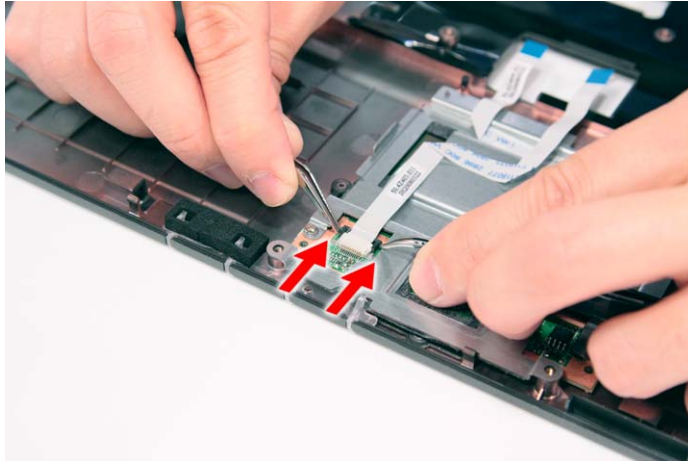

18. Disconnect the fingerprint cable from the fingerprint board.

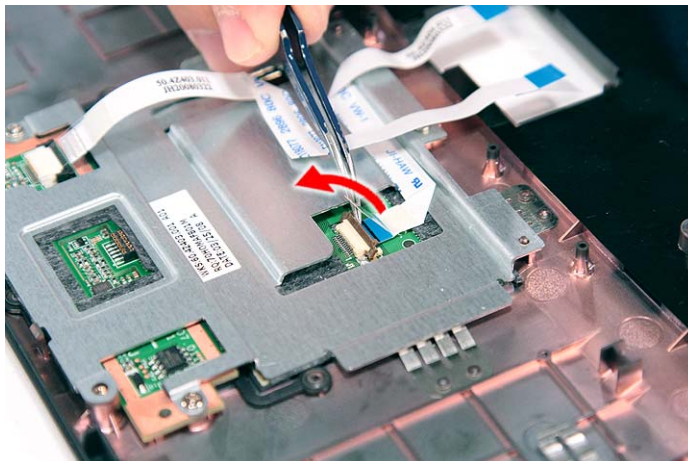

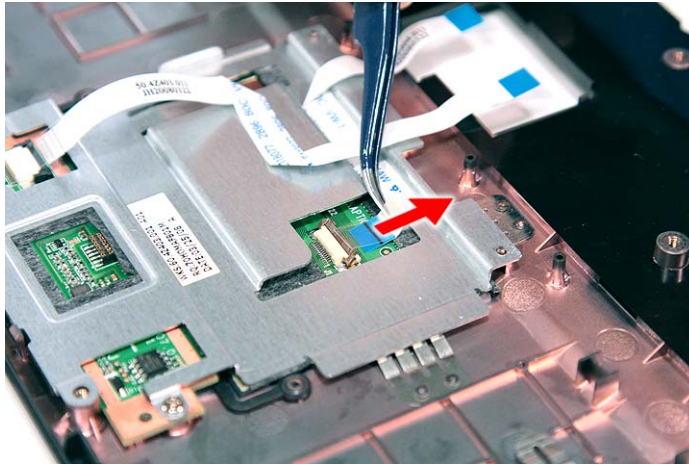

19. Remove the three screws (2 x F, 1 x A) securing the bracket to the upper case.

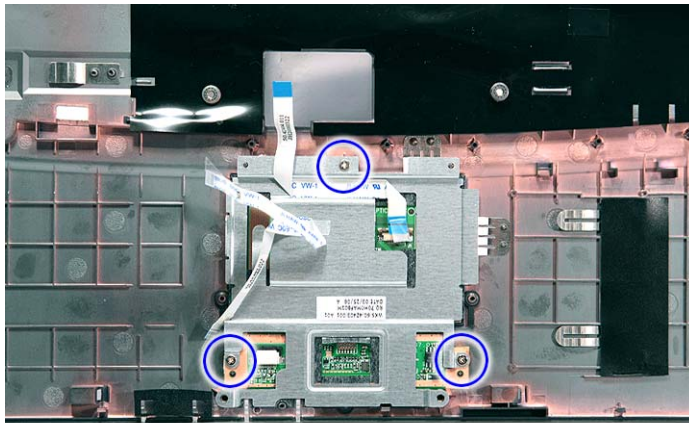

Step	Size (Quantity)	Color	Torque
1~2	M2 x L3 (2)	Silver	1.6 kgf-cm
3	M2 x L3 (2)	Silver	1.6 kgf-cm

20. Remove the touchpad bracket.



21. Remove the fingerprint board module.



22. Carefully pry loose and remove the touch pad board.

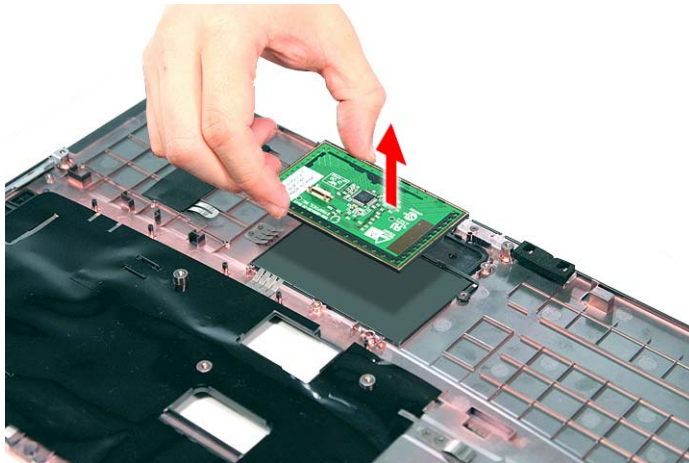
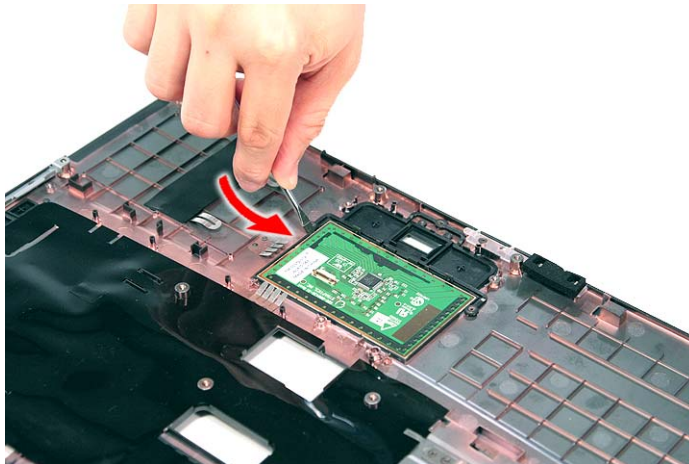

WARNING:The touchpad board is glued to the upper case, only remove the touchpad board if it is defective.

Removing the Modem Board

1. See "Removing the Battery Pack" on page 54.
2. See "Removing the SD dummy card" on page 55.

3. See “Removing the PC and ExpressCard dummy cards” on page 56.
4. See “Removing the Lower Cover” on page 57.
5. See “Removing the DIMM” on page 58.
6. See “Removing the WLAN Board Modules” on page 59.
7. See “Removing the Hard Disk Drive Module” on page 61.
8. See “Removing the Optical Drive Module” on page 62.
9. See “Removing the Middle Cover” on page 66.
10. See “Removing the Keyboard” on page 69.
11. See “Removing the Heatsink Fan Module” on page 70.
12. See “Removing the CPU and VGA Heatsink Module” on page 71.
13. See “Removing the CPU” on page 72.
14. See “Removing the VGA Board (Discrete Model only)” on page 73.
15. See “Removing the LCD Module” on page 74.
16. See “Separating the Upper Case from the Lower Case” on page 76.
17. Remove the two screws (B) securing the modem card.

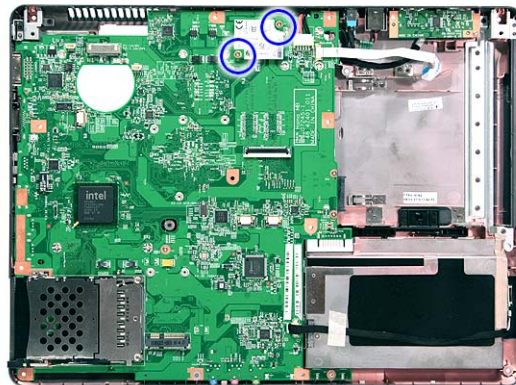

Step	Size (Quantity)	Color	Torque
1~2	M2 x L4 (2)	Silver	1.6 kgf-cm

18. Lift the modem board from the system.

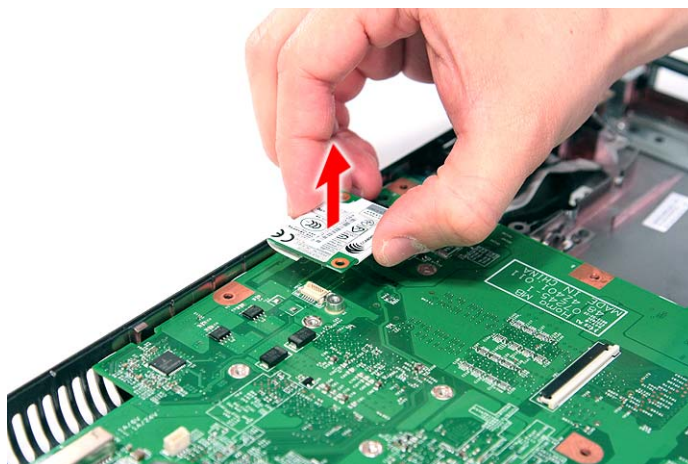

-
19. Disconnect the cable from the modem board.

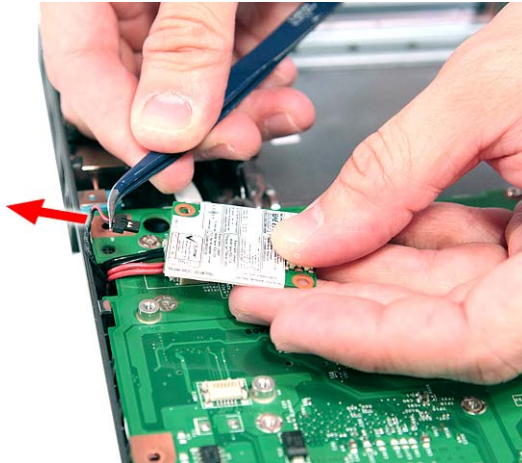

Removing the USB Board Module

1. See “Removing the Battery Pack” on page 54.
2. See “Removing the SD dummy card” on page 55.
3. See “Removing the PC and ExpressCard dummy cards” on page 56.
4. See “Removing the Lower Cover” on page 57.
5. See “Removing the DIMM” on page 58.
6. See “Removing the WLAN Board Modules” on page 59.
7. See “Removing the Hard Disk Drive Module” on page 61.
8. See “Removing the Optical Drive Module” on page 62.
9. See “Removing the Middle Cover” on page 66.
10. See “Removing the Keyboard” on page 69.
11. See “Removing the Heatsink Fan Module” on page 70.
12. See “Removing the CPU and VGA Heatsink Module” on page 71.
13. See “Removing the CPU” on page 72.
14. See “Removing the VGA Board (Discrete Model only)” on page 73.
15. See “Removing the LCD Module” on page 74.
16. See “Separating the Upper Case from the Lower Case” on page 76.

17. Remove the one screw (B) securing the USB board to the lower case.

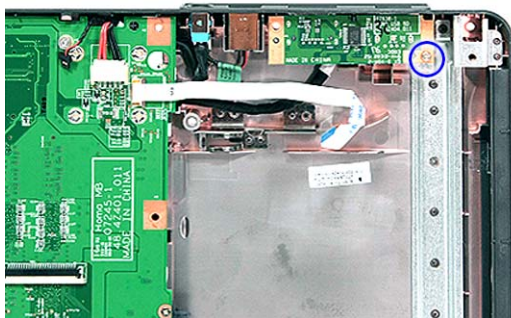

Step	Size (Quantity)	Color	Torque
1	M2 x L4 (1)	Silver	1.6 kgf-cm

18. Lift the USB board and disconnect the cable from USBCN1 on the USB board.

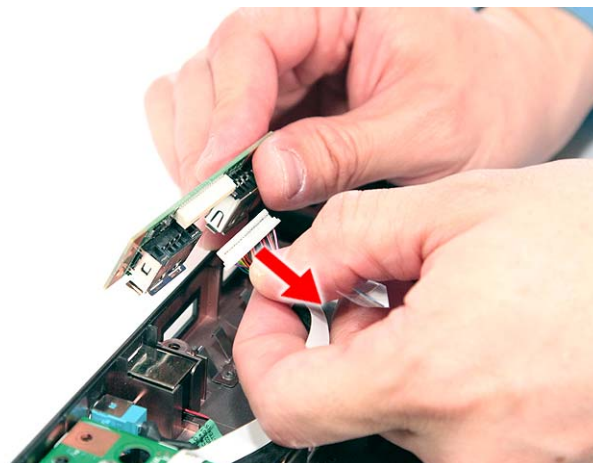

Removing the Main Board

1. See “Removing the Battery Pack” on page 54.
2. See “Removing the SD dummy card” on page 55.
3. See “Removing the PC and ExpressCard dummy cards” on page 56.
4. See “Removing the Lower Cover” on page 57.
5. See “Removing the DIMM” on page 58.
6. See “Removing the WLAN Board Modules” on page 59.
7. See “Removing the Hard Disk Drive Module” on page 61.
8. See “Removing the Optical Drive Module” on page 62.
9. See “Removing the Middle Cover” on page 66.
10. See “Removing the Keyboard” on page 69.
11. See “Removing the Heatsink Fan Module” on page 70.
12. See “Removing the CPU and VGA Heatsink Module” on page 71.
13. See “Removing the CPU” on page 72.

14. See “Removing the VGA Board (Discrete Model only)” on page 73.
15. See “Removing the LCD Module” on page 74.
16. See “Separating the Upper Case from the Lower Case” on page 76.
17. See “Removing the Modem Board” on page 85.
18. See “Removing the USB Board Module” on page 87.
19. Disconnect the Bluetooth cable from BLUE1 on the main board.

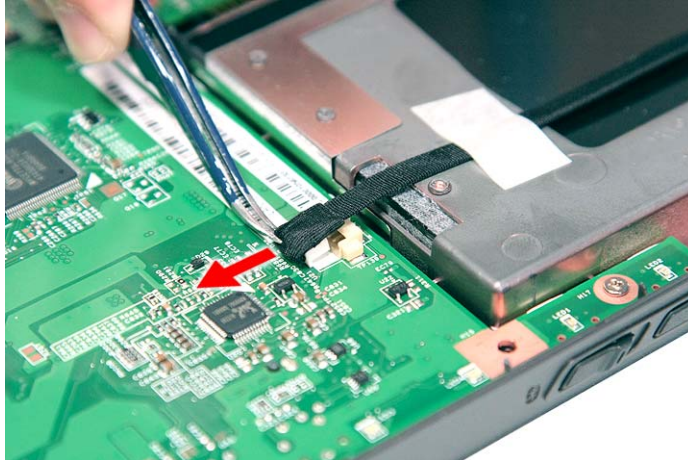

20. Disconnect the DC cable from the DC1 connector on the main board.

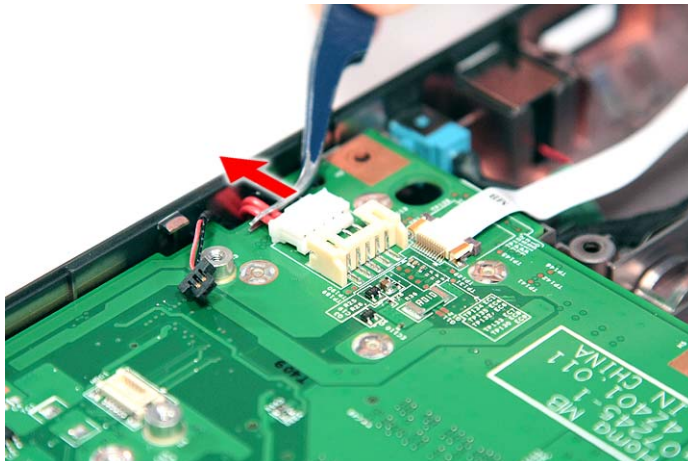

21. Remove the three screws (B) securing the main board in place.

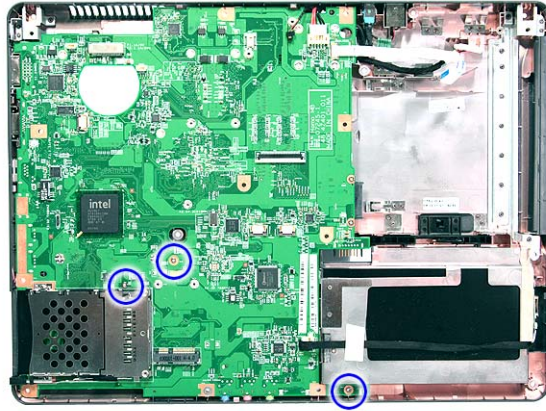

Step	Size (Quantity)	Color	Torque
1~3	M2 x L4 (3)	Silver	1.6 kgf-cm

22. Carefully remove the main board.

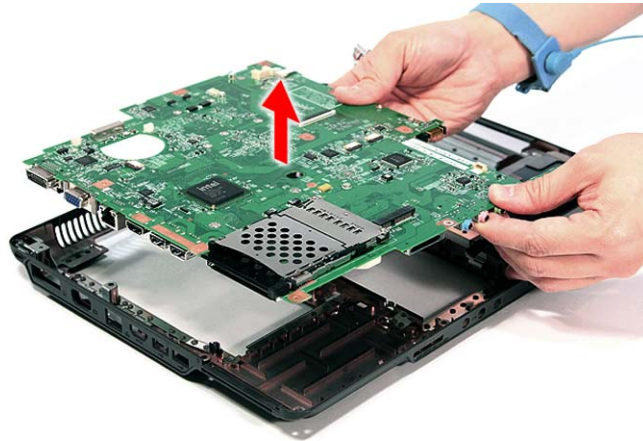

LCD Module Disassembly Process

LCD Module Disassembly Flowchart

LCD MODULE DISASSEMBLY

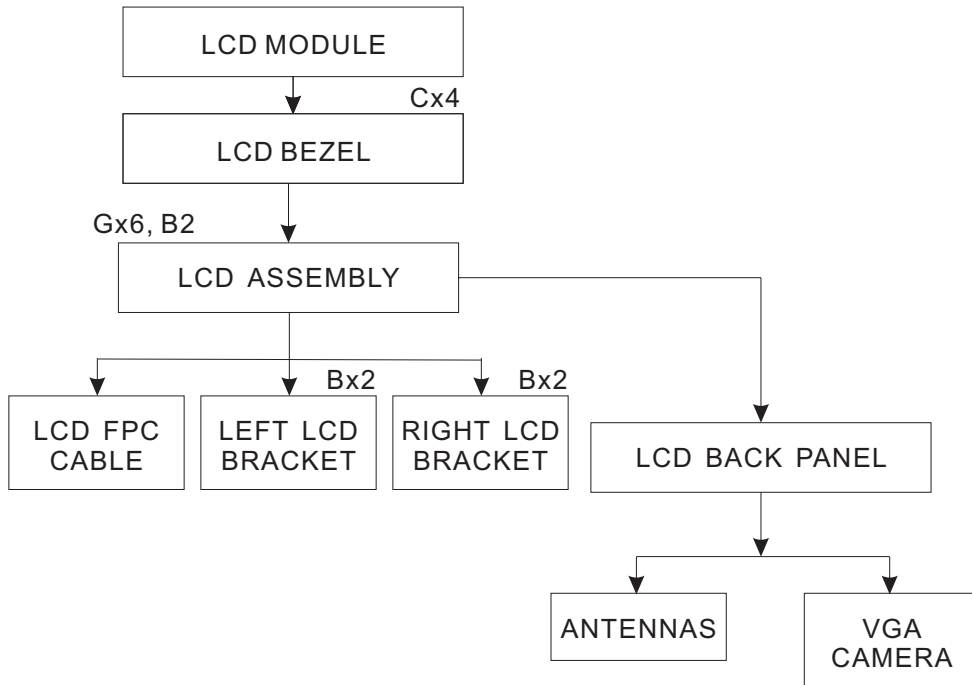

Screw List

Item	Screw	Color	Part No.
B	M2 x L4	Silver	86.9A552.4R0
C	M2.5 x L5	Black	86.00E33.736
G	M2.5 x L5	Black	86.00F87.735

Removing the LCD Bezel

1. See “Removing the Battery Pack” on page 54.
2. See “Removing the SD dummy card” on page 55.
3. See “Removing the PC and ExpressCard dummy cards” on page 56.
4. See “Removing the Lower Cover” on page 57.
5. See “Removing the WLAN Board Modules” on page 59.
6. See “Removing the Middle Cover” on page 66.
7. See “Removing the Keyboard” on page 69.
8. See “Removing the LCD Module” on page 74.
9. Remove the four screw covers from the LCD bezel.

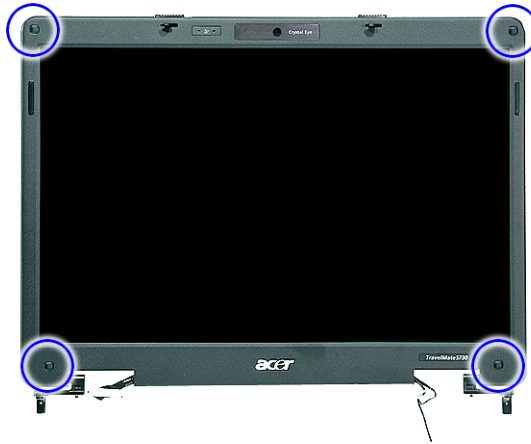

10. Remove the four screws (C) on the LCD module as shown.



Step	Size (Quantity)	Color	Torque
1~4	M2.5 x L6 (4)	Black	3.0 kgf-cm

11. Carefully pry open the LCD bezel and place the bezel on top of the LCD panel.



12. Disconnect the microphone cable and remove the bezel from the LCD panel.

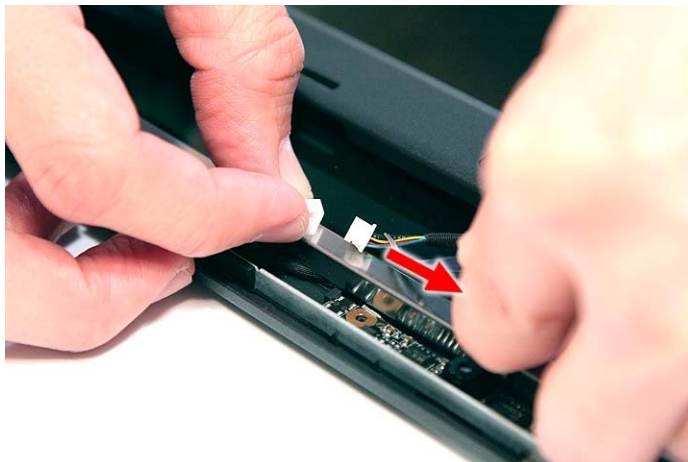

Removing the LCD module with the Brackets

1. See “Removing the Battery Pack” on page 54.
2. See “Removing the SD dummy card” on page 55.
3. See “Removing the PC and ExpressCard dummy cards” on page 56.
4. See “Removing the Lower Cover” on page 57.
5. See “Removing the WLAN Board Modules” on page 59.
6. See “Removing the Middle Cover” on page 66.
7. See “Removing the Keyboard” on page 69.
8. See “Removing the LCD Module” on page 74.
9. See “Removing the LCD Bezel” on page 92.
10. Disconnect the cable from the web camera.

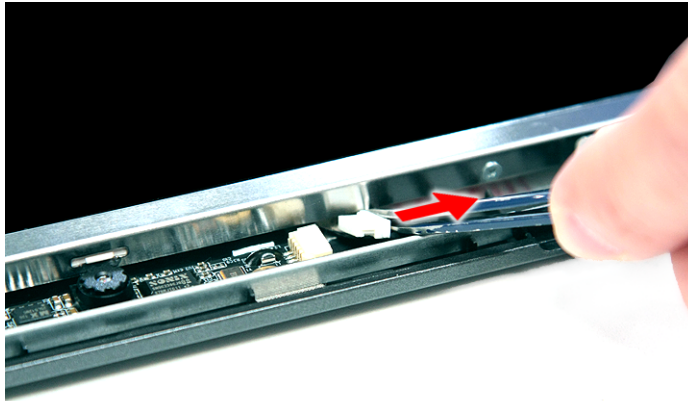

11. Remove the eight screws (6 x G, 2 x B) securing the LCD module.

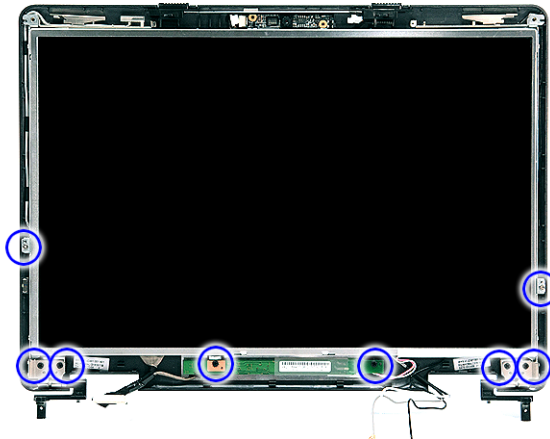

Step	Size (Quantity)	Color	Torque
1~6	M2.5 x L6 (6)	Black	2.5 kgf-cm
7~8	M2 x L4 (2)	Silver	1.6 kgf-cm

-
12. Remove the LCD with the brackets from the back cover.



Removing the FPC Cable

1. See "Removing the Battery Pack" on page 54.
2. See "Removing the SD dummy card" on page 55.
3. See "Removing the PC and ExpressCard dummy cards" on page 56.
4. See "Removing the Lower Cover" on page 57.
5. See "Removing the WLAN Board Modules" on page 59.
6. See "Removing the Middle Cover" on page 66.
7. See "Removing the Keyboard" on page 69.
8. See "Removing the LCD Module" on page 74.
9. See "Removing the LCD Bezel" on page 92.
10. See "Removing the LCD module with the Brackets" on page 94.
11. Disconnect the cables from the inverter board.

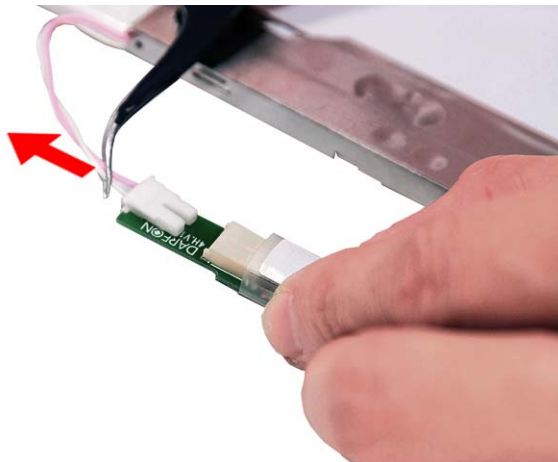

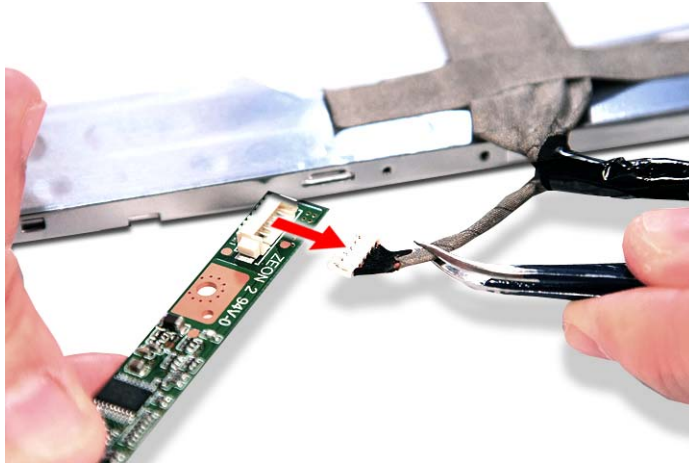

12. Detach any adhesive tapes and any cable that is glued to the LCD panel.





13. Disconnect the FPC cable from the LCD panel.

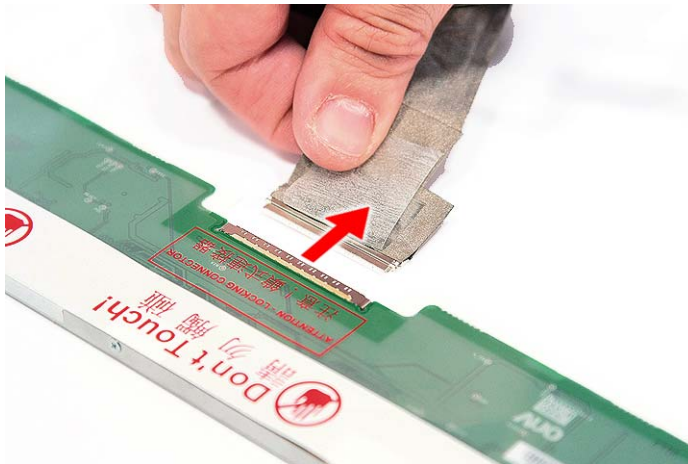

Removing the LCD Brackets

1. See “Removing the Battery Pack” on page 54.
2. See “Removing the Lower Cover” on page 57.
3. See “Removing the WLAN Board Modules” on page 59.
4. See “Removing the Keyboard” on page 69.
5. See “Removing the Middle Cover” on page 66.
6. See “Removing the LCD Module” on page 74.
7. See “Removing the LCD Bezel” on page 92.
8. See “Removing the LCD module with the Brackets” on page 94.
9. See “Removing the FPC Cable” on page 95.

10. Remove the four screws (4 x B) securing the left and right LCD brackets to remove the brackets.



Step	Size (Quantity)	Color	Torque
1~4	M2 x L4 (4)	Silver	1.6 kgf-cm

Removing the Antennas

1. See “Removing the Battery Pack” on page 54.
2. See “Removing the Lower Cover” on page 57.
3. See “Removing the WLAN Board Modules” on page 59.
4. See “Removing the Keyboard” on page 69.
5. See “Removing the Middle Cover” on page 66.
6. See “Removing the LCD Module” on page 74.
7. See “Removing the LCD Bezel” on page 92.
8. See “Removing the LCD module with the Brackets” on page 94.
9. Release the antenna cables from the aluminium tapes.

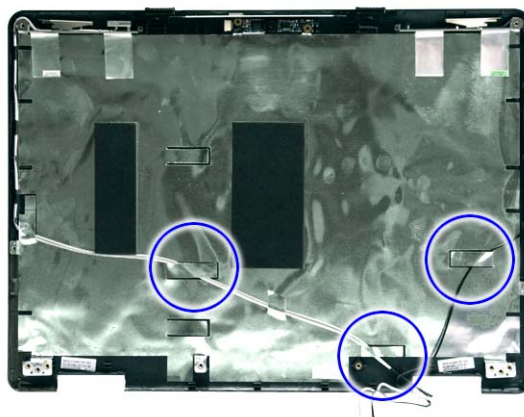

-
10. Remove the tapes together holding the antenna in place.



NOTE: There is no need to remove the antenna unless you really need to replace it.

Removing the Web Camera

1. See “Removing the Battery Pack” on page 54.
2. See “Removing the Lower Cover” on page 57.
3. See “Removing the WLAN Board Modules” on page 59.
4. See “Removing the Keyboard” on page 69.
5. See “Removing the Middle Cover” on page 66.
6. See “Removing the LCD Module” on page 74.
7. See “Removing the LCD Bezel” on page 92.
8. See “Removing the LCD module with the Brackets” on page 94.

-
9. Remove the Web camera from the back cover.



Troubleshooting

Use the following procedure as a guide for computer problems.

NOTE: The diagnostic tests are intended to test only Acer products. Non-Acer products, prototype cards, or modified options can give false errors and invalid system responses.

1. Obtain the failing symptoms in as much detail as possible.
2. Verify the symptoms by attempting to re-create the failure by running the diagnostic test or by repeating the same operation.
3. Use the following table with the verified symptom to determine which page to go to.

Symptoms (Verified)	Go To
Power failure. (The power indicator does not go on or stay on.)	"Power System Check" on page 103.
POST does not complete. No beep or error codes are indicated.	"Power-On Self-Test (POST) Error Message" on page 106 "Undetermined Problems" on page 120
POST detects an error and displayed messages on screen.	"Error Message List" on page 107
Other symptoms (i.e. LCD display problems or others).	"Power-On Self-Test (POST) Error Message" on page 106
Symptoms cannot be re-created (intermittent problems).	Use the customer-reported symptoms and go to "Power-On Self-Test (POST) Error Message" on page 106 "Intermittent Problems" on page 119 "Undetermined Problems" on page 120

System Check Procedures

External Diskette Drive Check

Do the following to isolate the problem to a controller, driver, or diskette. A write-enabled, diagnostic diskette is required.

NOTE: Make sure that the diskette does not have more than one label attached to it. Multiple labels can cause damage to the drive or cause the drive to fail.

Do the following to select the test device.

1. Boot from the diagnostics diskette and start the diagnostics program.
2. See if FDD Test is passed as the program runs to FDD Test.
3. Follow the instructions in the message window.

If an error occurs with the internal diskette drive, reconnect the diskette connector on the system board.

If the error still remains:

1. Reconnect the external diskette drive/DVD-ROM module.
2. Replace the external diskette drive/CD-ROM module.
3. Replace the main board.

External CD-ROM Drive Check

Do the following to isolate the problem to a controller, drive, or CD-ROM. Make sure that the CD-ROM does not have any label attached to it. The label can cause damage to the drive or can cause the drive to fail.

Do the following to select the test device:

1. Boot from the diagnostics diskette and start the diagnostics program.
2. See if CD-ROM Test is passed when the program runs to CD-ROM Test.
3. Follow the instructions in the message window.

If an error occurs, reconnect the connector on the System board. If the error still remains:

1. Reconnect the external diskette drive/CD-ROM module.
2. Replace the external diskette drive/CD-ROM module.
3. Replace the main board.

Keyboard or Auxiliary Input Device Check

Remove the external keyboard if the internal keyboard is to be tested.

If the internal keyboard does not work or an unexpected character appears, make sure that the flexible cable extending from the keyboard is correctly seated in the connector on the system board.

If the keyboard cable connection is correct, run the Keyboard Test.

If the tests detect a keyboard problem, do the following one at a time to correct the problem. Do not replace a non-defective FRU:

1. Reconnect the keyboard cables.
2. Replace the keyboard.
3. Replace the main board.

The following auxiliary input devices are supported by this computer:

- Numeric keypad

-
- External keyboard

If any of these devices do not work, reconnect the cable connector and repeat the failing operation.

Memory check

Memory errors might stop system operations, show error messages on the screen, or hang the system.

1. Boot from the diagnostics diskette and start the diagnostic program (please refer to main board).
2. Go to the diagnostic memory in the test items.
3. Press F2 in the test items.
4. Follow the instructions in the message window.

NOTE: Make sure that the DIMM is fully installed into the connector. A loose connection can cause an error.

Power System Check

To verify the symptom of the problem, power on the computer using each of the following power sources:

1. Remove the battery pack.
2. Connect the power adapter and check that power is supplied.
3. Disconnect the power adapter and install the charged battery pack; then check that power is supplied by the battery pack.

If you suspect a power problem, see the appropriate power supply check in the following list:

- “Check the Power Adapter” on page 104
- “Check the Battery Pack” on page 105

Check the Power Adapter

Unplug the power adapter cable from the computer and measure the output voltage at the plug of the power adapter cable. See the following figure

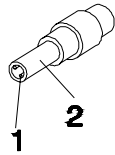

Pin 1: +19 to +20.5V

Pin 2: 0V, Ground

1. If the voltage is not correct, replace the power adapter.
2. If the voltage is within the range, do the following:
 - Replace the System board.
 - If the problem is not corrected, see “Undetermined Problems” on page 120.
 - If the voltage is not correct, go to the next step.

NOTE: An audible noise from the power adapter does not always indicate a defect.

3. If the power-on indicator does not light up, check the power cord of the power adapter for correct continuity and installation.
4. If the operational charge does not work, see “Check the Battery Pack” on page 105.

Check the Battery Pack

To check the battery pack, do the following:

From Software:

1. Check out the Power Management in control Panel
2. In Power Meter, confirm that if the parameters shown in the screen for Current Power Source and Total Battery Power Remaining are correct.
3. Repeat the steps 1 and 2, for both battery and adapter.
4. This helps you identify first the problem is on recharging or discharging.

From Hardware:

1. Power off the computer.
2. Remove the battery pack and measure the voltage between battery terminals 1(+) and 6(ground).
3. If the voltage is still less than 7.5 Vdc after recharging, replace the battery.

To check the battery charge operation, use a discharged battery pack or a battery pack that has less than 50% of the total power remaining when installed in the computer.

If the battery status indicator does not light up, remove the battery pack and let it return to room temperature. Re-install the battery pack.

If the charge indicator still does not light up, replace the battery pack. If the charge indicator still does not light up, replace the DC/DC charger board.

Touchpad Check

If the touchpad doesn't work, do the following actions one at a time to correct the problem. Do not replace a non-defective FRU:

1. Reconnect the touchpad cables.
2. Replace the touchpad.
3. Replace the system board.

After you use the touchpad, the pointer drifts on the screen for a short time. This self-acting pointer movement can occur when a slight, steady pressure is applied to the touchpad pointer. This symptom is not a hardware problem. No service actions are necessary if the pointer movement stops in a short period of time.

Power-On Self-Test (POST) Error Message

The POST error message index lists the error message and their possible causes. The most likely cause is listed first.

NOTE: Perform the FRU replacement or actions in the sequence shown in FRU/Action column, if the FRU replacement does not solve the problem, put the original part back in the computer. Do not replace a non-defective FRU.

This index can also help you determine the next possible FRU to be replaced when servicing a computer.

If the symptom is not listed, see “Undetermined Problems” on page 120.

The following lists the error messages that the BIOS displays on the screen and the error symptoms classified by function.

NOTE: Most of the error messages occur during POST. Some of them display information about a hardware device, e.g., the amount of memory installed. Others may indicate a problem with a device, such as the way it has been configured.

NOTE: If the system fails after you make changes in the BIOS Setup Utility menus, reset the computer, enter Setup and install Setup defaults or correct the error.

Index of Error Messages

Error Code List

Error Codes	Error Messages
006	Equipment Configuration Error Causes: 1. CPU BIOS Update Code Mismatch 2. IDE Primary Channel Master Drive Error (The causes will be shown before "Equipment Configuration Error")
010	Memory Error at xxxx:xxxx:xxxxh (R:xxxxh, W:xxxxh)
070	Real Time Clock Error
071	CMOS Battery Bad
072	CMOS Checksum Error
110	System disabled. Incorrect password is specified.
<No error code>	Battery critical LOW In this situation BIOS will issue 4 short beeps then shut down system, no message will show.
<No error code>	Thermal critical High In this situation BIOS will shut down system, not show message.

Error Message List

Error Messages	FRU/Action in Sequence
Failure Fixed Disk	Reconnect hard disk drive connector. "Load Default Settings" in BIOS Setup Utility. Hard disk drive System board
Stuck Key	see "Keyboard or Auxiliary Input Device Check" on page 102.
Keyboard error	see "Keyboard or Auxiliary Input Device Check" on page 102.
Keyboard Controller Failed	see "Keyboard or Auxiliary Input Device Check" on page 102.
Keyboard locked - Unlock key switch	Unlock external keyboard
Monitor type does not match CMOS - Run Setup	Run "Load Default Settings" in BIOS Setup Utility.
Shadow RAM Failed at offset: nnnn	BIOS ROM System board
System RAM Failed at offset: nnnn	DIMM System board
Extended RAM Failed at offset: nnnn	DIMM System board
System battery is dead - Replace and run Setup	Replace RTC battery and Run BIOS Setup Utility to reconfigure system time, then reboot system.
System CMOS checksum bad - Default configuration used	RTC battery Run BIOS Setup Utility to reconfigure system time, then reboot system.

Error Message List

Error Messages	FRU/Action in Sequence
System timer error	RTC battery Run BIOS Setup Utility to reconfigure system time, then reboot system. System board
Real time clock error	RTC battery Run BIOS Setup Utility to reconfigure system time, then reboot system. System board
Previous boot incomplete - Default configuration used	Run "Load Default Settings" in BIOS Setup Utility. RTC battery System board
Memory size found by POST differed from CMOS	Run "Load Default Settings" in BIOS Setup Utility. DIMM System board
Diskette drive A error	Check the drive is defined with the proper diskette type in BIOS Setup Utility See "External Diskette Drive Check" on page 102.
Incorrect Drive A type - run SETUP	Check the drive is defined with the proper diskette type in BIOS Setup Utility
System cache error - Cache disabled	System board
CPU ID:	System board
DMA Test Failed	DIMM System board
Software NMI Failed	DIMM System board
Fail-Safe Timer NMI Failed	DIMM System board
Device Address Conflict	Run "Load Default Settings" in BIOS Setup Utility. RTC battery System board
Allocation Error for device	Run "Load Default Settings" in BIOS Setup Utility. RTC battery System board
Failing Bits: nnnn	DIMM BIOS ROM System board
Fixed Disk n	None
Invalid System Configuration Data	BIOS ROM System board
I/O device IRQ conflict	Run "Load Default Settings" in BIOS Setup Utility. RTC battery System board
Operating system not found	Enter Setup and see if fixed disk and drive A: are properly identified. Diskette drive Hard disk drive System board

Error Message List

No beep Error Messages	FRU/Action in Sequence
No beep, power-on indicator turns off and LCD is blank.	Power source (battery pack and power adapter). See "Power System Check" on page 103.. Ensure every connector is connected tightly and correctly. Reconnect the DIMM. LED board. System board.
No beep, power-on indicator turns on and LCD is blank.	Power source (battery pack and power adapter). See "Power System Check" on page 103.. Reconnect the LCD connector Hard disk drive LCD inverter ID LCD cable LCD Inverter LCD System board
No beep, power-on indicator turns on and LCD is blank. But you can see POST on an external CRT.	Reconnect the LCD connectors. LCD inverter ID LCD cable LCD inverter LCD System board
No beep, power-on indicator turns on and a blinking cursor shown on LCD during POST.	Ensure every connector is connected tightly and correctly. System board
No beep during POST but system runs correctly.	Speaker System board

Phoenix BIOS Beep Codes

Code	Beeps	POST Routine Description
02h		Verify Real Mode
03h		Disable Non-Maskable Interrupt (NMI)
04h		Get CPU type
06h		Initialize system hardware
08h		Initialize chipset with initial POST values
09h		Set IN POST flag
0Ah		Initialize CPU registers
0Bh		Enable CPU cache
0Ch		Initialize caches to initial POST values
0Eh		Initialize I/O component
0Fh		Initialize the local bus IDE
10h		Initialize Power Management
11h		Load alternate registers with initial POST values
12h		Restore CPU control word during warm boot
13h		Initialize PCI Bus Mastering devices
14h		Initialize keyboard controller
16h	1-2-2-3	BIOS ROM checksum
17h		Initialize cache before memory autosize
18h		8254 timer initialization
1Ah		8237 DMA controller initialization
1Ch		Reset Programmable Interrupt Controller
20h	1-3-1-1	Test DRAM refresh
22h	1-3-1-3	Test 8742 Keyboard Controller
24h		Set ES segment register to 4 GB
26h		Enable A20 line
28h		Autosize DRAM
29h		Initialize POST Memory Manager
2Ah		Clear 215 KB base RAM
2Ch	1-3-4-1	RAM failure on address line xxxx
2Eh	1-3-4-3	RAM failure on data bits xxxx of low byte of memory bus
2Fh		Enable cache before system BIOS shadow
30h	1-4-1-1	RAM failure on data bits xxxx of high byte of memory bus
32h		Test CPU bus-clock frequency
33h		Initialize Phoenix Dispatch Manager
36h		Warm start shut down
38h		Shadow system BIOS ROM
3Ah		Autosize cache

Code	Beeps	POST Routine Description
3Ch		Advanced configuration of chipset registers
3Dh		Load alternate registers with CMOS values
42h		Initialize interrupt vectors
45h		POST device initialization
46h	2-1-2-3	Check ROM copyright notice
48h		Check video configuration against CMOS
49h		Initialize PCI bus and devices
4Ah		Initialize all video adapters in system
4Bh		QuietBoot start (optional)
4Ch		Shadow video BIOS ROM
4Eh		Display BIOS copyright notice
50h		Display CPU type and speed
51h		Initialize EISA board
52h		Test keyboard
54h		Set key click if enabled
58h	2-2-3-1	Test for unexpected interrupts
59h		Initialize POST display service
5Ah		Display prompt "Press F2 to enter SETUP"
5Bh		Disable CPU cache
5Ch		Test RAM between 512 and 640 KB
60h		Test extended memory
62h		Test extended memory address lines
64h		Jump to User Patch1
66h		Configure advanced cache registers
67h		Initialize Multi Processor APIC
68h		Enable external and CPU caches
69h		Setup System Management Mode (SMM) area
6Ah		Display external L2 cache size
6Bh		Load custom defaults (optional)
6Ch		Display shadow-area message
6Eh		Display possible high address for UMB recovery
70h		Display error messages
72h		Check for configuration errors
76h		Check for keyboard errors
7Ch		Set up hardware interrupt vectors
7Eh		Initialize coprocessor if present
80h		Disable onboard Super I/O ports and IRQs
81h		Late POST device initialization

Code	Beeps	POST Routine Description
82h		Detect and install external RS232 ports
83h		Configure non-MCD IDE controllers
84h		Detect and install external parallel ports
85h		Initialize PC-compatible PnP ISA devices
86h		Re-initialize onboard I/O ports
87h		Configure Motherboard Configurable Devices (optional)
88h		Initialize BIOS Area
89h		Enable Non-Maskable Interrupts (NMIs)
8Ah		Initialize Extended BIOS Data Area
8Bh		Test and initialize PS/2 mouse
8Ch		Initialize floppy controller
8Fh		Determine number of ATA drives (optional)
90h		Initialize hard-disk controllers
91h		Initialize local-bus hard-disk controllers
92h		Jump to UserPatch2
93h		Build MPTABLE for multi-processor boards
95h		Install CD ROM for boot
96h		Clear huge ES segment register
97h		Fixup Multi Processor table
98h	1-2	Search for option ROMs. One long, two short beeps on checksum failure.
99h		Check for SMART drive (optional)
9Ah		Shadow option ROMs
9Ch		Set up Power Management
9Dh		Initialize security engine (optional)
9Eh		Enable hardware interrupts
9Fh		Determine number of ATA and SCSI drives
A0h		Set time of day
A2h		Check key lock
A4h		Initialize Typematic rate
A8h		Erase F2 prompt
AAh		Scan for F2 key stroke
ACh		Enter SETUP
A Eh		Clear Boot flag
B0h		Check for errors
B2h		POST done- prepare to boot operating system
B4h	1	One short beep before boot
B5h		Terminate QuietBoot (optional)
B6h		Check password (optional)

Code	Beeps	POST Routine Description
B9h		Prepare Boot
BAh		Initialize DMI parameters
BBh		Initialize PnP Option ROMs
BCh		Clear parity checkers
BDh		Display MultiBoot menu
BEh		Clear screen (optional)
BFh		Check virus and backup reminders
C0h		Try to boot with INT 19
C1h		Initialize POST Error Manager (PEM)
C2h		Initialize error logging
C3h		Initialize error display function
C4h		Initialize system error handler
C5h		PnPnd dual CMOS (optional)
C6h		Initialize notebook docking (optional)
C7h		Initialize notebook docking late
C8h		Force check (optional)
C9h		Extended checksum (optional)
D2h		Unknown interrupt

Code	Beeps	POST Routine Description
E0h		Initialize the chipset
E1h		Initialize the bridge
E2h		Initialize the CPU
E3h		Initialize the system timer
E4h		Initialize system I/O
E5h		Check force recovery boot
E6h		Checksum BIOS ROM
E7h		Go to BIOS
E8h		Set Huge Segment
E9h		Initialize Multi Processor
EAh		Initialize OEM special code
EBh		Initialize PIC and DMA
ECh		Initialize Memory type
EDh		Initialize Memory size
EEh		Shadow Boot Block
EFh		System memory test
F0h		Initialize interrupt vectors
F1h		Initialize Run Time Clock
F2h		Initialize video
F3h		Initialize System Management Mode
F4h	1	Output one beep before boot

Code	Beeps	
F5h		Boot to Mini DOS
F6h		Clear Huge Segment
F7h		Boot to Full DOS

Index of Symptom-to-FRU Error Message

LCD-Related Symptoms

Symptom / Error	Action in Sequence
LCD backlight doesn't work LCD is too dark LCD brightness cannot be adjusted LCD contrast cannot be adjusted	Enter BIOS Utility to execute "Load Setup Default Settings", then reboot system. Reconnect the LCD connectors. Keyboard (if contrast and brightness function key doesn't work). LCD inverter ID LCD cable LCD inverter LCD System board
Unreadable LCD screen Missing pels in characters Abnormal screen Wrong color displayed	Reconnect the LCD connector LCD inverter ID LCD cable LCD inverter LCD System board
LCD has extra horizontal or vertical lines displayed.	LCD inverter ID LCD inverter LCD cable LCD System board

Indicator-Related Symptoms

Symptom / Error	Action in Sequence
Indicator incorrectly remains off or on, but system runs correctly	Reconnect the inverter board Inverter board System board

Power-Related Symptoms

Symptom / Error	Action in Sequence
Power shuts down during operation	Power source (battery pack and power adapter). See "Power System Check" on page 103. Battery pack Power adapter Hard drive & battery connection board System board
The system doesn't power-on.	Power source (battery pack and power adapter). See "Power System Check" on page 103. Battery pack Power adapter Hard drive & battery connection board System board

Power-Related Symptoms

Symptom / Error	Action in Sequence
The system doesn't power-off.	Power source (battery pack and power adapter). See "Power System Check" on page 103. Hold and press the power switch for more than 4 seconds. System board
Battery can't be charged	See "Check the Battery Pack" on page 105. Battery pack System board

PCMCIA-Related Symptoms

Symptom / Error	Action in Sequence
System cannot detect the PC Card (PCMCIA)	PCMCIA slot assembly System board
PCMCIA slot pin is damaged.	PCMCIA slot assembly

Memory-Related Symptoms

Symptom / Error	Action in Sequence
Memory count (size) appears different from actual size.	Enter BIOS Setup Utility to execute "Load Default Settings, then reboot system." DIMM System board

Speaker-Related Symptoms

Symptom / Error	Action in Sequence
In Windows, multimedia programs, no sound comes from the computer.	Audio driver Speaker System board
Internal speakers make noise or emit no sound.	Speaker System board

Power Management-Related Symptoms

Symptom / Error	Action in Sequence
The system will not enter hibernation	See "Save to Disk (S4)" on page 34. Keyboard (if control is from the keyboard) Hard disk drive System board
The system doesn't enter hibernation mode and four short beeps every minute.	Press Fn+0 and see if the computer enters hibernation mode. Touchpad Keyboard Hard disk connection board Hard disk drive System board
The system doesn't enter standby mode after closing the LCD	See "Save to Disk (S4)" on page 34. LCD cover switch System board

Power Management-Related Symptoms

Symptom / Error	Action in Sequence
The system doesn't resume from hibernation mode.	See "Save to Disk (S4)" on page 34. Hard disk connection board Hard disk drive System board
The system doesn't resume from standby mode after opening the LCD.	See "Save to Disk (S4)" on page 34. LCD cover switch System board
Battery fuel gauge in Windows doesn't go higher than 90%.	Remove battery pack and let it cool for 2 hours. Refresh battery (continue use battery until power off, then charge battery). Battery pack System board
System hangs intermittently.	Reconnect hard disk/CD-ROM drives. Hard disk connection board System board

Peripheral-Related Symptoms

Symptom / Error	Action in Sequence
System configuration does not match the installed devices.	Enter BIOS Setup Utility to execute "Load Default Settings", then reboot system. Reconnect hard disk/CD-ROM/diskette drives.
External display does not work correctly.	Press Fn+F5, LCD/CRT/Both display switching System board
USB does not work correctly	System board
Print problems.	Ensure the "Parallel Port" in the "Onboard Devices Configuration" of BIOS Setup Utility is set to Enabled. Onboard Devices Configuration Run printer self-test. Printer driver Printer cable Printer System Board
Serial or parallel port device problems.	Ensure the "Serial Port" in the Devices Configuration" of BIOS Setup Utility is set to Enabled. Device driver Device cable Device System board

Keyboard/Touchpad-Related Symptoms

Symptom / Error	Action in Sequence
Keyboard (one or more keys) does not work.	Reconnect the keyboard cable. Keyboard System board

Keyboard/Touchpad-Related Symptoms

Symptom / Error	Action in Sequence
Touchpad does not work.	Reconnect touchpad cable. Touchpad board System board

Modem-Related Symptoms

Symptom / Error	Action in Sequence
Internal modem does not work correctly.	Modem phone port modem combo board System board

NOTE: If you cannot find a symptom or an error in this list and the problem remains, see “Undetermined Problems” on page 120.

Intermittent Problems

Intermittent system hang problems can be caused by a variety of reasons that have nothing to do with a hardware defect, such as: cosmic radiation, electrostatic discharge, or software errors. FRU replacement should be considered only when a recurring problem exists.

When analyzing an intermittent problem, do the following:

1. Run the advanced diagnostic test for the system board in loop mode at least 10 times.
2. If no error is detected, do not replace any FRU.
3. If any error is detected, replace the FRU. Rerun the test to verify that there are no more errors.

Undetermined Problems

The diagnostic problems does not identify which adapter or device failed, which installed devices are incorrect, whether a short circuit is suspected, or whether the system is inoperative.

Follow these procedures to isolate the failing FRU (do not isolate non-defective FRU).

NOTE: Verify that all attached devices are supported by the computer.

NOTE: Verify that the power supply being used at the time of the failure is operating correctly. (See "Power System Check" on page 103.):

1. Power-off the computer.
2. Visually check them for damage. If any problems are found, replace the FRU.
3. Remove or disconnect all of the following devices:
 - q Non-Acer devices
 - q Printer, mouse, and other external devices
 - q Battery pack
 - q Hard disk drive
 - q DIMM
 - q CD-ROM/Diskette drive Module
 - q PC Cards
4. Power-on the computer.
5. Determine if the problem has changed.
6. If the problem does not recur, reconnect the removed devices one at a time until you find the failing FRU.
7. If the problem remains, replace the following FRU one at a time. Do not replace a non-defective FRU:
 - q System board
 - q LCD assembly

Jumper and Connector Locations

Top and Bottom View

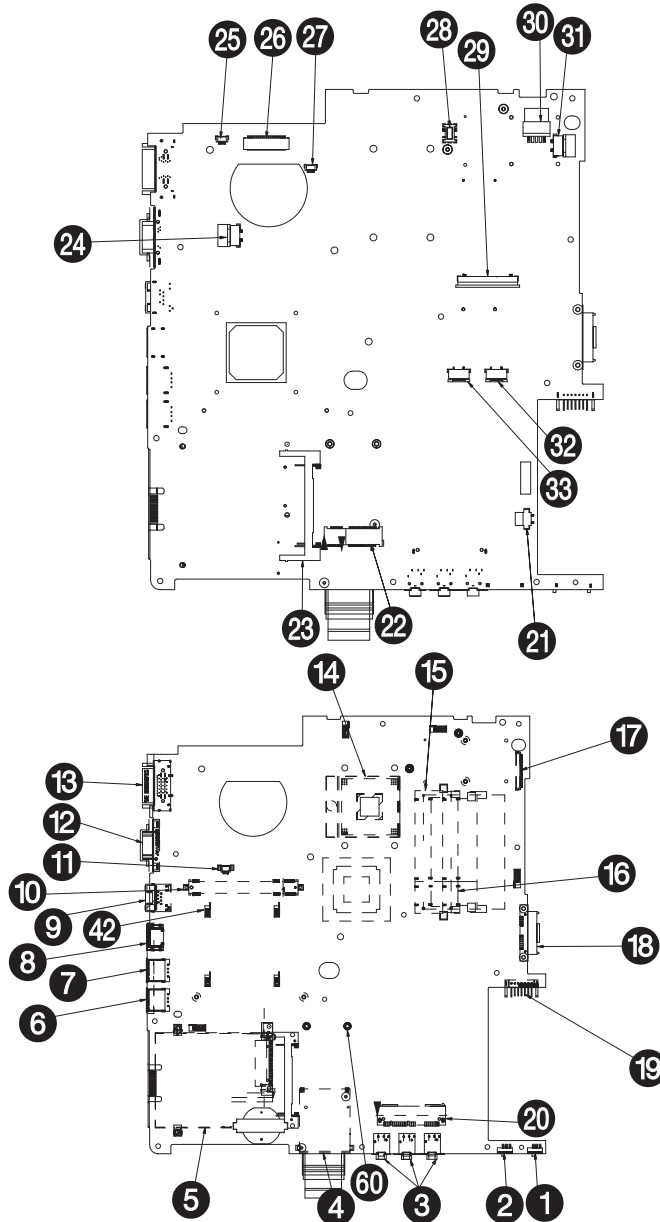

ITEM	POSITION	PIN
1	wirless switch	
2	bluetooth switch	
3	Audio Jack	
4	card reader	
5	new card	
6	USB	
7	USB	
8	HDMI	
9	RJ-45	
10	MXM card connector	
11	FAN connector	
12	D-sub	
13	P/R connector	
14	CPU connector	
15	Dimm 1 connector	
16	Dimm 2 connector	
17	USB BD to M/B connector	
18	ODD connector	
19	BTY connector	
20	HDD connector	
21	bluetooth connector	
22	robin connector	
23	card bus	
24	Latch BD to M/B connector	
25	MIC connector	
26	LCD connector	
27	speaker connector	
28	moden connector	
29	K/B connector	
30	DC-IN connector	
31	power BD to M/B connector	
32	T/P connector	
33	finger bd to M/B connector	
34	34.15F09.001	

NOTE: No.8, 10,12, 21, 33 are not available on these models

Clearing Password Check and BIOS Recovery

This section provide you the standard operating procedures of clearing password and BIOS recovery for TravelMate 5730 Series. TravelMate 5730 Series provide one Hardware Open Gap on main board for clearing password check, and one Hotkey for enabling BIOS Recovery.

Clearing Password Check

Hardware Open Gap Description

Hardware	Default Setting	Operation Description
Gap	Open (Normal)	Short (Clearing Password Check)

HW Gap position on M/B space:

Gap name in TravelMate 5730 Series is G77

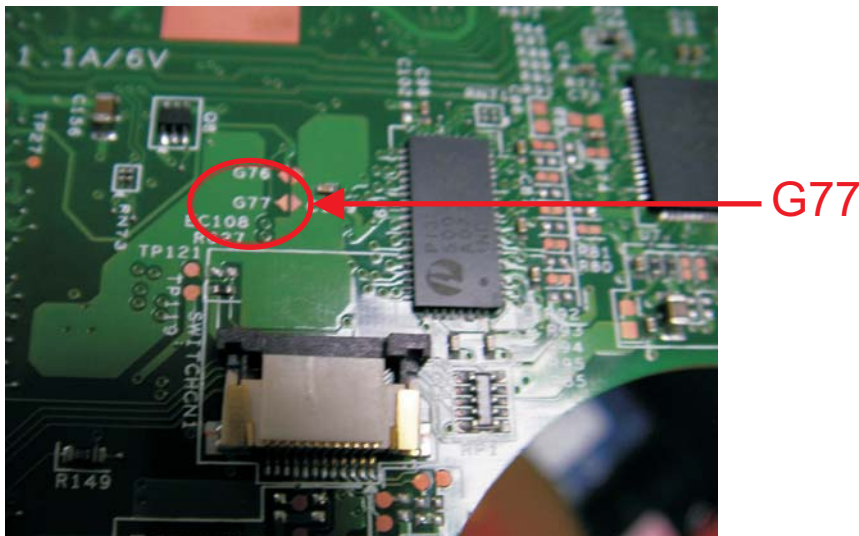

Steps for Clearing BIOS Password Check

If users set BIOS Password (Supervisor Password and/or User Password) for a security reason, BIOS will ask the password during systems POST or when systems enter to BIOS Setup menu. However, once it is necessary to bypass the password check, users need to short the HW Gap to clear the password by the following steps:

- Power Off a system, and remove HDD, AC and Battery from the machine.
- Open the back cover of the machine, and find out the HW Gap on M/B as picture.
- Use an electric conductivity tool to short the two points of the HW Gap.
- Plug in AC, keep the short condition on the HW Gap, and press Power Button to power on the system till BIOS POST finish. Then remove the tool from the HW Gap.
- Restart system. Press F2 key to enter BIOS Setup menu.
- If there is no Password request, BIOS Password is cleared. Otherwise, please follow the steps and try again.

NOTE: The steps are only for clearing BIOS Password (Supervisor Password and User Password).

BIOS Recovery by Crisis Disk

BIOS Recovery Boot Block:

BIOS Recovery Boot Block is a special block of BIOS. It is used to boot up the system with minimum BIOS initialization. Users can enable this feature to restore the BIOS firmware to a successful one once the previous BIOS flashing process failed.

BIOS Recovery Hotkey:

The system provides a function hotkey: **Fn+Esc**, for enable BIOS Recovery process when system is powered on during BIOS POST. To use this function, it is strongly recommended to have the AC adapter and Battery present. If this function is enabled, the system will force the BIOS to enter a special BIOS block, called Boot Block.

Steps for BIOS Recovery by Crisis Disk:

Before doing this, one Crisis Disk should be prepared ready in hand. The Crisis Disk could be made by executing the Crisis Disk program in another system with Windows XP OS.

Follow the steps below:

1. Power Off system.
2. Insert the Crisis Disk to a USB floppy drive which is attached to the BIOS flash failed machine.
3. In the power-off state, press **Fn+Esc** and hold them and then press Power Button. The system should be powered on with Crisis BIOS Recovery process.
4. BIOS Boot Block starts to restore the BIOS code from the Crisis floppy disk to BIOS ROM on the failed machine.
5. If the Crisis flashing process is finished, the system will restart.

If the Crisis Recovery process is finished, the system should be powered on with successful and workable BIOS. Then a person can update the latest version BIOS for this machine by regular BIOS flashing process.

FRU (Field Replaceable Unit) List

This chapter gives you the FRU (Field Replaceable Unit) listing in global configurations of Extensa5230/5630Z and TravelMate 5330 Series. Refer to this chapter whenever ordering for parts to repair or for RMA (Return Merchandise Authorization).

Please note that WHEN ORDERING FRU PARTS, you should check the most up-to-date information available on your regional web or channel. For whatever reasons a part number change is made, it will not be noted on the printed Service Guide. For ACER AUTHORIZED SERVICE PROVIDERS, your Acer office may have a DIFFERENT part number code from those given in the FRU list of this printed Service Guide. You MUST use the local FRU list provided by your regional Acer office to order FRU parts for repair and service of customer machines.

NOTE: To scrap or to return the defective parts, you should follow the local government ordinance or regulations on how to dispose it properly, or follow the rules set by your regional Acer office on how to return it.

TravelMate 5330 Series Exploded Diagram

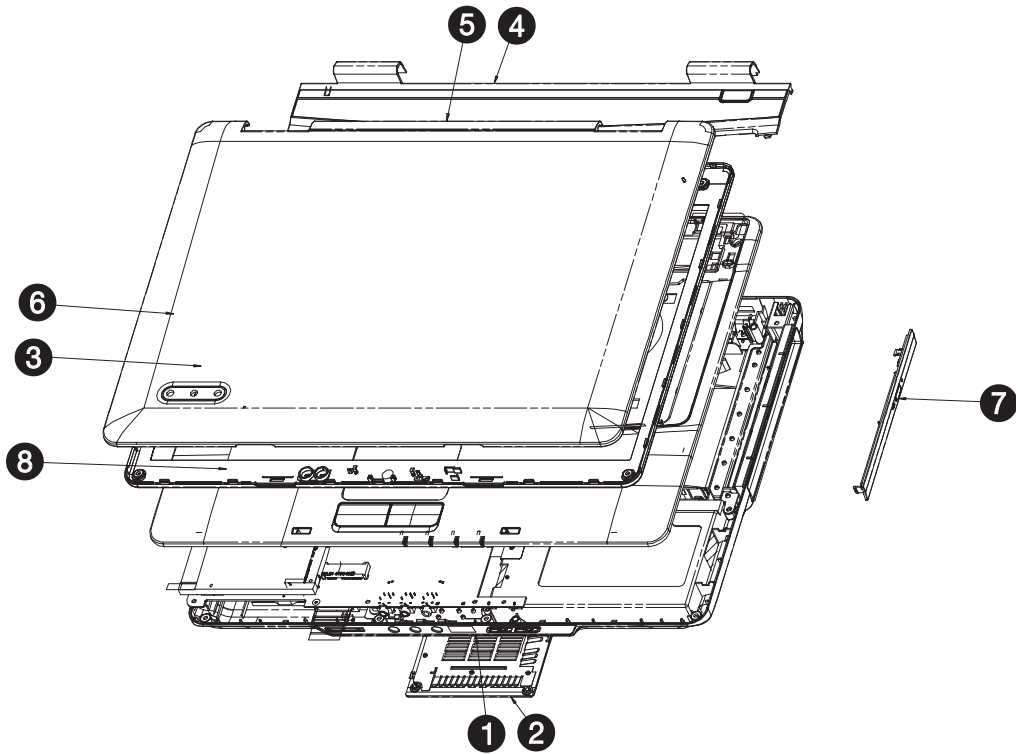

NO	PART NO	DESCRIPTION	Q'TY	REV	REMARK
1	60.4Z401.001	TBD	1	0A	
2	60.4Z402.001	TBD	1	0A	
3	60.4Z404.001	60.4Z404.001	1	0A	
4	60.4Z405.001	ASSY MIDDLE COVER HDMA	1	0A	
5	60.4Z406.001	Homa LCD Panel Assy	1	0A	
6	60.4Z408.001	Homa LCD Bezel Assy	1	0A	
7	60.4Z431.001	ASSY DVD BEZEL Blu-Ray	1	0A	
8	HD_A_MB_AY1	HDMA MB Layout ASSY	1	0A	

TravelMate 5330 Series FRU List

Category	No.	Part Name and Description	Acer Part No.
ACCESSORY			
		REMOTE CONTROLLER FORMOSA21 RC804V-B EN	RT.22700.011
		REMOTE CONTROLLER FORMOSA21 RC804V-B EU	RT.22700.008
Adapter			
		ADAPTER 90W LITEON PA-1900-24AR	AP.09003.011
		ADAPTER 90W DELTA ADP-90SB BBEA LF	AP.09001.013
		ADAPTER 90W 3PIN DELTA ADP-90SB	AP.09001.014
		ADT 90W 19V 3P HP-OL093B13P LF	AP.0900A.001
		ADAPTER 65W 3PIN DELTA SADP-65KB BFJA LF	AP.06501.014
		ADAPTER 65W LITEON PA-1650-02AC LF	AP.06503.016
		ADAPTER 65W HIPRO HP-OK065B13 LF	AP.0650A.010
		ADAPTER 65W DELTA SADP-65KB DFA LF	AP.06501.013
Battery-			
		SANYO AS-2007B LI-ION 3S2P SANYO 6 CELL 4400MAH	BT.00603.042
		SONY AS-2007B LI-ION 3S2P SONY 6 CELL 4400MAH	BT.00604.025
		PANASONIC AS-2007B LI-ION 3S2P PANASONIC 6 CELL 4400MAH	BT.00605.021
		SIMPLO AS-2007B LI-ION 3S2P PANASONIC 6 CELL 4400MAH	BT.00607.016
		SIMPLO AS-2007B LI-ION 4S2P PANASONIC 8 CELL 4800MAH	BT.00807.015
Boards			
		EIGER AUDIO BD 07629-2M (D)	55.AR501.001
		EIGER PD E KEY BD (D)	55.AR501.006
		EIGER PD LAUNCH BD (D)	55.AR501.002
		EIGER PD POWER BD (D)	55.AR501.007
		EIGER PD USB BD WITH TV (D)	55.AQE01.001
		TOUCHPAD SYNAPTICS TM00540-001	56.AGV01.001
		BT MOD FOXCONN BCM2045 V2	BT.21100.005
		WLAN 802.11ABGN SHIRLEYPEAK1*2	KI.SPM01.003
		BIWA MINI SENSOR BD 07522-2M	55.TKJ01.001
		EIGER PD FP BD WITH MINI (D)	55.AQ301.002
		TV TUNCER DVB-T MINI TT-1260DA	TU.23100.015
		CAPACITIVE BUTTON TM-01119-001	55.AR501.005
		MODEM BOARD FOXCONN DELPHI-AM5 V2H 1.5_3.3V	FX.22500.022

Category	No.	Part Name and Description	Acer Part No.
Cables			
		LAUNCH BOARD CABLE	50.AR501.002
		MEDIA BOARD CABLE	50.AR501.005
		TOUCHPAD BOARD CABLE	50.AR501.006
		USB BOARD CABLE	50.AR501.003
		BLUETOOTH BOARD CABLE	50.AR501.007
		AUDIO BOARD CABLE	50.AR501.001
		DC-IN CABLE 90W	50.AQ301.001
		TV TUNER BOARD CABLE	50.AQE01.001
		TOUCHPAD BUTTON BOARD CABLE	50.AR501.004
		DC-IN CABLE 65W	50.AR501.008
		LCD/CAMERA CABLE 15.4" WXGA	50.AR501.009
		POWER CORD 10A 125V US	27.T30V1.001
		POWER CORD 10A 125V 3PIN US BK	27.01518.641
		POWER CORD 2.5A 125V 8121- USA/ W CNS	27.01518.781
		POWER CORD 220V 3PIN EUR	27.T30V1.004
		POWER CABLE 16A 250V 3PIN EUR UK	27.01518.731
		POWER CORD 3A 250V 3PIN UK	27.01518.541
		POWER CORD 5A 250V 3PIN UK BK	27.03118.001
		POWER CORD 10A 3PIN BK DENMARK	27.01518.561
		POWER CORD 10A 250V 3PIN DENMARK BK	27.01518.671
		POWER CORD 10A 250V 3PIN BK SOUTH AFRICA	27.01518.571
		POWER CORD 16A 250V SOUTH AFRICA BK	27.01518.681
		POWER CORD 10A 250V SWISS	27.01518.581
		POWER CORD 10A 250V 3PIN SWISS BK	27.01518.691
		POWER CORD 10A 250V 3PIN CHINA	27.01518.591
		POWER CORD 10A 250V 3PIN CHINA BK	27.01518.701
		POWER CORD 10A 250V 3PIN ITALY	27.01518.611
		POWER CORD 10A 250V 3PIN ITALY BK	27.01518.711
		POWER CORD 2.5A 250V SOUTH AFRICA BK (INDIA)	27.01518.631
		POWER CORD 10A 250V SOUTH AFRICA BK (INDIA)	27.01518.721
		POWER CORD 2.5A 250V AUSTRALIA	27.01518.621
		POWER CORD ACA/ACNZ	27.03218.021
		POWER CORD 7A 125V 2PIN JAPEN	27.01518.551
		POWER CORD 7A 125V 2PIN JAPAN	27.03518.161
		POWER CORD 7A 250V 2PIN KOREA	27.01518.531
		POWER CORD 250V 10A 3PIN ISRAEL	27.01518.761
Case/Cover/Bracket/Assembly			

Category	No.	Part Name and Description	Acer Part No.
		LOWER CASE W/MODEM CABLE&FAN BRACKET&SPEAKER FOR TV	60.AQE01.001
		SPEAKER SUB WOFFER	23.AR501.001
		SPEAKER SET	23.AR501.002
		EXPRESS DUMMY CARD	42.AR501.004
		NEW CARD DUMMY CARD	42.TK901.005
		SD DUMMY CARD	42.TK901.006
		MIDDLE COVER	42.AR501.001
		UNITLOAD COVER	42.AR501.002
		E-KEY COVER	42.AR501.003
		TOUCHPAD BRACKET	33.AR501.001
		VGA BOARD BARCKET FOR NVIDIA	33.TPE01.001
		UPPER CASE W/SPEAKER&E KEY CABLE&POWER CABLE&FINGERPRINT HOLE	60.AQ301.002
		OPTICAL BRACKET	33.AR501.002
		BD COMBO BEZEL	42.AR501.005
		SUPER MULIT BEZEL	42.AGV01.005
		HDD BRACKET	33.AR501.003
		LCD COVER 15.4" W/BACKLIGHT MODULE&ANTENNA	60.AR501.005
		LCD BEZEL 15.4" W/MICROPHONE	60.AR501.004
		LCD BRACKET W/HINGE LEFT	33.AR501.004
		LCD BRACKET W/HINGE RIGHT	33.AR501.005
Combo Module			
		COMBO MODULE BLU-RAY 2X	6M.AR501.001
		ODD SONY BD COMBO 12.7MM TRAY DL 2X BC-5500S LF W/O BEZEL SATA	KO.0020E.002
Communication Module			
		EXTERNAL ANTENNA SET	25.AQE01.001
CPU/Processor			

Category	No.	Part Name and Description	Acer Part No.
		CPU INTEL CELERONM T1600 1.66G 1M 667 DUAL CORE, MV	KC.16001.CMT
		CPU INTEL CELERON 575 PGA 2.0G 1M 667 MV	KC.N0001.575
DVD Module			
		ODD TOSHIBA SUPER-MULTI DRIVE 12.7MM TRAY DL 8X TS-L633A LF W/O BEZEL SATA	KU.00801.021
		ODD PIONEER SUPER-MULTI DRIVE 12.7MM TRAY DL 8X DVR-TD08RS LF W/O BEZEL SATA	KU.00805.044
		ODD PANASONIC SUPER-MULTI DRIVE 12.7MM TRAY DL 8X UJ-870A LF W/O BEZEL SATA	KU.00807.059
		ODD HLDS SUPER-MULTI DRIVE 12.7MM TRAY DL 8X GSA-T50N LF W/ O BEZEL SATA	KU.0080D.029
		ODD HLDS SUPER-MULTI DRIVE 12.7MM TRAY DL 8X GSA-T50N LF W/ O BEZEL SATA MALAYSIA	KU.0080D.034
		ODD SONY SUPER-MULTI DRIVE 12.7MM TRAY DL 8X AD-7560S LF W/O BEZEL SATA	KU.0080E.009
		ODD PLDS SUPER-MULTI DRIVE 12.7MM TRAY DL 8X DS-8A2S LF W/O BEZEL SATA	KU.0080F.001
Fan			
		FAN SUNON	23.AR501.003
Heatsink			
		CPU HEATSINK AVC NB9 W/O FAN	60.AQ301.003
HDD/Hard Disk Drive			

Category	No.	Part Name and Description	Acer Part No.
		HDD 120GB 5400RPM SATA II HGST HTS542512K9SA00 BRONCO-B LF	KH.12007.014
		HDD 120GB 5400RPM SATA SEAGATE ST9120817AS LF	KH.12001.032
		HDD 120GB 5400RPM SATA TOSHIBA MK1246GSX LF	KH.12004.007
		HDD 120GB 5400RPM SATA WD WD1200BEVS-22UST0 ML125 LF	KH.12008.019
		HDD 160GB WD WD1600BEVT-22ZCT0	KH.16008.022
		HDD 160GB 5400RPM SATA II HITACHI HTS541616J9SA00 LF	KH.16007.016
		HDD 160GB SEAGATE SATA ST9160827AS	KH.16001.029
		HDD 160GB 5400RPM SATA TOSHIBA MK1646GSX LF	KH.16004.002
		HDD 250GB SEAGATE SATA ST9250827AS	KH.25001.011
		HDD 250GB 5400RPM SATA TOSHIBA MK2546GSX LF	KH.25004.001
		HDD 250GB 5400RPM SATA II HGST HTS542525K9SA00 LF	KH.25007.011
		HDD 250GB 5400RPM SATA WD WD2500BEVS-22UST0 ML125	KH.25008.018
		HDD 320GB 5400RPM SATA WD WD3200BEVT-22ZCT0 ML125	KH.32008.013
	Keyboard		
		KEYBOARD 14_15KB-FV3 BLACK E88KS US INTERNATIONAL (ASPIRE BLACK)	KB.INT00.442
		KEYBOARD 14_15KB-FV3 BLACK E88KS US INTERNATIONAL HEBREW (ASPIRE BLACK)	KB.INT00.443
		KEYBOARD 14_15KB-FV3 BLACK E89KS UK (ASPIRE BLACK)	KB.INT00.444
		KEYBOARD 14_15KB-FV3 BLACK E89KS TURKISH (ASPIRE BLACK)	KB.INT00.445
		KEYBOARD 14_15KB-FV3 BLACK E88KS THAILAND (ASPIRE BLACK)	KB.INT00.446
		KEYBOARD 14_15KB-FV3 BLACK E89KS SWISS/G (ASPIRE BLACK)	KB.INT00.447
		KEYBOARD 14_15KB-FV3 BLACK E89KS SWEDISH (ASPIRE BLACK)	KB.INT00.448
		KEYBOARD 14_15KB-FV3 BLACK E89KS SPANISH (ASPIRE BLACK)	KB.INT00.449
		KEYBOARD 14_15KB-FV3 BLACK 89KS SLO/CRO (ASPIRE BLACK)	KB.INT00.451
		KEYBOARD 14_15KB-FV3 BLACK E88KS RUSSIAN (ASPIRE BLACK)	KB.INT00.452
		KEYBOARD 14_15KB-FV3 BLACK E89KS PORTUGUESE (ASPIRE BLACK)	KB.INT00.453
		KEYBOARD 14_15KB-FV3 BLACK E89KS POLISH (ASPIRE BLACK)	KB.INT00.454

Category	No.	Part Name and Description	Acer Part No.
		KEYBOARD 14_15KB-FV3 BLACK E89KS NORWEGIAN (ASPIRE BLACK)	KB.INT00.455
		KEYBOARD 14_15KB-FV3 BLACK E88KS KOREAN (ASPIRE BLACK)	KB.INT00.457
		KEYBOARD 14_15KB-FV3 BLACK E93KS JAPANESE (ASPIRE BLACK)	KB.INT00.458
		KEYBOARD 14_15KB-FV3 BLACK E89KS ITALIAN (ASPIRE BLACK)	KB.INT00.459
		KEYBOARD 14_15KB-FV3 BLACK E89KS HUNGARIAN (ASPIRE BLACK)	KB.INT00.462
		KEYBOARD 14_15KB-FV3 BLACK E88KS GREEK (ASPIRE BLACK)	KB.INT00.463
		KEYBOARD 14_15KB-FV3 BLACK E89KS GERMAN (ASPIRE BLACK)	KB.INT00.464
		KEYBOARD 14_15KB-FV3 BLACK E89KS FRENCH (ASPIRE BLACK)	KB.INT00.465
		KEYBOARD 14_15KB-FV3 BLACK E89KS DUTCH (ASPIRE BLACK)	KB.INT00.467
		KEYBOARD 14_15KB-FV3 BLACK E89KS DANISH (ASPIRE BLACK)	KB.INT00.468
		KEYBOARD 14_15KB-FV3 BLACK E89KS CZECH (ASPIRE BLACK)	KB.INT00.469
		KEYBOARD 14_15KB-FV3 BLACK E88KS TRADITIONAL CHINESE (ASPIRE BLACK)	KB.INT00.470
		KEYBOARD 14_15KB-FV3 BLACK E89KS CANADIAN FRENCH (ASPIRE BLACK)	KB.INT00.471
		KEYBOARD 14_15KB-FV3 BLACK E89KS BRAZILIAN PORTUGUESE (ASPIRE BLACK)	KB.INT00.472
		KEYBOARD 14_15KB-FV3 BLACK E89KS BELGIUM (ASPIRE BLACK)	KB.INT00.473
		KEYBOARD 14_15KB-FV3 BLACK E88KS ARABIC/ENGLISH (ASPIRE BLACK)	KB.INT00.474
		KEYBOARD 14_15KB-FV3 BLACK E89KS ARABIC/FRENCH (ASPIRE BLACK)	KB.INT00.475
		KEYBOARD 14_15KB-FV3 BLACK E89KS NORDIC (ASPIRE BLACK)	KB.INT00.476
		KEYBOARD 14_15KB-FV3 BLACK E89KS ENGLISH/CANADIAN FRENCH (ASPIRE BLACK)	KB.INT00.477
LCD Module			
		LCD CMO 15.4" WXGA GLARE N154I3-L03 LF 220NIT 8MS	LK.1540D.022
		LCD AUO 15.4" WXGA GLARE B154EW02-V7 W/O BRACKET, H/W CODE 3A LF 220NIT 8MS	LK.15405.028
		LCD AUO 15.4" WXGA GLARE B154EW08-V1 W/O BRACKET, HW 3A LF 220NIT 8MS	LK.15405.029
		LCD LPL 15.4" WXGA GLARE LP154WX4-TLB4 LF 220NIT 8MS	LK.15408.029

Category	No.	Part Name and Description	Acer Part No.
MAINBOARD			
		MAINBOARD HOMA_2 INTEL GL40 ICH9 LF W/RTC BATTERY&MODEM&MODEM CABLE W/O FINGER PRINT	MB.TRM01.001
MEMORY			
		SODIMM 1GB DDRII667 HYNIX HYMP112S64CP6-Y5 LF	KN.1GB0G.012
		SODIMM 1GB DDRII667 SAMSUNG M470T2864QZ3-CE6	KN.1GB0B.016
		SODIMM 1GB DDRII667 INFINEON HYS64T128021EDL-3S LF	KN.1GB02.036
		SODIMM 1GB DDRII667 NANYA NT1GT64U8HB0BN-3C LF (0.09U)	KN.1GB03.014
		SODIMM 2GB DDRII667 ELPIDA EBE21UE8ACUA-6E-E LF	KN.2GB09.001
		SODIMM 2GB DDRII667 HYNIX HYMP125S64CP8-Y5 LF	KN.2GB0G.004
		SODIMM 2GB DDRII667 SAMSUNG M470T5663QZ3-CE6 LF	KN.2GB0B.003
		SODIMM 2GB DDRII667 MICRON MT16HTF25664HY-667E1 LF	KN.2GB04.001
		SODIMM 512MB DDRII667 HYNIX HYMP164S64CP6-Y5 LF	KN.5120G.024
		SODIMM 512MB DDRII667 NANYA NT512T64UH8B0FN-3C LF	KN.51203.032
		SODIMM 512MB DDRII667 SAMSUNG M470T6464QZ3-CE6 LF	KN.5120B.026
MISCELLANEOUS			
		NAME PLATE AS5930	47.AR501.001
		LOGO PLATE FOR LCD PANEL	47.AR501.002
SCREW			
		IMS M2X4(H=0.3)	86.00E13.524
		SCREW M2*L3 NYLOK CR 3+	86.00E25.723
		SCREW M2-3	86.9A522.3R0
		ISO M2.5X6(H=0.7~0.8MM)	86.00E12.536
		M2.5*L10 BLACK ZN	86.00F84.73A
		SCREW MACH WAFER M3*L4 NI	86.9A524.4R0

Model Definition and Configuration

Extensa 5230/5630Z and TravelMate 5330 Series

Please double click the icon below for model definition and configuration.



Test Compatible Components

This computer's compatibility is tested and verified by Acer's internal testing department. All of its system functions are tested under Windows® XP Home, Windows® XP Pro environment.

Refer to the following lists for components, adapter cards, and peripherals which have passed these tests. Regarding configuration, combination and test procedures, please refer to the TravelMate 5330/Exensa 5230/5630Z series Compatibility Test Report released by the Acer Mobile System Testing Department.

Microsoft® Windows® Vista Environment Test

Item	Specification
CRT Port Test	
CRT Monitor	Acer 211c 21", ViewSonic G220F, ViewSonic PF790 19"
LCD Monitor	Acer FP751 17" TFT LCD, Acer AL1521, Acer AL1721, ViewSonic VD201b, Westinghouse W37G, HP LP2065, HP S9500
Projector	Dell 3300MP
USB Port Test	
USB Keyboard/Mouse	Microsoft Natural Keyboard Pro Dell USB Keyboard Logicool USB Mouse (OWCM-USB) Logitech USB Wheel Mouse Logitech First Wheel Mouse Dell by Logitech Dell Internet Navigator Keyboard Dell Smart Card Keyboard HP USB Optical Austin Mouse Belkin Miniglow Optical USB Mouse HP USB Optical Mouse (RB129AA)
USB Speaker/Joystick	Aiwa Multimedia Digital Speaker (SC-UC78) Panasonic USB Speaker EAB-MPC57USB
USB Storage Drive	Iomega USB Zip 250MB Transcend 80G HDD Plextor DVD+R/RW LG DVD+R/RW Sony DVD+R/RW
USB Camera	Intel Easy PC Camera (A20953-001) Orange Micro USB 2.0 Web Cam
USB HUB and Others	A TEN UH-204 IOGEAR 4-Port Hub Corega CG-WLUSBST11
USB Printer/Scanner	HP 450WBT Deskjet Printer
USB Flash Drive	Sony Memory Key 128MB Sony Micro Vault Pro USD-5G IBM 128MB Memory Key IBM 512MB Memory Key Apacer Handy Drive Apacer The USB Flash Drive 256MB
USB ODD	Logitech CDRW+DVDROM combo LG DVD+R/RW Sony DVD+R/RW
1394 Camera	Sony DV-TRV10
Access Point 802.11a	Intel Pro/Wireless 5000 NetGear HE 102
Access Point 802.11g	D-Link Building Networks People WiFi Certified a/b/g Wireless 108AG
Access Point 802.11n	Belkin N1MIMO Wireless Router High Performance wireless 802.11n
Bluetooth Device	Sony Ericsson Wireless Headset Sony Ericsson T610 X Bridge Bluetooth Access Point BT300

Item	Specification
PCMCIA Test	
LAN/Modem Card	TDK CardBus Ethernet 10/100 32-Bit CBE-10/100BTX
Storage Card	Hitachi Microdrive 4G
1394 Card	Buffalo 1394 Interface Cardbus (IFC-ILCB/DV)
USB2.0 Card	IBM EtherJet CardBus Adapter 10/100
Wireless Lan Card (Not recommended for wireless ready model)	Cisco Wireless LAN Card 802.11a NETGEAR Wireless LAN card 802.11a
ISDN Card	Toshiba Type B for Bluetooth 128K ISDN Card
GPRS Card	Vodafone QL1ACC-21581 3G/GPRS card Sony Ericsson GC83 GPRS card Sony Ericsson GC89 GPRS card
ExpressCard Test	
Express Card	Abcom 5-in-1 Adapter ExpressCard Reader Abcom GigaLan ExpressCard Sunix ECF2400 2 Ports 1394A ExpressCard
Memory Card Test (SD/MS/MMC/SM/CF/Microdrive/XD)	
SD Card	Apacer 128/256MB SanDisk 256MB Apacer 2GB (150x Hi-Speed) KINGMAX 1GB (66x Hi-Speed) SanDisk 1GB RiDATA 4GB SD PRO Memory Card
MS Card	Sony 512 MS PRO Lexar 512MB MS PRO Lexar 1GB MS PRO Sony 2GB MS PRO
MMC Card	SanDisk 32MB Transcend 64/128MB Transcend 256MB SanDisk RS-MMC 128MB PQI RS-MMC 256MB Transcend 512MB A-DATA Turbo 200X 2GB MMC Card
XD Card	Apacer 256/512MB SanDisk 2GB Olympus 512MB
CF Card	Apacer 256/512 SanDisk 2GB

Online Support Information

This section describes online technical support services available to help you repair your Acer Systems.

If you are a distributor, dealer, ASP or TPM, please refer your technical queries to your local Acer branch office. Acer Branch Offices and Regional Business Units may access our website. However some information sources will require a user i.d. and password. These can be obtained directly from Acer CSD Taiwan.

Acer's Website offers you convenient and valuable support resources whenever you need them.

In the Technical Information section you can download information on all of Acer's Notebook, Desktop and Server models including:

- Service guides for all models
- User's manuals
- Training materials
- Bios updates
- Software utilities
- Spare parts lists
- TABs (Technical Announcement Bulletin)

For these purposes, we have included an Acrobat File to facilitate the problem-free downloading of our technical material.

Also contained on this website are:

- Detailed information on Acer's International Traveller's Warranty (ITW)
- Returned material authorization procedures
- An overview of all the support services we offer, accompanied by a list of telephone, fax and email contacts for all your technical queries.

We are always looking for ways to optimize and improve our services, so if you have any suggestions or comments, please do not hesitate to communicate these to us.

A

AFLASH Utility 48
Antennas 100
Audio 33

B

Battery Pack 56
BIOS 29
 vendor 29
 Version 29
BIOS Utility 37–48
 Navigating 38
 Onboard Device Configuration 43
 Security 41, 42
 System Security 47
Board Layout
 Top View 123
brightness
 hotkeys 16

C

caps lock
 on indicator 11
computer
 on indicator 11
CPU 74
CPU Fan True Value Table 29

D

DIMM Module 60
Display 3
display
 hotkeys 16

E

Error Symptom-to-Spare Part Index 108
Euro 17
External CD-ROM Drive Check 104
External Module Disassembly
 Flowchart 55

F

Features 1
Fingerprint Board 84
Flash Utility 48
fpc cable 97
FRU (Field Replaceable Unit) List 127

H

Hard disk 31
Hard Disk Drive Module 63
HDD 31
Hibernation mode
 hotkey 16
Hot Keys 14

I

Indicators 11
Intermittent Problems 121

J

Jumper and Connector Locations 123
 Top View 123

K

Keyboard 33, 71
Keyboard or Auxiliary Input Device Check
 104

L

Launch Board 83
LCD Bezel 94
LCD Brackets 99
LCD Module Disassembly
 Flowchart 93
LCD with the Brackets 96
lower cover 59

M

Main Unit Disassembly
 Flowchart 67
Mainboard 90

media access
 on indicator 11
Memory Check 105
Model Definition 136
Modem Board 87

N

Notebook Manager
 hotkey 16
num lock
 on indicator 11

O

Online Support Information 163

P

Panel 4
 Bottom 10
 left 4
PC Card 11
Power System Check 105
 Battery Pack 107
 Power Adapter 106
Processor 29

S

Screw List 54
speakers
 hotkey 16
System
 Block Diagram 3
System Check Procedures 104
System Memory 29
System Utilities 37

T

Test Compatible Components 159
Top 123
touchpad
 hotkey 16
 using 12
Touchpad Check 107
Troubleshooting 103

U

Undetermined Problems 122
utility
 BIOS 37–48

V

view
 left 7
 rear 9
 right 7

W

Windows 2000 Environment Test 160
WLAN Board 61

Free Manuals Download Website

<http://myh66.com>

<http://usermanuals.us>

<http://www.somanuals.com>

<http://www.4manuals.cc>

<http://www.manual-lib.com>

<http://www.404manual.com>

<http://www.luxmanual.com>

<http://aubethermostatmanual.com>

Golf course search by state

<http://golfingnear.com>

Email search by domain

<http://emailbydomain.com>

Auto manuals search

<http://auto.somanuals.com>

TV manuals search

<http://tv.somanuals.com>