

ATR-120

ACROPRINT

SERVICE MANUAL

ELECTRONIC TIME RECORDER

TABLE OF CONTENTS

- 1. DISASSEMBLY AND REPLACEMENT (#1~ #22)**
- 2. PARTS LIST**
- 3. P.C.B. CIRCUIT DIAGRAM**
- 4. C.P.U BLOCK DIAGRAM AND PIN ASSIGNMENT**
- 5. MEASUREMENT**
 - VOLTAGE CHECK**
 - MOTOR OPERATION CHECK**
 - PRINT HEAD RESISTANCE MEASUREMENT**
 - SENSORS CIRCUIT**
 - CPU OPERATION**

DISASSEMBLY AND REPLACEMENT

1

1. [Remove front case.](#)
2. [Replace quartzose clock.](#)
3. [Replace Ribbon.](#)
4. [Remove Print Head.](#)
5. [Replace Fuse.](#)
6. [Remove back case.](#)
7. [Remove operation Panel block.](#)
8. [Remove the LCD.](#)
9. [Remove the Ribbon Drive Shaft.](#)
10. [Removing to LF reduction gears, mid gear and roller gear.](#)
11. [Removing the paper feed shaft and bearings.](#)
12. [Remove the cam gear, reduction gear, change gear and gear guide.](#)
13. [Remove the ribbon cam.](#)
14. [Remove the lead screw assemblies, platen bearings and lead screw top.](#)
15. [Removing the card inlet and spacer and E-03&E-05 the sensor.](#)
16. [Removing the E-37 sensor.](#)
17. [Removing the E-30 sensor.](#)
18. [Removing the E-38 sensor.](#)
19. [Removing the switch lever and switch lever.](#)
20. [Remove the friction spring, friction shaft and friction roller.](#)
21. [Remove 2000UL PCB assembly.](#)
22. [Load NiCd battery.](#)

1、 Remove front case



1-1



1-2



1-3

- 1.Remove two screws M3×8
- 2.Two press place and push out direction
3. Remove front case

2. Replace quartzose Clock

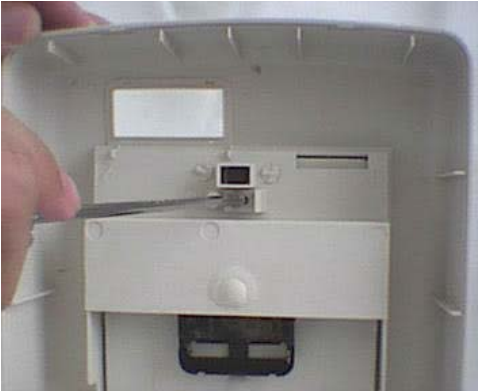

2-1

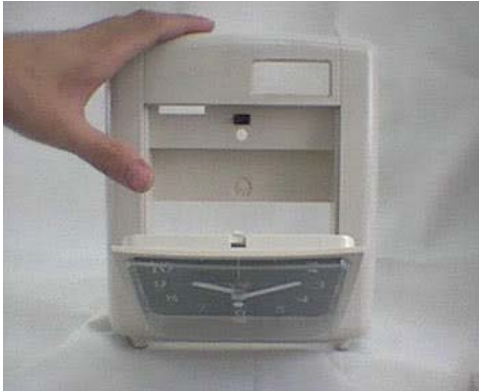

2-2



2-3



2-4



2-5

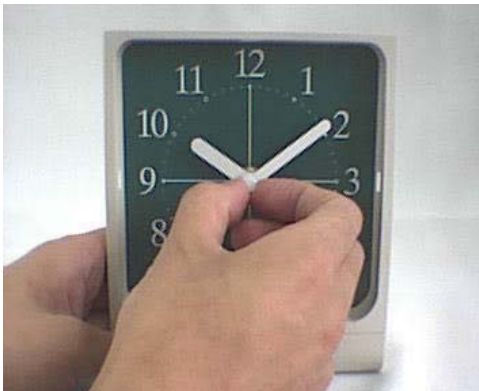

2-6

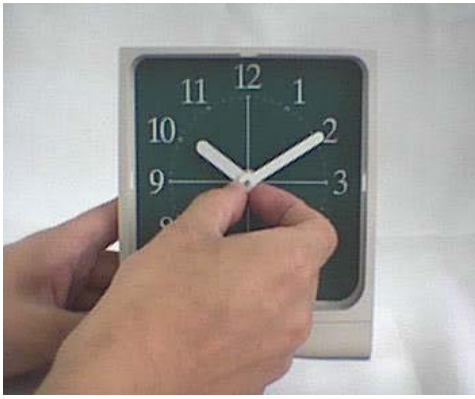

2-7

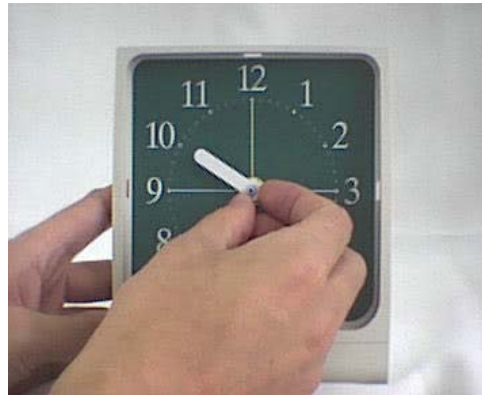

2-8

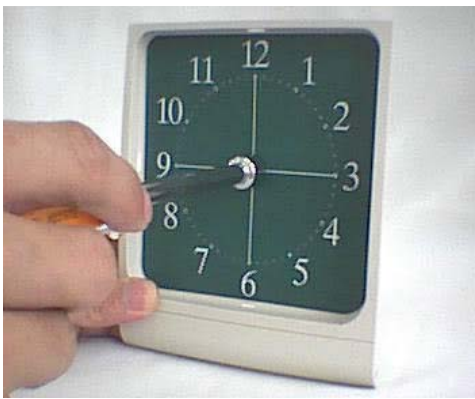

2-9



2-10

1. Remove one screw ST3×7 (2-1)

2. Remove active cover (2-2、 2-3、 2-4)

3. Remove time face Acryl (2-5)

4. Remove second hand (2-6)

5. Remove minute hand (2-7)

6. Remove hour hand (2-8)

7. Remove one screw (2-9)

8. Remove quartzose clock (2-10)

3. Replace Ribbon

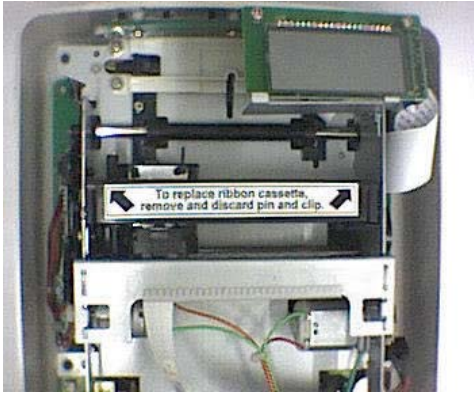

3-1



3-2

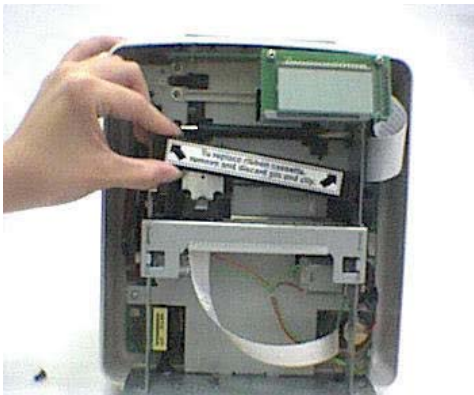

3-3

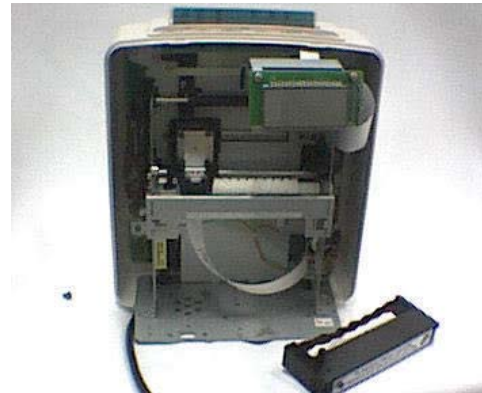

3-4

1. Remove and discard two pin clip. (3-1、3-2)
2. Pull the ribbon cassette by hand. (3-3、3-4)
3. Load new Ribbon
4. Load two pin and clip and front case.

4. Remove Print Head

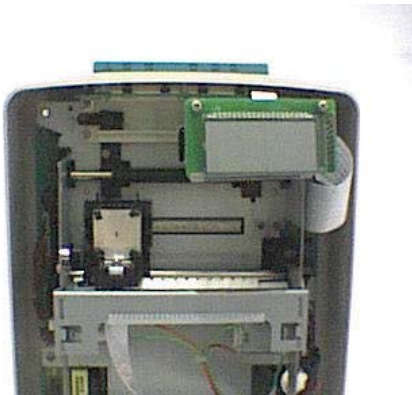

4-1



4-2

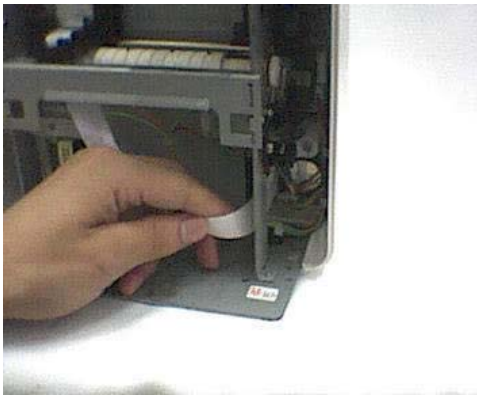

4-3



4-4

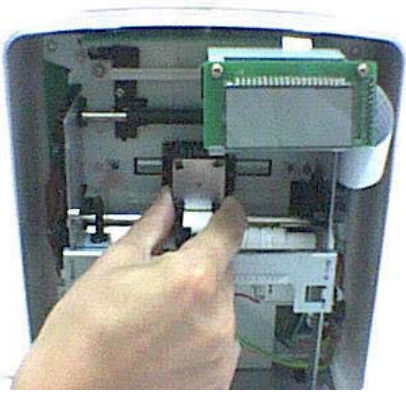

4-5

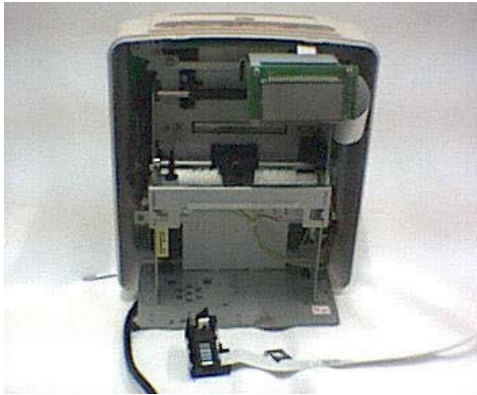

4-6

- 1.Remove the FPC guide using a standard type screwdriver.(4-2)
- 2.Disconnect the FPC cable from the connector (PCN8).(4-3、 4-4)
- 3.Pull the head toward the front by hand. (4-5)
- 4.Left it to remove. (4-6)

5. Replace Fuse

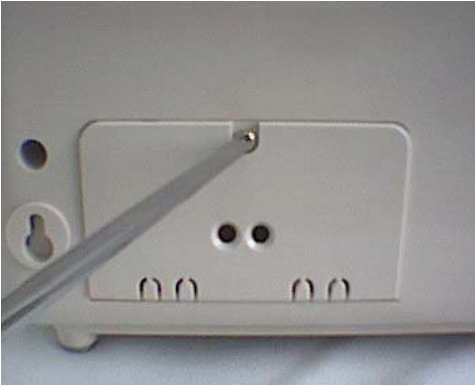

5-1

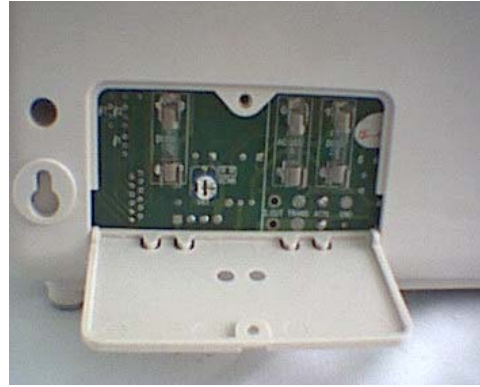

5-2

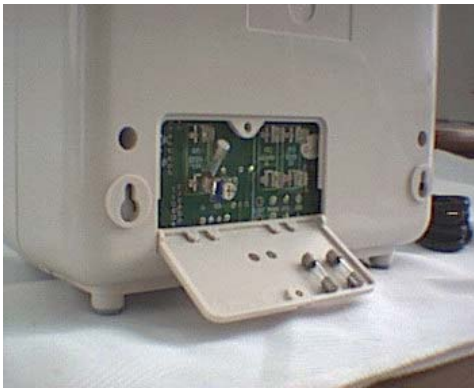

5-3



5-4

- 1.Remove one screw M3×6(5-1)
- 2.Open the small back cover(5-2)
- 3.Remove the damage fuse(5-3)
- 4.Replace a new fuse into right place
- 5.Close the small back cover and install the screw(5-4)

6. Remove back case



6-1



6-2

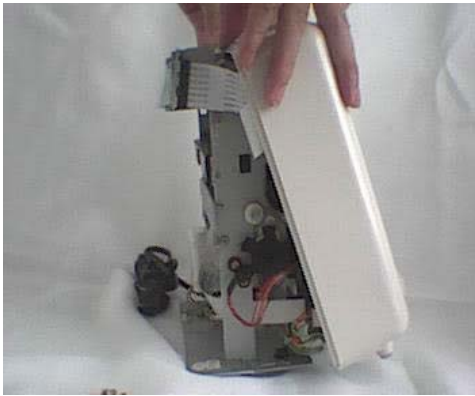

6-3

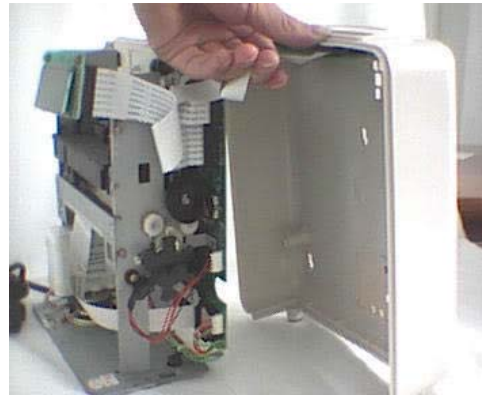

6-4

1.Remove four screws M4×10(6-2)

2.Remove the back case by hand, and disconnect operation panel block cable from the connector on operation panel block.(6-3、 6-4)

7. Remove operation Panel block (7-1)



7-1

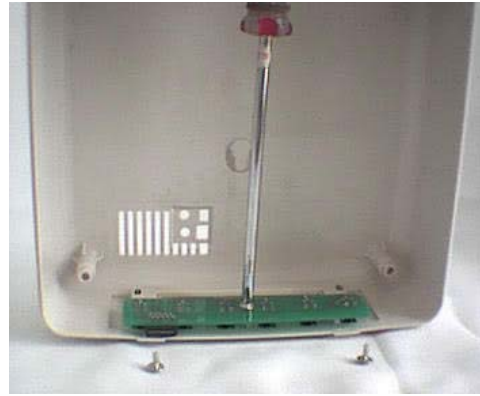

7-2

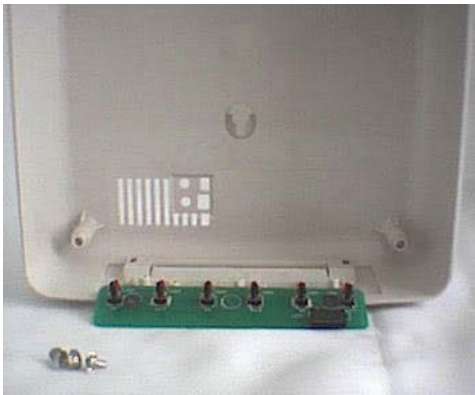

7-3

1.Remove three screws ST3×7。 (7-2)

2.Remove the operation panel block。 (7-3)

8. Remove the LCD

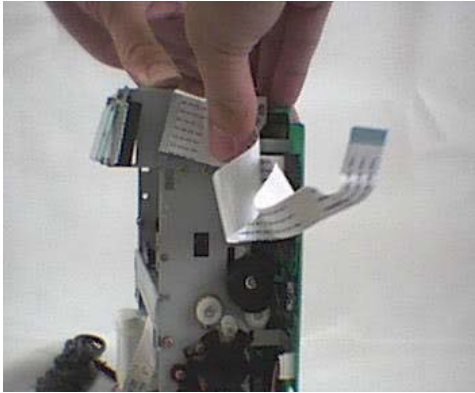

8-1

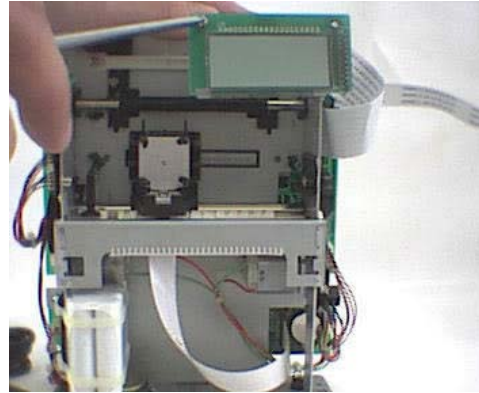

8-2

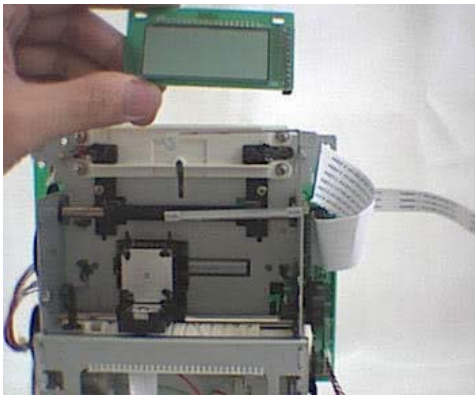

8-3

1. Disconnect the LCD cable from the connector (LCN10) on the 2000UL PCB assembly.(8-1)
2. Disconnect the LCD cable from the connector on the 2003A PCB assembly.(8-1)
3. Remove two screws.(8-2)
4. Remove the LCD.(8-3)

9. Remove the Ribbon Drive Shaft

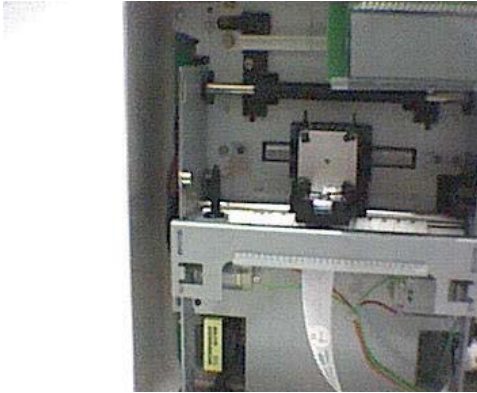

9-1

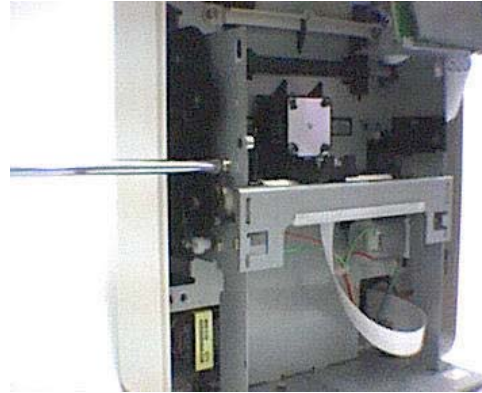

9-2

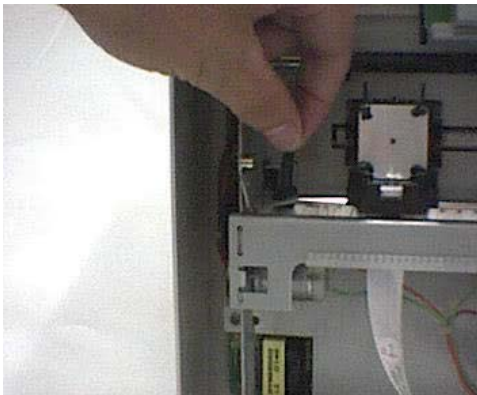

9-3

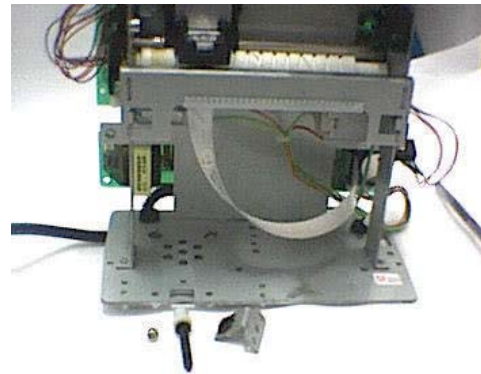

9-4

1.Remove the screw fixing the Ribbon Clutch Holding Plate. (9-2)

2.Remove the Ribbon Drive shaft by hand.(9-3)

10. Removing to LF reduction gears, mid gear and roller gear

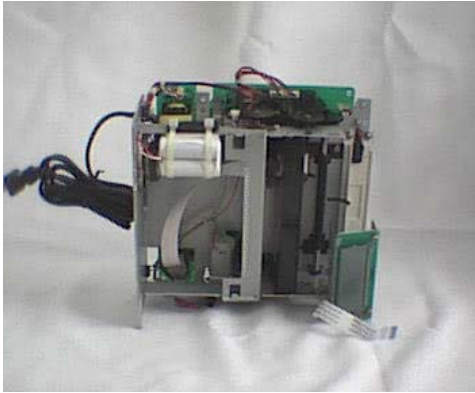

10-1

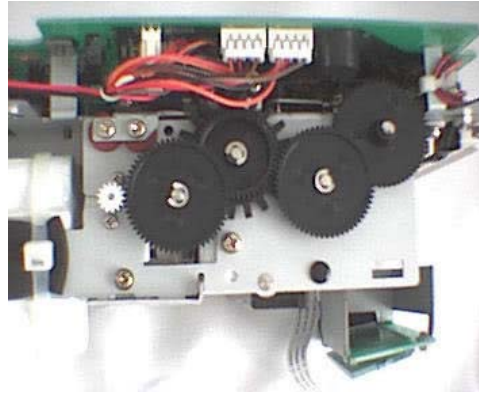

10-2

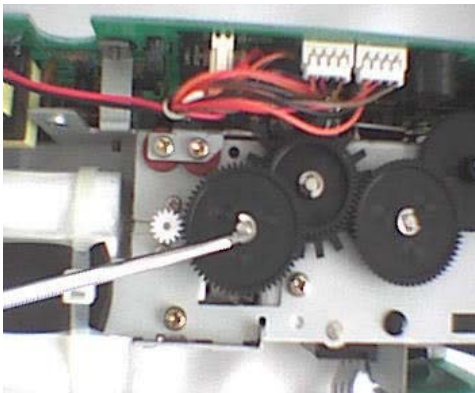

10-3

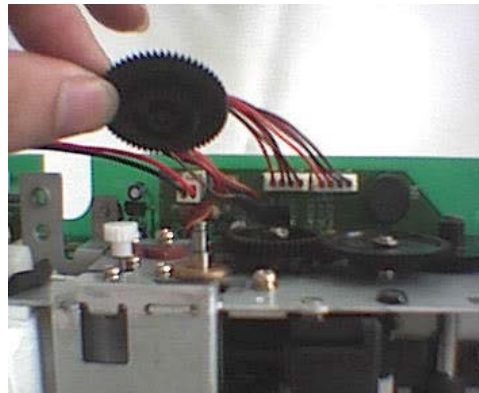

10-4

- 1.Remove three snap rings with a standard type screwdriver.(10-3)
- 2.Pull the two LF reduction gears out of the shaft (Inset a standard type screwdriver into the gap between the LF gear and frame, and lift the gear).(10-4)
- 3.Remove the mid gear in the same manner as shown second step.
- 4.Remove the roller gear in the same manner as shown second step.

11. Removing the paper feed shaft and bearings

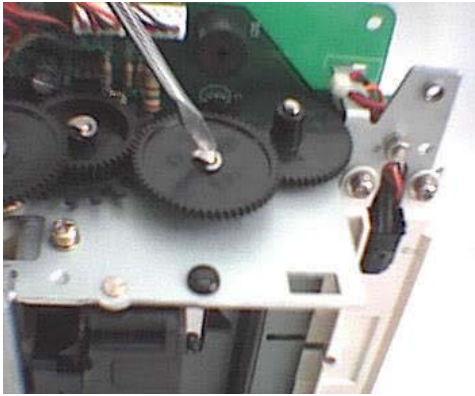

11-1

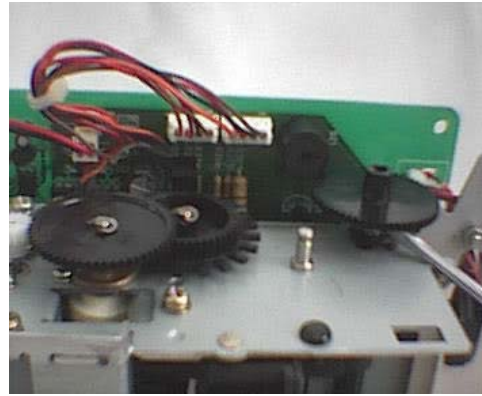

11-2

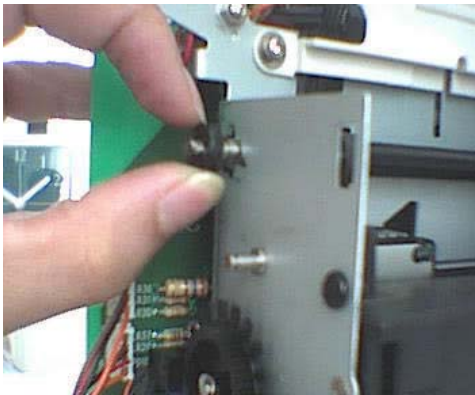

11-3

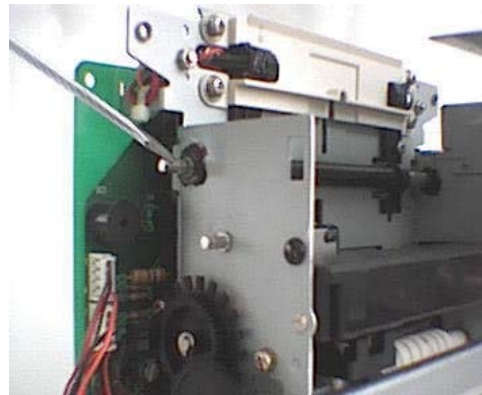

11-4

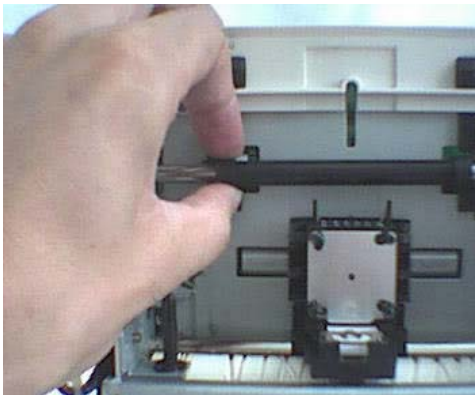

11-5

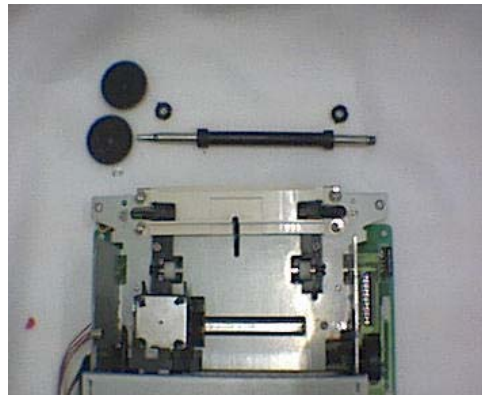

11-6

- 1.Removing the LF Reduction gear.(11-1)
- 2.Removing the Roller gear.(11-2)
- 3.Turn the bearing with small pliers to match up the projections on the bearing with the notches in the frame.(11-3)
- 4.Remove the bearings from the paper feed shaft to outside of the frame (There are two bearings, on the right and left).(11-4)
- 5.Move the paper feed shaft by hand.(11-5)
- 6.Detach it toward the front from inside the frame.(11-6)

12. Remove the cam gear, reduction gear, change gear and gear guide

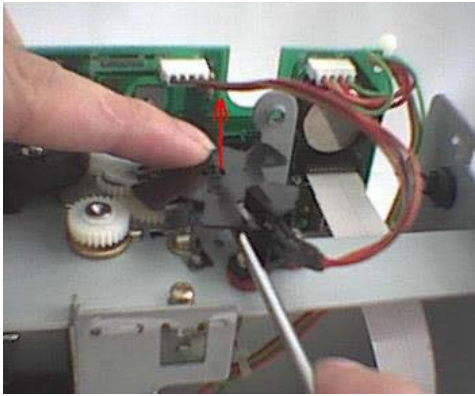

12-1

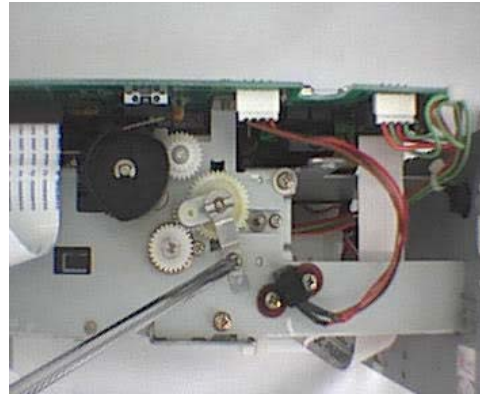

12-2

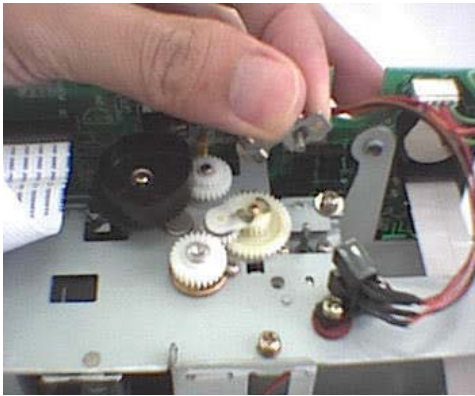

12-3

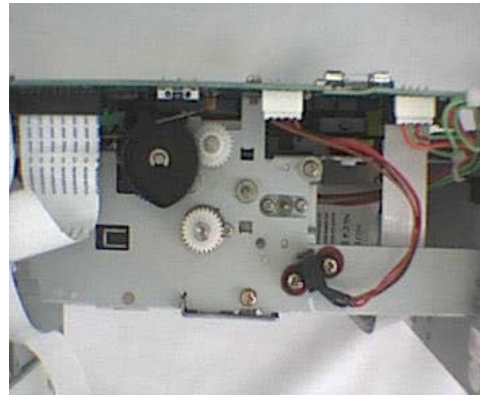

12-4

1.Remove the motor gear.(12-1)

2.Remove one screw to remove the Lever Holding Spring(12-2)

3.Pull the cam gear out of the shaft , Inset a standard type screwdriver into the gap between the cam gear and frame, and left the cam gear. Be careful mot to press the screwdriver against the shaft from the side.

4.Remove the reduction gear in the same as shown in above step. The change gear and gear guide are also remove with the reduction gear.

13. Remove the ribbon cam

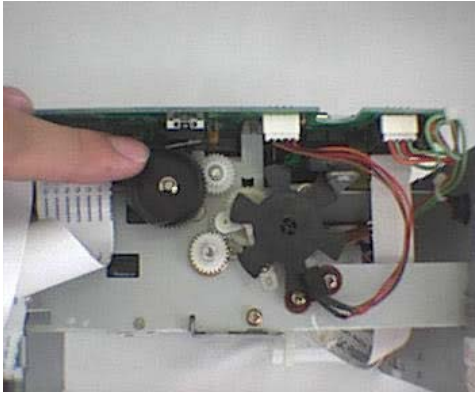

13-1

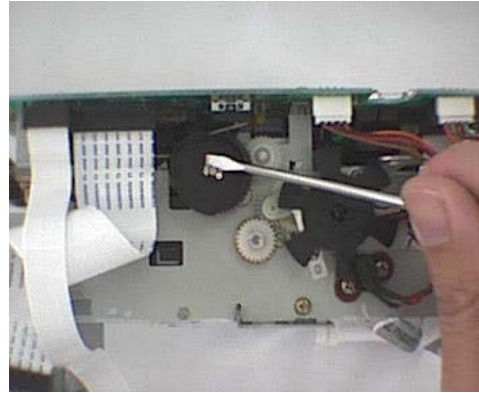

13-2

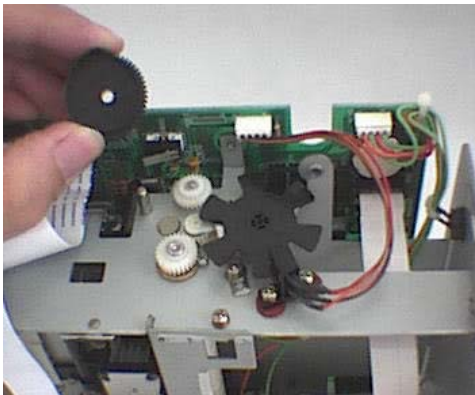

13-3

1. Remove the snap ring with a standard type screwdriver.(13-2)
2. Pull the ribbon cam out of shaft (Inset a standard type screwdriver into the gap between the ribbon cam and frame, and lift the cam. Be careful not to press the screwdriver against the shaft from the side).(13-3)

14. Remove the lead screw assembly, platen bearings and lead screw top

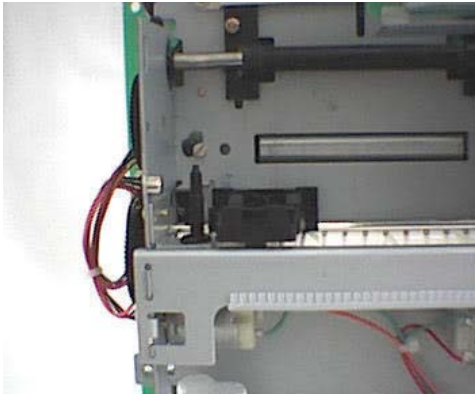

14-1

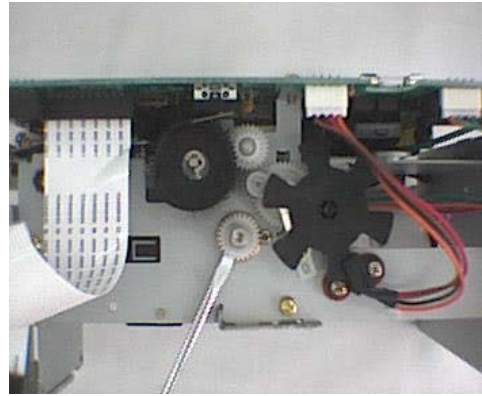

14-2

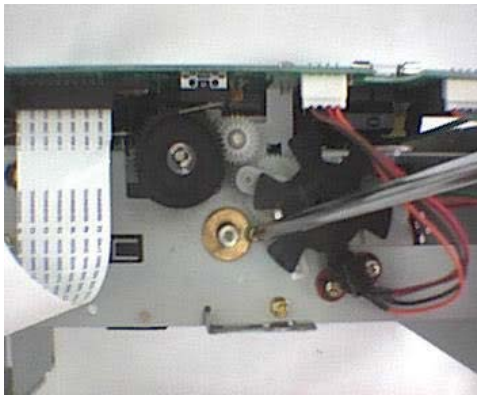

14-3

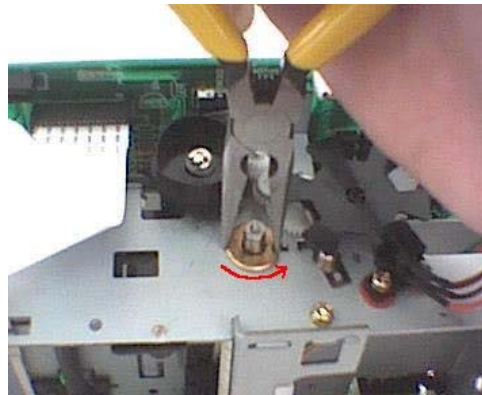

14-4

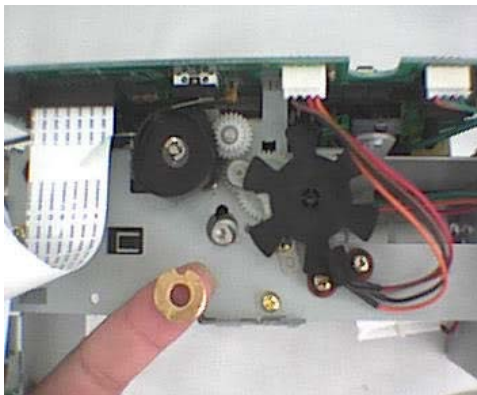

14-5

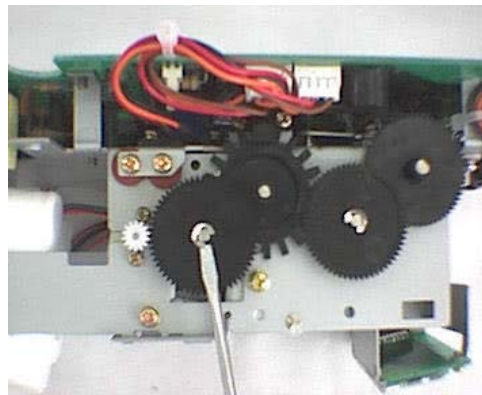

14-6

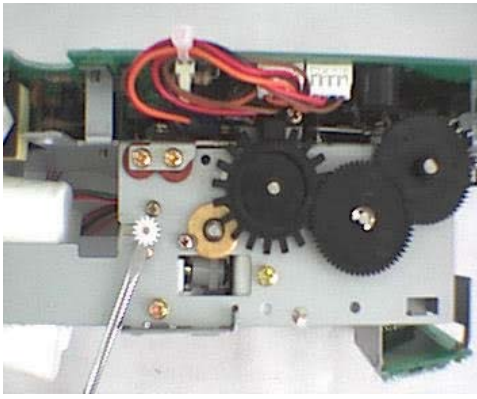

14-7

14-9

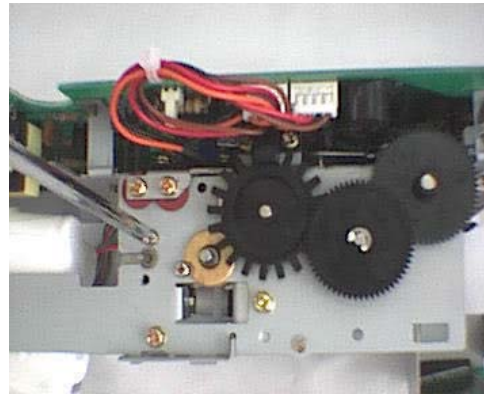

14-8

14-10

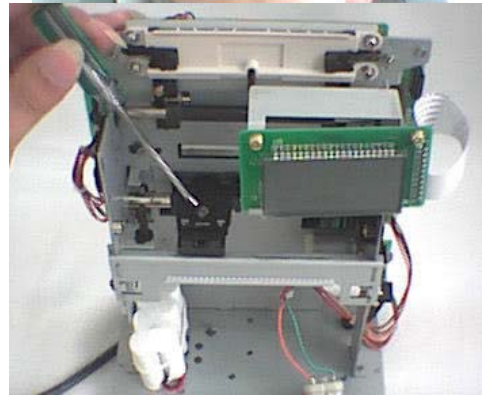
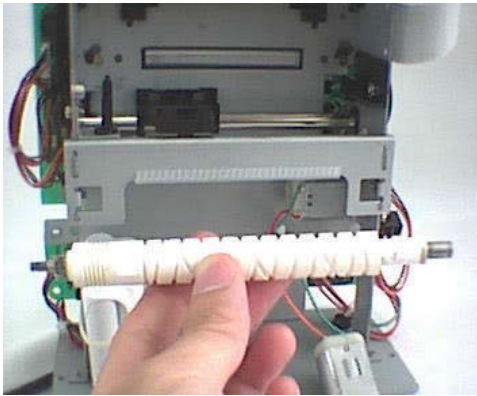
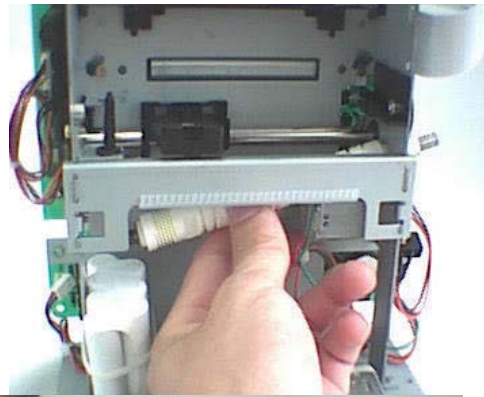
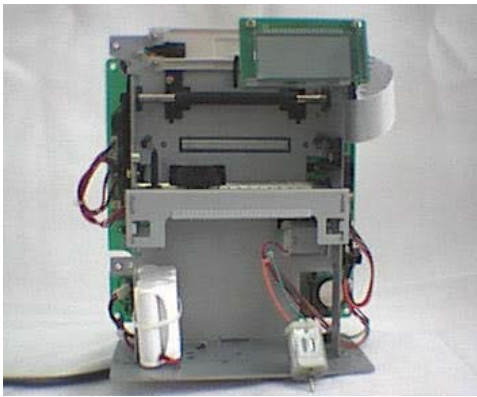

14-11

14-12

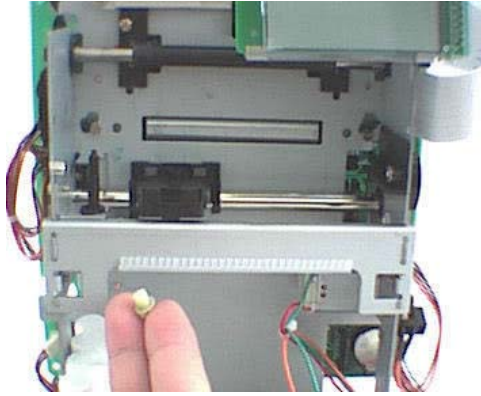

14-13

1. Remove one screw. (14-3)
2. Remove platen bearing whirl stop screw from the right. (14-4, 14-5)
3. Remove the LF gear and the motor gear and two screws to pull out the motor A. (14-6, 14-7, 14-8, 14-9)
3. Remove the lead screw assembly by hand. (14-10, 14-11)
4. Turn the lead screw top to match up the projection on it with the notch in the carrier.
Pull the lead screw top below the carrier. (14-12, 14-13)

15. Removing the card inlet and spacer and E-0305 the sensor

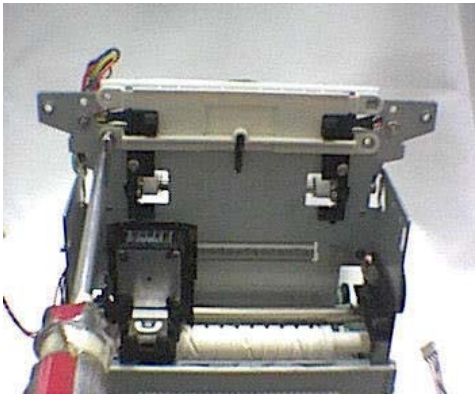

20-1

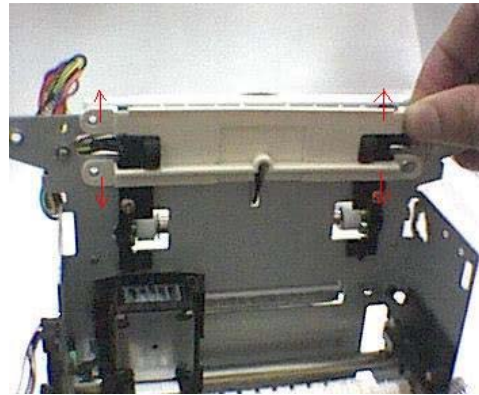

20-2

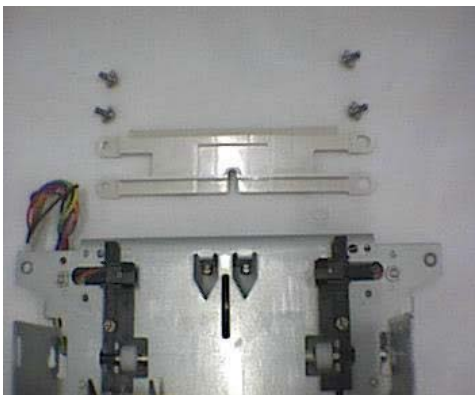

20-3

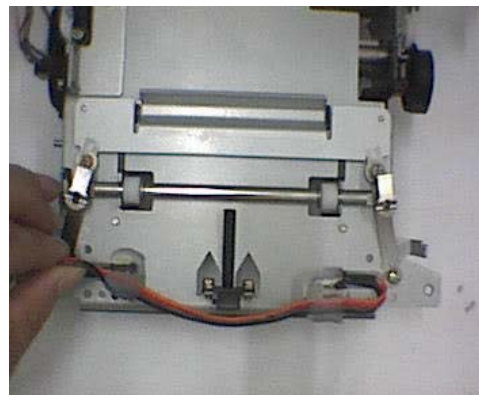

20-4

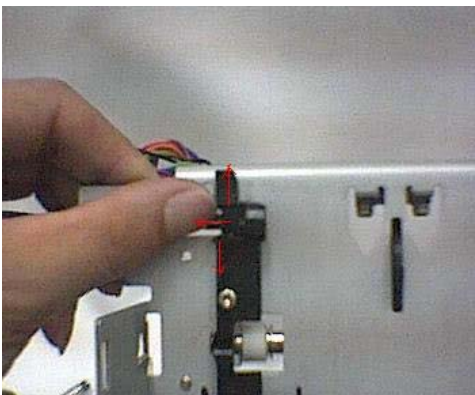

20-5

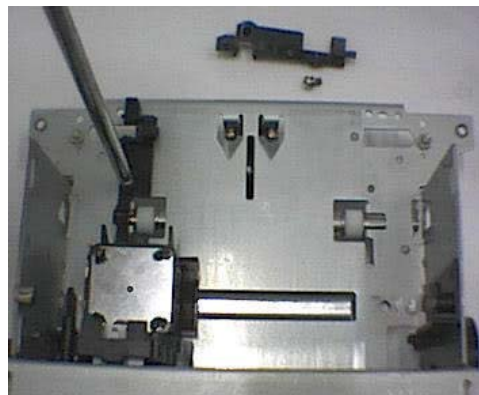

20-6

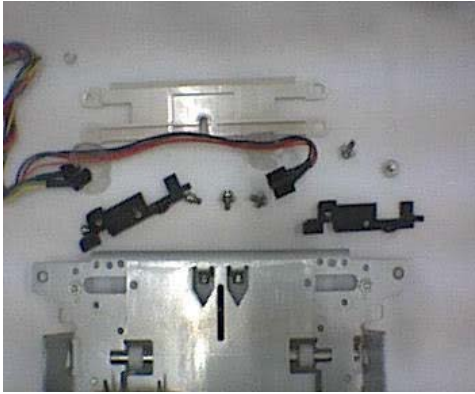

20-7

Remove four screws fixing the card inlet.(20-1)

1. Remove the card inlet by hand.(20-2、 20-3)
2. Press the hooks of the right and left sensors slightly outwards and pull out the E-0305 sensors. Be careful not to break the hooks.(20-4、 20-5)
3. Remove two screws fixing the spacer, and pull out the spacer.(20-6、 20-7)

16. Removing the E-37 sensor

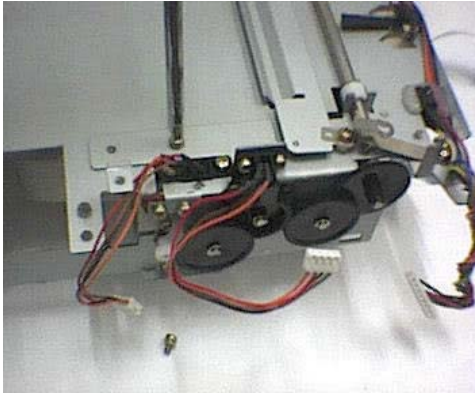

21-1

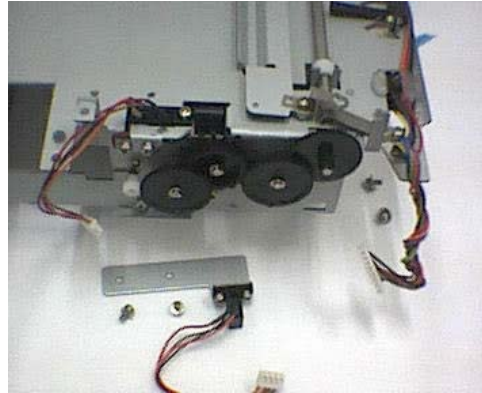

21-2

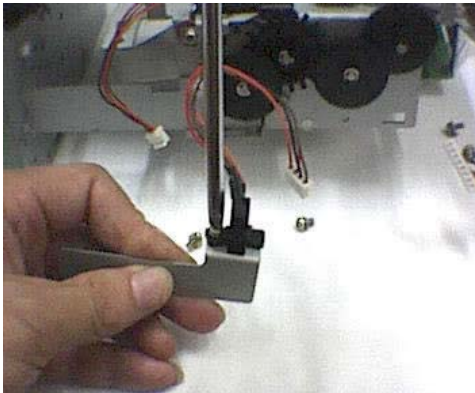

21-3

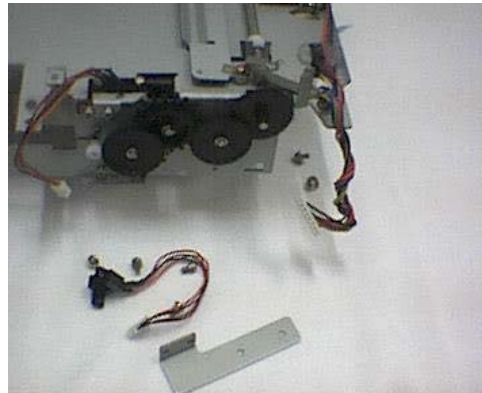

21-4

1.Remove two screws to take out of the sensor holding plate.(21-1、 21-2)

2.Remove another two screws to take out the sensor.(21-3、 21-4)

17. Removing the E-30 sensor

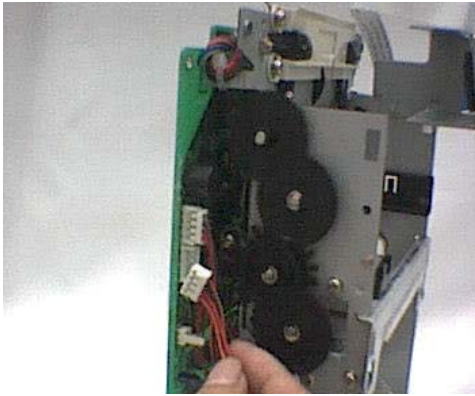

15-1

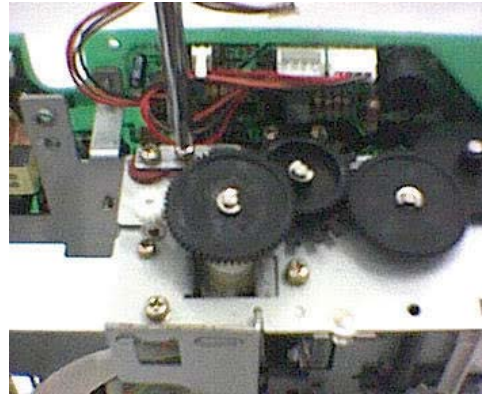

15-2

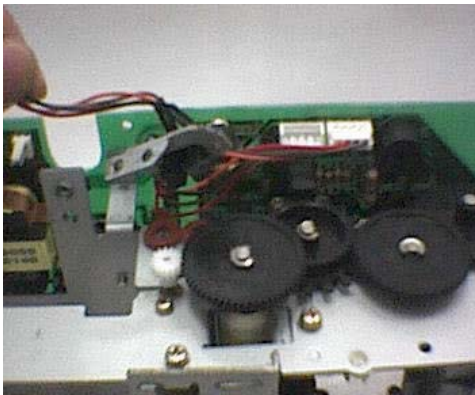

15-3



15-4

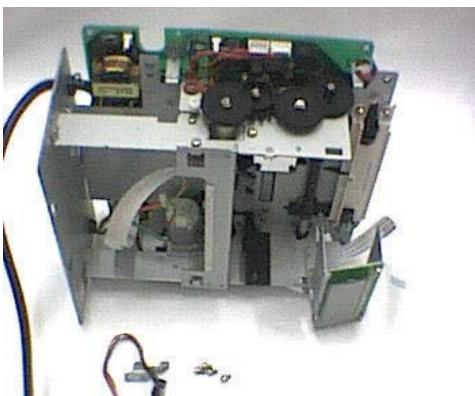

15-5

1. Disconnect the sensor harness assembly from the connector(LCN3)on the 2000UL PCB assembly.(15-1)
2. Remove two screws to take out the screw holding plate.(15-2、 15-3)
3. Remove another two screws to take out the sensor.(15-4、 15-5)

18. Removing the E-38 Sensor

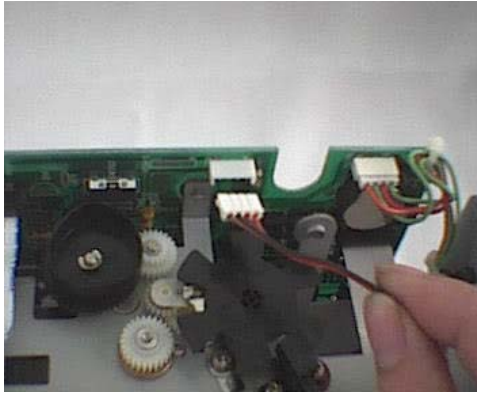

16-1

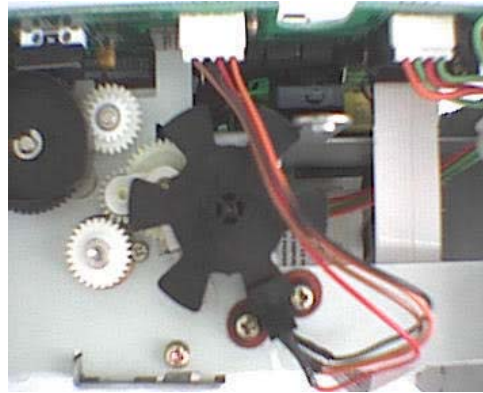

16-2

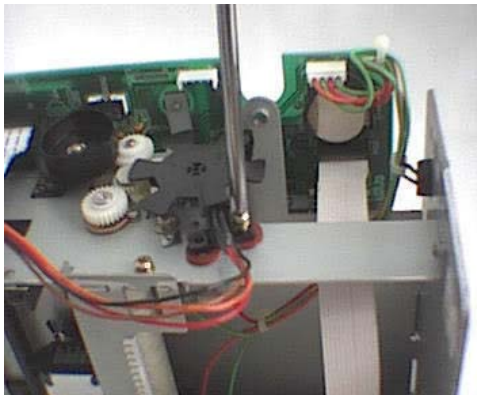

16-3

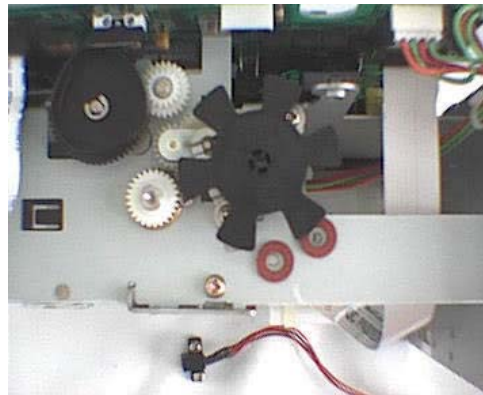

16-4

1. Disconnect the sensor harness assembly from the connector (LCN9) on the 2000UL PCB assembly.

2. Remove two screws (M3 × 8) to take out the sensor.

19. Removing the switch lever and switch lever

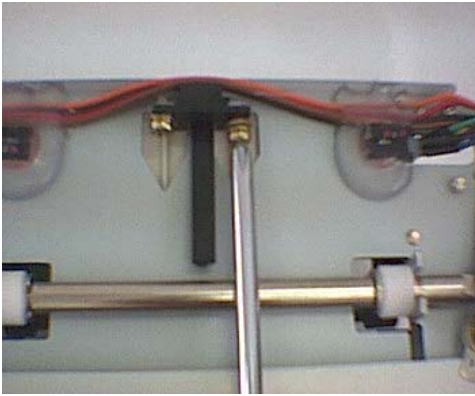

18-1

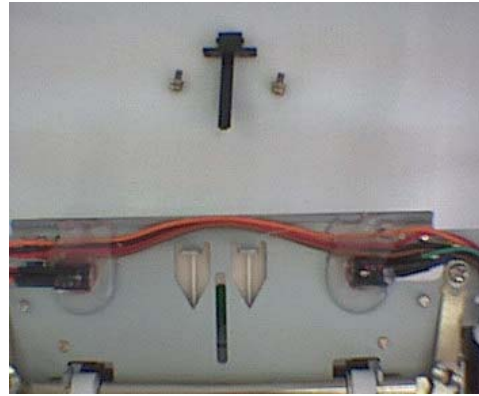

18-2

1. Remove two screws (a) fixing Switch Lever

2. Pull the switch lever out of the snap of switch lever position accurately.

20. Remove the friction spring, friction shaft and friction roller

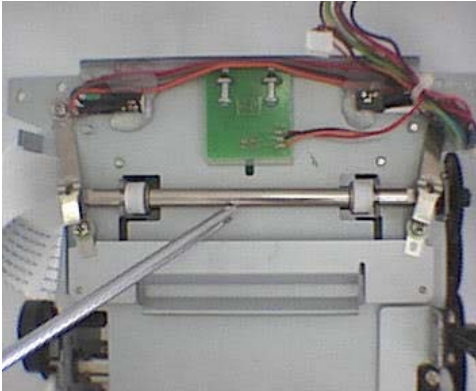

19-1

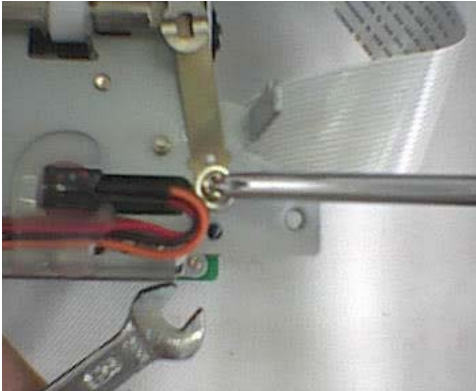

19-2



19-3

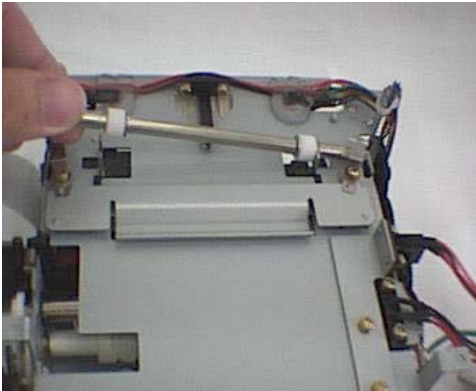

19-4

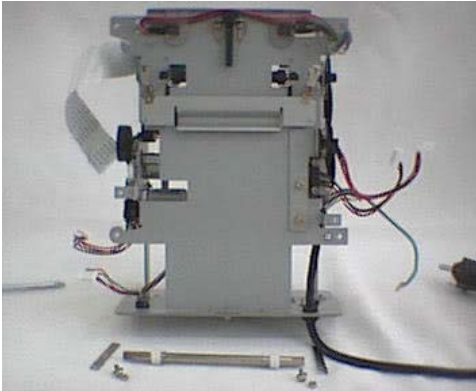

19-5

1. Remove two screws fixing the right and left friction springs to remove the friction springs. The friction shaft and friction roller are also removed.

21. Remove 2000UL PCB assembly

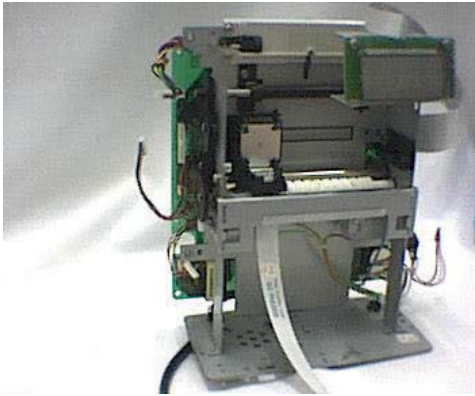

17-1

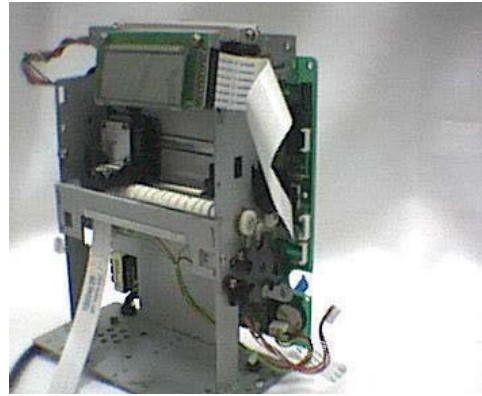

17-2

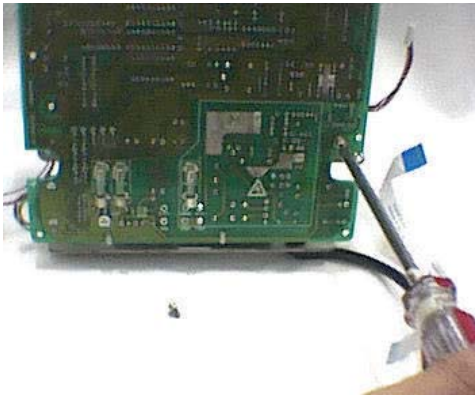

17-3

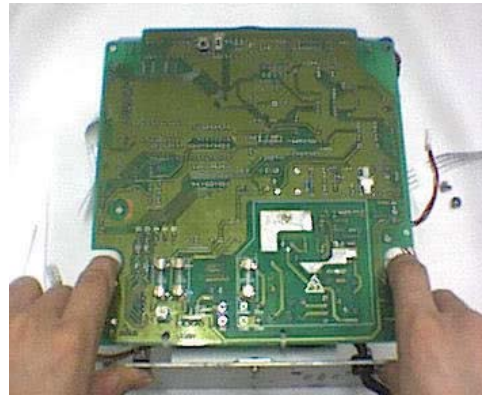

17-4

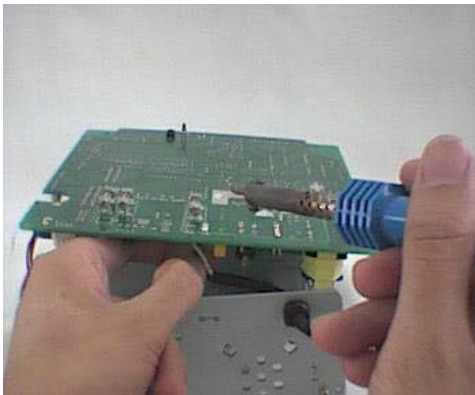

17-5

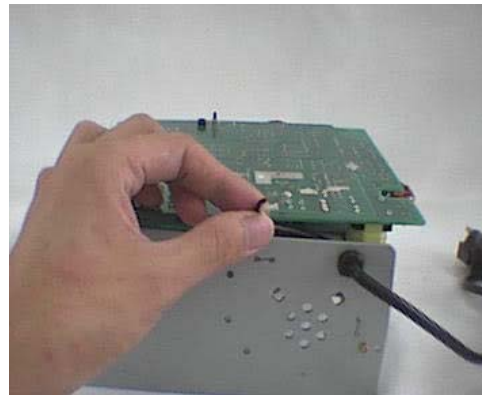

17-6

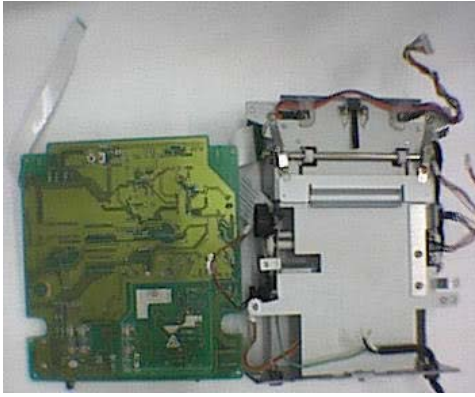

17-7

1. Disconnect all the sensor harness assembly, and LCD cable, and operation black cable, and motor block, and FPC cable from the connectors on the 2000UL PCB assembly (17-1、 17-2)
2. Remove two screws (17-3)
3. Pull out the 2000UL PCB assembly by hand。 (17-4)
4. Solder down the power supply wire to pull out the 2000UL PCB assembly. (17-5、 17-6、 17-7)

22. Load NiCd battery

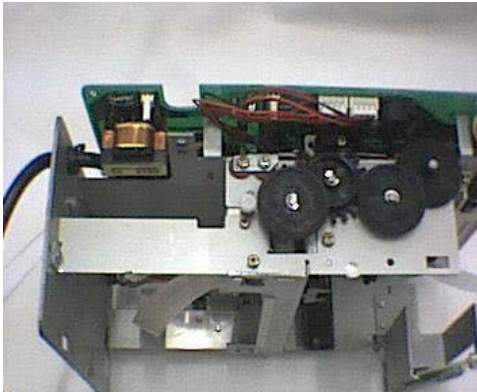

22-1

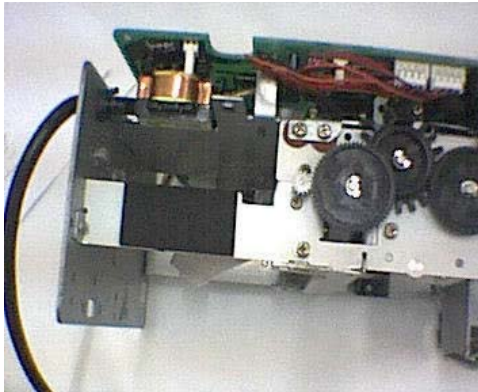

22-2

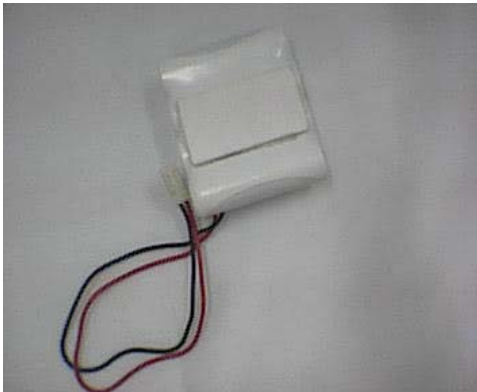

22-3

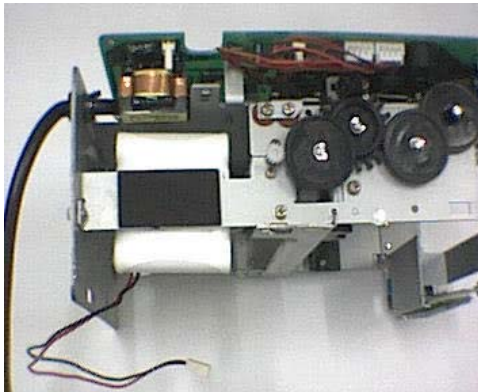

22-4

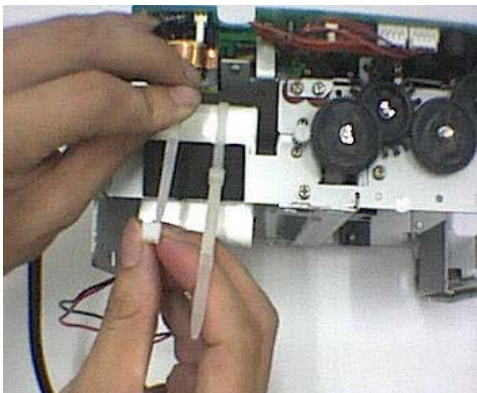

22-5

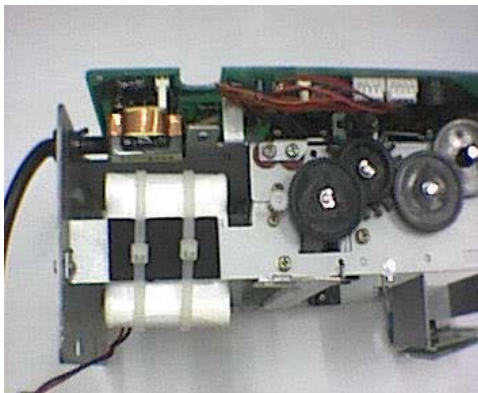

22-6

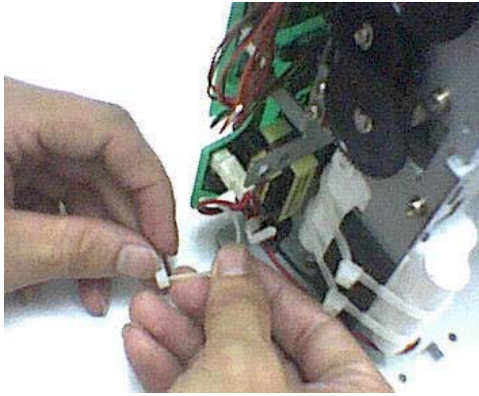

22-7

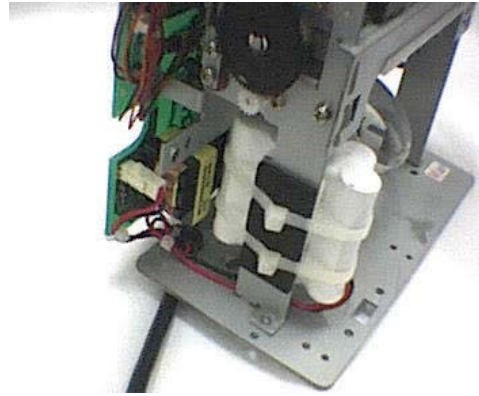

22-8

1. Place black sticker on the main body shelf.
2. Place white both sided sticker on the rechargeable battery.
3. Place rechargeable battery on the main body shelf.
4. Tighten the battery.
5. Tighten the inside wires.

PARTS LIST

Acroprint ATR120 Time recorder BOM

THE ELECTRON COMPONENT					
№	Name	Mode	Place In ATR120	P/N	Remarks
1	Multilayer Ceramic Capacitor	0.1uF/50V	PC21 PC22 PC14		
2	Multilayer Ceramic Capacitor	0.01uF/50V	PC10 LC25 LC38		
3	Multilayer Ceramic Capacitor	1000PF/50V	PC8 PC18 LC29 LC30 LC36		
4	Multilayer Ceramic Capacitor	100PF/50V	LC26 LC28 LC37 LC39 LC40 LC41 LC42 LC43		
5	Ceramic Capacitor	0.1uF/50V	PC19 PC23		
6	Multilayer Ceramic Capacitor	18P/50V 5%	LC33		
7	Multilayer Ceramic Capacitor	15PF/50V 5%	LC34		
8	Multilayer Ceramic Capacitor	30PF/50V 5%	LC31 LC32		
9	Diode	IN4007	PD2 PD3 PD4 PD5 PD6 PD7 PD8 PD11 SD3		
10	Diode	IN4148	LD11 LD12 LD13 PD9		
11	Carbon-Film Fixed Resistor (CR)	16K 1/4W 1%	PR13		
12	Carbon-Film Fixed Resistor (CR)	18K 1/4W 1%	LR39		
13	Carbon-Film Fixed Resistor (CR)	1 M 1/4W 1%	LR26		
14	Carbon-Film Fixed Resistor (CR)	4.7K 1/4W 1%	PR14		
15	Carbon-Film Fixed Resistor (CR)	100K 1/4W 5%	LR19 LR41 LR42 LR76		
16	Carbon-Film Fixed Resistor (CR)	10K 1/4W 5%	LR27 LR32 LR33 LR47 LR49 LR68 BR77		
17	Carbon-Film Fixed Resistor (CR)	10R 1/4W 5%	PR7		
18	Carbon-Film Fixed Resistor (CR)	15K 1/4W 5%	LR20 LR22 LR24 LR28 LR30 LR70		
19	Carbon-Film Fixed Resistor (CR)	1 K 1/4W 5%	PR2 LR45 LR46 LR48 LR50 LR52 LR53 LR54 LR55 LR56 LR57 LR58 LR59 LR60 LR61 LR62 LR63 LR64 LR65 LR66 LR67		
20	Carbon-Film Fixed Resistor (CR)	2.2K 1/4W 5%	PR11 PR15 LR21 LR23 LR25 LR29 LR31 LR69		
21	Carbon-Film Fixed Resistor (CR)	22R 1/4W 5%	PR3		

	Name	Mode	Place In ATR120	P/N	Remarks
22	Carbon-Film Fixed Resistor (CR)	270K 1/4W 5%	LR18		
23	Carbon-Film Fixed Resistor (CR)	33K 1/4W 5%	PR9 PR10		
24	Carbon-Film Fixed Resistor (CR)	620R 1/4W 5%	LR37 LR38 LR44 LR51 LR71		
25	Carbon-Film Fixed Resistor (CR)	820R 1/4W 5%	PR8		
26	Carbon-Film Fixed Resistor (CR)	9.1K 1/4W 5%	LR40 LR72 LR73 LR74		
27	Dynatron	D1866	Q5 Q6 Q7 Q8 Q9 Q10 Q11 Q12 Q13		
28	2000UL PCB				
29	IC	UC3842BN	PU1		
30	Opto-couple	PC817	PU3		
31	SCR	TL431	PU2		
32	IC	TA7291	PU10 PU11		
33	IC	78L05	PU4		
34	IC	74HD404889	LU5	PN NBE-065	
35	IC	HD74HC14P	LU6		
36	IC	HD74HC244P	LU8 LU9		
37	IC	ULN2003	LU7		
38	MOSFET	K2608	PQ1		
39	Bridge-commuted	KBL206	PD1		
40	Dynatron	C1815	Q3 Q4 Q15 Q17 BQ20		
41	Dynatron	C1015	Q18 Q19		
42	X2 Capacitor	0.1UF/275V	PC3		
43	X2 Capacitor	0.33UF/275V	PC1		
44	Ceramic Disc Capacitor	2200PF/500V	PC24		
45	Polyester Film Capacitor	0.047UF/100V	PC9		
46	Aluminum Electrolytic Capacitor	1UF/50V	PC12		
47	Aluminum Electrolytic Capacitor	10UF/16V	LC35		
48	Aluminum Electrolytic Capacitor	47UF/25V	PC7 PC16 PC17		
49	Aluminum Electrolytic Capacitor	100UF/25V	PC15		
50	Aluminum Electrolytic Capacitor	1000UF/25V	PC11		

№	Name	Mode	Place In ATR120	P/N	Remarks
51	Aluminum Electrolytic Capacitor	2200UF/25V	PC13		
52	Aluminum Electrolytic Capacitor	22UF/400V	PC1		
53	Neilsbed	2PIN 180°	PCN1		
54	Neilsbed	4PIN 180°	LCN3 LCN4 LCN8 PCN9		
55	Neilsbed	4PIN 90°	LCN0		
56	Neilsbed	8PIN 90°	LCN5		
57	Flex. PCB Socket	10PIN 180°	LCN12		
58	Flex. PCB Socket	12PIN 180°	PCN7		
59	Flex. PCB Socket	21PIN 180°	LCN10		
60	Carbon-Film Fixed Resistor (CR)	100R 1W 5%	PR16		
61	Carbon-Film Fixed Resistor (CR)	270R 1W 5%	PR12		
62	Carbon-Film Fixed Resistor (CR)	360R 1W 5%	LR35 LR36-1		
63	Carbon-Film Fixed Resistor (CR)	0.5R 2W 5%	PR1		
64	Carbon-Film Fixed Resistor (CR)	51K 2W 5%	PR5		
65	Carbon-Film Fixed Resistor (CR)	270K 2W 5%	PR6		
66	Buzzer	KC-1201	BZ1		
67	Buzzer	XHD	RL1		
68	Crystal	32.768KHZ	LX1		
69	Crystal	4.00MHZ	LX2		
70	Battery Seat	CR2032	PBT1		
71	Fuse	DC12V 2A	PF3		
72	Fuse	DC12V 1.5A	PF1		
73	Fuse	AC240V 1A	PF2		
74	Fuse nip				
75	Line Filter	UU9.8 30mH	PLF1		
76	Filter	47uH			
77	Choke Coil	15uH			
78	Choke Coil	1.5A 48mH	PL1		
79	Transformer	EI-28	PT1		
80	Tact Switch	TS1102P	RESET		
81	Mechanical switch	SW/3P	SW301 SW302		
82	Switch	SW/3P	SW304		

83	Radiating-flake	Model E		
84	Flame Assembly			P/N NBD-980101
85	Plate Soleplate			P/N NBD-980118
86	Switch Lever			P/N NB-008
87	Switch Lever B			P/N NB-015
88	Switch Lever Support			P/N NB-019
89	Paper Feed Shaft			P/N NBD-980108
90	Friction Shaft			P/N NBD-980109
91	Friction Roller			P/N NB-034
92	Friction Spring			P/N NBD-980121
93	Lever Holding Spring	0.4mm		P/N NBD-980113A
94	Lever Holding Spring	0.2mm		P/N NBD-980113B
95	Guide Pillar			P/N NBD-990107
96	Platen Bearing			P/N NBL-980100
97	Lead Screw Assembly			P/N NB-048
98	Carrier			P/N NB-002
99	Lead Screw Top			P/N TW102
100	Platen			P/N NBD-980108
101	FPC Guide			P/N NBD-980117
102	Print Head			P/N YZCP-100
103	Cassette Holding Plate R			P/N NB-006
104	Ribbon Cam Spring			P/N NBD-980125
105	Ribbon Drive Shaft			P/N NB-005
106	Ribbon Clutch Gear			P/N NB-028
107	Ribbon Clutch Spring			P/N NBD-980126
108	Ribbon Clutch Holding Plate			P/N NBD-980106
109	Carrier Auxiliary Board			P/N NB-037
110	Reduction Gear			P/N NB-029
111	Chang Gear			P/N NB-032
112	Gear Guide			P/N NB-037
113	Roller Gear			P/N NB-003
114	Mid Gear			P/N NB-004
115	LF Reduction(A)			P/N NB-017
116	LF Reduction(B)			P/N NB-039

117	Motor Gear			P/N NB-035	
118	Motor Gear			P/N NB-011	
119	Cam Gear			P/N NB-033	
120	Lead Screw Gear			P/N NB-027	
121	Ribbon Cam			P/N NB-013/014	
122	Card Guide(Left)			P/N NB-009	
123	Card Guide(Right)			P/N NB-010	
124	Card Inlet			P/N NB-040	
125	Bearing	big		P/N NB-018	
126	Bearing	small		P/N NB-019	
127	Motor(A)			P/N TW-104	
128	Motor(B)			P/N TW-105	
129	Motor Holding Plate			P/N NBD-980105	
130	Motor Block			P/N NBE-090	
131	E-03, 05Sensor	SG-205		P/N NBE-091	
132	E-30 Sensor	SG-23FF		P/N NBE-092	
133	E-37, 38Sensor	SG-289		P/N NBE-093	
134	Sensor Signal Wire				
135	Sensor Signal Wire				
136	Tubing				
137	Sensor Holding Plate	E-30 Sensor		P/N NDB-980114	
138	Sensor Holding Plate	E-37 Sensor		P/N NDB-980115	
139	Power Supply Wire			P/N NBE-094	
140	Insulating Bushings	5P-4		P/N NBE-095	
141	Insulating Bushings	3F-2		P/N NBE-096	
142	LCD			P/N CDCP-062	
143	LCD Holding Plate			P/N NBD-980104	
144	LCD Cable	170mm		P/N NBE-097	
145	Operation Panel Block			P/N AJCP-064	
146	Operation Panel Block Cable			P/N NBE-098	
147	Cushion(#1)	5.0×3.10×0.13		P/N DP-109	
148	Cushion(#2)	9.0×6.35×0.13		P/N DP-110	
149	Cushion(#3)	9.0×6.35×0.26		P/N DP-111	
150	Cushion(#4)	9.0×6.35×0.50		P/N DP-112	

151	Cushion(#5)	8.5×4.05×0.30		P/N DP-113	
152	Red Cushion	1.0mm		P/N DP-114	
153	Red Cushion	1.6mm		P/N DP-115	
154	Snap Rings			P/N DC-116	
155	Snap Rings			P/N ZC-117	
156	Snap Rings			P/N XC-118	
157	Screws	M3×6 Phillips round head screws with SPW		P/N NB-119	
158	Screws	M3×6 Phillips round head screws with Spring Washer		P/N NB-120	
159	Screws	M3×7 Phillips round head screws with Spring Washer		P/N NB-121	
160	Screws	M3×8 Phillips round head screws with Spring Washer		P/N NB-122	
161	Screws	M3×8 Phillips round head screws with SPW		P/N NB-123	
162	Screws	M2.6×4 Phillips round head screws with Spring Washer		P/N NB-124	
163	Screws	ST3×7		P/N NB-125	
164	Screws	M4×10 Phillips round head screws		P/N NB-126	
165	Screws	M4×8 Phillips round head screws with SPWs		P/N NB-127	
166	Screws	ST4×19		P/N NB-128	
167	Snap rings			NDB-980124	
168	Nut	M3		P/N NB-129	
169	Nut	M4		P/N NB-130	
170	Back Case	ABS765A		P/N NB-044	
171	Back Case Board	ABS765A		P/N NB-001	
172	Explain Label			P/N NB-131	
173	Dust Cover	ABS765A		P/N NB-021	
174	Keyboard film			P/N NB-132	
175	Front Case	ABS765A		P/N NB-045/049/046	
176	Active Cover	ABS765A		P/N NB-042	
177	Time Face Acryl			P/N NB-043	
178	Small Acryl			P/N NB-041	
179	Clock			P/N NB-052	
180	Rubber Cushion			P/N NB-053	
181	Cuprum Cushion			P/N NB-054	
182	Nut			P/N NB-055	
183	Hour Hand	white ATR120		P/N NB-056	
184	Minute Hand	white ATR120		P/N NB-057	

185	Second Hand	white ATR120		P/N NB-058	
186	Clock face Aluminum Board			P/N NB-059	
187	Cell	1.5V		P/N NB-133	
188	button			P/N TW-107	
189	Ribbon			SDCP-101	
190	Underlay			P/N NB-060	
191	Pin and Clip			P/N TW-108	
192	Label			P/N NB-136	
193	Frangibility Label			P/N NB-137	
194	Notebook	ATR120		P/N NB-138	
195	Wall Map			P/N NB-139	
196	8# Bag	250×180		P/N NB-140	
197	0# Bag	70×50		P/N NB-141	
198	Bag	450×360		P/N NB-142	
199	Fix up Holding Plate			P/N NBD-980107	
200	Plastic Thimble			P/N NB-143	
201	battery	3V		P/N NB-134	
	Carton	ATR121		P/N NB-144	
203	Carton	ATR121		P/N NB-145	
204	Environmental Carton			P/N NB-146	
205	Time Card			P/N NB-147	
206	Serial Label			P/N NB-148	

P.C.B. CIRCUIT DIAGRAM

2000lat_sch-1 - Sat May 17 19: 49: 05 2003
2000AA-ATR120

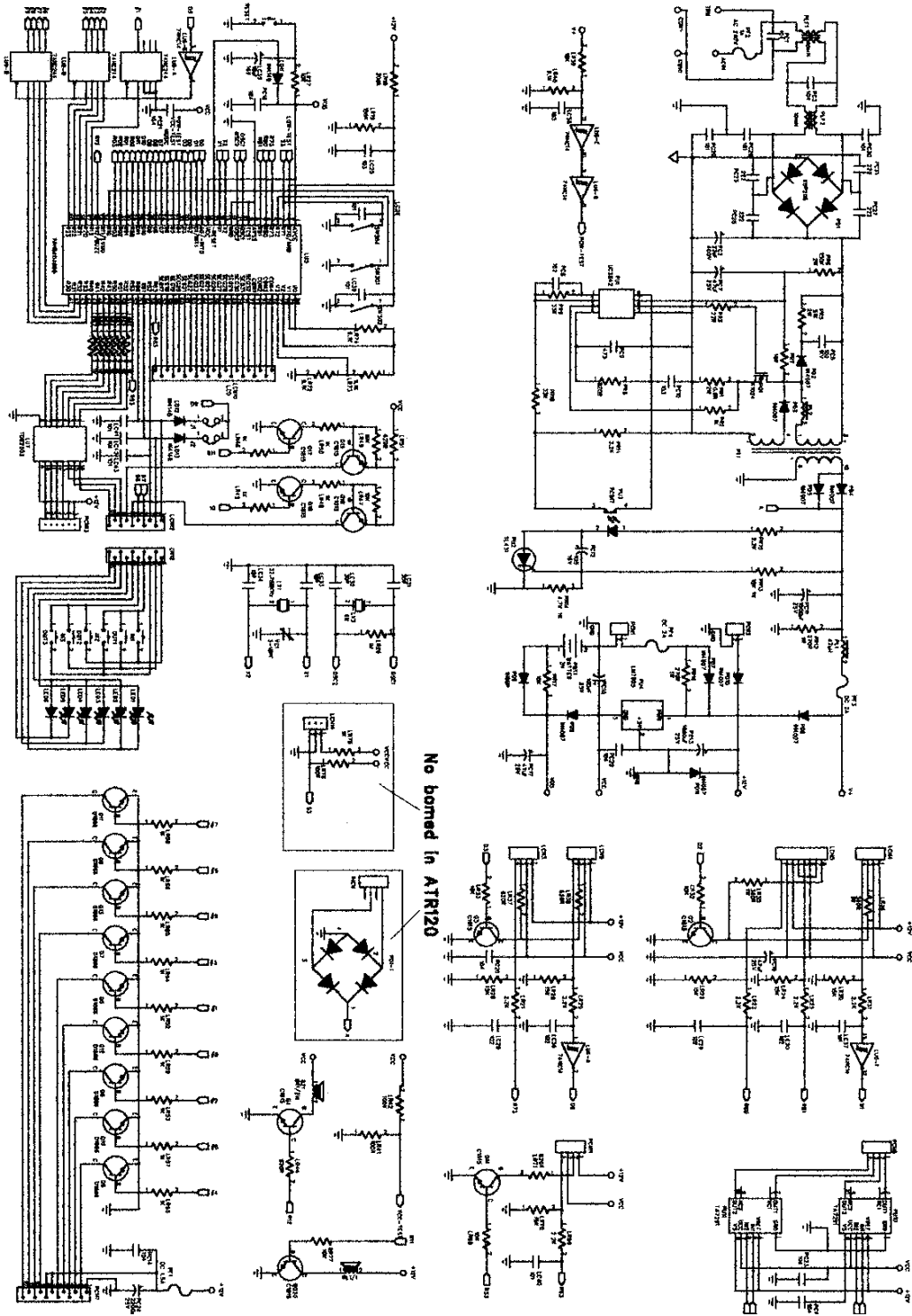

BELOW:

TOP LAYER

BOTTOM LAYER

BOTTOM LAYOUT

TOP LAYOUT

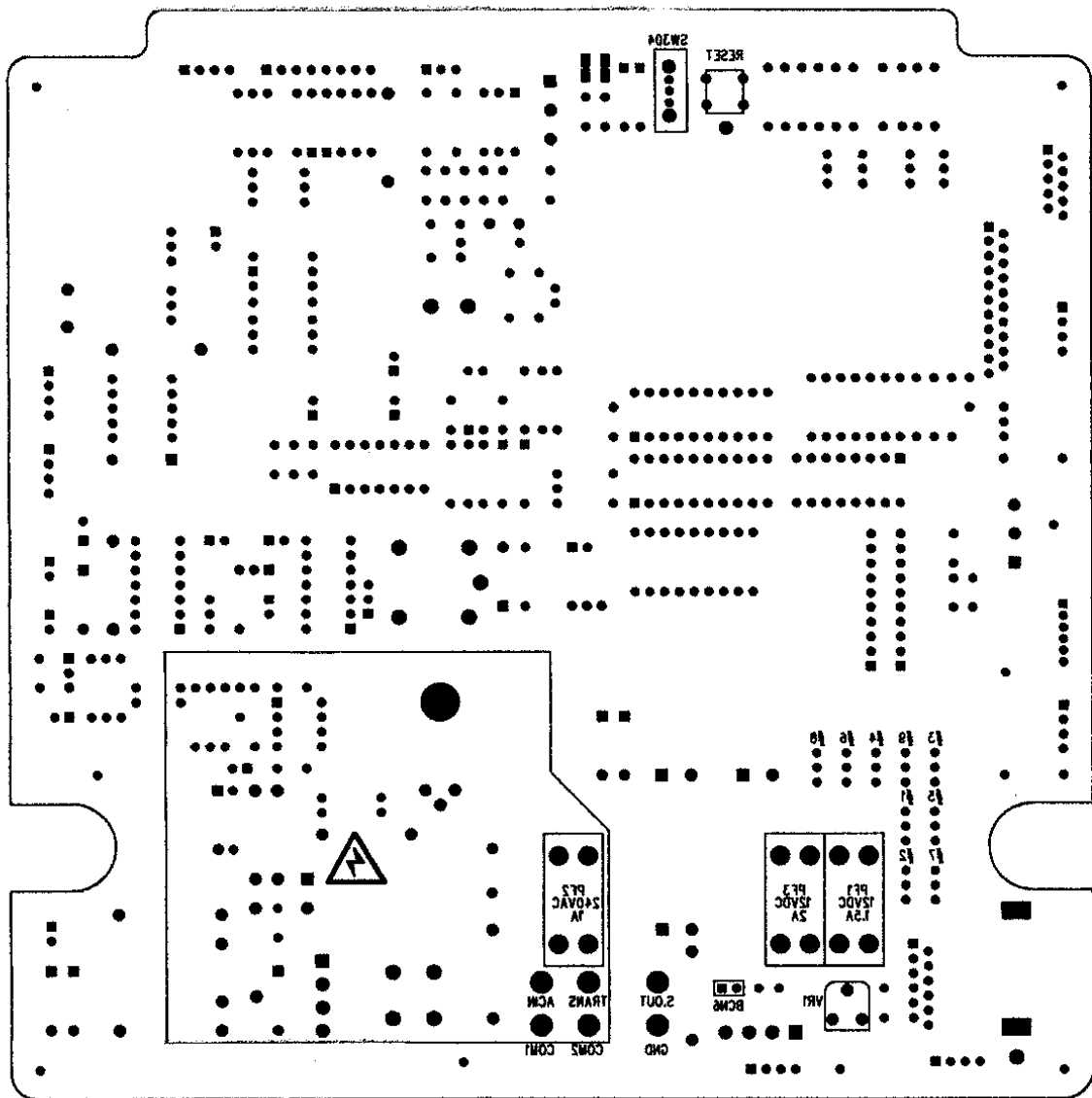

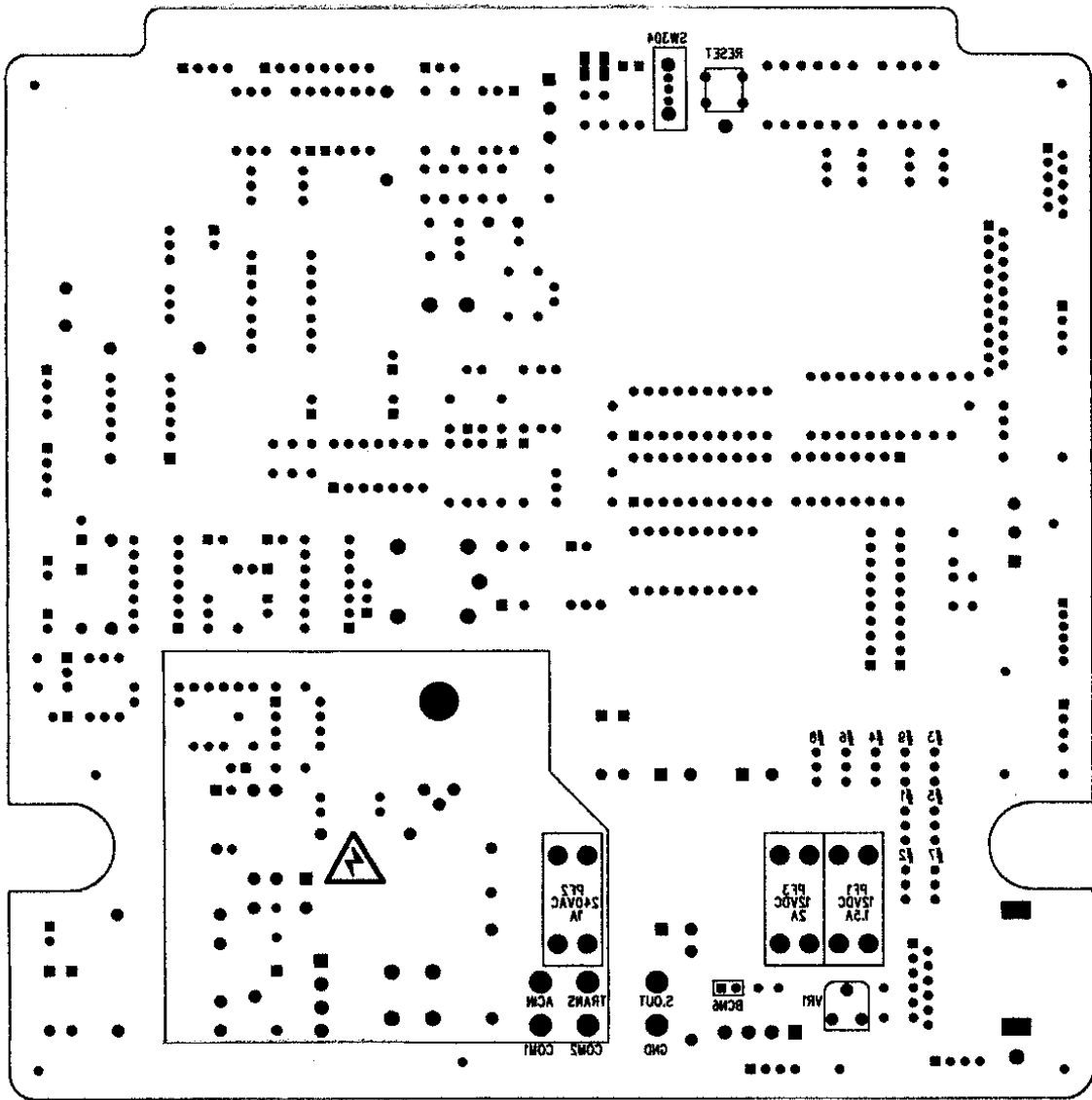

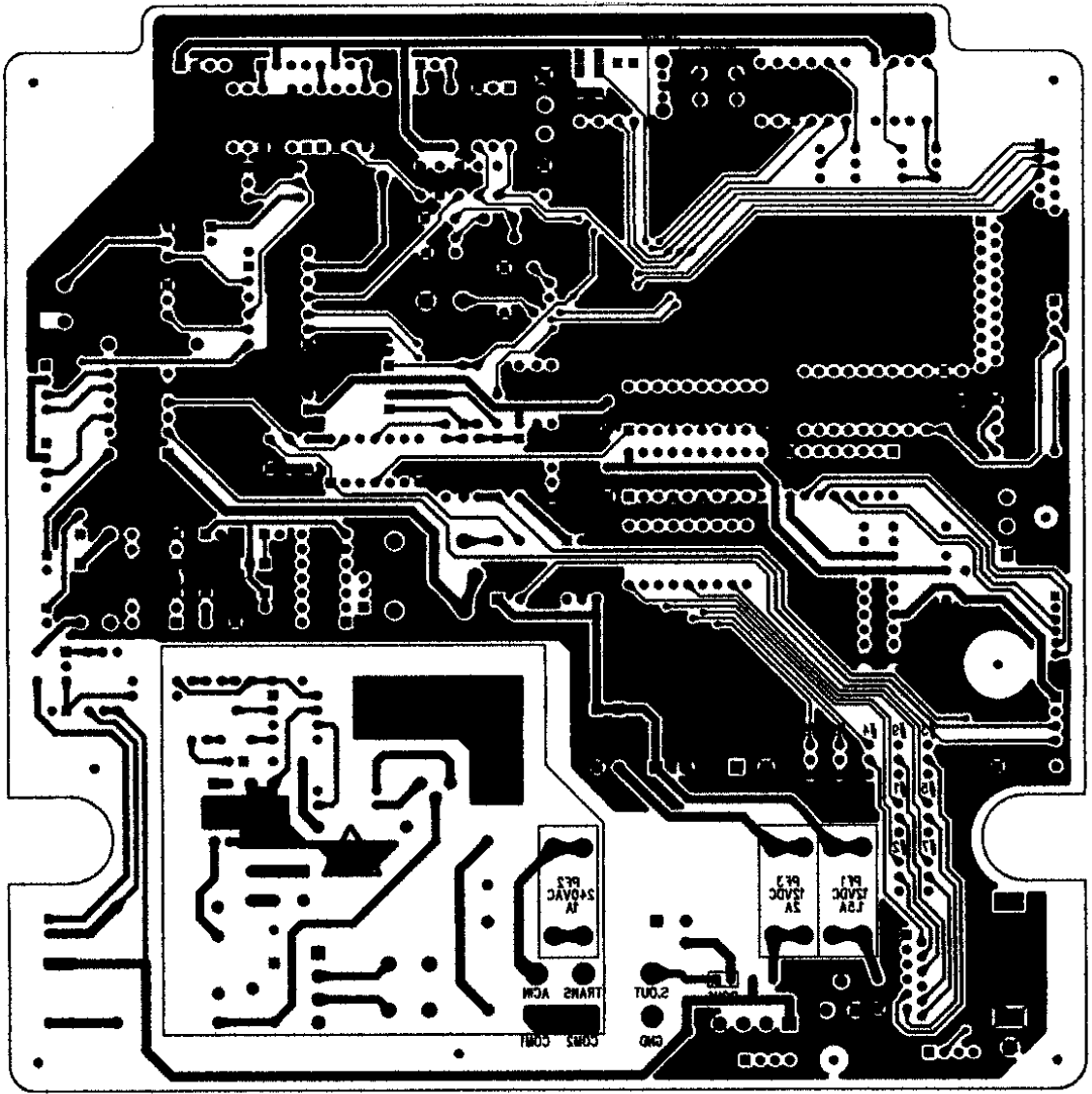

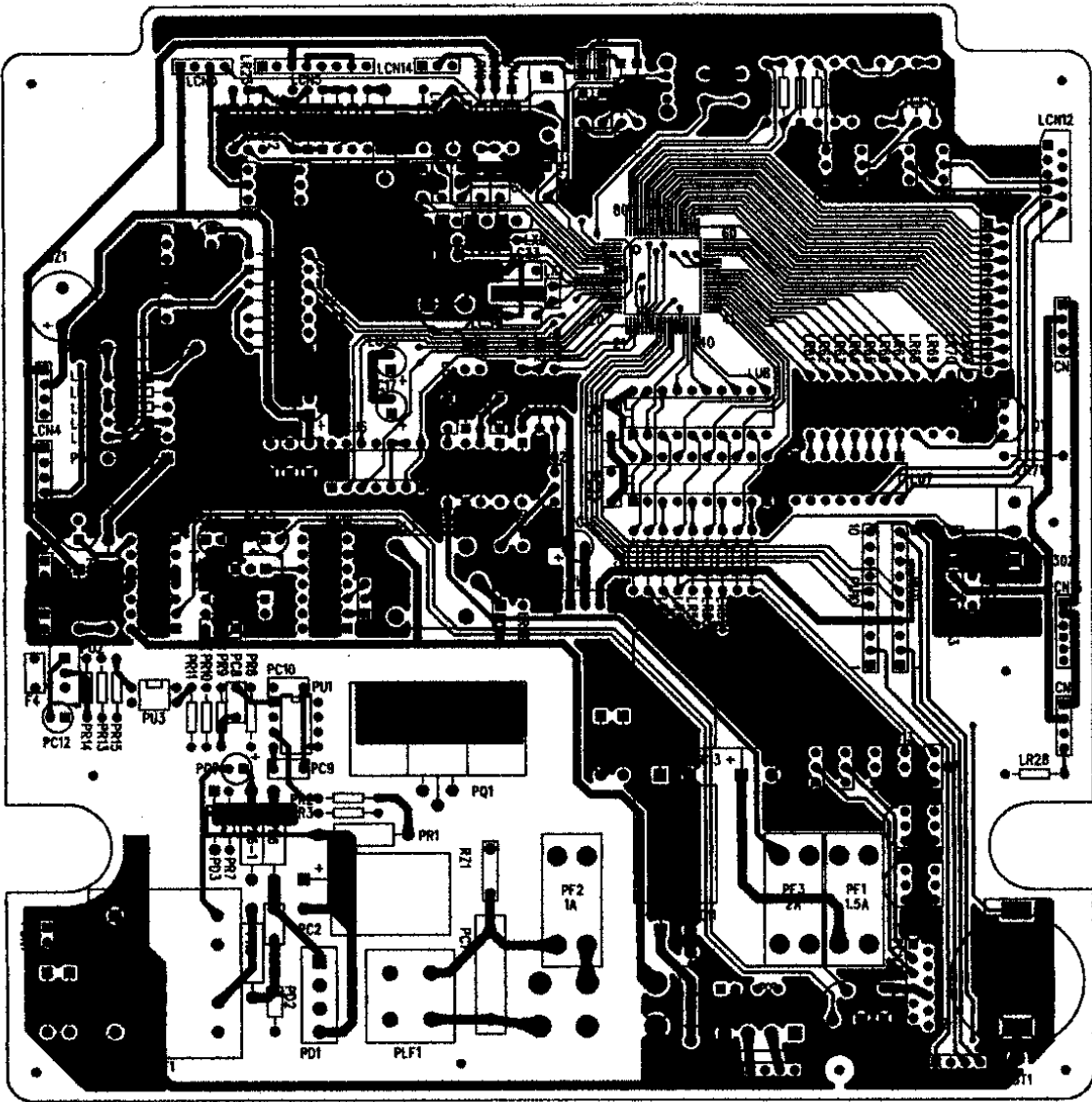

188

C.P.U BLOCK DIAGRAM AND PIN ASSIGNMENT

<PORT LIST>

74HD404889

port	Name	Function	Description	Logic
2	R70/AN0	IN	NiCd battery change control signal	
3	R71	IN	Mechanical switches	L
4	R72	IN	Red/Black ribbon check switch	L
5	R73	IN	Head position check sensor(E-30)	L
6	R80	IN	Card right/back side check sensor	H
7	R81	IN	Card right/back side check sensor	H
17	D0/INT0	IN	Head feed encoder sensor input(E-38)	
18	D1/INT1	IN	Paper feed encoder sensor input(E-37)	
19	D2	OUT		H
20	D3	OUT	Five sensors control	H
21	D4	IN	AC Failure detection signal	H
22	D5	IN	5V monitoring	H
23	D6	OUT	Time signal control	H
24~26	D7~D9	OUT	Six key and jumper wire scan control	L
27~28	D10~D11	OUT	Six LED scan control	L
29	R00	OUT	Paper feed motor control(Pulling)	H
30	R01	OUT	Paper feed motor control(Ejection)	H
31	R02	OUT	Head feed motor control(Changing red and black ribbons)	H
32	R03	OUT	Head feed motor control(Head feed)	H
33	R10	IN	red or black ribbons control	L
34	R11/EVND		No use	
35	R12/BUZZ	OUT	Piezoelectric buzzer control	
36	R13	OUT	Printer head pin1	H
37	R20	OUT	Printer head pin2	H
38	R21	OUT	Printer head pin3	H
39	R22	OUT	Printer head pin4	H
40	R23	OUT	Printer head pin5	H
41	R30	OUT	Printer head pin6	H
42	R31	OUT	Printer head pin7	H
43	R32	OUT	Printer head pin8	H
44	R33	OUT	Printer head pin9	H
45~48	R40~R43	OUT	Step motor control	
49~51	R50~R52	OUT	Six LED SEG control	H
52	R53	OUT	Clock sensor control	H
53~55	R60~R62	IN	Six key and jumper wire control	L
56	R63	IN	Clock sensor input	H
57~72	SEG17~SEG32	OUT	LCD display SEG	
73~76	COM1~COM4	OUT	LCD display COM	

<ELECTRONIC TIME RECORDER CONTROL PANE >

Electronic Time Recorder Control Pane

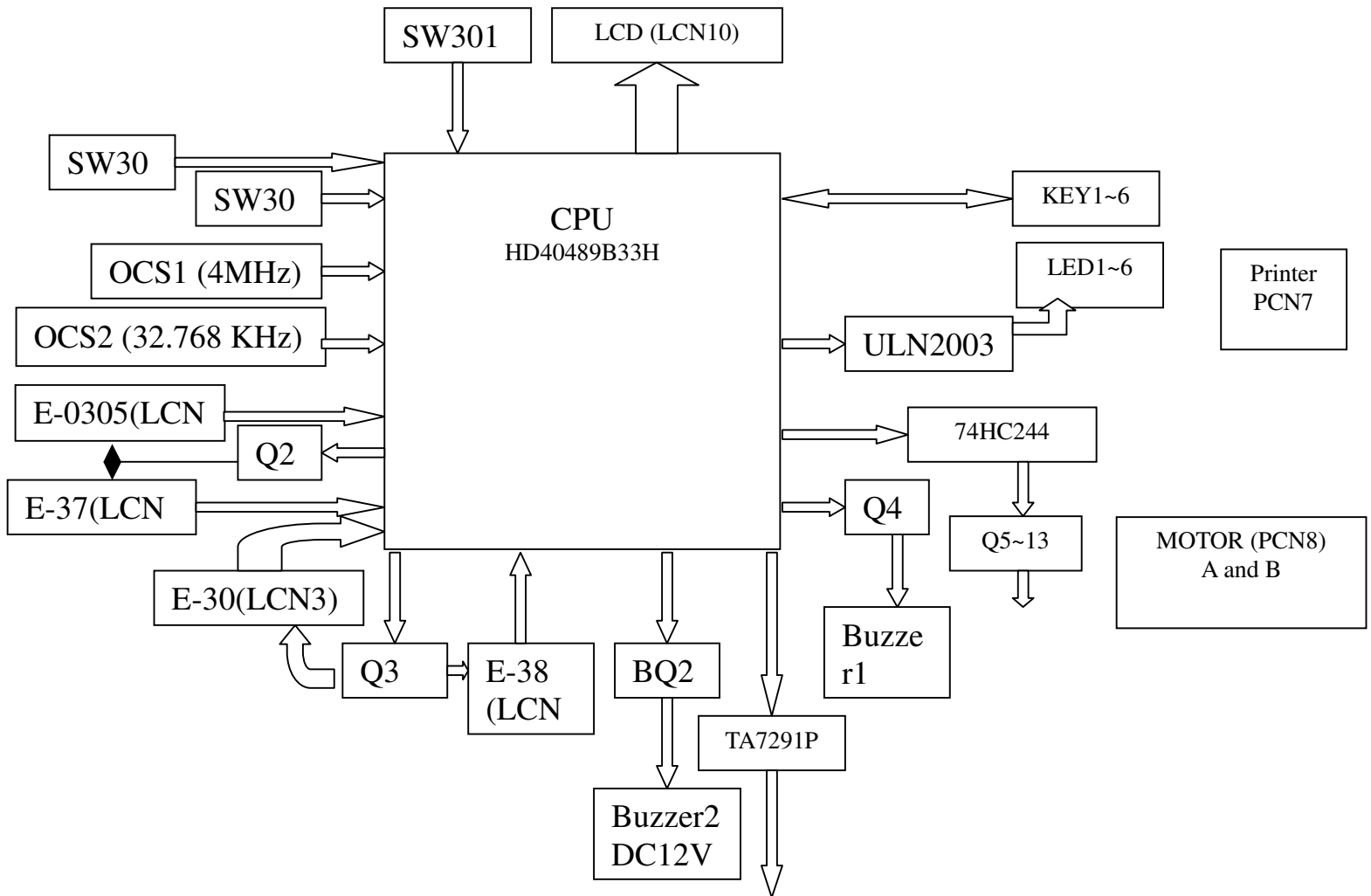

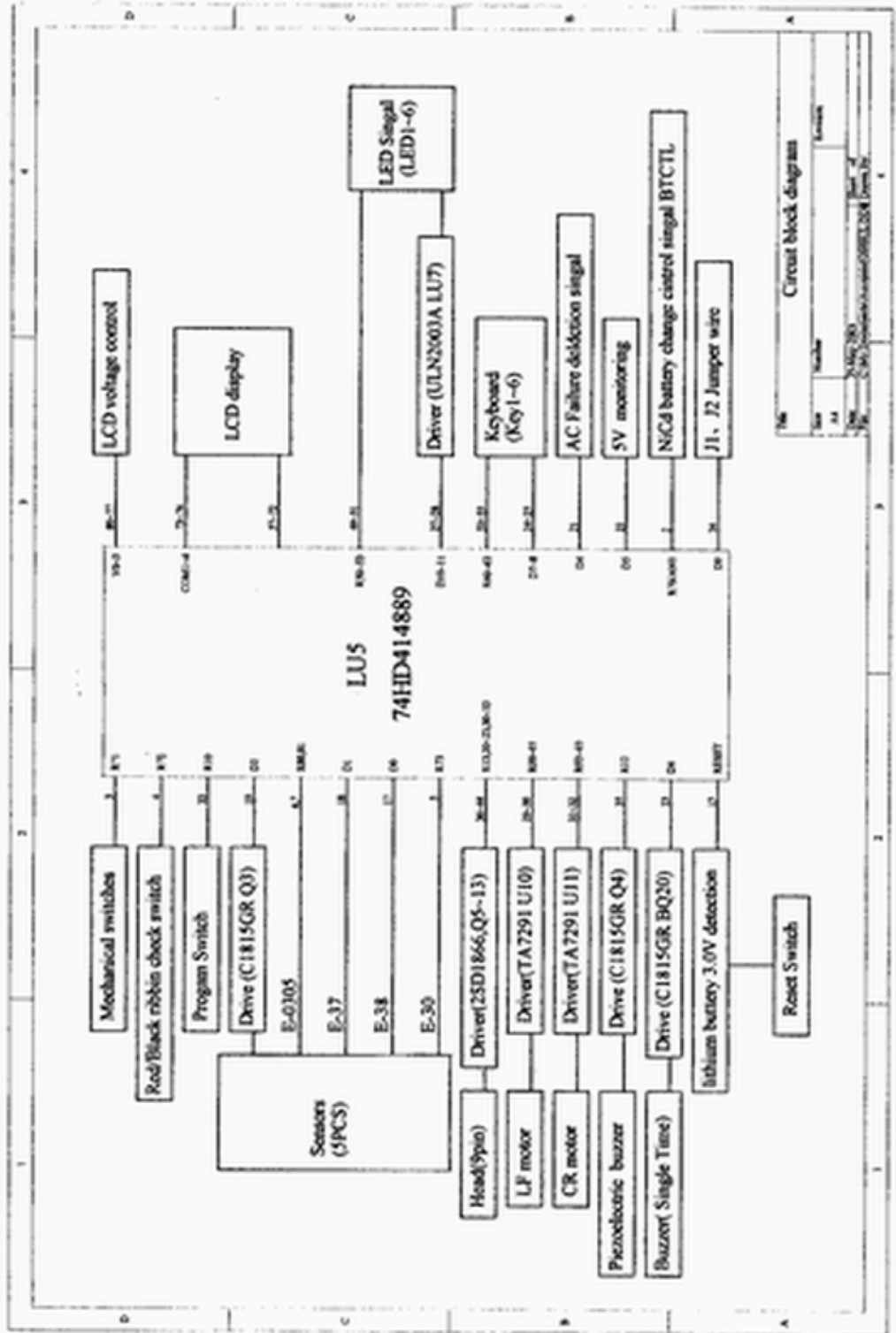

MEASUREMENT

1、 Voltage check

Measuring point	Voltage	Description
11V↔GND	11.0V ± 5%	AC plug should be connected
5V↔GND	5.0V ± 5%	AC plug should be connected

Note: Measurement with no load is possible.

2、 Motor operation check (PCN8.1~4)

Apply the voltages shown below to the terminals of the harness connected to connector PCN8 on the 2000UL PCB ass'y to make sure that the motor runs properly.

Motor	Operation	Applied voltage			
		Pin 1(orange)	Pin 2(green)	Pin 3(red)	Pin 4(green)
LF Motor(A motor)	Pulling	4~9V	GND	-----	-----
LF Motor(A motor)	Ejection	GND	4~9V	-----	-----
CR Motor(B motor)	Changing red and black ribbons.(Continuous)	-----	-----	4~9V	GND
CR Motor(B motor)	Head feed	-----	-----	GND	4~9V

3、 Head resistance measurement (PCN7.1~12)

Measure the head resistance at the terminals of the harness connected to connector PCN7 on the 2000UL PCB ass'y.

Measuring point(PIN NO. of PCN7)	Resistances
1→8	Open
2→8	3.0±0.2Ω
3→8	3.0±0.2Ω
4→8	3.0±0.2Ω
5→8	3.0±0.2Ω
6→8	3.0±0.2Ω
7→8	Short
9→8	3.0±0.2Ω
10→8	3.0±0.2Ω
11→8	3.0±0.2Ω
12→8	3.0±0.2Ω

Note: If the head resistance is less than the values shown above, the head pin drive circuit may also be defective. Replace the head and repair the 2000UL PCB ass'y.

4、 Sensors circuit

There are five sensors. their functions are shown below:

Name	CPU port	Functions
E-03	R80	Detects the right-up edge of an inserted time card.
E-05	R81	Detects the left-up edge of an inserted time card.
E-37	D1	Detects the operating condition of the LF motor.
E-38	D0	Detects the operating condition of the CR motor.
E-30	R73	Check whether the head is at the home position(left end of the machine).

① E-03、05 sensor (LCN5.1~8)

Measuring point (Pin NO.)	Signal name	Description	
		Stand by	Inserted time card and printing
1	E-03-E	0	0→4.0V or more→0
2	E-03-C	5V	5V
3	E-03-A	10.2V or more	10.0V or more
4	E-03-K	9.5V or more	8.5V or more
5	E-05-E	0	0→4.0V or more→0
6	E-05-C	5V	5V
7	E-05-A	9.5V or more	8.5V nor more
8	E-05-K	9.0V or more	7.5V or more

② E-37 sensor (LCN4.1~4)

Measuring point (Pin NO.)	Signal name	Description	
		Stand by	Inserted time card and printing
1	E-37-A	10.2V or more	10.0V or more
2	E-37-C	5V	5V
3	E-37-K	9.5V or more	8.5V or more
4	E-37-E	0	Output square waveform

② E-38 sensor (LCN9.1~4)

Measuring point (Pin NO.)	Signal name	Description	
		Stand by	Inserted time card and printing
1	E-38-A	10.2V or more	10.0V or more
2	E-38-C	5V	5V
3	E-38-K	9.5V or more	8.5V or more
4	E-38-E	0	Output square waveform

② E-30 sensor (LCN3.1~4)

Measuring point (Pin NO.)	Signal name	Description	
		Stand by	Inserted time card and printing
1	E-30-A	10.2V or more	10.0V or more
2	E-30-C	5V	5V
3	E-30-K	9.5V or more	8.5V or more
4	E-30-E	0	4.0V or more→0→4.0V or more→0 or 0→4.0V or more→0

5、CPU operation

The following table shows the operation modes and functions:

Mode	A	B	C	D
Operation	Normal operation.. All functions are valid.	Power failure mode where printing is possible. Same operation as in A mode.	Power failure mode. Time is updated. Data is saved in the memory.	Power failure mode. Time is updated. Data is saved in the memory.
AC power supply	ON	OFF	OFF	OFF
Printing battery	Operable/dead	Operable(guarantees mechanism operation)	Operable(does not guarantees mechanism operation)	Dead. Or, operable but supplies voltage below the rated value.
Back light(LED)	Yes	NO	NO	NO
Battery indicator	No display	Full to half	Should be replace. (flashes)	NO
CPU status	Active mode ↓ Watch mode	Active mode ↓ Watch mode	Active mode ↓ Watch mode	Watch mode

<CONNECTOR PIN ASSIGHMENT>

2000UL PCB Ass'y

(1) PCN1

Pin No.	Signal name
1	NiCd Battery Output
2	GND

(2) LCN3

Pin No.	Signal name
1	E-30-A
2	E-30-C
3	E-30-K
4	E-30-E

(3)LCN4

Pin No.	Signal name
1	E-37-A
2	E-37-C
3	E-37-K
4	E-37-E

(4)LCN9

Pin No.	Signal name
1	E-38-A
2	E-38-C
3	E-38-K
4	E-38-E

(5)LCN0

Pin No.	Signal name
1	+5V
2	GND
3	Card insertion
4	Panel open/close

(6)LCN5

Pin No.	Signal name	Pin No.	Signal name
1	E-03-E	5	E-05-E
2	E-03-C	6	E-05-C
3	E-03-A	7	E-05-C
4	E-03-K	8	E-05-K

(7)LCN12

Pin No.	Signal name	Pin No.	Signal name
1	R60	6	D9
2	R61	7	D10
3	R62	8	R50
4	D7	9	R51
5	D8	10	R52

(8)LCN10

Pin No.	Signal name	Pin No.	Signal name
1	SEG17	12	SEG28
2	SEG18	13	SEG29
3	SEG19	14	SEG30
4	SEG20	15	SEG31
5	SEG21	16	SEG32
6	SEG22	17	COM1
7	SEG23	18	COM2
8	SEG24	19	COM3
9	SEG25	20	COM4
10	SEG26	21	No use
11	SEG27		

(9)PCN8

Pin No.	Signal name
1	R00(A motor)
2	R01(A motor)
3	R02(B motor)
4	R03(B motor)

(10).PCN7

Pin No	Signal name.	Pin No	Signal name
1	GND	7	11V
2	PIN4	8	11V
3	PIN6	9	PIN3
4	PIN2	10	PIN9
5	PIN8	11	PIN5
6	PIN1	12	PIN7

Free Manuals Download Website

<http://myh66.com>

<http://usermanuals.us>

<http://www.somanuals.com>

<http://www.4manuals.cc>

<http://www.manual-lib.com>

<http://www.404manual.com>

<http://www.luxmanual.com>

<http://aubethermostatmanual.com>

Golf course search by state

<http://golfingnear.com>

Email search by domain

<http://emailbydomain.com>

Auto manuals search

<http://auto.somanuals.com>

TV manuals search

<http://tv.somanuals.com>