



KAL 3840

Automotive Scope / GMM

User's Manual



⚠ DANGER

When handling any signals higher than 150 V peak, don't electrically activate BOTH CH A and/or CH B terminal(s) AND USB terminal together at a time. If they are electrically activated simultaneously, a death or a serious personal injury could be resulted in.

Menu Overview

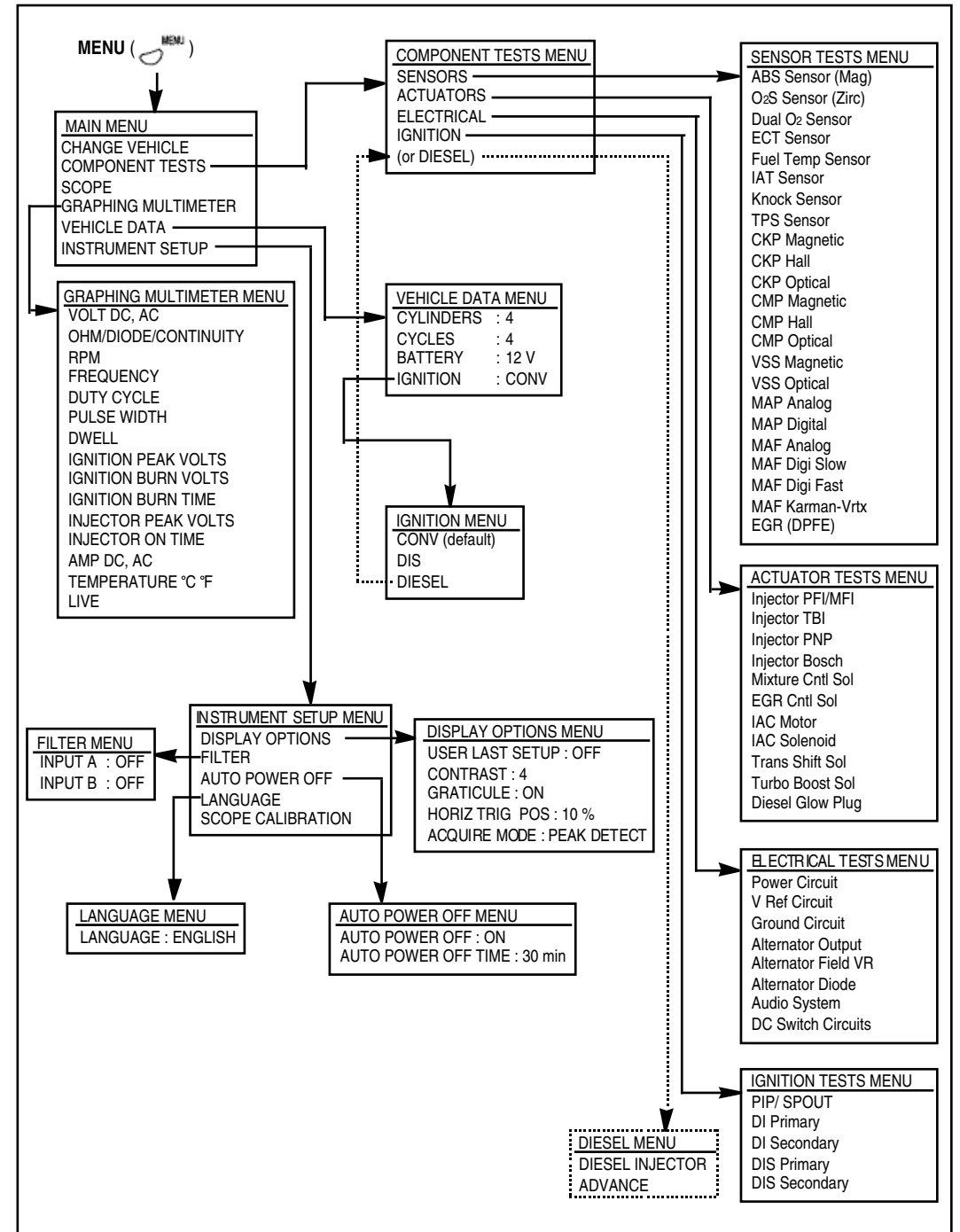

Contents

Menu Overview

- 1. Introduction
 - 1.1 Comparing Scan Tools, DSOs and DMMs 1- 1
 - 1.2 Vehicle Service Manuals 1- 2
- 2. Safety Information
- 3. Automotive Electronic Signals
 - 3.1 Primary Signal Types Found in Modern Vehicles 3- 1
 - 3.2 Critical Characteristics of Automotive Electronic Signals 3- 2
 - 3.3 The Golden Rule of Electronic System Diagnosis 3- 2
 - 3.4 Signal Probing with an Oscilloscope 3- 2
- 4. Getting Started
 - 4.1 Product Description 4- 1
 - 4.2 Quick Tour 4- 2
 - 4.3 Front Panel Controls 4- 6
 - 4.4 Measurement Connections 4- 7
 - 4.5 Grounding Guidelines 4- 8
 - 4.6 Display 4- 9
 - 4.7 SCOPE Mode 4-15
 - 4.8 GMM (GRAPHING MULTIMETER) Mode 4-16
- 5. Instrument Operation
 - 5.1 Instrument Test Modes 5- 1
 - 5.2 SCOPE Displays 5- 1
 - 5.3 GMM Displays 5- 7
 - 5.4 Dual Input Scope Operation 5-13
 - 5.5 Changing the Vehicle Data and Instrument Setup 5-13
 - 5.6 Freezing, Saving, and Recalling Screens 5-17
 - 5.7 Glitch Snare Operation 5-18
 - 5.8 Tips for Noise Management 5-19
- 6. Automotive Diagnostics & Applications
 - 6.1 Component Tests 6- 1
 - 6.2 Sensor Tests 6- 1
 - 6.3 Actuator Tests 6-32
 - 6.4 Electrical Tests 6-48
 - 6.5 Ignition Tests 6-57
 - 6.6 Diesel Tests 6-68

- 7. Maintenance
- 8. Specifications

Glossary

Menu Overview

1. INTRODUCTION

Vehicle manufacturers have helped you locate a driveability problem by designing Electronic Control Units with trouble-code generating capabilities. But, the ECUs aren't perfect because they don't cover everything (most glitches and intermittents). On-board diagnostic systems are engineered with fairly wide set limits for sensors, actuators, connectors and terminals. When a component exceeds its limit consistently, a trouble code is generated. But to keep warranty costs in line, tolerances aren't set to catch all transients, even though they can cause some of your worst driveability problems.

Therefore, repair technicians are finding more and more uses for a Digital Storage Oscilloscope (DSO) and a Digital Multimeter (DMM) these days. A DSO can capture a live "signature" of a circuit and store it for later analysis or comparison against Known-good waveforms - an invaluable resource for detecting marginal components. A GMM (Graphing Multimeter) gives you advanced multimeter capabilities coupled with the visual power of trend graphing and waveform display.

This Meter – a combination DSO and GMM – represents the most powerful and versatile tool available for troubleshooting automotive electronics since we can track down elusive no-code driveability problems.

1.1 COMPARING SCAN TOOLS, DSOs AND DMMs

All of these tools have unique capabilities, and today's vehicles demand that automotive technicians are able to use all three tools to correctly diagnose various driveability problems. DSOs alone cannot replace DMMs or scan tools. By the same token, DMMs or scan tools cannot replace DSOs.

For example, when anti-lock brakes on your car are sometimes erratic, you might firstly try a road test to notice that the ABS light does not come on. When you get back to the shop, you plug in your scan tool and find no trouble codes.

Because you still have your DMM, you follow the manufacturer's instructions and you look at the output voltage from each of the wheel speed sensors. They all appear to be in tolerance, and the manufacturer's fault tree recommends you to replace the ABS computer. Unfortunately, the ABS computer on this vehicle is embedded in the master cylinder, so you must replace everything. The worst thing is the problem still exists even after you complete all of the work.

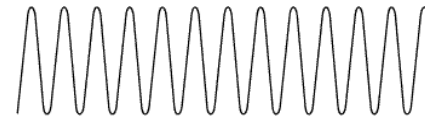

Normal ABS Signal

Most of the signal shown above is visible to scan tools, DSOs and DMMs.

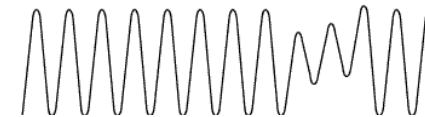

Faulty ABS Signal

However, the faults shown above are not visible to scan tools and DMMs. They are only visible to DSOs.

If you had a DSO, you could look at the output signal from each of the wheel speed sensors. From this you would have discovered that the left rear wheel speed sensor had some very fast aberrations that caused the ABS computer to act strange. You replace the left rear wheel speed sensor to cure the problem. The scan tools missed this problem because no trouble codes were set and the computer communication bus was too slow to pick up the spikes. The DMMs missed this problem because it averaged the sensor signals and could not see the fast aberrations.

Scan tools and DMMs sample very slow when compared to DSOs. DSOs are typically more than a few hundred thousand times faster than scan tools and more than 1,000 times faster than DMMs.

There are many examples of vehicle signals that DMMs and scan tools are unable to see. There are many vehicle problems that can occur that really require a DSO or combination DSO and DMM to diagnose accurately.

1.2 VEHICLE SERVICE MANUALS

This instrument tells how to hook up it to the selected vehicle components to be tested. However, it is strongly recommended that you consult the manufacturer's service manual for your vehicle before any test or repair procedures are performed in order to get the color of the wire or the PCM's pin number from a wiring diagram.

For availability of these service manuals, contact your local car dealership, auto parts store, or bookstore, The following companies publish valuable repair manuals:

- **Mitchell International**

14145 Danielson Street
Poway, CA 92064
Tel : 888-724-6742

- **Haynes Publications**

861 Lawrence Drive
Newbury Park, CA 91320
Tel : 1-800-442-9637

- **Motor Publications**

5600 Crooks Road, Suite 200
Troy, MI 48098
Tel : 1-800-426-6867

- **Helm Inc.**

14310 Hamilton Avenue
Highland Park, MI 48203
Tel : 1-800-782-4356

2. SAFETY INFORMATION



WARNING

READ "SAFETY INFORMATION" BEFORE USING THIS MANUAL.

This instrument is designed to be used only qualified personnel who are (properly trained) skilled professional automotive technicians.

It is assumed that the user has a thorough understanding of vehicle systems before using this instrument.

To use this instrument safely, it is essential that operating and servicing personnel follow both generally accepted safety procedures and the safety precautions specified in this manual.

A DANGER identifies an imminently hazardous situation which, if not avoided, will result in death or serious injury to the user or the bystanders.

A WARNING identifies conditions and actions that pose hazard(s) to the user or the bystanders.

A CAUTION identifies conditions and actions that may damage the instrument or the vehicle.

The term "Isolated (or Electrically floating)" is used in this manual to indicate a measurement in which the COM terminal of this instrument is connected to a voltage different from earth ground. The term "Grounded" is used when the COM terminal is connected to an earth ground potential. The COM terminal of this instrument is rated up to 300 V rms above earth ground for the safety of isolated measurements.

Using Your Instrument Safely

Follow safe servicing practices as described in your vehicle service manual. To use this instrument safely, follow the safety guidelines below :



DANGER

- Use the instrument in service area WELL VENTILATED providing at least four change of air per hour. Engines produce carbon monoxide, an odorless, colorless, and poisonous gas that causes slower action time and can result in death or serious injury. Route exhaust outside while testing with engine running.
- Set the parking brake and block the wheels, especially the wheels on front-wheel drive vehicles, before testing or repairing the vehicle because the parking brake does not hold the drive wheels.
- Be sure there is adequate clearance between any moving components when testing. Moving components and belts can CATCH loose clothing, parts of your body or the instrument and cause serious damage or personal injury.
- Always wear approved safety eye protection when testing or repairing vehicles. Objects can be propelled by whirling engine components can cause serious injury.
- When handling any signals higher than 150 V peak, don't electrically activate BOTH CH A and/or CH B terminal(s) AND USB terminal together at a time. If they are electrically activated simultaneously, a death or a serious personal injury could be resulted in.

Avoid Fires:

- Do not position head directly over carburetor or throttle body. Do not pour gasoline down carburetor or throttle body when cranking or running engine. Engine backfire can occur when air cleaner is out of normal position.
- Do not use fuel injector cleaning solvents or carburetor sprays when performing diagnostic testing.
- The instrument has internal arcing or sparking parts. Do not expose the instrument to flammable vapors.
- Do not smoke, strike a match, place metal tools on battery, or cause a spark in the vicinity of the battery. Battery gases can ignite.
- Keep a fire extinguisher rated for gasoline, chemical, and electrical fires in work area. Fires can lead to serious injury or death.

WARNING

Avoid Electrical Shock:

- Make sure that the vehicle to be tested is at a safe potential before making any measurement connections.
- Connect the COM input of the instrument to vehicle ground before clamping the standard SECONDARY PICKUP (supplied) on the ignition wires. This ground connection is required IN ADDITION TO the normal measurement ground connections.
- Do not touch ignition coils, coil terminals, and spark plugs while operating. They emit high voltages.
- Do not puncture an ignition wire to connect the instrument, unless specifically instructed by vehicle manufacturer.
- Be sure the ignition is in the OFF position, headlights and other accessories are off, and doors are closed before disconnecting the battery cables. This also prevents damage to on-board computer systems.

IF the ground of the instrument is connected to a voltage higher than 42 V peak (30 V rms);

- Use only the standard test leads set supplied with the instrument.
- Do not use conventional exposed metal BNC or BANANA PLUG connectors.
- Use only one ground connection to the instrument (GROUND LEAD of the CH A's shielded test lead).
- Remove all probes and test leads that are not in use.
- Connect the power adapter to the AC outlet before connecting it to the instrument.

Follow the general safety guidelines below;

- Avoid working alone.
- Inspect the test leads for damaged insulation or exposed metal. Check test lead continuity. Replace damaged leads before use.
- Do not use the instrument if it looks damaged.
- Select the proper function and range for your measurement.
- When using the probes, keep your fingers away from probe contacts.
Keep your fingers behind the finger guards on the probes.

- Disconnect the live test lead before disconnecting the common test lead.
- Do not perform internal service or adjustment of this instrument unless you are qualified to do so.

Avoid Burns:

- Do not touch hot exhaust systems, manifolds, engines, radiators, sample probe, etc.
- Do not remove radiator cap unless engine is cold. Pressurized engine coolant may be hot.
- Wear gloves when handling hot engine components.
- Use a suitable battery carrier when transporting batteries.

CAUTION

- Disconnect circuit power and discharge all high voltage capacitors before connecting the instrument to make resistance, continuity, or diodes measurements.
- Do not rely on questionable, erratic, or obviously erroneous test information or results. Make sure that all connections and data entry information are correct and that the test procedure was taken correctly. Do not use suspicious test information or results for diagnostics.

3. AUTOMOTIVE ELECTRONIC SIGNALS

3.1 PRIMARY SIGNAL TYPES FOUND IN MODERN VEHICLES

Once you become familiar with basic vehicle waveforms it will not matter how new or old the vehicle is, or even who manufactured the vehicle. You will be able to recognize signals that do not look right.

Direct Current (DC) Signals

The types of sensors or devices in a vehicle that produce DC signals are:

- Power Supplies - Battery voltage or sensor reference voltages created by the PCM.
- Analog sensor signals - engine coolant temperature, fuel temperature, intake air temperature, throttle position, EGR pressure and valve position, oxygen, vane and hot wire mass airflow sensors, vacuum and throttle switches and GM, Chrysler and Asian manifold absolute pressure (MAP) sensors.

Alternating Current (AC) Signals

The types of sensors or devices in a vehicle that produce AC signals are:

- Vehicle speed sensors (VSS)
- Antilock brake system wheel speed sensors (ABS wheel speed sensors)
- Magnetic camshaft (CMP) and crankshaft (CKP) position sensors
- Engine vacuum balance viewed from an analog MAP sensor signal
- Knock sensors (KS)

Frequency Modulated Signals

The types of sensors or devices in a vehicle that produce Frequency Modulated signals are:

- Digital mass airflow (MAF) sensors
- Ford's digital MAP sensors
- Optical vehicle speed sensors (VSS)
- Hall Effect vehicle speed sensors (VSS)
- Optical camshaft (CMP) and crankshaft (CKP) position sensors
- Hall Effect camshaft (CMP) and crankshaft (CKP) position sensors

Pulse Width Modulated Signals

The types of circuits or devices in a vehicle that produce Pulse Width Modulated signals are:

- Ignition coil primary
- Electronic spark timing circuits
- EGR, purge, turbo boost, and other control solenoids
- Fuel injectors
- Idle air control motors and solenoids

Serial Data (Multiplexed) Signals

The types of circuits or devices in a vehicle that produce Serial Data signals are:

- Powertrain control modules (PCM)
- Body control modules (BCM)
- ABS control modules
- Other control modules with self diagnostics or other serial data / communications capability

3.2 CRITICAL CHARACTERISTICS OF AUTOMOTIVE ELECTRONIC SIGNALS

Only 5 critical characteristics (or information types) given from the Automotive electronic signals are important because the vehicle's PCM considers them important.

- **Amplitude** - The voltage of the electronic signal at a certain point in time.
- **Frequency** - The time between events, or cycles, of the electronic signal, usually given in cycles per second (Hertz).
- **Shape** - The signature of the electronic signal, with its unique curves, contours, and corners.
- **Duty Cycle** - The on-time, or relative pulse width of the electronic signal.
- **Pattern** - The repeated patterns within the signal that make up specific messages, like synchronous pulses that tell the PCM that cylinder #1 is at TDC (Top Dead Center), or a repeated pattern in the serial data stream that tells the scan tool the coolant temperature is 212 F (or 100 C), etc.

3.3 THE GOLDEN RULE OF ELECTRONIC SYSTEM DIAGNOSIS

For the vehicle's computer system to function properly, it must send and receive signals with the critical characteristics it was designed to communicate with.

Each of the primary types of electronic signals use the critical characteristics to establish electronic communication. They each use different combinations of the critical characteristics to communicate. Here's a list of which critical characteristics each of the primary signal types uses to communicate:

- Direct Current signals use Amplitude only.
- Alternating Current signals use Amplitude, Frequency, and Shape.
- Frequency Modulated signals use Amplitude, Frequency, and Shape.
- Pulse Width Modulated signals use Amplitude, Frequency, Shape, and Duty Cycle.
- Serial Data signals use Amplitude, Frequency, Shape, Duty Cycle, and Pattern.

The list will help to give you a better understanding of which signal types use which critical characteristics to do their electronic communication. The above rules work very well and hold up in most cases, but there are exceptions to its rules. Not many, but a few.

It may come no surprise to some that serial data signals are the most complex signals in the vehicle. They use all 5 critical characteristics to communicate with. Thus, they take a special analyzer to decode them - one very familiar to most technicians - the scan tool.

3.4 SIGNAL PROBING WITH AN OSCILLOSCOPE

The engine compartment of a running vehicle is a very unfriendly environment for automotive signals to live. Temperature extremes, dirt and corrosion, and electrical leaks, or noises from the high voltage pulses generated from a typical ignition system can produce interference that can contribute significantly to the cause of many driveability problems.

When you are probing components, sensors and circuits, be aware that the electrical noises from today's high output ignition systems can produce an RF energy that is similar to a radio station. Since oscilloscopes are so sensitive, this interference can actually override the signals you are trying to capture and give you a false reading on the display.

To minimize this possible interference with the oscilloscope, keep these tips and suggestions in mind:

- Most interference will be picked up by the oscilloscope test leads.
 - Route the test leads away from all ignition wires and components whenever possible.
 - Use the shortest test leads possible, since other test leads may act as an antenna and increase the potential for interference, especially at higher frequency levels that are found when probing near the vehicle's on-board computer.
 - With the potential for RF interference in the engine compartment, if possible, use the vehicle chassis as ground when connecting the oscilloscope test leads. In some cases the engine block can actually act as an antenna for the RF signals.
 - The test leads are a very important part of any oscilloscope. Substituting other leads in both length and capability may alter the signals on your display.
- The oscilloscope can also pick up interference like the test leads.
 - Because the oscilloscope circuits are so sensitive, and therefore powerful, do not place the oscilloscope directly on ignition wires or near high energy ignition components, like coil packs.
 - If you are using the AC or DC charger/adaptor to power the oscilloscope, keep the external power leads far away from the engine and ignition if possible.

4. GETTING STARTED

4.1 PRODUCT DESCRIPTION

This instrument is a battery-operated 2-channel lab scope, advanced true rms graphing multimeter (GMM) designed expressly for use in the automotive service market. The main purpose of this instrument is to provide advanced troubleshooting capabilities for automotive service technicians in an easy-to-operate format.

This instrument offers the following features:

- A 25 Mega-sample/Second (one channel minimum) sample rate for rapid data updates.
- Lab scope signal patterns.
- True RMS Graphing Multimeter (GMM) measurements and graphs.
- A unique "Glitch Snare" mode which captures, displays and optionally saves abnormal signal patterns in the Scope mode of the COMPONENT TESTS only when they occur.
- Preset tests that enable the user to check the majority of automotive sensors, actuators and systems easily and quickly.
- Powerful built-in reference information for each preset test which includes a test procedure showing how to connect to the circuit, a normal reference signal pattern, theory of operation and troubleshooting tips.
- Menu-driven interface has automatic configurations for most of non-preset tests, so you will find that the instrument is easy-to-use.
- The Secondary Ignition Single function displays the waveform along with the spark voltage, RPM, burn time and burn voltage.
- The Diesel function allows you to set injection pump timing and RPM using the optional Diesel accessories.
- USB interface supports updates for code and data.

Even though this instrument is designed to configure itself to almost any test, it is very important that you continue through this manual and carefully read and understand the capabilities of this instrument before attempting actual measurements.

4.2 QUICK TOUR

Powering the Instrument

Press the POWER key to turn the instrument on. The instrument beeps once and turns on. At power on, the instrument displays the VEHICLE DATA menu as shown in Figure 1.

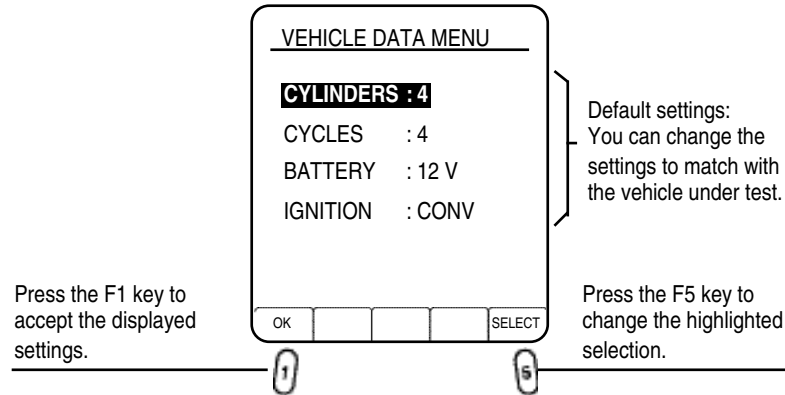



Figure 1. Vehicle Data Menu at Power-On

Changing the Power-On Display



Use "Instrument Setup" menu option to change the Power-On display from VEHICLE DATA MENU(default) to the user's last display.

Adjusting the Display Contrast

Press LIGHT () and Keep it depressed until you can clearly read the display.

Resetting the Instrument

If you want to restore the instrument settings as delivered from the factory, do the following:

1. Turn the instrument off by pressing the POWER key.
2. Keep  depressed while you turn the instrument on by pressing the POWER key. Release  . You will hear a double beep to indicate that the Master Reset has been executed.

NOTE

The Master Reset clears all memory data.

Performing a Navigation Exercise

To display the MAIN MENU while a measurement display is active, press the MENU key to display the MAIN MENU as shown in Figure 2. This menu lists all of the tests, displays and setups available:

- CHANGE VEHICLE
- COMPONENT TESTS
- SCOPE

- GRAPHING MULTIMETER
- VEHICLE DATA
- INSTRUMENT SETUP

The fastest way to set up the instrument to test most automotive devices(sensors, actuators...) and circuits is to choose from one of the built in **COMPONENT TESTS**. Each test places the instrument in a configuration best suited to display signals for the chosen device or circuit.

In order to get the Pin # / Wire Color for the component of the vehicle to be tested by using the HELP  button before starting test of the selected component, you must select the vehicle first by using the CHANGE VEHICLE menu choice. Then, the data (Year, Make, Line, WD, Engine capacity, etc.) for the vehicle to be tested will show on the "SELECTED VEHICLE" area.

Press a Four Way arrow key to position the HIGHLIGHT BAR over the COMPONENT TESTS menu choice and press  to select.

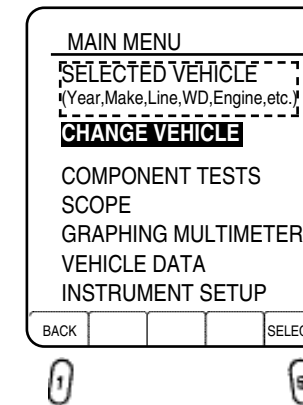

Figure 2. Main Menu

From the resulting COMPONENT TESTS menu, select IGNITION from the test group. Then, press  to select.

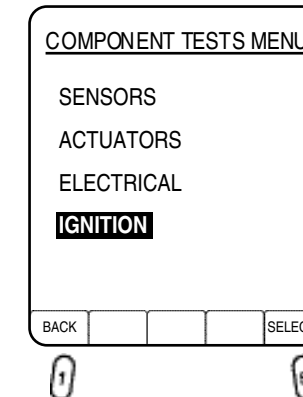

Figure 2. Selecting IGNITION Menu

Next, press the Four Way arrow keys to highlight **PIP/SPOUT**. Press **5** to select. Now, the instrument is ready to test the input signal(s).

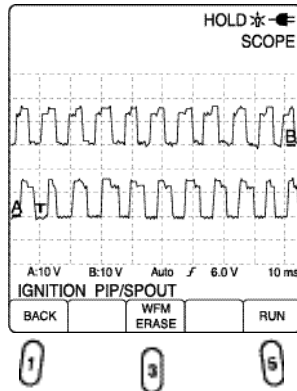

Figure 3. Example of Result Display

Press **3** to remove the Reference Waveform(s).

Press **5** to enter the scope into the test mode and continue to display the Reference Waveform(s) for comparison to a live waveform(s).

For this demonstration, view the following reference information specific to the test selected. Reference information is available at any time by pressing the HELP key. Press **1** when finished viewing each area under the HELP menu.

Pin # / Wire Color - Tells pin numbers and wire colors for both PCM and the other component connector for certain COMPONENTS.

Test Procedure - Tells how to hook up the scope, and what accessories to use. Describes how to stimulate the sensor or operate the circuit to obtain a diagnostic waveform.

Reference Waveform (REF WFM) - Shows a typical good or normal signal pattern. Describes significant waveform features or variations.

Theory of Operation - Explains what the sensor or circuit does and the important signals involved.

Troubleshooting Tips - Tells the symptoms caused by the defective component and how to fix up the problems.

Function Information - Explains about the particular function keys that can be used for the selected test for certain COMPONENTS.

Pressing **1** moves back through the previous displays to return to active tests or to test selected menus.

After you choose a preset test, you may change most instrument settings to get a better look at the signal. You can even change to different display modes, moving between Scope mode and GMM mode as needed, by pressing the GMM MODE function key in the Scope display or the SCOPE MODE function key in the GMM display.

You can hold the information in memory at any time by pressing the HOLD key to freeze the display. Notice that SAVE, RECALL, and CLEAR function key label is displayed above the Function key on the bottom display after HOLD **5** is pressed.

- Press the SAVE key to save the present screen in the next memory location.
- Press the RECALL key to recall the screen last saved in memory.
- Press the CLEAR key to clear all the memory locations.
- Press the BACK key to resume measuring or to return to the previous display.

Power Sources and Charging the Battery

The instrument can be powered from any of the following sources:

- **Internal Battery Pack**
This is a rechargeable Ni-MH Battery Pack already installed.
- **Power Adapter**
The Power Adapter / Battery Charger powers the instrument from a standard AC outlet and charges the installed Ni-MH Battery Pack.
The instrument can be used during battery charging. Verify that your local line voltage is appropriate before using the Power Adapter to power the instrument.
- **Charging Adapter (Optional)**
This adapter charges the instrument's Ni-MH Battery Pack from a standard 12 V DC cigarette lighter outlet



WARNING
TO AVOID ELECTRICAL SHOCK, USE A BATTERY CHARGER THAT IS AUTHORIZED FOR USE WITH THE AUTOMOTIVE SCOPE.

USE the following procedure to charge the battery pack and to power the instrument:

1. Connect the Power Adapter / Battery Charger to line voltage.
2. Insert the Power Adapter's low voltage plug into the Power Adapter connector of the instrument. You can now use the instrument while the Ni-MH batteries are being charged slowly. If the instrument is turned off, the batteries are charged more quickly.
During operation, when the batteries are low, a battery symbol appears on the top right of the display. When this occurs, replace or recharge the internal battery pack immediately.
3. The Power Adapter uses a trickle charging method for the batteries, so no damage can occur even if you leave it charging for long periods.
Typically a 8 hour recharge during instrument working and a 4 hour recharge during instrument off provides the instrument with the maximum use of 4 hours.

Auto-Power-Off

When operated on batteries (no adapter connected), the instrument conserves power by turning itself off automatically, if you have not pressed a key for 30 minutes or if the battery level is too low. The instrument turns back on if the POWER key is pressed.

The Auto-Power-Off will be disabled automatically when enters the GMM mode.

You can adjust the Auto-Power-Off time between 5 minutes and 120 minutes to use "Instrument Setup" menu option.

4.3 FRONT PANEL CONTROLS

Key Control Overview

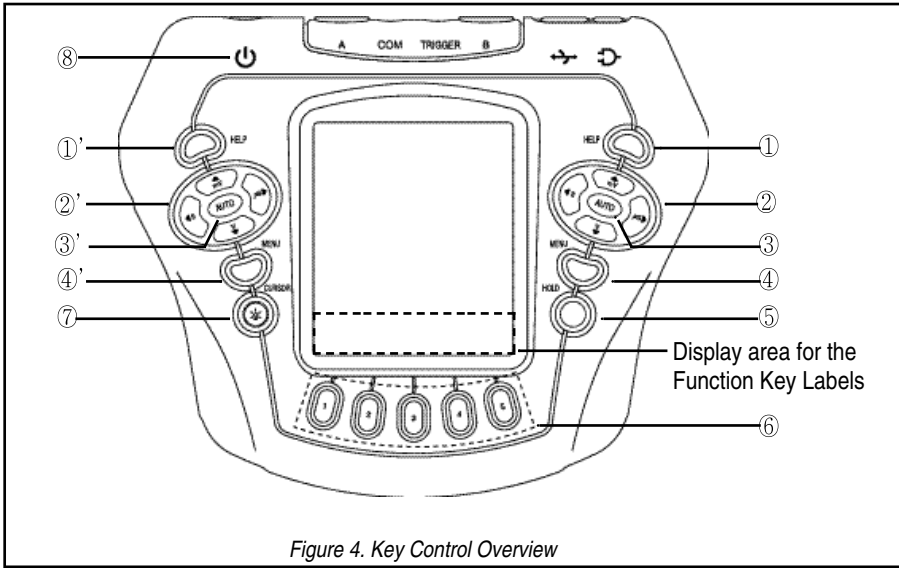

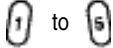



Figure 4. Key Control Overview

Key Descriptions

ITEM	KEYS	DESCRIPTION
① & ①'	HELP	Displays information about the highlighted menu choice during menu selection. Displays information about the function keys when a selected test is running.
② & ②'		Performs one of the following actions: <ul style="list-style-type: none"> Moves up and down through menu choices. Moves a waveform up and down. Moves a voltage cursor up and down. Adjusts the trigger level when you are in the SCOPE mode. Moves a waveform right and left. Moves a time cursor left and right.
		Ranges amplitude up and down for both channels (CH A & CH B). Ranges Time Bass up and down for both channels (CH A & CH B).
③ & ③'	AUTO	Sets automatic ranging on and off (toggle). When on, the top right display shows AUTO. When this function is set on, it searches for the best range and time base settings and once found it tracks the signal. When this function is off, you should manually control ranging.
④ & ④'	MENU	Takes you back to the main navigation menu.

ITEM	KEYS	DESCRIPTION
⑤	HOLD	Freezes the display (HOLD is displayed at the top right). Also displays a menu to save or recall screens or to clear the memory.
⑥	 1 to 5	These are the Function keys. The function assigned to each key is indicated by the Function Key Label displayed above the key on the bottom display.
⑦	 CURSOR	Cursor (Short) key allows you to use cursors for measurements on waveforms. A cursor is a vertical or a horizontal line that you can move over the waveform like a ruler to measure values at specific points. Light (Long) key turns the LCD Backlight on and off.
⑧	POWER	Turns the power on and off (toggle). When you turn the power on, previous settings are activated.

4.4 MEASUREMENT CONNECTIONS

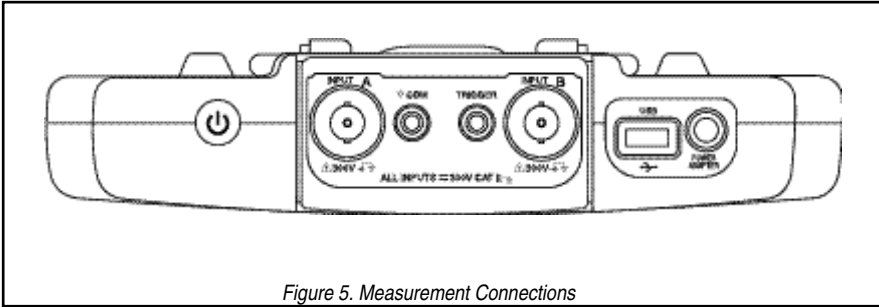

Figure 5. Measurement Connections

INPUT A (Red)

INPUT A is used for all single channel measurements, sometimes combined with use of the other inputs, Various test leads and adapters are required depending on the type of measurement selected.

INPUT B (Yellow)

INPUT B is used in conjunction with INPUT A.

- In COMPONENT TEST mode,
 - for DUAL O2 SENSOR measurements.
 - for PIP/SPOUT measurements.
 - for ADVANCE measurements.
- In SCOPE mode you can use the instrument as a dual trace oscilloscope with INPUT A and INPUT B connected.

COM, TRIGGER

Used as external trigger for probes with dual banana plugs, such as the RPM Inductive Pickup.

TRIGGER (as single input)

Used in SCOPE mode to trigger (or start) acquisitions from an external source.

COM (as single input)

Used for safety grounding when the Capacitive Secondary Pickup is connected to the ignition system.

WARNING

TO AVOID ELECTRICAL SHOCK, CONNECT THE COM INPUT OF THE INSTRUMENT TO VEHICLE GROUND BEFORE CLAMPING THE CAPACITIVE SECONDARY PICKUP(SUPPLIED) ON THE IGNITION WIRES. THIS GROUND CONNECTION IS REQUIRED IN ADDITION TO THE NORMAL MEASUREMENT GROUND CONNECTIONS.

For other tests, the COM input should not be connected to engine ground when the probes have their own ground connection at the probe end. See the GROUNDING GUIDELINES.

4.5 GROUNDING GUIDELINES

Incorrect grounding can cause various problems:

1. A ground loop can be created when you use two ground leads connected to different ground potentials. This can cause excessive current through the grounding leads.

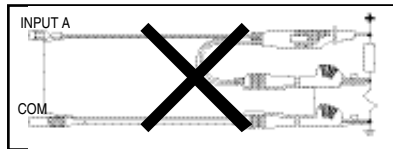

(Incorrect Grounding)
Ground Loop by Double Grounding on Different Grounds

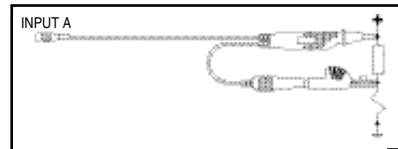

(Correct Grounding)
Shield of Test Lead Connected to Ground

2. Excessive noise shown on the measured signal.



(Incorrect Grounding)
Noise Pickup on Unshielded Ground Lead

3. Measurement faults or short circuit with the DUAL INPUT SCOPE mode. This occurs when you perform floating measurements with grounding at different points.

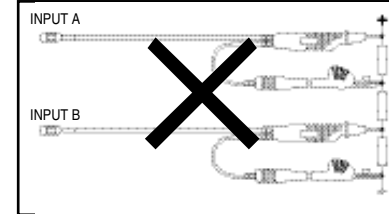

(Incorrect Grounding)
Short Circuit by Grounding on Different Potentials

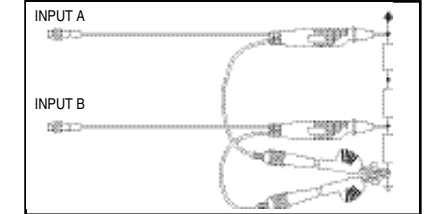

(Correct Grounding)
Grounding at One Point

Instrument Grounding for Measurements on the Ignition System

For the instrument safety, connect the COM input to engine ground before you perform measurements on the ignition system with the Capacitive Secondary Pickup.



To prevent ground loops, connect all ground leads to the SAME engine ground.

4.6 DISPLAY

The instrument presents "live" measurement data in the form of Scope and GMM displays. Temporary displays are used to display frozen and saved measurement data.

Menus are provided as a means of choosing instrument's measurement configuration. To display the MAIN MENU while a measurement display is active, press the MENU key at any time.

Menu Display

When you press MENU key, the instrument displays the MAIN MENU. To select a menu option, use the Four Way arrow keys to move the highlight bar to the desired item. Then press . To exit the MAIN MENU and return to the previous setup, press . During menu selection, the bottom part of the screen is used to display the function key menu.

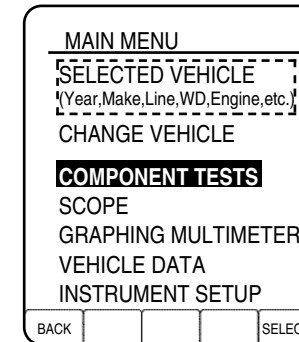

CHANGE VEHICLE

Makes you be able to obtain the pin numbers and wire colors for both PCM and the other component connector from HELP () on the selected vehicle you want to test.

COMPONENT TESTS

Leads to a series of predefined setups to test most common sensors and circuits.

SCOPE

Use Single Input Scope mode if you want to measure a single signal, INPUT B is turned off. Use Dual Input Scope mode if you want to simultaneously measure two waveforms - one on INPUT A and the other on INPUT B.

GRAPHING MULTIMETER

INPUT A is used for all GMM(Graphing Multimeter) tests. The probes and test leads to be used depend upon the type of test performed.

VEHICLE DATA

Set the vehicle data to match the vehicle under test. If they do not match, you could get incorrect test results and may not be able to select all available tests for this vehicle. This menu appears at power-on as the start-up display due to its importance.

INSTRUMENT SETUP

Use this menu option to set the following:

- Optimal settings for display.
- Filter function enabled and disabled.
- Auto-Power-Off enabled and disabled and adjusting the Auto-Power-Off time.
- Language for menus and HELP text.
- Scope Calibration when using the scope in abnormal operating environments.

Menu Overview

Figure 6. shows an overview of available test functions, displays and setups from the MENU key. The MAIN MENU choices represent categories of applications that are listed in sub-menus as shown in the following figure.

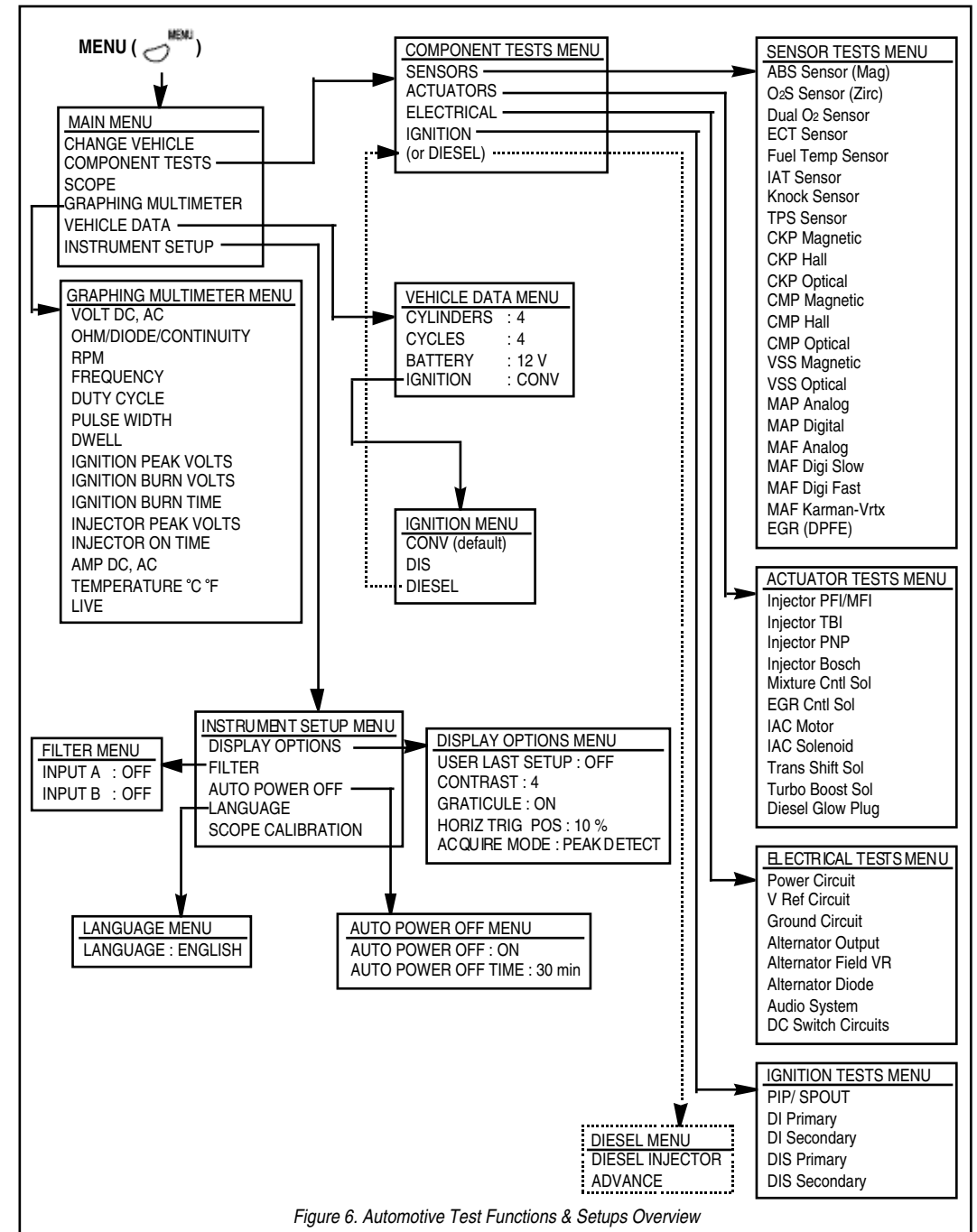
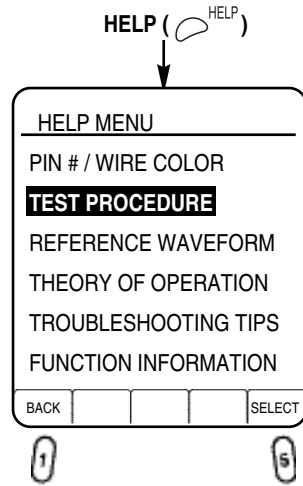

Figure 6. Automotive Test Functions & Setups Overview

Getting Reference Information for the Selected Test

Reference information is available at any time by pressing the HELP key. Press **1** when finished viewing each area under the HELP menu.



Getting Information About the Function Keys During a Running Test

HELP (**HELP**) When you press this key during a running test, you get information about the function keys that can be used for the test.

For example,

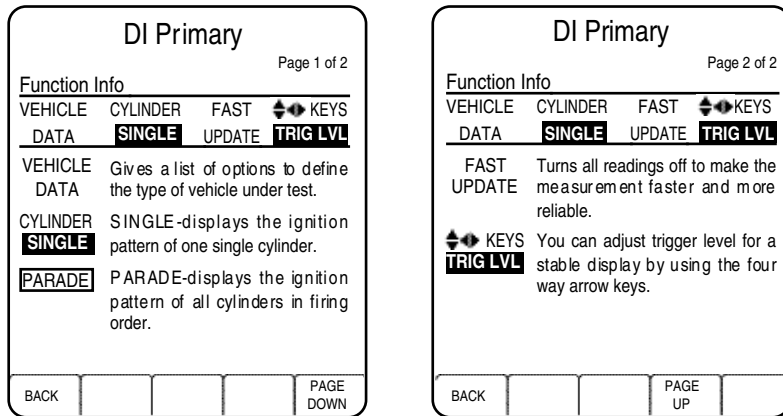

Figure 7. Information About the Function keys

Screen Displays

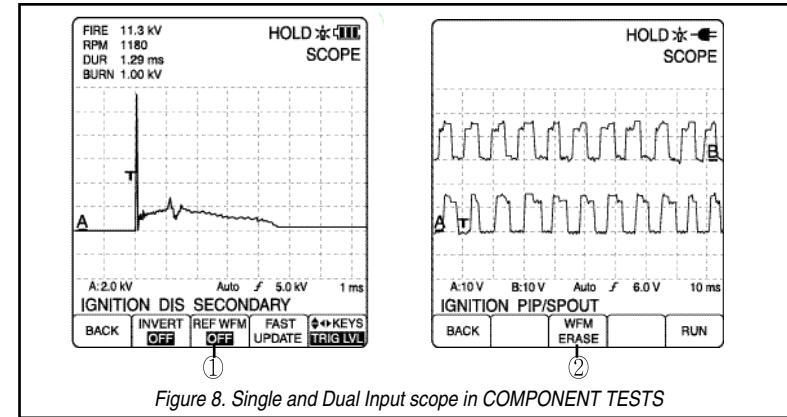

Figure 8. Single and Dual Input scope in COMPONENT TESTS

Use Dual Input Scope mode if you want to simultaneously measure two waveforms - one on INPUT A and the other on INPUT B.

- ① Use SINGLE INPUT SCOPE mode if you want to measure a single signal, INPUT B is turned off.
- ② Use DUAL INPUT SCOPE mode if you want to simultaneously measure two signals.

Using the Function keys

For each test, one or more Function Key Labels are displayed, depending on the sub-selections possible. The Labels indicate what the keys do when you press them. (See the following example.)

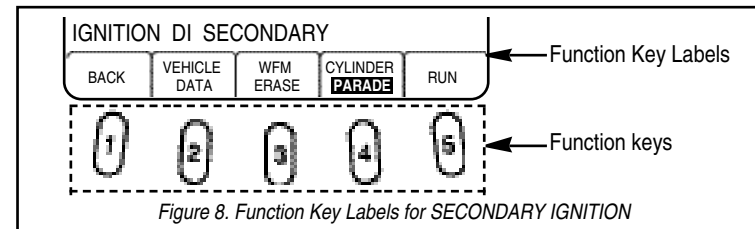

Figure 8. Function Key Labels for SECONDARY IGNITION

Pressing a function key that has no label has no effect.

The same Function Key Label can appear in several tests and it performs a similar function.

Examples of Function Key Labels

CYLINDER PARADE Two separate functions can be allowed to the same function key. You can use the function key to toggle between the functions. When you press **4**, you can select between PARADE and SINGLE cylinder test.

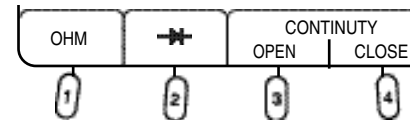

When you press **1**, OHM becomes the active function. When you press **2**, Diode (**+**) becomes the active function. When you press **3**, OPEN CONTINUITY becomes the active function. Pressing **4**, CLOSE CONTINUITY becomes the active function.

 KEYS
RANGE A
MOVE A
TRIG LVL
SENS LVL

The  KEYS icon indicates that you can use the Four Way arrow keys to change Volt & Time ranges, to move the waveform position, and to adjust the trigger level for either INPUT A or INPUT B. And also you can use the Four Way arrow keys to adjust the sensitivity level in the COMPONENT TEST (IGNITION mode).

Press  to toggle among **RANGE A**, **MOVE A**, **TRIG LVL**, and **SENS LVL** for INPUT A, or among **RANGE B**, **MOVE B**, and **TRIG LVL** for INPUT B.

 KEYS
CURSOR 1
CURSOR 2

The  con indicates that you can use the Four Way arrow keys to move CURSOR 1 (if **CURSOR 1** is highlighted) or move CURSOR 2 (if **CURSOR 2** is highlighted). Press the function key to toggle between CURSOR 1 and CURSOR 2.

REPEAT TEST

This Label is displayed for SINGLE DISPLAY tests, for example the knock sensor test. To repeat the test, press the function key, then perform the required action. The knock sensor test is a single shot measurement, which means that the signal from the knock sensor is displayed only once. To get a new test result, you have to press the  key and then tap the engine block or the sensor again. You may have to readjust the vertical RANGE to get an optimal waveform.

INVERT OFF
ON

To change to the opposite polarity. Puts the waveform display upside down.

GMM MODE

This Label is displayed in the Scope test mode of the COMPONENT TESTS only. To change from Scope test mode to GMM test mode, press the function key.

SCOPE MODE

This Label is displayed in the GMM test mode of the COMPONENT TESTS only. To change from GMM test mode to Scope test mode, press the function key.

GLITCH SNARE

This Label is displayed in the Scope test of the COMPONENT TESTS only. To capture, display, and optionally save abnormal signal patterns when they occur, press the function key.

4.7 SCOPE MODE

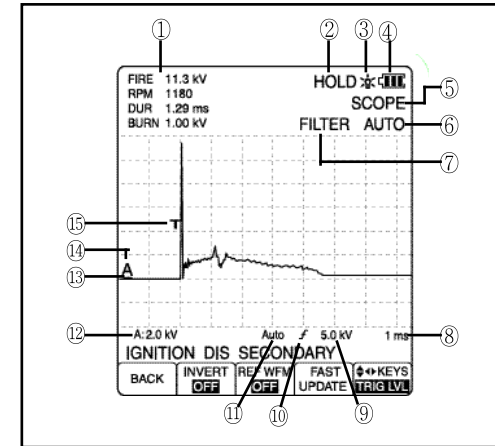



Figure 9. Scope Mode Indicators

SCOPE mode provides a display of signal patterns from either CH A or CH B over times ranging from 1 μ s to 50 seconds per division, and for voltage ranges from 50 mV to 300 V full scale.

The display may be triggered at all time settings, and trigger slope and level may be adjusted as needed. The scope display is defaulted in Glitch Detect mode to display even the narrowest glitches.

The SINGLE INPUT SCOPE mode (Component Tests only) provides for the display of up to four meter measurements above the waveform viewing area.

- ① Indicate meter measurement function.
- ② Indicate HOLD function enabled.
- ③ Backlit indicator.
- ④ Low battery indicator.
- ⑤ Indicate SCOPE mode.
- ⑥ Indicate AUTORANGING mode.
- ⑦ Indicate FILTER function enabled.
- ⑧ Indicate time base per division.
- ⑨ Indicate trigger level voltage.
Blank if DC, ~ if AC.
- ⑩ Indicate trigger slope (rising or falling).
- ⑪ Indicate AUTO triggered.
- ⑫ Indicate voltage per division and coupling.
Blank if DC, ~ if AC,  if GND.
- ⑬ Indicate signal source channel.
- ⑭ Indicate INPUT A zero level.
- ⑮ Indicate trigger location.

4.8 GMM (GRAPHING MULTIMETER) MODE

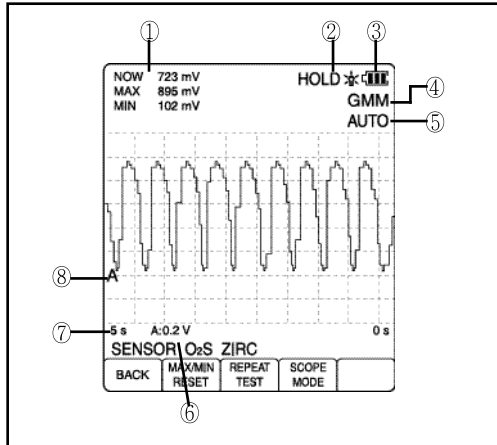



Figure 10. GMM Mode Indicators

GMM mode plots the results of signal measurements such as frequency as the values change with time. The time range in GMM mode may be set manually from 5 seconds to 24 hours per display.

Ranges for the vertical scale may also be set manually, and the available range depends upon the measurement being displayed.

Where possible, measurements plotted in GMM mode are performed on a cycle-by-cycle basis, resulting in extremely fast response.

This mode is very suitable to find faults in slowly changing processes.

- ① Indicate meter measurement functions.
NOW: Most recent meter reading.
MAX: Maximum value since last reset.
MIN: Minimum value since last reset.
- ② Indicate HOLD function enabled.
- ③ Low battery indicator.
- ④ Indicate GMM mode.
- ⑤ Indicate AUTORANGING mode. Pressing AUTO () sets automatic ranging on. Using the Four Way arrow keys for ranging turns automatic ranging off and extinguishes AUTO.
- ⑥ Indicate voltage per division.
- ⑦ Indicate time per display.
- ⑧ Indicate signal source channel.

5. INSTRUMENT OPERATION

5.1 INSTRUMENT TEST MODES

From the MAIN MENU, you can choose 3 independent instrument test modes:

- COMPONENT TESTS
- SCOPE
- GRAPHING MULTIMETER

The fastest way to set up the instrument to test most devices and circuits is to choose from one of the built in COMPONENT TESTS. These tests preset the instrument to either Single or Dual Input Scope mode. Most instrument settings may be adjusted manually once you have chosen a Component Test, enabling you to fine tune settings to get a better look at the signal. Changes you make to settings specific to a Component Test are temporary, and are restored to their preset values each time another test is chosen. When configured for a specific Component Test, the instrument displays the reference waveform and data as well as the name of the test on the bottom display along with the Function Key Labels specific to the test chosen.

If you prefer total control over your instrument configuration, choose SCOPE test mode from the MAIN MENU. Settings for SCOPE are separately preserved and restored each time you choose SCOPE from the MAIN MENU. These settings are not affected when you choose a Component Test. This is also true for the GRAPHING MULTIMETER test mode, so in effect they are “custom” setups.

5.2 SCOPE DISPLAYS

Using Single and Dual Input Scope Mode

The instrument can be configured to show scope displays for either CH A or CH B signals: In DUAL INPUT SCOPE mode, both CH A and CH B may be displayed at the same time. Use SINGLE INPUT SCOPE mode if you want to measure a single signal, INPUT B is turned off. Use DUAL INPUT SCOPE mode if you want to simultaneously measure two signals.

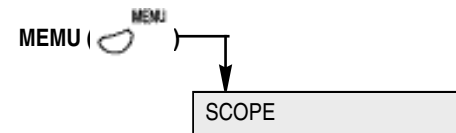

Function keys and Result Screen

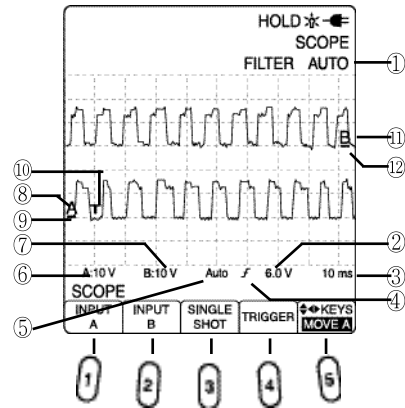

Figure 12. Scope Display

① Automatic ranging and signal tracking is on.

Pressing AUTO () sets automatic ranging and signal tracking on and off. If on, AUTO is displayed, if off, AUTO is disappeared.

② Trigger level voltage of INPUT A.

③ Time base range.

④ Trigger icon. Indicates trigger slope (indicated negative slope).

⑤ Auto triggered.

⑥ INPUT A range setting.

⑦ INPUT B range setting.

⑧ Indicates signal source channel A.

⑨ INPUT A zero level.

⑩ Indicates trigger location.

⑪ Indicates signal source channel B.

⑫ INPUT B zero level.

Making an Easy Setup

When you enter the scope mode, the instrument automatically optimizes vertical range, time base, and trigger settings to create a stable display. (Autoranging is default)

- When you press one of the Voltage and Time control keys, the instrument switches to manual control of range and trigger settings.
- Press AUTO () to toggle between automatic and manual control of range and trigger settings. Use this key if you cannot get a stable display using manual control.

SCOPE displays are defaulted in “Glitch Detection” mode. This means that all signals are sampled at the full sample rate of the instrument and the minimum and maximum excursions are always shown on the display, even if the horizontal time setting is too slow to show each individual sample interval. In this mode, every noise spike of 40 ns and wider will be displayed.

INPUT A Control Functions

When you are in SCOPE, you can control the INPUT A functions as follows:

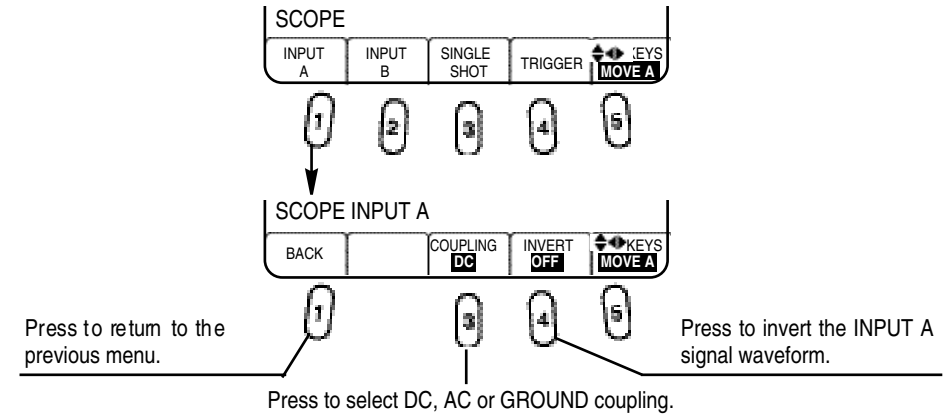

DC Coupling allows you to measure and display both the DC and AC components of a signal. AC Coupling blocks the DC component and passes the AC component only. GND grounds the input of the instrument internally.

INPUT B Control Functions

When you are in SCOPE, you can control the INPUT B functions as follows:

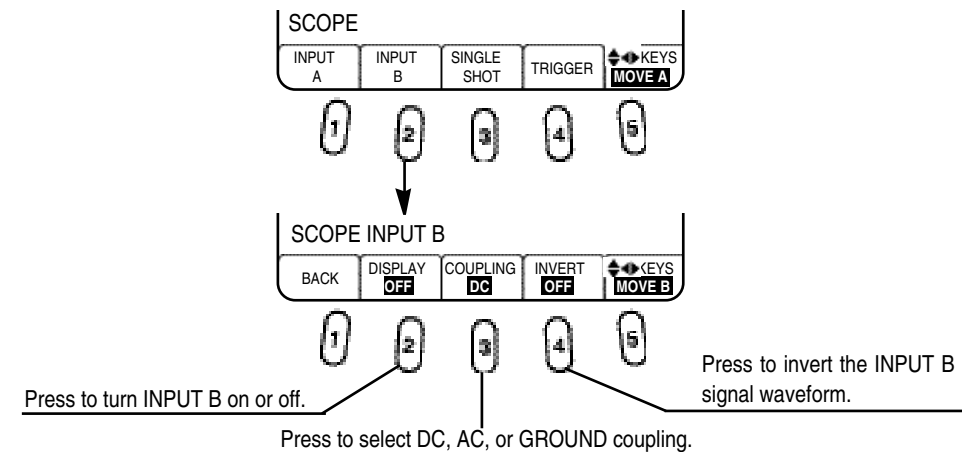

When you entered SINGLE DISPLAY, INPUT B is turned off by default, but you can turn it on by pressing F2.

Single-Shot Function

Normally the scope mode automatically repeats the measurements to acquire waveforms by the recurrent acquisition mode.

SINGLE-SHOT allows you to perform single acquisition to snap events that occur only once. REPEAT TEST () is used to start a next single acquisition.

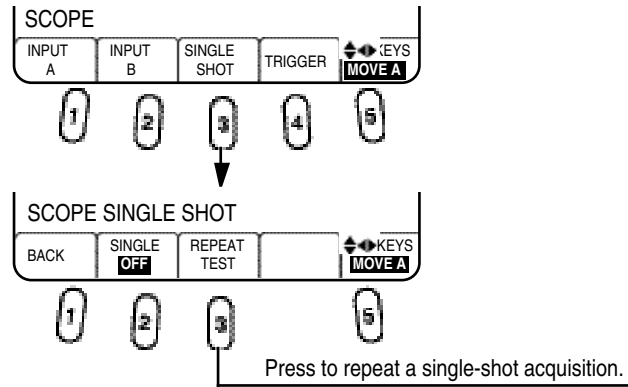

Trigger Control Functions

TRIGGER is a set of conditions that determine whether and when acquisitions start. The following will determine the trigger conditions:

- Select INPUT A or TRIGGER as the TRIGGER SOURCE input.
- Use AUTO or NORMAL acquisitions.
- Select trigger to occur on a positive or negative SLOPE of the signal.
- SET the trigger LEVEL.

If you change the trigger level, the AUTO RANGE function is turned off.

When you are in SCOPE, you can control the trigger functions as follows:

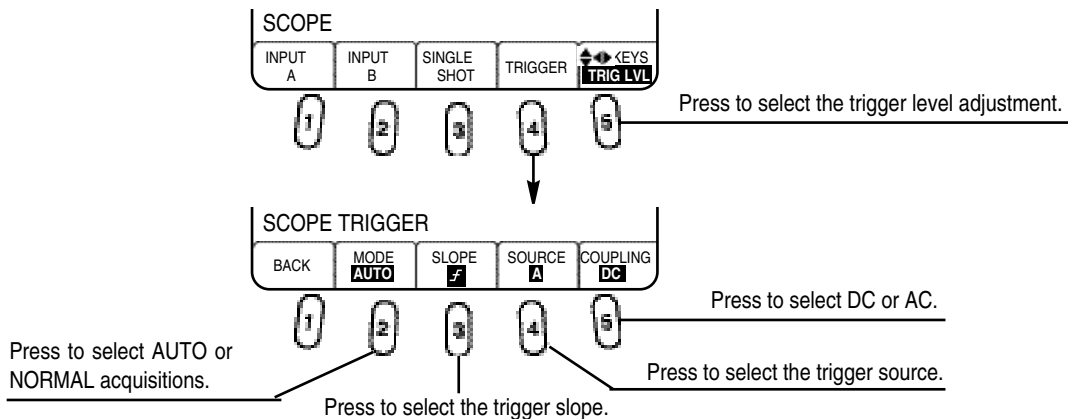



5-4

AUTO versus NORMAL acquisitions

If you select AUTO, the instrument always performs acquisitions, i.e., it always displays the signals on the input. If NORMAL is selected, a trigger is always needed to start an acquisition.

TRIGGER SLOPE

If you select , trigger occurs at a rising(positive) edge of the signal.

If you select , trigger occurs at a falling(negative) edge of the signal.

TRIGGER SOURCE



If you select TRIGGER SOURCE A (default), acquisitions start when the signal on INPUT A fulfills the selected trigger conditions.

If you select TRIGGER SOURCE TRIG, the previous rule is valid for the signal on the TRIGGER input.

TRIGGER LEVEL

This function allows you to set the level that the signal must cross to trigger acquisitions.

Normally, after you enter SINGLE or DUAL INPUT SCOPE mode, the AUTO RANGE function automatically sets and maintains an optimal trigger level as the signal changes.

Move the  trigger level icon (or  icon) to the desired level by using ▲ and ▼ keys

HORIZONTAL TRIGGER POSITION (HORIZ TRIG POS)

You can use the INSTRUMENT SETUP menu to set the Horizontal Trigger Position (Horiz Trig Pos) to three different horizontal locations on the display, depending on whether you want to see conditions that led up to the trigger event, or those following it.

- 10 % Trigger located close to left edge of display.
- 50 % Trigger located at center display.
- 90 % Trigger located close to right edge of display.

Use 10 % Trigger to show events which happen after the trigger.

Use 90 % Trigger to show events leading up to the trigger.

Noise Filter Function

There are cases where you may want to filter out noises in order to see a better signal. This can be especially true when ignition noise is present. The instrument provides a noise filter for each input channel which reduces the bandwidth from its normal 5 MHz to 2 KHz. You can enable or disable CH A Filter or CH B Filter using the INSTRUMENT SETUP menu. When enabled, the FILTER indicator appears on the screen.

5-5

Cursor Key Function



A cursor is a vertical line or a horizontal line placed over the displayed waveform to measure values at certain points. The instrument can measure signal details by using Cursors. This function is not possible for all tests.

Press CURSOR () to display the Function key Menu for cursor operation.

If cursor operation is not possible for the actual measurement, the instrument beeps to alert you. Two cursors (vertical lines) appear on the display.

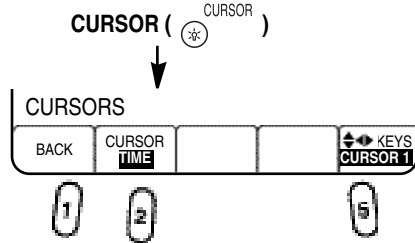
The left cursor is named CURSOR 1, the right CURSOR 2.



- Press  to set TIME cursor or VOLTS cursor or cursor OFF.
- Press  to select the cursor you want to move (1 or 2).
- Use the Four Way arrow keys to move the cursors.

The top display shows readings related to values at the cursor positions.

For TIME cursors,

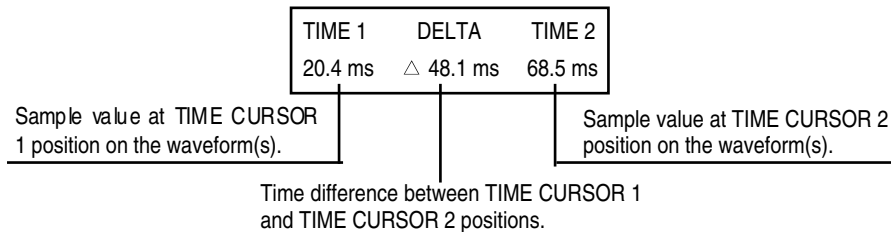

For VOLTS CURSORS,

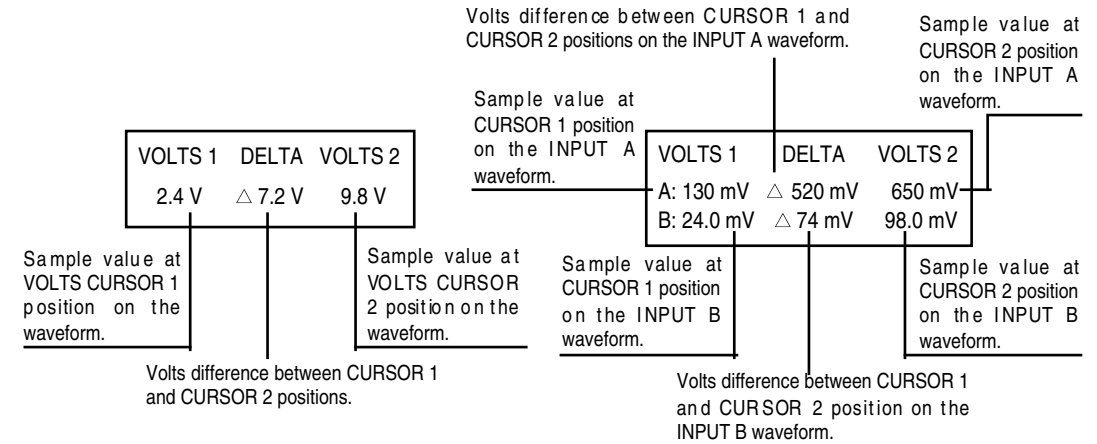

Reading Test Results on the SCOPE (Component Tests only) Display

Measurement results can be displayed as numeric values (referred to as readings) and waveform. The types of readings depend on the test taking place.

For example, during a O2S SENSOR (Zirc) test, MAXIMUM and MINIMUM values are displayed as readings and during a DUAL O2 SENSOR test MAXIMUM and MINIMUM values of the signals from the oxygen sensor before and after the catalytic converter are displayed as readings. During a DI SECONDARY test, SPARK VOLTAGE, RPM, BURN TIME, and BURN VOLTAGE are displayed as readings.

The values you see on the display most often depend on the vehicle under test. Refer to the Service Manual of the vehicle manufacturer.

In Chapter 6 "Automotive Diagnostics & Applications" you can find typical results of certain applications.

5.3 GMM DISPLAYS

The instrument performs cycle by cycle measurements of a variety of signal characteristics in Real Time and plots them as they change with time as a graph. The instrument also performs certain other measurements on a continuous basis, delivering the results for graphing 20 times per second. You can also plot the input signal directly (as in SCOPE mode) by choosing LIVE.

The GMM display includes a meter reading showing the current value of the graphed parameter. This reading is an average over many result values. In some cases, measurements are the maximum or minimum of a series of signal values over the most recent 1 second interval.

The following table shows measurements which can be plotted in GMM displays and the type of graphing and readout.

Code	Measurement	Graphing Type
DC VOLT	DC Average	Continuous
AC VOLT	AC Average	Continuous
AC+DC VOLT	AC+DC Average	Continuous
OHM	Ohms	Continuous
DIODE	Diode drop	Continuous
CONTINUITY	Continuity	Continuous
RPM	RPM	Cycle by Cycle
FREQUENCY	Frequency	Cycle by Cycle
DUTY CYCLE	Duty Cycle	Cycle by Cycle
PULSE WIDTH	Pulse Width	Cycle by Cycle
DWELL	Dwell	Cycle by Cycle
IGNITION PEAK VOLTS	Ignition Peak Volts	Cycle by Cycle
IGNITION BURN VOLTS	Ignition Burn Volts	Cycle by Cycle
IGNITION BURN TIME	Ignition Burn Time	Cycle by Cycle
INJECTOR PEAK VOLTS	Injector Peak Volts	Cycle by Cycle
INJECTOR ON TIME	Injector On Time	Cycle by Cycle
TEMPERATURE	Temperature °C, °F	Continuous
LIVE	Live	Direct input samples

Vertical and Horizontal Scaling

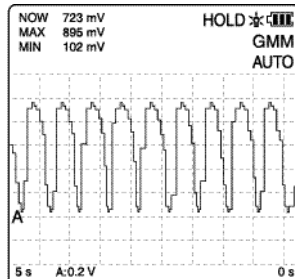

Figure 13. Changing Vertical and Horizontal Ranges

The vertical and horizontal ranges in GMM displays are manually adjustable by using the Four Way arrow keys.

The vertical ranges available in GMM displays vary with the measurement being graphed, and generally cover the possible output range of the measurement.

The time ranges available for GMM displays range from 5 sec. to 24 hrs. per display.

Auto-Power-Off will not occur during the GMM mode, but to graph for periods of 5 min and longer, operate the instrument from external power because operating endurance on internal power is limited to about 4 hours with fresh batteries.

Using Graphing Multimeter (GMM)

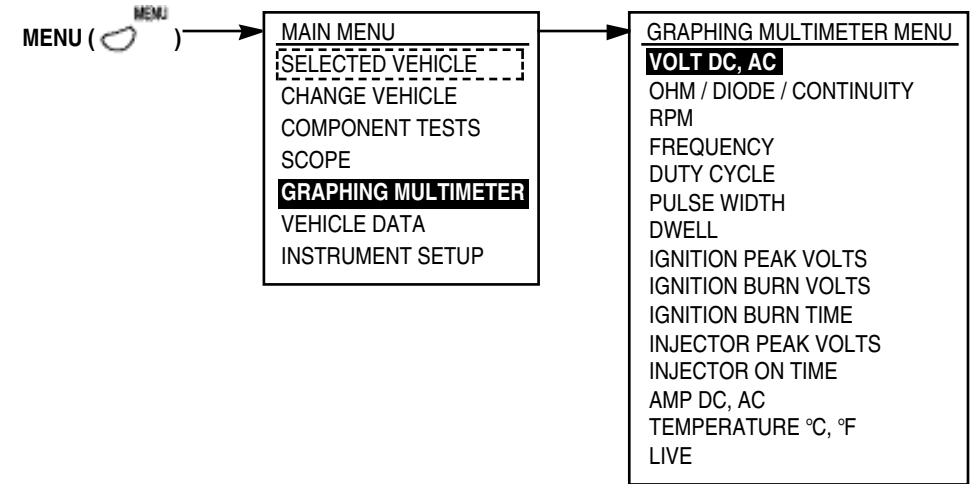

Making Connections

INPUT A is used for all GMM tests just except the RPM measurement. The probes and test leads to be used depend on the type of test performed. When you select certain GMM tests, a connection help screen will guide you by pressing HELP (HELP). This tells you which probe or test lead to use and where to connect it.

Function Key Labels for Each Test

Testing Volt DC, AC

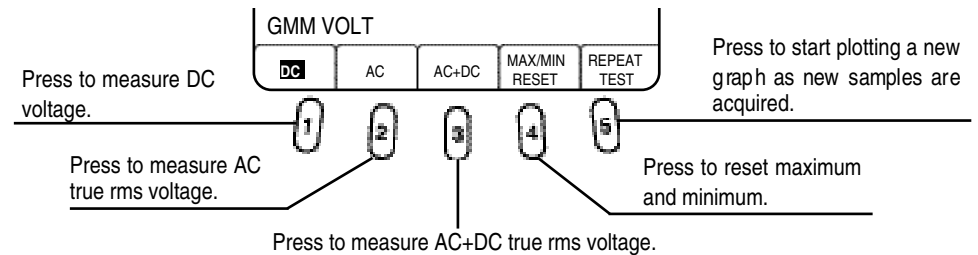

You can stop graphing by pressing HOLD key on the instrument.

Testing Resistance, Diode, and Continuity

Use this menu option to test resistance, diode forward voltage, and the continuity of wiring and connections. Connect the test lead tip and test lead ground across the object to be tested.

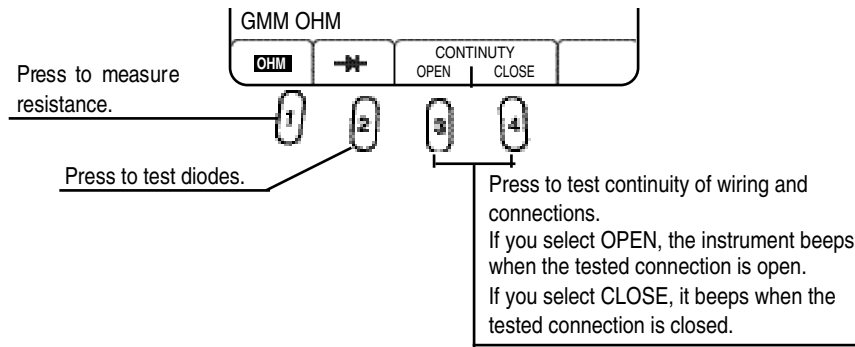

OFL is displayed when the resistance is outside the instrument's maximum range. This occurs when the resistance of the sensor is too high or the connection to the sensor is interrupted or open.

To test a diode, the instrument sends a small current through the diode to test the voltage across it. Depending on the type of diode, this voltage should be in the range from 300 to 600 mV. A diode that has an internal short will display about 0 V. **OFL** is displayed when the diode is defective or when it is connected in reverse. If you are not certain about the polarity of the diode, try the reverse connection. If this also displays **OFL**, the diode is defective. A good diode must display **OFL** when connected in reverse.

Measuring RPM

The instrument automatically scales and displays the waveform on the screen. Connect the Inductive Pickup to the COM/TRIGGER input terminals and clamp the pickup probe on the spark plug wire close to the spark plug.

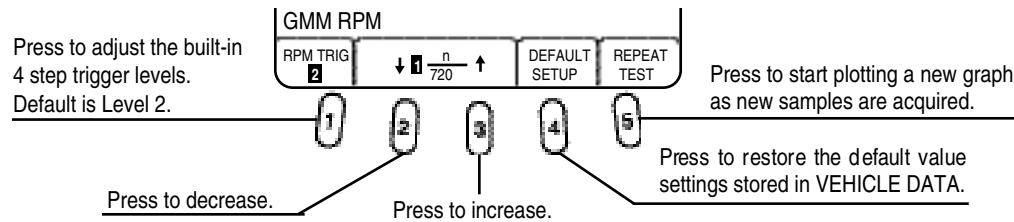

2 and **3** keys are used to set the number of Spark Signal Pulses to the instrument per 720 (two crank shaft revolutions). n = 1, 2, 3, 4, 5, 6, 8, 10, or 12

Testing Frequency, Duty Cycle, or Pulse Width

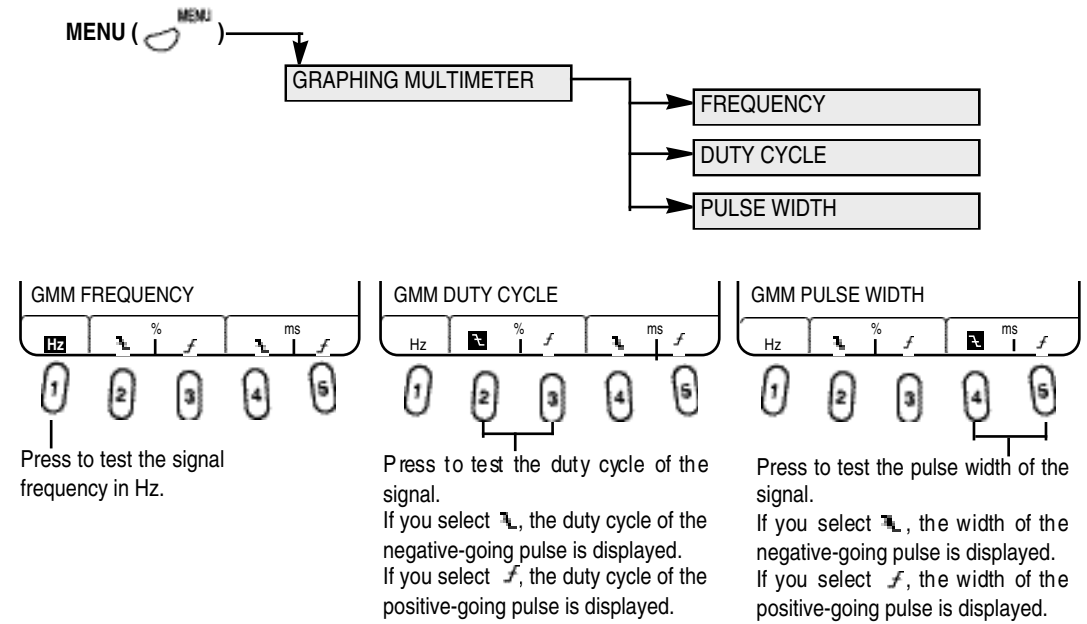

Testing Secondary Ignition Peak Volts, Burn Volts, and Burn Time

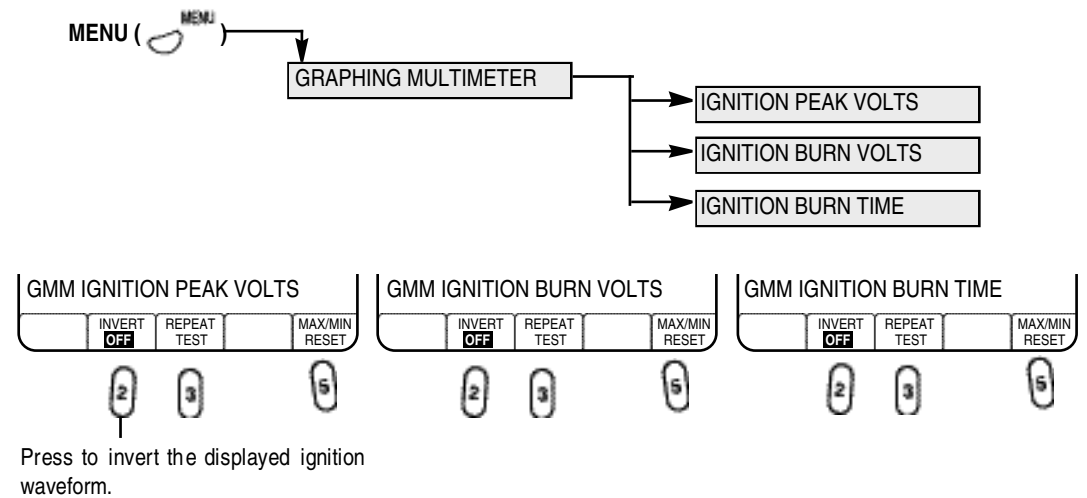

Press to invert the displayed ignition waveform.

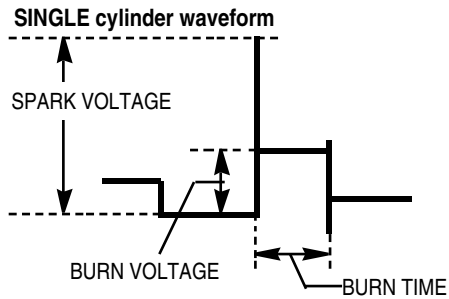

Testing Injector Peak Volts and On Time

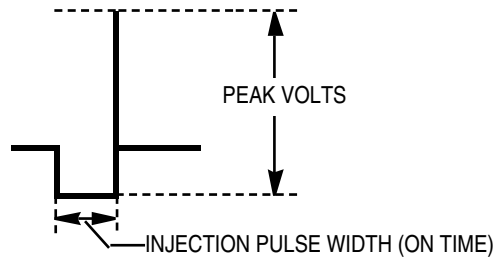
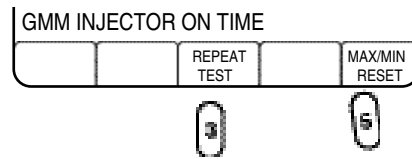
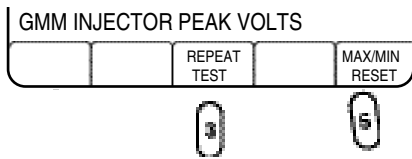
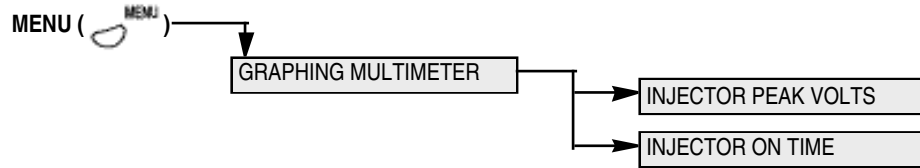

Testing Dwell

The test is done with the shielded test lead on INPUT A connected to the primary side of the ignition coil.

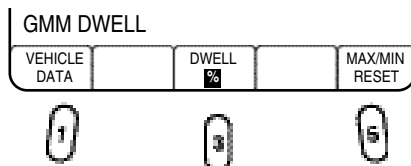

Press to select between readings in %, degrees (°) crankshaft rotation, or in ms.

Testing Current

Use this menu option to test current with a current probe. (optional accessory)

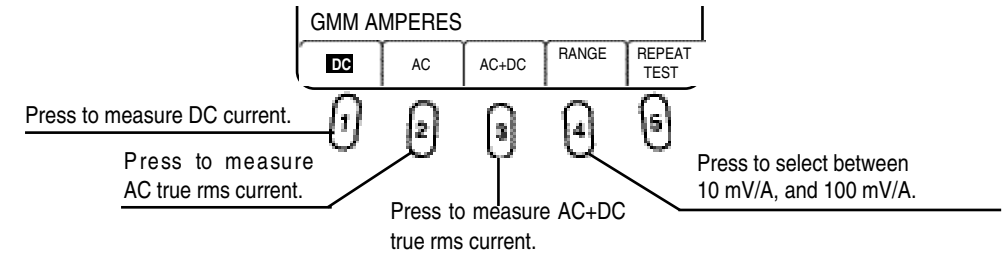

Don't forget to set the Current Probe to zero before using it for measurements.

Testing Temperature

Use this menu option to test temperature with a temperature probe. (optional accessory)

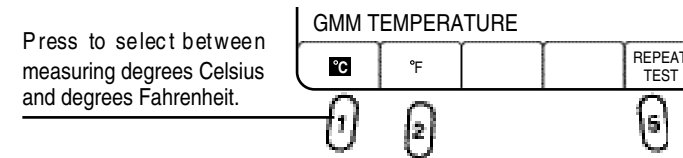

5.4 DUAL INPUT SCOPE OPERATION

Dual Input Scope

Use the scope function if you want to simultaneously measure two waveforms - one on INPUT A and the other on INPUT B.

Using Single and Dual Input Scope

Use SINGLE INPUT SCOPE if you want to use a single signal, INPUT B is turned off.
Use DUAL INPUT SCOPE if you want to simultaneously measure two signals.

5.5 CHANGING THE VEHICLE DATA & INSTRUMENT SETUP

There are two groups of setups in the Main Menu.

VEHICLE DATA : Use this menu option to enter the correct vehicle data, such as the number of cylinders or cycles on the vehicle under test.

INSTRUMENT SETUP : Use this menu option to set the following:

- Optimal settings for display.
- Optimal settings for noise filter to each INPUT.
- Auto-Power-Off ON and OFF and adjusting Auto-Power-Off Time.
- Language for menus and help text.
- Scope Calibration

Changing Vehicle Data

If the vehicle data do not match with the vehicle under test, you could get incorrect test results and may not be able to select all available tests for this vehicle. Because this menu is very important for the proper use of the instrument, it also appears at power-on as the start-up display.

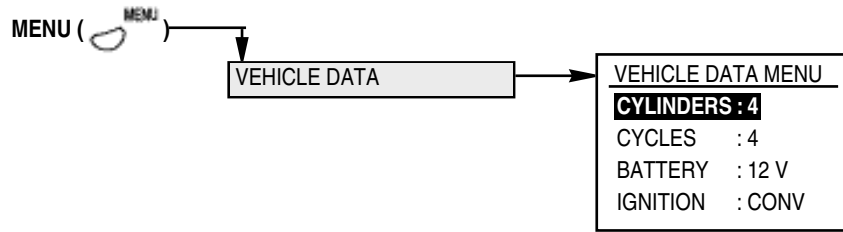

CYLINDERS: 1, 2, 3, 4(default), 5, 6, 8, 10, or 12. Specifies the number of cylinders on the vehicle under test.

CYCLES: 2 or 4(default). Specifies a two-or four-stroke engine.

BATTERY: 12 V (default) or 24 V. Specifies battery voltage.

IGNITION: CONV (default), DIS, or DIESEL.
Specifies the type of ignition system.
CONV (conventional) indicates systems using a distributor.
DIS (or EI) indicates Distributorless Ignition Systems.
DIESEL indicates ignition systems of Diesel engine.

Changing Instrument Setup

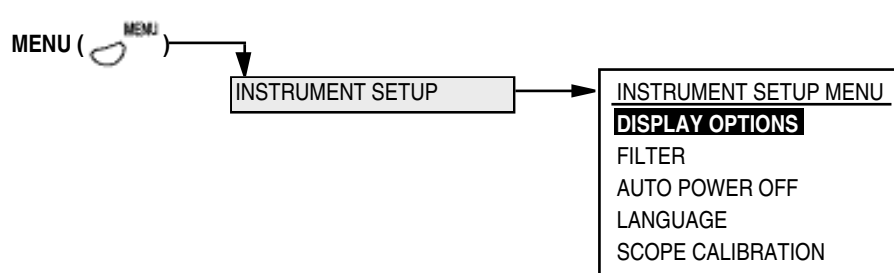

DISPLAY OPTIONS MENU

USER LAST SETUP: You can change the Power-On display from VEHICLE DATA MENU (default) to the last display having been displayed just before the instrument was turned off.

CONTRAST: This setting, expressed as a percentage, determines the contrast ratio between display text or graphics and the LCD background. 0 % is all white. 100 % is all black. In practice, the percentage will be somewhere between 30 % and 80 %, to have a good readable display. You can also change contrast by pressing the LIGHT key and keeping it pressed until you reach the desired contrast level.

GRATICULE: Can be set On or Off (default is On). A dot type graticule assists in making visual voltage and timing measurements. The distance between adjacent dots is one division. The graticule also allows you to easily compare wave forms between CH A and CH B and stored waveforms for timing and voltage differences.

HORIZ TRIG POS: Horizontal Trigger Position can be set to three different horizontal locations (10 %, 50 %, or 90 %) on the display, depending on whether you want to see conditions that led up to the trigger event, or those following it.

ACQUIRE MODE: Can be set to Peak Detect mode (default) or Normal mode.

- Peak Detect - This is the default mode to detect glitches and reduces the possibility of aliasing.
- Normal - Use to acquire 480 points and display them at the SEC/DIV setting.

< Key Points >

If you probe a noisy square wave signal that contains intermittent and narrow glitches, the waveform displayed will vary depending on the acquisition mode you choose.

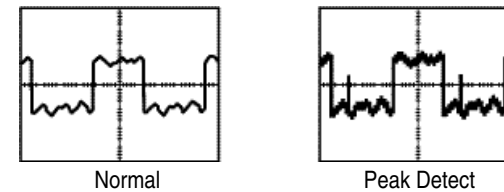

The next two topics describe each of the types of acquisition modes and their differences.

Peak Detect. Use Peak Detect acquisition mode to detect glitches as narrow as 1 μ s and to limit the possibility of aliasing. This mode is effective when at 10 μ s/div or slower.

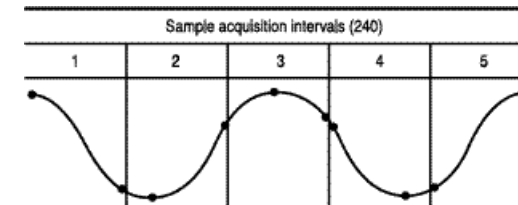

- Sample points displayed
- Peak Detect mode displays highest and lowest acquired voltage in each interval.

Normal. Use Normal acquisition mode to acquire 480 points and display them at the SEC/DIV setting.

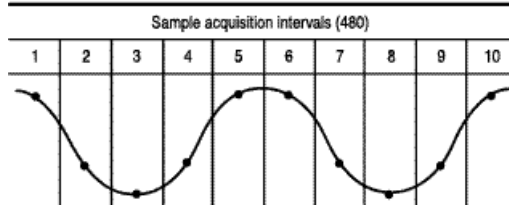

• **Sample points**

Normal mode acquires a single sample point in each interval.

The maximum sample rate is 25 MS/s. At 10 μ s and faster settings, this sample rate does not acquire 480 points. In this case, a Digital Signal Processor interpolates points between the sampled points to make a full 480 point waveform record.

FILTER MENU: Can be set On or Off (default is Off) for each INPUT.

- Off - Passes all signal components up to 5 MHz.
- On - Passes signal components up to 2 KHz.

Turn on this option to reduce noises in scope displays and measurements.

AUTO POWER OFF MENU

AUTO POWER OFF: You can adjust the Auto-Power-Off time between 5 minutes and 120 minutes.

LANGUAGE MENU

LANGUAGE: This setting is used to select the local language or English for the information text display. This option is not available if only one language is implemented.

SCOPE CALIBRATION MENU

SCOPE CALIBRATION: This setting is used to minutely calibrate the scope under the following operating environments.

- When measuring in extremely hot or cold places.
- When the inner temperature of the scope was increased very greatly due to its long operation.

Press **5** when SCOPE CALIBRATION is highlighted to activate this setting.

5.6 FREEZING, SAVING, AND RECALLING SCREENS

Hold Mode

The HOLD key enables you to freeze the current display. This makes it possible to examine occasional waveform anomalies and to stop the GMM mode at the end of a manual sweep test.

The instrument provides eight memory locations to which you can save the current screen along with its setup.

Press HOLD () to freeze the current display and show the Function key Menu to save, recall, or to clear the memory. HOLD indicator appears in the top right of the display when the HOLD key is pressed.

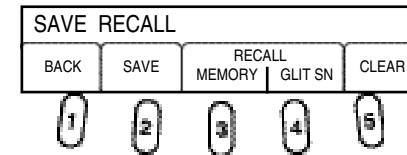

Press **1** to resume measuring or to return to the previous display.

Press **2** to save the present screen in the next free memory location.

- A message is displayed to tell you in which memory location the screen is saved.

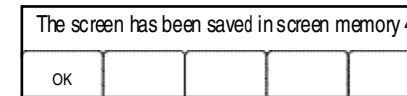

1

- When all memory locations are filled from previous save actions, a message is displayed asking to overwrite a memory location (press **1** or to cancel saving (press **2**).

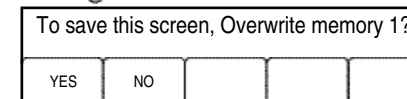

1

2

Press **5**, if necessary, to clear all the memory locations.

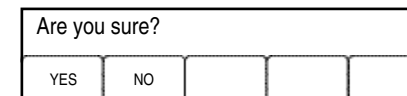

1

2

Press **3** to recall the screen last saved in memory or press **4** to recall the screen last saved in the Glitch Snare mode.

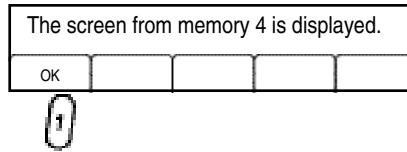

- Press **1** to remove the message and the following Function Key Labels will be displayed on the screen.

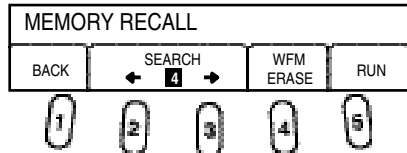

- Use **2** and **3** to display the previous or the next screens in memory. These keys are effective only if more than one screen has been saved in memory. The number indicates the recalled memory location.

Press **5** to select the displayed screen. The instrument activates the settings that are valid for the recalled screen to test the input signal.

5.7 GLITCH SNARE OPERATION

Glitch Snare is a powerful combination of capabilities which enables you to reliably capture and display Actual Signal Waveforms associated with elusive and unusual signals.

Glitch Snare combines real-time measurements with specially designed scope trigger facilities, monitoring measurement results on an event by event basis and triggering on any result which deviates above or below the norm by more than a present limit. The input signal is captured at the moment when a trigger event occurs.

Imagine the frequency graph from an ABS sensor with an occasional dropout due to an intermittent short in the cable. As the wheel spins, the frequency output is stable until it briefly drops out due to the short. A graph of the frequency shows a stable value until the short occurs. At that instant the graph shows a sharp spike downward indicating that the frequency went to zero. Now imagine being able to set "trigger thresholds" above and below the stable frequency value shown on the graph so that when the downward spike on the graph occurs, a trigger event is generated. This is the essence of Glitch Snare operation.

When ordinary scopes try to detect dropouts and other sudden changes in continuous AC signals, the majority of the signal is ignored because these instruments only display new waveforms at the rate of a few per second. Therefore, it is not easy for them to capture and display the occasional glitch or dropout. And if an interesting event does happen to be captured, it is soon overwritten with the next normal event, making detailed examination impossible.

The Glitch Snare operation triggers only on abnormal signal conditions, which virtually guarantees you'll catch the first event to come along. The captured signal waveform remains displayed in the Glitch Snare display for you to examine until it is overwritten by the next unusual event.

What's more, by enabling the Auto Save option, each new event to be detected is automatically saved to Memory 1 to Memory 4. By setting the Auto Save option, you can automatically fill up all four memories with the four most recent unusual events.

Best of all, Glitch Snare operation is completely automatic. Trigger thresholds are calculated automatically based on recent signal history. The measurement used as a basis for Glitch Snare operation is Period by default. Certain COMPONENT TESTS use other measurements, and some tests disable Glitch Snare when it is inappropriate.

Glitch Snare is most useful with continuous AC or digital signals where the information is embedded in the signal's frequency, pulse width or duty factor.

To enable Glitch Snare operation, press the Glitch Snare function key in the Scope mode of the COMPONENT TESTS. If Glitch Snare is available for the current test, the instrument will display the Glitch Snare display in a line along with a conventional scope display in a solid line for comparison. Vertical and horizontal settings for both displays are matched.

For example,

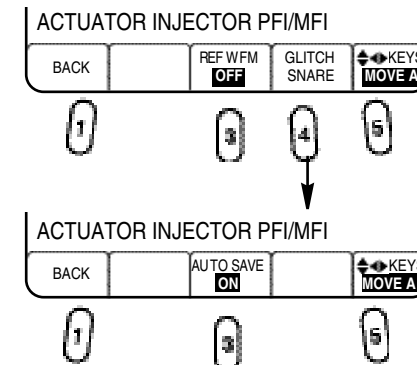
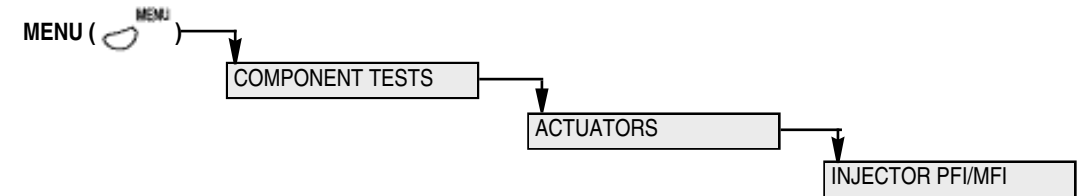

5.8 TIPS FOR NOISE MANAGEMENT

The instrument is very sensitive to spikes and other noise pulses which may be present on automotive signals. While this capability can be valuable when tracking down glitch related problems, it can also obscure the signal you really want to see in DC circuits such as power distribution.

If noise is obscuring the signals you want to see, try the following tips:

Using the Internal Battery Power

In general, noise pickup is minimized when you use this instrument on its internal battery power. Using the standard Shielded Test Leads supplied will help in noise rejection

Noise Filter

Turn on the Filter (INSTRUMENT SETUP menu) for the input channel you are using. This blocks frequencies above 2 kHz and should reduce ignition impulse noises and other noises of the short spike variety.

Ground Connections

Many sensors output signals are "single ended" meaning that a single output pin delivers the signal with being referred to a ground pin also on the sensor. In order for the signal to be accurately delivered to the PCM, however, both the signal and ground parts of the circuit should be sound. If a sensor output signal at the PCM appears to be erratic or its level appears incorrect, check the signal at the output pins of the sensor (both signal and ground connections). If the signal is correct, suspect the wire harness of either the signal or the ground side. Check for voltage drops in both the signal and the ground paths between the sensor and the PCM.

Never trust that a chassis ground connection is the same as the PCM or the sensor ground. The ground continuity can be disrupted by a missing strap or loose fastener easily.

6. AUTOMOTIVE DIAGNOSTICS & APPLICATIONS

6.1 COMPONENT TESTS

Preset Operation

The instrument provides predefined setups for a variety of vehicle sensors and circuits. To choose a preset test, select COMPONENT TESTS from the MAIN MENU. From the resulting menu, select a test group:

- SENSORS
- ACTUATORS
- ELECTRICAL
- IGNITION

Then select a specific test from those listed. Each test places the instrument in a configuration best suited to display signals for the chosen device or circuit. Once a test has been selected, you can obtain some useful reference informations specific to that test at any time by pressing the HELP key as previously described.

In some cases there are more than one test for a particular device. If you are not sure which test to use, the descriptions to the tests in the following sections would help you decide.

When you want to test a device for which no test is provided, choose a test for a similar device. For example, to test a temperature sensor not listed, try the Fuel Temp Sensor test. Or choose SCOPE from the MAIN MENU and configure the instrument manually as needed.

After you chose a preset test, you may change most instrument settings as needed to get a better look at the signal. You can even change the display type between SCOPE mode and GMM mode.

6.2 SENSOR TESTS

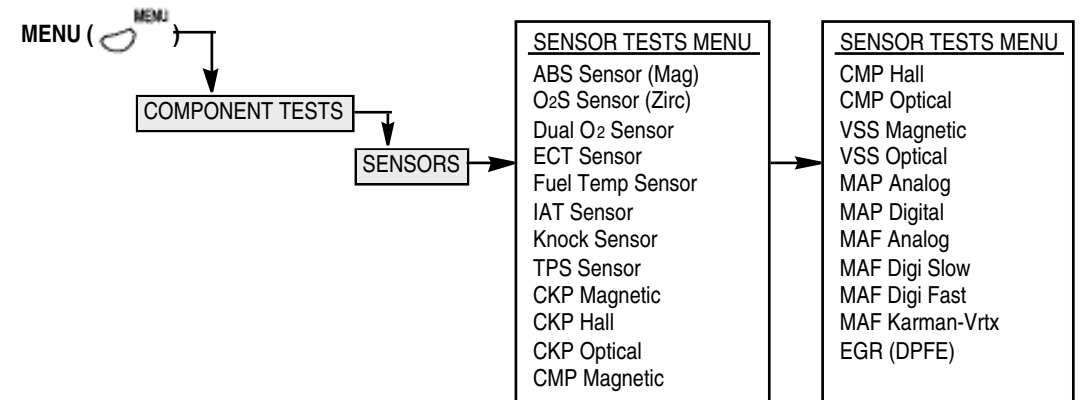

ABS Sensor-Magnetic

• Theory of Operation

ABS (Anti-lock Brake System) wheel speed sensors generate AC signals with frequency proportional to wheel speed. The amplitude (peak to peak voltage) increases as the wheel speed increases and is greatly affected by air gap between the magnetic tip and the reluctor wheel. The ABS computer compares the frequencies and uses this information to maintain wheel speeds while braking.

This test shows the sensor's raw output signal or the frequency proportional to wheel speed. The sensor's output signal should be continuous as long as the wheel rotates. Spikes or distortion of individual output pulses may indicate occasional contact between the sensor and the reluctor wheel.

• Symptoms

ABS light on, no ABS signal generation

• Test Procedure

1. Connect the shielded test lead to the CH A input and connect the ground lead of the test lead to the sensor output LO or GND and the test lead probe to the sensor output or HI. (Use a wiring diagram for the vehicle being serviced to get the ABS control unit pin number, or color of the wire for this circuit.)
2. Drive vehicle or spin the wheel by hand to generate signal.
When driving vehicle, back probe the connector leading to the sensor. Place the transmission in drive, and slowly accelerate the drive wheels.
If the sensor to be tested is on a drive wheel, raise the wheels off the ground to simulate driving conditions. Key OFF, Engine OFF (KOEO).
3. Use the Glitch Snare mode to detect spikes and dropouts.
4. Compare ABS sensors on all wheels for similarities.

• Reference Waveform

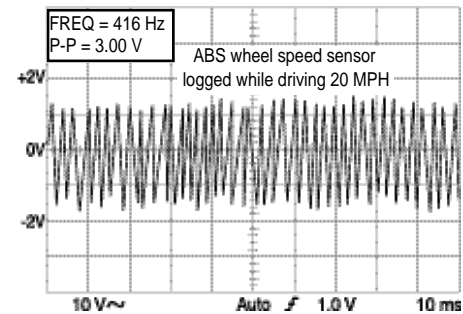

VEHICLE INFORMATION

YEAR : 1989
MAKE : Acura
MODEL : Legend
ENGINE : 2.7 L
FUELSYS : Multiport Fuel Injection
PCM_PIN : Pos Grn Blu pin 13
Neg Brn pin 18
STATUS : KOBD (Key On Driven)
RPM : 1200
ENG_TMP : Operating Temperature
VACUUM : 18 In. Hg
MILEAGE : 69050

Amplitude and Frequency increase with wheel speed. Output signal should be stable and repeatable without distorted pulses.

• Troubleshooting Tips

If the amplitude is low, look for an excessive air gap between the trigger wheel and the pickup.

If the amplitude wavers, look for a bent axle.

If one of the oscillations looks distorted, look for a bent or damaged tooth on the trigger wheel.

O₂S Normal - Zirconia

• Theory of Operation

An O₂ sensor provides an output voltage that represents the amount of oxygen in the exhaust stream. The output voltage is used by the PCM to adjust the air/fuel ratio of the fuel mixture between a slightly Rich condition and a slightly Lean condition.

A zirconia-type O₂ sensor provides high output voltage (a Rich condition) and low output voltage (a Lean condition).

A titania-type O₂ sensor changes resistance as the oxygen content of the fuel mixture changes. This results in a low output voltage (from a Rich condition) and a high output voltage (from a Lean condition). Most Titania O₂ sensors are found on MFI (Multiport Fuel Injection) systems.

A voltage swing between 100 mV and 900 mV indicates that the O₂ sensor is properly signalling PCM to control the fuel mixture.

• Symptoms [OBD II DTC's : P0130 ~ P0147, P0150 ~ P0167]

Feedback Fuel Control System's (FFCS's) no entering Closed Loop operation, high emissions, poor fuel economy.

• Test Procedure

1. Connect the shielded test lead to the CH A input and connect the ground lead of the test lead to the sensor output LO or GND and the test lead probe to the sensor output or HI. (Get the color of the O₂ signal wire or PCM pin number from a wiring diagram.)
2. Warm the engine and O₂ sensor for 2-3 minutes at 2500 RPM, and let the engine idle for 20 seconds.
3. Rev the engine rapidly five or six times in 2 second intervals from idle to Wide Open Throttle (WOT). Be careful not to overrev the engine. Engine RPM over about 4000 is not necessary. Just get good snap throttle accel and full decels.
4. Use the HOLD key to freeze the waveform on the display to check the maximum O₂ voltage, minimum O₂ voltage and response time from Rich to Lean.

- Reference Waveform

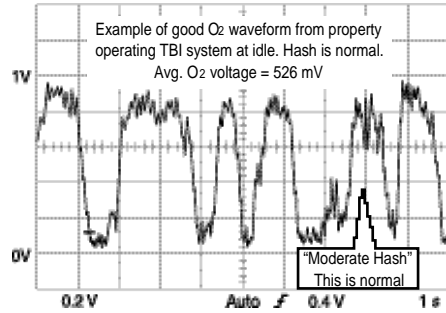

VEHICLE INFORMATION

YEAR : 1995
 MAKE : Plymouth
 MODEL : Acclaim
 ENGINE : 2.5 L
 FUELSYS : Throttle Body Fuel Injection
 PCM_PIN : 41 BkGrn Wire
 STATUS : KOER (Key On Running)
 RPM : Idle
 ENG_TMP : Operating Temperature
 VACUUM : 20 In. Hg
 MILEAGE : 4350

The maximum voltage when forced Rich should be greater than 800 mV. The minimum voltage when forced Lean should be less than 200 mV. The maximum allowable response time from Rich to Lean should be less than 100 ms.

NOTE

For a Titania-type O₂ sensor, change the vertical range to 1 V/div.

- Troubleshooting Tips

The response time increases by aging and poisoning of the O₂ sensor.

Peak to peak voltages should be at least 600 mV or greater with an average of 450 mV.

If the waveform is severely hashy, look for a misfire caused by Rich mixture, Lean mixture, ignition problem, vacuum leak to an individual cylinder, injector imbalance, or carboned intake valves.

IMPORTANT: Don't use a scan tool at the same time you are analyzing the O₂ waveform on the instrument. The PCM may go into a different operating strategy when diagnostics are activated by the scan tool.

Dual O₂ Sensor

- Theory of Operation

Many vehicles utilize dual O₂ sensors within the Feedback Fuel Control System. Both O₂ sensors provide an output voltage that present the amount of oxygen in the exhaust stream respectively before and after the catalytic converter. The leading sensor signal is used as feedback for controlling the fuel mixture. The trailing sensor signal is used by PCM to test efficiency of the catalytic converter. The signal amplitude from the trailing sensor will increase when the efficiency of the catalytic converter declines over years. A good O₂ sensor located downstream from the catalyst should see much less fluctuations than its upstream counterpart during steady state operation. This is due to the properly operating catalyst's ability to consume oxygen when it is converting HC and CO, thus dampening the fluctuations in the downstream sensor's signal. That is, the difference in voltage amplitude from the sensors is a measure for the ability of the catalyst to store oxygen for the conversion of harmful exhaust constituents.

- Symptoms [OBD II DTC's : P0420 ~ P0424, P0430 ~ P0434]

Emissions test failure, poor fuel economy.

- Test Procedure

1. Connect one shielded test lead to the CH A and the other test lead to the CH B. Connect the ground leads of both test leads to the engine GND's and one lead probe to the sensor 1 (upstream sensor) output or HI and the other lead probe to the sensor 2 (downstream sensor) output or HI.
2. Run the engine until the O₂ sensors are warmed to at least 600 °F (315 °C) in closed loop operation.
3. Run the engine at idle while increasing engine speed.
4. Use this test to check the efficiency of the catalytic converter.

- Reference Waveform

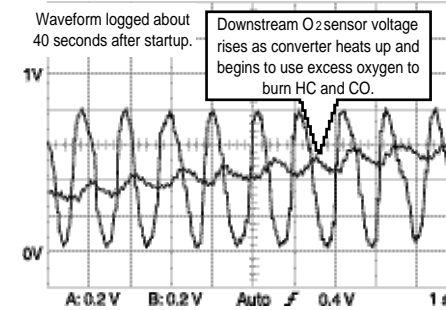

VEHICLE INFORMATION

YEAR : 1990
 MAKE : Lexus
 MODEL : LS400
 ENGINE : 4.0 L
 FUELSYS : Multiport Fuel Injection
 PCM_PIN : 6 OXL1 BIK wire OXL2 24 Grn wire
 STATUS : KOER (Key On Running)
 RPM : 2500
 ENG_TMP : Warming UP
 VACUUM : 21 In. Hg
 MILEAGE : 79369

Good O₂ sensor's output swing between 100 mV and 900 mV indicates that the O₂ sensor is properly signalling PCM to control the fuel mixture. The fluctuations in the downstream sensor's signal are much smaller than that of the the upstream sensor. As the catalytic converter "lights off" (or reaches operating temperature) the signal goes higher due to less and less oxygen being present in the exhaust stream as the catalyst begins to store and use oxygen for catalytic conversion.

• Troubleshooting Tips

When a catalytic converter is totally deteriorated, the catalytic conversion efficiency as well as the oxygen storage capability of the catalytic converter are essentially lost. Therefore, the upstream and downstream O₂ sensor signals closely resemble one another on an inactive converter.

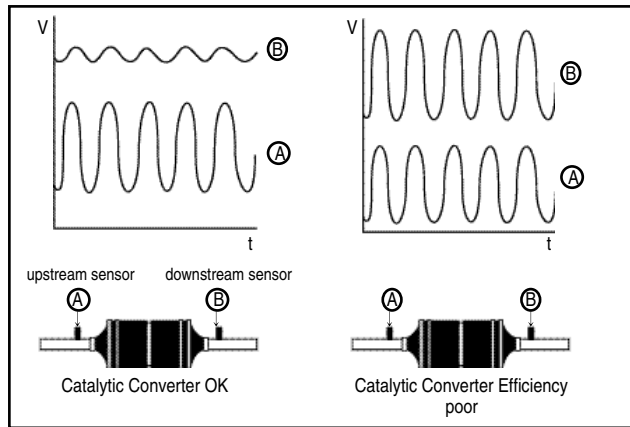

ECT (Engine Coolant Temperature) Sensor

• Theory of Operation

Most ECT sensors are Negative Temperature Coefficient (NTC) type thermistors. This means they are primarily two wire analog sensors whose resistance decreases when their temperature increases. They are supplied with a 5 V V Ref power signal and return a voltage signal proportional to the engine coolant temperature to the PCM. When this instrument is connected to the signal from an ECT sensor, what is being read is the voltage drop across the sensor's NTC resistor.

Typically, ETC sensor's resistance ranges from about 100,000 ohms at -40 °F (-40 °C) to about 50 ohms at +266 °F (+130 °C).

The ETC sensor signal is used by the PCM to control closed-loop operation, shift points, torque converter clutch operation, and cooling fan operation.

• Symptoms [OBD II DTC's: P0115 ~ P0116, P0117 ~ P0119]

No or hard start, high fuel consumption, emissions failure, driveability problems.

• Test Procedure

1. Backprobe the terminals on the ECT sensor with the CH A lead and its ground lead.
2. Run the engine at idle and monitor the sensor voltage decrease as the engine warms. (Start the engine and hold the throttle at 2500 RPM until the trace goes across the screen.)
3. Set the time base to 50 sec/div to see the sensor's entire operating range, from stone cold to operating temperature.

4. Press the HOLD key to freeze the waveform on the display for closer inspection.
5. To measure resistance, disconnect the sensor before changing to the GMM mode and then connect the Ground and CH A leads to the terminals on the sensor.

• Reference Waveform

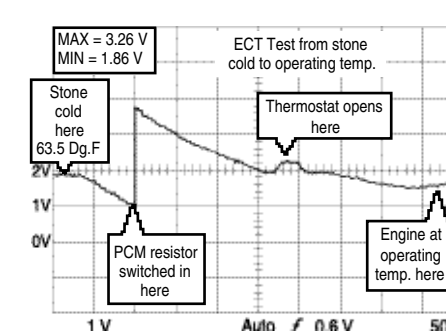

VEHICLE INFORMATION

YEAR	: 1986
MAKE	: Oldsmobile
MODEL	: Toronado
ENGINE	: 3.8 L
FUELSYS	: Multiport Fuel Injection
PCM_PIN	: C10 Yel wire
STATUS	: KOER (Key On Running)
RPM	: 1500
ENG_TMP	: Warming Up
VACUUM	: 18 In. Hg
MILEAGE	: 123686

• Troubleshooting Tips

Check the manufacturer's specifications for exact voltage range specifications, but generally the sensor's voltage should range from 3 V to just under 5 V when stone cold, dropping to around 1 V at operating temperature. The good sensor must generate a signal with a certain amplitude at any given temperature.

Opens in the ECT sensor circuit will appear as upward spikes to V Ref.

Shorts to ground in the ECT sensor circuit will appear as downward spikes to ground level.

Fuel Temp Sensor

• Theory of Operation

Most Fuel Temperature (FT) sensors are Negative Temperature Coefficient (NTC) type thermistors. They are primarily two wire analog sensors whose resistance decreases when their temperature increases. Some sensors use their own case as a ground, so they have only one wire, the signal wire. They are supplied with a 5 V V Ref power signal and return a voltage signal proportional to the temperature to the PCM. FT sensors usually sense the engine's fuel temperature in the fuel rail. When this instrument is connected to the signal from a FT sensor, what is being read is the voltage drop across the sensor's NTC resistor.

Typically, FT sensor's resistance ranges from about 100,000 ohms at -40 °F (-40 °C) to about 50 ohms at +266 °F (+130 °C).

• Symptoms [OBD II DTC's: P0180 ~ P0184, P0185 ~ P0189]

Hard start, poor fuel economy, driveability problems

• Test Procedure

1. Backprobe the terminals on the FT sensor with the CH A lead and its ground lead.
2. Start the engine and hold the throttle at 2500 RPM until the trace goes across the screen.
3. Set the time base to 50 sec/div to see the sensor's entire operating range, from stone cold to operating temperature.
4. Press the HOLD key to freeze the waveform on the display for closer inspection.
5. To measure resistance, disconnect the sensor before changing to the GMM mode and then connect the Ground and CH A leads to the terminals on the sensor.

• Reference Waveform

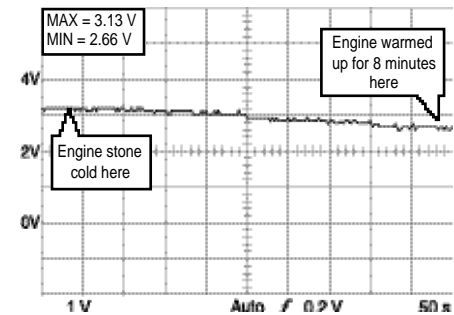

VEHICLE INFORMATION

YEAR : 1988
 MAKE : Nissan/Datsun
 MODEL : 300 ZX non-turbo
 ENGINE : 3.0 L
 FUELSYS : Multiport Fuel Injection
 PCM_PIN : 15 Yel wire
 STATUS : KOER (Key On Running)
 RPM : 2000
 ENG_TMP : Warming Up
 VACUUM : 21 In. Hg
 MILEAGE : 57782

• Troubleshooting Tips

Check the manufacturer's specifications for exact voltage range specifications, but generally the sensor's voltage should range from 3 V to just under 5 V when stone cold, dropping to around 1 to 2 V at operating temperature. The good sensor must generate a signal with a certain amplitude at any given temperature.

Opens in the FT sensor circuit will appear as upward spikes to V Ref.

Shorts to ground in the FT sensor circuit will appear as downward spikes to ground level.

INTAKE AIR TEMP (IAT) Sensor

• Theory of Operation

Most Intake Air Temperature (IAT) sensors are Negative Temperature Coefficient (NTC) type thermistors. They are primarily two wire analog sensors whose resistance decreases when their temperature increases. They are supplied with a 5 V V Ref power signal and return a voltage signal proportional to the intake air temperature to the PCM. Some sensors use their own case as a ground, so they have only one wire, the signal wire. When this instrument is connected to the signal from an IAT sensor, what is being read is the voltage drop across the sensor's NTC resistor.

Typically, IAT sensor's resistance ranges from about 100,000 ohms at -40 °F (-40 °C) to about 50 ohms at +266 °F (+130 °C).

• Symptoms [OBD II DTC's: P0110 ~ P0114]

Poor fuel economy, hard start, high emissions, tip-in hesitation

• Test Procedure

1. Backprobe the terminals on the IAT sensor with the CH A lead and its ground lead.
2. When the IAT sensors are at engine operating temperature, spray the sensors with a cooling spray, a water spray, or evaporative solvent spray and monitor the sensor voltage. Perform this test with the Key ON, Engine Off. The waveform should increase in amplitude as the sensor tip cools.
3. Press the HOLD key to freeze the waveform on the display for closer inspection.
4. To measure resistance, disconnect the sensor before changing to the GMM mode and then connect the Ground and CH A leads to the terminals on the sensor.

• Reference Waveform

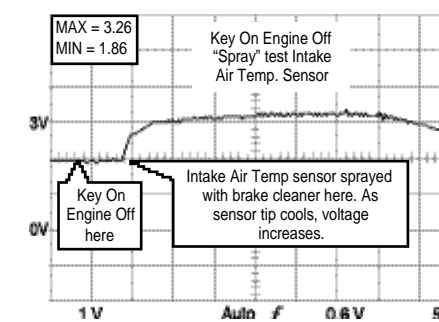

VEHICLE INFORMATION

YEAR : 1986
 MAKE : Oldsmobile
 MODEL : Toronado
 ENGINE : 3.8 L
 FUELSYS : Multiport Fuel Injection
 PCM_PIN : C11 Tan wire
 STATUS : KOEO (Key On Engine Off)
 RPM : 0
 ENG_TMP : Ambient Temp.
 VACUUM : 0 In. Hg
 MILEAGE : 123686

• Troubleshooting Tips

Check the manufacturer's specifications for exact voltage range specifications, but generally the sensor's voltage should range from 3 V to just under 5 V when stone cold, dropping to around 1 to 2 V at operating temperature. The good sensor must generate a signal with a certain amplitude at any given temperature.

Opens in the IAT sensor circuit will appear as upward spikes to V Ref.

Shorts in the IAT sensor circuit will appear as downward spikes to ground level.

Knock Sensor

• Theory of Operation

AC signal generating Knock Sensors are piezoelectric devices that sense vibration or mechanical stress (knock) from engine detonation. They are quite different from most other AC signal generating automotive sensors that sense the speed or position of a rotating shaft.

Engine detonation resulting from overadvanced ignition timing can cause severe engine damage. Knock sensors supply the PCM (sometimes via a spark control module) with Knock detection so the PCM can retard ignition timing to prevent further Knocking.

Knock sensors generate a small AC voltage spike when vibration or a knock from detonation occurs. The bigger the Knock or vibration, the bigger the spike. Knock sensors are usually designed to be very sensitive to the Knocking frequencies (in 5 to 15 kHz range) of the engine block.

- **Symptoms [OBD II DTC's: P0324 ~ P0334]**

No AC signal generation at all from Knock Sensors.

- **Test Procedure**

1. Connect the CH A lead to the sensor output or HI and its ground lead to the engine block or the sensor wire labeled LO (if internally grounded).
2. Test 1: With the Key On, Engine Running, put a load on the engine and watch the Scope display. The peak voltage and frequency of the waveform will increase with engine load and RPM increment. If the engine is detonating or pinging from too much advanced ignition timing, the amplitude and frequency will also increase.

Test 2: With the Key On, Engine Off, tap the engine block lightly near the sensor with a small hammer or a ratchet extension. Oscillations will be displayed immediately following a tap on the engine block. The harder the tap, the larger the amplitude of the oscillations.

- **Reference Waveform**

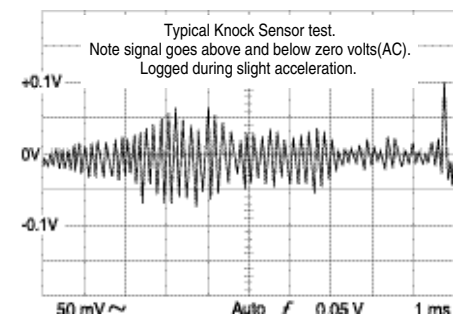

VEHICLE INFORMATION

YEAR : 1993
 MAKE : Ford
 MODEL : F150 4WD Pickup
 ENGINE : 5.0 L
 FUELSYS : Multiport Fuel Injection
 PCM_PIN : Neg-GND
 Pos-Pin23 Yel Red wire
 STATUS : KOER (Key On Running)
 RPM : Slightly Accelerate
 ENG_TMP : Operating Temperature
 VACUUM : 19 In. Hg
 MILEAGE : 66748

- **Troubleshooting Tips**

Knock sensors are extremely durable and usually fail from physical damage to the sensor itself. The most common type of Knock Sensor failure is not to generate a signal at all due to its physical damage, when the waveform stays flat even if you rev the engine or tap on the sensor. In this case, check the sensor and the instrument connections; make sure the circuit is not grounded, then condemn the sensor.

Throttle Position Sensor (TPS)

- **Theory of Operation**

A TPS is a variable resistor that tells the PCM the position of the throttle, that is, how far the throttle is open, whether it is opening or closing and how fast. Most throttle position sensors consist of a contact connected to the throttle shaft which slides over a section of resistance material around the pivot axis for the movable contact.

The TPS is a three wire sensor. One of the wires is connected to an end of the sensor's resistance material and provides 5 V via the PCM's V Ref circuit, another wire is connected to the other end of the resistance material and provides the sensor ground (GND). The third wire is connected to the movable contact and provides the signal output to the PCM. The voltage at any point in the resistance material is proportional to the throttle angle as sensed through the movable contact.

The voltage signal returning to the PCM is used to calculate engine load, ignition timing, EGR control, idle control and other PCM controlled parameters such as transmission shift points. A bad TPS can cause hesitation, idle problems, high emissions, and Inspection/ Maintenance (I/M) test failures.

Generally, throttle position sensors produce just under 1 V with the throttle closed and produce just under 5 V with the throttle wide open (WOT). The PCM determines the sensor's performance by comparing the sensor output to a calculated value based on MAP and RPM signals.

- **Symptoms [OBD II DTC's: P0120 ~ P0124, P0220 ~ P0229]**

Hesitation, stall at stops, high emissions, I/M test failures, transmission shifting problems.

- **Test Procedure**

1. Connect the CH A lead to the output or signal circuit of TPS and its ground lead to the TPS's GND.
2. With KOEO, slowly sweep the throttle from closed to the wide open position (WOT) and then the closed position again. Repeat this process several times.

- **Reference Waveform**

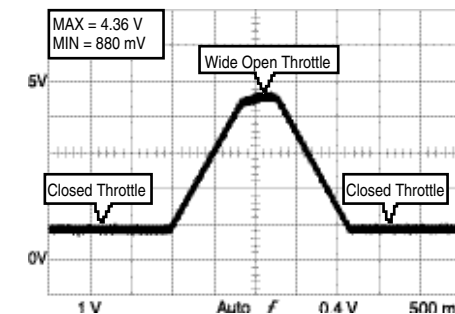

VEHICLE INFORMATION

YEAR : 1989
 MAKE : Chevrolet
 MODEL : 1500 Series Truck
 ENGINE : 5.0 L
 FUELSYS : Throttle Body Fuel Injection
 PCM_PIN : C13 DkBlu wire
 STATUS : KOEO (Key On Engine Off)
 RPM : 0
 ENG_TMP : Operating Temperature
 VACUUM : 0 In. Hg
 MILEAGE : 108706

• Troubleshooting Tips

Check the manufacturer's specifications for exact voltage range. Generally, the sensor output should range from just under 1 V at idle to just under 5 V at wide open throttle (WOT). There should be no breaks, spikes to ground or dropouts in the waveform.

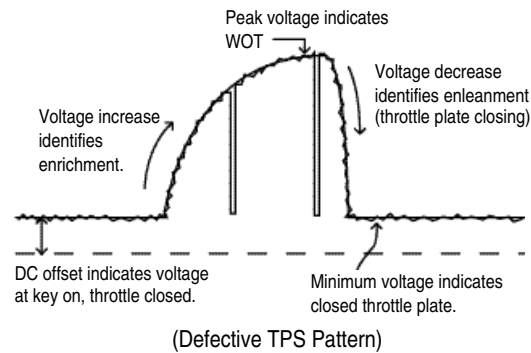

Dropouts on the slopes of the waveform indicate a short to ground or an intermittent open in the sensor's carbon track (resistance materials).

The first 1/8 to 1/3 of the sensor's carbon track usually wears out most because this portion is most used while driving. Thus, pay particular attention to the waveform as it begins to rise.

Magnetic Crankshaft Position (CKP) Sensor

• Theory of Operation

The magnetic CKP sensors are AC signal generating analog sensors. They generally consist of a wire wrapped, soft bar magnet with two connections. These two winding, or coil, connections are the sensor's output terminals. When a ring gear (a reluctor wheel) rotates past this sensor, it induces a voltage in the winding. A uniform tooth pattern on the reluctor wheel produces a sinusoidal series of pulses having a consistent shape. The amplitude is proportional to the rotating speed of the reluctor wheel (that is, the crankshaft or camshaft). The frequency is based on the rotational speed of the reluctor. The air gap between the sensor's magnetic tip and the reluctor wheel greatly affects the sensor's signal amplitude.

They are used to determine where TDC (Top Dead Center) position is located by creating a "synchronous" pulse which is generated by either omitting teeth on the reluctor wheel or moving them closer together.

The PCM uses the CKP sensors to detect misfire. When a misfire occurs, the amount of time it takes for a waveform to complete its cycle increases. If the PCM detects an excessive number of misfires within 200 to 1000 crankshaft revolutions, a misfire code (OBD II DTC) is set.

• Symptoms [OBD II DTC's: P0340 ~ P0349, P0365 ~ P0369, P0390 ~ P0394]

No or hard start, intermittent misfire, driveability problems

• Test Procedure

1. Connect the CH A lead to the sensor output or HI and its ground lead to the sensor output LO or GND.
2. With KOER (Key On, Engine Running), let the engine idle, or use the throttle to accelerate or decelerate the engine or drive the vehicle as needed to make the driveability, or emissions, problem occur.
3. Use the Glitch Snare mode to catch dropouts or stabilize waveforms when a "sync" pulse is created.

• Reference Waveform

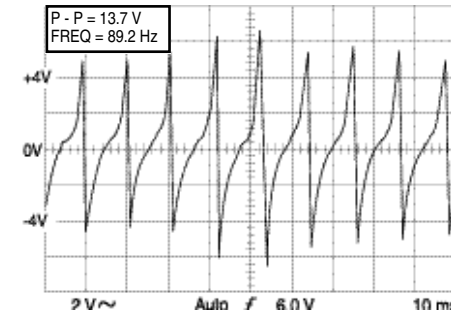

VEHICLE INFORMATION

YEAR : 1987
 MAKE : Chrysler
 MODEL : Fifth Avenue
 ENGINE : 5.2 L
 FUELSYS : Feedback Carburetor
 PCM_PIN : 5 #1 Org wire + 9 #1 Blk wire
 STATUS : KOER (Key On Running)
 RPM : 1400
 ENG_TMP : Operating Temperature
 VACUUM : 19 In. Hg
 MILEAGE : 140241

The amplitude and frequency increase with engine speed (RPM). The amplitude, frequency and shape should be all consistent for the conditions (RPM, etc.), repeatable (except for "sync" pulses), and predictable. Generally, the oscillations may not be perfect mirror images of each other above and below the zero level mark, but they should be relatively close on most sensors.

• Troubleshooting Tips

Make sure the frequency of the waveform is keeping pace with engine RPM, and that the time between pulses only changes when a "sync" pulse is displayed. This time changes only when a missing or extra tooth on the reluctor wheel passes the sensor. That is, any other changes in time between the pulses can mean trouble.

Look for abnormalities observed in the waveform to coincide with an engine sputter or driveability problem.

Before assuring the sensor's failure, when waveform abnormalities are observed, make sure that a chafed wire or bad wiring harness connector is not the cause, the circuit isn't grounded, and the proper parts are spinning.

Hall Effect Crankshaft Position (CKP) Sensor

• Theory of Operation

These CKP sensors are classified as "CKP Sensors-Low Resolution" in industry.

The Hall CKP sensors are low resolution digital sensors which generate the CKP signal, that is a low frequency (hundreds of Hz) square wave switching between zero and V Ref, from a Hall sensor.

The Hall CKP sensor, or switch, consists of an almost completely closed magnetic circuit containing a permanent magnet and pole pieces. A soft magnetic vane rotor travels through the remaining air gap between the magnet and the pole piece. The opening and closing of the vane rotor's windows interrupt the magnetic field, causing the Hall sensor to turn on and off like a switch - so some vehicle manufacturers call this sensor a Hall switch.

These sensors operate at different voltage levels depending on the vehicle manufacturers and deliver a series of pulses as the shaft rotates.

They are used to switch the ignition and/or fuel injection triggering circuits on and off.

The PCM uses the Hall CKP sensors to detect misfire.

- **Symptoms [OBD II DTC's: P0340 ~ P0349, P0365 ~ P0369, P0390 ~ P0394]**

Long cranking, poor fuel economy, emissions problem

- **Test Procedure**

1. Connect the CH A lead to the sensor output or HI and its ground lead to the sensor output LO or GND.
2. With KOEC (Key On, Engine Cranking), or with KOER, use the throttle to accelerate or decelerate the engine or drive the vehicle as needed to make the driveability, or emissions, problem occur.
3. Use the Glitch Snare mode to catch dropouts or stabilize waveforms when a "sync" pulse is created.

- **Reference Waveform**

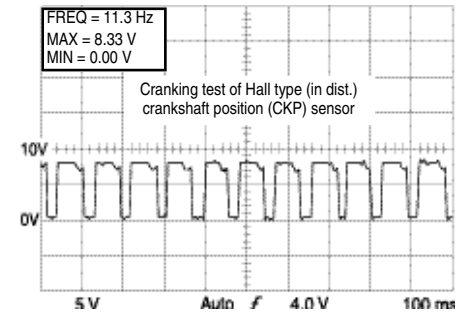

VEHICLE INFORMATION

YEAR : 1985
 MAKE : Volkswagen
 MODEL : Jetta
 ENGINE : 1.8 L
 FUELSYS : CIS Fuel Injection
 PCM_PIN : 9 GryWht wire
 STATUS : KOEC (Key On Cranking)
 RPM : Cranking
 ENG_TMP : Operating Temperature
 VACUUM : 5 In. Hg
 MILEAGE : 105522

The amplitude, frequency, and shape should be all consistent in the waveform from pulse to pulse. The amplitude should be sufficient (usually equal to sensor supply voltage), the time between pulses repeatable (except for "sync" pulses), and the shapes repeatable and predictable. Consistency is the key.

- **Troubleshooting Tips**

The duty cycle of the waveform changes only when a "sync" pulse is displayed. Any other changes in duty cycle can mean troubles.

The top and bottom corners of the waveform should be sharp and voltage transitions of the edge should be straight and vertical.

Make sure the waveform isn't riding too high off the ground level. This could indicate a high resistance or bad ground supply to the sensor.

Although the Hall CKP sensors are generally designed to operate in temperatures up to 318 °F (150 °C), they can fail at certain temperatures (cold or hot).

Optical Crankshaft Position (CKP) Sensor

- **Theory of Operation**

These CKP sensors are classified as "CKP Sensors - High Resolution" in industry.

The optical CKP sensors can sense position of a rotating component even without the engine running and their pulse amplitude remains constant with variations in speed. They are not affected by electromagnetic interference (EMI). They are used to switch the ignition and/or fuel injection triggering circuits on and off.

The optical sensor consists of a rotating disk with slots in it, two fiber optic light pipes, an LED, and a phototransistor as the light sensor. An amplifier is coupled to the phototransistor to create a strong enough signal for use by other electronic devices, such as PCM or ignition module.

The phototransistor and amplifier create a digital output signal (on/off pulse).

- **Symptoms [OBD II DTC's: P0340 ~ P0349, P0365 ~ P0369, P0390 ~ P0394]**

No or hard starts, stall at stops, misfires, poor fuel economy, emissions failure

- **Test Procedure**

1. Connect the CH A lead to the sensor output or HI and its ground lead to the sensor output LO or GND.
2. With KOER (Key On, Engine Running), let the engine idle, or use the throttle to accelerate or decelerate the engine or drive the vehicle as needed to make the driveability, or emissions, problem occur.
3. Use the Glitch Snare mode to catch dropouts or stabilize waveforms when a "sync" pulse is created.

- **Reference Waveform**

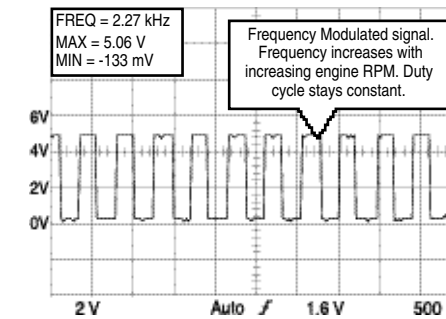

VEHICLE INFORMATION

YEAR : 1989
 MAKE : Mitsubishi
 MODEL : Montero
 ENGINE : 3.0 L
 FUELSYS : Multiport Fuel Injection
 PCM_PIN : 22 Blk wire at PCM
 STATUS : KOER (Key On Running)
 RPM : Idle
 ENG_TMP : Operating Temperature
 VACUUM : 20 In. Hg
 MILEAGE : 184066

The amplitude, frequency, and shape should be all consistent in the waveform from pulse to pulse. The amplitude should be sufficient, the time between pulses repeatable (except for "sync" pulses), and the shapes repeatable and predictable. Consistency is the key.

• Troubleshooting Tips

The duty cycle of the waveform changes only when a “sync” pulse is displayed. Any other changes in duty cycle can mean troubles.

The top and bottom corners of the waveform should be sharp. However, the left upper corner may appear rounded on some of the higher frequency (high data rate) optical distributors. This is normal.

Optical CKP sensors are very susceptible to malfunction from dirt or oil interfering with the light transmission through the rotating disk. When dirt or oil enters into the sensitive areas of the sensors, no starts, stalls, or misfires can occur.

Magnetic Camshaft Position (CMP) Sensor

• Theory of Operation

The magnetic CMP sensors are AC signal generating analog sensors. They generally consist of a wire wrapped, soft bar magnet with two connections. These two winding, or coil, connections are the sensor's output terminals. When a ring gear (a reluctor wheel) rotates past this sensor, it induces a voltage in the winding. A uniform tooth pattern on the reluctor wheel produces a sinusoidal series of pulses having a consistent shape. The amplitude is proportional to the rotating speed of the reluctor wheel (that is, the crankshaft or camshaft). The frequency is based on the rotational speed of the reluctor. The air gap between the sensor's magnetic tip and the reluctor wheel greatly affects the sensor's signal amplitude.

They are used to determine where TDC (Top Dead Center) position is located by creating a “synchronous” pulse which is generated by either omitting teeth on the reluctor wheel or moving them closer together.

The PCM or ignition module uses the CMP sensors to trigger ignition or fuel injector events. The magnetic CMP and CKP sensors are susceptible to Electromagnetic Interference (EMI or RF) from high voltage spark plug wires, car phones or other electronic devices on the vehicle. This can cause a driveability problem or set a Diagnostic Trouble Code (DTC).

• Symptoms [OBD II DTC's: P0340 ~ P0349, P0365 ~ P0369, P0390 ~ P0394]

Long cranking time, poor fuel economy, emissions failure

• Test Procedure

1. Connect the CH A lead to the sensor output or HI and its ground lead to the sensor output LO or GND.
2. With KOER (Key On, Engine Running), let the engine idle, or use the throttle to accelerate or decelerate the engine or drive the vehicle as needed to make the driveability, or emissions, problem occur.
3. Use the Glitch Snare mode to catch dropouts or stabilize waveforms when a “sync” pulse is created.

• Reference Waveform

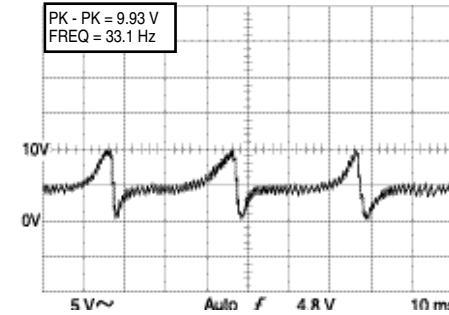

VEHICLE INFORMATION

YEAR : 1989
MAKE : Acura
MODEL : Legend
ENGINE : 2.7 L
FUELSYS : Multiport Fuel Injection
PCM_PIN : C3 OrgBlu
STATUS : KOER (Key On Running)
RPM : Idle
ENG_TMP : Operating Temperature
VACUUM : 20 In. Hg
MILEAGE : 69050

The amplitude and frequency increase with engine speed (RPM).
The amplitude, frequency and shape should be all consistent for the conditions (RPM, etc.), the time between pulses repeatable (except for “sync” pulses), and the shapes repeatable and predictable.

• Troubleshooting Tips

Make sure the frequency of the waveform is keeping pace with engine RPM, and that the time between pulses only changes when a “sync” pulse is displayed. This time changes only when a missing or extra tooth on the reluctor wheel passes the sensor. That is, any other changes in time between the pulses can mean trouble.

Look for abnormalities observed in the waveform to coincide with an engine sputter or driveability problem.

Hall Effect Camshaft Position (CMP) Sensor

• Theory of Operation

These CMP sensors are classified as “CMP Sensors - Low Resolution” in industry.

The Hall CMP sensors are low resolution (accuracy) digital sensors which generate the CMP signal, that is a low frequency (tens of Hz) square wave switching between zero and V Ref, from a Hall sensor.

The Hall CMP sensor, or switch, consists of an almost completely closed magnetic circuit containing a permanent magnet and pole pieces. A soft magnetic vane rotor travels through the remaining air gap between the magnet and the pole piece. The opening and closing of the vane rotor's window interrupts the magnetic field, causing the Hall sensor to turn on the off like a switch - so some vehicle manufacturers call this sensor a Hall switch.

These sensors operate at different voltage levels depending on the vehicle manufacturers and deliver a series of pulses as the shaft rotates.

They are used to switch the ignition and/or fuel injection triggering circuits on and off.

The PCM uses the Hall CMP sensors to detect misfire.

- Symptoms [OBD II DTC's: P0340 ~ P0349, P0365 ~ P0369, P0390 ~ P0394]

Long cranking time, poor fuel economy, emissions failure

- Test Procedure

1. Connect the CH A lead to the sensor output or HI and its ground lead to the sensor output LO or GND.
2. With KOER (Key On, Engine Running), let the engine idle, or use the throttle to accelerate or decelerate the engine or drive the vehicle as needed to make the driveability, or emissions, problem occur.
3. Use the Glitch Snare mode to catch dropouts or stabilize waveforms when a "sync" pulse is created.

- Reference Waveform

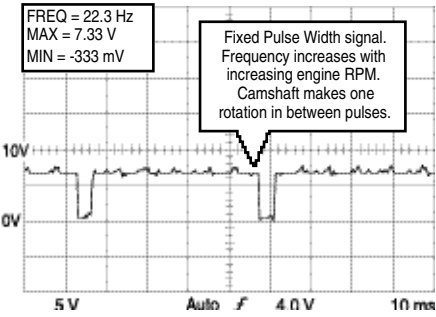

VEHICLE INFORMATION

YEAR : 1986
 MAKE : Oldsmobile
 MODEL : Toronado
 ENGINE : 3.8 L
 FUELSYS : Multiport Fuel Injection
 PCM_PIN : K BrnWht wire at ignition module
 STATUS : KOER (Key On Running)
 RPM : 2500
 ENG_TMP : Operating Temperature
 VACUUM : 20 In. Hg
 MILEAGE : 123686

The amplitude, frequency, and shape should be all consistent in the waveform from pulse to pulse. The amplitude should be sufficient (usually equal to sensor supply voltage), the time between pulses repeatable (except for "sync" pulses), and the shape repeatable and predictable. Consistency is the key.

- Troubleshooting Tips

The duty cycle of the waveform changes only when a "sync" pulse is displayed. Any other changes in duty cycle can mean troubles.

The top and bottom corners of the waveform should be sharp and voltage transitions of the edge should be straight and vertical.

Make sure the waveform isn't riding too high off the ground level. This could indicate a high resistance or bad ground supply to the sensor.

Although the Hall CMP sensors are generally designed to operate in temperatures up to 318 °F (150 °C), they can fail at certain temperatures (cold or hot).

Optical Camshaft Position (CMP) Sensor

- Theory of Operation

These CMP sensors are classified as "CMP Sensors - High Resolution" in industry.

The optical CMP sensors are high resolution (accuracy) digital sensors which generate the CMP signal, that is a high frequency (hundreds of Hz to several kHz) square wave switching between zero and V Ref.

The optical CMP sensors can sense position of a rotating component even without the engine running and their pulse amplitude remains constant with variations in speed. They are not affected by electromagnetic interference (EMI). They are used to switch the ignition and/or fuel injection triggering circuits on and off.

The optical sensor consists of a rotating disk with slots in it, two fiber optic light pipes, and LED, and a phototransistor as the light sensor. An amplifier is coupled to the phototransistor to create a strong enough signal for use by other electronic devices, such as PCM or ignition module.

The phototransistor and amplifier create a digital output signal (on/off pulse)

- Symptoms [OBD II DTC's: P0340 ~ P0349, P0365 ~ P0369, P0390 ~ P0394]

No or hard starts, stall at stops, misfires, poor fuel economy, emissions failure

- Test Procedure

1. Connect the CH A lead to the sensor output or HI and its ground lead to the sensor output LO or GND.
2. With KOER (Key On, Engine Running), let the engine idle, or use the throttle to accelerate or decelerate the engine or drive the vehicle as needed to make the driveability, or emissions, problem occur.
3. Use the Glitch Snare mode to catch dropouts or stabilize waveforms when a "sync" pulse is created.

- Reference Waveform

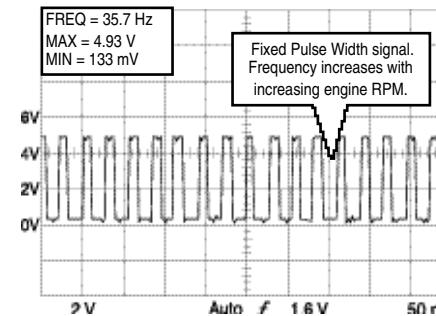

VEHICLE INFORMATION

YEAR : 1989
 MAKE : Mitsubishi
 MODEL : Montero
 ENGINE : 3.0 L
 FUELSYS : Multiport Fuel Injection
 PCM_PIN : 23 Red wire at PCM
 STATUS : KOER (Key On Running)
 RPM : Idle
 ENG_TMP : Operating Temperature
 VACUUM : 20 In. Hg
 MILEAGE : 184066

The amplitude, frequency, and shape should be all consistent in the waveform from pulse to pulse. The amplitude should be sufficient, the time between pulses repeatable (except for "sync" pulses), and the shapes repeatable and predictable. Consistency is the key.

• Troubleshooting Tips

The duty cycle of the waveform changes only when a “sync” pulse is displayed. Any other changes in duty cycle can mean troubles.

The top and bottom corners of the waveform should be sharp. However, the left upper corner may appear rounded on some of the higher frequency (high data rate) optical distributors. This is normal.

Optical CMP sensors are very susceptible to malfunction from dirt or oil interfering with the light transmission through the rotating disk.

When dirt or oil enters into the sensitive areas of the sensors, no starts, stalls, or misfires can occur.

Magnetic Vehicle Speed Sensor (VSS)

• Theory of Operation

The vehicle speed sensors provides vehicle speed information to the PCM, the cruise control, and the speedometer. The PCM uses the data to decide when to engage the transmission torque converter clutch lockup and to control electronic transmission shift levels, cruise control, idle air bypass, engine cooling fan, and other functions.

The magnetic vehicle speed sensors are usually mounted directly on the transmissions or transaxles. They are two wire sensors and AC signal generating analog sensors. They are very susceptible to Electromagnetic Interference (EMI or RF) from other electronic devices on the vehicle.

They generally consist of a wire wrapped, soft bar magnet with two connections. These two winding, or coil, connections are the sensor's output terminals. When a ring gear (a reluctor wheel) rotates past this sensor, it induces a voltage in the winding.

A uniform tooth pattern on the reluctor wheel produces a sinusoidal series of pulses having a consistent shape. The amplitude is proportional to the rotating speed of the reluctor wheel. The signal frequency is based on the rotational speed of the reluctor. The air gap between the sensor's magnetic tip and the reluctor wheel greatly affects the sensor's signal amplitude.

• Symptoms [OBD II DTC's: P0500 ~ P0503]

Inaccurate speedometer, improper transmission shifting, problems affecting ABS and cruise control

• Test Procedure

1. Raise the drive wheels off the ground and place the transmission in drive.
2. Connect the CH A lead to the sensor output or HI and its ground lead to the sensor output LO or GND.
3. With KOBD (Key On, Being Driven), monitor the VSS output signal at low speed while gradually increasing the speed of the drive wheels.
4. Use the Glitch Snare mode to detect spikes and dropouts.

• Reference Waveform

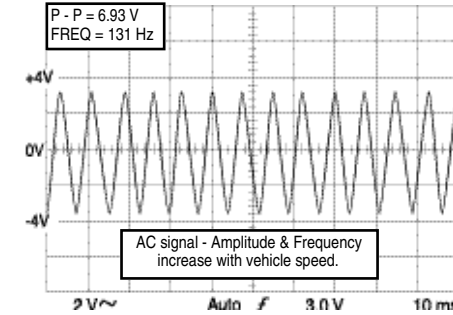

VEHICLE INFORMATION

YEAR : 1988
MAKE : Nissan/Datsun
MODEL : 300 zx non-turbo
ENGINE : 3.0 L
FUELSYS : Multiport Fuel Injection
PCM_PIN : 12 Wht wire at the instrument cluster
STATUS : KOBD (Key On Being Driven)
RPM : 1500
ENG_TMP : Operating Temperature
VACUUM : 20 In. Hg
MILEAGE : 57782

The amplitude and frequency increase with vehicle speed. Vehicle Speed Sensors make waveforms whose shapes all look and behave very similar. Generally, the oscillations (the ups and downs in the waveform) are very symmetrical at constant speed.

• Troubleshooting Tips

If the amplitude is low, look for an excessive air gap between the trigger wheel and the pickup.

If the amplitude wavers, look for a bent trigger wheel or shaft.

If one of the oscillations look distorted, look for a bent or damaged tooth on the trigger wheel.

IMPORTANT: When troubleshooting a missing VSS signal, check the fuse first. If there is no power to the buffer, there will be no square wave output. If the fuse is good, check the sensor first than a buffer mounted under the dash. If you have a sine wave coming from the sensor, but no square wave from the buffer, don't assume the problem is in the buffer; it may not be there because of a loose connector between the sensor and the buffer.

Optical Vehicle Speed Sensor (VSS)

• Theory of Operation

The optical vehicle speed sensors are usually driven by a conventional cable and are found under the dash. They are digital sensors and are not affected by electromagnetic interference (EMI).

They generally consist of a rotating disk with slots in it, two fiber optic light pipes, a light emitting diode, and a phototransistor as the light sensor. An amplifier is coupled to the phototransistor to create a strong enough signal for use by other electronic devices, such as the PCM or ignition module. The phototransistor and amplifier create a digital output signal (on/off pulse).

Optical sensors are very susceptible to malfunction from dirt or oil interfering with the light transmission through the rotating disk. When dirt or oil enters into the sensitive areas of the sensors, driveability problems can occur and DTC's can be set.

- Symptoms [OBD II DTC's: P0500 ~ P0503]

Improper transmission shifting, inaccurate speedometer, problems affecting ABS and cruise control

- Test Procedure

1. Raise the drive wheels off the ground and place the transmission in drive.
2. Connect the CH A lead to the sensor output or HI and its ground lead to the sensor output LO or GND.
3. With KOBD (Key On, Being Driven), monitor the VSS output signal at low speed (about 30 MPH) while gradually increasing the speed of the drive wheels.
4. Use the Glitch Snare mode to detect spikes and dropouts.

- Reference Waveform

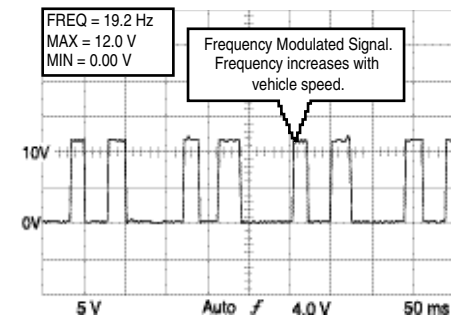

VEHICLE INFORMATION

YEAR : 1984
 MAKE : Oldsmobile
 MODEL : Toronado
 ENGINE : 5.0 L
 FUELSYS : Feedback Carburetor
 PCM_PIN : 16 Brn wire
 STATUS : KOBD (Key On Being Driven)
 RPM : 1350
 ENG_TMP : Operating Temperature
 VACUUM : 15 In. Hg
 MILEAGE : 52624

The signal frequency should increase with increasing vehicle speed, but the duty cycle should stay consistent at any speed. The amplitude, frequency, and shape should be all consistent in the waveform from pulse to pulse. The amplitude should be sufficient (usually equal to sensor supply voltage), the time between pulses repeatable and the shapes repeatable and predictable.

- Troubleshooting Tips

The top and bottom corners of the waveform should be sharp and voltage transitions of the edge should be straight and vertical.

All of the waveforms should be equal in height due to the constant supply voltage to the sensor.

Make sure the waveform isn't riding too high off the ground level. This could indicate a high resistance or bad ground supply to the sensor. (Voltage drop to ground should not exceed 400 mV.)

Look for abnormalities observed in the waveform to coincide with a driveability problem or a DTC.

Analog Manifold Absolute Pressure (MAP) Sensor

- Theory of Operation

Almost all domestic and import MAP sensors are analog types in design except Ford's MAP sensor. Analog MAP sensors generate a variable voltage output signal that is directly proportional to the intake manifold vacuum, which is used by the PCM to determine the engine load. They are primarily three wire sensors and are supplied with 5V V Ref power, a ground circuit, and the signal output to the PCM.

High pressure occurs when the engine is under a heavy load, and low pressure (high intake vacuum) occurs when there is very little load. A bad MAP sensor can affect the air-fuel ratio when the engine accelerates and decelerates. It may also have some effect on ignition timing and other PCM outputs. A bad MAP sensor or its hose can trigger DTC's for MAF, TP, or EGR sensors.

- Symptoms [OBD II DTC's: P0105 ~ P0109]

Low power, stall, hesitation, excessive fuel consumption, emissions failure

- Test Procedure

1. Connect the CH A lead to the sensor output or HI and its ground lead to the sensor output LO or GND.
2. Shut off all accessories, start the engine and let it idle in park or neutral. After the idle has stabilized, check the idle voltage.
3. Rev the engine from idle to Wide Open Throttle (WOT) with a moderate input speed (this should only take about 2 seconds - don't overrev the engine.)
4. Let engine speed drop back down to idle for about two seconds.
5. Rev the engine again to WOT (very quickly) and let it drop back to idle again.
6. Press the HOLD key to freeze the waveform on the display for closer inspection.

NOTE

It may be advantageous to put the sensor through its paces by using a handheld vacuum pump to see that it generates the correct voltage at a specific vacuum.

- Reference Waveform

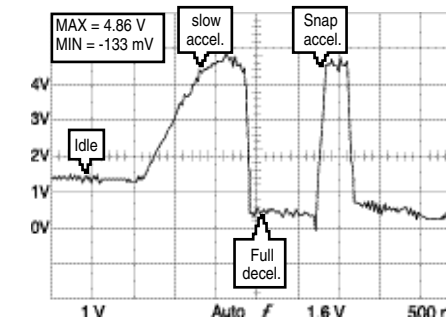

VEHICLE INFORMATION

YEAR : 1993
 MAKE : Chevrolet
 MODEL : Suburban 1500
 ENGINE : 5.7 L
 FUELSYS : Throttle Body Fuel Injection
 PCM_PIN : B13 LtGrn wire at MAP sensor
 STATUS : KOER (Key On Running)
 RPM : Acceleration & Deceleration
 ENG_TMP : Operating Temperature
 OVACUUM : 3-24 In. Hg
 MILEAGE : 55011

Check the manufacturer's specifications for exact voltage range versus vacuum levels, and compare them to the readings on the display. Generally the sensor voltage should range about 1.25 V at idle to just under 5 V at WOT and close to 0 V on full deceleration. High vacuum (around 24 In. Hg on full decel) produces low voltage (close to 0 V), and low vacuum (around 3 In. Hg at full load) produces high voltage (close to 5 V).

IMPORTANT: There are a few MAP sensors designed to do the opposite (high vacuum = high voltage). Some Chrysler MAP sensors just stay at a fixed voltage when they fail, regardless of changes in vacuum level. Generally 4 cylinder engines make noisier waveforms because their vacuum fluctuates more between intake strokes.

• Troubleshooting Tips

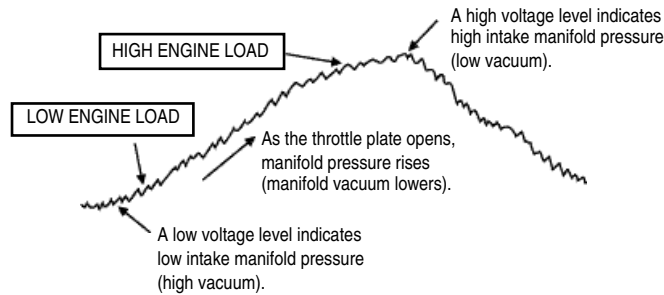

Digital Manifold Absolute Pressure (MAP) Sensor

• Theory of Operation

Ford's digital MAP sensor is found on many Ford and Lincoln Mercury vehicles from the early 1980's to well into the 1990's. This sensor produces a frequency modulated square wave whose frequency varies with the amount of intake vacuum sensed. It generates about 160 Hz with no vacuum applied, and it generates about 105 Hz when it is sensing around 19 In.Hg at idle. Check the manufacturer's specs for the year, make and model for exact vacuum versus frequency reference numbers. This is a three wire sensor, supplied with 5 V V Ref power, a ground circuit, and the digital signal output pulses based on the amount of vacuum it senses.

• Symptoms [OBD II DTC's: P0105 ~ P0109]

Low power, stall, hesitation, excessive fuel consumption, emissions failure

• Test Procedure

1. Connect the CH A lead to the sensor output or HI and its ground lead to the sensor output LO or GND.
2. With the Key On, Engine Off (KOEO), apply different amounts of vacuum to the sensor using a handheld vacuum pump.

3. Make sure that the amplitude, frequency and shape are all present, repeatable, and consistent. Amplitude should be close to 5 V. Frequency should vary with vacuum. Shape should stay constant (square wave).
4. Make sure the sensor produces the correct frequency for a given amount of vacuum, according to the specification chart for the vehicle you are working on.
5. Use the Glitch Snare mode to detect dropouts or unstable output frequency.

• Reference Waveform

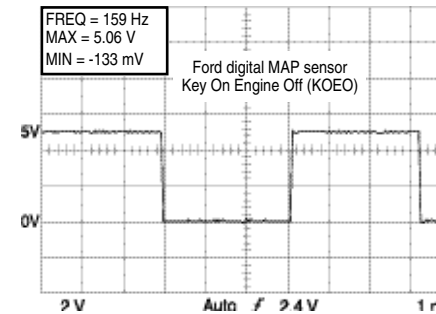

VEHICLE INFORMATION

YEAR : 1993
 MAKE : Ford
 MODEL : F150 4WD Pickup
 ENGINE : 5.0 L
 FUELSYS : Multiport Fuel Injection
 PCM_PIN : 45 LtGrn Blk wire
 STATUS : KOEO (Key On Engine Off)
 RPM : 0
 ENG_TMP : Operating Temperature
 VACUUM : 0 In. Hg
 MILEAGE : 66748

Frequency decreases as vacuum increases. Look for pulses that are a full 5 V in amplitude. Voltage transitions should be straight and vertical. Voltage drop to ground should not exceed 400 mV. If the voltage drop is greater than 400 mV, look for a bad ground at the sensor or the PCM.

• Troubleshooting Tips

A bad digital MAP sensor can produce incorrect frequencies, rounded (shortened) pulses, unwanted spikes and rounded off corners that could all have the effect of garbling "electronic communication", thus causing a driveability or emissions problem.

Analog Mass Air Flow (MAF) Sensor

• Theory of Operation

There are two main varieties of analog MAF sensors; Hot Wire type and Vane type. Hot wire type MAF sensors use heated-metal-foil sensing element to measure air flow entering the intake manifold. The sensing element is heated to about 170 °F (77 °C), above the temperature of incoming air. As air flows over the sensing element, it cools the element, causing resistance to drop. This causes a corresponding increase in current flow, which causes supply voltage to decrease. This signal is seen by the PCM as a change in voltage drop (high air flow = high voltage) and is used as an indication of air flow. The PCM uses this signal to calculate engine load, to determine the right amount of fuel to be mixed with the air, and ignition timing, EGR control, idle control, transmission shift points, etc.

Vane type MAF sensors, mainly, consist of a variable resistor (potentiometer) that tells the PCM the position of the vane air flow door. As the engine is accelerated and more air passes through the vane air flow sensor, the vane air door is pushed open by the incoming air. The angle of the vane air flow door is proportional to the volume of air passing by it. A vane type MAF sensor consists of a contact connected to the vane door which slides over a section of resistance material that is placed around the pivot axis for the movable contact. The voltage at any point in the resistance material, as sensed through the movable contact, is proportional to the angle of the vane air door. Overswing of the door caused by snap accelerations provides information to the PCM for acceleration enrichment. [Many Toyotas are equipped with vane type MAF sensors operating opposite the above – their voltage is high when airflow is low.]

• Symptoms [OBD II DTC's: P0100 ~ P0104]

Hesitation, stall, low power, idle problems, excessive fuel consumption, emissions failure

• Test Procedure

1. Connect the CH A lead to the sensor output or HI and its ground lead to the sensor output LO or GND.
2. Shut off all accessories, start the engine and let it idle in park or neutral. After the idle has stabilized, check the idle voltage.
3. Rev the engine from idle to Wide Open Throttle (WOT) with a moderate input speed (this should only take about 2 seconds – don't overrev the engine).
4. Let engine speed drop back down to idle for about two seconds.
5. Rev the engine again to WOT (very quickly) and let it drop back to idle again.
6. Press the HOLD key to freeze the waveform on the display for closer inspection.

• Reference Waveform

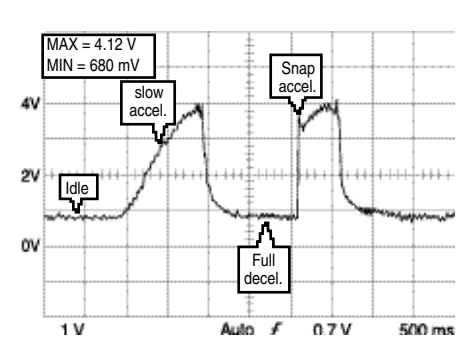

VEHICLE INFORMATIONS

YEAR : 1993
 MAKE : Ford
 MODEL : Explorer
 ENGINE : 4.0 L
 FUELSYS : Multiport Fuel Injection
 PCM_PIN : 14 LtBlu Red wire
 STATUS : KOER (Key On Running)
 RPM : Acceleration and Deceleration
 ENG_TMP : Operating Temperature
 VACUUM : 2-24 In. Hg
 MILEAGE : 54567

Hot wire type MAF sensor voltage should range from just over 2 V at idle to just over 4 V at WOT, and should dip slightly lower than idle voltage on full deceleration. Vane type MAF sensor voltage should range from about 1 V at idle to just over 4 V at WOT and not quite back to idle voltage on full deceleration. Generally, on non-Toyota varieties, high airflow makes high voltage and low airflow makes low voltage. When the sensor voltage output doesn't follow airflow closely, the waveform will show it and the engine operation will be noticeably affected.

• Troubleshooting Tips

If overall voltage is low, be sure to check for cracked, broken, loose, or otherwise leaking intake air ducts.

IMPORTANT: 0.25 V can make the difference between a good sensor and a bad one, or an engine that is blowing black smoke and one that is in perfect control of fuel mixture. However, because the sensor output voltages will vary substantially depending on vehicle engine families, in some cases, this sensor can be difficult to diagnose definitively.

Digital Slow MAF (Mass Air Flow) Sensor

• Theory of Operation

There are three main varieties of digital MAF sensors; Digital Slow type (output signals in the 30 to 500 Hz range), Digital Fast type (output signals in the kHz range), and Karman Vortex type (which changes pulse width as well as frequency). A digital MAF sensor receives a 5 V reference signal from the PCM and sends back a variable frequency signal that is proportional to the mass of air entering the engine. The output signal is a square wave, in most cases, with a full 5 V in amplitude. As the airflow increases, the frequency of the signal generated increases. The PCM uses these signals to calculate fuel injector ON time and ignition timing and also determines MAF sensor deterioration by comparing the MAF signal to a calculated value based on MAP, TP, IAT, and RPM signals.

Digital Slow MAF sensors can be found on early to mid 1980's GM vehicles, and many other engine systems. Generally, the older the MAF sensor, the slower the frequency it produces.

• Symptoms [OBD II DTC's: P0100 ~ P0104]

Hesitation, stall, low power, idle problems, excessive fuel consumption, emissions failure

• Test Procedure

1. Connect the CH A lead to the sensor output or HI and its ground lead to the sensor output LO or GND.
2. With the Key On, Engine Running (KOER), use the throttle to accelerate and decelerate the engine. Try different RPM ranges while spending more time in the RPM ranges that correspond to the driveability problem.
3. Make sure that the amplitude, frequency and shape are all correct, consistent, and repeatable.
4. Make sure that the sensor generates the correct frequency for a given RPM or airflow rate.
5. Use the Glitch Snare mode to detect dropouts or unstable output frequency.

• Reference Waveform

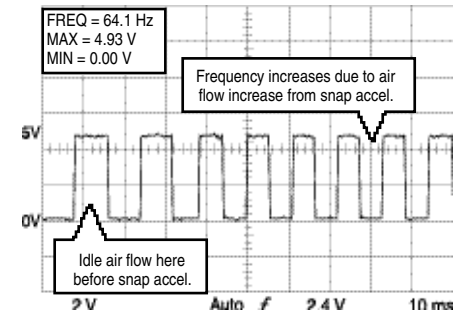

VEHICLE INFORMATION

YEAR : 1986
 MAKE : Oldsmobile
 MODEL : Toronado
 ENGINE : 3.8 L
 FUELSYS : Multiport Fuel Injection
 PCM_PIN : B6 Yel wire
 STATUS : KOER (Key On Running)
 RPM : Snap Acceleration
 ENG_TMP : Operating Temperature
 VACUUM : 0-24 In. Hg
 MILEAGE : 123686

Frequency stays constant when airflow is constant. Frequency increases as airflow increases from snap acceleration. Look for pulses that are a full 5 V in amplitude. Voltage transitions should be straight and vertical. Voltage drop to ground should not exceed 400 mV. If greater than 400 mV, look for a bad ground at the sensor or the PCM.

• Troubleshooting Tips

Possible defects to watch for are runted (shortened) pulses, unwanted spikes, and rounded off corners that could all have the effect of garbling an electronic communication, causing a driveability or emissions problem. The sensor should be replaced if it has intermittent faults.

Digital Fast MAF (Mass Air Flow) Sensor

• Theory of Operation

Digital Fast type MAF sensors can be found on GM's 3800 V-6 engine with the Hitachi sensor, Lexus models, and many others. The Hitachi sensor has a square wave output in the 10 kHz range. Voltage level of square waves should be consistent and frequency should change smoothly with engine load and speed.

• Symptoms [OBD II DTC's: P0100 ~ P0104]

Hesitation, stall, low power, idle problems, excessive fuel consumption, emissions failure

• Test Procedure

1. Connect the CH A lead to the sensor output or HI and its ground lead to the sensor output LO or GND.
2. With the Key On, Engine Running (KOER), use the throttle to accelerate and decelerate the engine. Try different RPM ranges while spending more time in the RPM ranges that correspond to the driveability problem.
3. Make sure that the amplitude, frequency and shape are all consistent, repeatable, and accurate.

4. Make sure that the sensor generates the correct frequency for a given RPM or airflow rate.
5. Use the Glitch Snare mode to detect dropouts or unstable output frequency.

• Reference Waveform

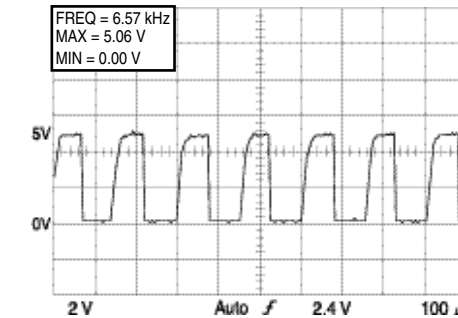

VEHICLE INFORMATION

YEAR : 1990
 MAKE : Buick
 MODEL : Le Sabre
 ENGINE : 3.8 L
 FUELSYS : Multiport Fuel Injection
 PCM_PIN : Yel wire
 STATUS : KOER (Key On Running)
 RPM : 2500
 ENG_TMP : Operating Temperature
 VACUUM : 20 In. Hg
 MILEAGE : 103128

Frequency stays constant when airflow is constant. Frequency increases as airflow increases from snap acceleration. Look for pulses that are a full 5 V in amplitude. Voltage transitions should be straight and vertical. Voltage drop to ground should not exceed 400 mV. If greater than 400 mV, look for a bad ground at the sensor or the PCM.

NOTE

On some Digital Fast MAF sensors, such as the GM Hitachi sensor found on 3800 Buick V-6s, the upper left corner of the pulse is rounded off slightly. This is normal and doesn't indicate a bad sensor.

• Troubleshooting Tips

Possible defects to watch for are runted (shortened) pulses, unwanted spikes, and rounded off corners that could all have the effect of garbling an electronic communication, causing a driveability or emissions problem. The sensor should be replaced if it has intermittent faults.

Digital Karman-Vortex MAF (Mass Air Flow) Sensor

• Theory of Operation

Karman-Vortex type MAF sensors are usually manufactured as part of the air cleaner assembly. They are commonly found on Mitsubishi engine systems. While most digital MAF sensors vary only their frequency with changes in airflow rate, the Karman-Vortex type's signal varies Pulse Width as well as Frequency with changes in airflow rate. As the airflow increases, the frequency of the signal generated increases.

Karman-Vortex sensors differ from other digital MAF sensors during acceleration modes. During acceleration, not only does the sensor's frequency output increase, but also its pulse width changes.

- Symptoms [OBD II DTC's: P0100 ~ P0104]

Hesitation, stall, low power, idle problems, excessive fuel consumption, emissions failure

- Test Procedure

1. Connect the CH A lead to the sensor output HI and its ground lead to the sensor output LO or GND.
2. With the Key On, Engine Running (KOER), use the throttle to accelerate and decelerate the engine. Try different RPM ranges while spending more time in the RPM ranges that correspond to the driveability problem.
3. Make sure that the amplitude, frequency, shape, and pulse width are all consistent, repeatable and accurate for any given operating mode.
4. Make sure that the sensor generates the correct and steady frequency for a given RPM or airflow rate.
5. Use the Glitch Snare mode to detect dropouts or unstable output frequency.

- Reference Waveform

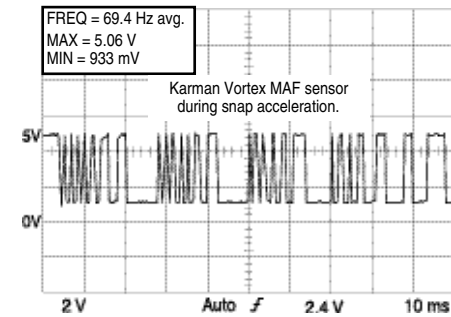

VEHICLE INFORMATIONS

YEAR : 1992
MAKE : Mitsubishi
MODEL : Eclipse
ENGINE : 1.8 L
FUELSYS : Multiport Fuel Injection
PCM_PIN : 10 GrnBlu wire
STATUS : KOER (Key On Running)
RPM : Snap Acceleration
ENG_TMP : Operating Temperature
VACUUM : 3-24 In. Hg
MILEAGE : 49604

Frequency increases as airflow rate increases. Pulse width (duty cycle) is modulated in acceleration modes.
Look for pulses that are a full 5 V in amplitude. Look for the proper shape of the waveform in terms of consistent, square corners, and consistent vertical legs.

- Troubleshooting Tips

Possible defects to watch for are runted (shortened) pulses, unwanted spikes, and rounded off corners that could all have the effect of garbling an electronic communication, causing a driveability or emissions problem. The sensor should be replaced if it has intermittent faults.

Differential Pressure Feedback EGR (DPFE) Sensor

- Theory of Operation

An EGR (Exhaust Gas Recirculation) pressure sensor is a pressure transducer that tells the PCM the relative pressures in the exhaust stream passages and, sometimes, intake manifold. It is found on some Ford EEC IV and EEC V engine systems.

Ford calls it a PFE (Pressure Feedback EGR) sensor when the sensor outputs a signal that is proportional to the exhaust backpressure.

Ford calls it a DPFE (Differential Pressure Feedback EGR) sensor when the sensor outputs the relative difference in pressure between intake vacuum and exhaust.

These are important sensors because their signal input to the PCM is used to calculate EGR flow. A bad EGR pressure sensor can cause hesitation, engine pinging, and idle problems, among other driveability problems, and I/M emission test failures.

The EGR pressure sensor is usually a three wire sensor. One wire supplies the sensor with 5 V via the PCM's V Ref circuit, another wire provides the sensor ground, and the third wire is the sensor's signal output to the PCM.

Generally, Ford's DPFE sensors are found on late model 4.0 L Explorers and other vehicles and produce just under 1 V with no exhaust gas pressure and close to 5 V with maximum exhaust gas pressure.

NOTE

Ford's PFE sensors produce 3.25 V with no exhaust back pressure increasing to about 4.75 V with 1.8 PSI of exhaust back pressure. On properly operating vehicles the voltage won't ever get to 5 V. PFE sensors can be found on many Taurus and Sable models.

- Symptoms [OBD II DTC's: P0400 ~ P0408]

Hesitation, engine pinging, idle problems, I/M emission test failure

- Test Procedure

1. Connect the CH A lead to the sensor output HI and its ground lead to the sensor output LO or GND.
2. Start the engine and hold throttle at 2500 RPM for 2-3 minutes until the engine is fully warmed up and the Feedback Fuel System is able to enter closed loop. (Verify this by viewing the O₂ sensor signal, if necessary.)
3. Shut off A/C and all other accessories. Drive the vehicle under normal driving modes; start from dead stop, light acceleration, heavy acceleration, cruise, and deceleration.
4. Make sure that the amplitude is correct, repeatable, and present during EGR conditions. The sensor signal should be proportional to exhaust gas versus manifold vacuum pressures.
5. Make sure that all the hoses and lines to and from the intake manifold, EGR valve, and vacuum solenoid valve are intact, and routed properly, with no leaks. Make sure the EGR valve diaphragm can hold the proper amount of vacuum (check manufacturer's specs.). Make sure that the EGR passageways in and around the engine are clear and unrestricted from internal carbon buildup.
6. Press the HOLD key to freeze the waveform on the display for closer inspection.

• Reference Waveform

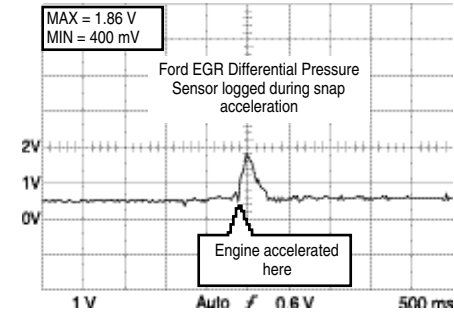

VEHICLE INFORMATION

YEAR : 1994
 MAKE : Ford
 MODEL : Explorer
 ENGINE : 4.0 L
 FUELSYS : Multiport Fuel Injection
 PCM_PIN : 27 BrnLtGrn wire
 STATUS : KOER (Key On Running)
 RPM : Snap Acceleration
 ENG_TMP : Operating Temperature
 VACUUM : 3-24 In. Hg
 MILEAGE : 40045

As soon as the engine reaches the predetermined EGR requirement conditions, the PCM will begin opening the EGR valve. The waveform should rise when the engine is accelerated. The waveform should fall when the EGR valve closes and the engine decelerates. EGR demands are especially high during accelerations. During idle and deceleration, the valve is closed.

• Troubleshooting Tips

There should be no breaks, spikes to ground, or dropouts in the waveform.

6.3 ACTUATOR TESTS

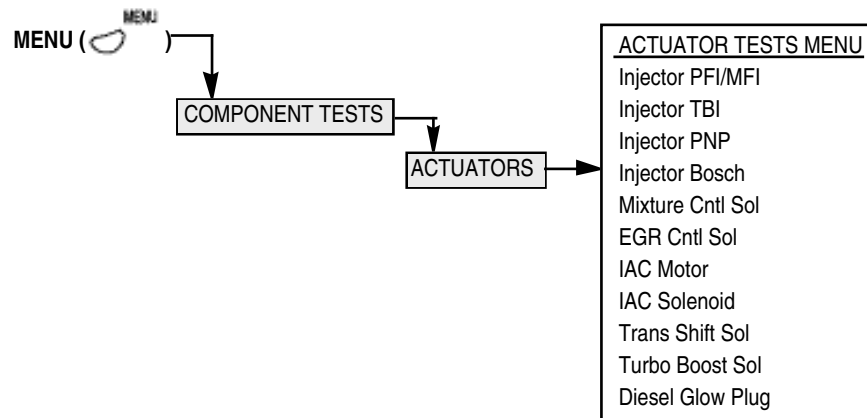

Saturated Switch Type (MFI/PFI/SFI) Injector

• Theory of Operation

The fuel injector itself determines the height of the release spike. The injector driver (switching transistor) determines most of the waveform features. Generally an injector driver is located in the PCM that turns the injector on and off. Different Kinds (Saturated Switch type, Peak-and-Hold type, Bosch type Peak-and-Hold, and PNP type) of injector drivers create different waveforms. Knowing how to interpret injector waveforms (determining on-time, referencing peak height, recognizing bad drivers, etc.) can be a very valuable diagnostic talent for driveability and emission repair.

Saturated switch injector drivers are used primarily on multiport fuel injection (MFI, PFI, SFI) systems where the injectors are fired in groups or sequentially. Determining the injector on-time is fairly easy. The injector on-time begins where the PCM grounds the circuit to turn it on and ends where the PCM opens the control circuit. Since the injector is a coil, when its electric field collapses from the PCM turning it off, it creates a spike. Saturated Switch type injectors have a single rising edge. The injector on-time can be used to see if the Feedback Fuel Control System is doing its job.

• Symptoms

Hesitation, rough idle, intermittent stall at idle, poor fuel mileage, emissions test failure, low power on acceleration

• Test Procedure

1. Connect the CH A lead to the injector control signal from the PCM and its ground lead to the injector GND.
2. Start the engine and hold throttle at 2500 RPM for 2-3 minutes until the engine is fully warmed up and the Feedback Fuel System enters closed loop. (Verify this by viewing the O₂ sensor signal, if necessary.)
3. Shut off A/C and all other accessories. Put vehicle in park or neutral. Rev the engine slightly and watch for the corresponding injector on-time increase on acceleration.
 - 1) Induce propane into the intake and drive the mixture rich. If the system is working properly, the injector on-time will decrease.
 - 2) Create a vacuum leak and drive the mixture lean. The injector on-time will increase.
 - 3) Raise the engine to 2500 RPM and hold it steady. The injector on-time will modulate from slightly larger to slightly smaller as the system controls the mixture. Generally, the injector on-time only has to change from 0.25 ms to 0.5 ms to drive the system through its normal full rich to full lean range.

IMPORTANT: If the injector on-time is not changing, either the system may be operating in an "open loop" idle mode or the O₂ sensor may be bad.
4. Use the Glitch Snare mode to check for sudden changes in the injector on-time.

• Reference Waveform

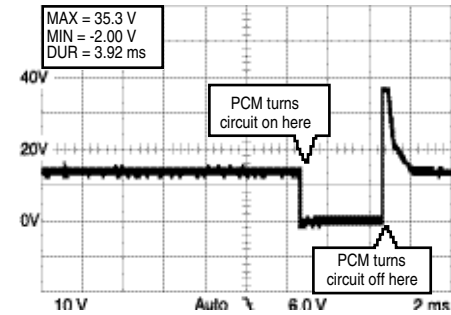

VEHICLE INFORMATION

YEAR : 1993
 MAKE : Ford
 MODEL : F150 4WD Pickup
 ENGINE : 5.0 L
 FUELSYS : Multiport Fuel Injection
 PCM_PIN : 58 Tan wire
 STATUS : KOER (Key On Running)
 RPM : Idle
 ENG_TMP : Operating Temperature
 VACUUM : 19 In. Hg
 MILEAGE : 66748

When the Feedback Fuel Control System controls fuel mixture properly, the injector on-time will modulate from about 1-6 ms at idle to about 6-35 ms under cold cranking or Wide Open Throttle (WOT) operation. The injector coil release spike(s) ranges are from 30 V to 100 V normally.

• Troubleshooting Tips

Spikes during on-time or unusual high turn off spikes indicate the injector driver's malfunction.

Peak and Hold Type (TBI) Injector

• Theory of Operation

Peak and Hold fuel injector drivers are used almost exclusively on Throttle Body Injection (TBI) systems. These drivers are only used on a few selected MFI systems like GM's 2.3 L Quad-4 engine family, Saturn 1.9 L, and Isuzu 1.6 L. The driver is designed to allow approximately 4 A to flow through the injector coil and then reduce the current flow to a maximum of about 1 A. Generally, far more current is required to open the pintle valve than to hold it open.

The PCM continues to ground the circuit (hold it at 0 V) until it detects about 4 A flowing through the injector coil. When the 4 A "Peak" is reached, the PCM cuts back the current to a maximum of 1 A, by switching in a current limiting resistor. This reduction in current causes the magnetic field to collapse partially, creating a voltage spike similar to an ignition coil spike. The PCM continues the "Hold" operation for the desired injector on-time, then it shuts the driver off by opening the ground circuit completely. This creates the second spike. Under acceleration the second spike move to the right, while the first remains stationary. If the engine is running extremely rich, both spikes are nearly on top of one another because the PCM is attempting to lean out the mixture by shortening injector on-time as much as possible.

• Symptoms

Hesitation on throttle tip in, rough idle, intermittent stall at idle, poor fuel mileage, emissions test failure, low power on acceleration.

• Test Procedure

1. Connect the CH A lead to the injector control signal from the PCM and its ground lead to the injector GND.
2. Start the engine and hold throttle at 2500 RPM for 2-3 minutes until the engine is fully warmed up and the Feedback Fuel System enters closed loop. (Verify this by viewing the O₂ sensor signal, if necessary.)
3. Shut off A/C and all other accessories. Put vehicle in park or neutral. Rev the engine slightly and watch for the corresponding injector on-time increase on acceleration.
 - 1) Induce propane into the intake and drive the mixture rich. If the system is working properly, the injector on-time will decrease.
 - 2) Create a vacuum leak and drive the mixture lean. The injector on-time will increase.
 - 3) Raise the engine to 2500 RPM and hold it steady. The injector on-time will modulate from slightly larger to slightly smaller as the system controls the mixture. Generally, the injector on-time only has to change from 0.25 ms to 0.5 ms to drive the system through its normal full rich to full lean range.
4. Use the Glitch Snare mode to check for sudden changes in the injector on-time.

• Reference Waveform

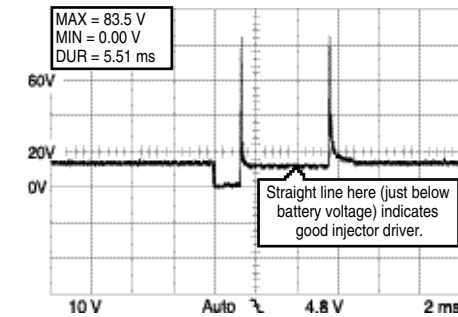

VEHICLE INFORMATION

YEAR : 1993
 MAKE : Chevrolet
 MODEL : Suburban 1500
 ENGINE : 5.7 L
 FUELSYS : Throttle Body Fuel Injection
 PCM_PIN : A16 DkBlu
 STATUS : KOER (Key On Running)
 RPM : Snap Acceleration
 ENG_TMP : Operating Temperature
 VACUUM : 3-24 In. Hg
 MILEAGE : 55011

When the Feedback Fuel Control System controls fuel mixture properly, the injector on-time will modulate from about 1-6 ms at idle to about 6-35 ms under cold cranking or Wide Open Throttle (WOT) operation. The injector coil release spike(s) ranges are from 30 V to 100 V normally. The turn off spikes less than 30 V may indicate shorted injector coil. Initial drive voltage should go close to 0 V. If not, injector driver may be weak.

• Troubleshooting Tips

Spikes during on-time or unusual high turn off spikes indicate the injector driver's malfunction. On GM and some ISUZU dual TBI systems lots of extra oscillations or "hash" in between the peaks indicates a faulty injector driver in the PCM.

PNP Type Injector

• Theory of Operation

A PNP type injector driver within the PCM has two positive legs and one negative leg. PNP drivers pulse power to an already grounded injector to turn it on. Almost all other injector drivers (NPN type) are opposite. They pulse ground to an injector that already has voltage applied. This is why the release spike is upside-down. Current flow is in the opposite direction. PNP type drivers can be found on several MFI systems; Jeep 4.0 L engine families, some pre-1988 Chrysler engine families, a few Asian vehicles, and some Bosch vehicles in the early 1970s like the Volvo 264 and Mercedes V-8s.

The injector on-time begins where the PCM switches power to the circuit to turn it on. The injector on-time ends where the PCM opens the control circuit completely.

• Symptoms

Hesitation on throttle tip in, rough idle, intermittent stall at idle, poor fuel mileage, emissions test failure, low power on acceleration

• Test Procedure

1. Connect the CH A lead to the injector control signal from the PCM and its ground lead to the injector GND.
2. Start the engine and hold throttle at 2500 RPM for 2-3 minutes until the engine is fully warmed up and the Feedback Fuel System enters closed loop. (Verify this by reviewing the O₂ sensor signal, if necessary.)
3. Shut off A/C and all other accessories. Put vehicle in park or neutral. Rev the engine slightly and watch for the corresponding injector on-time increase on acceleration.
 - 1) Induce propane into the intake and drive the mixture rich. If the system is working properly, the injector on-time will decrease.
 - 2) Create a Vacuum leak and drive the mixture lean. The injector on-time will increase.
 - 3) Raise the engine to 2500 RPM and hold it steady. The injector on-time will modulate from slightly larger to slightly smaller as the system control the mixture. Generally, the injector on-time only has to change from 0.25 ms to 0.5 ms to drive the system through its normal full rich to full lean range.

IMPORTANT: If the injector on-time is not changing, either the system may be operating in an "open loop" idle mode or the O₂ sensor may be bad.

4. Use the Glitch Snare mode to check for sudden changes in the injector on-time.

• Reference Waveform

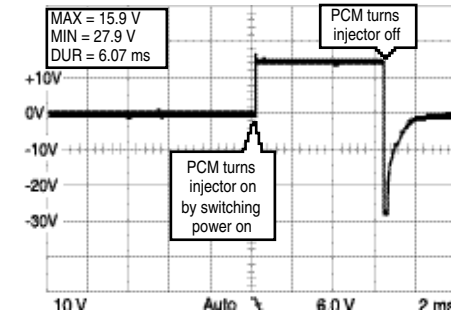

VEHICLE INFORMATION

YEAR : 1990
MAKE : Jeep
MODEL : Cherokee
ENGINE : 4.0 L
FUELSYS : Multiport Fuel Injection
PCM_PIN : 4 Yel wire at #4 injector
STATUS : KOER (Key On Running)
RPM : Idle
ENG_TMP : Operating Temperature
VACUUM : 16.5 In. Hg
MILEAGE : 85716

When the Feedback Fuel Control System controls fuel mixture properly, the injector on-time will modulate from about 1-6 ms at idle to about 6-35 ms under cold cranking or Wide Open Throttle (WOT) operation.
The injector coil release spike(s) ranges are from -30 V to -100 V normally.

NOTE

Some injector spike heights are "chopped" to between -30 V to -60 V by clamping diodes. There are usually identified by the flat top on their spike(s) instead of a sharper point. In those cases, a shorted injector may not reduce the spike height unless it is severely shorted.

• Troubleshooting Tips

Spikes during on-time or unusual large turn off spikes indicate the injector driver's malfunction.

Bosch-Type Peak and Hold Injector

• Theory of Operation

Bosch type Peak and Hold injector drivers (within the PCM) are designed to allow about 4 A to flow through the injector coil, then reduce the flow to a maximum of 1 A by pulsing the circuit on and off at a high frequency. The other type injector drivers reduce the current by using a “switch-in” resistor, but this type drivers reduce the current by pulsing the circuit on and off.

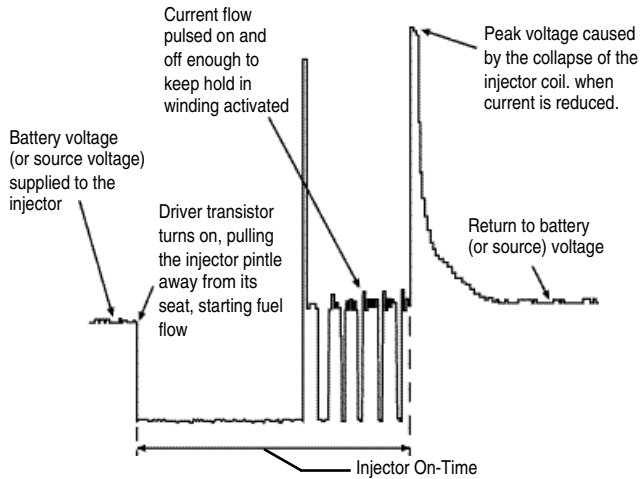

Bosch type Peak and Hold injector drivers are found on a few European models with MFI systems and some early to mid-1980s Asian vehicles with MFI systems.

• Symptoms

Hesitation on throttle tip in, rough idle, intermittent stall at idle, poor fuel mileage, emissions test failure, low power on acceleration

• Test Procedure

1. Connect the CH A lead to the injector control signal from the PCM and its ground lead to the injector GND.
2. Start the engine and hold throttle at 2500 RPM for 2-3 minutes until the engine is fully warmed up and the Feedback Fuel System enters closed loop. (Verify this by reviewing the O₂ sensor signal, if necessary.)
3. Shut off A/C and all other accessories. Put vehicle in park or neutral. Rev the engine slightly and watch for the corresponding injector on-time increase on acceleration.
 - 1) Induce propane into the intake and drive the mixture rich. If the system is working properly, the injector on-time will decrease.
 - 2) Create a vacuum leak and drive the mixture lean. The injector on-time will increase.
 - 3) Raise the engine to 2500 RPM and hold it steady. The injector on-time will modulate from slightly larger to slightly smaller as the system control the mixture. Generally, the injector on-time only has to change from 0.25 ms to 0.5 ms to drive the system through its normal full rich to full lean range.

IMPORTANT: If the injector on-time is not changing, either the system may be operating in an “open loop” idle mode or the O₂ sensor may be bad.

4. Use the Glitch Snare mode to check for sudden changes in the injector on-time.

• Reference Waveform

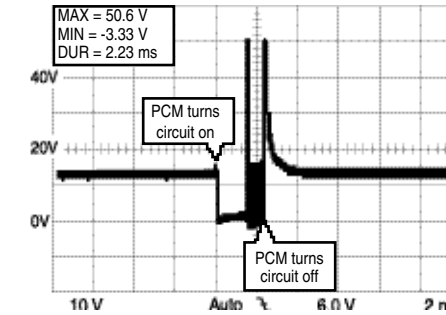

VEHICLE INFORMATION

YEAR : 1986
 MAKE : Nissan/Datsun
 MODEL : Stanza Wagon
 ENGINE : 2.0 L
 FUELSYS : Multiport Fuel Injection
 PCM_PIN : B WhtBlk wire
 STATUS : KOER (Key On Running)
 RPM : Idle
 ENG_TMP : Operating Temperature
 VACUUM : 21 In. Hg
 MILEAGE : 183513

When the Feedback Fuel Control System controls fuel mixture properly, the injector on-time will modulate from about 1-6 ms at idle to about 6-35 ms under cold cranking or Wide Open Throttle (WOT) operation. The injector coil release spike(s) ranges are from 30 V to 100 V normally.

IMPORTANT: On some European vehicles like Jaguar, there may be only one release spike because the first release spike does not appear due to a spike suppression diode.

• Troubleshooting Tips

Spikes during on-time or unusual high turn off spikes indicate the injector driver's malfunction.

Mixture Control Solenoid

• Theory of Operation

The mixture control signal is the most important output signal in a carbureted Feedback Fuel Control system. On a GM vehicle, this circuit pulses about 10 times per second, with each individual pulse (pulse width or on-time) varying, depending upon the fuel mixture needed at that moment.

In a GM vehicle, this circuit controls how long (per pulse) the main jet metering rods in the carburetor stay down (lean position). Most feedback carburetor systems operate in the same way – more mixture control on-time means lean mixture command. Generally, mixture control commands (from the PCM) that oscillate around duty cycles greater than 50 % mean the system is commanding a lean mixture in an effort to compensate for a long term rich condition.

• Symptoms

Hesitation on throttle tip in, poor fuel economy, erratic idle, rich or lean emissions

• Test Procedure

IMPORTANT: Before performing the test procedure, the O₂ sensor must be tested and confirmed good.

1. Connect the CH A lead to the mixture solenoid control signal from the PCM and its ground lead to GND.

2. Start the engine and hold throttle at 2500 RPM for 2-3 minutes until the engine is fully warmed up and the Feedback Fuel System enters closed loop. (Verify this by viewing the O₂ sensor signal.)
3. Shut off A/C and all other accessories. Put vehicle in park or neutral. Adjust lean stop, air bleed, and idle mixture as per recommended service procedures for the carburetor being serviced.
4. Use the Glitch Snare mode the check for signal dropouts.

• Reference Waveform

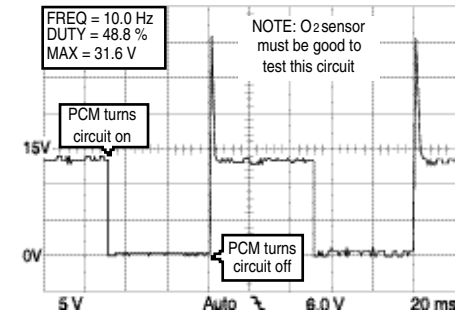

VEHICLE INFORMATIONS

YEAR : 1984
 MAKE : Oldsmobile
 MODEL : Delta 88
 ENGINE : 5.0 L
 FUELSYS : Feedback Carburetor
 PCM_PIN : 18 Blu wire (at test connector)
 STATUS : KOER (Key On Running)
 RPM : Idle
 ENG_TMP : Operating Temperature
 VACUUM : 19.5 In. Hg
 MILEAGE : 104402

When the main venturi metering circuits are adjusted properly (lean stop, air bleed, etc.), the mixture control signal should oscillate around 50 % duty cycle normally. When the main metering and idle mixture adjustments are set correctly, the tall spike will oscillate slightly from right to left and back again, but remain very close to the middle of the two vertical drops in the waveform. The PCM is oscillating the signal right to left, based on input from the O₂ sensor.

• Troubleshooting Tips

If the duty cycle does not remain around 50 %, check for vacuum leaks or a poor mixture adjustment.

If the waveform oscillates around 50 % duty cycle during one operating mode (for instance, idle) but not another, then check for vacuum leaks, misadjusted idle mixture, main metering mixture, or other non-feedback system problems that affect mixture at different engine speeds.

EGR (Exhaust Gas Recirculation) Control Solenoid

• Theory of Operation

EGR systems are designed to dilute the air-fuel mixture and limit NO_x formation when combustion temperatures generally exceed 2500 °F (1371 °C) and air-fuel ratios are lean. The effect of mixing exhaust gas (a relatively inert gas) with the incoming air-fuel mixture is a sort of chemical buffering or cooling of the air and fuel molecules in the combustion chamber. This prevents excessively rapid burning of the air-fuel charge, or even detonation, both of which can raise combustion temperatures above 2500 °F. The initial formation of NO_x is limited by EGR flow and then the catalytic converter acts to chemically reduce the amounts of produced NO_x entering the atmosphere.

How much and when EGR flow occurs is very important to emissions and driveability. To precise control EGR flow, the PCM sends Pulse Width Modulated signals to a vacuum solenoid valve to control vacuum flow to the EGR valve. When applying vacuum, the EGR valve opens, allowing EGR flow. When blocking vacuum, EGR flow stops.

Most engine control systems do not enable EGR operation during cranking, engine warm up, deceleration, and idling. EGR is precisely controlled during acceleration modes to optimize engine torque.

• Symptoms

Hesitation, loose power, stall, emissions with excessive NO_x, engine detonation (pinging)

• Test Procedure

1. Connect the CH A lead to the EGR control signal from the PCM and its ground lead to GND.
2. Start the engine and hold throttle at 2500 RPM for 2-3 minutes until the engine is fully warmed up and the Feedback Fuel System enters closed loop. (Verify this this by viewing the O₂ sensor signal.)
3. Shut off A/C and all other accessories. Drive the vehicle under normal driving modes; start from dead stop, light acceleration, heavy acceleration, cruise, and deceleration.
4. Make sure that the amplitude, frequency, shape, and pulse width are all correct, repeatable, and present during EGR flow conditions.
5. Make sure that all the hoses and lines to and from the intake manifold, EGR valve, and vacuum solenoid valve are all intact, and routed properly, with no leaks. Make sure the EGR valve diaphragm can hold the proper amount of vacuum. Make sure that the EGR passageways in and around the engine are clear and unrestricted from internal carbon buildup.
6. Use the Glitch Snare mode to check for signal dropouts.

• Reference Waveform

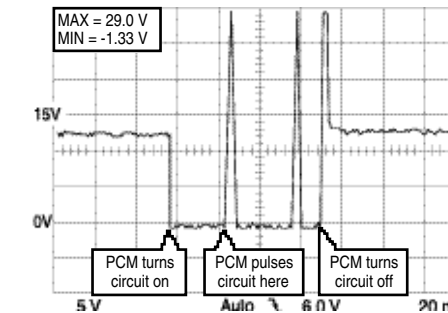

VEHICLE INFORMATIONS

YEAR : 1990
 MAKE : Chevrolet
 MODEL : Suburban
 ENGINE : 5.7 L
 FUELSYS : Throttle Body Fuel Injection
 PCM_PIN : A4 Gry wire
 STATUS : KOER (Key On Running)
 RPM : Light Acceleration
 ENG_TMP : Operating Temperature
 VACUUM : 12-23 In. Hg
 MILEAGE : 59726

As soon as the engine reaches the predetermined EGR requirement conditions, the PCM should begin pulsing the EGR solenoid with a pulse width modulated signal to open the EGR solenoid valve. EGR demands are especially high during accelerations.

• Troubleshooting Tips

If the waveform has runt (shortened) spike heights, it indicates a shorted EGR vacuum solenoid.

If the waveform has a flat line (no signal at all), it indicates a PCM failure, PCM's EGR conditions not met, or wiring or connector problem.

Too much EGR flow can make the vehicle hesitate, loose power, or even stall. Not enough EGR flow can result in emissions with excessive NOx and engine detonation (pinging).

IAC (Idle Air Control) Motor

• Theory of Operation

Idle air control valves keep the engine idling as low as possible, without stalling, and as smoothly as possible when accessories such as air conditioning compressors, alternators, and power steering load the engine.

Some IAC valves are solenoids (most Fords), some are rotating motors (European Bosch), and some are gear reduction DC stepper motors (most GM, Chrysler). In all cases, however, the PCM varies the amplitude or pulse width of the signal to control its operation and ultimately, idle speed.

Rotating IAC motors receive a continuous pulse train. The duty cycle of the signal controls the speed of the motor, and in turn the amount of air bypassing the throttle plate.

• Symptoms

Erratic high or low idle, stalling, high activity but no change in idle

• Test Procedure

1. Connect the CH A lead to the IAC control signal from the PCM and its ground lead to GND.
2. Run the engine at idle while turning accessories (A/C, blowers, wipers, etc.) on and off. If the vehicle has an automatic transmission, put it in and out of drive and park. This will change the load on the engine and cause the PCM to change the output command signal to the IAC motor.
3. Make sure that idle speed responds to the changes in duty cycle.
4. Use the Glitch Snare mode to check for signal dropouts.

• Reference Waveform

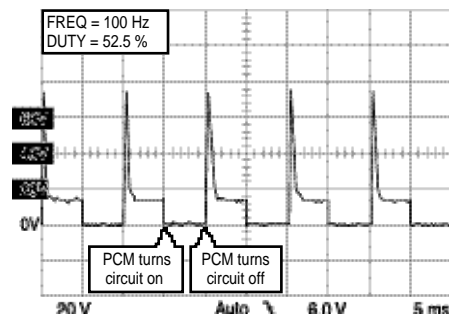

The idle control output command from the PCM should change when accessories are switched on and off or the transmission is switched in and out of gear. The pulse width modulated signals from the PCM should control the speed of the motor, and in turn the amount of air bypassing the throttle plate. The turn off spikes may not be present in all IAC drive circuits.

IMPORTANT : Before diagnosing IAC motor, several things must be checked and verified; the throttle plate should be free of carbon buildup and should open and close freely, the minimum air rate (minimum throttle opening) should be set according to manufacturer's specifications, and check for vacuum leaks or false air leaks.

• Troubleshooting Tips

If the engine idle speed doesn't change corresponding with the change of the PCM's command signal, suspect a bad IAC motor or clogged bypass passage.

IAC (Idle Air Control) Solenoid

• Theory of Operation

Idle air control solenoids keep the engine idling as low as possible, without stalling, and as smoothly as possible when accessories such as air conditioning compressors, alternators, and power steering load the engine.

Ford's IAC solenoids are driven by a DC signal with some AC superimposed on top. The solenoid opens the throttle plate in proportion to the DC drive it receives from the PCM. The DC drive is applied by holding one end of the solenoid coil at battery positive while pulling the other end toward GND. The DC voltage at the driven pin decreases as the solenoid drive current is increased.

• Symptoms

Erratic high or low idle, stalling, high activity but no change in idle

• Test Procedure

1. Connect the CH A lead to the IAC control signal from the PCM and its ground lead to the chassis GND.
2. Run the engine at idle while turning accessories (A/C, blowers, wipers, etc.) on and off. If the vehicle has an automatic transmission, put it in and out of drive and park. This will change the load on the engine and cause the PCM to change the output command signal to the IAC solenoid.
3. Make sure that the amplitude, frequency, and shape are all correct, repeatable, and consistent for the various idle compensation modes.
4. Make sure that idle speed responds to the changes in the IAC drive.

VEHICLE INFORMATIONS

YEAR : 1989
MAKE : BMW
MODEL : 525 I
ENGINE : 2.5 L
FUELSYS : Multiport Fuel Injection
PCM_PIN : 22 WhtGrn wire
STATUS : KOER (Key On Running)
RPM : Idle
ENG_TMP : Operating Temperature
VACUUM : 15 In. Hg
MILEAGE : 72822

• Reference Waveform

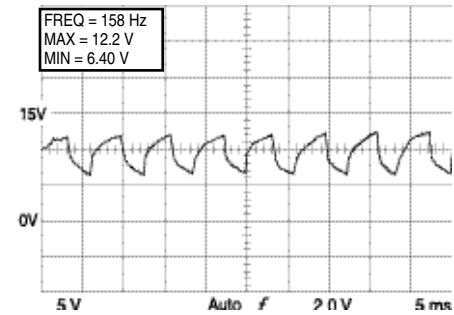

VEHICLE INFORMATION

YEAR : 1993
 MAKE : Ford
 MODEL : Explorer
 ENGINE : 4.0 L
 FUELSYS : Multiport Fuel Injection
 PCM_PIN : 21 Wht-LtBlu wire
 STATUS : KOER (Key On Running)
 RPM : Idle
 ENG_TMP : Operating Temperature
 VACUUM : 19 In. Hg
 MILEAGE : 54567

The idle control output command from the PCM should change when accessories are switched on and off or the transmission is switched in and out of gear. DC level should decrease as the IAC solenoid drive current is increased.

IMPORTANT: Before diagnosing IAC solenoid, several things must be checked and verified; the throttle plate should be free of carbon buildup and should open and close freely, the minimum air rate (minimum throttle opening) should be set according to manufacturer's specifications, and check for vacuum leaks or false air leaks.

• Troubleshooting Tips

If the engine idle speed doesn't change corresponding with the change of the PCM's command signal, suspect a bad IAC solenoid or clogged bypass passage.

Transmission Shift Solenoid

• Theory of Operation

The PCM controls an automatic transmission's electronic shift solenoid or torque converter clutch (TCC) lockup solenoid.

The PCM opens and closes the solenoid valves using a DC switched signal. These solenoid valves, in effect, control transmission fluid flow to clutch park, servos, torque converter lockup clutches, and other functional components of the transmission under the PCM's control.

Some electronic shift solenoid systems use ground feed controlled solenoids that are always powered up and some systems use power feed controlled solenoids that are always grounded. A ground feed controlled solenoid on a DC switched circuit appears as a straight line at the system voltage, and drops to ground when the PCM activates the solenoid. A power feed controlled solenoid on a DC switched circuit appears as a straight line at 0 V until the PCM activates the solenoid.

Many vehicle PCM's are programmed not to enable TCC operation until the engine reaches a certain temperature as well as a certain speed.

• Symptoms

Slow and improper shifting, engine stops running when vehicle comes to a stop

• Test Procedure

1. Connect the CH A lead to the transmission shift solenoid control signal from the PCM and its ground lead to the chassis GND.
2. Drive the vehicle as needed to make the driveability problem occur or to exercise the suspected shift solenoid circuit.
3. Make sure that the amplitude is correct for the suspected transmission operation.
4. Use the proper transmission fluid pressure gauges to make sure the transmission fluid pressure and flow being controlled by the solenoid is being effected properly by solenoid operation. This will help discriminate between an electronic problem and a mechanical problem (such as a sticking solenoid valve, clogged fluid passages, or leaking internal seals, etc.) in the transmission.

• Reference Waveform

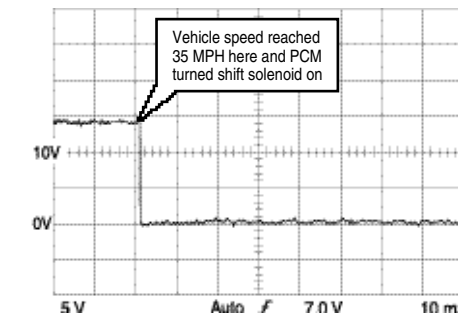

VEHICLE INFORMATION

YEAR : 1993
 MAKE : Ford
 MODEL : Explorer
 ENGINE : 4.0 L
 FUELSYS : Multiport Fuel Injection
 PCM_PIN : 52 Org Yel wire
 STATUS : KOBD (Key On Driven)
 RPM : 1500
 ENG_TMP : Operating Temperature
 VACUUM : 19 In. Hg
 MILEAGE : 54567

The drive signal should be consistent and repeatable.

• Troubleshooting Tips

If the waveform appears as a flat line (no signal at all), it can indicate a PCM failure, PCM conditions not met (shift points, TCC lockup, etc.), or wiring or connector problems.

Turbo Boost Control Solenoid

• Theory of Operation

Turbochargers increase horsepower considerably without increasing engine piston displacement. Turbochargers also improve torques over the useful RPM range and fuel economy, and reduces exhaust gas emissions.

Turbocharger's boost pressure must be regulated to obtain optimum acceleration, throttle response, and engine durability. Regulating the boost pressure is accomplished by varying the amount of exhaust gas that bypasses the exhaust side turbine. As more exhaust gas is routed around the turbine, the less boost pressure is increased.

A door (called the wastegate) is opened and closed to regulate the amount of bypass. The wastegate is controlled by a vacuum servo motor, which can be controlled by a vacuum solenoid valve that receives a control signal from the PCM. When the PCM receives a signal from the MAP sensor indicating that certain boost pressure is reached, the PCM commands the vacuum solenoid valve to open in order to decrease boost pressure. The PCM opens the solenoid valve via a pulse width modulated signal.

• Symptoms

Poor driveability, engine damage (blown head gasket), hard stall under acceleration

• Test Procedure

1. Connect the CH A lead to the solenoid control signal from the PCM and its ground lead to the chassis GND.
2. Start the engine and hold throttle at 2500 RPM for 2-3 minutes until the engine is fully warmed up and the Feedback Fuel system enters closed loop. (Verify this by viewing the O₂ sensor signal, if necessary.)
3. Drive the vehicle as needed to make the suspected problem occur.
4. Make sure that the drive signal comes on as the boost pressure is regulated and the wastegate actually responds to the solenoid control signal.

• Reference Waveform

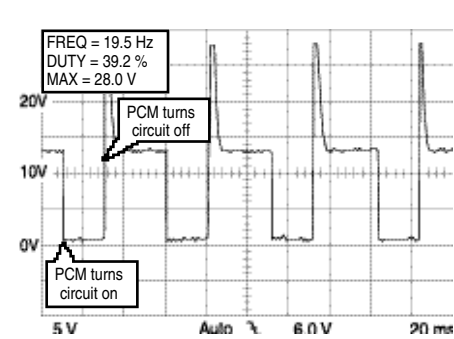

VEHICLE INFORMATION

YEAR : 1988
 MAKE : Chrysler
 MODEL : LeBaron Convertible
 ENGINE : 2.2 L Turbo
 FUELSYS : Multiport Fuel Injection
 PCM_PIN : 39 LtGrn Blk wire
 STATUS : KOBD (Key On Driven)
 RPM : Moderate Acceleration (35 MPH)
 ENG_TMP : Operating Temperature
 VACUUM : 5 In. Hg
 MILEAGE : 77008

As soon as the turbo engine reaches a predetermined boost pressure under acceleration, the PCM should begin pulsing the turbo boost solenoid with a varying pulse width modulated signal to open the wastegate. On deceleration, the signal is stopped and the valve is closed.

• Troubleshooting Tips

If the turn off spikes are not present, the solenoid coil may be shorted.

If the drive signal never appears under the high boost conditions, the driver within the PCM may have failed.

If the turn off spikes are runted (shortened), the vacuum solenoid valve may be shorted.

Diesel Glow Plug

• Theory of Operation

Starting cold diesel engines are not easy because Blowby past the piston rings and thermal losses reduce the amount of compression possible. Cold starting can be improved by a sheathed element glow plug in the precombustion chamber (in case of Direct-injection (DI) engines, in the main combustion chamber).

When current flows through the heating coil of the glow plug, a portion of the fuel around the glow plug's hot tip is vaporized to assist in igniting the air-fuel mixture. Newer glow plug systems, which continue to operate after engine startup for up to 3 minutes, improve initial engine performance, reduce smokes, emissions, and combustion noises.

Usually, a glow plug control unit supplies power to the glow plug during appropriate conditions. Some newer glow plugs are designed with a heater element that changes resistance with temperature. The glow plug's resistance increases as the heating element gets hotter by the combustion temperature's increment after startup.

Usually, glow plug systems are power feed controlled so the waveform of the current going through its heating element appears as a straight line at 0 V until the ignition key is switched on.

• Symptoms

No or hard start, emissions with excessive smokes, excessive combustion noises (knocks)

• Test Procedure

1. Set the instrument up with the current probe. (Connect the probe to the CH A.)
2. Adjust the probe to read DC Zero.
3. Clamp the current probe around the glow plug feed wire.
4. With the diesel engine stone cold, turn on the ignition key and watch for the readings.
5. Make sure that the amplitude of the current is correct and consistent for the glow plug systems under test.

• Reference Waveform

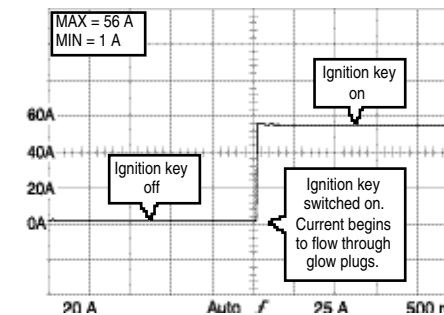

VEHICLE INFORMATION

YEAR : 1977
 MAKE : Mercedes-Benz
 MODEL : 240 D
 ENGINE : 2.4 L
 FUELSYS : Multiport Fuel Injection
 PCM_PIN : Power supply to glow plugs
 STATUS : KOEO (Key On Engine Off)
 RPM : 0
 ENG_TMP : Ambient Temperature
 VACUUM : 0 In. Hg
 MILEAGE : 151417

Look for the current going through the glow plug to be at its maximum when the ignition key is switched on. Maximum current and operating current specifications may be available from the manufacturer's service manual. All glow plugs should draw about the same current under cold or hot conditions.

• **Troubleshooting Tips**

If the waveform stays flat (at 0 V), suspect a faulty glow plug. If the waveform has drop outs, suspect an open circuit in the glow plug's heating element. An open circuit may be caused by overheat from a faulty controller, vibration, or fatigue related malfunctions.

6.4 ELECTRICAL TESTS

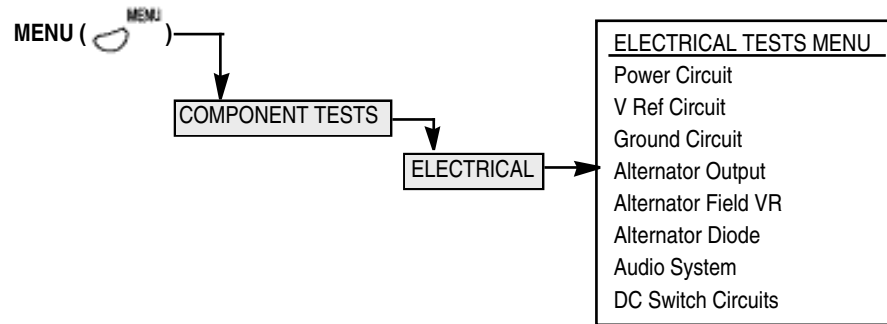

Power Supply Circuit

• **Theory of Operation**

This test procedure tests the integrity of the battery power supply to vehicle as well as to subsystems or switches that rely on battery power to operate. This test procedure can be used to assure components and devices are getting the quality and quantity of power supply necessary for proper operation. This procedure can be applied to a lot of different automotive circuits that use battery voltage as their power source, such as power supply circuits (to PCM and other control modules), temperature switches, throttle switches, vacuum switches, light switches, brake switches, cruise control switches, etc.

• **Symptoms**

No start, loss of power

• **Test Procedure**

1. Connect the CH A lead to the power supply circuit of the device to be tested and its ground lead to the device's GND.
2. Make sure power is switched on in the circuit so that the sensor, device or circuit is operational and current is flowing through the circuit.

3. Exercise the sensor, device, or circuit while watching for the amplitude of the signal. The amplitude should stay in a predetermined voltage range for a given condition.
4. In most cases, the amplitude of the waveform should stay at the battery voltage when the circuit is on, and go to 0 V when the circuit is off.

• **Reference Waveform**

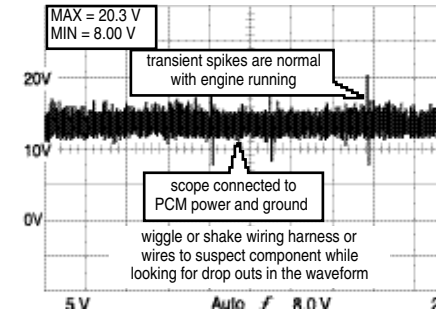

VEHICLE INFORMATION

YEAR : 1986
 MAKE : Oldsmobile
 MODEL : Toronado
 ENGINE : 3.8 L
 FUELSYS : Multiport Fuel Injection
 PCM_PIN : C16 Org and D1 BlkWht wires
 STATUS : KOER (Key On Running)
 RPM : Idle
 ENG_TMP : Operating Temperature
 VACUUM : 20 In. Hg
 MILEAGE : 123686

The voltage should stay in a predetermined voltage range for a given condition (during normal operation). Transient spikes above average voltage level are normal with engine running.

• **Troubleshooting Tips**

If the amplitude is changing when it is not supposed to (for example, when the switch in the circuit is not being operated), there may be a failure in the circuit.

If the waveform has some spikes to ground, there may be an open circuit in the power side or there may be a voltage short to ground.

If the waveform has some upward spikes, there may be an open circuit in the ground side.

Voltage Reference (V Ref) Circuit

• **Theory of Operation**

The PCM provides a stable regulated voltage, normally 5 V DC (8 V or 9 V DC on some older vehicles), to sensors and components controlled by it for operation. The V Ref circuit should stay at their specified voltage during normal operation. (The voltage level should not vary more than 200 mV under normal operation.)

• **Symptoms**

Low power, sensor output values out of range

• **Test Procedure**

1. Connect the CH A lead to the V Ref signal from the PCM and its ground lead to the sensor or chassis GND.

2. Make sure power is switched on to the PCM and monitor the voltage level of the V Ref signal from the PCM. Compare it with the manufacturer's recommended limits.
3. If the voltage level is unstable or the waveform shows spikes to ground, check the wiring harness for shorts or intermittent connections.

• Reference Waveform

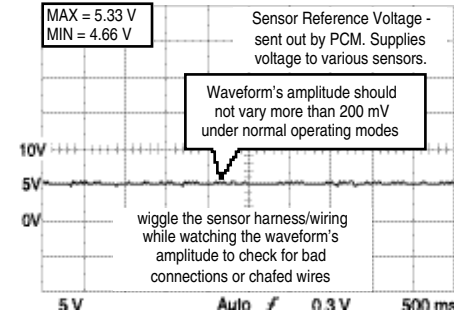

VEHICLE INFORMATION

YEAR : 1986
 MAKE : Oldsmobile
 MODEL : Toronado
 ENGINE : 3.8 L
 FUELSYS : Multiport Fuel Injection
 PCM_PIN : C14 Gry wire at TPS
 STATUS : KOER (Key On Running)
 RPM : Idle
 ENG_TMP : Operating Temperature
 VACUUM : 18 In. Hg
 MILEAGE : 123686

The voltage should stay in a predetermined voltage range for a given condition. Normal V Ref voltage ranges are from 4.50 V to 5.50 V.

• Troubleshooting Tips

If the voltage level is unstable or the waveform shows spikes to ground, check the wiring harness for shorts or bad connections.

Waveform's amplitude should not vary more than 200 mV under normal operation.

Ground Circuit

• Theory of Operation

A ground circuit controls the feedback on any controlled circuit by grounding that circuit to a common conductor (ground).

This test procedure tests the integrity of ground circuits by performing a voltage drop test across the suspected resistance in a ground circuit or the suspect junction.

This test procedure can be used assure components and devices are getting the quality of ground supply necessary for proper operation. This procedure can be applied to a lot of different automotive circuits that are grounded to the vehicle's electrical systems either through the engine block, chassis, or through a wire connected to the negative side of the battery.

• Symptoms

Poor performance, inaccurate sensor outputs

• Test Procedure

1. Connect the CH A lead to the GND pin of the grounded device or the one side of the suspect junction and its ground lead to the chassis GND or the other side of the suspect junction.
2. Make sure power is switched on in the circuit so that the sensor, device, or circuit is operational and current is flowing through the circuit.
3. The average voltage drop across the junction should be less than 100 mV to 300 mV.

• Reference Waveform

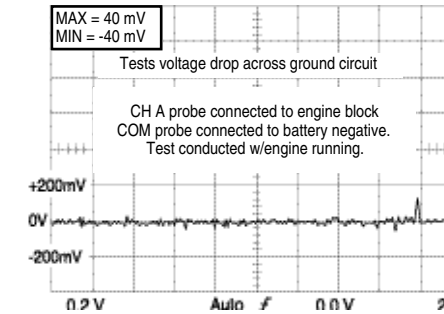

VEHICLE INFORMATION

YEAR : 1986
 MAKE : Oldsmobile
 MODEL : Toronado
 ENGINE : 3.8 L
 FUELSYS : Multiport Fuel Injection
 PCM_PIN : CH A on Engine Block
 COM on Battery Negative
 STATUS : KOER (Key On Running)
 RPM : Idle
 ENG_TMP : Operating Temperature
 VACUUM : 18 In. Hg
 MILEAGE : 123686

Average voltage drop should not exceed 100 - 300 mV. If there is too much resistance in the ground circuit, the waveform's amplitude will be too high.

• Troubleshooting Tips

If average voltage drop is excessive, clean or replace the connections and cables.

Alternator Output

• Theory of Operation

Alternators replaced generators due to their higher output at low engine speed, and their more compact and lightweight design. An alternator is an AC generator with diode rectification, which converts the AC signal to a pulsating DC signal. The DC signal charges the vehicle's battery and supplies power to run the vehicle's electrical and electronic systems. Field current is supplied to the rotor in the alternator to vary its output. Alternator output voltage increases as engine RPM increases.

The alternator's output voltage is controlled by a solid state regulator within the PCM, in some cases. The regulator limits the charging voltage to a preset upper limit and varies the amount of the excitation current supplied to the field winding. The field winding excitation is varied according to the battery's need for charge and ambient temperature.

Check the manufacturer's specs regarding the upper and lower limits of charging voltage permitted for the vehicle being checked.

The alternator's output voltage should be roughly 0.8 V to 2.0 V above the static battery voltage with the KOEO (Key Off Engine Off).

- **Symptoms**

No start, low battery, slow cranking

- **Test Procedure**

Before performing the alternator output voltage test, the battery's state of charge should be checked and a battery load test should be performed.

1. Connect the CH A lead to the battery positive post and its ground lead to the battery negative post.
2. Turn off all electrical loads and start the engine.
3. Hold the engine at 2500 RPM for about 3 minutes and check the alternator's output voltage.

- **Reference Waveform**

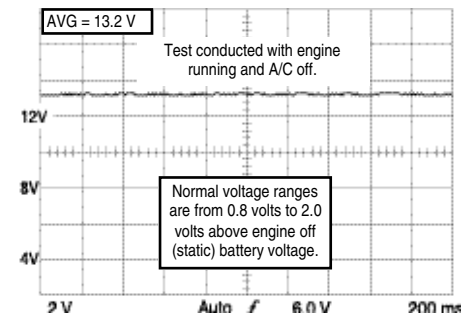

VEHICLE INFORMATION

YEAR : 1986
 MAKE : Oldsmobile
 MODEL : Toronado
 ENGINE : 3.8 L
 FUELSYS : Multiport Fuel Injection
 PCM_PIN : CH A to Positive side of Battery
 COM to GND
 STATUS : KOER (Key On Running)
 RPM : 2500
 ENG_TMP : Operating Temperature
 VACUUM : 20 In. Hg
 MILEAGE : 123686

Normal voltage ranges are about 0.8 V to 2.0 V above the static battery voltage with the Key Off Engine Off. Over 2.0 V may indicate an overcharge condition and less than 0.8 V may indicate an undercharge solution. Different vehicles have different charging system specifications. Consult the manufacturer's specs.
 General rules of thumb; GM 14.5 to 15.4 V, Ford 14.4 to 14.8 V, and Chrysler 13.3 to 13.9 V

IMPORTANT: The test results can be different in a big way according to the ambient temperature, what electrical loads are on the battery during testing, the age of battery, the battery's charging state, the level and quality of the battery's electrolyte, or the battery design.

- **Troubleshooting Tips**

If the output voltage is excessively high, or the battery is leaking, wet, smells like acid, or is boiling, the alternator may be defective. Check the regulator for its proper operation. Also perform a voltage drop test on both sides of the alternator housing and at the battery. If the voltage is different, the alternator may be grounded improperly.

Alternator Field/ VR (Voltage Reference)

- **Theory of Operation**

A voltage regulator (in the PCM) controls alternator output by adjusting the amount of current flowing through the rotor field windings. To increase alternator output, the voltage regulator allows more current to flow through the rotor field windings. The field control current is varied according to the battery's need for charge and ambient temperature.

If the battery is discharged, the regulator may cycle the field current on 90 % of the time to increase the alternator output. If the electrical load is low, the regulator may cycle the field current off 90 % of the time to decrease the alternator output. That is the signal is usually pulse width modulated.

If the field control circuit is malfunctioning, the charging system can overcharge or undercharge, either creating problems.

- **Symptoms**

Undercharging, overcharging, or no charging output

- **Test Procedure**

1. Connect the CH A lead to the field control circuit the and its ground lead to the chassis GND.
2. Start the engine and run at 2500 RPM. Operate the heater fan on high with the headlight on high beam, or use battery load tester to vary the amount of load on the vehicle's electrical system.
3. Make sure that the voltage regulator is properly controlling the duty cycle of the alternator field drive signal as the load changes.

- **Reference Waveform**

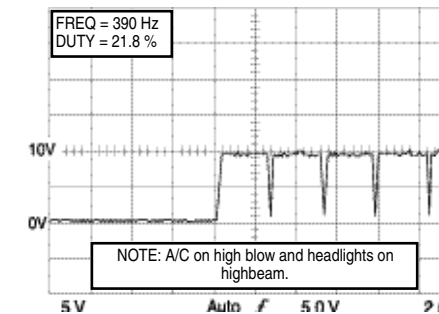

VEHICLE INFORMATION

YEAR : 1986
 MAKE : Oldsmobile
 MODEL : Toronado
 ENGINE : 3.8 L
 FUELSYS : Multiport Fuel Injection
 PCM_PIN : 3D11 at BCM Grey wire at alternator pin F
 RPM : 2500
 ENG_TMP : Operating Temperature
 VACUUM : 18 In. Hg
 MILEAGE : 123686

The charging system's voltage regulator should vary the on-time of the alternator's field control drive signal depending on the electrical system requirements. The regulator should pulse the field drive signal with the overall duty cycle average meeting the electrical system demands. When electrical load is put on the battery, the field control circuit should go high to compensate for it. Frequency may increase during conditions of increased charging demand.

• Troubleshooting Tips

If the voltage is high, there is no command to turn the alternator on or the regulator does not have the ability to decrease the voltage.

If the voltage is low, the alternator will be on all the time and cause an overcharging state.

If the voltage can not be pulled to ground sufficiently, there may be bad regulator within the PCM.

Alternator Diode

• Theory of Operation

An alternator generates current and voltage by the principles of electromagnetic induction. Accessories connected to the vehicle's charging system require a steady supply of direct current (DC) at a relatively steady voltage level. A set of diodes, part of the alternator's rectifier bridge, modifies the AC voltage (produced in the alternator) to the DC voltage. When analyzing a vehicle's charging system, both AC and DC level should be analyzed because the AC level (called "ripple voltage") is a clear indication of diode condition. Too high a level of AC voltage can indicate a defective diode and discharge the battery.

Usually, a bad alternator diode produces Peak to Peak voltages of more than 2 V.

• Symptoms

Overnight battery draining, excessive AC current from alternator output, flickering lights, poor driveability

• Test Procedure

NOTE

*This test is made at the rear case half of the alternator and not battery.
The battery can act as a capacitor and absorb the AC voltage.*

1. Connect the CH A lead to the B+ output terminal on the back of the alternator and its ground lead to the alternator case.
2. With the Key On, Engine Off, turn on the high beam headlights, put the A/C or heater blower motor on high speed, turn on the windshield wipers, and rear defrost (if equipped) for 3 minutes.
3. Start the engine and let it idle.
4. Make sure that pulses in ripple waveform are all about the same size and that pulses are not grouped into pairs.

• Reference Waveform

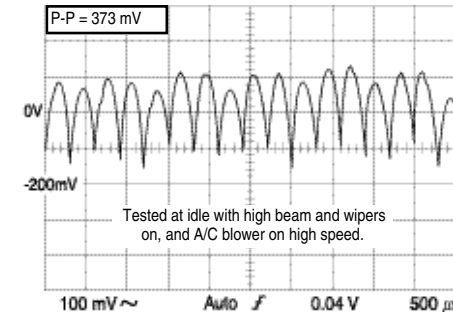

VEHICLE INFORMATION

YEAR : 1986
MAKE : Oldsmobile
MODEL : Toronado
ENGINE : 3.8 L
FUELSYS : Multiport Fuel Injection
PCM_PIN : B+ post at alternator
STATUS : KOER (Key On Running)
RPM : Idle
ENG_TMP : Operating Temperature
VACUUM : 18 In. Hg
MILEAGE : 123686

A bad alternator diode produces Peak to Peak voltages exceeding 2 V usually and its waveform will have "humps" that drop out and go much lower than the normal ones shown above.
A shorted diode splits the pulses into pairs.

• Troubleshooting Tips

If the waveform has very noticeable dropouts with two or three times the peak to peak amplitude of a normal ripple, the diodes are defective. Dropouts from bad diodes usually have a peak to peak voltages of around 1.5 V to 2.0 V.

If the humps in the waveform are grouped into pairs, the alternator has one or more bad diodes.

Audio System Speaker

• Theory of Operation

Automotive speakers are electromechanical devices that convert electrical signal from a vehicle's radio (or monitoring system) into mechanical vibrations. The mechanical vibrations produced by automotive speakers are in the audible frequency range from 16 to 20,000 Hz.

Audio signals to the speaker usually range between 0.5 and 10 V Peak to Peak. DC resistance of the speaker voice coils is normally less than 10 ohms.

• Symptoms

A blown speaker with an open circuit

• Test Procedure

1. Connect the CH A lead to the positive speaker circuit and its ground lead to the negative speaker circuit.
2. Turn on the radio at normal listening level and make sure that the speaker drive signal is present.
3. To measure the resistance of the speaker voice coils, set the instrument to the GMM mode. Measure the resistance with the drive signal disconnected.

• **Reference Waveform**

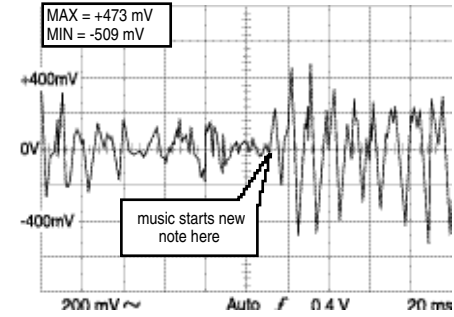

VEHICLE INFORMATION

YEAR : 1989
 MAKE : Buick
 MODEL : Le Sabre
 ENGINE : 3.8 L
 FUELSYS : Multiport Fuel Injection
 PCM_PIN : CH A to speaker (+)
 COM to speaker (-)
 STATUS : KOEO (Key On Engine Off)
 RPM : 0
 ENG_TMP : Ambient Temperature
 VACUUM : 0 In. Hg
 MILEAGE : 93640

A few notes from Willie Nelson's
 "On The Road Again"

Automotive speaker drive signals normally range between 0.5 V and 10 V Peak to Peak.
 Resistance of the speaker voice coils is normally less than 10 ohms.

• **Troubleshooting Tips**

If the speaker is blown, suspect an open circuit.

DC Switch Circuits

• **Theory of Operation**

This test procedure can be applied to a lot of different automotive circuits that use B+ as their power source, such as power supply circuits (to the PCM and other control modules), temperature switches, throttle switches, vacuum switches, light switches, brake switches, cruise control switches, etc.

This test can be used to test the integrity of the battery power supply to the switches that rely on the battery power to operate.

• **Symptoms**

No start, lose of power, no working of switches

• **Test Procedure**

1. Connect the CH A lead to the power supply circuit of the switch to be tested and its ground lead to the switch GND circuit.
2. Make sure power is switched on in the circuit so that the switch is operational.

3. Exercise the switch while paying attention to the amplitude of the signal. It should stay in a predetermined voltage range for a given condition. In most cases, the amplitude of the waveform should stay at B+ or battery voltage when the circuit is on, and go to 0 V when the switch is activated.

• **Reference Waveform**

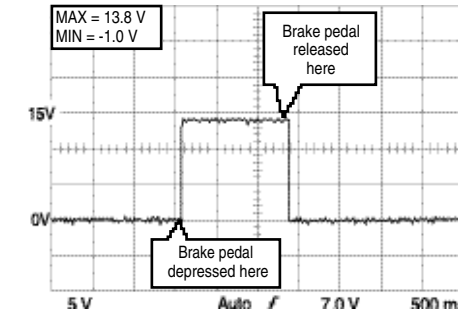

VEHICLE INFORMATION

YEAR : 1993
 MAKE : Ford
 MODEL : Explorer
 ENGINE : 4.0 L
 FUELSYS : Multiport Fuel Injection
 PCM_PIN : 2 Lt Grn wire
 STATUS : KOER (Key On Running)
 RPM : Idle
 ENG_TMP : Operating Temperature
 VACUUM : 19 In. Hg
 MILEAGE : 54567

If there is a failure in the circuit, the waveform's amplitude will change when it is not supposed to.

• **Troubleshooting Tips**

- If the waveform has spikes to ground, there may be an open circuit in the power side or a voltage short to ground.
- If the waveform has upward spikes, there may be an open in the ground side.

6.5 IGNITION TESTS

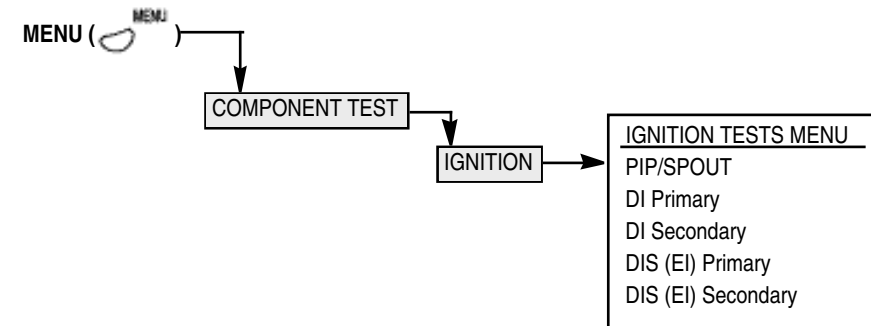

PIP (Profile Ignition Pickup)/SPOUT (Spark Output)

• Theory of Operation

The most common electronic ignition system found on Ford vehicles (primarily on Ford/Lincoln/Mercury) has been dubbed TFI for Thick Film Ignition. This system uses a Hall Switch in the TFI module, mounted on the distributor, to produce a basic spark timing signal, PIP (Profile Ignition Pickup). This signal is sent to the PCM and the PCM uses this signal to monitor results and accurately time the fuel injector and electronic spark timing output (SPOUT) signals. The PCM sends the SPOUT back to the TFI module, which then fires the ignition coil primary circuit. The PIP signal is primarily a frequency modulated signal that increases and decreases its frequency with engine RPM, but it has also a pulse width modulated component because it is acted upon by the TFI module, based on information previously received via the SPOUT signal.

The SPOUT signal is a pulse width modulated signal because the PCM continually alters the SPOUT signal's pulse width, which has the primary ignition dwell and ignition timing advance information encoded in it. The frequency of the SPOUT signal also increases and decreases with engine RPM because it simply mimics the frequency of the PIP signal.

Many GM/European/Asian vehicles use a similar overall ignition circuit design.

The rising and falling edges of the SPOUT move in relation to PIP. The rising edge controls spark timing and the falling edge controls coil saturation (dwell).

Watching both simultaneously using this instrument will tell you whether the PCM can compute timing based on sensor inputs. For example, if the MAP sensor fails, the rising edge of SPOUT will not move relative to the rising edges of PIP when Manifold Absolute Pressure changes.

• Symptoms

Engine stall out, misfire, slow advance timing, hesitations, no start, poor fuel economy, low power, high emissions

• Test Procedure

1. Connect the ground leads of both channel test leads to the chassis GND's. Connect the CH A to the PIP signal and the CH B to the SPOUT signal. Use a wiring diagram for the vehicle being serviced to get the PCM pin number, or color of the wire for each circuit.
2. Crank or start the engine.
3. With the Key On, Engine Running (KOER), let the engine idle, or use the throttle to accelerate and decelerate the engine, or drive the vehicle as needed to make the driveability problem occur.
4. Look closely to see that the frequency of both signals is keeping pace with engine RPM and that the pulse width on the pulse width modulated notches of the signal changes when timing changes are required.
5. Look for abnormalities observed in the waveforms to coincide with an engine sputter or driveability problem.

• Reference Waveform

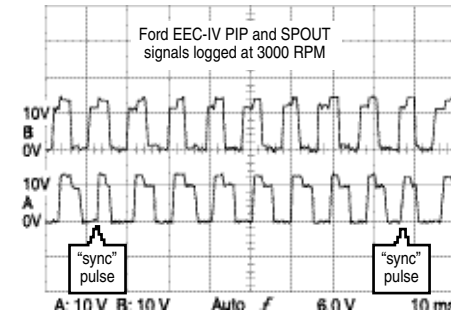

VEHICLE INFORMATION

YEAR : 1993
MAKE : Ford
MODEL : F150 4WD Pickup
ENGINE : 5.0 L
FUELSYS : Multiport Fuel Injection
PCM_PIN : CH A 56 GryOrg wire
 CH B 36 Pnk wire
STATUS : KOER (Key On Running)
RPM : 3000
ENG_TMP : Operating Temperature
VACUUM : 21 In. Hg
MILEAGE : 66748

The edges must be sharp. Anything that affects ignition timing should change the position of SPOUT (upper trace) with respect to PIP (lower trace). The notches out of the top and bottom corner of PIP go away when the SPOUT connector is removed because this cuts off the TFI's ability to encode the PIP signal with the SPOUT information.

• Troubleshooting Tips

If changing manifold vacuum has no effect on the rising edges of SPOUT, check for a faulty BP/MAP sensor.

If PIP is absent, the engine will not start; check for a bad TFI module or other distributor problem.

If SPOUT is absent, the system may be in LOS (Limited Operation Strategy) or limp-home mode. Check for problems in the PCM or bad wiring harness connectors.

If the rising edges of PIP or SPOUT are rounded, timing will be inaccurate, although the system may not set an error code. Check for problems in the module producing each signal.

DI (Distributor Ignition) Primary

• Theory of Operation

The ignition coil primary signal is one of the top three most important diagnostic signals in powertrain management systems. This signal can be used for diagnosing the driveability problems such as no starts, stalls at idle or while driving, misfires, hesitation, cuts out while driving, etc.

The waveform displayed from the ignition primary circuit is very useful because occurrences in the ignition secondary burn are induced back into the primary through mutual induction of the primary and secondary windings.

This test can provide valuable information about the quality of combustion in each individual cylinder. The waveform is primarily used to :

1. analyze individual cylinder's dwell (coil charging time),
2. analyze the relationship between ignition coil and secondary circuit performance (from the firing line or ignition voltage line),
3. locate incorrect air-fuel ratio in individual cylinder (from the burn line), and

4. locate fouled or damaged spark plugs that cause a cylinder misfire (from the burn line).

It's sometimes advantageous to test the ignition primary when the ignition secondary is not easily accessible.

• Symptoms

No or hard starts, stalls, misfires, hesitation, poor fuel economy

• Test Procedure

1. Connect the CH A lead to the ignition coil primary signal (driven side) and its ground lead to the chassis GND.
2. With the Key On, Engine Running (KOER), use the throttle to accelerate and decelerate the engine or drive the vehicle as needed to make the driveability problem or misfire occur.
3. For cranking test, set the Trigger mode to Normal.
4. Make sure that the amplitude, frequency, shape and pulse width are all consistent from cylinder to cylinder. Look for abnormalities in the section of the waveform that corresponds to specific components.

• Reference Waveform

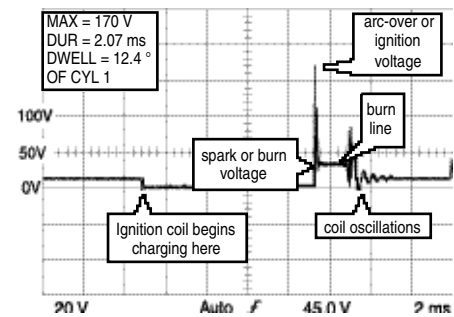

VEHICLE INFORMATIONS

YEAR : 1987
MAKE : Chrysler
MODEL : Fifth Avenue
ENGINE : 5.2 L
FUELSYS : Feedback Carburetor
PCM_PIN : CH A to Negative side of ignition coil
STATUS : KOER (Key On Running)
RPM : Idle
ENG_TMP : Operating Temperature
VACUUM : 20 In. Hg
MILEAGE : 140241

The Ignition Peak voltage and Burn voltage measurements are available in this test, but they should be corrected to account for the turns ratio of the coil windings. Look closely to see that the pulse width (dwell) changes when engine load and RPM changes.

• Troubleshooting Tips

Look for the drop in the waveform where the ignition coil begins charging to stay relatively consistent, which indicates consistent dwell and timing accuracy of individual cylinder.

Look for a relatively consistent height on the "arc-over" voltage or firing line. A line that is too high indicates high resistance in the ignition secondary due to an open or bad spark plug wire or a large spark gap. A line that is too short indicates lower (than normal) resistance in the ignition secondary due to fouled, cracked, or arcing spark plug wire, etc.

Look for the spark or burn voltage to remain fairly consistent. This can be an indicator of air-fuel ratio in the cylinder. If the mixture is too lean, the burn voltage may be higher, and if too rich, the voltage may be lower than normal.

Look for the burn line to be fairly clean without a lot of hash ("noise"). A lot of hash can indicate an ignition misfire in the cylinder due to over-advanced ignition timing, bad injector, fouled spark plug, or other causes. Longer burn lines (over 2 ms) can indicate an abnormally rich mixture and shorter burn line (under 0.75 ms) can indicate an abnormally lean mixture.

Look for at least 2, preferably more than 3 oscillations after the burn line. This indicates a good ignition coil (and a good condenser on point-type ignitions).

DI (Distributor Ignition) Secondary (Conventional Single and Parade)

Secondary ignition patterns are very useful when diagnosing ignition related malfunctions. The secondary scope pattern is divided into three sections:

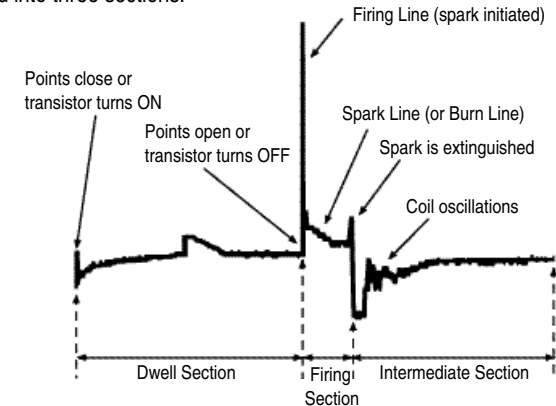

SECONDARY FIRING SECTION

The firing section consists of a firing line and a spark (or burn) line. The firing line is a vertical line that represents the voltage required to overcome the gap of the spark plug. The spark line is a semi-horizontal line that represents the voltage required to maintain current flow across the spark gap.

SECONDARY INTERMEDIATE SECTION

The intermediate section displays the remaining coil energy as it dissipates itself by oscillating between the primary and secondary side of the coil (with the points open or transistor off).

SECONDARY DWELL SECTION

The dwell section represents coil saturation, which is the period of time the points are closed or the transistor is on. The ignition (or distributor) dwell angle is the number of degrees of distributor rotation during which the points or transistor are closed (or magnetic saturation time in degrees).

Normally, it takes about 10 to 15 ms for an ignition coil to develop complete magnetic saturation from primary current.

The secondary ignition test has been an effective driveability check for over three decades along with the primary ignition test. The ignition secondary waveform can be useful in detection of problems in mechanical components of engine and fuel system, as well as the ignition system components.

When the PARADE mode is selected, this instrument will present a parade of all the cylinders, starting at the left with the spark line of the number 1 cylinder. The instrument will display the pattern for each cylinder's ignition cycle in the engine's firing order. For example, if the firing order for a given engine is 1,4,3,2, the instrument will display the ignition cycles for each cylinder as shown starting with cylinder number 1, then 4, then 3, and then 2.

Firing lines should be equal. A short line indicates low resistance in the wire. A high line indicates high resistance in the wire

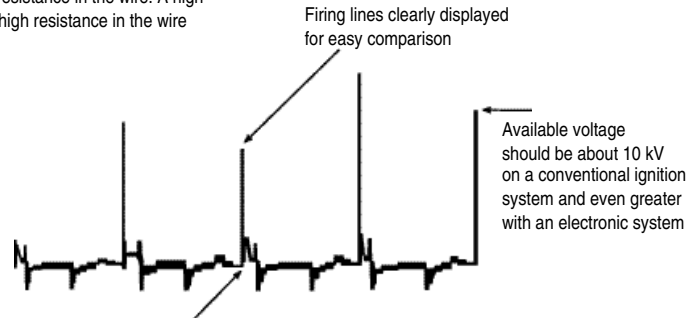

Spark lines can be viewed side-by-side for ease of comparison

Cylinders are displayed in firing order

• Symptoms

No or hard starts, stalls, misfires, hesitation, poor fuel economy

• Test Procedure

NOTE

A Capacitive type ignition secondary probe must be used to test the ignition secondary circuit. Connecting the CH A or CH B leads directly to an ignition secondary circuit can cause severe damage to the instrument or even personal injury.

Connect the test leads as displayed by the test tool's HELP (Test Procedure) and shown in Figure below.

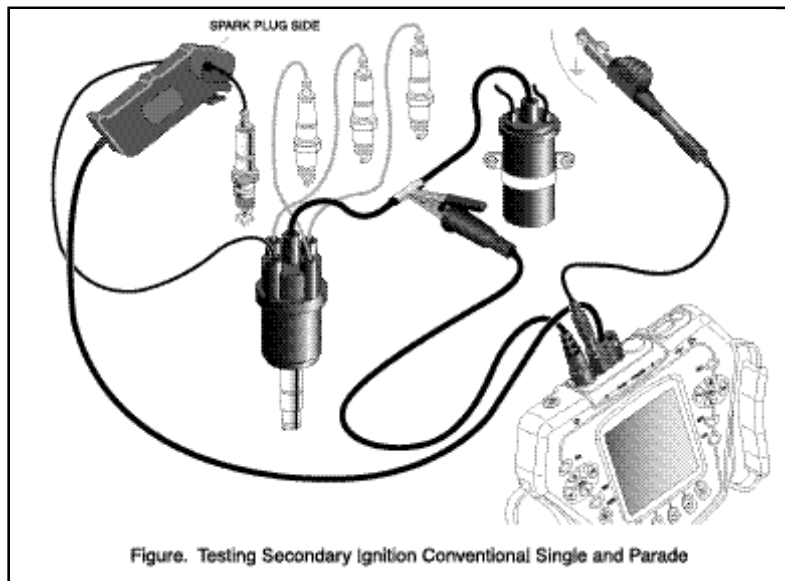

Figure. Testing Secondary Ignition Conventional Single and Parade

1. Connect the capacitive type ignition secondary probe to the CH A input terminal.
2. Connect the Inductive Pickup to the COM/TRIGGER input terminals and connect the COM input of the test tool to vehicle ground by using a Ground Lead (black) in order to avoid electrical shock before clamping the capacitive secondary pickup and the inductive pickup on the ignition wires.

NOTE

The Inductive Pickup must be used to synchronize triggering between the spark plug wire signal and the coil secondary signal clamped by the capacitive secondary probe.

3. Clip the secondary probe to the coil secondary lead wire and clamp the pickup probe on the spark plug wire close to the spark plug.

IMPORTANT : Signals from individual spark plug wires are useful only for triggering. Ignition Peak Voltage, Burn Voltage, and Burn Time measurements may not be accurate, if the signal is taken on the spark plug side of the distributor, due to the rotor spark gap. For accurate measurements, use the coil secondary signal before the distributor.

NOTE

If you want to test SECONDARY IGNITION SINGLE, press to highlight SINGLE and SECONDARY IGNITION PARADE, press to highlight PARADE.

4. With the Key On, Engine Running (KOER), use the throttle to accelerate and decelerate the engine or drive the vehicle as needed to make the driveability problem or misfire occur.
5. Make sure that the amplitude, frequency, shape and pulse width are all consistent from cylinder to cylinder. Look for abnormalities in the section of the waveform that corresponds to specific components.

• Reference Waveform

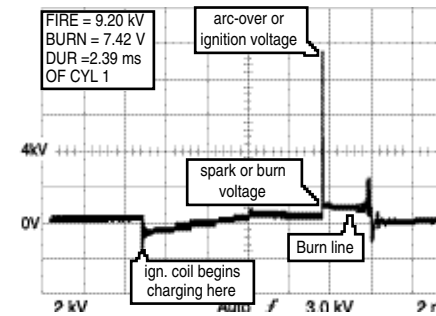

VEHICLE INFORMATIONS

YEAR : 1984
 MAKE : Mercedes-Benz
 MODEL : 380 SE
 ENGINE : 3.8 L
 FUELSYS : CIS Fuel Injection
 PCM_PIN : CH A to the Coil wire
 STATUS : KOER (Key On Running)
 RPM : Idle
 ENG_TMP : Operating Temperature
 VACUUM : 19.5 In. Hg
 MILEAGE : 18575

Look closely to see that the pulse width (dwell) changes when engine load and RPM changes.

• Troubleshooting Tips

Look for the drop in the waveform where the ignition coil begins charging to stay relatively consistent, which indicates consistent dwell and timing accuracy of individual cylinder.

Look for a relatively consistent height on the “arc-over” voltage or firing line. A line that is too high indicates high resistance in the ignition secondary due to an open or bad spark plug wire or a large spark gap. A line that is too short indicates lower (than normal) resistance in the ignition secondary due to fouled, cracked, or arcing spark plug wire, etc.

Look for the spark or burn voltage to remain fairly consistent. This can be an indicator of air-fuel ratio in the cylinder. If the mixture is too lean, the burn voltage may be higher, and if too rich, the voltage may be lower than normal.

Look for the burn line to be fairly clean without a lot of hash. A lot of hash can indicate an ignition misfire in the cylinder due to over-advanced ignition timing, bad injector, fouled spark plug or other causes. Longer burn lines (over 2 ms) can indicate an abnormally rich mixture and shorter burn lines (under 0.75 ms) can indicate an abnormally lean mixture.

Look for at least 2, preferably more than 3 oscillations after the burn line. This indicate a good ignition coil (a good condenser on point-type ignitions).

DIS (Distributorless Ignition System) Primary

• Theory of Operation

The DIS (or EI) primary ignition test is an effective test for locating ignition problems that relate to EI ignition coils. The waveform is very useful because occurrences in the ignition secondary burn are induced back into the primary through mutual induction of the primary and secondary windings. The waveform is primarily used to :

1. analyze individual cylinder dwell (coil charging time),
2. analyze ignition coil and secondary circuit performance (from the firing line),
3. locate incorrect air-fuel ratio in individual cylinders (from the burn line), and
4. locate fouled or damaged spark plugs that cause a cylinder misfire (from the burn line).

This test can be useful in detection of problems in mechanical engine and fuel system components, as well as ignition system components.

• Symptoms

No or hard starts, stalls, misfires, hesitation, poor fuel economy

• Test Procedure

1. Connect the CH A lead to the ignition coil primary signal (driven side) and its ground lead to the chassis GND.
2. With the key on, engine running, let the engine idle, or use the throttle to accelerate and decelerate the engine or drive the vehicle as needed to make the driveability problem or misfire occur.
3. Make sure that the amplitude, frequency, shape and pulse width are all consistent from cylinder to cylinder. Look for the abnormalities in the section of the waveform that corresponds to specific components.
4. If necessary, adjust the trigger level for a stable display.

• Reference Waveform

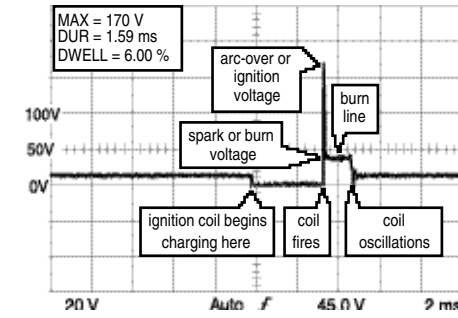

The Ignition Peak voltage and Burn voltage measurements are available in this test, but they should be corrected to account for the turns ratio of the coil windings.

VEHICLE INFORMATION

YEAR : 1994
MAKE : Ford
MODEL : Explorer
ENGINE : 4.0 L
FUELSYS : Multiport Fuel Injection
PCM_PIN : 10 Coil A YelBlk at ignition
STATUS : KOER (Key On Running)
RPM : Idle
ENG_TMP : Operating Temperature
VACUUM : 19.5 In. Hg
MILEAGE : 40045

• Troubleshooting Tips

Look for the drop in the waveform where the ignition coil begins charging to stay relatively consistent, which indicates consistent dwell and timing accuracy of individual cylinder.

Look for a relatively consistent height on the “arc-over” voltage or firing line. A line that is too high indicates high resistance in the ignition secondary due to an open or bad spark plug wire or a large spark gap. A line that is too short indicates lower (than normal) resistance in the ignition secondary due to fouled, cracked, or arcing spark plug wire, etc.

Look for the spark or burn voltage to remain fairly consistent. This can be an indicator of air-fuel ratio in the cylinder. If the mixture is too lean, the burn voltage may be higher, and if too rich, the voltage may be lower than normal.

Look for the burn line to be fairly clean without a lot of hash, which can indicate an ignition misfire in the cylinder due to over-advanced ignition timing, bad injector, fouled spark plug or other causes. Longer burn lines (over 2 ms) can indicate an abnormally rich mixture and shorter burn lines (under 0.75 ms) can indicate an abnormally lean mixture.

Look for at least 2, preferably more than 3 oscillations after the burn line. This indicate a good ignition coil (a good condenser on point-type ignitions).

DIS (Distributorless Ignition System) Secondary

• Theory of Operation

Most Distributorless Ignition systems use a waste spark method of spark distribution. Each cylinder is paired with the cylinder opposite to it (1-4, or 3-6, or 2-5). The spark occurs simultaneously in the cylinder coming up on the compression stroke and in the cylinder coming up on the exhaust stroke. The cylinder on the exhaust stroke requires very little of the available energy to fire the spark plug.

The remaining energy is used as required by the cylinder on the compression stroke. The same process is repeated when the cylinders reverse roles.

The secondary POWER/WASTE spark display waveform can be used to test several aspects of EI (or DIS) system operation. This test can be used to :

1. analyze individual cylinder dwell (coil charging time),
2. analyze ignition coil and secondary circuit performance (from the firing line),
3. locate incorrect air-fuel ratio in individual cylinders (from the burn line), and
4. locate fouled or damaged spark plugs that cause a cylinder misfire (from the burn line).

Generally on modern high energy ignition (HEI) systems, firing voltages should be around 15 kV to beyond 30 kV. Firing voltages vary based on spark plug gap, engine compression ratio, and air-fuel mixture. On dual spark EI systems, the WASTE spark is usually much lower in peak voltage than the POWER spark. Close to 5 kV can be normal.

• Symptoms

No or hard starts, stalls, misfires, hesitation, poor fuel economy

• Test Procedure

NOTE

A Capacitive type ignition secondary probe must be used to test the ignition secondary circuit. Connecting the CH A or CH B leads directly to an ignition secondary circuit can cause severe damage to the instrument or even personal injury.

Connect the test leads as displayed by the test tool's HELP (Test Procedure) and shown in Figure below.

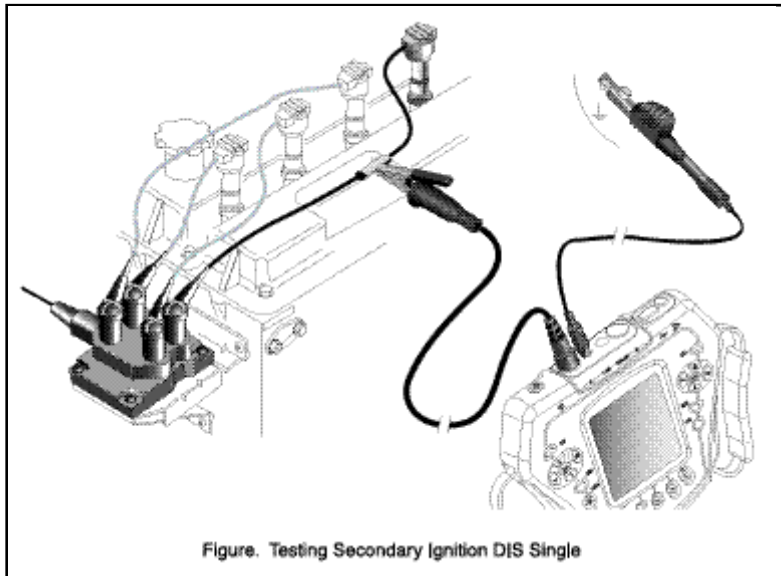
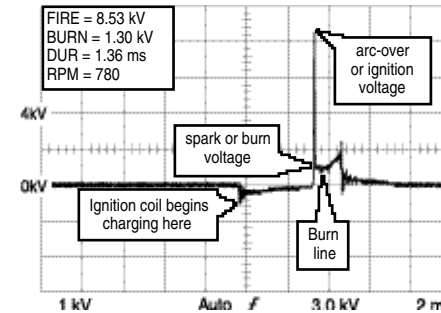

Figure. Testing Secondary Ignition DIS Single

1. Connect the capacitive type ignition secondary probe to the CH A input terminal.
2. Connect the COM input of the test tool to vehicle ground by using a Ground Lead (black) in order to avoid electrical shock before clamping the secondary probe on the coil secondary lead wire.
3. Clip the secondary probe to the coil secondary lead wire before the distributor.
4. With the Key On, Engine Running (KOER), use the throttle to accelerate and decelerate the engine or drive the vehicle as needed to make the driveability problem or misfire occur.
5. If the firing line is negative, press **2** to invert the pattern.
6. Make sure that the amplitude, frequency, shape and pulse width are all consistent from cylinder to cylinder. Look for abnormalities in the section of the waveform that corresponds to specific components.

• Reference Waveform



VEHICLE INFORMATIONS

YEAR : 1994
 MAKE : Ford
 MODEL : Explorer
 ENGINE : 4.0 L
 FUELSYS : Multiport Fuel Injection
 PCM_PIN : Cyl #1 Spark Plug wire
 STATUS : KOER (Key On Running)
 RPM : Idle
 ENG_TMP : Operating Temperature
 VACUUM : 19.5 In. Hg
 MILEAGE : 40045

Look closely to see that the pulse width (dwell) changes when engine load and RPM changes.

• Troubleshooting Tips

Look for the drop in the waveform where the ignition coil begins charging to stay relatively consistent, which indicates consistent dwell and timing accuracy of individual cylinder.

Look for a relatively consistent height on the "arc-over" voltage or firing line. A line that is too high indicates high resistance in the ignition secondary due to an open or bad spark plug wire or a large spark gap. A line that is too short indicates lower (than normal) resistance in the ignition secondary due to fouled, cracked, or arcing spark plug wire, etc.

Look for the spark or burn voltage to remain fairly consistent. This can be an indicator of air-fuel ratio in the cylinder. If the mixture is too lean, the burn voltage may be higher, and if too rich, the voltage may be lower than normal.

Look for the burn line to be fairly clean without a lot of hash, which can indicate an ignition misfire in the cylinder due to over-advanced ignition timing, bad injector, fouled spark plug or other causes. Longer burn lines (over 2 ms) can indicate an abnormally rich mixture and shorter burn lines (under 0.75 ms) can indicate an abnormally lean mixture.

Look for at least 2, preferably more than 3 oscillations after the burn line. This indicates a good ignition coil (a good condenser on point-type ignitions).

6.6 DIESEL TESTS

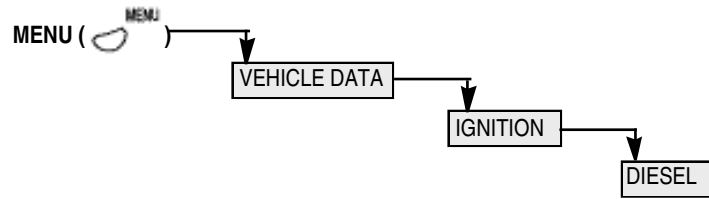

The diesel test functions are selected if "IGNITION: DIESEL" has been set in the VEHICLE DATA menu. To choose a preset DIESEL test menu, select COMPONENT TESTS from the MAIN MENU. From the resulting menu, select DIESEL TESTS menu.

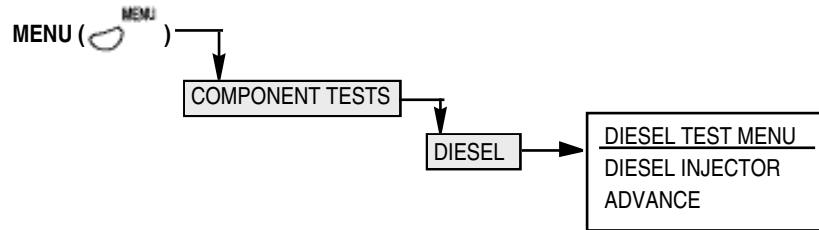

Introduction

During the compression stroke of a diesel engine, the intake air is compressed to about 735 psi (50 Bar). The temperature hereby increases up to 1,292 ° to 1,652 °F (700 ° to 900 °C). This temperature is sufficient to cause automatic ignition of the Diesel fuel which is injected into the cylinder, shortly before the end of the compression stroke and very near to the TDC (Top Dead Center).

Diesel fuel is delivered to the individual cylinders at a pressure of between 5145 psi and 17,640 psi (350 Bar and 1200 Bar). The start of the injection cycle should be timed within 1 ° Crankshaft to achieve the optimum trade-off between engine fuel consumption and combustion noise (knock). A timing device controls the start of the injection and will also compensate for the propagation times in the fuel delivery lines.

Diesel RPM measurements are necessary for adjusting idle speed, checking maximum RPM, and performing smoke tests at fixed RPM values.

Measurement Conditions

Cleaning : The fuel lines (to be measured on) should be cleaned in order to assure a good contact of the fuel line itself to the Piezo Pickup and ground clip. Use sandpaper (preferably a de-greaser) to clean the lines.

Positioning and Probe Connection : The Piezo Adapter should be placed as close as possible to the Diesel injector on a straight part of the fuel line. Clamp the ground clip close to the Piezo Pickup. Make sure that the ground clip does not make contact to the piezo itself or to adjacent fuel lines. Connect the adapter to the instrument. Notice that the ground wire is shorter than the signal wire in order to have the weight of probe and cable loaded on the ground wire, not on the signal wire. The piezo element may not bounce or rattle on the fuel line, or make contact to other fuel lines or any other material close by.

Some tips to keep in mind :

- Always position the piezo pickup on the fuel line at about the same distance from the injector.
- Place the pickup on a straight part of the fuel line. Don't place it on a bent part of the line.
- Always compare results with a reference waveform from a good diesel engine to get acquainted with the signal shape.
- Always compare signals at the same engine speed (RPM).
- Pump timing is critical and should occur within 1 degree of crankshaft rotation.

Diesel Injector

(Diesel RPM Measurement and Diesel Injection Pattern Display)

Use the optional Diesel Probe Set consisting of a Piezo Pickup, which is clamped on the diesel fuel pipe, and a Diesel Adaptor to be connected to the CH A input of the instrument.

• Reference Waveform

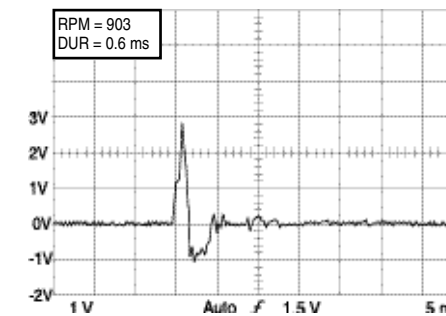

DUR = Duration of the injection pulse

• Analysis of Injection Pattern at Idle Speed

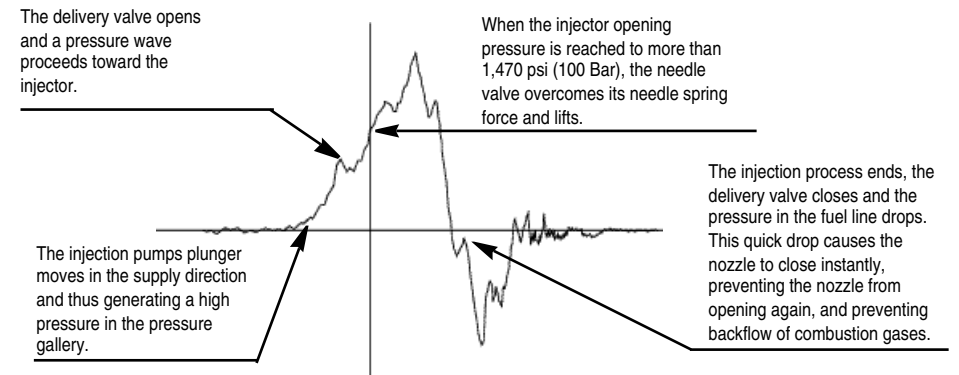

Diesel Advance

Diesel pump testers are used to calibrate pumps exactly to the engine's requirements. The testers monitor the signals from the reference on the engine's flywheel. The start of the delivery is monitored and timing adjustments can be made at different speeds.

We can reveal problems in the timing of the start of fuel delivery compared to the TDC signal of the flywheel sensor through this advance measurement, which cannot be an absolute and accurate diesel pump adjustment test.

• Test Procedure

1. Clamp the piezo pickup and its ground clip on the fuel line of the first cylinder close to the injector and connect the adapter to the CH A.
2. Connect the CH B to the TDC sensor signal output or HI. Don't use the ground lead of the CH B test lead, since the instrument is already grounded through the pickup adapter to the fuel line (double grounding).
3. Use the cursors to read the advance in degrees of the flywheel rotation.

• Reference Waveform

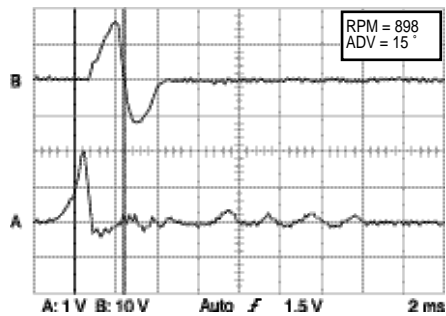

(Advance at idle)

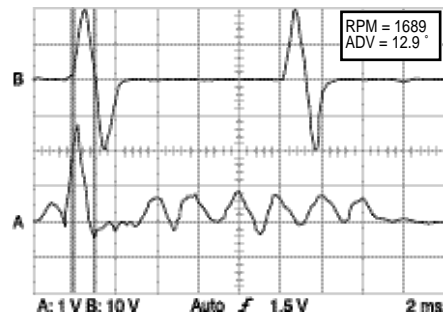

(Advance at 1689 RPM)

7. Maintenance

WARNING

Avoid Electrical Shock or Fire:

- Use only insulated probes, test lead, and connectors specified in this manual when making measurements > 42 V Peak (30 Vrms) above earth ground or on circuits > 4800 VA.
- Use probes and test leads within ratings and inspect them before use. Remove probes and test leads before opening case or battery cover.
- The instrument must be disconnected from all voltage sources before it is opened for any adjustment, replacement, maintenance, or repair.
- Capacitors inside may still be charged even if the instrument has been disconnected from all voltage sources. Discharge all high voltage capacitors before making resistance, continuity, or diodes measurements.

Cleaning

Clean the instrument with a damp cloth and a mild detergent.

Do not use abrasives, solvents, or alcohol.

Do not use any type of paper to clean the display screen. This will cause scratches and diminish the transparency of the screen. Use only a soft cloth with a mild detergent.

Keeping Batteries in Optimal Condition

Always operate the instrument on batteries until a battery symbol  appears in the top right of the display. This indicates that the battery level is too low and the batteries need to be recharged.

CAUTION

Frequent charging of the batteries when they are not completely empty can cause a "memory effect". This means that the capacity of the Ni-MH batteries decreases, which can reduce the operating time of the instrument.

Replacing and Disposing of Batteries

WARNING

To avoid electrical shock, remove the test leads, probes, and battery charger before replacing the batteries.

1. Disconnect the test leads, probes, and battery charger from both the source and the instrument.
2. Remove the battery cover by using a screwdriver.
3. Replace the Ni-MH battery pack with a new Ni-MH battery pack ONLY specified in this manual.
4. Reinstall the battery cover by using a screwdriver.



NOTE

Do not dispose of the replaced battery with other solid waste. Used batteries should be disposed of by a qualified recycler or hazardous materials handler.

Fuses Not Required

Since the instrument uses electronically protected inputs, no fuses are required.

8. Specifications

General Specifications

Operation temperature	: 32 °F to 104 °F (0 °C to 40 °C)
Storage temperature	: -4 °F to 140 °F (-20 °C to 60 °C)
Relative Humidity	: 0 % to 80 % at 32 °F to 95 °F (0 °C to 35 °C), 0 % to 70 % at 32 °F to 131 °F (0 °C to 55 °C)
Temperature Coefficient	: Nominal 0.1 x (Specified Accuracy) / °C (< 18 °C or > 28 °C ; < 64 °F or > 82 °F)
Max Voltage between any input and Ground	: 300 V
Max Input Voltage	: 300 V
GMM Basic DC Accuracy	: 0.3 %
Bandwidth	: DC to 5 MHz (-3dB)
Max Sample rate	: 25 Mega sample/second
Graphing Multimeter Display Counter	: 5,000 count
Display	: 280 x 240 pixels (active area) with backlit (EL)
Reference Waveform	: 51 Waveform
PC interface	: USB version 1.1
Power requirements	: Rechargeable Battery (External AC to DC Power Adaptor)
Battery Life	: 4 Hours with backlit off
Size (H x W x D)	: 9.06 x 4.72 x 1.97" (230 x 120 x 50 mm)
Safety & design	: CAT II 300 V per IEC 1010-1, UL 3111-1 and C22.2 No. 1010-1

Accessory

User Manual	: 1 ea
AC to DC Power Adaptor /Battery Charger	: 1 ea
Shielded Test Leads	: 2 ea (red and yellow)
Ground Leads for Shielded Test Leads	: 2 ea (black)
Alligator Clips	: 3 ea (red, yellow and black)

Back Probe Pins : 3 ea (red, yellow and black)
 2 mm Adaptor : 3 ea (red, yellow and black)
 Secondary Pick-up : 1 ea
 Ground Lead
 for Capacitive Secondary Probe : 1 ea (black)
 Inductive Pick-up : 1 ea
 Soft Carrying Case : 1 ea
 USB Interface
 Cable and Software (Optional) : 1 ea
 Current Probe - CA113 OS/AT (Optional) : 1 ea
 Diesel Probe Set (Optional) : 1 ea
 Temperature Probe (Optional) : 1 ea
 Isolated 12V Charging Adaptor (Optional) : 1 ea
 Isolated 24V Charging Adaptor (Optional) : 1 ea

Scope Specifications

Horizontal

Sample rate : 25 Mega sample/second
 Record length : 1000 Points
 Update rate : Real time, Roll
 Accuracy : $\pm (0.1 \% + 1 \text{ pixel})$
 Sweep rate : 1 μs to 50 sec in a 1, 2, 5 sequence (Scope mode)
 5 s to 24 Hours in a 1, 2, 5 sequence (GMM mode)

Vertical

Band width : DC to 5 MHz ; -3 dB
 Resolution : 8 bit
 Channel : 2 Channel
 Coupling : AC, DC, GND
 Input Impedance : 1 Mohm / 70 pF
 Maximum Input Voltage : 300 V
 Volt/Division : 50 mV to 100 V in a 1, 2, 5 sequence
 Accuracy : $\pm 3 \%$

Trigger

Trigger Source : CH A, CH B, TRIGGER (External trigger)
 Sensitivity (CH A) : < 1.0 div to 5 MHz
 Sensitivity (Trigger) : 0.2 V p-p
 Modes : Single shot, Normal, Auto
 Coupling : AC, DC
 Slope : Rising and falling edge

Others

Glitch Snare : SCOPE Mode (Component test only)
 Acquire Mode : SCOPE Mode
 Setup memory : 8 Waveform & Setup
 Reference waveform : 51 Waveform and Setup
 Cursor : Time and Volt
 Instrument Setup : Language, Contrast, Graticule

Graphing Multimeter (GMM) Specifications

DC Voltage Measurement

Range	Resolution	Accuracy
500 mV	0.1 mV	$\pm (0.3 \% + 5 \text{ d})$
5 V	0.001 V	
50 V	0.01 V	
500 V	0.1 V	
600 V	1 V	

> Input Impedance : 10 M Ω

AC Voltage Measurement

Range	Resolution	Accuracy	
		40 Hz ~ 400 Hz	400 Hz ~ 20 kHz
500 mV	0.1 mV	$\pm (0.5 \% + 5 \text{ d})$	$\pm (2.5 \% + 5 \text{ d})$
5 V	0.001 V		
50 V	0.01 V		
500 V	0.1 V		
600 V	1 V		

> Input Impedance : 10 M Ω

(AC+DC) Voltage Measurement

Range	Resolution	Accuracy	
		40 Hz ~ 400 Hz	400 Hz ~ 10 kHz
DC 500 mV	0.1 mV	± (0.8 % + 5 d)	± (3.0 % + 5 d)
DC 5 V	0.001 V		
DC 50 V	0.01 V		
DC 500 V	0.1 V		
DC 600 V	1 V		

RPM Measurement

Mode	Range	Accuracy
4 cylinder	120 - 20000 RPM	2 RPM
2 cylinder	60 - 10000 RPM	

Frequency Measurement

Function	Range	Resolution	Accuracy
Frequency	10 Hz	0.001 Hz	± (0.1 % + 3 d)
	100 Hz	0.01 Hz	
	1 kHz	0.1 Hz	
	10 kHz	1 Hz	
	100 kHz	10 Hz	
	1 MHz	100 Hz	
	5 MHz	1 kHz	
% Duty	2.0 % ~ 98 %	0.1 %	Pulse Width > 2 µs
Dwell	3.6 ° ~ 356.4 °	0.1 °	1.2 %/krpm + 2 d
Pulse Width	2 µs ~ 450 ms (Pulse Width > 2 µs)		

Ohm Measurement

Range	Resolution	Accuracy
500 Ω	0.1 Ω	± (0.5 % + 5 d)
5 kΩ	0.001 kΩ	
50 kΩ	0.01 kΩ	
500 kΩ	0.1 kΩ	
5 MΩ	0.001 MΩ	± (0.75 % + 5 d)
30 MΩ	0.01 MΩ	± (0.75 % + 10 d)

Continuity Test

Test Voltage	Threshold	Response time
1.2 V	Approx. 70	1 ms

Diode Test

Range	Open Circuit Voltage	Accuracy
2.0 V	3.0 V	± (2.0 % + 5 d)

Temperature Measurement

Range	Resolution	Accuracy
-50 °C to 1300 °C	0.1 °C	± 3 °C
-58 °F to 2372 °F	0.1 °F	± 5.4 °F

DC Ampere Measurement (Current Probe Output)

Range	Resolution	Accuracy
30 mA ~ 20 A	1 mV/10 mA	± (1.5 % + 20 mA)
100 mA ~ 40 A	1 mV/100 mA	± (2.0 % + 20 mA)
40 A ~ 60 A	1 mV/100 mA	± (4.0 % + 0.3 A)

AC Ampere Measurement (Current Probe Output)

Range	Resolution	Accuracy	
		40 Hz ~ 1 kHz	1 kHz ~ 5 kHz
30 mA ~ 10 A	1 mV/10 mA	± (2.0 % + 20 mA)	± (4.0 % + 30 mA)
100 mA ~ 40 A	1 mV/100 mA	± (2.0 % + 20 mA)	± (6.0 % + 30 mA)
40 A ~ 60 A	1 mV/100 mA	± (8.0 % + 0.3 A)	

GLOSSARY

Terminology	Description
ABS	Antilock Brake System
AC	Alternating Current
AC Coupling	A mode of signal transmission that passes the dynamic (AC) signal component to the input (INPUT A or INPUT B), but blocks the DC component. Useful to observe an AC signal that is normally riding on a DC signal, e.g. charging ripple.
Acquisition	The process of gathering measurement data into the instrument's memory.
Acquisition Rate	The number of acquisitions performed per second
Actuator	A mechanism for moving or controlling something indirectly instead of by hand.
Alternating Current	An electrical signal in which current and voltage vary in a repeating pattern over time.
Alternator	An AC generator with diode rectification.
Amplitude	The difference between the highest and the lowest level of a waveform.
Attenuation	The decrease in amplitude of a signal
Auto Range	Activates an automatic adaptation of the instrument to the input signal in amplitude, timebase, and triggering.
Bandwidth	A frequency range.
Baud Rate	Communication parameter that indicates the data transfer rate in bits per second.
Blower	A device designed to supply a current of air at a moderate pressure. The blower case is usually designed as part of a ventilation system.
BNC	Coaxial type input connector used for INPUT A and INPUT B.
Bottom Display	The lower part of the display, where the function key menu is listed.
Bypass	Providing a secondary path to relieve pressure in the primary passage.
Carburetor	A mechanism which automatically mixes fuel with air in the proper proportions to provide a desired power output from a spark ignition internal combustion engine.
Catalytic Converter	An in-line exhaust system device used to reduce the level of engine exhaust emissions.
Closed Loop (Engine)	An operating condition or mode which enables modification of programmed instructions based on a feedback system.
Continuity	Instrument setup to check wiring, circuits, connectors, or switches for breaks (open circuit) or closed circuits.
Contrast	This setting (expressed in a percentage) determines the contrast ratio between display text or graphics and the LCD background. (0 % is all white. 100 % is all black.)
Conventional Ignition System	Ignition system that uses a distributor.

Terminology	Description
Cursor	A vertical or horizontal line (kind of ruler) that you can place on the screen and move horizontally or vertically to measure values at certain points of the waveform.
DC	Direct Current
DC Coupling	A mode of signal transmission that passes both AC and DC signal components to the input (INPUT A or INPUT B) of the instrument.
Default Setup	The setup that exists as long as there are no changes made to the settings.
Diesel Probe	A test probe that has a pickup element to measure the pressure pulse in the diesel fuel pipe. It converts fuel pipe expansion into voltage.
Differential Measurement(Delta)	Measurement of the difference between the waveform sample values at the positions of the two cursors.
Diode	An electrical device that allows current to flow in one direction only.
Direct Current	A signal with constant voltage and current
DIS	Distributorless Ignition System
Division	A specific segment of a waveform, as defined by the grid on the display.
Drive	A device which provides a fixed increase or decrease ratio of relative rotation between its input and output shafts.
Driver	A switched electronic device that controls output state.
Duty Cycle	On-time or off-time to period time ratio expressed in a percentage.
Earth Ground	A conductor that will dissipate large electrical currents into the Earth.
ECM	Electronic Control Module on a vehicle.
ECU	Electronic Control Unit on a vehicle.
EIA-232-D/RS-232C	International standard for serial data communication to which the optical interface of the instrument conforms.
Electromagnetic Interference	Mutual disturbance of signals, mostly caused by signals from adjacent wiring.
EMI	Electromagnetic Interference
Feed Controlled Circuit	A circuit that is energized by applying voltage; it has already been grounded.
Filter	Electrical circuits or device that only passes or blocks certain signal frequencies. An application can be to remove noises from a signal.
Freeze Frame	A block of memory containing the vehicle operating conditions for a specific time.
Frequency	The number of times a waveform repeats per second, measure in Hz. 1 Hz equals one cycle per second.
Fuel Trim	A set of positive and negative values that represent adding or subtracting fuel from engine. A fuel correction term.

Terminology	Description
Function Key Labels	Labels shown on the bottom display that indicate the function of the function keys (1) to (5).
Function Key Menu	The function key labels listed on the bottom display.
Glitch	A momentary spike in a waveform. This can be caused by a momentary disruption in the circuit under test.
Glow plug	A combustion chamber heat generating device to aid starting diesel engines.
Governor	A device designed to automatically limit engine speed.
Ground	An electrical conductor used as a common return for an electric circuit(s) and with a relative zero potential.
Ground Controlled Circuit	A circuit that is energized by applying ground; voltage has been already supplied.
Hall-Effect Sensor (or Hall Sensor)	A semiconductor moving relative to a magnetic field, generating a variable voltage output. Used to determine position in the automotive industry.
Idle	Rotational speed of an engine with vehicle at rest and accelerator pedal not depressed.
Ignition	System used to provide high voltage spark for internal combustion engines.
Inductance	The signal caused by a sudden change of a magnetic field. For example, when you turn off the current through a solenoid, a voltage spike is generated across the solenoid.
Intake Air	Air drawn through a cleaner and distributed to each cylinder for use in combustion.
Intermittent	Irregular, a condition that happens with no apparant or predictable pattern.
Invert	To change to the opposite polarity. Puts the waveform display upside down.
Knock (Engine)	The sharp, metallic sound produced when two pressure fronts collide in the combustion chamber of an engine.
Lamda Sensor	Oxygen (or O ₂) sensor.
LCD	Liquid Crystal Display
Link (Electrical/Electronic)	General term used to indicate the existence of communication facilities between two points.
Manifold	A device designed to collect or distribute fluid, air or the like.
Master Reset	Resets the instrument to the factory "Default Setup". You can do this by turning power on while pressing the F5 function key (5).
Menu	A list of choices for selecting a test, a function, or a setting.
Malfunction Indicator Lamp (MIL)	A required on-board indicator to alert the driver of an emission related malfunction.
Noise	Extraneous electrical signal that can interfere with other electrical signals. The noise can disturb the function of the signal when it exceeds a certain electrical level.

Terminology	Description
NTC	A resistor that has a Negative Temperature Coefficient; resistance decreases as temperature increases.
O ₂ Sensor	Oxygen sensor
Off-time	The part of an electrical signal during which an electrical device is de-energized.
On-time	The part of an electrical signal during which an electrical device is energized.
OBD II	On-Board Diagnostics Second Generation (or Generation Two)
OBD II Systems	Provide comprehensive diagnostics and monitoring of emission controlling systems.
Open Loop	An operating condition or mode based on programmed instructions and not modified by a feedback system.
Peak Value	The highest or lowest value of a waveform.
Peak-and-Hold	A method for regulating the current flow through electronic fuel injectors. Supplies higher current necessary to energize the injector, then drops to a lower level just enough to keep the injector energized.
Pixel	The smallest graphic detail possible for the liquid crystal display (LCD)
Powertrain	The elements of a vehicle by which motive power is generated and transmitted to the driven axles.
Pressure (Absolute)	The Pressure referenced to a perfect vacuum.
Pressure (Differential)	The pressure difference between two regions, such as between the intake manifold and the atmospheric pressures.
PTC	A resistor that has a Positive Temperature Coefficient; resistance increases as temperature increases.
Pulse	A voltage signal that increases or decreases from a constant value, then returns to the original value.
Pulse Modulated	A circuit that maintains average voltage levels by pulsing the voltage on and off.
Rail	A manifold for fuel injection fuel.
Range	Specified limits in which measurements are done.
Reference Voltage	An unaltered voltage applied to a circuit. Battery plus (B+) and ground (GND) are examples of reference voltages.
Regulator (Voltage)	A device that automatically controls the functional output of another device by adjusting the voltage to meet a specified value.
Relay	A generally electromechanical device in which connections in one circuit are opened or closed by changes in another circuit.
Root Mean Square (RMS)	Conversion of AC voltages to the effective DC value.
RPM	Engine speed expressed in Rotations Per Minute of the crankshaft.

Terminology	Description
Scan Tool	A device that interfaces with and communicates information on a data link.
Sample	A reading taken from an electrical signal. A waveform is created from a successive number of samples.
Sampling Rate	The number of readings taken from an electrical signal every second.
Saturated Driver	Fuel injection circuit that maintains the same voltage level throughout its on-time.
Secondary Pickup	An accessory that can be clamped on the high voltage coil wire used to measure secondary ignition patterns.
Shielded Test Lead	A test lead that is surrounded by a conductive screen to protect the measurement signal against environmental influences, such as electrical noise or radiation.
Shift Solenoid	A device that controls shifting in an automatic transmission.
Single Shot	A signal measured by an oscilloscope that only occurs once (also called a transient event).
Spark Advance	The relationship between the ignition timing and top dead center (DTC).
Spike	A (high) voltage pulse during a short period of time (sharp pulse).
Throttle	A valve for regulating the supply of a fluid, usually air or a fuel/air mixture, to an engine.
Time Base	The time defined per horizontal division on the display.
Trace	The displayed waveform that shows the variations of the input signal as a function of time.
Trigger	Determines the beginning point of a waveform.
Trigger Level	The voltage level that a waveform must reach to start display.
Trigger Slope	The voltage direction that a waveform must have to start display. A positive Slope requires the voltage to be increasing as it crosses the Trigger Level, a negative Slope requires the voltage to be decreasing.
Trigger Source	The instrument input that supplies the signal to provide the trigger.
Transducer	A device that receives energy from one system and retransmits (transfers) it, often in a different form, to another system. For example, the cruise control transducer converts a vehicle speed signal to a modulated vacuum output to control a servo.
Turbocharger	A centrifugal device driven by exhaust gases that pressurize the intake air, thereby increasing the density of charge air and the consequent power output from a given engine displacement.
USB	Universal Serial Bus (visit www.usb.org for details.)
User's Last Display	The last display having been displayed just before the instrument was turned off.
Vertical Scale	The scale used for vertical display (vertical sensitivity) expressed in certain units per division.

Terminology	Description
Voltage Drop	Voltage lose across a wire, connector, or any other conductor. Voltage drop equals resistance in ohms times current in amperes (ohm's Law).
Wastegate	A valve used to limit charge air pressure by allowing exhaust gases to bypass the turbocharger.
Waveform	The pattern defined by an electrical signal.
WOT	Wide Open Throttle.

Menu Overview

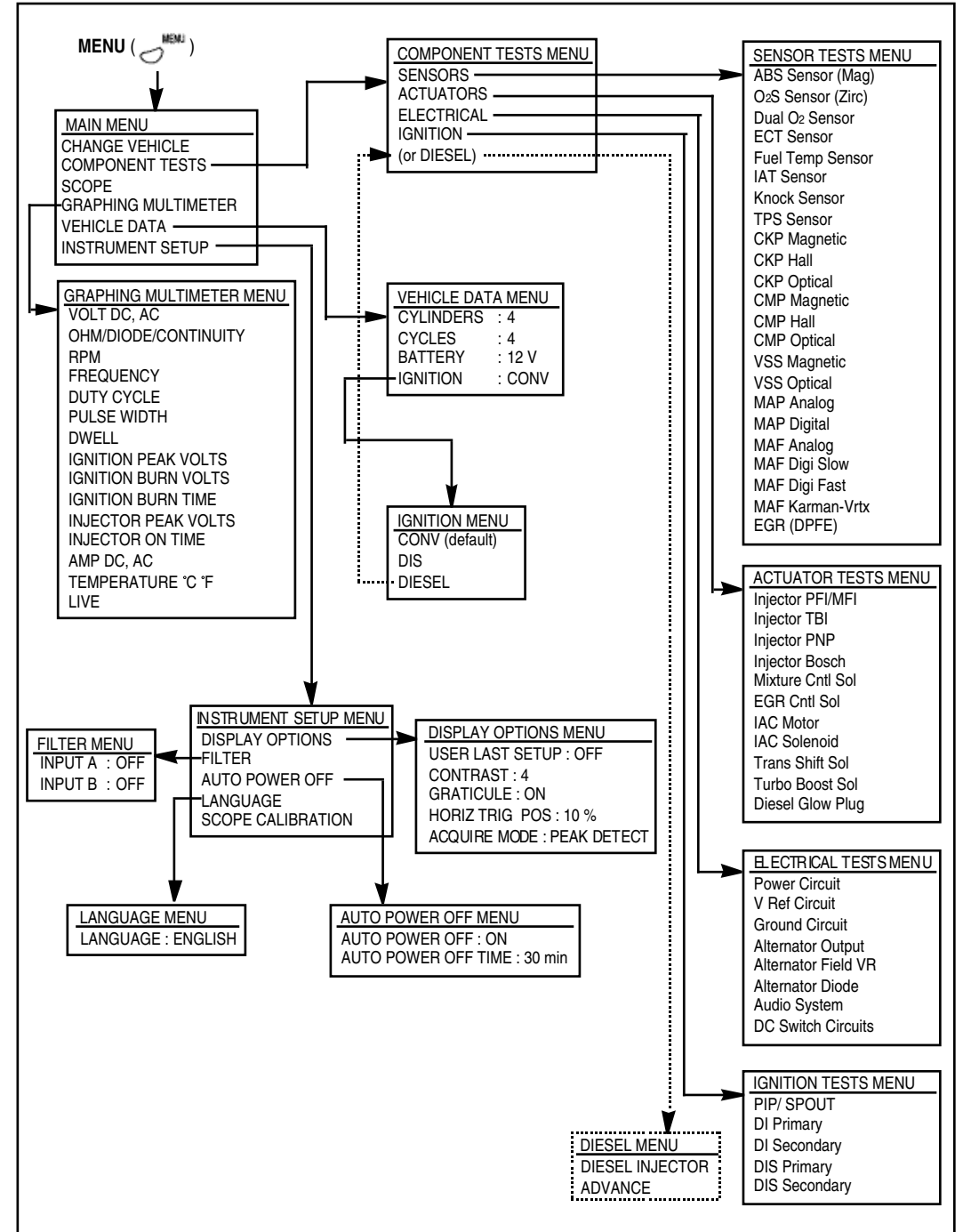

Free Manuals Download Website

<http://myh66.com>

<http://usermanuals.us>

<http://www.somanuals.com>

<http://www.4manuals.cc>

<http://www.manual-lib.com>

<http://www.404manual.com>

<http://www.luxmanual.com>

<http://aubethermostatmanual.com>

Golf course search by state

<http://golfingnear.com>

Email search by domain

<http://emailbydomain.com>

Auto manuals search

<http://auto.somanuals.com>

TV manuals search

<http://tv.somanuals.com>