

# 2Gb SANbloc Series Installation Guide

P/N: MAN-FC2002-001

Revision: 1.4

September 2003





# Disclaimer and Warranty

## Disclaimer

ADAPTEC reserves the right to make changes to this manual and the equipment described herein without notice. ADAPTEC has made all reasonable effort to insure that the information in this manual is accurate and complete. However, ADAPTEC shall not be liable for any technical or editorial errors or omissions made herein or for incidental, special, or consequential damage of whatsoever nature resulting from the furnishing of this manual, or operation and performance of equipment in connection with this manual.

**All Trademarks acknowledged.**

## Warranty

**Basic Warranty** - In the absence of any optional warranty or continuing provisions by formal agreement, ADAPTEC warrants its products in accordance with the schedules listed below. Purchaser hereafter mentioned refers at all times to the customer who purchased ADAPTEC product(s).

**2Gb SANbloc Warranty** - Adaptec warrants 2Gb SANbloc products of its manufacture to be free from defect in material and workmanship for a period of three (3) years from the date of shipment. During this period, if the customer experiences difficulties with a ADAPTEC 2Gb SANbloc system and is unable to resolve the problem via phone with ADAPTEC Technical Support a Return Material Authorization (RMA) number will be issued for the faulty component. Following receipt of an RMA, the Purchaser is responsible for returning the product to

ADAPTEC, freight prepaid. ADAPTEC, upon verification of warranty, will repair or replace at its option the 2Gb SANbloc component in question, and will then return the product to the Purchaser, freight prepaid.

**Cable Warranty** - All ADAPTEC provided cables are warranted for ninety (90) days from the time of shipment. Questionable cables should be returned to ADAPTEC, freight prepaid where they will be repaired or replaced by ADAPTEC at its option and returned to the Purchaser, freight prepaid.

**General Terms** - The above warranties shall not apply to expendable components such as fuses, bulbs, and the like, nor to connectors, adapters, and other items not a part of the basic product. ADAPTEC shall have no obligation to make repairs or to cause replacement required through normal wear and tear or necessitated in whole or in part by catastrophe, fault or negligence of the user, improper or unauthorized use of the product, or use of the product in such a manner for which it was not designed, or by causes external to the product, such as, but not limited to, power failure or air conditioning. The ADAPTEC sole obligation hereunder shall be to repair or replace any defective product, and unless stated, pay return transportation costs for such replacement. Purchaser shall provide labor for removal of the defective product, shipping charges for return to ADAPTEC and installation of its replacement. On-site services are not a part of this warranty. Above warranties are subject to change without notice.

**Returned Material** - Warranty claims must be received by ADAPTEC within the applicable warranty period. A replaced product, or part thereof, shall become the property of EUROLOGIC and shall be returned to ADAPTEC at Purchaser's expense. All returned material must be accompanied by a Return Materials Authorization (RMA) number assigned by ADAPTEC. For RMA numbers contact ADAPTEC Customer Support Monday-Friday 3am-5pm PST at:

**Telephone:** 321-207-2000 (RAID, FC, External Storage)  
408-934-7274 (Hardware)

**email:** [ask.adaptec.com](mailto:ask.adaptec.com)

**WWW:** <http://www.adaptec.com/support>

THE EXPRESSED WARRANTIES SET FORTH IN THIS AGREEMENT ARE IN LIEU OF ALL OTHER WARRANTIES, EXPRESSED OR IMPLIED, INCLUDING WITHOUT LIMITATION, ANY WARRANTIES OF MERCHANTABILITY OR FITNESS FOR A PARTICULAR PURPOSE, AND ALL SUCH OTHER WARRANTIES ARE HEREBY DISCLAIMED AND EXCLUDED BY EUROLOGIC. THESE STANDARD EXPRESS WARRANTIES ARE IN LIEU OF ALL OBLIGATIONS OR LIABILITIES ON THE PART OF EUROLOGIC FOR DAMAGES, INCLUDING BUT NOT LIMITED TO SPECIAL, INDIRECT OR CONSEQUENTIAL DAMAGES ARISING OUT OF OR IN CONNECTION WITH THE USE OR PERFORMANCE OF THE PRODUCT.

# Table of Contents

## **Preface ..... 13**

Audience .....	13
Conventions Used In This User Guide .....	13
Getting Support.....	14
FCC Statement.....	14
VCCI.....	15
European Community Statement.....	15
Safety Statements.....	16

## **Chapter 1: Introduction ..... 19**

Introduction.....	19
Features .....	19
Disk Drive Carrier .....	20
Power Supplies .....	20
Cooling System .....	21
I/O Option Modules.....	22

## **Chapter 2: Installation and Setup ..... 27**

Safety Statements.....	28
Unpacking and Initial Setup .....	30
Installing the System in an Equipment Rack.....	30
Ambient Temperature.....	30
Air Flow.....	31

Mechanical Loading .....	31
Electrical Considerations .....	32
Circuit Overloading .....	32
Setting Fibre Channel Loop Speed (2Gb or 1Gb) .....	32
2Gb Operation .....	32
1Gb Operation .....	33
Split Fibre Channel Loop Operation (Quad Loop) .....	34
Setting Up Split Loop Operation .....	34
Removing Split Loop Operation .....	34
Configuration Rules .....	35
Supported Host Bus Adapters .....	35
Supported Cables .....	36
Copper Cables .....	36
Optical Cables .....	36

## **Chapter 3: JBOD Configurations ..... 37**

Setting the Enclosure ID .....	37
Configurations .....	40
JBOD Configurations .....	41
Dual FC Loop Configuration.....	41
Quad Loop Configuration.....	44
Connecting a Power Source .....	45
Connecting an AC Power Source .....	45
Disk Drive Spin Up Sequence .....	46

## **Chapter 4: RAID Configurations ..... 47**

2Gb SANbloc Series RAID Controller Introduction.....	47
RAID Controller Circuit Boards.....	49



Controller Circuit Board.....	49
I/O Circuit Board.....	50
Ethernet Circuit Board.....	50
RAID Controller Location.....	51
RAID Controller Status LEDs.....	52
RAID Controller Configurations .....	53
Setting the Enclosure ID .....	53
Configurations .....	55
Single RAID Controller Configuration .....	56
Dual RAID Controller Configuration.....	59
Connecting a Power Source .....	62
Connecting an AC Power Source .....	62
Disk Drive Spin Up Sequence .....	63

## **Chapter 5: System Monitoring ..... 65**

Overview.....	65
LS Module .....	65
LS Module Features .....	66
2Gb SANbloc Enclosure LEDs.....	66
Disk Drive LEDs .....	69
Power Supply LEDs.....	71
Advanced Cooling Module (ACM) LEDs.....	72
RAID Controller LEDs.....	73

## **Chapter 6: Installing and Removing Components ..... 75**

Location of the Components.....	76
Installing and Removing a Disk Drive Carrier .....	77
Installing a Disk Drive Carrier .....	77

- Removing a Disk Drive Carrier..... 77
- Installing and Removing an LS Module ..... 79
  - Installing an LS Module ..... 79
  - Removing an LS Module..... 79
- Installing and Removing a Power Supply..... 81
  - Installing a Power Supply..... 81
  - Removing a Power Supply ..... 81
- Installing and Removing an Advanced Cooling Module..... 82
  - Installing an Advanced Cooling Module..... 82
  - Removing an Advanced Cooling Module ..... 82
- Installing and Removing an I/O Module/RAID Controller ..... 83
  - Installing an I/O Module/RAID Controller ..... 83
  - Removing an I/O Module/RAID Controller..... 83

**Appendix A: Safety Statement Translations ..... 85**

**Appendix B: Technical Specifications ..... 95**

- Host Interface..... 95
- Disk Drive Interface..... 95
- System..... 95
- Redundant, Hot Swappable Components ..... 95
- Physical Dimensions ..... 96
  - Deskside Enclosure ..... 96
  - Rack Enclosure..... 96
- Warranty ..... 96
- Monitoring ..... 96
- Failure Notification..... 96
- Disk Drives ..... 97
- Power Supply ..... 97



	11
AC Power Supply Input.....	97
Temperature .....	97
Humidity .....	97
Altitude .....	98
Operational Shock.....	98
Operational Vibration .....	98
Regulatory Agency Compliance.....	99
Product Safety Standards.....	99
Product Safety Third Party Certifications .....	99
CE Mark .....	99
Electromagnetic Radiation .....	99

## **Appendix C: Configuration Loop Diagrams ..... 101**

## **Appendix D: Upgrading a 2Gb SANbloc JBOD Array to a RAID Array ..... 105**

Equipment and parts necessary for upgrade.....	105
Upgrading from JBOD to RAID .....	105
Installing the Battery Backup Unit.....	107



# Preface

This Installation Guide describes the installation and operation of the 2Gb SANbloc Series. The following products are covered: FC2101CDT2-AC, FC2101CDR2-AC, FC2101ODT2-AC, FC2101ODR2-AC, FC2101MDT2-AC, FC2101MDR2-AC.

## Audience

This Installation Guide is intended for use by the person installing and operating the 2Gb SANbloc Series. This Installation Guide describes the operation of the 2Gb SANbloc Series only. For details relating to the host system, refer to the documentation supplied with the host system.

## Conventions Used In This User Guide

The following conventions are used throughout this Installation Guide.

---

**Note:** A *NOTE* gives general information, such as helpful tips and references to related information.

---

---

**CAUTION:** A *CAUTION* means take care. There is a risk of causing damage to the equipment or losing data.

---

---

**WARNING:** A *WARNING* means beware. There is a risk of electric shock or personal injury. Before working on the enclosure be aware of the hazards that exist.

---

## Getting Support

If you are having difficulties installing or operating your 2Gb SANbloc Series you can contact our World Wide Support Centre for assistance Monday-Friday 3am to 5pm Pacific:

**Telephone:** 321-207-2000 (RAID, FC, External Storage)  
408-934-7274 (Hardware)

**email:** [ask.adaptec.com](mailto:ask.adaptec.com)

**WWW** <http://www.adaptec.com/support>

## FCC Statement

---

*WARNING: Changes or modifications to this unit not expressly approved by the party responsible for compliance could void the user's authority to operate the equipment.*

---

This equipment has been tested and found to comply with the limits for a class A digital device, pursuant to Part 15 of the FCC Rules.

These limits are designed to provide reasonable protection against harmful interference when operated in a commercial environment.

This equipment generates, uses and can radiate radio frequency energy and, if not installed and used in accordance with the instruction manual, may cause harmful interference to radio communications.

Operation of this equipment in a residential area is likely to cause harmful interference, in which case, the user will be required to correct the interference at his own expense.

Any changes or modifications to this equipment not expressly approved by Eurologic Systems Ltd. could void the user's authority to operate this equipment.

## VCCI

この装置は、情報処理装置等電波障害自主規制協議会（VCCI）の基準に基づくクラスA情報技術装置です。この装置を家庭環境で使用すると電波妨害を引き起こすことがあります。この場合には使用者が適切な対策を講ずるよう要求されることがあります。

### English Translation:

This is a Class A product based on the standard of the Voluntary Control Council for Interference by Information Technology Equipment. If this equipment is used in a domestic environment, radio disturbance may arise. When such trouble occurs, the user may be required to take corrective actions.

## European Community Statement

This equipment complies with the following European directives:

EMC Directive 89/336/EEC and amending Directives 92/31/EEC and 93/68/EEC Low Voltage Directive 73/23/EEC.

## Safety Statements

The following safety statements **must** be read before **installation**. For language translations of these statements refer to Appendix B.

---

**CAUTION:** *This equipment is intended only for installation in a restricted access location.*

---

---

**CAUTION:** *Allow disk drives and power supplies to reach room ambient temperature before powering on the system.*

---

---

**CAUTION:** *It is recommended that if interconnecting equipment resides within more than one equipment rack cabinet, these cabinets should be at the same ground potential.*

---

---

**CAUTION:** *Before attempting to install or remove any of the components, ensure that anti-static precautions have been taken. The minimum requirement is an anti-static wrist strap and grounding wire.*

---

---

**CAUTION:** *When installing or removing a rackmount shelf, remove all power supplies and disk drives. It is recommended that you work with at least one other person. This is necessary to prevent personal injury and damage to the shelf.*

---



---

***CAUTION: The tower skin set is not a field replaceable unit and therefore must not be removed from the Storage Array.***

---

---

***CAUTION: After removing the LS Module the resulting hole must be blocked, by installing a blanking plate or by installing a replacement LS Module. Failure to do so can disrupt air flow and seriously reduce cooling.***

---

---

***WARNING: A possible shock hazard may exist in the area of the fan connection.***

---

---

***WARNING: Disconnect the power cord before removing the power supply from the storage enclosure.***

---

---

***WARNING: The module handles are to facilitate the easy insertion and removal of the modules, they should not be used to lift and/or carry the enclosure.***

---



# Chapter 1: Introduction

This Chapter introduces the 2Gb SANbloc Series. The main features of the Series are described along with a list of the models that are available.

## Introduction

The 2Gb SANbloc Series provides a highly flexible, high performance storage solution that evolves to meet your changing needs. Based on a modular, “building block” enclosure design, the 2Gb SANbloc Series offers exceptional scalability. Each enclosure supports up to 14 disk drives, or 1TB of capacity in a dense 3U form factor. As your storage needs grow, simply add 2Gb SANbloc enclosures dynamically - up to a total of 8 enclosures. The 2Gb SANbloc Series can be scaled in multiple dimensions, enabling flexible configuration of capacity, performance and functionality, to match and grow with virtually any application or IT environment. The enclosure is available with your choice of copper, or optical I/O modules, and is downward compatible to 1GB, protecting your investment. A high performance, industry first Quad Loop (4 FCAL loops on one enclosure) capability provides over 700 MB/s from a single enclosure. 2Gb Fibre Channel connectivity provides simplified cabling and extremely high bandwidth, for outstanding performance in demanding applications.

## Features

- Redundant data paths with dual-ported fibre drives and dual (200MB/s) fibre channel loops for a total of 400 MB/s.
- Quad Loop feature, provides over 700MB/s from a single enclosure.



- Downward compatible to 1GB.
- Dense enclosure with 14 drives in a 3U form factor.
- Scalable to 8.2TB (112 drives), support for 15K rpm drives.
- Enhanced enclosure services (SES) monitoring and reporting.
- No single point of failure, with redundant, hot-swappable components.
- Intuitive, comprehensive management with Spheras Storage Manager.
- User installable, configurable and on-line maintainable.
- Industry-standard 19-inch rackmount or deskside configuration.
- Dual AC power supplies.

### Disk Drive Carrier

The disk drive carrier supports one inch, SCA-2 direct attach disk drives. The 2Gb SANbloc Series can hold up to fourteen disk drive carriers. The disk drives can be hot swapped and the disk drive carriers provide for blind mating.

### Power Supplies

The 2Gb SANbloc Series uses two AC power supplies for normal operation, providing redundancy of the power system. The power supplies can be hot swapped. The AC power supplies provide 673 Watts continuous output power and 853 Watts peak output power. The power supplies provide active current sharing, power factor correction, over current and over voltage protection is also provided. The power supplies have individual power inputs.

---

***CAUTION: Power supply cords shall have conductors with a cross-sectional area not less than 4mm<sup>2</sup>. This cross-sectional area corresponds to a minimum 10AWG wire.***

---

## Cooling System

Cooling is provided by the two Advanced Cooling Modules (ACMs) located at the rear of the enclosure. Each of the ACM units contain two variable speed fans. The enclosure requires four fans for normal operation, but will operate correctly with one fan failed (redundancy is lost if one fan is failed in either ACM), however, it is recommended that the failed fan be replaced as soon as possible. The ACM units can be hot swapped. The LS Module monitors and controls the speed of each fan. The speed is set depending on the ambient temperature and failed status. The fans are set to full speed if one fan is failed. The following table shows how the fan speed relates to temperature change.

**Table 1-1 Fan Speed vs. Temperature Change**

ACM Speed	Ambient Temp (°C)
Speed 1	0 to 26
Speed 2	26 to 28
Speed 3	28 to 30
Full Speed	30 +

---

**Note:** All fans in an enclosure are set to the same speed.

---

## I/O Option Modules

The two rear I/O option slots (A and B) can contain a range of different option modules. The LS module will detect the type of option module installed.

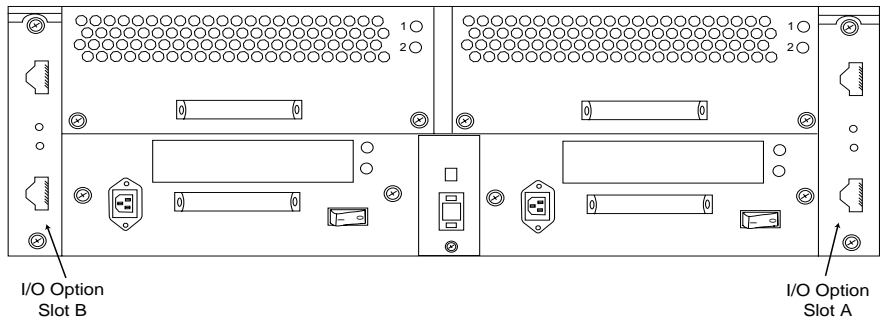

The available option modules are:

### I/O Expansion Module - Copper/Copper

This 2Gb FC expansion module has two HSSDC connectors. The top connector is the primary FC loop input port and the bottom connector is available for FC loop expansion / input. A fibre channel loop back terminator is not required.

### I/O Expansion Module - Optical/Copper

This 2Gb FC expansion module has the SFF LC optical connector as the FC Loop Input port. The FC loop expansion is carried out by the HSSDC connector. A loop back terminator is not required.

## I/O Expansion Module- Optical/Optical

This 2Gb FC expansion module has two SFF LC optical connectors. The top connector is the FC Loop Input port and the bottom connector is for FC Loop Expansion. A loop back terminator is not required.

## 2Gb SANbloc RAID Controller

The 2Gb SANbloc RAID Controller is a high performance controller, providing two host fibre channel and two device fibre channel interfaces. It is an intelligent, caching controller that supports RAID levels 0, 1, 3, 5, 0+1, and JBOD. The controller enables multiple hosts to access an array of disk drives, which can be configured as one or more virtual storage devices (logical units).

Figure 1-2: 2Gb SANbloc Series Tower Model

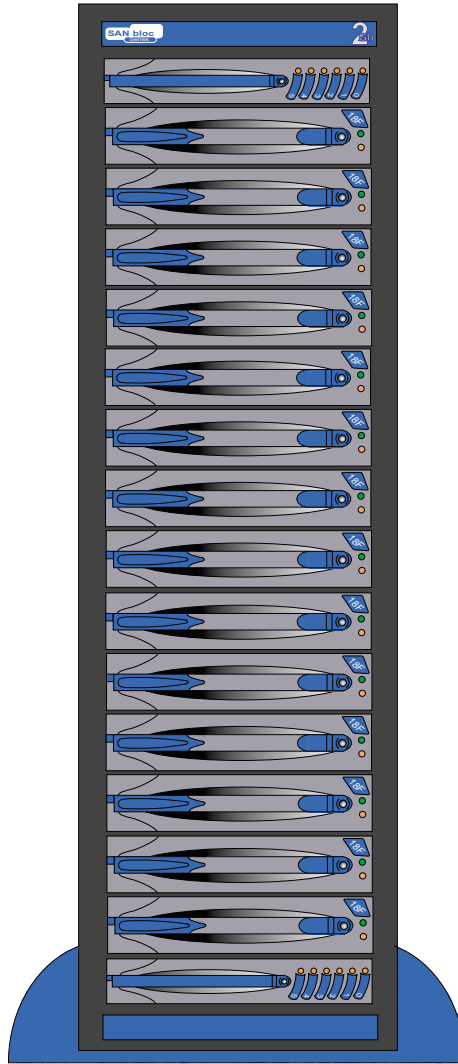
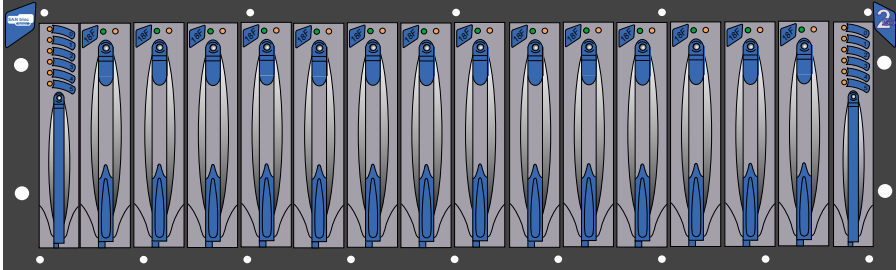



Figure 1-3: 2Gb SANbloc Series Rack Model





## Chapter 2: Installation and Setup

This Chapter describes the installation and set up of the 2Gb SANbloc Series. Important safety instructions are discussed along with the electrical, mechanical and environmental precautions that need to be taken. Items that need to be set prior to operating the 2Gb SANbloc enclosure are also described here.

---

**Note:** *Please read this Chapter carefully before attempting to install or operate the 2Gb SANbloc Series enclosure.*

---

## Safety Statements

# CAUTION

The following safety statements must be read before you install or operate the 2Gb SANbloc Series. For language translations of these statements refer to Appendix B.

---

**CAUTION:** *This equipment is intended only for installation in a restricted access location.*

---

---

**CAUTION:** *Before attempting to install or remove any of the components, ensure that anti-static precautions are taken. The minimum requirement is, a properly grounded anti-static wrist strap and ground wire.*

---

---

**CAUTION:** *If any of the components are removed the resulting hole must be blocked, by installing a component blank or replacing the component. Failure to do so can seriously restrict air flow and cooling.*

---

---

**CAUTION:** *This device should be connected to a power source which carries a fuse or circuit breaker that is greater than the rating of the shelf, but also complies with national wiring standards.*

---

---

**CAUTION:** *Allow disk drives and power supplies to reach room ambient temperature before powering on the shelf.*

---

---

***CAUTION:*** *It is recommended that, if interconnecting equipment resides within more than one equipment rack cabinets, these equipment racks should be at the same ground potential.*

---

---

***WARNING:*** *A possible shock hazard may exist in the area of the fan connection.*

---

---

***WARNING:*** *Disconnect the power cords before removing a power supply from the enclosure.*

---

## Unpacking and Initial Setup

When you receive your system, visually inspect the exterior of the packaging for any signs of damage. If any damage is found the carrier and Adaptec should be informed immediately, and they will advise you of the appropriate action. The cartons are sealed using packaging tape which should be cut open in the normal manner. Exercise caution when lifting out the components. At this point the contents should be verified against the packing list and Adaptec should again be notified if any discrepancies exist. Anti-static precautions must be observed before removing any of the components.

## Installing the System in an Equipment Rack

Before installing the 2Gb SANbloc Series in an equipment rack, it is essential that the following guidelines are complied with, to ensure the safe and efficient operation of the system. The 2Gb SANbloc Series can be installed in open or closed equipment racks, with a front width of 19", by observing the environmental, electrical, and mechanical precautions described below.

### Ambient Temperature

Installation of the rack system in a standard 19" cabinet may lead to a differential between the room ambient temperature and the internal ambient temperature of the rack environment. The operating temperature of the 2Gb SANbloc Series is between 5°C to 40°C. However, it is not recommended that the system be continuously run at these extreme temperatures. Consideration should therefore be given to ensure that the room ambient temperature is compatible with these specifications.

### Air Flow

To ensure that the internal heat build up is properly dissipated into the room environment, air flow should in no way be restricted. It is essential that no air vents are blocked, and that the system is a minimum of one meter from a solid surface such as a wall or partition. Air flow through the 2Gb SANbloc Series is from front to rear.

### Mechanical Loading

Consideration should be given to the loading of any equipment racks. To maintain a low centre of gravity (thus reducing the likelihood of instability) racks should be loaded (where possible) from the bottom of the equipment rack upwards. This is recommended to ensure personal safety.

---

***CAUTION: When installing or removing a rack mount enclosure, remove all disk drives. It is recommended that you work with at least one other person when installing an enclosure. This is necessary to prevent personal injury and damage to the enclosure.***

---

## Electrical Considerations

When installing the 2Gb SANbloc Series the following electrical considerations must be applied.

### Circuit Overloading

Care should be taken to ensure that the current does not exceed the rating of the power source circuitry. This includes cabling, power distribution units, filters and any other devices through which the main current flows. The electrical power rating of the enclosure is 100 - 240 VAC, 10 - 5 Amps (50/60 Hz), and this must be added to the power demands of any other electrical devices installed in the equipment rack to arrive at a total power consumption figure. In addition, surge currents must be catered for. Disk drives may consume twice the amount of current at start-up time as they do during steady state operation.

## Setting Fibre Channel Loop Speed (2Gb or 1Gb)

The 2Gb SANbloc Series can be operated with fibre channel loop speeds of either 2Gb or 1Gb. The loop speed is set through the use of a jumper (JP2) located on the LS Module.

---

**Note:** *If the enclosure has dual LS modules the following procedures must be applied to both LS modules.*

---

### 2Gb Operation

To set the fibre channel loop speed to 2Gb operation:

- 1 Remove the LS Module from the front of the enclosure.
- 2 On the LS Module locate the jumper position JP2 (Figure 2-1).
- 3 Install a jumper at JP2.
- 4 Replace the LS module.



## 1Gb Operation

To set the fibre channel loop speed to 1Gb operation:

- 1 Remove the LS module from the front of the enclosure.
- 2 On the LS Module locate the jumper position JP2 (Figure 2-1).
- 3 For 1Gb operation there should be no jumper installed at JP2. If one is installed, remove it.
- 4 Replace the LS module.

**Figure 2-1 Location of Jumpers on LS Module**

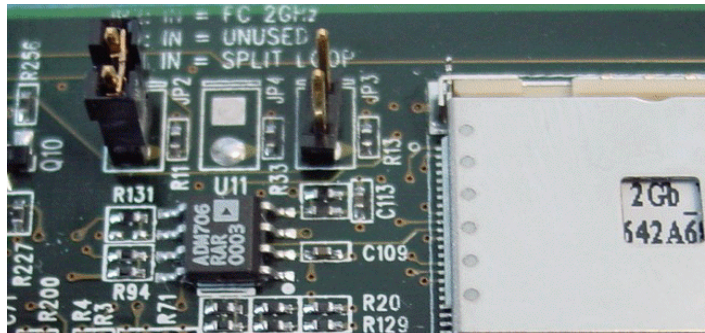

## Split Fibre Channel Loop Operation (Quad Loop)

The 2Gb SANbloc Series LS module allows for split FC Loop operation, with two dual fibre channel loops of seven disk drives each. In this split loop mode the primary port (I/O Slot A) will form a loop using the first seven drives, 1 to 7 (from right hand side of rackmount systems). The expansion port (I/O Slot B) will form a second loop using the remaining 7 drives, 8 to 14 (from right hand side of rackmount systems).

---

**Note:** *If the enclosure has dual LS modules the following procedures must be applied to both LS modules.*

---

---

**CAUTION:** *Enclosures operating in split loop mode can not be daisy chained to other enclosures.*

---

### Setting Up Split Loop Operation

To operate the 2Gb SANbloc Series enclosure in split fibre channel loop mode, follow this procedure:

- 1 Remove the LS module from the front of the enclosure.
- 2 On the LS Module locate the jumper position JP3 (Figure 2-1).
- 3 To operate in split loop mode, install a jumper at JP3.
- 4 Replace the LS module.

### Removing Split Loop Operation

To remove split fibre channel loop operation from the 2Gb SANbloc Series enclosure, follow this procedure:

- 1 Remove the LS module from the enclosure and locate jumper JP3 (Figure 2-1).
- 2 To remove split loop operation, remove jumper JP3.
- 3 Replace the LS module.

## Configuration Rules

These rules must be applied when implementing the 2Gb SANbloc Series configurations:

- When daisy chaining, both 2Gb enclosures must be configured identically.
- 1Gb and 2Gb systems cannot be daisy chained together.
- Two LS modules and two I/O modules are required for dual drive loops.
- Cannot mix optical and copper I/O modules in the same enclosure (both I/O Modules must be the same).
- Cannot mix 1Gb and 2Gb LS and I/O modules, and 1Gb and 2Gb cables.
- 2Gb JBOD enclosures require 2Gb cables.
- 2Gb JBOD enclosures require 2Gb disk drives.
- Disk drive blanks must be ordered for any empty drive slots.

## Supported Host Bus Adapters

**Only** the following **QLogic** Host Bus Adapters should be used with the 2Gb SANbloc Series enclosures:

- **QLA-2300** (Rev. C or higher)
- **QLA-2310** (Rev. C or higher)

## Supported Cables

***WARNING: Only the following APPROVED cables must be used with the 2Gb SANbloc Series enclosures.***

This section lists the cables that must be used with the 2Gb SANbloc Series enclosure. Failure to adhere to these guidelines may cause the enclosure to operate incorrectly.

### Copper Cables

Only the following **AMPHENOL** copper Fibre Channel cables **must** be used with the 2Gb SANbloc Series enclosure (copper applications).

#### Amphenol Cable Model Numbers:

Model No.	Description
515840001	.3m 2Gb Fibre Channel, copper cable, non-equalized, HSSDC-HSSDC
515840003	1m 2Gb Fibre Channel, copper cable, non-equalized, HSSDC-HSSDC
515840007	3m 2Gb Fibre Channel, copper cable, non-equalized, HSSDC-HSSDC
515840013	6m 2Gb Fibre Channel, copper cable, non-equalized, HSSDC-HSSDC

### Optical Cables

The optical Fibre Channel cables used with the 2Gb SANbloc Series enclosure must conform to the following:

- Minimum Length: 2 Meters
- Maximum Length: 150 Meters

## Chapter 3: JBOD Configurations

This Chapter describes the procedure for connecting your 2Gb SANbloc Series JBOD system to a host computer(s). Detailed information on how to configure and daisy chain enclosures is also provided along with instructions on how to set the enclosure ID.

### Setting the Enclosure ID

Each of the fourteen disk drive slots of the 2Gb SANbloc Series has a unique identifier assigned to it. This identifier is assigned using a combination of the slot number and the enclosure ID.

The enclosure ID is set using the enclosure ID switch, located on the rear of the 2Gb SANbloc (see Figure 3-1).

---

**Note:** *The enclosure ID must be set prior to powering on the enclosure.*

---

---

**Note:** *Each enclosure must have a separate ID when daisy chained together.*

---

---

**Note:** *2Gb Amphenol cables must be used if 2Gb operation is required.*

---

---

**Note:** *Only QLogic 2300 and 2310 adapters should be used.*

---

**Figure 3-1 Location of Enclosure ID Switch**

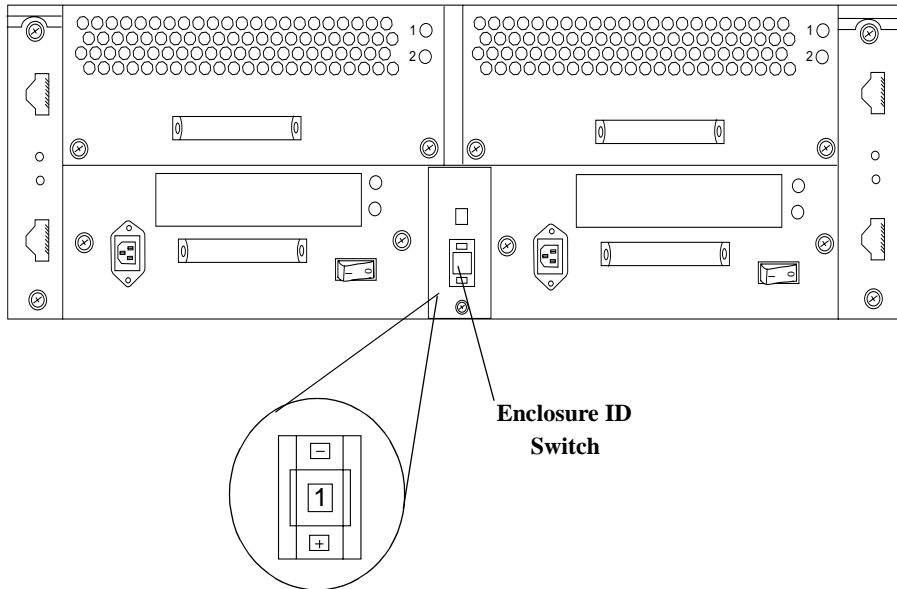

This enclosure ID switch can be set to 0 through 7.

The graphic below shows the slot number and location.

**Slot location when viewed from the front of the enclosure**

LSM
Slot 0
Slot 1
Slot 2
Slot 3
Slot 4
Slot 5
Slot 6
Slot 7
Slot 8
Slot 9
Slot 10
Slot 11
Slot 12
Slot 13
LSM

The fourteen disk drive slots (0 to 13), will be assigned an identifier based on the enclosure ID and the slot number as shown in Table 3-1.

**Table 3-1 Disk Drive Identifier Table**

Enclosure ID → Drive Slot ↓	0	1	2	3	4	5	6	7
<b>Slot 0</b>	3	18	33	48	63	78	93	108
<b>Slot 1</b>	4	19	34	49	64	79	94	109
<b>Slot 2</b>	5	20	35	50	65	80	95	110
<b>Slot 3</b>	6	21	36	51	66	81	96	111
<b>Slot 4</b>	7	22	37	52	67	82	97	112
<b>Slot 5</b>	8	23	38	53	68	83	98	113
<b>Slot 6</b>	9	24	39	54	69	84	99	114
<b>Slot 7</b>	10	25	40	55	70	85	100	115
<b>Slot 8</b>	11	26	41	56	71	86	101	116
<b>Slot 9</b>	12	27	42	57	72	87	102	117
<b>Slot 10</b>	13	28	43	58	73	88	103	118
<b>Slot 11</b>	14	29	44	59	74	89	104	119
<b>Slot 12</b>	15	30	45	60	75	90	105	120
<b>Slot 13</b>	16	31	46	61	76	91	106	121

## Configurations

This section describes the procedures for cabling the main configurations of the 2Gb SANbloc Series JBOD.

---

**Note:** *The following configuration procedures refer to connecting the 2Gb SANbloc Series directly to the host system. It is also possible to connect the system using a Hub/Switch.*

---

---

**CAUTION:** *Before working on the enclosure, ensure that anti-static precautions have been taken. The minimum requirement is an anti-static wrist strap and grounding wire.*

---



## JBOD Configurations

There are two JBOD configurations covered in this Installation Guide:

- Dual FC Loop mode (including how to daisy chain enclosures)
- Quad Loop (single enclosure with 4 FCAL loops)

---

**Note:** The following examples show the Copper/Copper I/O Module option for illustration purposes. The configuration procedures are identical for all I/O Module options.

---

### Dual FC Loop Configuration

---

**Note:** For dual FC Loop enclosures there **must** be two LS modules installed in the enclosure.

---

This section describes the procedure for connecting a dual FC Loop configuration to your host computer, and how to daisy chain these enclosures together.

To connect the dual FC Loop enclosure to the host:

---

**Note:** You will need two HBA's in your host system, or a single HBA with support for two connections. A hub, switch or two hosts with HBA may also be used.

---

- 1 Insert the connector on the first cable, into the top connector on the first I/O module (see Figure 3-2).
- 2 Insert the other end of this cable into the connector on your HBA.
- 3 Insert the connector on the second cable, into the top connector on the second I/O module (see Figure 3-2).
- 4 Insert the other end of this cable into the connector on your HBA.

---

**Note:** For details on your host and/or HBA refer to the documentation that was supplied with the host / HBA.

---

**Figure 3-2** Connecting dual FC Loop configuration to a host

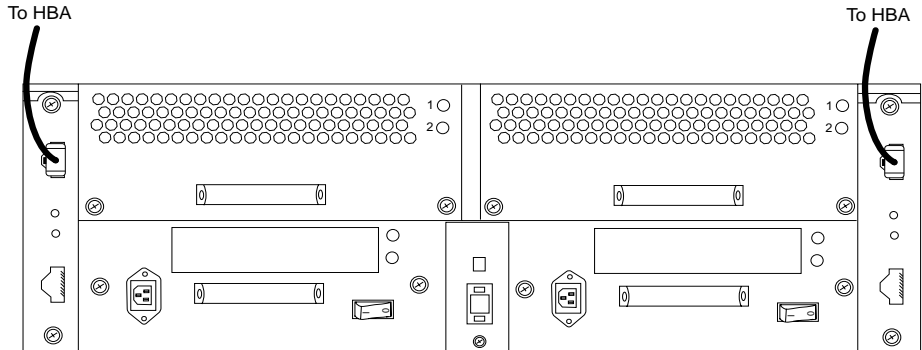

See Appendix C for Loop Diagram.

To daisy chain enclosures together, connect link cables from the bottom connectors on the I/O modules of the first enclosure to the top connectors of the I/O modules on the next enclosure (see Figure 3-3).

---

**Note:** A maximum of eight enclosures may be daisy chained together.

---

**Figure 3-3 Daisy chaining dual FC Loop enclosures**

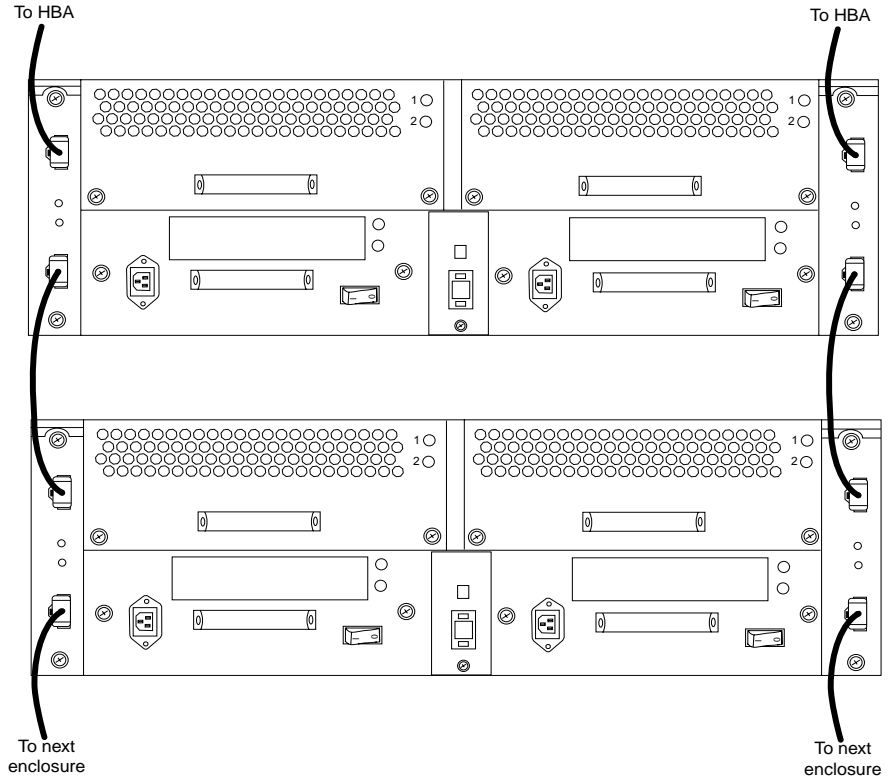

See Appendix C for Loop Diagram.

***CAUTION:*** When daisy chaining enclosures, you must ensure that each enclosure has a unique Enclosure ID.

## Quad Loop Configuration

**Note:** Quad loop configuration requires that the enclosure be configured in split loop mode. To set split loop mode, a jumper must be installed at jumper location JP3 on each LS module in the enclosure.

This section describes the procedure for connecting the enclosure in quad loop mode. For this configuration there must be two LS modules and two I/O modules installed in the enclosure.

- 1 Remove both LS modules from the enclosure and install a jumper, at jumper location JP3 if one is not already installed. This sets the enclosure to operate in split loop mode.
- 2 Attach cables to the top and bottom connector of both I/O modules (see Figure 3-4).
- 3 Attach the other end of these four cables to your host systems.

**Figure 3-4 Cabling the Quad Loop Configuration**

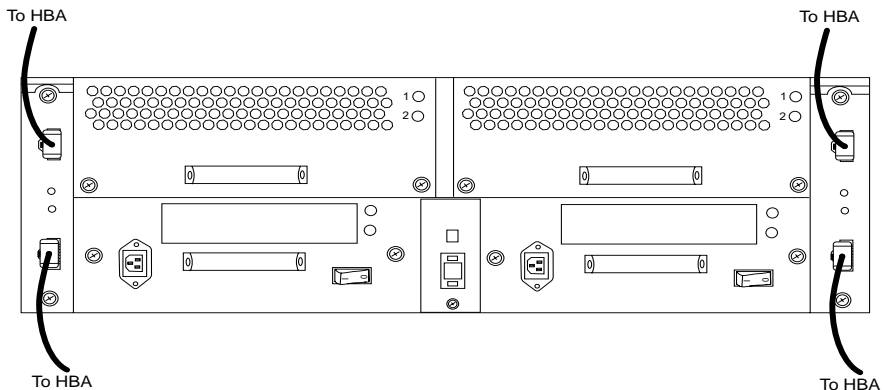

**CAUTION:** Enclosures in split loop mode can not be daisy chained to other enclosures.

## Connecting a Power Source

The 2Gb SANbloc enclosure supports dual AC power supplies. Only one power supply is required for normal operation. However, a second, optional power supply may be added to provide a redundant power system. Each power supply has its own AC power inlet.

---

**CAUTION:** Power supply cords shall have conductors with a cross-sectional area not less than  $4\text{mm}^2$ . This cross-sectional area corresponds to a minimum 10AWG wire.

---

### Connecting an AC Power Source

- 1 Ensure all cables have been attached as described in the preceding sections.
- 2 Attach the AC power cords to the power supplies and turn the power supply switches to the On (-) position (see Figure 3-5).

**Figure 3-5** Attaching the AC power cords

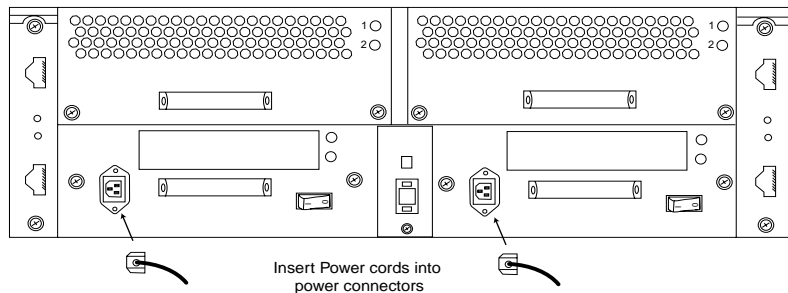

---

**WARNING:** This equipment must be connected to an earthed mains socket outlet. Ensure the power cabling provides earthing continuity to the equipment.

---

## Disk Drive Spin Up Sequence

At power on, the LS module will perform its internal start up initialization routine. Then the LS module will assert the disk drive START\_1 and START\_2 motor start signals low for disk drive slots 7 through 13, which will spin up the first 7 disk drives immediately. The LS module will then assert the disk drive START\_2 motor start signal low and leave the START\_1 motor start signal high for disk drive slots 0 through 6 which will command the second seven disk drives to spin up after a delay of 12 seconds times the modulo 8 value of the numeric SEL\_ID of the disk drive.

Once the enclosure is powered up and all 14 drives are spun up as depicted above, the enclosure will support immediate drive spin up with two power supplies present.

### Modulo 8

The drive spin up sequence above uses modulo 8 to calculate the spin up delay. Modulo 8 is determined by:

$$(\text{SHELF ID} \times \text{DRIVE NUMBER})/8 = \text{NUMBER} + \text{REMAINDER}$$

It is the **REMAINDER** value that is used for the calculation as it is always between 0 and 7 (hence modulo 8). The drive spin up time can then be calculated as follows:

$$\text{REMAINDER} \times \text{MODE PAGE SETTING} = \text{SPIN UP DELAY (Seconds)}$$

**EXAMPLE:** A typical Mode Page Setting is 12, so if the Remainder = 7, the Spin Up Delay would be 7 x 12, or 84 seconds.

## Chapter 4: RAID Configurations

This chapter describes how to set up, configure and use the 2Gb SANbloc Series RAID Controller. Some general information about the RAID controller is also provided.

### 2Gb SANbloc Series RAID Controller Introduction

The 2Gb SANbloc RAID Controller is a high performance controller, providing two host fibre channel and two device fibre channel interfaces. It is an intelligent, caching controller that supports RAID levels 0, 1, 3, 5, 0+1, and JBOD. The controller enables multiple hosts to access an array of disk drives, which can be configured as one or more virtual storage devices (logical units).

The controller provides continuous access to data in the event of a disk drive failure. When configured in a dual-active controller system, the RAID controller also provides continuous access to data in the event of a controller failure. This dual-active controller system is one in which two controllers share access to the same array of disk drives. In the event of a controller failure, controller operations are assumed by the surviving controller through a *failover* process. The failed controller can then be removed and replaced while the system is online. The new controller resumes processing array operations in a *failback* process. During failover and failback, write cache coherency is maintained with the disk drives.

Three circuit boards make up the RAID Controller:

- **Controller:** The controller circuit board contains the main controller and peripheral functions, including processor, control-store memory, XOR engine and cache controller, and

host and device fibre channel input/output processors (IOPs).

- **I/O:** The I/O circuit board provides the interface to the disk drive enclosure (device) and host as well as general support functions. It also contains the switching power supply, which generates +3.3 Vdc and +2.5 Vdc from +5 Vdc, hot-swap circuits, and battery backup unit (BBU) circuits.
- **Ethernet** (optional): The ethernet circuit board provides an ethernet interface to the controller, and connections for debug and out-of-band service to the host and device PCI busses.

The RAID Controller requires a minimum of two circuit boards: the controller and I/O. The controller and I/O circuit boards are connected using two 38-pin controlled impedance connectors. The controller, I/O, and ethernet circuit boards are assembled into a stack with the controller and ethernet boards mounted to a controller cover plate and the I/O board mounted to the controller board. When the ethernet circuit board is used, it is mounted to the controller circuit board. Figure 4-1 shows the three circuit boards in their relative positions.

**Figure 4-1 RAID Controller Circuit Boards**

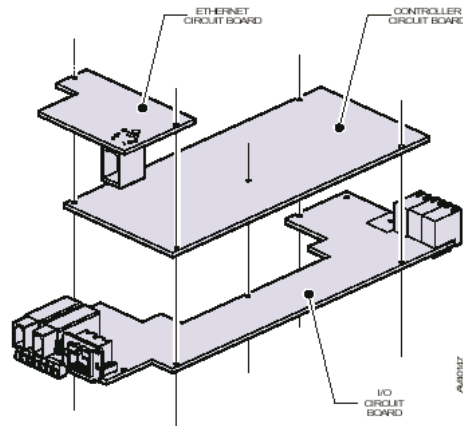



Features of the RAID Controller include:

- Main processor coupled with a companion chip
- Proprietary XOR engine ASIC that provides data processing XOR function and data cache SDRAM control
- Four 2Gb-capable fibre protocol chips for the device and host ports
- Dual internal 528 MB/s, 64-bit, 66 MHz PCI buses
- Separate memory areas for processor and user data
- Scalable data cache memory: 128, 256, 512 MB DIMMs
- 128 KB NVRAM configuration memory
- Real Time Clock
- 4 MB Flash PROM
- Transparent failover/failback with multiple target ID support

The I/O circuit board includes a Battery Backup Unit (BBU) that maintains memory content in case of AC power failure. Power for the BBU is provided by a battery pack mounted in the fan module of the enclosure.

## RAID Controller Circuit Boards

This section gives a brief description of the three RAID controller circuit boards: Controller, I/O, and Ethernet.

### Controller Circuit Board

The controller circuit board oversees and regulates the flow of data from a host through the I/O circuit board to the disk arrays in the 2Gb SANbloc enclosure. The controller circuit board performs these operations with a proprietary architecture, using the following components:

- Main microprocessor and companion chip
- Control-store memory
- Memory Controller/Hardware XOR Engine ASIC (XOR ASIC)
- Flash PROM
- Non-volatile RAM (NVRAM)
- Dual universal asynchronous receiver/transmitter (DUART)
- Fibre Channel I/O processors

- Cache DIMM memory

## I/O Circuit Board

The I/O circuit board provides the interface between the enclosure and a host, as well as general support functions. The I/O circuit board provides the following:

- Connections to the host
- Connections to the enclosure
- Dual switching power supply for +3.3 V and +2.5 V
- Hot pluggability for the controller
- Support for the BBU

The I/O circuit board has two SFF optical transceivers supporting shortwave multimode fibre on the host side and a 90-pin controlled impedance (50 Ohm) connector on the device side. An HSSDC connector with repeaters on the expansion loop provides for a copper connection between one of the device channels and an expansion module. Port bypass circuitry on the I/O circuit board enables quadplex operation on a second host loop. The I/O board has seven LEDs to indicate subsystem status.

## Ethernet Circuit Board

The ethernet circuit board provides a 10BASE-T/100BASE-TX LAN connection for out of band service for the RAID controller. Features of the ethernet circuit board include:

- PCI ethernet controller chip
- Enhanced scatter-gather bus mastering
- Operation in either full duplex or half-duplex mode
- Auto-negotiation for speed, duplex, and flow control
- RJ45 ethernet connector with integral activity and link status LEDs

The PCI ethernet controller is a fully integrated 10BASE-T/100BASE-TX controller consisting of both the media access controller (MAC) and physical layer (PHY) in one package.

It has a 32 bit, 33 MHz maximum PCI interface and features scatter-gather bus mastering, which enables it to perform high speed data transfers on the PCI bus. It operates in either full duplex mode or half duplex mode. It has a four wire interface to a serial EEPROM, which can provide power-on initialization and software configuration.

The firmware interface is primarily through the PCI interface, but a four-wire serial EEPROM interface can provide power-on initialization. The diagnostic interface is through the PCI interface.

The ethernet circuit board connects to the controller circuit board through a 114 pin Mictor impedance controlled connector. The electrical interface is with the primary PCI bus (host bus) on the controller circuit board. In addition to the PCI signals, this connector provides the 3.3 V power for the ethernet circuit board. The power required for this board is a maximum of 860 mA at 3.3 V, approximately 2.85 W.

## RAID Controller Location

The RAID controller is installed in the rear of the enclosure in the location shown in Figure 4-2.

**Figure 4-2 RAID Controller location**

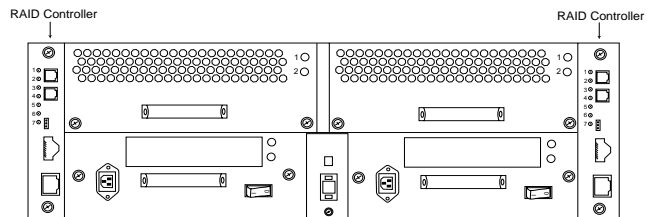

The above illustration shows a dual RAID configuration.

The main parts of the RAID Controller are described in Figure 4-3.

**Figure 4-3 Main components of RAID controller**

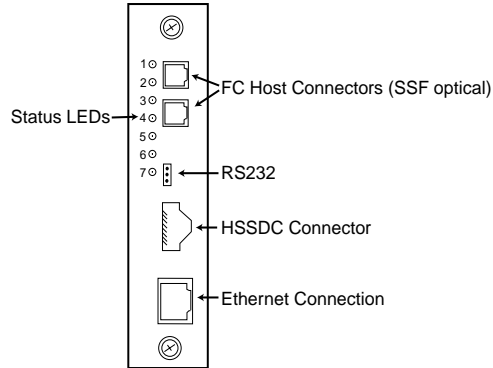

## RAID Controller Status LEDs

The RAID controller has 7 Status LEDs as shown above. Table 6-1 describes what these LEDs signify.

**Table 6-1 Controller Status LEDs**

LED	Description
1	Yellow - Not Ready. Normally Off. Goes On during power up sequence.
2	Green - Ready. Normally On
3	Green - Dirty Cache. On when there is data in cache.
4	Yellow - BBU Fault. Normally Off.
5	Green - Partner Fail. Normally Off
6	Green - Device Activity i.e. on drive channels. Flashes with activity.
7	Green - Host Activity. Flashes with activity.

## RAID Controller Configurations

This section describes how to cable the two standard RAID controller configurations: Single RAID Controller and Dual RAID Controller (dual active). The procedure for daisy chaining these standard configurations to expansions enclosures is also described. This section also describes how to set the enclosure ID.

### Setting the Enclosure ID

Each of the fourteen disk drive slots of the SANbloc Series has a unique identifier assigned to it. This identifier is assigned using a combination of the Slot number and the enclosure ID.

The enclosure ID is set, using the enclosure ID switch, located on the rear of the SANbloc (see Figure 4-4).

---

**Note:** *The enclosure ID must be set prior to powering on the enclosure.*

---

---

**Note:** *Each enclosure must have a separate ID when daisy chained together.*

---

**Figure 4-4 Location of Enclosure ID Switch**

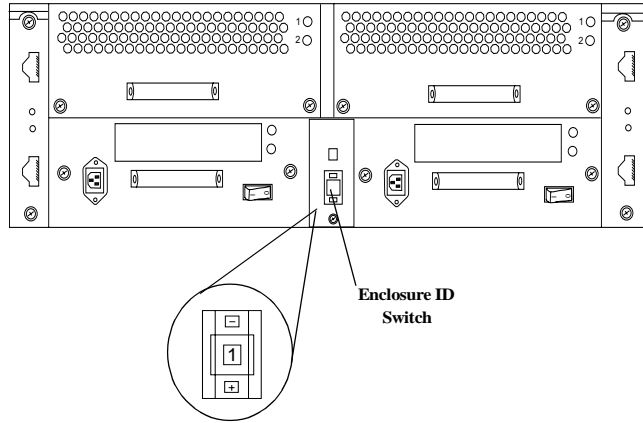

This enclosure ID switch can be set to 0 through 7.

The graphic below shows the slot number and location.

**Slot location when viewed from the front of the enclosure**

LSM
Slot 0
Slot 1
Slot 2
Slot 3
Slot 4
Slot 5
Slot 6
Slot 7
Slot 8
Slot 9
Slot 10
Slot 11
Slot 12
Slot 13
LSM

The fourteen disk drive slots (0 to 13), will be assigned an identifier based on the enclosure ID and the slot number as shown in Table 6-2.

Table 6-2 Disk Drive Identifier Table

Enclosure ID Drive Slot	0	1	2	3	4	5	6	7
Slot 0	3	18	33	48	63	78	93	108
Slot 1	4	19	34	49	64	79	94	109
Slot 2	5	20	35	50	65	80	95	110
Slot 3	6	21	36	51	66	81	96	111
Slot 4	7	22	37	52	67	82	97	112
Slot 5	8	23	38	53	68	83	98	113
Slot 6	9	24	39	54	69	84	99	114
Slot 7	10	25	40	55	70	85	100	115
Slot 8	11	26	41	56	71	86	101	116
Slot 9	12	27	42	57	72	87	102	117
Slot 10	13	28	43	58	73	88	103	118
Slot 11	14	29	44	59	74	89	104	119
Slot 12	15	30	45	60	75	90	105	120
Slot 13	16	31	46	61	76	91	106	121

## Configurations

This section shows how to connect the RAID enclosures to a host system(s). The procedure for daisy chaining the enclosures together is also described.

## Single RAID Controller Configuration

In this configuration only one RAID controller is installed in the enclosure's I/O slot. The second I/O slot must contain an I/O module or a blank plate.

---

**Note:** *The following configuration procedures refer to connecting the 2Gb SANbloc Series directly to the host system. It is also possible to connect the system using a Hub/Switch.*

---

**CAUTION:** *Before working on the enclosure, ensure that anti-static precautions have been taken. The minimum requirement is an anti-static wrist strap and grounding wire.*

---

To connect this configuration to a host system, follow this procedure:

### Connecting a Single RAID Controller to a Host

- 1 Plug both host cables into the host connectors on the RAID controller (see Figure 4-5).

---

**Note:** *For single HBA configurations only one of the host connectors should be used.*

---

- 2 Connect the opposite ends of these host cables, to the HBA's of the host system.

---

**Note:** *For details on your host and/or HBA refer to the documentation that was supplied with the host / HBA.*

---



Figure 4-5 Single RAID Controller to Host Connector

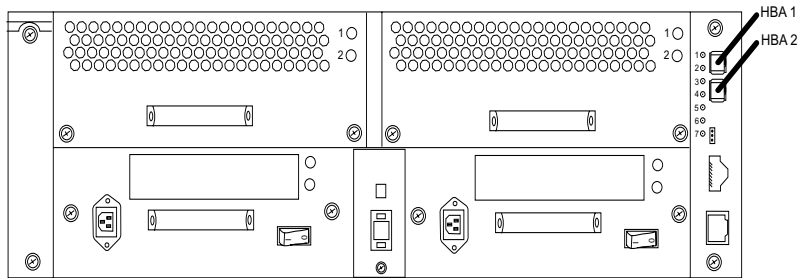

### Daisy Chaining a Single Controller Enclosure

To daisy chain the RAID enclosure to an expansion enclosure, connect link cables from the RAID controller to the top connectors of the I/O modules of the expansion enclosure (see Figure 4-6).

---

**Note:** A maximum of eight enclosures may be daisy chained together.

---

**Figure 4-6 Daisy Chaining Single Controller Enclosure**

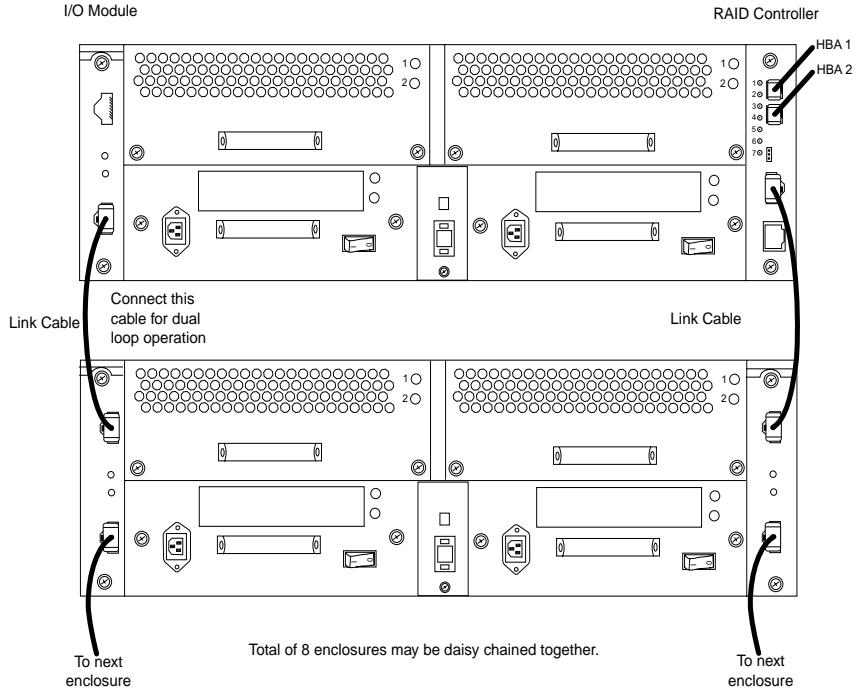

***CAUTION: When daisy chaining enclosures, you must ensure that each enclosure has a unique Enclosure ID.***

## Dual RAID Controller Configuration

In this configuration two RAID Controllers are installed in the enclosures I/O slots.

---

**Note:** *The following configuration procedures refer to connecting the 2Gb SANbloc Series directly to the host system. It is also possible to connect the system using a Hub/Switch.*

---

---

**CAUTION:** *Before working on the enclosure, ensure that anti-static precautions have been taken. The minimum requirement is an anti-static wrist strap and grounding wire.*

---

To connect this configuration to a host system, follow this procedure:

### Connecting Dual RAID Controllers to a Host System

---

**Note:** *This example configuration assumes that the RAID enclosure is being attached to two separate host systems, each containing two HBA's. Other configurations, such as one host with 4 HBA's are also possible.*

---

- 1 Plug two host cables in to the host connectors of the first RAID controller (one cable into each FC connector).
- 2 Plug the opposite ends of these cables into the HBA's of the first host system (see Figure 4-7)
- 3 Plug two host cables in to the host connectors of the second RAID controller (one cable into each FC connector).
- 4 Plug the opposite ends of these cables into the HBA's of the second host system (see Figure 4-7)

Figure 4-7 Dual RAID Controller Configuration

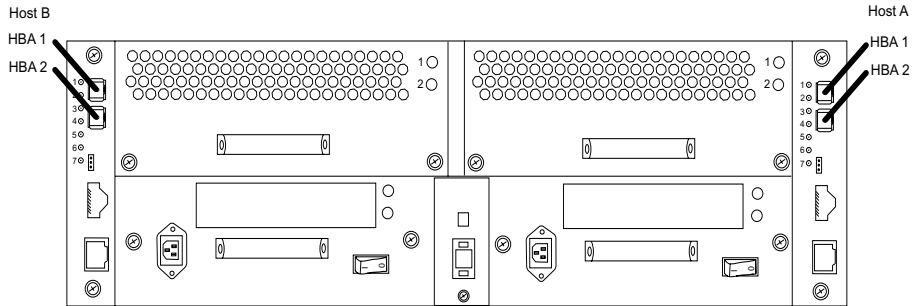

### Daisy Chaining a Dual Controller Enclosure

To daisy chain the RAID enclosure to an expansion enclosure, connect link cables from the RAID enclosure to the top connectors of the I/O modules of the expansion enclosure (see Figure 4-8).

---

**Note:** A maximum of eight enclosures may be daisy chained together.

---

Figure 4-8 Daisy Chaining a Dual Controller Enclosure

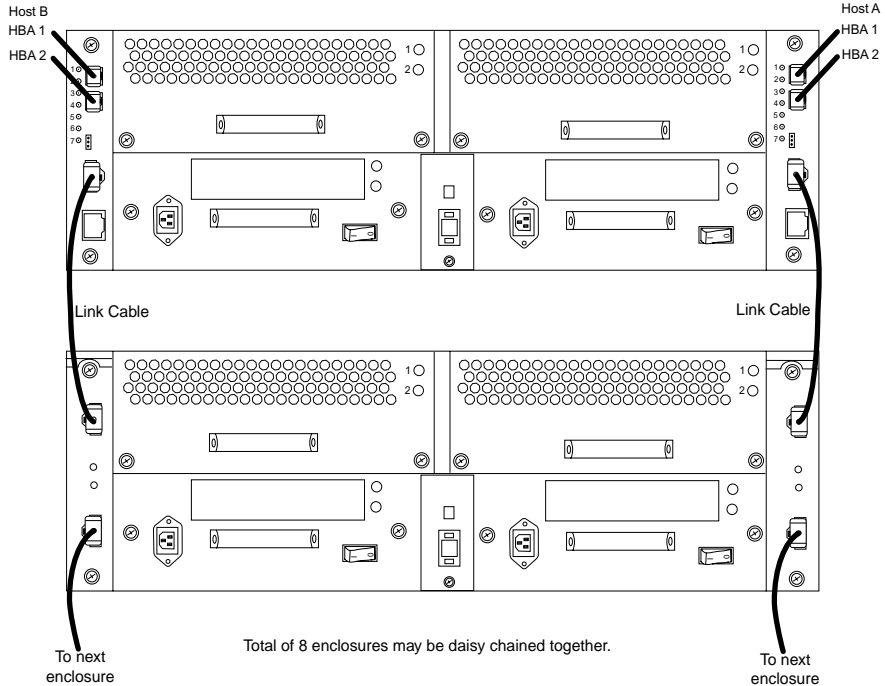

**CAUTION:** When daisy chaining enclosures, you must ensure that each enclosure has a unique Enclosure ID.

## Connecting a Power Source

The 2Gb SANbloc enclosure supports dual AC power supplies. Only one power supply is required for normal operation. However, a second, optional, power supply may be added to provide a redundant power system. Each power supply has its own AC power inlet.

---

**CAUTION:** Power supply cords shall have conductors with a cross-sectional area not less than  $4\text{mm}^2$ . This cross-sectional area corresponds to a minimum 10AWG wire.

---

### Connecting an AC Power Source

- 1 Ensure all cables have been attached as described in the preceding sections.
- 2 Attach the AC power cords to the power supplies and turn the power supply switches to the On (-) position (see Figure 4-9).

**Figure 4-9 Attaching the AC power cords**

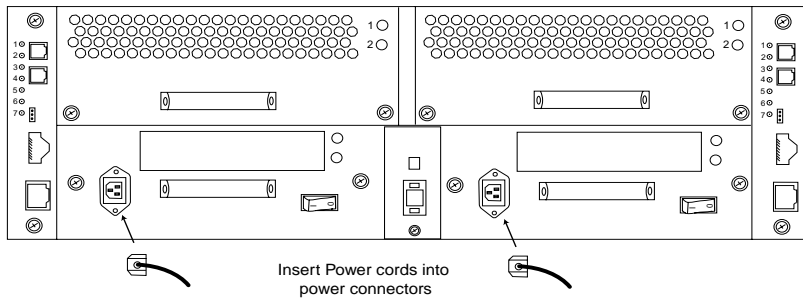

---

**WARNING:** This equipment must be connected to an earthed mains socket outlet. Ensure the power cabling provides earthing continuity to the equipment.

---

## Disk Drive Spin Up Sequence

At power on, the LS module will perform its internal start up initialization routine. Then the LS module will assert the disk drive START\_1 and START\_2 motor start signals low for disk drive slots 7 through 13, which will spin up the first 7 disk drives immediately. The LS module will then assert the disk drive START\_2 motor start signal low and leave the START\_1 motor start signal high for disk drive slots 0 through 6 which will command the second seven disk drives to spin up after a delay of 12 seconds times the modulo 8 value of the numeric SEL\_ID of the disk drive.

Once the enclosure is powered up and all 14 drives are spun up as depicted above, the enclosure will support immediate drive spin up with two power supplies present.

### Modulo 8

The drive spin up sequence above uses modulo 8 to calculate the spin up delay. Modulo 8 is determined by:

$$(\text{SHELF ID} \times \text{DRIVE NUMBER})/8 = \text{NUMBER} + \text{REMAINDER}$$

It is the **REMAINDER** value that is used for the calculation as it is always between 0 and 7 (hence modulo 8). The drive spin up time can then be calculated as follows:

$$\text{REMAINDER} \times \text{MODE PAGE SETTING} = \text{SPIN UP DELAY (Seconds)}$$

**EXAMPLE:** A typical Mode Page Setting is 12, so if the Remainder = 7, the Spin Up Delay would be 7 x 12, or 84 seconds.





## Chapter 5: System Monitoring

This Chapter describes the devices used to monitor the 2Gb SANbloc Series. The location of the monitoring LEDs and how to interpret them is described.

### Overview

The front mounted LS module is the main monitoring device of the 2Gb SANbloc Series. This module is complemented by status and fault LEDs, mounted on all the major components of the enclosure, such as, disk drives, power supplies, Advanced Cooling Modules (ACMs), and RAID Controller. All these monitoring devices are discussed in the following sections.

### LS Module

The LS Module (Loop Resiliency and SES Module) provides monitoring and control for the 2Gb SANbloc Series. The module reports status and receives control information over the Enclosure Services Interface (ESI) port of any of the fourteen disk drives installed in the enclosure. The LS Module also provides loop resiliency for the Fibre Channel loop (in the form of Port Bypass Circuits).

The 2Gb SANbloc Series contains one LS Module as standard. However, a second optional LS Module is available to provide active/passive fail-over for the enclosure services communication, and to provide a second Fibre Channel Loop. Only one LS Module communicates (using ESI communication) with the host system at any one time, but both LS modules will continuously monitor the

system. If the active LS Module fails, then the ESI communication with the host system will be taken over by the passive LS Module.

### LS Module Features

- Monitoring/Control for 2 Power Supplies and 2 ACMs
- Reports status and receives control information via the FC loop
- Microcontroller for data processing, control and communications
- Volatile and non-volatile memory for the microcontroller
- Temperature sensor
- Audible alarm with manual and software disable
- FC link monitoring and status information
- Firmware download capability
- Reporting of PSU, LS module, I/O module, and backplane serial number and revision
- I/O module and backplane type reporting
- Control of 6 front LEDs for enclosure and module status
- I/O option slot status monitoring

### 2Gb SANbloc Enclosure LEDs

The 2Gb SANbloc Series has six LEDs located on each of the front mounted LS Modules. These LEDs show the status of the enclosure, power supply, Fibre Channel Loops, LS Module status and the operating mode of the enclosure (1GB or 2Gb operation). Figure 5-1 shows the location of the LEDs

Figure 5-1 Location of 2Gb SANbloc Enclosure LEDs

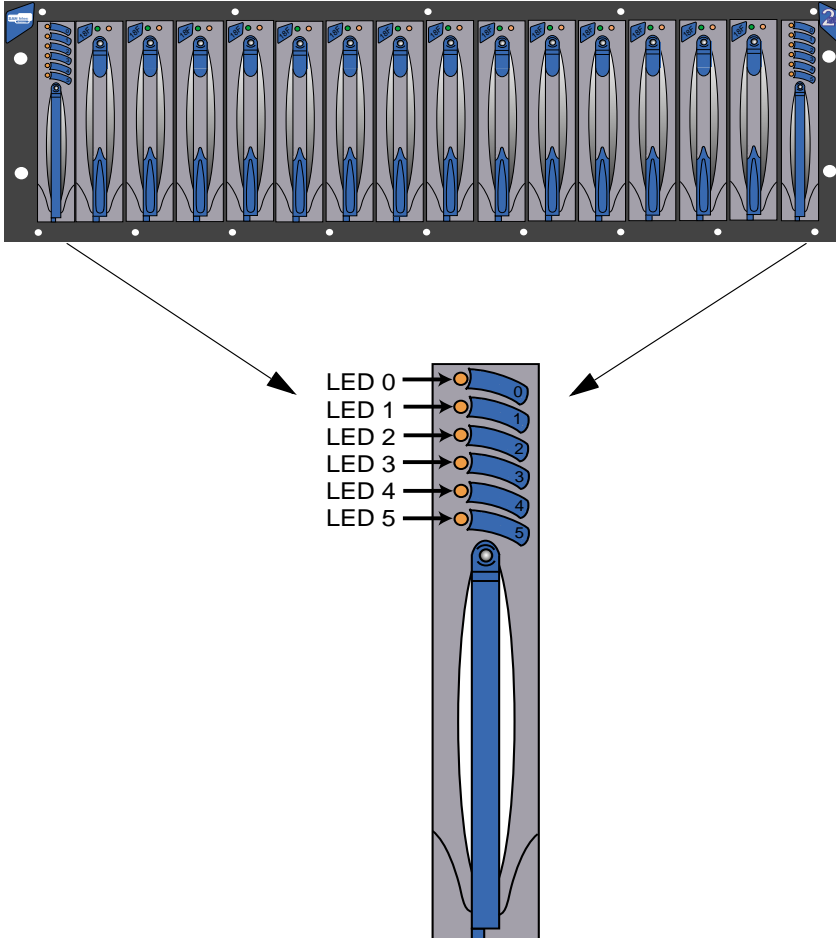

Table 5-1 shows the meaning of each of the LEDs, and how to interpret them.

Table 5-1 Enclosure LED Descriptions

	Description	Color	Indication
LED 0	Power On	Green	Normally <b>ON</b> , indicates power is applied. <b>OFF</b> indicates no power.
LED 1	Shelf Fault	Amber	Normally <b>OFF</b> indicates no faults exist in the enclosure. <b>ON</b> indicates a fault. <b>Flashing</b> of this LED indicates the both a 1GB and a 2Gb I/O module has been detected.
LED 2	FC Loop A	Green	<b>ON</b> indicates FC Loop A closed. <b>OFF</b> indicates FC Loop A open
LED 3	FC Loop B	Green	<b>ON</b> indicates FC Loop B closed. <b>OFF</b> indicates FC Loop B open.
LED 4	LS Fault	Amber	Normally <b>OFF</b> indicating that the LS Module has no fault. <b>ON</b> indicates an LS Module fault. <b>Flashing</b> of this LED indicates that the LS is a 1GB LS module in a 2Gb system.
LED 5	2Gb Operation	Green	<b>ON</b> indicates the FC loop is operating at 2Gb/Sec speed. <b>OFF</b> indicates the FC Loop is operating at 1GB/Sec Speed. <b>Flashing</b> of this LED indicates that the LS module is set to an incorrect speed.

---

**Note:** The audible alarm will sound when an error is detected.

---



---

**CAUTION:** If 1GB and 2Gb hardware is mixed in an enclosure at power up, and the enclosure is set to 2Gb, the drives will not spin up and LED 5 will flash.

---

## Disk Drive LEDs

Each disk drive carrier has two LED indicators visible from the front of the 2Gb SANbloc enclosure. The green disk drive ready LED is controlled by the disk drive, and the bi-colour LED is controlled by the LS Module. The following table shows how to interpret these LEDs.

**Table 5-2 Disk Drive LED Descriptions**

Drive Ready Green LED	Bicolor LED Green	Bicolor LED Amber	Condition
Drive Controlled	Off	Off	Slot empty, ready for insert
Drive Controlled	On	Off	Drive online, ready for operation
Drive Controlled	ON 125ms Off 125ms	Off Off	Drive Identify (POD)
Drive Controlled	ON 250ms Off 250ms	Off Off	Prepare for removal
Drive Controlled	On 500ms Off 125ms	Off Off	Drive Rebuild
Drive Controlled	Off	On 125ms Off 125ms	Drive Fail
Drive Controlled	Off Off	On 125ms Off 750ms	Drive off-line, Loop A or Loop B <sup>a</sup>

a. The shelf fault Amber LED is On. This is visible from the front of the enclosure

---

**Note:** *The audible alarm will sound when an error is detected.*

---

**Figure 5-2 Disk Drive Carrier LEDs**

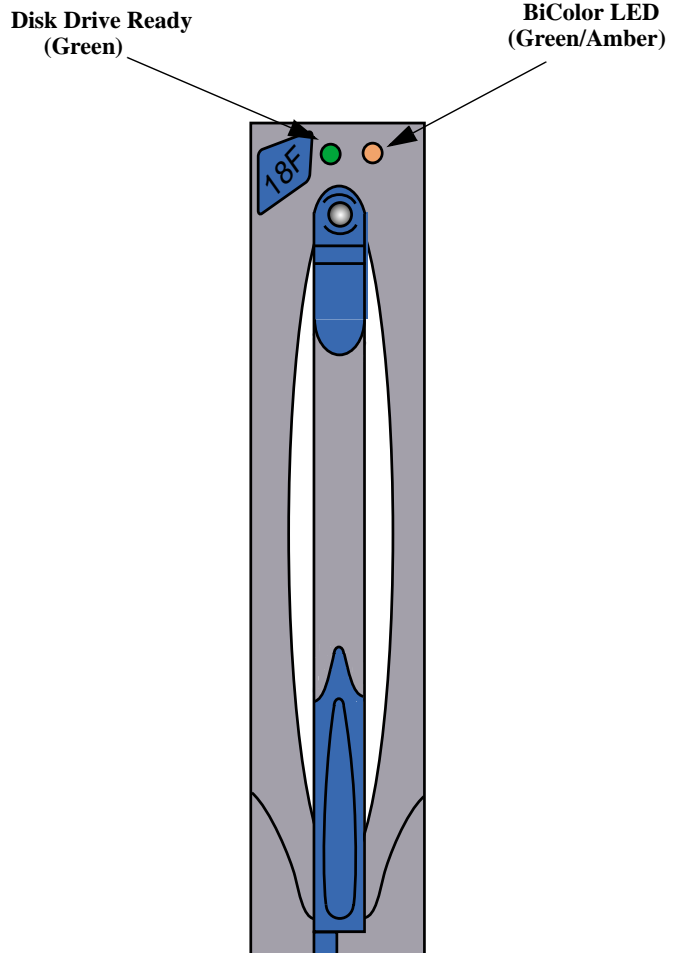

## Power Supply LEDs

The 2Gb SANbloc Series uses two AC power supplies. The AC power supplies provide 853W peak output power and 673W continuous output power.

The 2Gb SANbloc Series power supply has two LED indicators on it, which are visible from the rear of the enclosure. The green Power OK LED is on when the power supply is operating normally. This green LED is driven by the power supply, and indicates that the power supply output voltages are operating normally. The power supply amber Fault LED is driven by the LS Module and power supply. This amber LED is ON when the LS Module detects a power supply fault, or it will flash, when the power supply Locate feature is selected.

---

**Note:** *The audible alarm will sound when an error is detected*

---

**Figure 5-3 Power Supply LEDs**

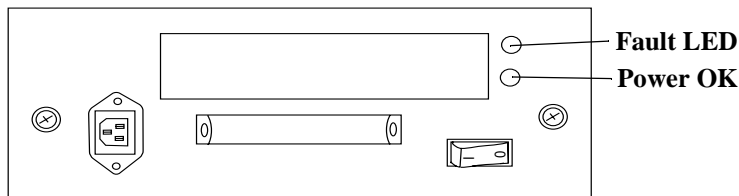

## Advanced Cooling Module (ACM) LEDs

The 2Gb SANbloc Series has two variable speed fans per advanced cooling module. Each of the two ACMs on the rear of the 2Gb SANbloc Series enclosure has two fault LEDs visible from the rear of the enclosure. The LEDs are labeled “1” and “2” to correspond with the two fans inside the ACM assembly. These LEDs are normally off and will only be on when a fault is detected in a fan by the LS Module.

---

**Note:** *The audible alarm will sound when an error is detected.*

---

**Figure 5-4** Advanced Cooling Module LEDs

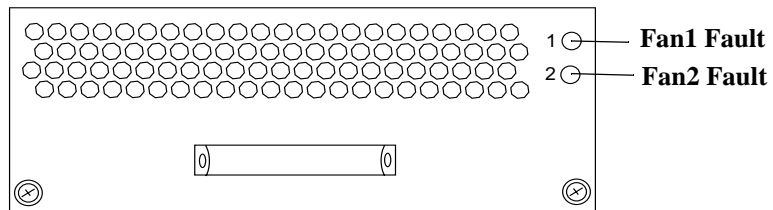



## RAID Controller LEDs

The RAID controller has 7 LEDs located and numbered as shown.

**Figure 5-5 RAID controller LEDs**

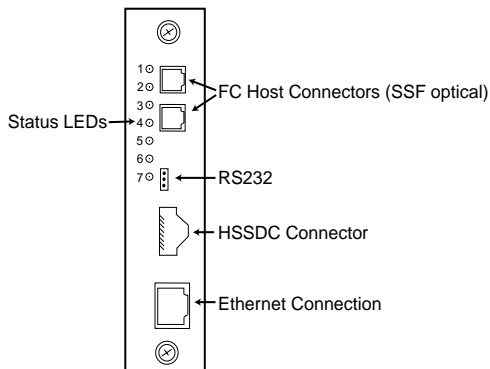

The table below describes the LEDs meaning.

**Table 5-3 Controller Status LEDs**

LED	Description
1	Yellow - Not Ready. Normally Off. Goes On during power up sequence.
2	Green - Ready. Normally On
3	Green - Dirty Cache. On when there is data in cache.
4	Yellow - BBU Fault. Normally Off.
5	Green - Partner Fail. Normally Off
6	Green - Device Activity i.e. on drive channels. Flashes with activity.
7	Green - Host Activity. Flashes with activity.



## Chapter 6: Installing and Removing Components

This Chapter describes the procedures for installing and removing the replaceable components in the 2Gb SANbloc Series.

---

***WARNING: The module handles are to facilitate the easy insertion and removal of the modules, they should not be used to lift and/or carry the enclosure.***

---

## Location of the Components

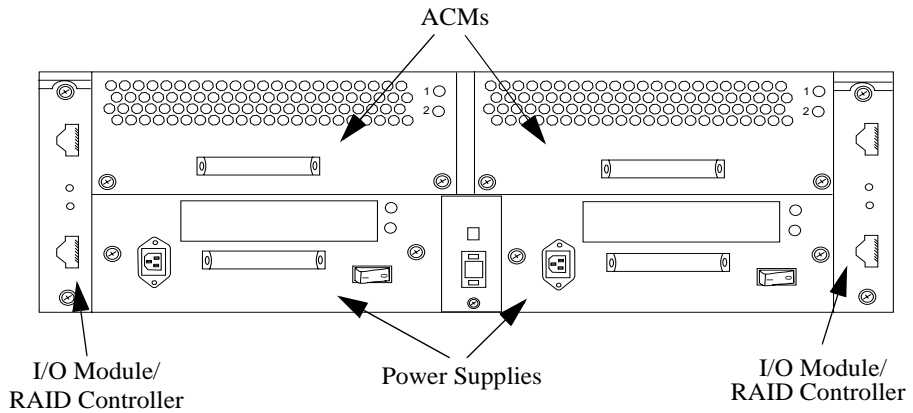
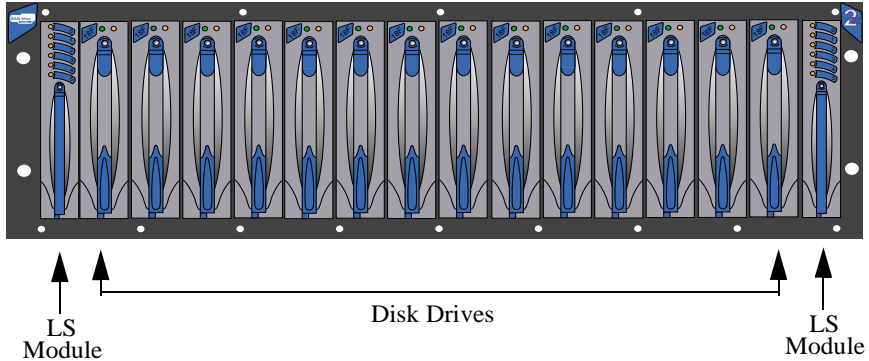

## Installing and Removing a Disk Drive Carrier

The disk drive carriers are located in the front of the enclosure. Follow these procedures to install and remove the disk drive carrier.

### Installing a Disk Drive Carrier

- 1 Select the disk drive slot into which the disk drive carrier is to be installed and remove the carrier blank if there is one installed.
- 2 Orient the disk drive carrier such that the LEDs are on the top (on the right for desk side systems).
- 3 With the cam lever fully open slide the carrier into the slot until the lever starts to close.
- 4 Fully close the cam lever. The lever is fully closed, and the drive locked in place, when the lever “clicks” into position.

### Removing a Disk Drive Carrier

- 1 Using your finger, release the locking tab by pressing it in the direction shown in Figure 5-1, and pull the cam lever towards you.
- 2 Fully open the cam lever. (approx. 90° to enclosure).
- 3 With the cam lever open wait for at least one minute to allow the disk drive to spin down fully before removing it.
- 4 Gently, pull the disk drive carrier out of the enclosure.

---

**CAUTION:** *Immediately replace the disk drive carrier or install a disk drive carrier blank to maintain correct airflow.*

---

**Figure 6-1 Disk Drive Carrier**

Push locking tab in this direction to open

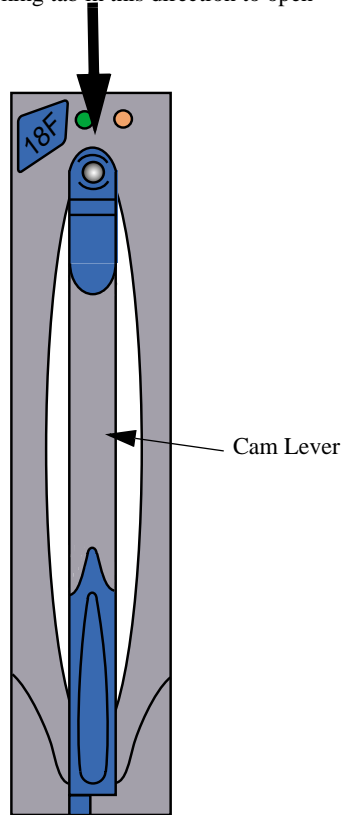

## Installing and Removing an LS Module

The LS Modules are located in the front of the enclosure. Follow these procedures to install and remove the LS Modules.

### Installing an LS Module

- 1 Select the LS Module slot in to which the LS Module is to be inserted and remove the LS blank if one is installed.
- 2 Orient the LS Module such that the LEDs are on the top (on the right for deskside systems).
- 3 With the cam lever fully open slide the LS Module into the slot until the lever starts to close.
- 4 Fully close the cam lever. The lever is fully closed, and the LS Module locked in place, when the lever “clicks” into position.

### Removing an LS Module

- 1 Using your finger, release the locking tab by pressing it in the direction shown in Figure 5-2, and pull the cam lever towards you.
- 2 Fully open the cam lever (approx. 90° to enclosure).
- 3 Gently, pull the LS Module out of the enclosure.

---

***CAUTION: Immediately replace the LS Module or install an LS Module blank to maintain correct airflow.***

---

Figure 6-2 LS Module

Push locking tab in this direction to open

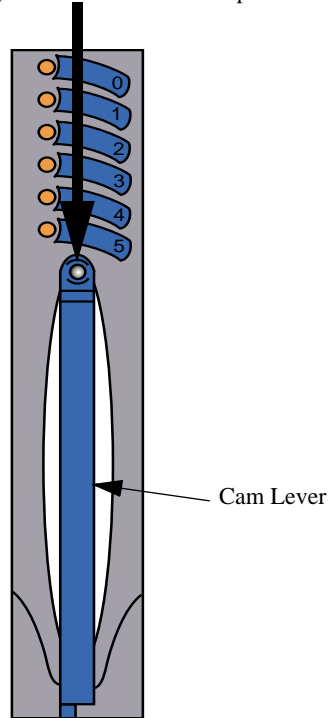



## Installing and Removing a Power Supply

The power supplies are located in the rear of the enclosure. Follow these procedures to install and remove the power supplies.

### Installing a Power Supply

- 1 Select the power supply slot into which the power supply is to be inserted and remove the carrier blank if there is one installed.
- 2 Orient the power supply, such that the LEDs are on the top (on the right hand side for rack mount systems).
- 3 Gently slide the power supply into the empty power supply slot.
- 4 Secure in place using the two fixing screws (torque setting 0.3Nm).
- 5 Install the power cables.

### Removing a Power Supply

- 1 Turn off the power supply, and remove the power cable.
- 2 Loosen the two fixing screws.
- 3 Using the power supply handle, gently slide it out of the enclosure.

---

**CAUTION:** Immediately replace the power supply carrier or install a power supply carrier blank to maintain correct airflow.

---

Figure 6-3 Power Supply

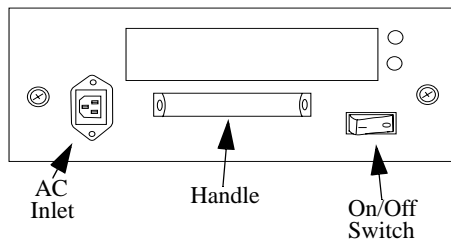

## Installing and Removing an Advanced Cooling Module

The advanced cooling modules are located in the rear of the enclosure. Follow these procedures to install and remove the advanced cooling modules.

### Installing an Advanced Cooling Module

- 1 Select the advanced cooling module slot into which the module is to be installed.
- 2 Orient the module, such that the LEDs are on the top (on the right hand side for rack mount systems).
- 3 Gently slide the ACM into the empty ACM slot.
- 4 Secure in place using the two fixing screws (torque setting 0.3Nm).

### Removing an Advanced Cooling Module

- 1 Loosen the two fixing screws.
- 2 Using the advanced cooling module handle, gently slide it out of the enclosure.

---

**CAUTION:** Immediately replace the ACM to maintain correct air-flow.

---

Figure 6-4 Advanced Cooling Module

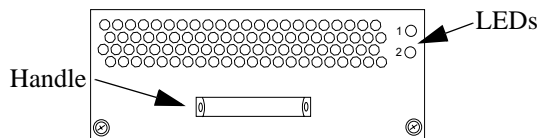

## Installing and Removing an I/O Module/RAID Controller

---

**Note:** In the following section, “I/O Module” is taken to include the RAID Controller in addition to the I/O Module.

---

The I/O module is located in the rear of the enclosure. Follow these procedures to install and remove the I/O module.

### Installing an I/O Module/RAID Controller

- 1 Remove the I/O module blank if there is one installed.
- 2 Gently insert the I/O module into the slot.
- 3 Secure in place using the two fixing screws (torque setting 0.3Nm).
- 4 Connect the cables as described in Chapter 3.

### Removing an I/O Module/RAID Controller

- 1 Remove all cables.
- 2 Loosen the two fixing screws.
- 3 Using the module handle, gently slide the I/O Module out of the slot.

---

**CAUTION:** Immediately replace the carrier or install an I/O module blank to maintain correct airflow.

---



## Appendix A: Safety Statement Translations

**CAUTION**

---

**CAUTION:** This equipment is intended only for installation in a restricted access location.

---

---

**ACHTUNG:** Dieses Gerät sollte nur an einem Ort mit Zugangskontrolle installiert werden.

---

---

**FÖRSIKTIGHET:** Denna utrustning får endast installeras på ställe med begränsad åtkomst.

---

---

**VAROITUS:** Laitteisto on tarkoitettu asennettavaksi ainoastaan sivullisilta suojattuun paikkaan.

---

---

**FORSIGTIG:** Dette udstyr er kun beregnet til installation i et område med begrænset adgang.

---

---

**OBS:** Dette utstyret er bare beregnet for installering på steder med adgangsbegrænsning.

---

# CAUTION

---

**CAUTION:** Allow disk drives and power supplies to reach room ambient temperature before powering on the shelf.

---

---

**ACHTUNG:** Ehe Laufwerke und Netzteile an die Stromversorgung angeschlossen werden, sollten sie sich an die Raumtemperatur angepasst haben.

---

---

**FÖRSIKTIGHET:** Låt skivdrivenheter och strömtillförsel nå rumstemperatur innan strömförsörjningen slås på.

---

---

**VAROITUS:** Ennen kuin kytket virran hyllyn sijoitettuihin levyasemiin ja teholähteisiin, odota, että laitteet saavuttavat huoneiston lämpötilan.

---

---

**FORSIGTIG:** Sørg for, at drev og strømforsyninger har opnået rumtemperaturer, før strømmen tilsluttes hylden.

---

---

**OBS:** La diskstasjoner og strømforsyninger nå romtemperatur før du slår på strømmen til hyllen.

---

# CAUTION

**CAUTION:** It is recommended that if interconnecting equipment resides within more than one equipment rack cabinet, these rack cabinets should be at the same ground potential.

**ACHTUNG:** Befinden sich Verbindungselemente in mehr als einem Rack-Gehäuse, sollten die Racks dasselbe Massepotential aufweisen.

**FÖRSIKTIGHET:** Vi rekommenderar, om förbindelseutrustning finns i mer än ett utrustningshyllskåp, att dessa hyllskåp ligger på samma jordpotential.

**VAROITUS:** Jos toisiinsa yhdistettyjä laitteita sijaitsee useammassa kuin yhdessä kehyksessä, on suositeltavaa sijoittaa kyseiset kehykset samalle tasolle.

**FORSIGTIG:** Hvis der i mere end ét udstyrskabinet er indbyrdes forbundet udstyr, bør disse kabinetter have samme grundspænding.

**OBS:** Dersom sammenkoblingsutstyr er monteret i mer enn ett kabinett i utstyrskab, anbefales det at kabinettene blir monteret slik at de har samme jordingspotensial.

# CAUTION

**CAUTION:** Before attempting to install or remove any of the components, ensure that anti-static precautions have been taken. The minimum requirement is a properly grounded anti-static wrist strap and grounding wire.

**ACHTUNG:** Vor dem Entfernen oder Installieren einer Komponente sollte sichergestellt werden, dass antistatische Vorsichtsmaßnahmen ergriffen wurden. Mindestanforderung sind ein ordnungsgemäß geerdetes Antistatik-Armband und ein Erdungskabel.

**FÖRSIKTIGHET:** Se till att antistatiska åtgärder vidtages innan någon av komponenterna installeras eller avlägsnas. Minimumkravet är ett ordentligt jordat antistatiskt armband och jordledning.

**VAROITUS:** Ennen komponenttien asentamista tai poistamista varmistu, että antistaattisista varotoimenpiteistä on huolehdittu. Vähimmäisvaatimuksina on asianmukaisesti maadoitettu antistaattinen rannehihna ja maadoitusjohto.

**FORSIGTIG:** Før du forsøger at installere eller fjerne en af komponenterne, skal du tage antistatiske forholdsregler. Minimumskravet er en korrekt jordet, antistatisk håndledsrem og en afleder.

**OBS:** Før det blir gjort forsøk på installere eller fjerne komponenter, må det tas forholdsregler for å avverge statisk elek-



# CAUTION

trisetet. Minimumskravet er riktig jordet antistatisk håndleddstropp og jordingsledning.

---

**CAUTION:** When installing or removing a rackmount shelf, remove all power supplies and disk drives. It is recommended that you work with at least one other person when installing a disk shelf. This is necessary to prevent personal injury and damage to the shelf.

---

**ACHTUNG:** Vor der Installation oder dem Entfernen eines Rackmontagefachs müssen alle Netzteile und Laufwerke entfernt werden. Es wird empfohlen, die Installation des Laufwerkfachs von mindestens zwei Personen vornehmen zu lassen. Dies ist notwendig, um Verletzungen bzw. Schäden am Fach zu vermeiden.

---

**FÖRSIKTIGHET:** När en utrustningshylla installeras eller avlägsnas ska all strömtillförsel bortkopplas och alla skivdrivenheter avlägsnas. Det rekommenderas att du arbetar med minst en person till när en skivhylla ska installeras. Detta är nödvändigt för att förhindra personliga skador och skador på hyllan.

---

**VAROITUS:** Poista kaikki tehölähteet ja levyasemat ennen hyllyn asentamista kehykseen tai poistamista kehyksestä. Levyhyllä asennettaessa on suositeltavaa käyttää ainakin yhtä avustajaa. Tämä on välttämätöntä loukkaantumisten ja hyllyn vaurioitumisen välttämiseksi.

---

# CAUTION

---

**FORSIGTIG:** Når en rackmonteret hylde installeres eller fjernes, skal al strømforsyning og alle drev fjernes. Det anbefales, at der mindst er én anden person til stede, når en drevhylde installeres. Det er nødvendigt for at undgå personskade og beskadigelse af hylden.

---

---

**OBS:** Når hylle for rackmontering blir installert eller fjernet, må alle strømforsyninger og diskstasjoner fjernes. Det anbefales at du arbeider sammen med minst én annen person når du installerer en diskhylle. Dette er nødvendig for å hindre personskade og skade på hyllen.

---

# CAUTION

---

**CAUTION:** The tower skin set is not a field replaceable unit and therefore must not be removed from the Storage Array.

---

---

**ACHTUNG:** Das Tower-Gehäuse kann nicht am Einsatzort ausgetauscht werden und sollte deshalb nicht entfernt werden.

---

---

**FÖRSIKTIGHET:** Det yttre höljet är inte en utbytbar enhet och skall därför inte avlägsnas från lagringsuppsättningen.

---

---

**VAROITUS:** Tornikehys ei ole paikan päällä vaihdettavissa eikä sitä saa poistaa muistijärjestelmästä.

---

---

**FORSIGTIG:** Søjleindkapslingen kan ikke udskiftes på stedet og må derfor ikke fjernes fra lagringssystemet.

---

---

**OBS:** Det ytre dekselet er ikke konstruert for å kunne skiftes på stedet, og må derfor ikke fjernes fra lagringskabinettet.

---

# CAUTION

---

**CAUTION:** After removing the LS Module the resulting hole must be blocked by installing a blanking plate or by installing a replacement LS Module. Failure to do this can disrupt airflow and seriously reduce cooling.

---



---

**ACHTUNG:** Nach dem Entfernen des LS Module muss die entstehende Lücke durch eine Blende oder durch die Installation eines anderen LS Module geschlossen werden. Wird dies nicht beachtet, kann es zu Unterbrechung der Luftzufuhr und zu stark verminderter Kühlung kommen.

---



---

**FÖRSIKTIGHET:** När en LS Module avlägsnas skall utrymmet som blir kvar blockeras genom att en blindplåt installeras eller genom att sätta in en ny LS Module. Ett allvarligt avbrott i luftflödet kan orsakas och därmed reducera kylningen om detta inte görs.

---



---

**VAROITUS:** LS Module-valvontayksikön poistamisen seurauksena syntyvä aukko on peitettävä suojalevyllä tai asentamalla uusi valvontayksikkö entisen tilalle. Muussa tapauksessa ilmavirran kulku saattaa häiriintyä, mikä heikentää jäähdytystä merkittävästi.

---



---

**FORSIGTIG:** Når LS Module er fjernet, skal det hul, der opstår, dækkes. Det gøres enten ved at påsætte en udstanset plade eller ved at installere en anden LS Module til erstatning. Hvis du ikke gør det, kan det give forstyrrelser i luftstrømningerne og reducere afkølingen alvorligt.

---

# WARNING

---

**OBS:** Når en LS Module er fjernet, må hullet blokkeres ved å installere en maskeringsplate eller ved å sette inn en annen LS Module. Dersom dette ikke gjøres, kan det forstyrre lufttilstrømningen og gi sterkt redusert kjøling.

---

---

**WARNING:** A possible shock hazard may exist in the area of the fan connection.

---

---

**VORSICHT:** Im Bereich des Lüftungsanschlusses besteht Stromschlaggefahr.

---

---

**WARNING:** Det finns risk för elstötår i området runt fläkanslutningen.

---

---

**VAARA:** Tuuletinliitännän ympäristössä voi olla sähköiskun vaara.

---

---

**ADVARSEL:** Der er fare for stød i området, hvor ventilatoren er tilsluttet.

---

---

**ADVARSEL:** Det kan være en viss risiko for elektrisk stød i nærheten av tilkoblingspunktet for viften.

---



## Appendix B: Technical Specifications

### Host Interface

- One or two Fibre Channel interfaces, 200MB\s each, 400 MB\s total.
- External hub and switch support.

### Disk Drive Interface

- Dual independent Fibre Channel interfaces, 200MB\s each, 400MB\s total.

### System

**Max drives per enclosure:** Up to 14 drives

**Max drives per subsystem:** Up to 112 drives

### Redundant, Hot Swappable Components

- Two power supplies, removable from the rear.
- Two advanced cooling modules, removable from the rear.
- Two loop resiliency and SES modules (LS), removable from the front.
- Up to 14 disk drives, removable from the front.
- Two independent AC power inlets.

## Physical Dimensions

**Deskside Enclosure**      Height: 20 inches (50.8cm)  
Width: 9 inches (22.9cm)  
Depth: 20 inches (50.8cm)  
Weight: 60 lbs (29.5kg) maximum

**Rack Enclosure**      Height: 5.22 inches (13.3cm)  
Width: 17.5 inches (44.5cm)  
Depth: 20 inches (50.8cm)  
Weight: 60 lbs (29.5kg) maximum

## Warranty

Three (3) years (5 years disk drive warranty)

## Monitoring

Temperature, advanced cooling modules, power supplies, disk drives, loop resiliency modules, I/O modules

## Failure Notification

In-band reporting SES; LEDs; audible alarm; Sphas Storage Management software.



## Disk Drives

<b>Rotational Velocity:</b>	10K; 15K
<b>Form factor:</b>	3.5"
<b>Height:</b>	1.0"
<b>Interface:</b>	Fibre Channel (2Gb FC support)

## Power Supply

### AC Power Supply Input

<b>Input Voltage:</b>	85 - 264 VAC
<b>Current Rating</b>	10 - 5 Amps
<b>Input Frequency:</b>	47 - 63 Hz
<b>Max. Peak Output Power</b>	853 Watts
<b>Max. Average Output Power</b>	673 Watts

## Temperature

- Operating Temperature: 5°C to 40°C
- Temperature Storage: -40°C to +70°C
- Maximum rate of temperature change: 20°C per hour

## Humidity

- Relative Humidity Operating: 10% to 80%, non-condensing
- Max. Rate of Operational Humidity Change: 10% per hour
- Relative Humidity Storage: 5% to 95%, non-condensing

## Altitude

- Altitude Operating: -200 to 10,000 feet
- Altitude Storage: -200 to 40,000 feet

## Operational Shock

Half sine shock: 3G half sine shock with a pulse duration of 11 milliseconds or less. No permanent damage will occur at or below this level.

## Operational Vibration

Sinusoidal vibration from 5 to 350 Hz at 0.2G (0 to peak) at a sweep rate of 1/2 octave per minute. No permanent damage will occur at or below these levels.

## Regulatory Agency Compliance

### Product Safety Standards

- UL1950 Information Technology Equipment (US)
- CSA C22.2 No 950 Information Technology Equipment (Canadian Law)
- EN 60950 Information Technology Equipment (European Norm)

### Product Safety Third Party Certifications

- UL Listed USA
- CSA Certification Canada
- CB Certificate and Report from NEMKO
- NEMKO Norway
- TUV-GS German

### CE Mark

Emission Testing: Light Industry CENELEC EN 50 081-1,1995

- Radiated Emissions CENELEC EN 55 022, 1992
- Conducted Emissions CENELEC EN 55 022, 1991

Immunity Testing: CISPR 24 for ITE

Immunity Testing: Light Industry CENELEC EN 50 082-1, 1997

- Electrostatic Discharge CENELEC EN 61000-4-2, 1995
- Radiated Immunity CENELEC EN 61000-4-3
- Electrical Fast Transients (Burst) CENELEC EN 61000-4-4 1995
- Transient (Surge) CENELEC EN 61000-4-5,1995
- Conducted Immunity CENELEC EN 61000-4-6
- Power Line Interruption CENELEC EN 61000-4-11

### Electromagnetic Radiation

- United States FCC Part 15 Class A, Computing Equipment
- Canadian DOC, Data Processing Equipment



## Appendix C: Configuration Loop Diagrams

Loop Diagram for a Single Enclosure System - Single Loop

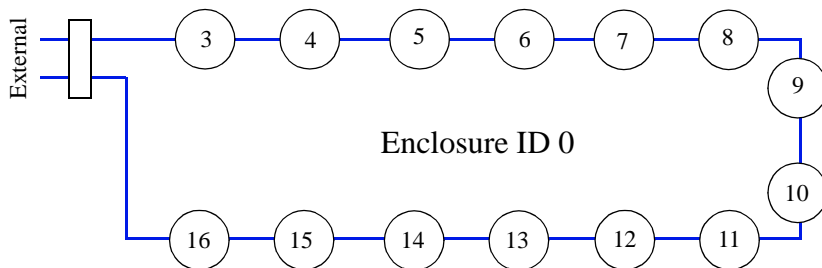

Circles denote disk drives with drive ID shown.

## Loop Diagram for a Dual Enclosure System - Single Loop

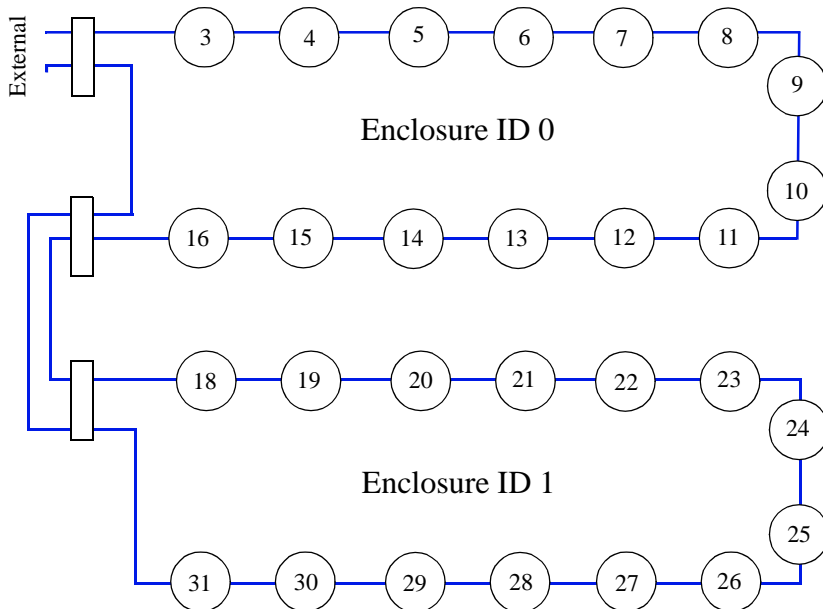

Circles denote disk drives with drive ID shown.

## Loop Diagram for a Single Enclosure System - Dual Loop

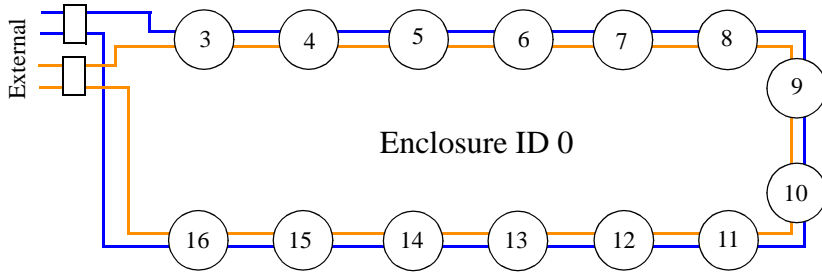

Circles denote disk drives with drive ID shown.

## Loop Diagram for a Dual Enclosure System - Dual Loop

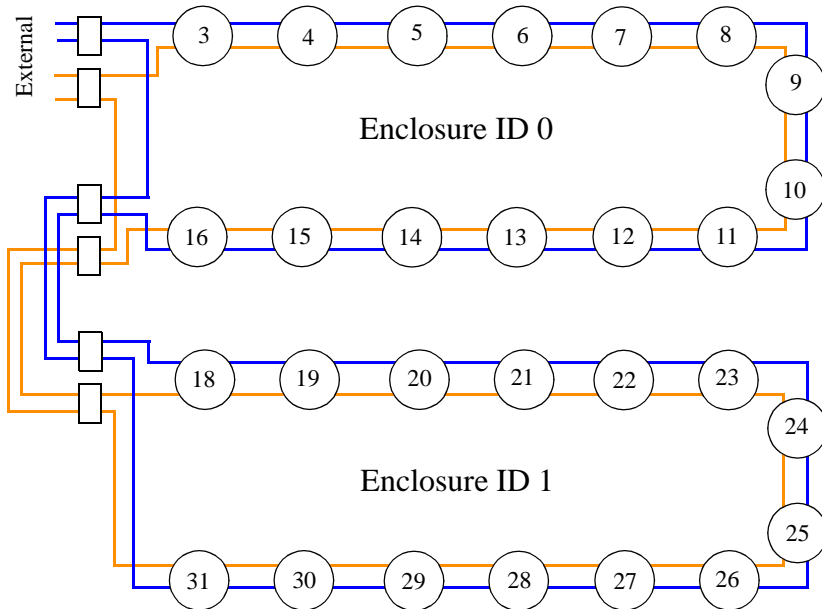

Circles denote disk drives with drive ID shown.



## Appendix D: Upgrading a 2Gb SANbloc JBOD Array to a RAID Array

In this section the procedure for upgrading a 2Gb SANbloc Series Storage Array from a JBOD system to a RAID system is described. The equipment and parts necessary for the upgrade are also described.

### Equipment and parts necessary for upgrade

The following is a list of the equipment and parts required for the upgrade from JBOD to RAID:

- Anti-static wrist strap and properly earthed grounding wire.
- Phillips head screw driver.
- 2Gb SANbloc RAID Controller (2 controllers if dual controller operation is required)
- FC host cables to connect RAID controller to host/hub/switch

### Upgrading from JBOD to RAID

---

**CAUTION:** *Before beginning the upgrade, ensure that anti-static precautions are taken. The minimum requirement is an anti-static wrist strap and grounding wire.*

---

- 1 Shut down the system and remove the power cables from the rear of the enclosure.
- 2 Using the Phillips head screwdriver, loosen the screws securing the I/O Module in the enclosure.
- 3 Using the handle on the module remove the I/O Module from the enclosure.
- 4 Into the I/O Module slot install the RAID controller and secure in place by tightening the screws using the Phillips head screw-

driver.

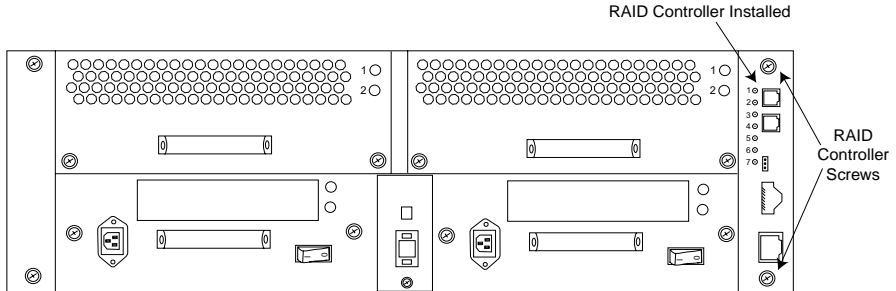

- 5 If you are upgrading to a dual RAID configuration then repeat steps 2 through 4 to install the second RAID controller.
- 6 Attach the host cable(s) to the host connector on the RAID controller and attach the other end of the cable(s) to your HBA/hub/switch (refer to Chapter 4 for more details).

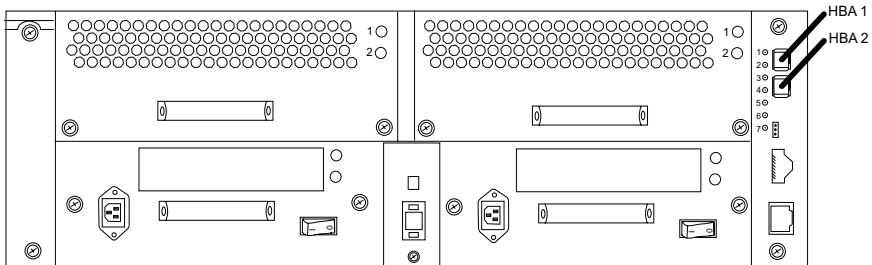

- 7 Install the battery backup unit as described below.
- 8 Re-attach the power cables and switch on the enclosure.
- 9 You can now configure your RAID system using the Management Software supplied.

## Installing the Battery Backup Unit

The battery backup unit (BBU) for the RAID controller is installed on the ACM unit (see Figure D-1).

**Figure D-1** Location of Battery Backup Unit on ACM

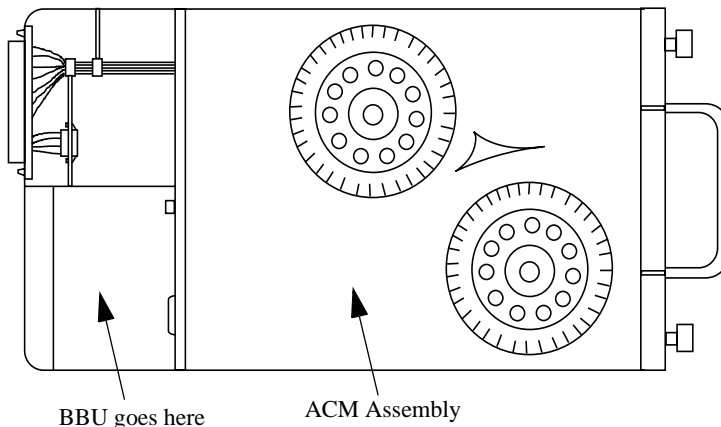

Follow this procedure to install the Battery Backup Unit (BBU):

- 1 Remove the ACM from the enclosure by loosening the two ACM screws and using the handle, slide the ACM out of the enclosure.
- 2 Lay the ACM on a flat surface as in Figure D-1 above.
- 3 Orient the BBU as shown (see Figure D-2).

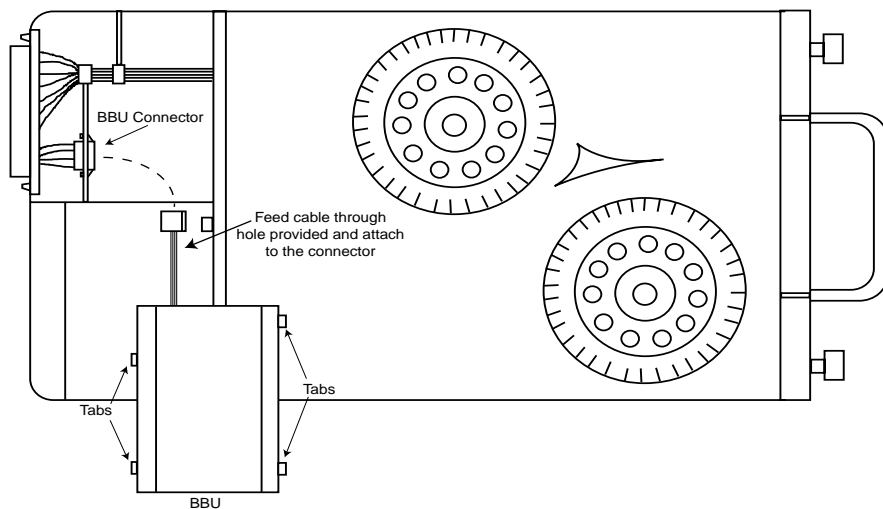
**Figure D-2 Installing the BBU**

- 4 Feed the BBU cable through the hole provided and connect it to the BBU connector (see Figure D-2).
- 5 Press the BBU into position and secure it by ensuring the four tabs “click” into place.
- 6 Replace the ACM in the enclosure and tighten the ACM screws to complete the installation.

**A**

advanced cooling module, leds, 72  
 advanced cooling modules, 21, 81, 82  
 air flow, 31  
 ambient temperature, 30  
 audience, 13

**B**

battery backup unit (BBU) 107  
 battery backup unit, location 107

**C**

cabling, dual i/o module, 41  
 circuit overloading, 32  
 communication, esi, 65  
 compliance, agency, 99  
 conventions, 13  
 current, input, 32

**D**

daisy chaining, 42, 57, 60  
 dimensions, 96  
 disk drive spin up sequence 46, 63  
 disk drive, carrier, 20, 77  
 disk drive, leds, 69  
 disk drives, 97  
 dual i/o module, configuration, 41  
 dual raid controller configuration

59

**E**

enclosure id, 37, 53  
 expansion modules, 22

**F**

fans, 21  
 fcc statement, 14  
 features, 19

**H**

hot swappable, 95  
 humidity, 97

**I**

i/o modules, 83  
 i/o modules, copper hssdc, 22  
 id settings, 37  
 id table, 39, 55  
 installation, 27  
 interface, disk drive, 95  
 interface, host, 95

**L**

leds, enclosure, 66, 68  
 leds, ls module, 66  
 loading racks, 31

110

loop resiliency and ses module, 65  
ls module, 79

## M

modulo 8 63  
monitoring, system, 65, 96

## N

notification, 96

## O

operating temperature, 30

## P

port bypass circuits, 65  
power consumption 32  
power output 20  
power rating, 32  
power source 62  
power supplies, 20, 81, 97  
power supplies, leds, 71

## R

rack mounting, 30  
raid, 45  
redundancy, 95  
regulatory agency, 99

## S

safety statements, 16, 28  
safety statements, translations, 28, 85  
shock, operational, 98  
single i/o module, configuration, 41  
single raid controller configuration 56  
specifications, technical, 95  
spin up sequence 46, 63  
support, 5, 14

## T

technical specifications, 95  
temperature, 30, 97  
translations, safety statements, 85

## U

unpacking, 30  
upgrading jbod to raid 105

## V

vibration, operational, 98

## W

warranty, 3, 96  
world wide support centre, 14

## Free Manuals Download Website

<http://myh66.com>

<http://usermanuals.us>

<http://www.somanuals.com>

<http://www.4manuals.cc>

<http://www.manual-lib.com>

<http://www.404manual.com>

<http://www.luxmanual.com>

<http://aubethermostatmanual.com>

Golf course search by state

<http://golfingnear.com>

Email search by domain

<http://emailbydomain.com>

Auto manuals search

<http://auto.somanuals.com>

TV manuals search

<http://tv.somanuals.com>