

ADCOM

OWNER'S MANUAL

GFA-7805 & GFA-7807



Multi-channel High-Current Power Amplifiers

WELCOME

Dear fellow ADCOM product owner,

Welcome to the ADCOM family! For more than twenty years, ADCOM products have delivered excellent performance and value for customers around the world. Our products are designed by our experienced and demanding engineering team, built to the highest standards in our factory, and sold and serviced through dealers, custom installers, and other retailers whose primary goal is your complete satisfaction.

We know you are anxious to hear your new amplifier in action, but please take a few minutes to read this owner's manual before connecting the amplifier to your system. Because ADCOM amplifiers can put out tremendous power, it is particularly important that you connect your amplifier to your pre-amplifier and speakers while the amplifier is unplugged and your other equipment is turned off. This will protect the amplifier and other equipment from potential short circuits that may occur during installation. In addition, it is important that you allow for adequate ventilation around your amplifier and other equipment, since excessive heat buildup can shorten the life of any electronic product, including the amplifier. Once you have correctly connected your pre-amplifier and speakers to your new amplifier, you should be able to enjoy many trouble-free years of performance.

We conduct a thorough quality and performance test on each and every amplifier we build in our factory prior to shipment. In the rare case of a defect that may occur after shipment, we stand behind our amplifiers with a five-year parts and labor warranty. To register for this warranty, please complete and mail the enclosed warranty card back to ADCOM. Also, please keep a copy of your sales receipt with the owner's manual so you may provide proof of eligibility for the warranty should the need arise.

We know you will be very happy with the sound and performance of your new amplifier. We hope you will also consider other ADCOM products, such as our line of pre-amplifiers and DVD and CD players. In addition, we design and manufacture complementary products such as line conditioners/surge suppressors and speaker selectors. Please visit our web site, www.adcom.com, to learn more about our complete line of stereo, home theater, and distributed audio/video products.

On behalf of all of us at ADCOM, I want to thank you for selecting our product for your home or business entertainment system.

Sincerely,



Douglas Klein
President
ADCOM

TABLE OF CONTENTS

WELCOME	2
SAFETY INFORMATION	4
DESCRIPTION OF UNIT	
GFA-7805 FEATURES	5
GFA-7807 FEATURES	5
WARRANTY INFORMATION	5
INSTALLATION & HOOKUP	
UNPACKING THE GFA-7805/7807	6
INSTALLING THE GFA-7805/7807	6
OPERATION	
FRONT AND REAR PANEL DIAGRAMS	7
DESCRIPTION OF UNIT: REAR PANEL	8
DESCRIPTION OF UNIT: FRONT PANEL	8-9
CONNECTIONS DIAGRAM	10
CONNECTING THE GFA-7805/7807	11
TROUBLESHOOTING	
RESOLVING PROBLEMS	12
CARING FOR YOUR GFA-7805/7807	13
SERVICE INFORMATION	13
GFA-7805 SPECIFICATIONS	14
GFA-7807 SPECIFICATIONS	15

THE FOLLOWING PRECAUTIONS AND SAFETY INSTRUCTIONS ARE REQUIREMENTS OF UL AND CSA SAFETY REGULATIONS

Warning: To reduce the risk of fire or electric shock, do not expose this unit to rain or moisture.

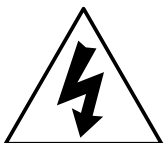
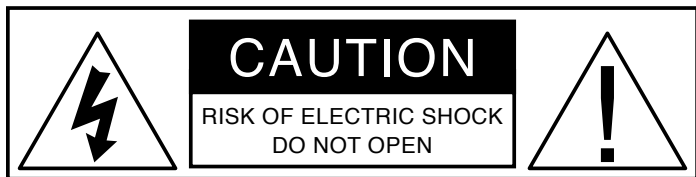

The graphic symbol of a lightning flash with an arrow point within a triangle signifies that there is dangerous voltage within the unit and it poses a hazard to anyone removing the cover to gain access to the interior of the unit. Only qualified service personnel should make any such attempt.



The graphic symbol of an exclamation point within an equilateral triangle warns a user of the device that it is necessary to refer to the instruction manual and its warnings for proper operation of the unit.

Do not place this unit on an unstable cart, stand, tripod, bracket, or table. The unit may fall, causing serious injury to a child or adult, and serious damage to the unit. Use only with a cart, stand, tripod, bracket, or table recommended by the manufacturer or sold with the unit. Any mounting of the device should follow the manufacturer's instructions, and should use a mounting accessory recommended by the manufacturer.

Read all the safety and operating instructions before connecting or using this unit.

Retain this notice and the owner's manual for future reference.

All warnings on the unit and in its operating instructions should be adhered to.

All operating and use instructions should be followed.

Do not use this unit near water. For example, near a bathtub, washbowl, kitchen sink, laundry tub, in a wet basement, or near a swimming pool.

The unit should be installed so that its location or position does not interfere with its proper ventilation. For example, it should not be situated on a bed, sofa, rug, or similar surface that may block the ventilation openings; or placed in a built-in installation, such as bookcase or cabinet, that may impede the flow of air through its ventilation openings.

The unit should be situated away from heat sources such as radiators, heat registers, stoves, or other devices (including amplifiers) that produce heat.

The unit should be connected to a power supply outlet only of the voltage and frequency marked on its rear panel.

The power supply cord should be routed so that it is not likely to be walked on or pinched, especially near the plug, convenience receptacles, or where the cord exits from the unit.

Clean unit only as recommended in its instruction manual.

The power supply cord of the unit should be unplugged from the wall outlet when it is to be unused for a long period of time.

Care should be taken so that objects do not fall, and liquids are not spilled, into the enclosure through any openings.

This unit should be serviced by qualified service personnel when:

- A. The power cord or the plug has been damaged; or
- B. Objects have fallen, or liquid has been spilled, into the unit; or
- C. The unit has been exposed to rain, or liquids of any kind; or
- D. The unit does not appear to operate normally, or exhibits a marked change in performance; or
- E. The device has been dropped, or the enclosure damaged.

**DO NOT ATTEMPT SERVICING OF THIS UNIT YOURSELF.
REFER SERVICING TO QUALIFIED SERVICE PERSONNEL.**

ATTENTION

POUR PREVENIR LES CHOCS ELECTRIQUES NE PAS UTILISER CETTE FICHE POLARISEE AVEC UN PROLONGATEUR, UNE PRISE CE COURANT OU UNE AUTRE SORTIE CE COURANT, SAUF SI LES LAMES PEUVENT ETRE INSEREES A FOND SANS EN LAISSER AUCUNE PARTIE A DECOUVERT.

CAUTION

TO PREVENT ELECTRIC SHOCK DO NOT USE THIS POLARIZED PLUG WITH AN EXTENSION CORD, RECEPTACLE OR OTHER OUTLET UNLESS THE BLADES CAN BE FULLY INSERTED TO PREVENT BLADE EXPOSURE.

CAUTION POWER LINES

Any outdoor antenna must be located away from all power lines.

OUTDOOR ANTENNA GROUNDING

If an outside antenna is connected to your tuner or tuner/preamplifier, be sure the antenna system is grounded so as to provide some protection against voltage surges and built-up static charges. Section 810 of the National Electrical Code, ANSI/NFPA No. 701984, provides information with respect to proper grounding of the mast and supporting structure, grounding of the lead-in wire to an antenna discharge unit, size of grounding conductors, location of antenna discharge unit, connection to grounding electrodes, and requirements for the grounding electrode.

- a. Use No.10 AWG (5.3 mm²) copper, No.8 AWG (8.4 mm²) aluminum, No.17 AWG (1.0 mm²) copper clad steel or bronze wire, or larger, as a ground wire.
- b. Secure antenna lead-in and ground wires to house with stand-off insulators spaced from 46 feet (1.221.83 m) apart.
- c. Mount antenna discharge unit as close as possible to where lead-in enters house.
- d. Use jumper wire not smaller than No.6 AWG (13.3 mm²) copper, or the equivalent, when a separate antenna grounding electrode is used. See NEC Section 810-21 (j).

EXAMPLE OF ANTENNA GROUNDING AS PER NATIONAL ELECTRICAL CODE INSTRUCTIONS CONTAINED IN ARTICLE 810. RADIO AND TELEVISION EQUIPMENT.

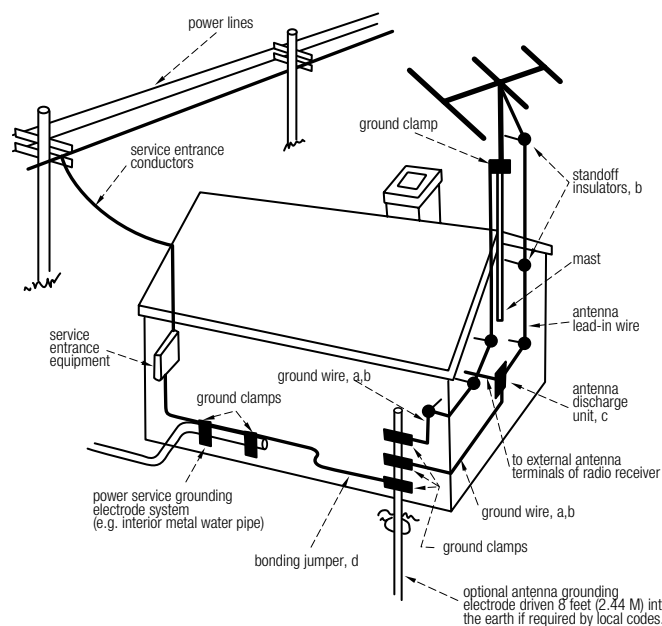

NOTE TO CATV SYSTEM INSTALLER

This reminder is provided to call the CATV system installer's attention to Article 82022 of the National Electrical Code that provides guidelines for proper grounding and, in particular, specifies that the cable ground shall be connected to the grounding system of the building, as close to the point of cable entry as practical.

GFA-7805 FEATURES

- Precision-matched devices used throughout the signal path
- 112,000 μF of power supply-filter capacitance to optimize transient response
- Independent power supplies for each channel
- Fewer gain stages improve signal reproduction accuracy
- Custom toroidal power transformer provides better regulation and greater peak current capability
- Independent thermal-overload and distortion LEDs for all 5 channels
- High quality, gold-plated 5-way binding posts
- Balanced XLR inputs
- High quality, gold-plated RCA jacks
- Large independent internal heatsinks for greater cooling capability of output devices
- Convenient 12V DC power ON/OFF triggering
- Heavy gauge, anodized aluminum front panel
- Powder-coated, baked chassis and top cover for greater durability
- Cooling vents for greater efficiency and cooler operation while driving low impedance loads
- Forced convection temperature sensitive cooling

GFA-7807 FEATURES

- Precision-matched devices used throughout the signal path
- 156,800 μF of power supply-filter capacitance to optimize transient response
- Independent power supplies for each channel
- Fewer gain stages improve signal reproduction accuracy
- Custom toroidal power transformer provides better regulation and greater peak current capability
- Independent thermal-overload and distortion LEDs for all 7 channels
- High quality, gold plated 5-way binding posts
- Balanced XLR inputs
- High quality, gold-plated RCA jacks
- Large independent, internal heatsinks for greater cooling capability of output devices
- Heavy gauge, anodized aluminum front panel
- Powder-coated, baked chassis and top cover for greater durability
- Cooling vents for greater efficiency and cooler operation while driving low impedance loads
- Forced convection temperature sensitive cooling

ADCOM PROTECTION PLAN (USA Only)

ADCOM offers the enclosed valuable Limited Warranty. Please read the details on the Warranty Card carefully to understand the extent of the protection offered by the Warranty, its reasonable limitations, and what you should do in order to obtain its benefits. Be sure to verify that the serial number printed on the rear panel matches the serial number on the outer carton. If any number is altered or missing, or if the ADCOM Warranty Card is not included in the carton, you should notify us immediately in order to ensure that you have received a genuine ADCOM product which has not been opened, mishandled, or tampered with in any way. **Always retain your original sales receipt as a proof of purchase.**

INTRODUCTION

Congratulations on your decision to purchase the GFA-7805 or GFA-7807 multichannel power amplifier. The GFA-7805 and GFA-7807 have been designed to be high performance and musically accurate in a configuration specifically designed to integrate with any audio pre-amplifier. You have made a wise choice that will reward you for years to come with exceptionally accurate and musical sound reproduction. To realize the full potential of your new amplifier, and before making any connections to it, please read these operating and installation instructions thoroughly.

UNPACKING THE GFA-7805/7807

Before your new ADCOM amplifier left our factory, it was carefully inspected for physical imperfections and tested for all electrical parameters as a routine part of ADCOM's systematic quality control. This, along with full operational and mechanical testing, should ensure a product flawless in both appearance and performance. After you have unpacked the GFA-7805/07, inspect it for physical damage. Save the shipping carton and all packing material as they are intended to reduce the possibility of transportation damage should the amplifier ever need to be shipped again. In the unlikely event damage has occurred, notify your dealer immediately and request the name of the carrier so a written claim to cover shipping damages can be initiated. **THE RIGHT TO A CLAIM AGAINST A PUBLIC CARRIER CAN BE FORFEITED IF THE CARRIER IS NOT NOTIFIED PROMPTLY IN WRITING AND IF THE SHIPPING CARTON AND PACKING MATERIALS ARE NOT AVAILABLE FOR INSPECTION BY THE CARRIER. SAVE ALL PACKING MATERIALS UNTIL THE CLAIM HAS BEEN SETTLED.**

INSTALLING THE GFA-7805/7807

During normal home operation the internal heatsinks of the GFA-7805/7807 may become warm. However, there are instances during high-level playback into low impedances when the heatsinks will become much warmer than usual. To ensure the amplifier's long-term, trouble-free operation it is necessary to provide adequate ventilation for the heatsinks. Therefore, the GFA-7805/7807 should be kept away from external sources of heat such as radiators and hot-air ducts. The GFA-7805/7807 should never be placed with other heat-producing components in a cabinet or enclosure lacking free air flow. The top and bottom panel of the amplifier's chassis have been provided with vents to allow the necessary cooling of the internal components. It is imperative that these vents are not obstructed in any way.

We recommend that you do not stack other components on top of the GFA-7805/7807. This is particularly important if your system includes low-impedance loudspeakers which are difficult to drive, or if you will consistently demand high volume levels from the amplifier and speaker system. Not only will heat generated by the amplifier affect the performance of equipment stacked on top of the GFA-7805/7807, but the free flow of air through the ventilating slots in the amplifier may be partially obstructed.

If you observe these recommendations, the GFA-7805/7807 will perform reliably in any reasonable environment. You should also pay attention to such normal considerations as protection from excessive dust and moisture. Occasional vacuuming of accumulated dust on the chassis, panels and around the ventilating slots should be all that is required.

The optimal performance of your new GFA-7805/7807 will ultimately depend on the care with which you make the connections between the amplifier, pre-amplifier, surround sound decoder and the loudspeakers. All input and output signal connections should be made only with high quality, low-loss, low capacitance cables following the recommendations in the Inputs and Outputs section of **CONNECTING THE GFA-7805/7807**.

GFA-7807 REAR PANEL

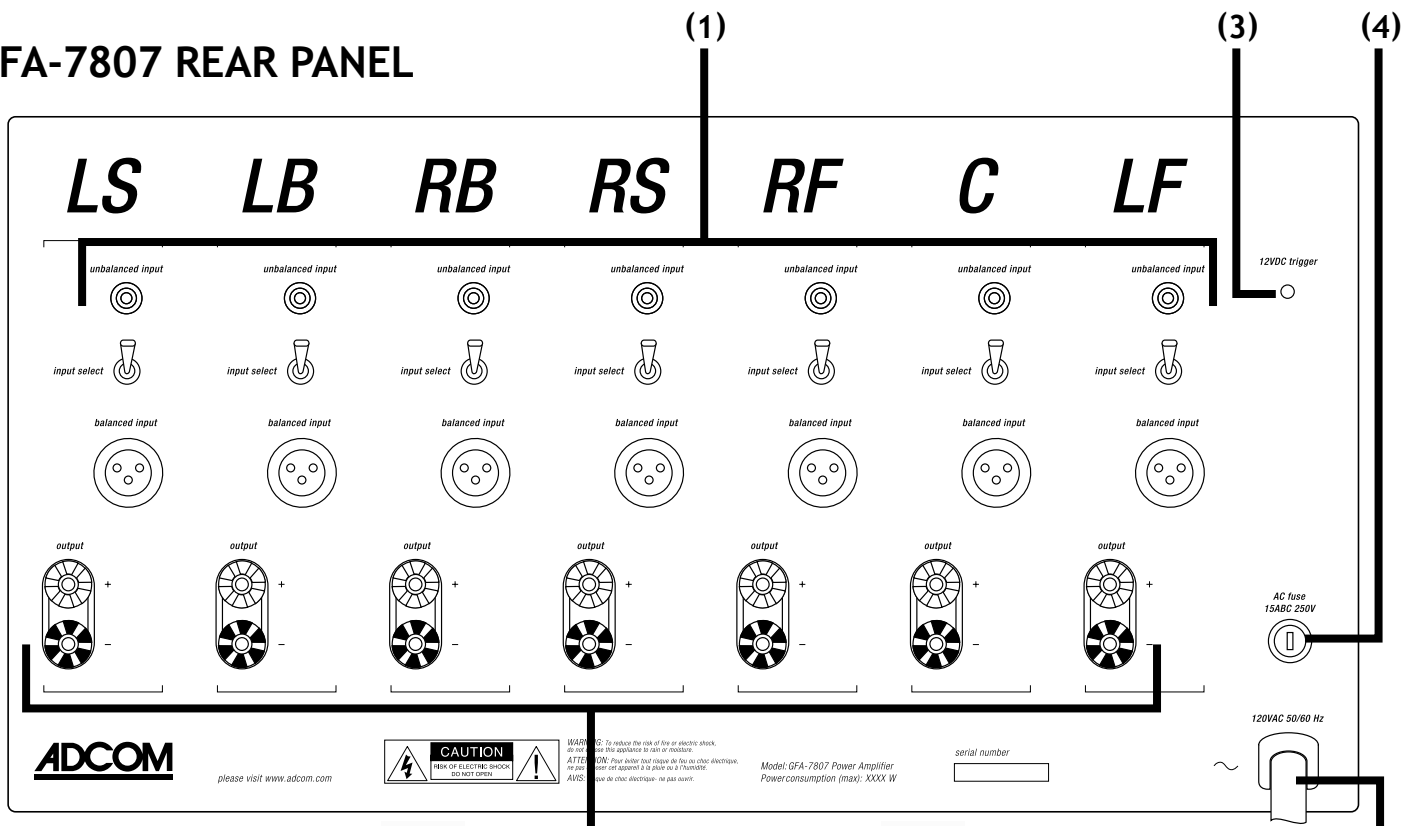

GFA-7807 FRONT PANEL

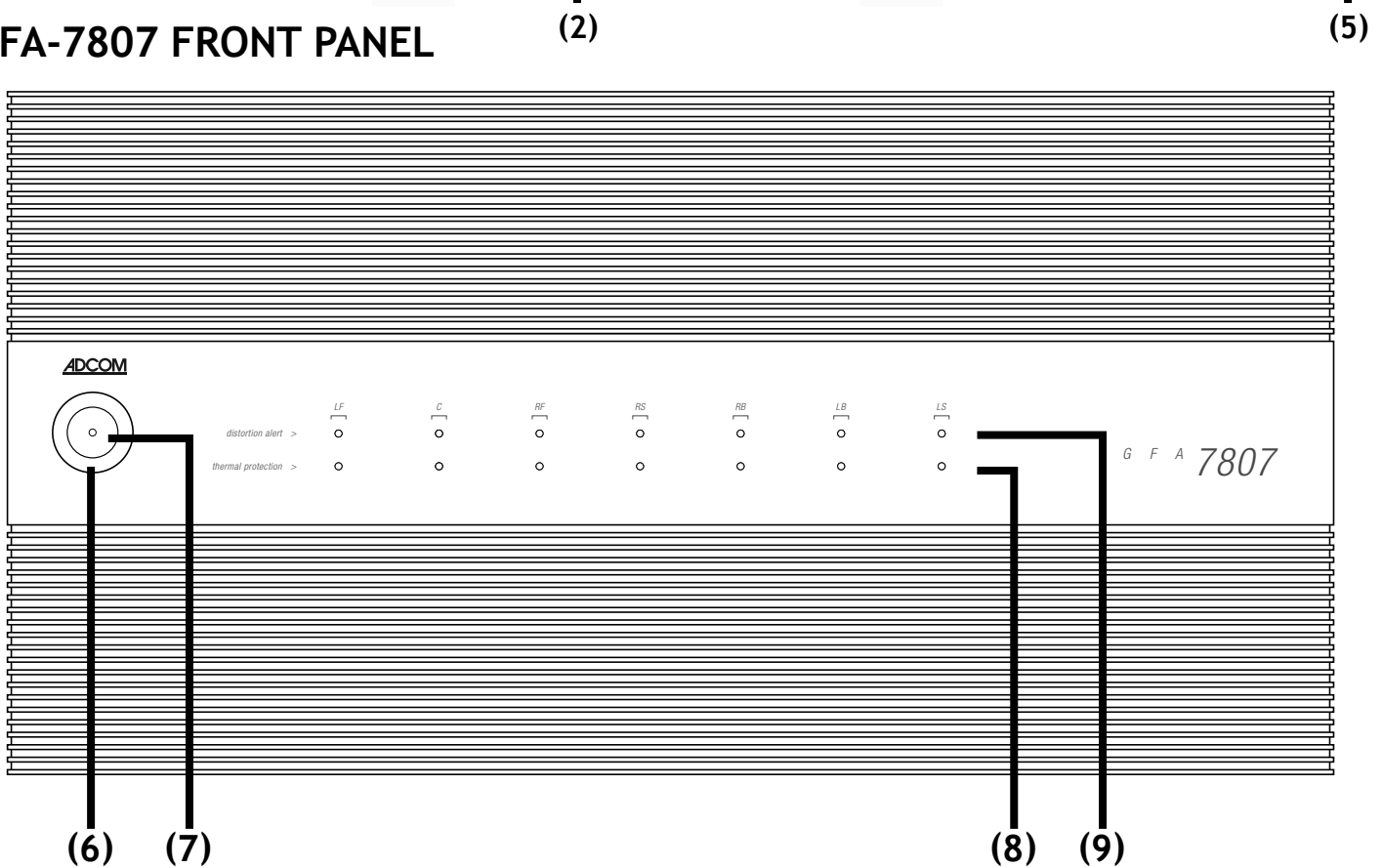

(1) Input Jacks

(2) Output Binding Posts

(3) 12V DC Trigger

(4) AC Fuse

(5) AC Power Cord

(6) On/Off Switch

(7) Power LED

(8) Thermal Protection LEDs

(9) Distortion Alert LEDs

DESCRIPTION OF UNIT: REAR PANEL

(1) Inputs

The GFA-7805 and GFA 7807 have both balanced and unbalanced inputs for each channel. The unbalanced connection is made via the gold plated RCA jack and the balanced connection is made via the XLR input connection. Each channel also has a switch which selects the type of input for each channel. Make sure the switch is in the appropriate position for the type of connection you have chosen. For best performance, always use high quality interconnects. Your ADCOM dealer can help select the best cable for your needs.

(2) Outputs

The GFA-7805's and GFA-7807's connections to the loudspeakers are made through high-grade, 5-way, gold-plated binding post terminals. There are two terminals for each speaker, which are colored RED for the positive (+) output and BLACK for the negative (-) output.

The binding posts will accept a variety of connector types. The most secure and prevalent of these is the "U"-type spade connectors (at least 0.25" wide and maximum width of 0.57"). The terminal will also accept bare wire (up to AWG10) and "banana" type plugs (single or dual).

(3) 12V DC Trigger

The GFA-7805 and GFA-7807 are very high power amplifiers and as such must be directly connected to the wall outlet or an appropriate surge protector or AC line conditioner. It must never be connected to the 'switched' outlets on the rear panel of a pre-amplifier. Usually this would mean that when you turn on/off your pre-amplifier you would have to turn on/off your power amplifier separately. We have, however, provided the ability to control the OFF/ON function of the GFA-7805/7807 by a 12V DC output jack on the rear of certain ADCOM pre-amplifiers. When using this feature the front panel Power Switch must be left in the in "on" position. To connect the preamplifier 12V DC output jack to the amplifier 12V DC jack, you will need a monaural mini phone plug to monaural mini phone plug cable. Contact your dealer for information on using this feature with ADCOM and other brand pre-amplifiers.

(4) AC Fuse

The AC Fuse protects the electronic circuits of the GFA-7805/7807. This fuse, normally, will fail only if there

is an overload within the GFA-7805/7807. If your fuse fails please contact your dealer or ADCOM directly for a replacement or servicing.

(5) AC Power Cord

The AC cord provides power to operate all the GFA-7805/7807's circuits. Its plug can be connected to a standard wall outlet provided the outlet supplies a voltage compatible with the power requirements printed on the rear panel of the GFA-7805/7807.

DESCRIPTION OF UNIT: FRONT PANEL

(6) On/Off Switch

The On/Off Switch controls power to the power transformer and circuits of the GFA-7805/7807. Whenever the GFA-7805/7807 is energized the Power LED (7) will glow. To turn the GFA-7805/7807 on, press the push-button. It will remain in the "engaged" position while the unit is energized. To turn the GFA-7805/7807 off, press the push-button in and release and it will move to the "disengaged" position.

(7) Power LED

This LED will glow whenever the On/Off Switch (6) is turned on and the GFA-7805/7807 is energized. The Power LED indicates that there is AC voltage being fed to the amplifier, but it does not signify that all the amplifier's circuits are in operation. If, for example, one of the Thermal Protection LEDs (9) glows, that amplifier channel will not produce sound even though the Power LED may still glow. When the GFA-7805/7807 is turned off, the Power LED will take some time to fade out completely. It may take up to 30 seconds to fully extinguish.

Additionally, the internal power transformer is provided with a thermostat which will interrupt power into the transformer if its temperature exceeds 125°C. This high temperature will seldom, if ever, be encountered unless the amplifier is subjected to abnormal conditions, such as operation into loads of less than 3 ohms at very high listening levels, etc. If the AC Fuse (4) has not failed, the Power LED is out, and the Thermal Protection LED (9) does not glow, this would indicate that the thermostat within the transformer has opened.

Once the temperature within the transformer decreases to a normal level, the thermostat will reset itself

automatically and normal operation will resume. If you are to avoid tripping the thermostat in the transformer continually, you must reduce the sound level demands, correct the load impedance of the loudspeakers, or both.

(8) Thermal Protection LEDs

The GFA-7805/7807 are provided with a thermal protection circuit which will shut down the individual amplifiers if its heatsink temperature reaches 85°C. The Thermal Protection LEDs will light whenever the thermal protection circuit in its respective channel has been triggered and the amplifier is inoperative. The thermal protection circuitry will typically be triggered by very high power demands into impedances much lower than the amplifier is capable of driving at those levels. If any amplifier channel's output through the loudspeaker(s) ceases abruptly, and its Thermal Protection LED glows, you will know that its heatsink temperature has become unacceptably high and the circuitry is protecting the amplification devices. Please note that the Power LED (7) will remain on and the amplifier will still be energized. Once the temperature of the heatsink(s) drops to a safe operating level, that amplifier will automatically resume operation.

Activation of the Thermal Protection circuitry in any of the amplifiers in the GFA-7805/7807 is an indication that the amplifier has been over-driven or that the load the loudspeakers are presenting to the amplifier is unreasonably low. If you wish to prevent recurrent activation of the thermal protection circuitry, you must reduce the volume-level demands or correct the load impedance condition which may be causing activation of this circuitry.

(9) Distortion Alert LEDs

The Distortion Alert circuit is a unique ADCOM distortion detection system which reads all forms of non-linear distortion such as THD, IM, slew-induced, "clipping," etc. The Distortion Alert LEDs will light when distortion reaches approximately 1% regardless of impedance, voltage/current phase angle or the reactance of the loudspeakers which the amplifier is driving. Sometimes, when the amplifier is in use, the LEDs may occasionally flicker during high volume listening, particularly if you are driving low impedances. This flickering is no cause for concern. The LEDs are simply warning you that the amplifier is approaching its maximum power output into the particular loudspeakers you are using. If, however, the Distortion Alert LEDs glow brightly or are illuminated most of the time during playback, you are over driving the amplifier and should turn down your volume control to reduce the listening level, otherwise it may cause the Thermal Protection to be activated or, in extreme cases, damage your loudspeakers.

WARNING

WHENEVER CONNECTIONS TO OR FROM THE GFA-7805 & GFA-7807 ARE BEING MADE, BE CERTAIN THAT THE AC ON/OFF SWITCH OF THE AMPLIFIER IS IN THE OFF POSITION, THE AC CORD OF THE AMPLIFIER IS DISCONNECTED FROM THE AC WALL OUTLET AND THAT ALL ASSOCIATED COMPONENTS ARE OFF.

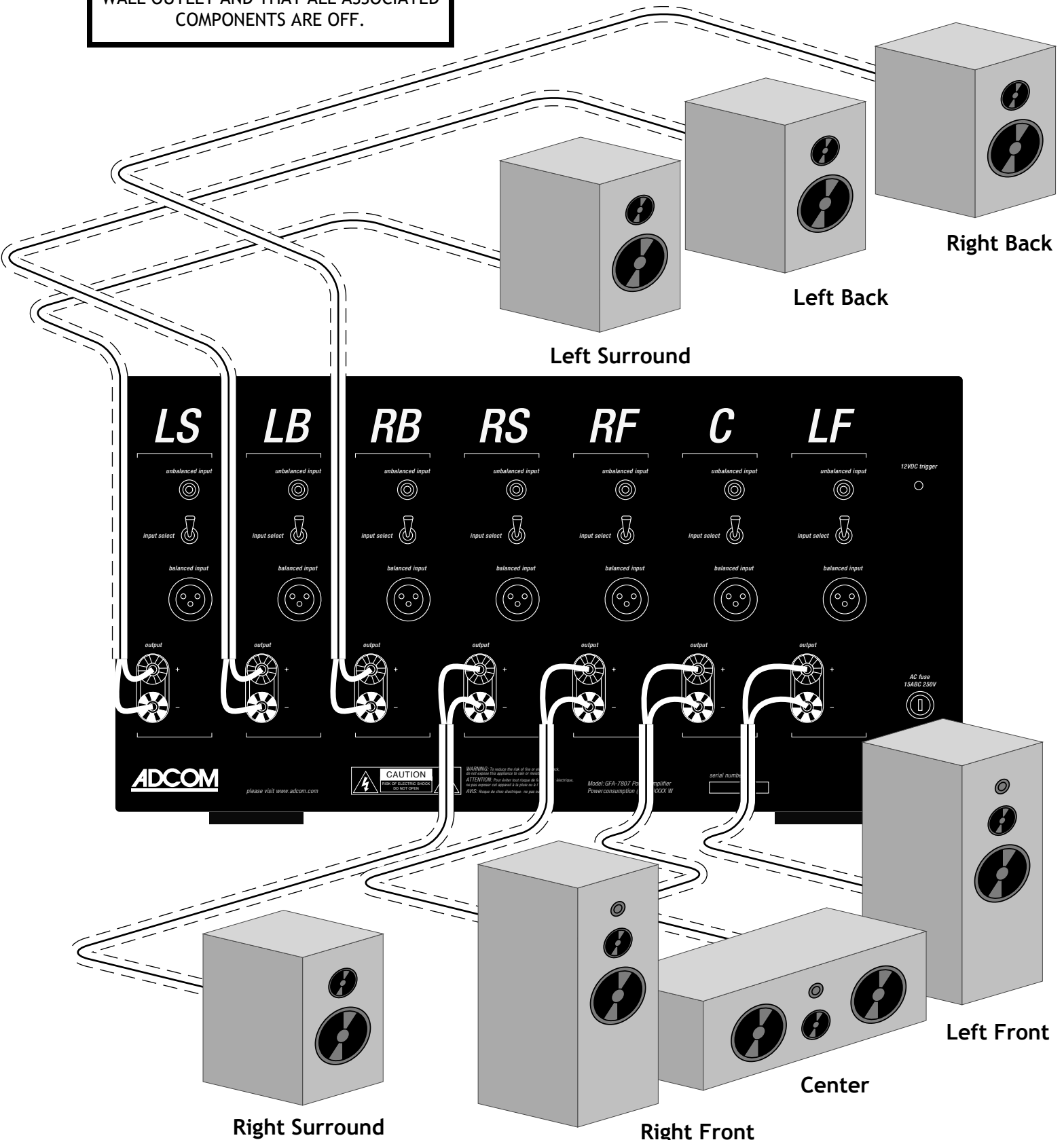

CONNECTING THE GFA-7805/7807 TO YOUR SPEAKERS

When connecting the amplifier to the loudspeaker, it is vital to maintain proper polarity (positive to positive, negative to negative). On the GFA-7805/7807, the positive terminal is color coded RED and labeled "+," and the negative is color coded BLACK and labeled "-". The positive terminal on the speaker will be color coded RED, or will be labeled "+," "pos," "positive," "8 ohms" or "4 ohms." The negative terminal on the speaker will be color coded BLACK, or will be labeled "-", "neg," "negative," "C," "Common," "G," or "ground."

We recommend that your speaker cables be terminated with "U" type spade connectors. These will give the most contact area insuring long-term reliability. The spade connector should have a maximum width of 0.57 inches and an opening width of no less than 0.25".

To properly connect the speaker cable to the binding posts, turn the insulated head of the binding post clockwise until the wire or connector is firmly secured. Finger pressure is sufficient and you should not use pliers or other tools which could damage or over-tighten the binding-post assembly. The binding posts have been designed in such a way that finger pressure is all that is required to cause a "pinching" action among the different metal surfaces to ensure proper connection.

It is very important to use the correct size of wire in order to avoid unnecessary loss of amplifier power in the cable, reduction of amplifier damping factor and other undesirable conditions. Sound audio engineering practice suggests the use of at least AWG16, stranded, copper cable. Recommended capacitance of the speaker wire should not exceed 50pF per foot. This insures high frequencies will not be rolled off.

All loudspeakers having a nominal impedance down to 4 ohms can be connected to and driven by the GFA-7805/7807. The amplifier can drive these low-impedance speakers at more than adequate power levels with no difficulty. It should be noted that many loudspeaker systems which are nominally rated at 4 ohms drop in impedance, in some parts of their frequency range, to as low as 2 ohms (and sometimes less). You will not experience difficulties even with these very low impedance loads unless you demand excessively high volumes levels from your system.

We do not recommend that you run additional sets of speakers to the GFA-7805/7807. If you choose to add remote speakers in another room, we strongly suggest that a switching system to disconnect the non-home-theater speakers be incorporated when the surround sound (home theater) mode is in operation. A device such as the ADCOM GFS-3 or GFS-6 speaker selector is recommended. A Speaker Selector enables you to maintain good sonic integrity while giving you the flexibility to add speakers throughout your house.

We suggest that you follow this chart below for maximum speaker lengths and minimum wire gauges. If longer runs are needed, we recommend that you consult with your ADCOM Dealer to maximize the performance of your system for your exact conditions.

up to 24 feet	AWG16
---------------	-------

up to 36 feet	AWG14
---------------	-------

up to 58 feet	AWG12
---------------	-------

RESOLVING PROBLEMS

Use the chart below to solve common situations that don't require professional attention. If the steps stated in POSSIBLE SOLUTION do not resolve your problem, then please contact your ADCOM Dealer or call the ADCOM Customer Service Department. Any problems not covered here should be brought to the attention of your ADCOM Dealer or ADCOM Customer Service Department.

SYMPTOM	POSSIBLE REASON	POSSIBLE SOLUTION
Power LED does not glow. No sound	AC Power Cord(s) not plugged in. AC Fuse(s) failed. Transformer thermal protection engaged. 12V DC triggering malfunctioning.	Plug in AC Power Cord(s). Replace AC Fuse(s). Wait until unit cools down. It will reset. Reset power switch manually. Check connection of 12V DC trigger at source.
Power LED glows, but no sound	Preamp or source unit is not on. Connections in rear of amp are loose.	Make sure whole system is on. Verify all connections on rear of amp.
One channel not producing sound	INPUT(s) or OUTPUT(s) connector disconnected or loose. Speaker disconnected. Internal protection engaged.	Verify both connections on that channel. Verify connection at speaker. Bring to Dealer or Service Center.
Hum from all speakers at any volume	Ground loop (difference in ground voltages between components).	If Cable TV is present (see Note 1). If Cable TV is not present (see Note 2).
Hum from all speakers (hum goes up or down with volume)	Problem with source unit (CD, tape, etc.), or RCA cable connecting that source unit to the preamp.	Try different source (tuner, tape, etc.) and/or different RCA cable.
Hum from the amplifier itself	Some major appliance, dimmer, halogen or fluorescent light is creating interference.	Make sure all appliances, dimmers and suspect lights are off.

A special note on "hum:" When there is a low-volume "hum" audible throughout your speakers, even with the main volume turned all the way down, you have a common phenomenon known as a "ground loop." A ground loop is basically a difference in ground voltages between two or more components which are connected electrically and which creates multiple current paths where there must only be one. This difference in potentials creates a 60Hz low-level sound (approximately a low A), that seems to "hum."

It can be caused by adding new components to your system, but that does not imply there is anything electrically wrong with any new component. With the advent of audio/video and home theater systems, the problem has become commonplace. Generally, the cause is the Cable-TV incoming signal line. This new incoming line may add an additional ground at a different potential to the AC line ground of your other equipment (refer to Note 1 and 2, to troubleshoot a hum problem).

Note 1: Cable TV systems can sometimes contribute to ground loop problems which cause "hum." To determine if your cable system is the contributing factor, disconnect the Cable-TV incoming signal line (round, 75Ω) at the wall, or the first component the cable is connected to (i.e. the cable box, or VCR). If the hum is no longer present, you must insert a "75Ω Ground Loop Isolator" before reconnecting the line. You should check with your ADCOM Dealer to obtain one. If the "75Ω Ground Loop Isolator" works only partially or not at all, then please read Note 2 to complete the troubleshooting procedure.

Note 2: Make sure that the power amplifier is at least 6" from the Preamp and/or Processor. Usually putting another component between them is sufficient to minimize the hum. If this does not reduce the hum, turn the system off and disconnect all Inputs from the amplifier. If the hum still persists, then your Dealer or Service Center must examine the amplifier. If the hum disappears, try another set of RCA cables. Connect one RCA cable at a time to see if one specific cable is responsible. If any or all cables cause the hum to appear, then the preamp or processor should be evaluated for proper operation by your Dealer or Authorized Service Center.

CARING FOR YOUR GFA-7805/7807

Great care has been taken by ADCOM to ensure that your amplifier is as flawless in appearance as it is electronically. The front panel is a heavy-gauge, high-grade aluminum extrusion carefully finished and anodized for durability. The chassis, top cover and rear panel are heavy-gauge steel that has been powder coated and baked to ensure a lasting finish. If the front panel, top or sides become dusty or fingerprinted, they can be cleaned with a soft lint-free cloth, slightly dampened with a very mild detergent solution or glass cleaner.

Do not spray or pour liquids of any kind directly onto the GFA-7805/7807.

SERVICING

ADCOM has a Technical Service Department to answer questions pertinent to the installation and operation of your unit. In the event of difficulty, please contact us for prompt advice. If your problem cannot be resolved through our combined efforts, we may refer you to an authorized repair agency, or authorize return of the unit to our factory. To aid us in directing you to a convenient service center, it would be helpful if you indicate which major city is accessible to your home.

Please address mail inquires to:

**ADCOM Service
8551 East Anderson Drive, Suite 105
Scottsdale, Arizona 85255 USA**

Phone, Fax or Email inquires to:

**Voice: (480) 607-2277
Fax: (480) 348-9876
Monday through Friday
9:00 AM to 5:00 PM MST
Email: service@adcom.com**

For Fax inquires, please include a return Fax number for the reply. When calling or writing about your GFA-7805/7807, be sure to note and refer to its serial number as well as the date of purchase and the dealer from whom it was purchased. In any communications to us, please include a daytime phone number where we may reach you. In the event the unit must be returned to our factory for service, you will be instructed on the proper procedure when you call or write for a Return Authorization. **UNDER NO CIRCUMSTANCES SHOULD YOUR UNIT BE SHIPPED TO OUR FACTORY WITHOUT PRIOR AUTHORIZATION, OR PACKED IN OTHER THAN ITS ORIGINAL CARTON AND FILLERS.**

If the original shipping carton and its fillers have been lost, discarded, or damaged, a duplicate carton may be obtained from our Service Department for a nominal charge.

Always ship PREPAID VIA UNITED PARCEL SERVICE (UPS) OR OTHER APPROVED CARRIER. DO NOT SHIP VIA PARCEL POST, since the packing was not designed to withstand rough Parcel Post handling.

**FREIGHT COLLECT SHIPMENTS WILL NOT BE ACCEPTED
UNDER ANY CIRCUMSTANCES.**

GFA-7805 SPECIFICATIONS

Power Rating (To EIA/CEA-490-A Requirements)

300 Watts continuous average power per channel into 8 ohms at any frequency between 20Hz and 20kHz with all channels driven at less than 1.00% THD.

450 Watts continuous average power per channel into 4 ohms at any frequency between 20Hz and 20kHz with all channels driven at less than 1.00% THD.

THD + Noise at 300 watts into 8 Ohms (Typical)

20Hz.	0.012%
1kHz.	0.135%
10kHz.	0.12%
20kHz.	0.12%

THD + Noise at 450 watts into 4 Ohms (Typical)

20Hz.	0.3%
1 kHz.	0.3%
10kHz.	0.27%
20kHz.	0.1%

Frequency Response @ 1 Watt into 8 Ohms

10Hz to 20kHz.	+0, -0.25dB
---------------------	-------------

Power Bandwidth (-3d B).	3Hz to 130kHz
-------------------------------	---------------

Dynamic Headroom Into 4 Ohms.	0.96 dB
------------------------------------	---------

Signal to Noise Ratio, "A" Weighted

300 watts into 8 ohms.	≥ 112dB
-----------------------------	---------

Gain.	29.67dB
------------	---------

Input Sensitivity

for 1 Watt output.	0.1 volts
for 300 Watts output.	1.61 volts

Input Impedance

Unbalanced.	500K ohms
Balanced.	10K ohms

Damping Factor

1k.	> 500
----------	-------

General

Power (available in 230VAC by special order).	120VAC—50/60Hz
Chassis Dimension.	19 ³ / ₄ " (501.65mm) x 17" (432mm) x 8 ³ / ₄ " (222.25mm)
Maximum Dimensions.	20 ³ / ₄ " (527.05mm) x 17" (432mm) x 9 ¹ / ₂ " (241.3mm)
Weight.	88 lbs. (40kg)
Weight, Packed.	138.6 lbs. (63kg)

GFA-7807 SPECIFICATIONS

Power Rating (To EIA/CEA-490-A Requirements)

300 Watts continuous average power per channel into 8 ohms at any frequency between 20Hz and 20kHz with all channels driven at less than 1.00% THD.

450 Watts continuous average power per channel into 4 ohms at any frequency between 20Hz and 20kHz with all channels driven at less than 1.00% THD.

THD + Noise at 300 watts into 8 Ohms (Typical)

20Hz.	0.012%
1kHz.	0.135%
10kHz.	0.12%
20kHz.	0.12%

THD + Noise at 450 watts into 4 Ohms (Typical)

20Hz.	0.3%
1 kHz.	0.3%
10kHz.	0.27%
20kHz.	0.1%

Frequency Response @ 1 Watt into 8 Ohms

10Hz to 20kHz.	+0, -0.25dB
---------------------	-------------

Power Bandwidth (-3d B).	3Hz to 130kHz
-------------------------------	---------------

Dynamic Headroom Into 4 Ohms.	0.96 dB
------------------------------------	---------

Signal to Noise Ratio, "A" Weighted

300 watts into 8 ohms.	≥ 112dB
-----------------------------	---------

Gain.	29.67dB
------------	---------

Input Sensitivity

for 1 Watt output.	0.1 volts
for 300 Watts output.	1.61 volts

Input Impedance

Unbalanced.	500K ohms
Balanced.	10K ohms

Damping Factor

1k.	> 500
----------	-------

General

Power (available in 230VAC by special order).	120VAC—50/60Hz
Chassis Dimension.	19 ³ / ₄ " (501.65mm) x 17" (432mm) x 8 ³ / ₄ " (222.25mm)
Maximum Dimensions.	20 ³ / ₄ " (527.05mm) x 17" (432mm) x 9 ¹ / ₂ " (241.3mm)
Weight.	118.8 lbs. (54kg)
Weight, Packed.	169.4 lbs. (77kg)

ADCOM

A division of Klein Technology Group, LLC
8551 East Anderson Drive, Suite 105
Scottsdale, Arizona 85255
Voice: (480) 607-2277
Fax: (480) 348-9876
<http://www.adcom.com>

GFA7805_07_manual_v1

Free Manuals Download Website

<http://myh66.com>

<http://usermanuals.us>

<http://www.somanuals.com>

<http://www.4manuals.cc>

<http://www.manual-lib.com>

<http://www.404manual.com>

<http://www.luxmanual.com>

<http://aubethermostatmanual.com>

Golf course search by state

<http://golfingnear.com>

Email search by domain

<http://emailbydomain.com>

Auto manuals search

<http://auto.somanuals.com>

TV manuals search

<http://tv.somanuals.com>