

Voyager[®]

AOM681 6.8" FLAT PANEL COLOR OBSERVATION MONITOR OWNER'S MANUAL

AOM681 Features:

- ? 6.8" High Performance Color LCD
- ? Water Resistant Design
- ? Built-in Audio Speaker with Volume Control and 12V Trigger

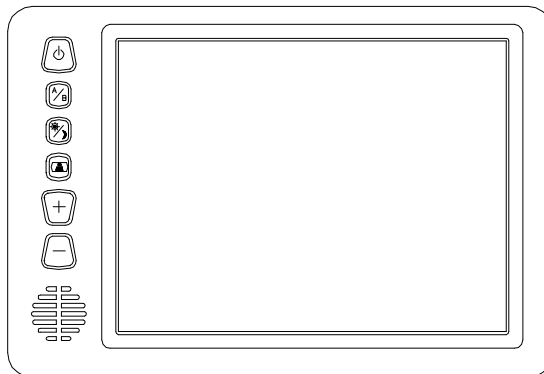

- ? 2 Camera (A/V) Input with A/B Select Control
- ? Backlit Controls and Day/Night Picture Modes for Nighttime Use
- ? Auto/Manual Power On
- ? Sun Visor Included

Visit us at <http://www.asaelectronics.com>

Important! – Please Read This Manual Before Installing!

Congratulations on your purchase of a Voyager AOM681 LCD Observation Monitor. With proper installation and use, your AOM681 is designed to provide you with years of trouble-free operation. This manual contains important information required to properly install and operate the unit. Please read this manual thoroughly before beginning.

All Voyager Observation products are strictly intended to be installed as a supplement aid to standard rear-view mirror systems that may already exist in your vehicle. Voyager observation products are not intended for use as substitutes for rear-view mirror devices, or for any other standard motor vehicle equipment required to be installed on vehicles by law.

While Voyager observation products contribute to improving the vehicle operator's field of view, these products are no substitute for proper defensive driving techniques and observance of traffic laws and motor vehicle safety regulations.

Warnings!

Installation Location

It is unlawful in most jurisdictions for a person to drive a motor vehicle equipped with a television viewer or screen located at any point forward of the back of the driver's seat or in any location that is visible, directly or indirectly, to the driver while operating the vehicle. The AOM681 product is designed to be used primarily as a rear observation device in conjunction with closed circuit cameras. In any installations where the AOM681 is used to display television broadcasts or recorded video playback, installation **location** must adhere to local laws and regulations.

Tampering

To prevent electrical shock, **DO NOT OPEN THE MONITOR CASE.** *There are potentially harmful voltages inside the monitor. There are no user serviceable parts inside.* If evidence of tampering is detected, the warranty will be considered void.

Moisture

Your Voyager AOM681 was designed to be water-resistant. While it will withstand short periods of exposure to moisture, this product does contain sensitive electronic components and exposure to moisture should be limited by the user / installer. This product is not designed for applications where constant exposure to moisture or immersion can be encountered. This unit should NEVER be cleaned with a power washer or used where direct power washer spray may be encountered.

PACKING CONTENTS:



WARRANTY CARD
QTY. 1

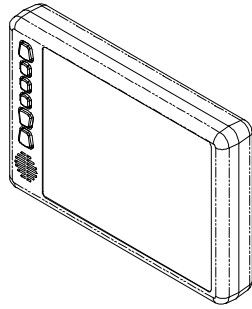

LCD MONITOR
QTY. 1

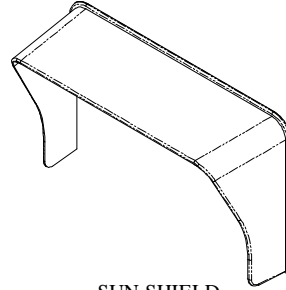

SUN SHIELD
QTY. 1

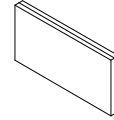

4" X 2" VELCRO
QTY. 1

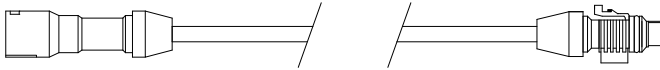

5' INTERMEDIATE HARNESS
QTY. 1

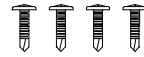

#8 X 3/4" SELF DRILL BLACK SCREWS (HARDWARE BAG)
QTY. 4

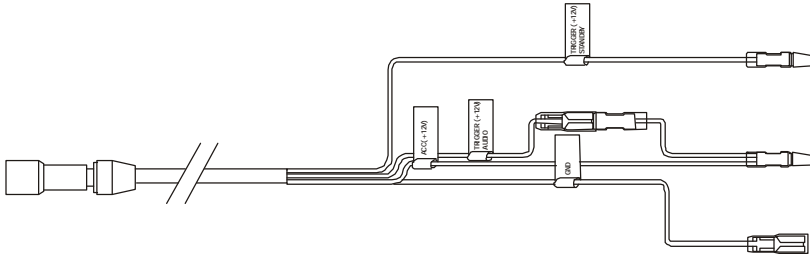

POWER HARNESS QTY. 1



#10 X 5/16" PHP THREAD FORMING BLACK SCREW (HARDWARE BAG) QTY. 4

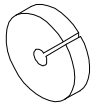

SPLIT GROMMET
1" O.D. 3/16 I.D.
QTY. 1

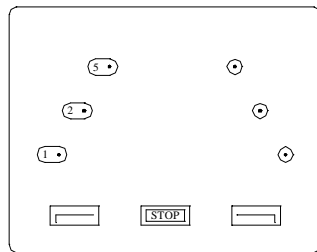

DISTANCE MARKER STICKER
QTY. 1

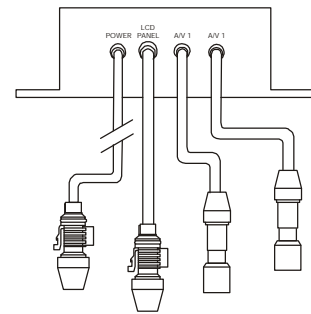

A/V INPUT JUNCTION BOX
QTY. 1



4" BLACK WIRE TIE
QTY. 4

CONTROLS AND OPERATION

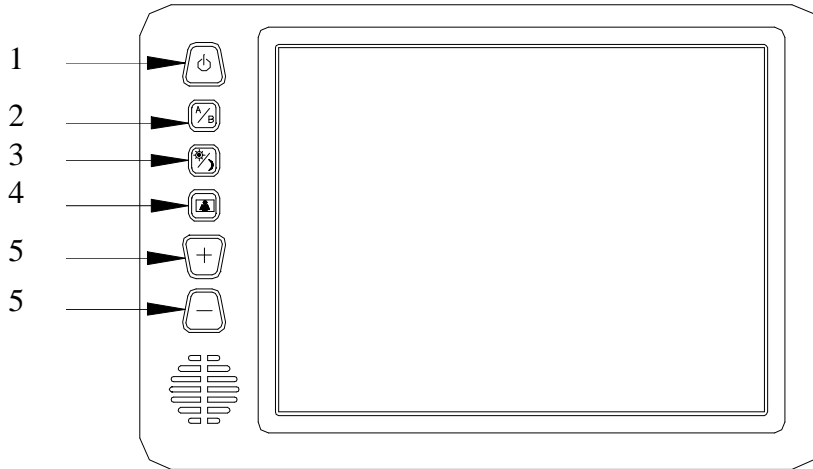

1. Power/Stand-By Button

The AOM681 has two possible operation modes for turning the unit on/off. In manual mode, the power button is used to turn the unit on/off. In stand-by mode, the unit automatically turns on only when 12V is applied to the stand-by trigger wire.

For MANUAL operation, the AOM681 should be wired as follows:

The ACC (+12V) lead (red) should be wired to the ACC feed of the vehicle (switched +12V).

*Please note that if the unit is in “Stand-by On” mode, the Power Button will appear to have no effect (it will switch from “on” to “on” in this case).

For STAND-BY operation, the AOM681 should be wired as follows:

The ACC (+12V) lead (red) should be wired to the ACC feed of the vehicle (switched +12V). The Stand-by Trigger (+12V) should be wired to the reverse feed of the vehicle (+12V when the vehicle is in reverse). The unit will automatically turn on whenever the standby trigger is +12V.

The power button features dual-illumination (bright and dim). In installations where the unit is not wired for Stand-by operation and power is applied to the unit, the Power Button will dimly glow when the unit is off, allowing the user to easily find the control in low light. Illumination switches to full intensity when the unit is turned on.



2. A/B Input Select Button

This control toggles the active display image back and forth between AV1 and AV2 inputs.



3. Day/Night Mode Button This control toggles the unit between “Day” and “Night” LCD illumination modes. In the “Day” mode, the LCD backlight intensity is at maximum. In “Night” mode, the LCD backlight is dimmed to a preset level that is more suitable for low light operation.



4. Picture Adjustment Menu Button

This control accesses an On-Screen-Display (OSD) menu for four LCD picture adjustments (Brightness, Contrast, Color, and Tint). The first depress of the button accesses the “Brightness” adjustment. The Volume +/- controls adjust the level, which is indicated by the bar graph at the bottom of the screen. Each consecutive depress of the Picture button accesses the adjustment screen for each picture adjustment. If no buttons are pressed within 6 seconds or controls other than the Picture and Volume buttons are pressed, the unit will exit the Picture Adjustment mode.



5. Volume +/- Buttons



This 2-button set of controls adjusts the output volume of the built-in audio speaker when the audio function is enabled *(see typical system connection diagram). The “+” button increases output volume. The “-“ button decreases output volume. Volume level is indicated by the OSD bar graph at the bottom of the screen.

These buttons also serve as adjustment controls while in the Picture Adjustment Menu mode (see above section for details).

*Note: The AOM681 requires +12V to be applied to the “Audio Enable” trigger input in order to activate the built-in speaker. If no audio output is heard from the speaker regardless of the volume level adjustment, check this connection.

INSTALLATION INSTRUCTIONS

BEFORE YOU BEGIN INSTALLATION:

Before drilling, be sure that no cable or wiring is on the other side. Clamp all wires securely to reduce the possibility of them being damaged during installation and use. Keep all cables away from hot or moving parts, and electrically noisy components.

Wiring Definitions:

- ✍ Power connection: Pin 1 ACC +12V (Red)
 Pin 2 Standby Trigger (Blue wire)
 Pin 3 Ground (Black wire)
 Pin 4 Audio Trigger (Blue w/white stripe wire)

- ✍ Camera A input: Connection for camera or camera extension cable

- ✍ Camera B input: Connection for camera or camera extension cable

- ✍ LCD panel: 9-pin DIN cable connection: junction box to monitor.

Procedure:

1. Choose the monitor, junction box, and camera mounting locations.

2. Install all required cables in vehicle. A 3/4" (19mm) hole should be drilled for passing cables through vehicle walls, barriers, etc. After the intermediate cable is passed through the hole, install the split grommet (included). If additional cable protection is required install convoluted tubing over the cable.

3. After cable/wiring has been routed and components are in place, temporarily make all system connections and perform a system function check. If system does not operate properly, see the troubleshooting section of this manual.

4. If using an optional PanaVise[?] stalk mount (available separately), use the mounting template provided on page 10. Install the PanaVise[?] mount to the LCD monitor using the #10 self-drilling screws (included).

****Important:** Do not use screws other than those provided with the AOM681.
Void of warranty and serious product damage will occur.

5. Use the template provided on page 10 for proper placement of the junction box mounting holes. Use the #8 self-drilling screws (included) to secure the junction box in the desired location. The junction box can also be mounted using the 2" x 4" velcro strip (included).

6. There are 2 options for connecting the LCD monitor to the junction box. If the application is such that the monitor is in close proximity to the junction box, the AOM681 monitor can be connected directly to the junction box. If the junction box is mounted further from the monitor, use the 5' intermediate cable included with the AOM681 to connect the monitor to the junction box. If more cable length is needed, additional 5' lengths of the intermediate cable can be purchased. (See the accessory list at the back of this manual for part number details.)
7. Connect the 4-pin power harness to vehicle. (See system connection illustration page 8)
8. Plug camera extension cable (available separately P/N CEC25) into AV1 or AV2 input connector on the junction box. Plug observation camera into camera extension cable.
9. Make sure all cables are routed away from hot or moving parts, and away from sharp edges. Secure cables with wire ties.
10. For rear observation applications, range marker stickers have been included with this product. These markers are designed to adhere to your LCD monitor and provide a reference for gauging distance. See page 9 for illustration showing proper use and installation of the range markers

TYPICAL SYSTEM CONNECTION

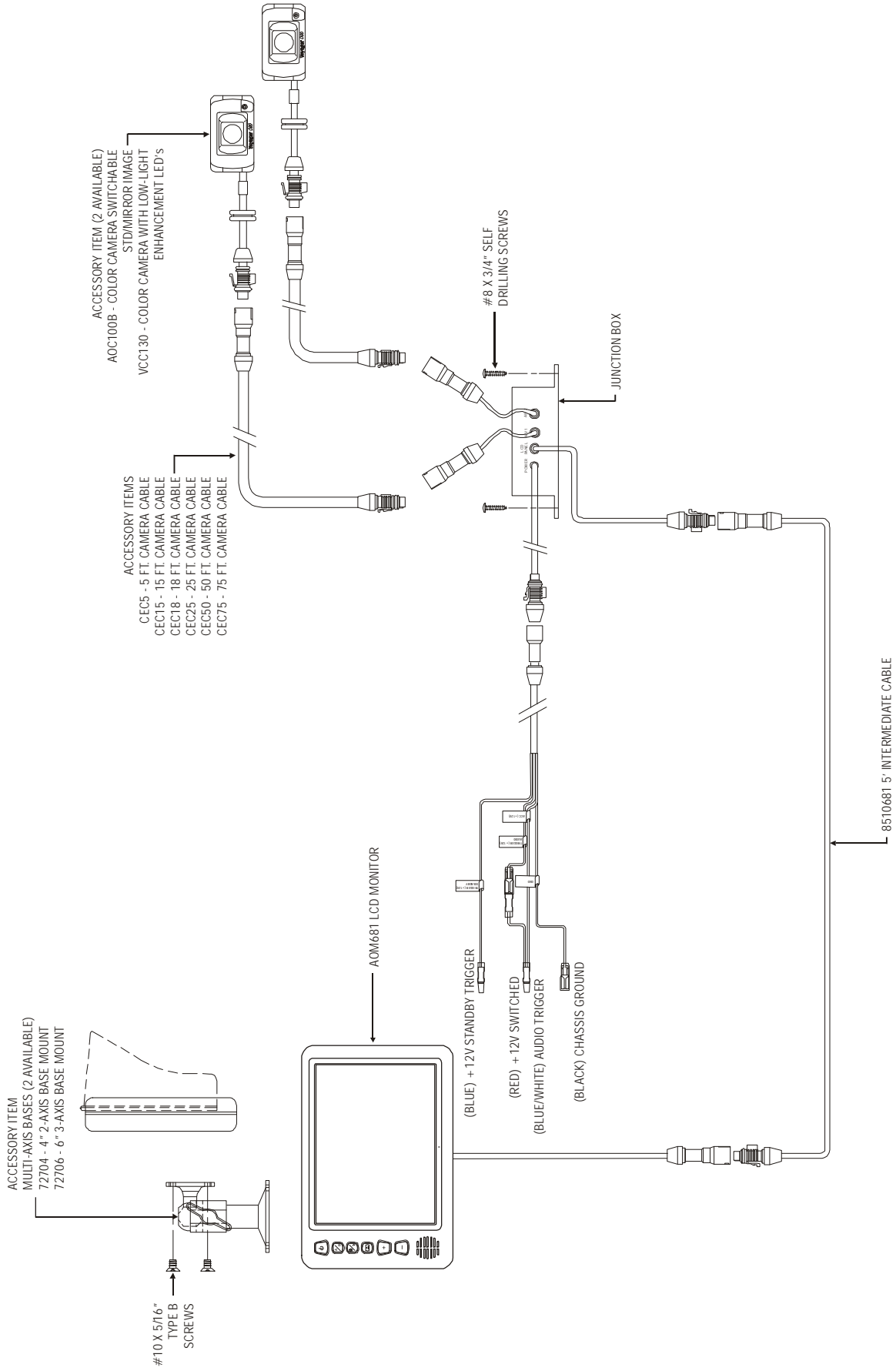

REAR OBSERVATION INSTALLATION **DISTANCE MARKER USE/INSTALLATION**

- PLACE INDICATOR MARKERS (CONE, BOX ANY REFERENCE OBJECT HANDY) BEHIND VEHICLE AS IN FIGURE A.
- PLACE RANGE MARKER DECALS ON SCREEN OF MONITOR OVER IMAGE OF INDICATOR MARKERS ON GROUND BEHIND VEHICLE, AS VIEWED ON THE MONITOR SCREEN.
- THIS GIVES YOU A VISUAL REFERENCE OF ACTUAL DISTANCE BEHIND VEHICLE, AS OBJECTS ARE VIEWED.

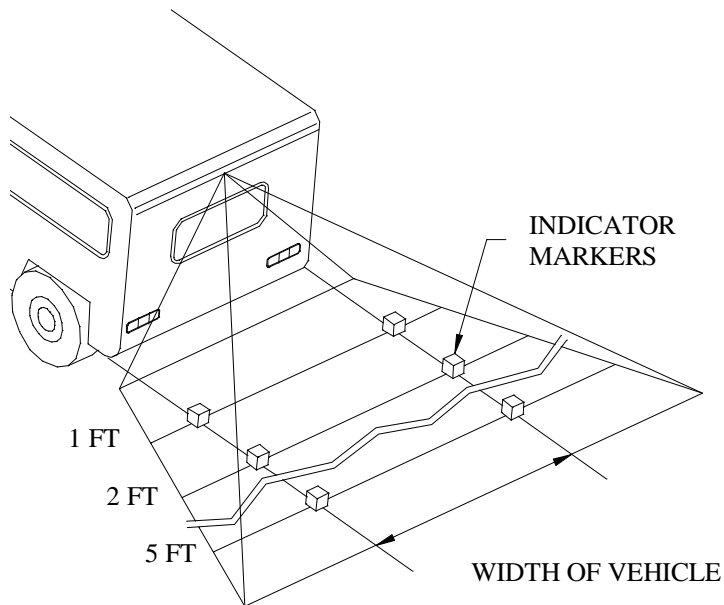

FIGURE A

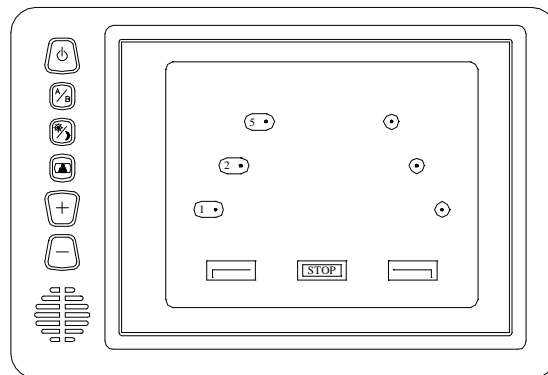
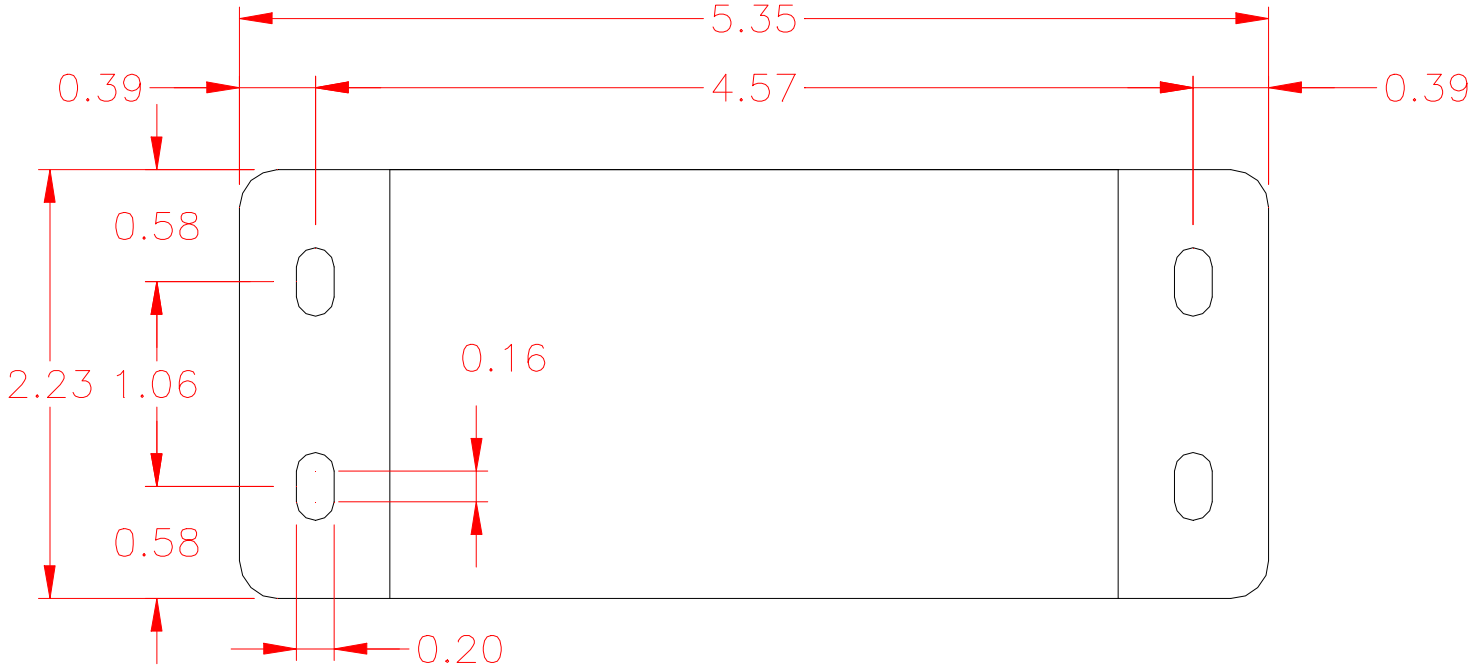
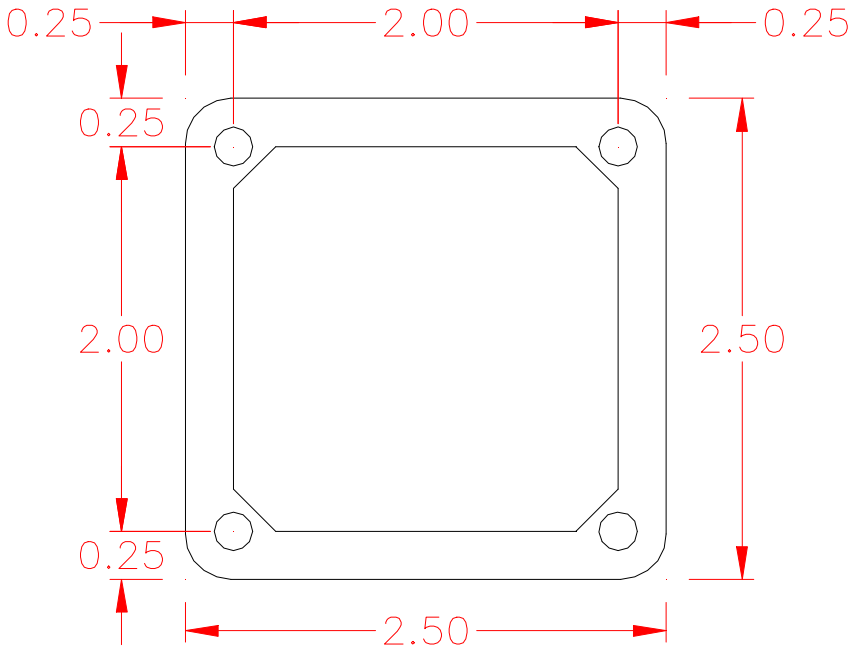

FIGURE B

JUNCTION BOX MOUNTING TEMPLATE



PANAVERSE[®] MOUNT TEMPLATE
(OPTIONAL ACCESSORY – SEE PAGE 8)



TROUBLESHOOTING

SYMPTOM	CAUSE	SOLUTION
No power	No +12V accessory, No ground, mis-wired/reversed	Replace circuit fuse, monitor has protection device built-in/reset, check ground connection, verify power is being supplied
Video/No audio	Blue/white audio trigger wire not powered, Volume adjust down	Connect to +12V ACC or reverse light circuit, turn volume adjustment up
Monitor does not activate in reverse	Blue standby wire not powered	Connect to reverse circuit +12V
Negative/dark video image	Low voltage, Brightness adjustment down	Check voltage power and ground connections, turn brightness adjustment up
No video/no audio	Camera connection	Check camera input selection, connection to camera and junction box, correct camera connection/plugged incorrectly
Vehicle battery drained	+12V ACC (red wire) connected to vehicle battery	Provide +12V ACC (red wire) power from switched circuit

ACCESSORY LIST

AOC100B – COLOR CAMERA-SWITCHABLE STD/MIRROR IMAGE
VCC130 - COLOR CAMERA W/LOW LIGHT ENHANCEMENT LED's-MIRROR IMAGE ONLY
CEC2 – 2 FOOT CAMERA EXTENSION CABLE
CEC15 – 15 FOOT CAMERA EXTENSION CABLE
CEC18 – 18 FOOT CAMERA EXTENSION CABLE
CEC25 – 25 FOOT CAMERA EXTENSION CABLE
CEC50 – 50 FOOT CAMERA EXTENSION CABLE
CEC75 – 75 FOOT CAMERA EXTENSION CABLE
8510681 – 5 FOOT INTERMEDIATE HARNESS
CSW4000 – MANUAL 4 CAMERA SWITCHER
CSW450A – AUTOMATIC 4 CAMERA SWITCHER
FDK681N - FLIP DOWN KIT, AOM681 NEUTRAL
FKD681G – FLIP DOWN KIT, AOM681 GRAY
FDK681PL – FLIP DOWN KIT, AOM681 PEARL
72704 – CELLULAR MOUNT 4” WITH THUMBSCREW
72706 – CELLULAR MOUNT 6” WITH THUMBSCREW

PRODUCT SPECIFICATIONS

LCD panel specifications:

Size/Type	6.8" (diagonal) /TFT LCD
Brightness	250 nit (min) 300 nit (typ.)
Contrast Ratio	60 (min) 150 (typ.)
View Angles (@ CR? 10)	Top (12 o'clock): 25?min Bottom (6 o'clock): 40?min Horizontal: ? 55?(min)
Response Time	Rise: 25ms (typ.) ; 50ms (max) Fall: 30ms (typ.) ; 60ms (max)
Back light Type	CCFL
Back light Life	30k hrs (min) ; 40k hrs (typ.)

Operation Temperature Range: -20?C to 65?C
 Storage Temperature Range: -40?C to 80?C
 Max Humidity: 100? RH
 Max Vibration Force: 2.5G
 Max Shock Force: 100G
 Operating Voltage Range: 10VDC to 16VDC
 Current Draw (typical): 50mA (Idle); 1.15A (typ) ; 1.25A (max)
 Signal System: NTSC

Video:

? Aspect Ratio: 4:3
 ? Input format: Composite NTSC
 ? Input level: 1Vp-p into 75?

Audio

? Input level: -10dBV nominal (317mV)

Product Weight: 2.8lbs (approximate)
 Product Overall Dimensions: 7 3/4" (197mm)**W** x 5 1/4" (134mm)**H** x 1 3/16" (29.5mm)**D**

Visit us at <http://www.asaelectronics.com>

Free Manuals Download Website

<http://myh66.com>

<http://usermanuals.us>

<http://www.somanuals.com>

<http://www.4manuals.cc>

<http://www.manual-lib.com>

<http://www.404manual.com>

<http://www.luxmanual.com>

<http://aubethermostatmanual.com>

Golf course search by state

<http://golfingnear.com>

Email search by domain

<http://emailbydomain.com>

Auto manuals search

<http://auto.somanuals.com>

TV manuals search

<http://tv.somanuals.com>