



BLUETOOTH® MINI-BRIDGE STEREO
HEADSET WITH MIRASOL™ DISPLAY

USER MANUAL

IMPORTANT INFORMATION

1. Receiver may explode if exposed to flames. Keep away from fire.
2. Do not drop or apply excessive force to the receiver. It may cause damage.
3. In case of malfunction, do not attempt to repair. Please contact the nearest service center or the place of purchase immediately.
4. Do not expose to moisture or dripping. If the receiver gets wet, avoid heat or electrical current. Contact the nearest service center or the place of purchase immediately.
5. Keep out of reach of children.
6. Do not use chemical products (for example, bleach) to clean the product.
7. Do not use any unauthorized charging device.
8. When storing the product for an extended period of time, store in a dry place and avoid extreme temperatures.
9. In order to avoid radio interference, do not use the receiver where use of wireless devices is forbidden.
10. Your battery and the mobile device may require recycling in accordance with local laws. Please contact your local authorities for more information. Do not discard your battery or mobile device in the trash.
11. If you use any medical device (for example, pacemaker or hearing aids), please consult your medical device manufacturer to make sure that the correct functioning of your medical device is not affected by RF energy emitted by the Bluetooth Receiver. Your doctor may be able to assist you in obtaining this information.
12. Avoid using the receiver at full volume or for long periods. Such use may damage your hearing.
13. Strong static electricity may damage the product. Use caution when operating the receiver around sources of static electricity.
14. Modifications not expressly approved by the party responsible for compliance could void the user's authority to operate the equipment.

This device complies with part 15 of FCC Rules. Operation is subject to the following two conditions:

1. This device may not cause harmful interference, and
2. This device must accept any interference received, including interference that may cause undesired operation.

This equipment has been tested and found to comply with the limits for a Class B digital device, pursuant to part 15 of the FCC Rules. These limits are designed to provide reasonable protection against harmful interference in a residential installation. This equipment generates, uses and can radiate radio Frequency energy and, if not installed and used in accordance with the instructions, may cause harmful interference to radio communications. However, there is no guarantee that interference will not occur in a particular installation. If this equipment does cause harmful interference to radio or television reception, which can be determined by turning the equipment off and on, the user is encouraged to try to correct the interference by one or more of the following measures:

- Reorient or relocate the receiving antenna.
- Increase the separation between the equipment and receiver
- Connect the equipment into an outlet on a circuit different from that to which the receiver is connected.

Consult the dealer or an experienced radio/TV technician for help.

This Class B digital apparatus complies with Canadian ICES-003.

Cet appareil numérique de la classe B est conforme à la norme NMB-003 du Canada.

Our product satisfies Bluetooth Core Specification Version 2.0. Some Bluetooth devices may not be compatible with the receiver. For further information about compatibility, please contact the concerned manufacturer, or our customer service center.

All trade names are trademarks or registered trademarks of respective manufacturers listed. The Bluetooth name, logo and Bluetooth trademarks are owned by Bluetooth SIG, Inc. XEN, XOME, LIVE, WIDE, and MEX are trademarks owned by Emersys Corp. and are used by Audiovox Accessories Corporation under license.

Download from [Www.Somanuals.com](http://www.Somanuals.com). All Manuals Search And Download.

STEP 1: UNPACKING

Make sure you find the following pieces in your Mini-Bridge Stereo Headset package:



the Mini-Bridge



earbuds

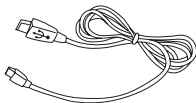

USB charging cable

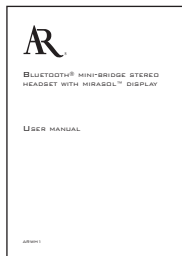

this user manual

STEP 2: CHARGING

Before you start using the Bluetooth Mini-Bridge, you should charge it fully. Average charging time is 2 hours.

TO CHARGE THE BLUETOOTH MINI-BRIDGE:

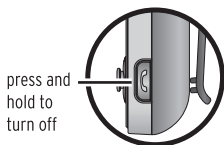

press and hold to turn off

1. Make sure the Mini-Bridge is turned off. If necessary, press and hold the  button on the side of the Mini-Bridge to turn the Mini-Bridge off.
2. Connect the Mini-Bridge to a computer using the provided USB charging cable. You can also connect the charging cable to a USB power adapter to charge the Mini-Bridge. The Mini-Bridge's display screen tells you the charging status:

'Recharging' appears when the Mini-Bridge is still charging.

'Fully charged' appears when the Mini-Bridge has finished charging.



continues on next page... 3

GETTING STARTED

3. Disconnect the Mini-Bridge from the charging cable when charging is complete.

Each full recharge will give you, on average, 6 hours of continuous talk time, 5 hours of continuous music time, or 140 hours of standby time before the next charge is necessary. Actual times before recharge may vary depending on usage conditions.

When the Mini-Bridge needs to be recharged again, the  (low battery) icon will flash.

IMPORTANT BATTERY INFORMATION



- Fully charge the Mini-Bridge before first use.
- Use your computer or approved USB power adapters to recharge the Mini-Bridge. Do not use other kinds of recharging devices.
- Disconnect the Mini-Bridge from the recharging cable once charging is complete.
- Do not use the Mini-Bridge while it is charging.

STEP 3: PAIRING

Before you can use the Bluetooth Mini-Bridge with your phone or computer, you must pair the two devices. This step establishes a unique link between two Bluetooth devices, which lets you use the Bluetooth Mini-Bridge with this device without repeating the pairing process.

TO PAIR MINI-BRIDGE WITH A PHONE OR COMPUTER:



1. Make sure the Mini-Bridge is off.
2. Press and hold the  button for approximately 5 seconds.
3. Release the  button when 'Pairing...' appears on the display. The Mini-Bridge will beep every 5 seconds to indicate that it's in the process of pairing with your device.



4. On your phone or computer, search for Bluetooth devices and select 'ARWH1' from the discovered devices.
5. When prompted for a password, enter '0000'
6. Your phone or computer will indicate when the pairing has been successful.

IMPORTANT PAIRING INFORMATION

- The Mini-Bridge will keep trying to pair with your device for 90 seconds. If it hasn't successfully paired in that time, you'll have to start the pairing process again.
- If your Bluetooth device displays a connection failed message, retry the pairing process from the beginning.
- If you've tried several times to pair without success, consult your Bluetooth device's user's manual. Many devices have special instructions for pairing.

Congratulations! You are now ready to use your Bluetooth Mini-Bridge with your Bluetooth device. When you turn the ARWH1 on, it will automatically connect to the last Bluetooth device it was connected to if that device is in range.

The rest of this User's Guide shows you how to use your Bluetooth Mini-Bridge for listening to music and receiving phone calls, all wirelessly.

USING YOUR MINI-BRIDGE

TOUR OF THE MINI-BRIDGE

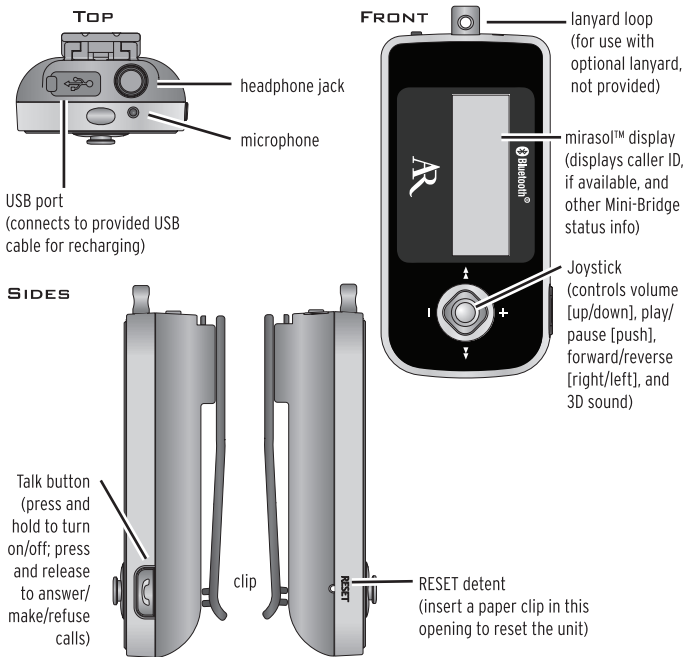

TURNING THE MINI-BRIDGE ON AND OFF

TO TURN THE MINI-BRIDGE ON: Press and hold the  button for 3 seconds. The Acoustic Research logo will appear on the display.

NOTE: If you hold the  button for longer than 3 seconds, the Mini-Bridge will enter pairing mode. See page 4 for more information.

TO TURN THE MINI-BRIDGE OFF: Press and hold the  button for 3 seconds. The display will display "Goodbye" briefly, then turn off.

CONNECTION TIPS

The Bluetooth Mini-Bridge must be paired with a Bluetooth device in order to connect to that device. Once it's been paired, the two devices connect automatically.

AUTO CONNECT

Once the Mini-Bridge is turned on, it automatically attempts to connect to the Bluetooth device that it was last connected to. If the Mini-Bridge cannot find a connection (or if it loses a connection), the auto-connect function times out after 5 minutes.

TO RE-ESTABLISH THE CONNECTION:

- Turn the Mini-Bridge off and on,

—OR—

- Make the connection from your Bluetooth device.

CONNECTING TO A DIFFERENT DEVICE

TO CONNECT THE MINI-BRIDGE TO A DIFFERENT DEVICE:

1. Make sure the Mini-Bridge is off. Press and hold the  button for 5 seconds to put the Mini-Bridge into pairing mode.
2. Make the connection from the Bluetooth device.

IMPORTANT CONNECTION INFORMATION

If you turn the Mini-Bridge off or leave its range of operation with your Bluetooth device, you will have to re-establish the connection before using the Mini-Bridge again.

USING YOUR MINI-BRIDGE

MAKING PHONE CALLS

TO MAKE A CALL:

1. Enter the phone number on your phone.
2. Press the  button on the Mini-Bridge twice to place the call.

NOTE: Some devices may not support placing a call from the Mini-Bridge.

TO REDIAL THE LAST NUMBER: Press the  button on the Mini-Bridge twice to call the number of the last outgoing call.

TO VOICE DIAL: Press the  button on the Mini-Bridge and begin voice dialing.

NOTE: Some devices may not support voice dialing from the Mini-Bridge.

RECEIVING CALLS

When you receive a call on your phone, the Mini-Bridge will emit a ring tone and display caller ID information (if available) on its screen.

TO ANSWER A CALL: Press the  button on the Mini-Bridge.

TO REJECT A CALL: Press down on the Mini-Bridge's joystick.

NOTE: Some devices may not support rejecting calls from the Mini-Bridge.

DURING THE CALL

TO END THE CALL: Press the  button on the Mini-Bridge.

TO TRANSFER THE CALL FROM THE MINI-BRIDGE TO YOUR PHONE: Press down on the Mini-Bridge's joystick.

TO TRANSFER THE CALL FROM YOUR PHONE TO THE MINI-BRIDGE: Press down on the Mini-Bridge's joystick.

TO ADJUST THE VOLUME OF THE CALL: Move the Mini-Bridge's joystick up or down.

USING YOUR MINI-BRIDGE

TO HOLD THE CURRENT CALL AND ANSWER AN INCOMING CALL:

Press and hold the Mini-Bridge's joystick. Press and hold the joystick again to switch between calls.

TO END THE CURRENT CALL AND ANSWER AN INCOMING CALL:

Press the Mini-Bridge's joystick toward ►► and hold.

TO HOLD THE CURRENT CALL AND REDIAL THE LAST NUMBER:

Press the Mini-Bridge's joystick toward ◀◀ and hold.

LISTENING TO MUSIC

IMPORTANT: Some devices may not support some of these functions.

TO START PLAYBACK: Press down on the Mini-Bridge's joystick to launch your phone's MP3 player. The first song in the current playlist starts.

TO PAUSE OR RESUME PLAYBACK: Press down on the Mini-Bridge's joystick.

TO STOP PLAYBACK: Press and hold the Mini-Bridge's joystick.

TO SELECT SONGS: Press the Mini-Bridge's joystick toward ◀◀ or ►►.

TO FORWARD OR REVERSE THROUGH SONGS: Press and hold the Mini-Bridge's joystick toward ◀◀ or ►►.

TO ANSWER A CALL WHILE LISTENING TO MUSIC: Press the  button on the Mini-Bridge. The music will automatically pause when the call picks up. Music will resume when the call terminates.

TO REJECT A CALL WHILE LISTENING TO MUSIC: Press down on the Mini-Bridge's joystick.

IMPORTANT BLUETOOTH AUDIO INFORMATION

For optimum audio quality, use the A2DP Bluetooth profile to connect your device to the Mini-Bridge.

To play, pause, or select music, your Bluetooth host device must support the AVRCP profile. See your host's owner's manual for more information.

USING YOUR MINI-BRIDGE

USING 3D SOUND

The AR Bluetooth Mini-Bridge offers five 3D sound enhancement options for music.

TO TRY THE NEXT SOUND ENHANCEMENT OPTION DURING MUSIC PLAYBACK: Press down on the Mini-Bridge's joystick twice.

The following enhancement options are available:

'Normal' No sound enhancement.



Provides subtle noise cancelling, for use in noisy environments.



Provides a sound environment that mimics a live performance.



Provides a widened 3D audio image.



Provides a widened 3D audio image with bass boost.

NOTE: The Mini-Bridge beeps twice to signal when you return to normal mode.

IMPORTANT BLUETOOTH AUDIO INFORMATION

The 3D Sound Enhancement feature requires the A2DP Bluetooth profile.

MULTI-PAIRING

Multi pairing lets you use the Bluetooth Mini-Bridge with multiple Bluetooth host devices simultaneously. You could, for example, connect the Mini-Bridge to your PC (to listen to music) and your mobile phone (to answer calls) at the same time.

TO USE MULTIPLE DEVICES SIMULTANEOUSLY:

1. Pair each Bluetooth device you want to use individually using the Bluetooth profile appropriate for each device. The HSP or HFP profiles are best for phone conversation; A2DP is best for music.

IMPORTANT: Devices used simultaneously must have different profiles. You cannot, for example, use two devices with HSP profiles at the same time. See the note below for more information.

2. Once you've paired the Bluetooth Mini-Bridge with each host device, turn the Mini-Bridge off and on (the auto-connect function will take effect).

You can also set the Bluetooth Mini-Bridge to pairing mode and make the connections to it from the host devices.

IMPORTANT MULTI-PAIRING INFORMATION

In multi pairing, each device must have a different profile. For example, you cannot use your phone's MP3 player and the computer's MP3 player at the same time, because both devices try to connect using the A2DP profile. Instead, you need to connect the phone using HSP, while the computer is connected using A2DP. This way, you can listen to the music from the computer and answer phone calls at the same time.

In multi-pairing mode, the use of some functions may be restricted depending on host devices and the environment in which it is used. Acoustic Research does not guarantee the compatibility of all device combinations and functions for multi-pairing.

MINI-BRIDGE DISPLAY MESSAGES

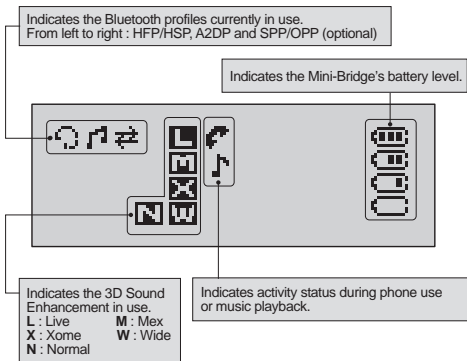

Display	Mini-Bridge Status
Acoustic Research logo	Mini-Bridge turning on
Goodbye...	Mini-Bridge turning off
Pairing related	
Pairing...	Searching for connection
Connecting...	Trying to connect
Pairing Failed	Connection failed
Connected	Connection successful
Disconnected	Connection disabled
Phone call related	
Redialing	Redialing the last number
XXX - XXX - XXXX	Caller's phone number
Call in Progress	Starting a call
Call Ended	Ending a call
Call Rejected	Call refused
Voice Dialing	Voice dial activated
Call Transferred	Transfer call from phone to Mini-Bridge
Call Transferred	Transfer call from Mini-Bridge to phone
Volume XX	Volume level

USING YOUR MINI-BRIDGE

Display	Mini-Bridge Status
Music related	
▶ Playing	Music is playing
▶ Play / ■ Pause	Mini-Bridge is in pause mode
Next ▶■	Play next song
■◀ Previous	Play previous song
Fast Forward ▶▶	Searching track forward
◀◀ Rewind	Searching track backward
Volume XX	Volume level
3D Sound related	
Normal	Please consult 3D Sound section of this manual for details
Xome	
Live	
Wide	
Mex	
Battery related	
Battery Low Please Recharge	Battery level is low
Recharging...	Battery is being recharged
Fully Charged	Battery level is full

Note: Icon and message display time is 20 seconds, after which the display turns off. To bring the display up again, push down on the joystick.

STORING THE MINI-BRIDGE

Make sure you turn off your Mini-Bridge and store it in a safe, dry place away from moisture when you're not using it. Avoid extreme temperatures and direct sunlight.

TROUBLESHOOTING

The following troubleshooting guide takes you through some of the more common problems associated with the installation and/or operation of a Bluetooth Mini-Bridge. If a problem persists, please call toll-free 1-800-732-6866 or visit www.araccessories.com.

I cannot turn my Mini-Bridge on.	The Mini-Bridge turns off automatically when the battery level is low. Please recharge the Mini-Bridge before using it for the first time.
I cannot pair the Mini-Bridge to other devices	The Mini-Bridge will only work with Bluetooth devices supporting HSP, HFP or A2DP profiles. This Mini-Bridge meets Bluetooth Core Specification Version 2.0 Some Bluetooth devices supporting a lower core specification version may not be compatible with this Mini-Bridge. For more information, see the owner's manual that came with your Bluetooth device.
Sound cuts out frequently.	The working range of this Mini-Bridge is 10m, but obstacles (such as walls) can affect this range. Other wireless devices, such as cordless phones and WiFi routers, may also interfere with the Mini-Bridge. Try to use your Mini-Bridge as far from these devices as possible.
My Mini-Bridge doesn't work correctly	Turn off your Mini-Bridge for a few seconds and restart it. If the problem persists, please contact the AR Helpline at the number listed above.

SPECIFICATIONS

Bluetooth Version	Version 2.0, Class II
Supported Profiles	A2DP, AVRCP, HFP, HSP
Frequency Spectrum	2.4~2.4835GHz
Working Distance	Maximum 10m
Operating Temperature	-5 ~ +60 °C
Operating Time	Talk 6 Hours / Music 5 Hours
Standby Time	140 Hours
Product Size	57(L) x 28(W) x 12.7(H) mm
Product Weight	21g (Receiver only)

Operating time varies according to usage conditions.

Specifications are subject to change without notice.

12 MONTH LIMITED WARRANTY

Audiovox Electronics Corporation (the "Company") warrants to the original retail purchaser of this product that should this product or any part thereof, under normal use and conditions, be proven defective in material or workmanship within 12 months from the date of original purchase, such defect(s) will be repaired or replaced (at the Company's option) without charge for parts and repair labor. To obtain repair or replacement within the terms of this Warranty, the product along with any accessories included in the original packaging is to be delivered with proof of warranty coverage (e.g. dated bill of sale), specification of defect(s), transportation prepaid, to the Company at the address shown below. Do not return this product to the Retailer.

This Warranty is not transferable and does not cover product purchased, serviced or used outside the United States or Canada. The warranty does not extend to the elimination of externally generated static or noise, to costs incurred for the installation, removal or reinstallation of the product. The warranty does not apply to any product or part thereof which, in the opinion of the company, has suffered or been damaged through alteration, improper installation, mishandling, misuse, neglect, accident or exposure to moisture. This warranty does not apply to damage caused by an AC adapter not provided with the product, or by leaving non-rechargeable batteries in the product while plugged into an AC outlet.

THE EXTENT OF THE COMPANY'S LIABILITY UNDER THIS WARRANTY IS LIMITED TO THE REPAIR OR REPLACEMENT PROVIDED ABOVE AND, IN NO EVENT, SHALL THE COMPANY'S LIABILITY EXCEED THE PURCHASE PRICE PAID BY PURCHASER FOR THE PRODUCT.

This Warranty is in lieu of all other express warranties or liabilities. ANY IMPLIED WARRANTIES, INCLUDING ANY IMPLIED WARRANTY OF MERCHANTABILITY OR FITNESS FOR A PARTICULAR PURPOSE, SHALL BE LIMITED TO DURATION OF THIS WARRANTY. ANY ACTION FOR BREACH OF ANY WARRANTY HEREUNDER, INCLUDING ANY IMPLIED WARRANTY, MUST BE BROUGHT WITHIN A PERIOD OF 24 MONTHS FROM THE DATE OF ORIGINAL PURCHASE. IN NO CASE SHALL THE COMPANY BE LIABLE FOR ANY CONSEQUENTIAL OR INCIDENTAL DAMAGES WHATSOEVER. No person or representative is authorized to assume for the Company any liability other than expressed herein in connection with the sale of this product. Some states/provinces do not allow limitations on how long an implied warranty lasts or the exclusion or limitation of incidental or consequential damage so the above limitations or exclusions may not apply to you. This Warranty gives you specific legal rights and you may also have other rights which vary from state/province to state/province.

USA.: Audiovox Electronics Corporation, 150 Marcus Blvd., Hauppauge, NY 11788

CANADA: Audiovox Return Center, c/o Genco, 6685 Kennedy Road, Unit 3, Door 16, Mississauga, Ontario L5T 3A5

© 2007 Audiovox Accessories Corporation
111 Congressional Blvd., Suite 350
Carmel, IN 46032 USA
www.araccessories.com

ARWH1_US_IB_01

Trademark(s) Registered

All other brands and product names are trademarks or registered trademarks of their respective owners.

Download from Www.Somanuals.com. All Manuals Search And Download.

Free Manuals Download Website

<http://myh66.com>

<http://usermanuals.us>

<http://www.somanuals.com>

<http://www.4manuals.cc>

<http://www.manual-lib.com>

<http://www.404manual.com>

<http://www.luxmanual.com>

<http://aubethermostatmanual.com>

Golf course search by state

<http://golfingnear.com>

Email search by domain

<http://emailbydomain.com>

Auto manuals search

<http://auto.somanuals.com>

TV manuals search

<http://tv.somanuals.com>