



MP3/WMA/AAC CD Receiver

CDA-9883E

MP3



AAC



EN

CT

- OWNER'S MANUAL
Please read before using this equipment.
- 使用手冊
請在使用本設備之前先閱讀使用手冊。

ALPINE ELECTRONICS MARKETING, INC.
1-1-8 Nishi Gotanda,
Shinagawa-ku,
Tokyo 141-0031, Japan
Phone 03-5496-8231

ALPINE ELECTRONICS OF AMERICA, INC.
19145 Gramercy Place, Torrance,
California 90501, U.S.A.
Phone 1-800-ALPINE-1 (1-800-257-4631)

ALPINE ELECTRONICS OF CANADA, INC.
777 Supertest Road, Toronto,
Ontario M3J 2M9, Canada
Phone 1-800-ALPINE-1 (1-800-257-4631)

ALPINE ELECTRONICS OF AUSTRALIA PTY. LTD.
161-165 Princes Highway, Hallam
Victoria 3803, Australia
Phone 03-8787-1200

ALPINE ELECTRONICS GmbH
Frankfurter Ring 117, 80807 München, Germany
Phone 089-32 42 640

ALPINE ELECTRONICS OF U.K. LTD.
Alpine House
Fletchamstead Highway, Coventry CV4 9TW, U.K.
Phone 0870-33 33 763

ALPINE ELECTRONICS FRANCE S.A.R.L.
(RCS PONTOISE B 338 101 280)
98, Rue de la Belle Etoile, Z.I. Paris Nord II,
B.P. 50016, 95945 Roissy Charles de Gaulle
Cedex, France
Phone 01-48638989

ALPINE ITALIA S.p.A.
Viale C. Colombo 8, 20090 Trezzano
Sul Naviglio (MI), Italy
Phone 02-484781

ALPINE ELECTRONICS DE ESPAÑA, S.A.
Portal de Gamarra 36, Pabellón, 32
01013 Vitoria (Alava)-APDO 133, Spain
Phone 945-283588

ALPINE ELECTRONICS (BENELUX) GmbH
Leuvensesteenweg 510-B6,
1930 Zaventem, Belgium
Phone 02-725-13 15

Contents

Operating Instructions

WARNING

WARNING	3
CAUTION	3
PRECAUTIONS	3

Getting Started

Accessory List	6
Turning Power On and Off	6
Detaching and Attaching the Front Panel	6
Initial System Start-Up	7
Adjusting Volume	7
Lowering Volume Quickly	7
Setting Time	7

Radio

Listening to Radio	8
Presetting Stations Manually	8
Presetting Stations Automatically	8
Tuning to Preset Stations	8
Frequency Search Function	8

CD/MP3/WMA/AAC

Playback	9
Repeat Play	9
M.I.X. (Random Play)	10
Searching from CD Text	10
File/Folder Name Search (concerning MP3/WMA/AAC)	10
Quick Search	11
About MP3/WMA/AAC	11

Sound Setting

Adjusting Bass/Treble/Balance (Between Left and Right)/Fader (Between Front and Rear)/ Defeat	13
Setting the Bass Control	13
Setting the Bass Centre Frequency	13
Setting the Bass Bandwidth	13
Setting the Bass Level	13
Setting the Treble Control	14
Setting the Treble Centre Frequency	14
Setting the Treble Level	14
Adjusting the High Pass Filter	14
Turning Loudness On/Off	14

Other Functions

Displaying the Text	15
Displaying Time	16

SETUP

BLUETOOTH IN

Setting the Bluetooth Connection	17
----------------------------------------	----

Sound Customizing

Subwoofer On and Off	17
Setting the Subwoofer System	17

Visual Customizing

Dimmer Control	17
Scroll Type Setting	17
Scroll Setting (TEXT SCROLL)	17
Setting the Language Font	17
Adjusting Display Contrast	17
Demonstration	17

MP3/WMA/AAC

Playing MP3/WMA/AAC Data (PLAY MODE)	17
-----------------------------------------------	----

External Device

Connecting to an External Amplifier	18
-------------------------------------------	----

General Setting

Turning Mute Mode On/Off (INT MUTE)	18
Setting the AUX Mode (V-Link)	18
Changer Name Setting	18
Setting the External Digital Input	18

iPod® (Optional)

Playback	19
Searching for a desired Song	19
Quick Search	20
Direct Search Function	20
Select Playlist/Artist/Album/Podcast/Genre/ Composer	20
Random Play Shuffle (M.I.X.)	20
Repeat Play	21
Displaying the Text	21

Changer (Optional)

Controlling CD Changer (Optional)	21
Playing MP3 Files with the CD Changer (Optional)	22
Multi-Changer Selection (Optional)	22

Remote Control

Controls on Remote Control	22
Battery Replacement	23

Information

In Case of Difficulty	24
Specifications	26

Installation and Connections

Warning	27
Caution	27
Precautions	27
Installation	28
Connections	30

Operating Instructions

WARNING

WARNING

This symbol means important instructions. Failure to heed them can result in serious injury or death.

DO NOT OPERATE ANY FUNCTION THAT TAKES YOUR ATTENTION AWAY FROM SAFELY DRIVING YOUR VEHICLE.

Any function that requires your prolonged attention should only be performed after coming to a complete stop. Always stop the vehicle in a safe location before performing these functions. Failure to do so may result in an accident.

KEEP THE VOLUME AT A LEVEL WHERE YOU CAN STILL HEAR OUTSIDE NOISES WHILE DRIVING.

Excessive volume levels that obscure sounds such as emergency vehicle sirens or road warning signals (train crossings, etc.) can be dangerous and may result in an accident. LISTENING AT LOUD VOLUME LEVELS IN A CAR MAY ALSO CAUSE HEARING DAMAGE.

MINIMIZE DISPLAY VIEWING WHILE DRIVING.

Viewing the display may distract the driver from looking ahead of the vehicle and cause an accident.

DO NOT DISASSEMBLE OR ALTER.

Doing so may result in an accident, fire or electric shock.

USE ONLY IN CARS WITH A 12 VOLT NEGATIVE GROUND.

(Check with your dealer if you are not sure.) Failure to do so may result in fire, etc.

KEEP SMALL OBJECTS SUCH AS BATTERIES OUT OF THE REACH OF CHILDREN.

Swallowing them may result in serious injury. If swallowed, consult a physician immediately.

USE THE CORRECT AMPERE RATING WHEN REPLACING FUSES.

Failure to do so may result in fire or electric shock.

DO NOT BLOCK VENTS OR RADIATOR PANELS.

Doing so may cause heat to build up inside and may result in fire.

USE THIS PRODUCT FOR MOBILE 12V APPLICATIONS.

Use for other than its designed application may result in fire, electric shock or other injury.

DO NOT PLACE HANDS, FINGERS OR FOREIGN OBJECTS IN INSERTION SLOTS OR GAPS.

Doing so may result in personal injury or damage to the product.

CAUTION

This symbol means important instructions. Failure to heed them can result in injury or material property damage.

HALT USE IMMEDIATELY IF A PROBLEM APPEARS.

Failure to do so may cause personal injury or damage to the product. Return it to your authorized Alpine dealer or the nearest Alpine Service Centre for repairing.

DO NOT MIX NEW BATTERIES WITH OLD BATTERIES. INSERT WITH THE CORRECT BATTERY POLARITY.

When inserting the batteries, be sure to observe proper polarity (+ and -) as instructed. Rupture or chemical leakage from the battery may cause fire or personal injury.

PRECAUTIONS

Product Cleaning

Use a soft dry cloth for periodic cleaning of the product. For more severe stains, please dampen the cloth with water only. Anything else has the chance of dissolving the paint or damaging the plastic.

Temperature

Be sure the temperature inside the vehicle is between +60°C (+140°F) and -10°C (+14°F) before turning your unit on.

Moisture Condensation

You may notice the CD playback sound wavering due to condensation. If this happens, remove the disc from the player and wait about an hour for the moisture to evaporate.

Damaged Disc

Do not attempt to play cracked, warped, or damaged discs. Playing a bad disc could severely damage the playback mechanism.

Maintenance

If you have problems, do not attempt to repair the unit yourself. Return it to your Alpine dealer or the nearest Alpine Service Station for servicing.

Never Attempt the Following

Do not grip or pull out the disc while it is being pulled back into the player by the automatic reloading mechanism.

Do not attempt to insert a disc into the unit when the unit power is off.

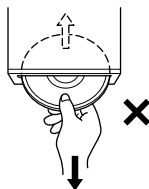

Inserting Discs

Your player accepts only one disc at a time for playback. Do not attempt to load more than one disc.

Make sure the label side is facing up when you insert the disc. "ERROR" will be displayed on your player if you insert a disc incorrectly. If "ERROR" continues to be displayed even though the disc has been inserted correctly, push the RESET switch with a pointed object such as a ballpoint pen.

Playing a disc while driving on a very bumpy road may result in skips, but this will not scratch the disc or damage the player.

New Discs

To prevent the CD from jamming, "ERROR" is displayed if discs with irregular surfaces are inserted or if discs are inserted incorrectly. When a new disc is ejected immediately after initial loading, use your finger to feel around the inside of the centre hole and outside edge of the disc. If you feel any small bumps or irregularities, this could inhibit proper loading of the disc. To remove the bumps, rub the inside edge of the hole and outside edge of the disc with a ballpoint pen or other such instrument, then insert the disc again.

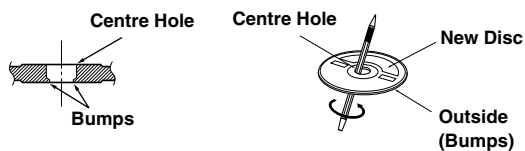

Irregular Shaped Discs

Be sure to use round shape discs only for this unit and never use any special shape discs.

Use of special shape discs may cause damage to the mechanism.



Installation Location

Make sure this unit will not be installed in a location subjected to:

- Direct sun and heat
- High humidity and water
- Excessive dust
- Excessive vibrations

Correct Handling

Do not drop the disc while handling. Hold the disc so you will not leave fingerprints on the surface. Do not affix tape, paper, or gummed labels to the disc. Do not write on the disc.

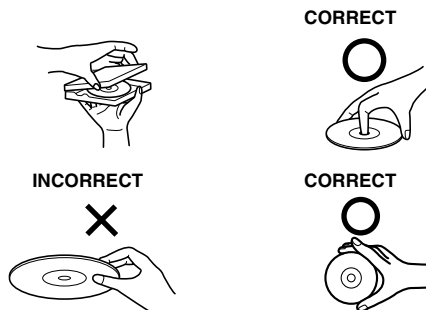

Disc Cleaning

Fingerprints, dust, or soil on the surface of the disc could cause the CD player to skip. For routine cleaning, wipe the playing surface with a clean, soft cloth from the centre of the disc to the outer edge. If the surface is heavily soiled, dampen a clean, soft cloth in a solution of mild neutral detergent before cleaning the disc.



Disc Accessories

There are various accessories available on the market for protecting the disc surface and improving sound quality. However, most of them will influence the thickness and/or diameter of the disc. Using such accessories can cause the disc to be out of standard specifications and may create operational problems. We recommend not using these accessories on discs played in Alpine CD players.

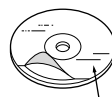

Transparent Sheet

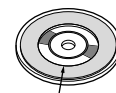

Disc Stabilizer

On handling Compact Discs (CD/CD-R/CD-RW)

- Do not touch the surface.
- Do not expose the disc to direct sunlight.
- Do not affix stickers or labels.
- Clean the disc when it is dusty.
- Make sure that there are no bumps around the disc.
- Do not use commercially available disc accessories.

Do not leave the disc in the car or the unit for a long time.

Never expose the disc to direct sunlight. Heat and humidity may damage the CD and you may not be able to play it again.

To customers using CD-R/CD-RW

- If a CD-R/CD-RW cannot be played back, make sure the last recording session was closed (finalized).
- Finalize the CD-R/CD-RW if necessary, and attempt playback again.

About media that can be played

Use only compact discs with the label side showing the CD logo marks below.



If you use unspecified compact discs, correct performance cannot be guaranteed.

You can play CD-Rs (CD-Recordables)/CD-RWs (CD-ReWritable) which have been recorded only on audio devices. You can also play CD-Rs/CD-RWs containing MP3/WMA/AAC formatted audio files.

- Some of the following CDs may not play on this unit:
Flawed CDs, CDs with fingerprints, CDs exposed to extreme temperatures or sunlight (e.g., left in the car or this unit), CDs recorded under unstable conditions, CDs on which a recording failed or a re-recording was attempted, copy-protected CDs which do not conform to the audio CD industry standard.
- Use discs with MP3/WMA/AAC files written in a format compatible with this unit. For details, see pages 11-12.
- ROM data other than audio files contained in a disc will not produce sound when played back.

-
- *Windows Media and the Windows logo are trademarks, or registered trademarks of Microsoft Corporation in the United States and/or other countries.*
 - *Apple, the Apple logo, iPod and iTunes are trademarks of Apple Computer, Inc., registered in the U.S. and other countries.*
 - *“MPEG Layer-3 audio coding technology licensed from Fraunhofer IIS and Thomson.”*
 - *“Supply of this product only conveys a license for private, non-commercial use and does not convey a license nor imply any right to use this product in any commercial (i.e. revenue-generation) real time broadcasting (terrestrial, satellite, cable and/or any other media), broadcasting/streaming via internet, intranets and/or other networks or in other electronic content distribution systems, such as pay-audio or audio-on-demand applications. An independent license for such use is required. For details, please visit <http://www.mp3licensing.com>”*

Getting Started

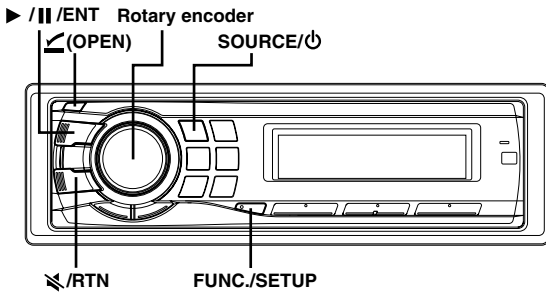

Accessory List

- Head unit1
- Power cable1
- Mounting sleeve1
- Carrying case1
- Bracket key2
- Screw (M5 x 8)4
- Remote Control1
- Battery (AAA size)2
- Owner's Manual 1 set

Turning Power On and Off

Press **SOURCE/⏻** to turn on the unit.

- The unit can be turned on by pressing any other button except ↙ (OPEN) and TITLE.

Press and hold **SOURCE/⏻** for at least 2 seconds to turn off the unit.

- The first time power is turned on, the volume will start from level 12.

Detaching and Attaching the Front Panel

Detaching

- 1 Turn off the unit power.
- 2 Press ↙ (OPEN) to open the front panel.

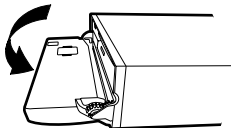

To close the front panel, press the left side until it locks as shown in the figure below.

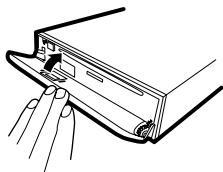

- 3 Grasp the front panel firmly, slide to the left ①, and then pull ② to remove.

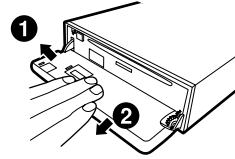

- The front panel may become hot in normal usage (especially the connector terminals on the back of the front panel). This is not a malfunction.
- To protect the front panel, place it in the supplied carrying case.
- When detaching the front panel, do not apply excessive force as it may result in malfunction.
- Do not leave the front panel open, or drive the car with the panel open as it may result in an accident or malfunction.

Attaching

- 1 Insert the right side of the front panel into the main unit. Align the groove on the front panel with the projections on the main unit.
- 2 Push the left side of the front panel until it locks firmly into the main unit.

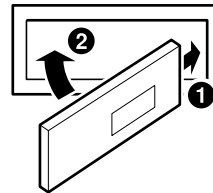

- Before attaching the front panel, make sure that there is no dirt or dust on the connector terminals and no foreign object between the front panel and the main unit.
- Attach the front panel carefully, holding the sides of the front panel to avoid pushing buttons by mistake.

Initial System Start-Up

Be sure to press the RESET switch when using the unit for the first time, after changing the car battery, etc.

- 1 Turn off the unit power.
- 2 Press **OPEN** to open the front panel, and then remove it.
- 3 Press **RESET** with a ballpoint pen or similar pointed object.

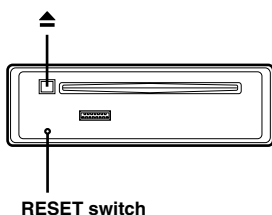

Adjusting Volume

Turn the **Rotary encoder** until the desired sound is obtained.

Lowering Volume Quickly

Activating the Audio Mute function will instantly lower the volume level by 20 dB.

Press **RTN** to activate the MUTE mode.

The audio level will decrease by about 20 dB.

Pressing **RTN** again will bring the audio back to its previous level.

Setting Time

- 1 Press and hold **FUNC./SETUP** for at least 2 seconds to activate the **SETUP** selection mode.
- 2 Turn the **Rotary encoder** to select **CLOCK ADJUST**, and then press **ENT**.
- 3 Turn the **Rotary encoder** to set hour.
- 4 Press **ENT**.
- 5 Repeat steps 3 and 4 above to set hour and minute.

- 6 Press and hold **FUNC./SETUP** for at least 2 seconds to return to normal mode.

- Pressing **RTN** returns to the previous **SETUP** mode.
- If no operation is performed for 60 seconds, **SETUP** is cancelled.
- To synchronize the clock to another clock/watch or radio time announcement, press and hold **ENT** for at least 2 seconds after setting the "hour". Minutes will reset to 00. If the display shows over "30" minutes when you do this, the time will advance one hour.

Radio

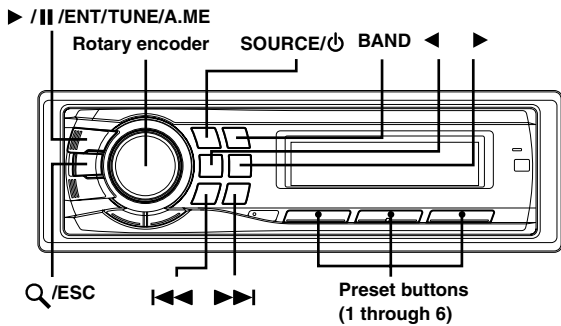

Listening to Radio

- 1 Press **SOURCE/⏻** to select **TUNER** mode.
- 2 Press **BAND** repeatedly until the desired radio band is displayed.

F1 → F2 → AM → F1

- 3 Press **TUNE/A.ME** to select the tuning mode.

DX SEEK (Distance mode) → SEEK (Local mode) → OFF (Manual mode) → DX SEEK (Distance mode)

- The initial mode is Distance mode.

Distance mode:

Both strong and weak stations will be automatically tuned in (Automatic Seek Tuning).

Local mode:

Only strong stations will be automatically tuned in (Automatic Seek Tuning).

Manual mode:

The frequency is manually tuned in steps (Manual tuning).

- 4 Press **◀◀** or **▶▶** to tune in the desired station. Holding down **◀◀** or **▶▶** will change the frequency continuously.

Presetting Stations Manually

- 1 Select the radio band and tune in a desired radio station you wish to store in the preset memory.
 - 2 Press and hold, for at least 2 seconds, any one of the **preset buttons (1 through 6)** into which you wish to store the station.
The selected station is stored. The display shows the band, preset number and station frequency memorized.
- A total of 18 stations can be stored in the preset memory (6 stations for each band; F1, F2 and AM).
 - If you store a station in a preset memory which already has a station, the current station will be cleared and replaced with the new station.

Presetting Stations Automatically

- 1 Press **BAND** repeatedly until the desired radio band is displayed.
 - 2 Press and hold **TUNE/A.ME** for at least 2 seconds.
The frequency on the display continues to change while the automatic memory is in progress. The tuner will automatically seek and store 6 strong stations in the selected band. They will be stored into preset buttons 1 to 6 in order of signal strength.
When the automatic memory has been completed, the tuner goes to the station stored in preset location No. 1.
- If no stations are stored, the tuner will return to the original station you were listening to before the auto memory procedure began.

Tuning to Preset Stations

- 1 Press **BAND** repeatedly until the desired band is displayed.
- 2 Press any one of the **station preset buttons (1 through 6)** that has your desired radio station in memory.
The display shows the band, preset number and frequency of the station selected.

Frequency Search Function

You can search for a radio station by its frequency.

- 1 Press and hold **Q / ESC** for at least 2 seconds in **Radio mode** to activate **Frequency search mode**.
 - 2 Turn the **Rotary encoder** to select the desired frequency.
 - 3 Press **▶ / || / ENT** to receive the selected frequency.
- Press and hold **Q / ESC** for at least 2 seconds in the search mode to cancel. Or, the search mode will be cancelled if no operation is performed for 10 seconds.

CD/MP3/WMA/AAC

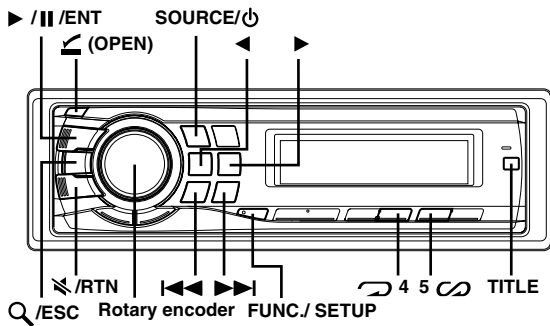

Playback

1 Press **(OPEN)**.

The front panel will open.

2 Insert a disc with the label side facing up.

The disc will be pulled into the unit automatically.

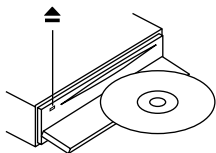

Close the front panel manually and "DISC IN" indicator lights up.

When a disc is already inserted, press SOURCE/⏻ to switch to the DISC mode.

TUNER → DISC → iPod*¹ → CHANGER*² → TUNER

*¹ Only when the iPod is connected.

*² Only when the CD changer is connected.

3 While playing back MP3/WMA/AAC, press **◀** or **▶** to select the desired folder.

Pressing and holding **◀** or **▶** will change folders continuously.

4 Press **◀◀** or **▶▶** to select the desired track (file).

Returning to the beginning of the current track (file):

Press **◀◀**.

Fast backward:

Press and hold **◀◀**.

Advancing to the beginning of the next track (file):

Press **▶▶**.

Fast forward:

Press and hold **▶▶**.

5 To pause playback, press **▶ /|| /ENT**.

Pressing **▶ /|| /ENT** again will resume playback.

6 After pressing **(OPEN)** to open the front panel, press **▲** to eject the disc.

- Do not remove a CD during its eject cycle. Do not load more than one disc at a time. A malfunction may result from doing either.
- If the CD does not eject, press and hold **▲** for at least 2 seconds.
- The "DISC IN" indicator lights up when a disc is inserted.
- The CD-player can play discs containing audio data, MP3 data, WMA data and AAC data.
- "MP3" is display during MP3 playback.
- "WMA" is displayed during WMA playback.
- "AAC" is displayed during AAC playback.
- WMA format files that are protected by DRM (Digital Rights Management), AAC format files that have been purchased from iTunes Music Store and files that are copy-protected (copyright protection) cannot be played back on this unit.
- The track display for MP3/WMA/AAC data playback is the file numbers recorded on the disc.
- The playback time may not be correctly displayed when a VBR (Variable Bit Rate) recorded file is played back.

MP3/WMA/AAC Play Display

The folder number and file number will be displayed as described below.

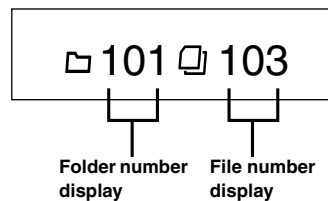

- Press **TITLE** to switch the display. See "Displaying the Text" (page 15) for information about display switching.

Repeat Play

Press **↺ 4** to play back repeatedly the track being played.

The track (file) will be played repeatedly.

Press **↺ 4** again and select off to deactivate repeat play.

CD mode :

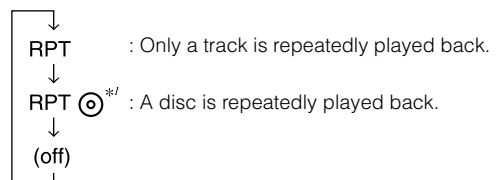

*¹ When a CD changer is connected.

- If RPT is set to ON during M.I.X. (M.I.X. ONE) play in CD changer mode, M.I.X. will apply to the current disc only.

MP3/WMA/AAC mode :

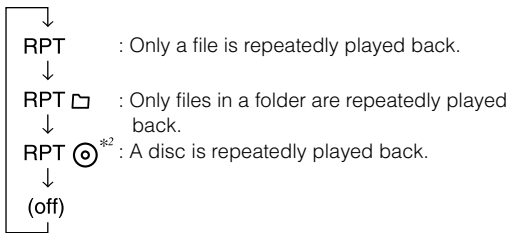

*2 When an MP3 compatible CD changer is connected.

- If a CD changer or an MP3 compatible CD changer is connected: After pressing **FUNC./SETUP** to select the function mode (RPT/M.I.X.), perform the operation within 10 seconds.

M.I.X. (Random Play)

Press **5** in the play or pause mode.

The tracks (files) on the disc will be played back in random sequence.

To cancel M.I.X. play, press **5** again.

Internal CD mode :

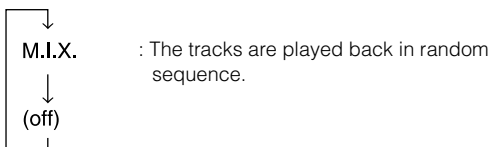

CD Changer mode :

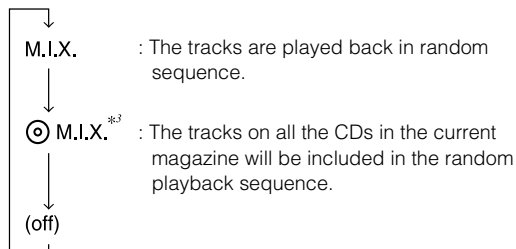

*3 When a CD changer equipped with the ALL M.I.X. function is connected.

- If M.I.X. is set to ON during RPT (REPEAT ALL) play in CD changer mode, M.I.X. will apply to the current disc only.

MP3/WMA/AAC mode :

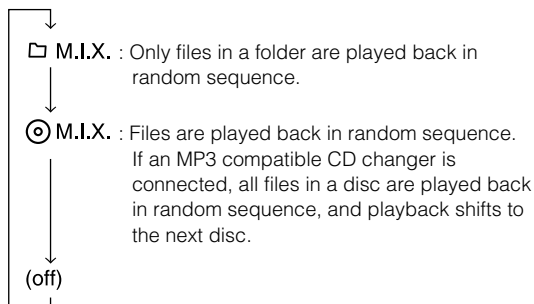

- If a CD changer or an MP3 compatible CD changer is connected: After pressing **FUNC./SETUP** to select the function mode (RPT/M.I.X.), perform the operation within 10 seconds.

Searching from CD Text

Tracks can be searched and played using the CD text on the disc. If a disc is not compatible with text, or a disc is in the changer, searches can be made by track number.

1 Press **Q/ESC** during play.

This will set the search mode.

2 Turn the **Rotary encoder** to select the desired track, and then press **▶/II/ENT**.

This will play the selected track.

- Press and hold **Q/ESC** for at least 2 seconds in the search mode to cancel. Or, the search mode is cancelled if no operation is performed for 10 seconds.
- CD text search cannot be made during M.I.X. play.

File/Folder Name Search (concerning MP3/WMA/AAC)

Folder and file names may be searched and displayed during playback.

1 Press **Q/ESC** to activate the search mode during MP3/WMA/AAC playback.

2 Turn the **Rotary encoder** to select Folder Name Search mode or File Name Search mode, and then press **▶/II/ENT**.

Folder Name Search mode

3 Turn the **Rotary encoder** to select the desired folder.

4 Press and hold **▶/II/ENT** for at least 2 seconds to play back the first file in the selected folder.

- Press and hold **Q/ESC** for at least 2 seconds in the search mode to cancel. Or, the search mode is cancelled if no operation is performed for 10 seconds.
- To search for files in the Folder Name Search mode, press **▶/II/ENT**. Files in the folder may be searched.
- Press **↖/RTN** to exit Folder Name Search mode in step 3 in order to select File Name Search mode.
- The root folder is displayed as “-----”.
- Folder Name search cannot be made during M.I.X. play.

File Name Search mode

3 Press **◀** or **▶** to select another Folder.

4 Select the desired file by turning the **Rotary encoder**.

5 Press **▶/II/ENT** to play back the selected file.

- Press and hold **Q/ESC** for at least 2 seconds in the search mode to cancel. Or, the search mode is cancelled if no operation is performed for 10 seconds.
- Press **↖/RTN** in the search mode to return to the previous mode.
- File Name search cannot be made during M.I.X. play.

Quick Search

You can search for tracks (files).

1 Press and hold \mathcal{Q} /ESC for at least 2 seconds in the CD/Changer/MP3/WMA/AAC mode to activate Quick Search mode.

2 Turn the Rotary encoder to select a desired track (file).

The selected track is played back immediately.

- Press and hold \mathcal{Q} /ESC for at least 2 seconds in the search mode to cancel. Or, the search mode is cancelled if no operation is performed for 10 seconds.

About MP3/WMA/AAC

CAUTION

Except for private use, duplicating audio data (including MP3/WMA/AAC data) or distributing, transferring, or copying it, whether for free or for a fee, without permission of the copyright holder is strictly prohibited by the Copyright Act and by international treaty.

What is MP3?

MP3, whose official name is "MPEG-1 Audio Layer 3", is a compression standard prescribed by the ISO, the International Standardization Organization and MPEG which is a joint activity institution of the IEC.

MP3 files contain compressed audio data. MP3 encoding is capable of compressing audio data at extremely high ratios, reducing the size of music files to as much as one-tenth their original size. This is achieved while still maintaining near CD quality. The MP3 format realises such high compression ratios by eliminating the sounds that are either inaudible to the human ear or masked by other sounds.

What is AAC?

AAC is the abbreviation for "Advanced Audio Coding" and is a basic format of audio compression used by MPEG2 or MPEG4.

What is WMA?

WMA, or "Windows Media™ Audio" is compressed audio data. WMA is similar to MP3 audio data and can achieve CD quality sound with small file sizes.

Method for creating MP3/WMA/AAC files

Audio data is compressed using software with MP3/WMA/AAC codecs. For details on creating MP3/WMA/AAC files, refer to the user's manual for that software.

MP3/WMA/AAC files that are playable on this device have the file extensions:

MP3: ".mp3"

WMA: ".wma" (ver. 7.1, 8 and 9 are supported)

AAC: ".m4a"

There are many different versions of the AAC format. Confirm that the software being used conforms to the acceptable formats listed above. It's possible that the format may be unplayable even though the extension is valid. Playback of AAC files encoded by iTunes version 7.0 or earlier is supported.

Supported playback sampling rates and bit rates

MP3

Sampling rates: 48 kHz, 44.1 kHz, 32 kHz, 24 kHz, 22.05 kHz, 16 kHz, 12 kHz, 11.025 kHz, 8 kHz

Bit rates: 8 - 320 kbps

WMA

Sampling rates: 48 kHz, 44.1 kHz, 32 kHz

Bit rates: 48 - 192 kbps

AAC

Sampling rates: 48 kHz, 44.1 kHz, 32 kHz, 24 kHz, 22.05 kHz, 16 kHz, 12 kHz, 11.025 kHz, 8 kHz

Bit rates: 16 - 320 kbps

This device may not play back correctly depending on sampling rates.

ID3 tags/WMA tags

This device supports ID3 tag v1 and v2, and WMA tag.

If tag data is in an MP3/WMA/AAC file, this device can display the title (track title), artist name, and album name ID3 tag/WMA tag data.

This device can only display single-byte alphanumeric characters (up to 30 for ID3 tags and up to 15 for WMA tags) and the underscore. For non-supported characters, "NO SUPPORT" is displayed.

The tag information may not be correctly displayed, depending on the contents.

Producing MP3/WMA/AAC discs

MP3/WMA/AAC files are prepared, then written to a CD-R or CD-RW using CD-R writing software. A disc can hold up to 510 files/folders (including Root Folders), and the maximum number of folders is 255.

Playback may not be performed if a disc exceeds the limitations described above.

Media supported

The media that this device can play back are CD-ROMs, CD-Rs, and CD-RWs.

Corresponding File Systems

This device supports discs formatted with ISO9660 Level 1 or Level 2.

Under the ISO9660 standard, there are some restrictions to remember.

The maximum nested folder depth is 8 (including the root directory). The number of characters for a folder/file name is limited.

Valid characters for folder/file names are letters A-Z (all caps), numbers 0-9, and ' _ ' (underscore).

This device also can play back discs in Joliet, Romeo, etc., and other standards that conform to ISO9660. However, sometimes the file names, folder names, etc., are not displayed correctly.

Formats supported

This device supports CD-ROM XA, Mixed Mode CD, Enhanced CD (CD-Extra) and Multi-Session.

This device cannot correctly play back discs recorded with Track At Once or packet writing.

Order of files

Files are played back in the order that the writing software writes them to the disc. Therefore, the playback order may not be what is expected. Verify the writing order in the software's documentation. The playback order of the folders and files is as follows.

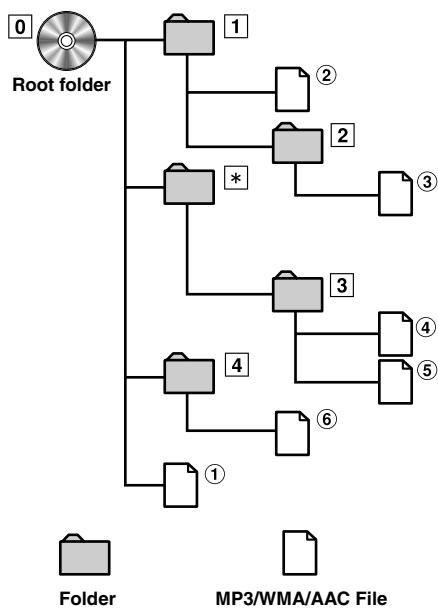

* The folder No./folder Name will not be displayed if no file is contained in the folder.

Terminology

Bit rate

This is the “sound” compression rate specified for encoding. The higher the bit rate, the higher the sound quality, but also the larger the files.

Sampling rate

This value shows how many times per second the data is sampled (recorded). For example, music CDs use a sampling rate of 44.1 kHz, so the sound is sampled (recorded) 44,100 times per second. The higher the sampling rate, the higher the sound quality, but also the larger the volume of data.

Encoding

Converting music CDs, WAVE (AIFF) files, and other sound files into the specified audio compression format.

Tag

Song information such as track titles, artist names, album names, etc., written into MP3/WMA/AAC files.

Root folder

The root folder (or root directory) is found at the top of the file system. The root folder contains all folders and files. It is created automatically for all burned discs.

Sound Setting

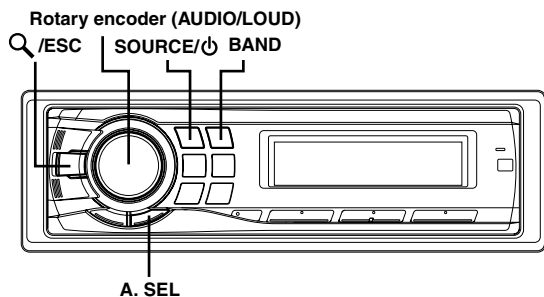

Adjusting Bass/Treble/Balance (Between Left and Right)/Fader (Between Front and Rear)/Defeat

- 1 Press **Rotary encoder (AUDIO)** repeatedly to choose the desired mode.

Each press changes the mode as follows:

SUBWOOFER*¹ → BASS → TREBLE → BALANCE → FADER
→ DEFEAT → VOLUME → SUBWOOFER

Subwoofer: 0 ~ +15

Bass level: -7 ~ +7

Treble level: -7 ~ +7

Balance: L15 ~ R15

Fader: R15 ~ F15

Defeat: ON/OFF

Volume: 0 ~ 35

- If no operation is performed for 5 seconds after selecting the SUBWOOFER, BASS, TREBLE, BALANCE, FADER or DEFEAT mode, the unit automatically returns to normal mode.

*¹ When the subwoofer mode is set to OFF, its level cannot be adjusted.

- 2 Turn the **Rotary encoder (AUDIO)** until the desired sound is obtained in each mode.

By setting Defeat ON, previously adjusted settings of BASS and TREBLE will return to the factory defaults.

- Depending on the connected devices, some functions and display indications do not work.

Setting the Bass Control

You can change the Bass Frequency emphasis to create your own tonal preference.

- 1 Press **A.SEL** to select the **BASS (Bass Centre Frequency)** control mode.

BASS → TREBLE → HPF → BASS

Setting the Bass Centre Frequency

- 2-1 Press **BAND** to select the desired bass centre frequency.

80 Hz → 100 Hz → 200 Hz → 60 Hz → 80 Hz

Emphasizes the displayed bass frequency ranges.

Setting the Bass Bandwidth

- 2-2 Press **SOURCE/⏻** to select the desired bass bandwidth.

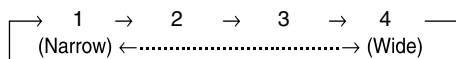

Changes the boosted bass bandwidth to wide or narrow. A wider setting will boost a wide range of frequencies above and below the centre frequency. A narrower setting will boost only frequencies near the centre frequency.

Setting the Bass Level

- 2-3* Turn the **Rotary encoder** to select the desired bass level (-7~+7).

You can emphasize or weaken the bass level.

- 3 Press and hold **Q /ESC** for at least 2 seconds to return to normal mode.

- If no operation is performed for 15 seconds, the unit will return to normal mode automatically.
- The bass level settings will be individually memorized for each source (FM, AM, CD, etc.) until the setting is changed. The bass frequency and bass bandwidth settings adjusted for one source are effective for all other sources (FM, AM, CD, etc.).
- Depending on the connected devices, some functions and display indications do not work. However, Bass Level is still adjustable if an audio processor with the Bass function is connected.
- The function is inoperable when DEFEAT is set to ON.

* The adjustment can also be made by pressing **Rotary encoder (AUDIO)**. Refer to "Adjusting Bass/Treble/Balance (Between Left and Right)/Fader (Between Front and Rear)/Defeat" (page 13).

Setting the Treble Control

You can change the Treble Frequency emphasis to create your own tonal preference.

1 Press **A.SEL** to select the **TREBLE** (Treble Centre Frequency) control mode.

BASS → TREBLE → HPF → BASS

Setting the Treble Centre Frequency

2-1 Press **BAND** to select the desired treble centre frequency.

10.0 kHz → 12.5 kHz → 15.0 kHz → 17.5 kHz → 10.0 kHz

Emphasizes the displayed treble frequency ranges.

Setting the Treble Level

2-2* Turn the **Rotary encoder** to select the desired treble level (-7~+7).

You can emphasize or weaken the treble level.

3 Press and hold **Q/ESC** for at least 2 seconds to return to normal mode.

- If no operation is performed for 15 seconds, the unit will return to normal mode automatically.
- The treble level settings will be individually memorized for each source (FM, AM, CD, etc.) until the setting is changed. The Treble frequency settings adjusted for one source are effective for all other sources (FM, AM, CD, etc.).
- Depending on the connected devices, some functions and display indications do not work. However, Treble Level is still adjustable if an audio processor with the Treble function is connected.
- The function is inoperable when DEFEAT is set to ON.

* The adjustment can also be made by pressing **Rotary encoder (AUDIO)**. Refer to "Adjusting Bass/Treble/Balance (Between Left and Right)/Fader (Between Front and Rear)/Defeat" (page 13).

Adjusting the High Pass Filter

The High Pass Filter on this unit can be adjusted to suit your personal taste.

1 Press **A.SEL** to select the **HPF** (High Pass Filter) mode.

BASS → TREBLE → HPF → BASS

2 Turn the **Rotary encoder** to select the **HPF** frequency.

OFF ↔ 80 Hz ↔ 120 Hz ↔ 160 Hz

3 Press and hold **Q/ESC** for at least 2 seconds to return to normal mode.

- If no operation is performed for 15 seconds, the unit will return to normal mode automatically.
- The function is inoperable when DEFEAT is set to ON.
- When an external audio processor is connected, this setting cannot be made.

Turning Loudness On/Off

Loudness introduces a special low-and high-frequency emphasis at low listening levels. This compensates for the ear's decreased sensitivity to bass and treble sound.

Press and hold **Rotary encoder (LOUD)** for at least 2 seconds to activate or deactivate the loudness mode.

- When an external audio processor is connected, this setting cannot be made.
- The function is inoperable when DEFEAT is set to ON.

Other Functions

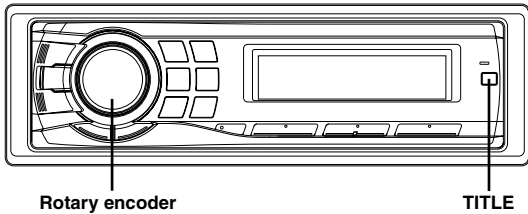

Rotary encoder

TITLE

Displaying the Text

Text information, such as the disc name and the track name, will be displayed if playing a CD text compatible disc. It is also possible to display the folder name, the file name and the tag, etc., while playing MP3/WMA/AAC files.

Press **TITLE**.

The display will change every time the button is pressed.

- If you want to change the display when the **TEXT SCROLL** is set to **SCROLL MANU**, press **TITLE** while the text is scrolling. If the scroll has been completed, press **TITLE** to scroll the text again.

The display in Radio mode:

FREQUENCY → CLOCK → FREQUENCY

The display in CD mode:

TRACK NO./ELAPSED TIME → TRACK NO./CLOCK →
TEXT (DISC NAME)*¹ → TEXT (TRACK NAME)*¹ →
TRACK NO./ELAPSED TIME

The display in MP3/WMA/AAC mode:

FILE NO./ELAPSED TIME → FOLDER NO./FILE NO. →
FILE NO./CLOCK → FOLDER NAME*³ → FILE NAME →
ARTIST NAME*² → ALBUM NAME*² → SONG NAME*² →
FILE NO./ELAPSED TIME

*¹ Displayed during playback of a disc with CD text.

If there is no Text (Disc Name or Track Name), "DISC TEXT"/
"TRACK TEXT" is displayed. "DISC TEXT"/"TRACK TEXT" is
displayed for changer.

*² ID3 tag/WMA tag

If an MP3/WMA/AAC file contains ID3 tag/WMA tag information,
the ID3 tag/WMA tag information is displayed (e.g., song name,
artist name, and album name). All other tag data is ignored.

If the Scroll Setting (page 17) is set to "SCROLL AUTO", the tag
information will scroll automatically.

If there is no tag information, "ARTIST"/"ALBUM"/"SONG" is
displayed.

*³ The root folder is displayed as "FOLDER".

About the indication display

When displaying Text, the following indicators are lit according to the mode.

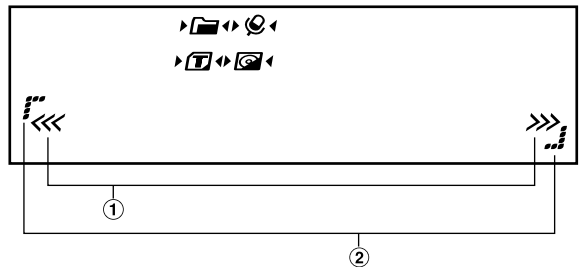

- Blinks in search mode when the **Rotary encoder** is turned. Also Blinks when operation, such as fast forward etc., is performed.
- Lights up in **SETUP** mode.

Indicator/Mode	CD Mode	MP3/WMA/AAC Mode	iPod Mode
	—	Folder Name being displayed	—
	—	Artist Name being displayed	Artist Name being displayed
	Text (Disc Name) being displayed	Album Name being displayed	Album Name being displayed
	Text (Track Name) being displayed	Song Name/ File Name being displayed	Song Name being displayed

About "Text"

Text:

Text compatible CDs contain text information such as the disc name and track name. Such text information is referred to as "text".

- Some characters may not be displayed correctly with this device, depending on the character type.
- The CD changer must also be CD Text compatible for the Text information to be displayed.
- The text or tag information may not be correctly displayed, depending on the contents.

Displaying Time

Press **TITLE** repeatedly until the time is displayed.

Each press changes the display.

For details, see "Displaying the Text" (page 15).

- Selecting any tuner or CD function while in the clock priority mode will interrupt the time display momentarily. The function selected will be displayed for about 5 seconds before the time returns to the display.
- When the power is off but the ignition key is on, press **TITLE** to display or turn off the time.

SETUP

You can flexibly customize the unit to suit your own preferences and usage. From the SETUP menu, Sound Customizing, Visual Customizing, etc., can be modified.

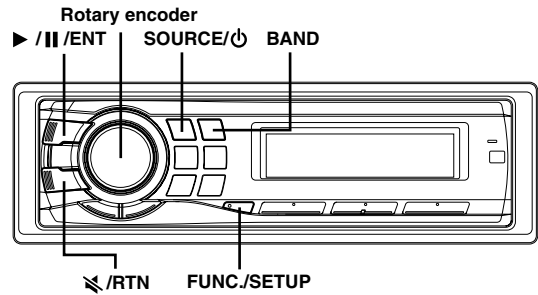

Use steps 1 to 4 to select one of the **SETUP** modes to modify. See the applicable section below for details about the selected **SETUP** item.

- 1 Press and hold **FUNC./SETUP** for at least 2 seconds to activate the **SETUP** mode.**
- 2 Turn the **Rotary encoder** to select the desired item, and then press **>|||/ENT**.**
(e.g. Select SUBWOOFER)

BLUETOOTH IN*¹ ↔ LCD CONTRAST ↔ DIMMER ↔
SUBWOOFER ↔ (SUBW. SYSTEM)*² ↔ PLAY MODE ↔
SCROLL TYPE ↔ TEXT SCROLL ↔ INT MUTE*³ ↔
CLOCK ADJUST ↔ AUX IN ↔ (AUX NAME)*⁴ ↔
CHANGER NAME ↔ DIGITAL AUX ↔ POWER IC ↔
LANGUAGE ↔ DEMO ↔ BLUETOOTH IN

*¹ Displayed only when INT MUTE is OFF.

*² Displayed only when SUBW is ON.

*³ Displayed only when BLUETOOTH IN is OFF.

*⁴ Displayed only when AUX IN is ON.

- 3 Turn the **Rotary encoder** to change the setting.**
(e.g. Select SUBW ON or SUBW OFF.)
- 4 Press and hold **FUNC./SETUP** for at least 2 seconds to return to normal mode.**

- Pressing <⏻/RTN returns to the previous **SETUP** mode.
- If no operation is performed for 60 seconds, **SETUP** is cancelled.

BLUETOOTH IN

Setting the Bluetooth Connection

BT IN ADP / BT IN OFF (Initial setting)

If an optional Bluetooth Box is connected, you can place a hands-free call by a Bluetooth-equipped mobile phone. Make this setting when the Bluetooth Box is connected and the Bluetooth function is used. For details, refer to the Owner's Manual of the optional Bluetooth Box. Set ADP when the Bluetooth Box is connected.

Sound Customizing

Subwoofer On and Off

SUBW. ON (Initial setting) / SUBW. OFF

When the subwoofer is on, perform the steps below to adjust the subwoofer output level.

- 1 In the normal mode, press the Rotary encoder repeatedly to select the SUBWOOFER mode.
SUBWOOFER → BASS → TREBLE → BALANCE →
FADER → DEFEAT → VOLUME → SUBWOOFER
- 2 Adjust the level by turning the Rotary encoder.

Setting the Subwoofer System

SUBW. SYS 1 (Initial setting) / SUBW. SYS 2

Select either SYS 1 or SYS 2 for the desired subwoofer effect.

- SUBW. SYS 1: Subwoofer level changes according to the main volume setting.
- SUBW. SYS 2: Subwoofer level change is different from the main volume setting. For example, even at low volume settings, the subwoofer is still audible.

Visual Customizing

Dimmer Control

DIMMER AUTO (Initial setting) / DIMMER MANU

Set the DIMMER control to AUTO to decrease the illumination brightness of the unit with the head lights of the vehicle ON. This mode is useful if you feel the unit's backlighting is too bright at night.

Scroll Type Setting

SCROLL TYPE1 / SCROLL TYPE2 (Initial setting)

Choose from two scrolling methods. Select the type you prefer.

- SCROLL TYPE1: The characters scroll from right to left, a single character at a time, until the entire title has scrolled.
- SCROLL TYPE2: Words are built up from left to right, a single character at a time. When the display is filled, it is cleared and the remaining words are displayed the same way until all words of the title have been shown.

Scroll Setting (TEXT SCROLL)

SCROLL AUTO / SCROLL MANU (Initial setting)

This CD player can scroll the disc and track names recorded on CD-TEXT discs, as well as the text information of MP3/WMA/AAC files, folder names and tags.

SCROLL AUTO: CD text information, folder and file names are scrolled continuously. In addition, all tag information is automatically rotated into the display continuously, without pressing the TITLE button.

SCROLL MANU: The above information is scrolled only when a disc is loaded, a channel or track is changed, etc.

- The unit scrolls CD text names, folder names, file names or tag display.

Setting the Language Font

LANGUAGE 1 (Initial setting) / LANGUAGE 2

Two types of font can be selected.

LANGUAGE 1: Normal font

LANGUAGE 2: European font

Adjusting Display Contrast

CONTRAST

You can adjust the display contrast for better visibility.

You can adjust in a range of -5 and +3.

- The initial setting at the factory is "0".

Demonstration

DEMO ON / DEMO OFF (Initial setting)

This unit has a demonstration feature for the display.

- To quit Demo mode, set to DEMO OFF.

MP3/WMA/AAC

Playing MP3/WMA/AAC Data (PLAY MODE)

CD-DA (Initial setting) / CD-DA&MP3

This unit can play back CDs containing both CD and MP3/WMA/AAC data (created in Enhanced CD (CD Extra) format). However, in some situations, playback of an enhanced CD may be difficult. In this case, you can select playback of a single session only, containing the CD data. When a disc contains both CD and the MP3/WMA/AAC data, playback starts from the CD data portion of the disc.

CD-DA: Only the CD data in session 1 can be played back.

CD-DA&MP3: CD data, MP3/WMA/AAC files in mixed mode, and multi-session discs can be played back.

- Perform this setting before inserting a disc. If a disc has already been inserted, remove it first. (If you use an MP3 changer, you have to change discs).

External Device

Connecting to an External Amplifier

POWER IC ON (Initial setting) / POWER IC OFF

When an external amplifier is connected, sound quality can be improved by stopping the power supply of the built-in amplifier.

POWER IC OFF: Use this mode when the line output of this unit is used to drive an external amplifier. In this setting, the head unit's internal amplifier is turned OFF and can not drive speakers.

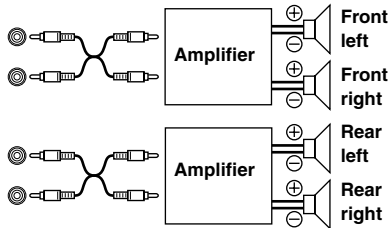

POWER IC ON: The speakers are driven by the built-in amplifier.

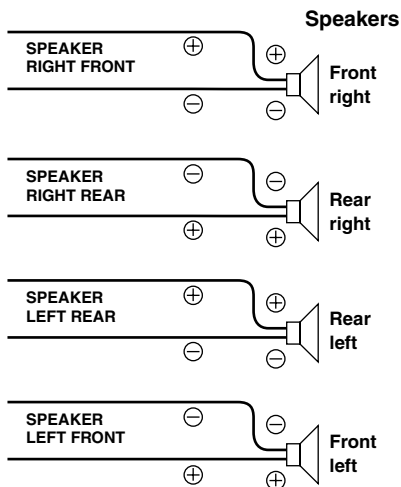

- No sound is produced by the system when the power output is set to OFF.

General Setting

Turning Mute Mode On/Off (INT MUTE)

MUTE ON / MUTE OFF (Initial setting)

If a device having the interrupt feature is connected, audio will be automatically muted whenever the interrupt signal is received from the device.

Setting the AUX Mode (V-Link)

AUX IN ON / AUX IN OFF (Initial setting)

You can input TV/video sound by connecting an optional Ai-NET/RCA Interface cable (KCA-121B) or Versatile Link Terminal (KCA-410C) to this component.

You can change the AUX name display when AUX IN is set to ON. Press **▶ / || / ENT** when AUX IN is set to ON, and select AUX NAME by turning the **Rotary encoder**, and then press **▶ / || / ENT**. After that, turn the **Rotary encoder** to select the desired AUX name. If the KCA-410C is connected, it is possible to select two AUX names.

- Via KCA-410C, up to 2 external devices with RCA output can be connected. In this case, press **SOURCE/⏻** to select AUX mode and then press **BAND** to select your desired device.

Changer Name Setting

CHANGER (Initial Setting) / USB / PORTABLE

This setting is used when the head unit is connected to the USB Adapter for MP3 (KCA-620M). You can set the name to be displayed on the unit depending on the device to which the USB Adapter for MP3 (KCA-620M) is connected.

Setting the External Digital Input

D-AUX ON / D-AUX OFF (Initial setting)

When an ALPINE Ai-NET compatible digital audio processor (PXA-H701) and a DVD player (DVE-5207) not compatible with Ai-NET are connected, set Digital AUX to ON to enjoy 5.1-channel surround sound.

- Press **SOURCE/⏻**, and select the **DIGITAL-AUX** mode, and adjust the volume, etc.
- Depending on the connected audio processor, DVD player sound may continue to be output, even though the source is changed to another one. If this occurs, set the DVD player's power to OFF.

iPod® (Optional)

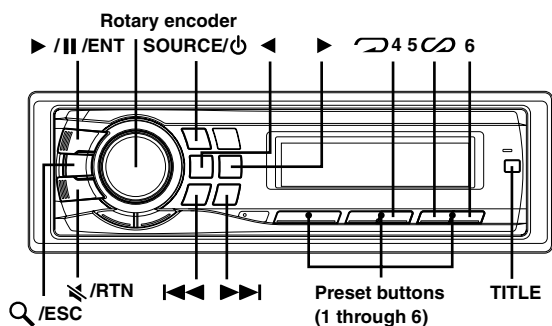

An iPod® can be connected to this unit by using the proprietary ALPINE FULL SPEED™ Connection Cable (KCE-422i) (sold separately). When this unit is connected by using the cable, the controls on the iPod are not functional.

iPods usable with this unit

- The unit can be used with the fourth generation and above iPod, iPod photo, iPod minis or iPod nano. iPod Shuffle can not be used, however.
- Touch wheel or scroll wheel type iPods without the dock connector cannot be connected to the unit.
- The unit can be used with the following iPod versions. Correct function of earlier versions cannot be guaranteed.

Fourth generation iPod: Ver. 3.1.1

Fifth generation iPod: Ver. 1.1.2

iPod photo: Ver. 1.2.1

iPod mini: Ver. 1.4.1

iPod nano: Ver. 1.2

- *The unit cannot be used with software versions earlier than “2006-06-28”. For details about “iPod Software Update”, refer to the iPod Instruction Manual.*

Playback

1 Press SOURCE/⏻ to switch to the iPod mode.

TUNER → DISC → iPod*¹ → CHANGER*² → TUNER

*¹ Only when the iPod is connected.

*² Only when the CD changer is connected.

2 Press ◀◀ or ▶▶ to select the desired song.

Return to the beginning of the current song:

Press ◀◀.

Fast backward:

Press and hold ◀◀.

Advance to the beginning of the next song:

Press ▶▶.

Fast forward:

Press and hold ▶▶.

3 To pause playback, press ▶/||/ENT.

Pressing ▶/||/ENT again will resume playback.

- A song playing on the iPod while it is connected to this unit will continue to play from where it was paused after disconnection.

Searching for a desired Song

An iPod can contain hundreds of songs. By using file tag information and keeping these songs organised in playlists, this unit's search functions will ease song searches.

Each music category has its own individual hierarchy. Use the Playlist/Artist/Album/Song/Podcast/Genre/Composer search mode to narrow searches based on the table below.

Hierarchy 1	Hierarchy 2	Hierarchy 3	Hierarchy 4
Playlist	Song	—	—
Artist*	Album*	Song	—
Album*	Song	—	—
Song	—	—	—
Podcast	Episode	—	—
Genre*	Artist*	Album*	Song
Composer*	Album*	Song	—

For example: Searching by Artist name

The following example explains how an ARTIST search is performed. Another search mode can be used for the same operation, although the hierarchy differs.

1 Press Q/ESC to activate the search selection mode.

2 Turn the Rotary encoder to select the Artist search mode, and then press ▶/||/ENT.

PLAYLIST ↔ ARTIST ↔ ALBUM ↔ SONG ↔ PODCAST
↔ GENRE ↔ COMPOSER ↔ PLAYLIST

3 Turn the Rotary encoder to select the desired Artist, and then press ▶/||/ENT.

4 Turn the Rotary encoder to select an album, and then press ▶/||/ENT.



5 Turn the Rotary encoder to select a song and press ▶/||/ENT.

The selected song is played back.

- After pressing and holding ▶/||/ENT for at least 2 seconds while in each hierarchy (except SONG hierarchy), all songs of the selected hierarchy are played back.
- After selecting [ALL] in the search mode with “*”, press and hold ▶/||/ENT for at least 2 seconds to play back all songs in the iPod or selected search mode.
- While in the search mode, if you press and hold Q/ESC for at least 2 seconds, or no operation is performed for 10 seconds, the search mode is cancelled.
- In the search mode, pressing ◀/RTN will return to the previous mode.
- Search can not be made during M.I.X. play.
- “NO SONG” will be displayed if there is no song in the selected playlist in the playlist search mode.
- “NO PODCAST” will be displayed if there is no podcast data in the iPod in the PODCAST search mode.
- If “iPod name” stored in the iPod is selected in the desired playlist search mode and ▶/||/ENT is pressed, you can search for all songs in the iPod. Also, if you press and hold ▶/||/ENT for at least 2 seconds, all songs in the iPod are played back.
- Depending on the iPod, podcast search is not supported.
- If any one of the preset buttons (1 through 6) is pressed in the search mode, a search can be made quickly by skipping to the specified location. For details, refer to “Direct Search Function” on page 20.

Quick Search

You can search a song from all songs in the iPod without selecting an album, artist, etc.

- 1 Press and hold /ESC for at least 2 seconds to activate the Quick Search mode.**
- 2 Turn the Rotary encoder to select a desired song.**
The selected song is played back immediately.
 - While in the search mode, if you press and hold /ESC for at least 2 seconds, or no operation is performed for 10 seconds, the search mode is cancelled.
 - If many songs are in iPod, it takes time to search for songs.
 - If any one of the **preset buttons (1 through 6)** is pressed in the search mode, a search can be made quickly by skipping to the specified location. For details, refer to "Direct Search Function" on page 20.

Direct Search Function

The unit's direct search function can be used to search for an album, song, etc., more efficiently. In the Playlist/Artist/Album/Song/Podcast/Genre/Composer mode, You can quickly target any song.

In the search mode, press any one of the preset buttons (1 through 6) to quickly skip over a designated percent of your song content.

Song search example:

If there are 100 songs in your iPod, they are divided into 6 groups using percentages (shown below). These groups are assigned to preset buttons (1 through 6).

Example 1:

Suppose the song you are searching for is located at around the middle (50%) of your library: press button 4 to jump to the 50th song and turn the Rotary encoder to find the desired song.



Example 2:

Suppose the song you are searching for is located near the end (83%) of your library: press button 6 to jump to the 83rd song and turn the Rotary encoder to find the desired song.

	All 100 songs (100%)					
	0%	17%	33%	50%	67%	83%
Preset buttons	1	2	3	4	5	6
Songs	First song	17th song	33rd song	50th song	67th song	83rd song

Select Playlist/Artist/Album/Podcast/Genre/Composer

Playlist/Artist/Album/Podcast/Genre/Composer can be easily changed. For example, if you listen to a song from a selected album, the album can be changed.

Press  or  to select the desired Playlist/Artist/Album/Podcast/Genre/Composer.

- If the song search mode was used to select a song, this function is inactive.
- If an album is selected during an artist search, other albums by that artist are searchable.
- This function is inactive during shuffle (M.I.X.) playback.

Random Play Shuffle (M.I.X.)

The Shuffle function of the iPod is displayed as M.I.X. on this unit.

Shuffle Albums:

The songs on each album are played back in proper order. Upon completion of all the songs on the album, the next album is selected randomly. This continues until all albums have been played.

Shuffle Songs:

Song shuffle randomly plays back songs within a selected category (playlist, album, etc.). The songs within the category are played just once until all songs have been played.

1 Press 5 .

The songs are played back in random sequence.

 M.I.X. → M.I.X. → (off) →  M.I.X.
(Shuffle Albums) (Shuffle Songs)

2 To cancel M.I.X. play, select (off) with the above procedure.

- If a song is selected in the album search mode before selecting M.I.X. play, the songs will not play back randomly even when Shuffle Albums is selected.

Shuffle ALL:

Shuffle ALL plays all songs in the iPod randomly. Any one song does not play back again until all songs have been played back.

1 Press 6.

The songs are played back in random sequence.

M.I.X. → (off) → M.I.X.
(Shuffle ALL)

2 To cancel M.I.X. play, select (off) with the above procedure.

- If Shuffle ALL is selected, the selected songs being played back in the search mode are cancelled.

Repeat Play

Only Repeat One is available for the iPod.

Repeat One:



A single song is repeatedly played back.

1 Press 4.

The song is played back repeatedly.

RPT → (off) → RPT
(Repeat One)

2 To cancel repeat play, select (off) with the above procedure.

- During repeat playback, no other songs are selectable by pressing  or .

Displaying the Text

You can display the tag information of a song in the iPod.

Press **TITLE**.

Each press changes the display.

- If you want to change the display when the **TEXT SCROLL** is set to **SCROLL MANU**, press **TITLE** while the text is scrolling. If the scroll has been completed, press **TITLE** to scroll the text again.

TRACK NO./ELAPSED TIME → TRACK NO./CLOCK →
ARTIST NAME* → ALBUM NAME* →
SONG TITLE* → TRACK NO./ELAPSED TIME

* TAG information

“ARTIST”/“ALBUM”/“SONG” is displayed if there is no tag information.

- Only alphanumeric characters (ASCII) can be displayed.
- If the artist, album or song name, created in iTunes, has too many characters, songs may not be played back when connected to the adapter. Therefore, a maximum of 250 characters is recommended. The maximum number of characters for the head unit is 128 (128 byte).
- Some characters may not be correctly displayed.
- “NO SUPPORT” is displayed if text information is not supported by the unit.

Changer (Optional)

▶ /II/ENT SOURCE/⏻ BAND

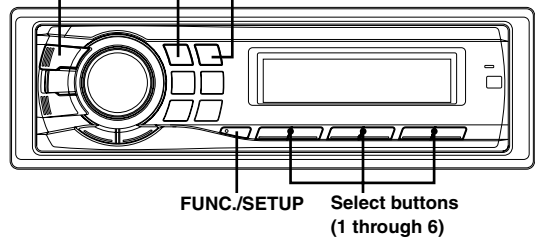

Controlling CD Changer (Optional)

An optional 6-disc or 12-disc CD Changer may be connected to this unit if it is Ai-NET compatible. With a CD Changer connected to the Ai-NET input of this unit, the CD Changer will be controllable from this unit.

Using the KCA-400C (Multi-Changer Switching device) or the KCA-410C (Versatile Link Terminal) multiple changers can be controlled by this unit.

See “Multi-Changer Selection (Optional)” on page 22 for selecting the CD Changers.

- The controls on this unit for CD Changer operation are operative only when a CD Changer is connected.
- The DVD changer (optional) is controllable from this unit as well as the CD changer.

1 Press **SOURCE/⏻** to activate the **CHANGER** mode.

- The source indicator varies depending on the connected source.
- Press **BAND** to switch the Disc mode in the Changer mode.

2 Press **FUNC./SETUP** to activate **Disc Select** mode.

Disc Select Mode → Disc Select Mode * →
(Disc No.1~6) → (Disc No.7~12)

RPT/M.I.X. Mode → Disc Select Mode
(Disc No.1~6)

3 Press the disc select buttons (1 through 6) corresponding to one of the discs loaded in the CD Changer.

The selected disc number appears in the display and CD/MP3 playback starts.

- After selecting the desired disc, you can operate in the same way as for the CD player of this unit. For details, please see the CD/MP3/WMA/AAC section.

* When a 12-disc CD changer is connected.

Playing MP3 Files with the CD Changer (Optional)

If you connect a changer compatible with MP3, you can play CD-ROMs, CD-Rs, and CD-RWs containing MP3 files on this unit.

- 1 Press **SOURCE/⏻** to switch to the MP3 Changer mode.
- 2 Press any one of the disc select buttons (1 through 6) corresponding to one of the discs loaded in the CD Changer.
- 3 To pause playback, press **▶ /|| /ENT**.
Pressing **▶ /|| /ENT** again will resume playback.

- The unit can play discs containing both audio data and MP3 data.
- For operating MP3 with an MP3 compatible CD Changer, refer to "CD/MP3/WMA/AAC" pages 9 to 12.

Multi-Changer Selection (Optional)

Alpine's Ai-NET system will support up to 6 CD Changers. When operating two or more changers, the KCA-400C (Multi-Changer Switching device) must be used. If you use 1 Switching device, you can connect up to 4 CD Changers. If you use 2 Switching devices, you can connect up to 6 CD Changers. When using KCA-410C (Versatile Link Terminal), you can connect two changers and two external outputs (AUX).

- 1 Press **SOURCE/⏻** on this unit to activate the CD Changer mode.
Alternatively, press SOURCE on the remote control (RUE-4202) to activate the CD Changer mode.

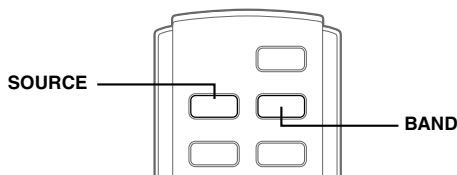

- 2 Press **BAND** on this unit or the RUE-4202 to activate the CD Changer Selection mode.
The CD Changer Selection mode remains active for a few seconds.

- 3 Press **BAND** until the desired CD Changer indicator appears on the display.
Alternatively press BAND on the Remote Control until the desired changer indicator appears on the display.

- If the selected CD Changer is not connected, the display will show "NO CHANGER - (No.)".
- To operate the selected changer, see "CD/MP3/WMA/AAC" (pages 9 to 12).
- For further details about the external input (AUX) when using KCA-410C, see "Setting the AUX Mode (V-Link)" on page 18.

Remote Control

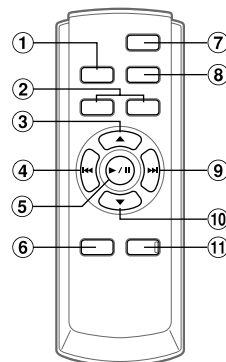

Controls on Remote Control

- ① **Source Button**
Press this button to select the audio source.
 - ② **Volume Adjustment Buttons**
To increase the volume level:
Press the **▲** button

To decrease the volume level:
Press the **▼** button
 - ③ **▲ Button**
Radio mode: Pressing this button will select, in ascending order, stations programmed into the radio's presets as shown below.
1 → **2** ... **6** → **1**

CD Changer mode: DISC Select (UP) button
Press this button to select a disc in ascending order.

MP3/WMA/AAC mode: Folder Select (UP) button
Press this button to select the folder.

MP3 compatible CD changer mode:
Folder Select (UP) / DISC Select (UP) button
Press this button to select a folder in ascending order. Press and hold this button to select a disc in ascending order.
iPod mode: Switches Playlist/Artist/Album.
 - ④ **◀◀ DN Button**
Radio mode: SEEK (DN) Button
CD/iPod mode: Press this button to go back to the beginning of the current track.
 - ⑤ **▶ /|| Button**
Press this button to switch between the Play and Pause modes for CD.
 - ⑥ **Audio Processor Button**
Press the button to call the external audio processor mode when the external audio processor is connected*1.
- *1 For the operation of external audio processor, refer to the Owner's Manual of the external audio processor you purchased.
- ⑦ **Power Button**
Press this button to turn the power on/off.

⑧ **Band Button**

Radio mode: BAND Button

Press this button and the band will change.

Changer mode: To switch the changer.

⑨ **▶▶ UP Button**

Radio mode: SEEK (UP) button

CD/iPod mode: Press this button to advance to the beginning of the next track.

⑩ **▼ Button**

Radio mode: Pressing this button will select, in descending order, stations programmed into the radio's presets as shown below.

6 → 5 ... 1 → 6

CD Changer mode: DISC Select (DN) button

Press this button to select a disc in descending order.

MP3/WMA/AAC mode: Folder Select (DN) button

Press this button to select the folder.

MP3 compatible CD changer mode:

Folder Select (DN) / DISC Select (DN) button

Press this button to select a folder in descending order.

Press and hold this button to select a disc in descending order.

iPod mode: Switches Playlist/Artist/Album.

⑪ **Mute Button**

Press this button to lower the volume by 20 dB instantly.

Press this button again to cancel.

Battery Replacement

Applicable battery: Use two "AAA" sized dry batteries or equivalent.

1 Opening the battery cover

Slide out the battery cover while firmly pressing in the direction of the arrow.

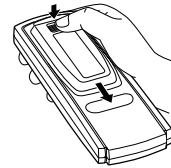

2 Replacing the battery

Insert the batteries, observing the polarities as illustrated.

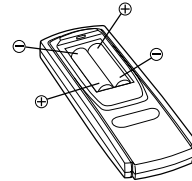

3 Closing the cover

Slide the cover as illustrated until a click is heard.

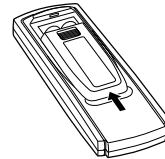

Controllable With Remote Control

Point the remote control transmitter at the remote control sensor.

Remote control sensor

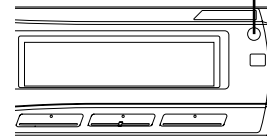

Connectable to Remote Control Interface Box

This unit may be controlled from the vehicle's audio controls. An optional Alpine Remote Control Interface Box must be used. For details, contact your Alpine dealer.

Information

In Case of Difficulty

If you encounter a problem, please turn the power off, then on again. If the unit is still not functioning normally, please review the items in the following checklist. This guide will help you isolate the problem if the unit is at fault. Otherwise, make sure the rest of your system is properly connected or consult your authorized Alpine dealer.

Basic

No function or display.

- Vehicle's ignition is off.
 - If connected following instructions, the unit will not operate with the vehicle's ignition off.
- Improper power lead (Red) and battery lead (Yellow) connections.
 - Check power lead and battery lead connections.
- Blown fuse.
 - Check the fuse of the unit; replace with the proper value if necessary.
- Internal micro-computer malfunctioned due to interference noise etc.
 - Press the RESET switch with a ballpoint pen or other pointed article.

Radio

Unable to receive stations.

- No antenna or open connection in cable.
 - Make sure the antenna is properly connected; replace the antenna or cable if necessary.

Unable to tune stations in the seek mode.

- You are in a weak signal area.
 - Make sure the tuner is in the DX mode.
- If the area you are in is a primary signal area, the antenna may not be grounded and connected properly.
 - Check your antenna connections; make sure the antenna is properly grounded at its mounting location.
- The antenna may not be the proper length.
 - Make sure the antenna is fully extended; if broken, replace the antenna with a new one.

Broadcast is noisy.

- The antenna is not the proper length.
 - Extend the antenna fully; replace it if it is broken.
- The antenna is poorly grounded.
 - Make sure the antenna is grounded properly at its mounting location.

CD

CD Player/Changer not functioning.

- Out of operating temperature range +50°C (+120°F) for CD.
 - Allow the vehicle's interior (or trunk) temperature to cool.

CD playback sound is wavering.

- Moisture condensation in the CD Module.
 - Allow enough time for the condensation to evaporate (about 1 hour).

CD insertion not possible.

- A CD is already in the CD player.
 - Eject the CD and remove it.
- The CD is being improperly inserted.
 - Make sure the CD is being inserted following instructions in the CD Player Operation section.

Unable to fast forward or backward the CD.

- The CD has been damaged.
 - Eject the CD and discard it; using a damaged CD in your unit can cause damage to the mechanism.

CD playback sound skips due to vibration.

- Improper mounting of the unit.
 - Securely re-mount the unit.
- The disc is very dirty.
 - Clean the disc.
- The disc has scratches.
 - Change the disc.
- The pick-up lens is dirty.
 - Do not use a commercially available lens cleaner disc. Consult your nearest Alpine dealer.

CD playback sound skips without vibration.

- The disc is dirty or scratched.
 - Clean the disc; damaged disc should be replaced.

Error displays (built-in CD player only).

- Mechanical error.
 - Press . After the error indication disappears, insert the disc again. If the above-mentioned solution does not solve the problem, consult your nearest Alpine dealer.

CD-R/CD-RW playback not possible.

- Close session (finalization) has not been performed.
 - Perform finalization and attempt playback again.

MP3/WMA/AAC

MP3, WMA or AAC is not played back.

- Writing error occurred. The CD format is not compatible.
 - Make sure the CD has been written in a supported format. Refer to "About MP3/WMA/AAC" (pages 11-12), then rewrite in the format supported by this device.

Audio

The sound is not output from the speakers.

- Unit has no output signal of the internal amplifier.
 - POWER IC is switched to "ON" (page 18).

iPod

iPod does not play and no sound is output.

- The iPod has not been recognized.
 - Reset this unit and the iPod. Refer to "Initial System Start-Up" (page 7). To reset the iPod, refer to the Owner's Manual of the iPod.

Indication for CD Player

HIGH-TEMP

- Protective circuit is activated due to high temperature.
 - The indication will disappear when the temperature returns to normal operating range.

NO DISC

- No CD is inserted.
 - Insert a CD.
- Although a disc is inserted, "No Disc" is displayed and the unit does not start to play or eject the disc.
 - Remove the disc by following these steps:
 - Press the **▲** button again for at least 2 seconds.
 - If the disc still does not eject, consult your Alpine dealer.

ERROR

- Mechanism error.
 - 1) Press the **▲** button and eject the CD.
 - If not ejecting, consult your Alpine dealer.
 - 2) When the error indication remains after ejecting, press the **▲** button again.
 - If the error indication still does not turn off after pressing the **▲** button for a few times, consult your Alpine dealer.
- *When "Error" is displayed:*
 - If the disc cannot be ejected by pressing **▲**, press the RESET switch (refer to page 7) and press **▲** again.*
 - If the disc still cannot be ejected, consult your Alpine dealer.*

PROTECT

- A copy-protected WMA file was played back.
 - You can only play back non-copy-protected files.

UNSUPPORTED

- A sampling rate/bit rate not supported by the unit is used.
 - Use a sampling rate/bit rate that is supported by the unit.

Indication for CD Changer

HIGH-TEMP

- Protective circuit is activated due to high temperature.
 - The indication will disappear when the temperature returns to normal operating range.

ERROR-01

- Malfunction in the CD Changer.
 - Consult your Alpine dealer. Press the magazine eject button and pull out the magazine.
 - Check the indication. Insert the magazine again.
 - If the magazine cannot be pulled out, consult your Alpine dealer.
- Magazine ejection not possible.
 - Press the magazine eject button. If the magazine does not eject, consult your Alpine dealer.

ERROR-02

- A disc is left inside the CD Changer.
 - Press the eject button to activate the eject function. When the CD Changer finishes the eject function, insert an empty CD magazine into the CD Changer to receive the disc left inside the CD Changer.

NO MAGZINE

- No magazine is loaded into the CD Changer.
 - Insert a magazine.

NO DISC

- No indicated disc.
 - Choose another disc.

Indication for iPod Mode

NO iPod

- The iPod is not connected.
 - Make sure the iPod is correctly connected (refer to "Connections").
 - Make sure the cable is not bent excessively.
- The iPod's battery remains low.
 - Refer to the iPod's documentation and charge the battery.

NO SONG

- There are no songs in the iPod.
 - Download songs to the iPod and connect to this unit.

NO PODCAST

- There is no podcast data in the iPod.
 - Download podcast data to the iPod and connect to this unit.

ERROR-01

- Communication error.
 - Turn the ignition key off, and then set to ON again.
 - Check the display by reconnecting between the iPod and the adapter, using the iPod cable.

ERROR-02

- Caused by the iPod Software Version not being compatible with this unit.
 - Update the iPod Software Version to be compatible with this unit.

Specifications

FM TUNER SECTION

Tuning Range	87.5-108.0 MHz
Mono Usable Sensitivity	9.3 dBf (0.8 μ V/75 ohms)
50 dB Quieting Sensitivity	13.5 dBf (1.3 μ V/75 ohms)
Alternate Channel Selectivity	80 dB
Signal-to-Noise Ratio	65 dB
Stereo Separation	35 dB
Capture Ratio	2.0 dB

AM TUNER SECTION

Tuning Range	531-1,602 kHz
Sensitivity (IEC Standard)	22.5 μ V/27 dB

CD PLAYER SECTION

Frequency Response	5-20,000 Hz (\pm 1 dB)
Wow & Flutter (% WRMS)	Below measurable limits
Total Harmonic Distortion	0.008% (at 1 kHz)
Dynamic Range	95 dB (at 1 kHz)
Signal-to-Noise Ratio	105 dB
Channel Separation	85 dB (at 1 kHz)

PICKUP

Wave length	795 nm
Laser power	CLASS I

GENERAL

Power Requirement	14.4 V DC (11-16 V allowable)
Maximum Power Output	50 W \times 4
Maximum Pre-Output Voltage	2 V/10 k ohms
Bass	+14/-14 dB at 100 Hz
Treble	\pm 14 dB at 10 kHz
Weight	1.6 kg (3 lbs. 8 oz)

CHASSIS SIZE

Width	178 mm (7")
Height	50 mm (2")
Depth	162 mm (6-3/8")

NOSEPIECE SIZE

Width	170 mm (6-3/4")
Height	46 mm (1-13/16")
Depth	24 mm (15/16")

- *Due to continuous product improvement, specifications and design are subject to change without notice.*

Installation and Connections

Before installing or connecting the unit, please read the following and pages 3 to 5 of this manual thoroughly for proper use.

Warning

MAKE THE CORRECT CONNECTIONS.

Failure to make the proper connections may result in fire or product damage.

USE ONLY IN CARS WITH A 12 VOLT NEGATIVE GROUND.

(Check with your dealer if you are not sure.) Failure to do so may result in fire, etc.

BEFORE WIRING, DISCONNECT THE CABLE FROM THE NEGATIVE BATTERY TERMINAL.

Failure to do so may result in electric shock or injury due to electrical shorts.

DO NOT SPLICE INTO ELECTRICAL CABLES.

Never cut away cable insulation to supply power to other equipment. Doing so will exceed the current carrying capacity of the wire and result in fire or electric shock.

DO NOT DAMAGE PIPE OR WIRING WHEN DRILLING HOLES.

When drilling holes in the chassis for installation, take precautions so as not to contact, damage or obstruct pipes, fuel lines, tanks or electrical wiring. Failure to take such precautions may result in fire.

DO NOT USE BOLTS OR NUTS IN THE BRAKE OR STEERING SYSTEMS TO MAKE GROUND CONNECTIONS.

Bolts or nuts used for the brake or steering systems (or any other safety-related system), or tanks should NEVER be used for installations or ground connections. Using such parts could disable control of the vehicle and cause fire etc.

KEEP SMALL OBJECTS SUCH AS BATTERIES OUT OF THE REACH OF CHILDREN.

Swallowing them may result in serious injury. If swallowed, consult a physician immediately.

DO NOT INSTALL IN LOCATIONS WHICH MIGHT HINDER VEHICLE OPERATION, SUCH AS THE STEERING WHEEL OR SHIFT LEVER.

Doing so may obstruct forward vision or hamper movement etc. and results in serious accident.

DO NOT ALLOW CABLES TO BECOME ENTANGLED IN SURROUNDING OBJECTS.

Arrange wiring and cables in compliance with the manual to prevent obstructions when driving. Cables or wiring that obstruct or hang up on places such as the steering wheel, shift lever, brake pedals, etc. can be extremely hazardous.

Caution

HAVE THE WIRING AND INSTALLATION DONE BY EXPERTS.

The wiring and installation of this unit requires special technical skill and experience. To ensure safety, always contact the dealer where you purchased this product to have the work done.

USE SPECIFIED ACCESSORY PARTS AND INSTALL THEM SECURELY.

Be sure to use only the specified accessory parts. Use of other than designated parts may damage this unit internally or may not securely install the unit in place. This may cause parts to become loose resulting in hazards or product failure.

ARRANGE THE WIRING SO IT IS NOT CRIMPED OR PINCHED BY A SHARP METAL EDGE.

Route the cables and wiring away from moving parts (like the seat rails) or sharp or pointed edges. This will prevent crimping and damage to the wiring. If wiring passes through a hole in metal, use a rubber grommet to prevent the wire's insulation from being cut by the metal edge of the hole.

DO NOT INSTALL IN LOCATIONS WITH HIGH MOISTURE OR DUST.

Avoid installing the unit in locations with high incidence of moisture or dust. Moisture or dust that penetrates into this unit may result in product failure.

Precautions

- Be sure to disconnect the cable from the (-) battery post before installing your CDA-9883E. This will reduce any chance of damage to the unit in case of a short-circuit.
- Be sure to connect the colour coded leads according to the diagram. Incorrect connections may cause the unit to malfunction or damage to the vehicle's electrical system.
- When making connections to the vehicle's electrical system, be aware of the factory installed components (e.g. on-board computer). Do not tap into these leads to provide power for this unit. When connecting the CDA-9883E to the fuse box, make sure the fuse for the intended circuit of the CDA-9883E has the appropriate amperage. Failure to do so may result in damage to the unit and/or the vehicle. When in doubt, consult your Alpine dealer.
- The CDA-9883E uses female RCA-type jacks for connection to other units (e.g. amplifier) having RCA connectors. You may need an adaptor to connect other units. If so, please contact your authorized Alpine dealer for assistance.
- Be sure to connect the speaker (-) leads to the speaker (-) terminal. Never connect left and right channel speaker cables to each other or to the vehicle body.

IMPORTANT

Please record the serial number of your unit in the space provided below and keep it as a permanent record. The serial number or the engraved serial number is located on the bottom of the unit.

SERIAL NUMBER: _____

INSTALLATION DATE: _____

INSTALLATION TECHNICIAN: _____

PLACE OF PURCHASE: _____

Installation

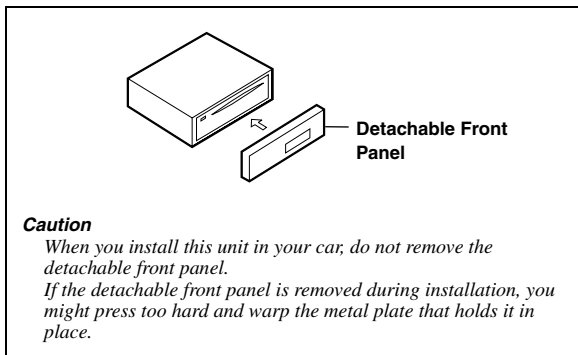

- The main unit must be mounted within 35 degrees of the horizontal plane, back to front.

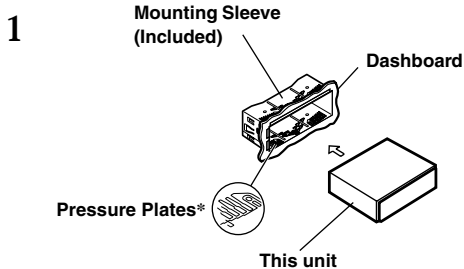
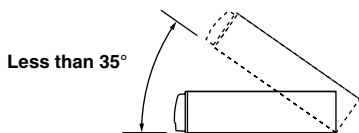

* If the installed mounting sleeve is loose in the dashboard, the pressure plates may be bent slightly to remedy the problem.

Remove the mounting sleeve from the main unit (see "Removal" on page 29).

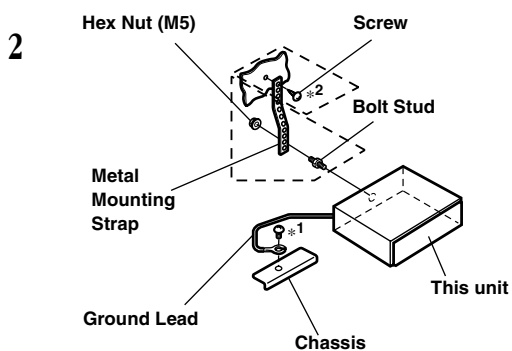

Reinforce the head unit with the metal mounting strap (not supplied). Secure the ground lead of the unit to a clean metal spot using a screw (*1) already attached to the vehicle's chassis.

- For the screw marked "*2", use an appropriate screw for the chosen mounting location.

Connect each input lead coming from an amplifier or equalizer to the corresponding output lead coming from the left rear of the CDA-9883E. Connect all other leads of the CDA-9883E according to details described in the CONNECTIONS section.

3

Slide the CDA-9883E into the dashboard until it clicks. This ensures that the unit is properly locked and will not accidentally come out from the dashboard.

Removal

1. Remove the detachable front panel.
2. Insert the bracket keys into the unit, along the guides on either side. The unit can now be removed from the mounting sleeve.

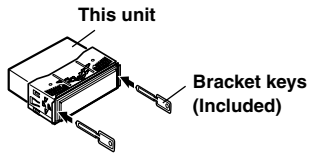

3. Pull the unit out, keeping it unlocked as you do so.

<JAPANESE CAR>

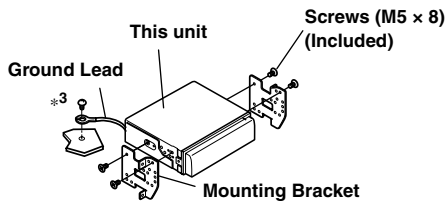
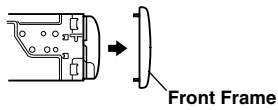

- Secure the ground lead of the unit to a clean metal spot using a screw (*3) already attached to the vehicle's chassis.

Connections

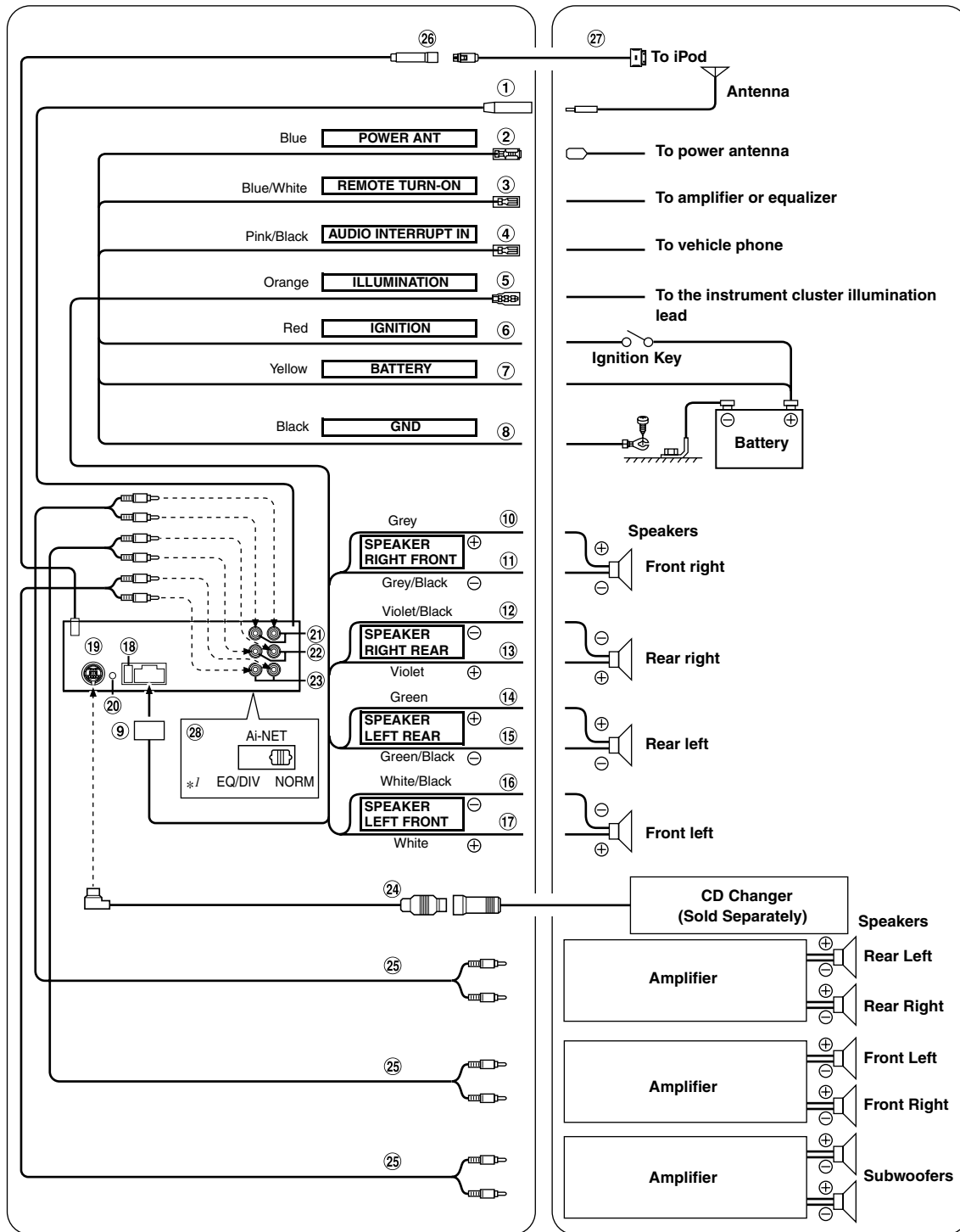

*1 The label is attached on the bottom of the unit.

- ① **Antenna Receptacle**
- ② **Power Antenna Lead (Blue)**
Connect this lead to the +B terminal of your power antenna, if applicable.
 - *This lead should be used only for controlling the vehicle's power antenna. Do not use this lead to turn on an amplifier or a signal processor, etc.*
- ③ **Remote Turn-On Lead (Blue/White)**
Connect this lead to the remote turn-on lead of your amplifier or signal processor.
- ④ **Audio Interrupt In Lead (Pink/Black)**
Connect this lead to the Audio interface output of a cellular phone which provides ground shorting when a call is received.
- ⑤ **Illumination Lead (Orange)**
This lead may be connected to the vehicle's instrument cluster illumination lead. This will allow the backlighting of this unit to dim whenever the vehicle's lights are turned on.
- ⑥ **Switched Power Lead (Ignition) (Red)**
Connect this lead to an open terminal on the vehicle's fuse box or another unused power source which provides (+)12V only when the ignition is turned on or in the accessory position.
- ⑦ **Battery Lead (Yellow)**
Connect this lead to the positive (+) post of the vehicle's battery.
- ⑧ **Ground Lead (Black)**
Connect this lead to a good chassis ground on the vehicle. Make sure the connection is made to bare metal and is securely fastened using the sheet metal screw provided.
- ⑨ **Power Supply Connector**
- ⑩ **Right Front (+) Speaker Output Lead (Grey)**
- ⑪ **Right Front (-) Speaker Output Lead (Grey/Black)**
- ⑫ **Right Rear (-) Speaker Output Lead (Violet/Black)**
- ⑬ **Right Rear (+) Speaker Output Lead (Violet)**
- ⑭ **Left Rear (+) Speaker Output Lead (Green)**
- ⑮ **Left Rear (-) Speaker Output Lead (Green/Black)**
- ⑯ **Left Front (-) Speaker Output Lead (White/Black)**
- ⑰ **Left Front (+) Speaker Output Lead (White)**
- ⑱ **Fuse Holder (10A)**
- ⑲ **Ai-NET Connector**
Connect this to the output or input connector of another device (CD Changer, Equalizer, etc.) equipped with Ai-NET.
 - *Interface adapter for iPod® (KCA-420i) is not recommended for use with this product.*
 - *You can input TV/video sound by connecting an optional Ai-NET/RCA Interface cable (KCA-121B) to this component.*
- ⑳ **Steering Remote Control Interface Connector**
To steering Remote control interface box.
- ㉑ **Rear Output RCA Connectors**
RED is right and WHITE is left.
- ㉒ **Front Output RCA Connectors**
RED is right and WHITE is left.
- ㉓ **Subwoofer RCA Connectors**
RED is right and WHITE is left.
- ㉔ **Ai-NET Cable (Included with CD Changer)**
- ㉕ **RCA Extension Cable (sold separately)**
- ㉖ **iPod Direct Connector**
Control iPod signals.
Connect this to an iPod or to an optional Bluetooth Box. To use a hands-free mobile phone, an optional Bluetooth Box connection is required. For details on connection, refer to the Owner's Manual of the Bluetooth Box.
- ㉗ **FULL SPEED™ Connection Cable (KCE-422i) (sold separately)**
- ㉘ **System Switch**
When connecting a processor or divider using Ai-NET, place this switch in the EQ/DIV position. When no device is connected, leave the switch in the NORM position.
 - *Be sure to turn the power off to the unit before changing the switch position.*

To prevent external noise from entering the audio system.

- Locate the unit and route the leads at least 10 cm away from the car harness.
- Keep the battery power leads as far away from other leads as possible.
- Connect the ground lead securely to a bare metal spot (remove any paint, dirt or grease if necessary) of the car chassis.
- If you add an optional noise suppressor, connect it as far away from the unit as possible. Your Alpine dealer carries various noise suppressors, contact them for further information.
- Your Alpine dealer knows best about noise prevention measures so consult your dealer for further information.

Free Manuals Download Website

<http://myh66.com>

<http://usermanuals.us>

<http://www.somanuals.com>

<http://www.4manuals.cc>

<http://www.manual-lib.com>

<http://www.404manual.com>

<http://www.luxmanual.com>

<http://aubethermostatmanual.com>

Golf course search by state

<http://golfingnear.com>

Email search by domain

<http://emailbydomain.com>

Auto manuals search

<http://auto.somanuals.com>

TV manuals search

<http://tv.somanuals.com>