



MP3/WMA/AAC CD Receiver with Bluetooth®

CDE-103EBT

MP3**AAC**

MP3/WMA/AAC CD Receiver

CDE-102E/CDE-101E/ CDE-101EM

MP3**AAC**

- **OWNER'S MANUAL**
Please read before using this equipment.
- **用戶手冊**
請在使用本設備之前先閱讀用戶手冊。

ALPINE ELECTRONICS MARKETING, INC.
1-1-8 Nishi Gotanda,
Shinagawa-ku,
Tokyo 141-0031, Japan
Phone 03-5496-8231

ALPINE ELECTRONICS OF AMERICA, INC.
19145 Gramercy Place, Torrance,
California 90501, U.S.A.
Phone 1-800-ALPINE-1 (1-800-257-4631)

ALPINE ELECTRONICS OF CANADA, INC.
777 Superstest Road, Toronto,
Ontario M3J 2M9, Canada
Phone 1-800-ALPINE-1 (1-800-257-4631)

ALPINE ELECTRONICS OF AUSTRALIA PTY. LTD.
161-165 Princes Highway, Hallam
Victoria 3803, Australia
Phone 03-8787-1200

ALPINE ELECTRONICS GmbH
Frankfurter Ring 117, 80807 München, Germany
Phone 089-32 42 640

ALPINE ELECTRONICS OF U.K. LTD.
Alpine House
Fletchamstead Highway, Coventry CV4 9TW, U.K.
Phone 0870-33 33 763

ALPINE ELECTRONICS FRANCE S.A.R.L.
(RCS PONTOISE B 338 101 280)
98, Rue de la Belle Etoile, Z.I. Paris Nord II,
B.P. 50016, 95945 Roissy Charles de Gaulle
Cedex, France
Phone 01-48638989

ALPINE ITALIA S.p.A.
Viale C. Colombo 8, 20090 Trezzano
Sul Naviglio (MI), Italy
Phone 02-484781

ALPINE ELECTRONICS DE ESPAÑA, S.A.
Portal de Gamarra 36, Pabellón, 32
01013 Vitoria (Alava)-APDO 133, Spain
Phone 945-283588

ALPINE ELECTRONICS (BENELUX) GmbH
Leuvensesteenweg 510-B6,
1930 Zaventem, Belgium
Phone 02-725-13 15

DAESUNG ELTEC CO., LTD.
Phone 031-711-1731
Web www.dseltec.co.kr

Contents

Operating Instructions

WARNING

WARNING	3
CAUTION	3
PRECAUTIONS	3
CAUTION	5

Getting Started

Accessory List	6
Turning Power On and Off	6
Detaching and Attaching the Front Panel	6
Initial System Start-Up	6
Adjusting Volume	6
Lowering Volume Quickly	6
Setting Time	7

Radio

Listening to Radio	7
Presetting Stations Manually	7
Presetting Stations Automatically	8
Tuning to Preset Stations	8

CD/MP3/WMA/AAC

Playback	8
Repeat Play	9
M.I.X. (Random Play)	9
Searching for CD Text	10
File/Folder Name Search (concerning MP3/WMA/AAC)	10
Quick Search	10
About MP3/WMA/AAC	10

Sound Setting

Adjusting Subwoofer Level/Bass Level/Treble Level/Balance (Between Left and Right)/Fader (Between Front and Rear)/Defeat	12
Setting the Bass Control	12
Setting the Treble Control	13
Adjusting the High Pass Filter	13
Turning Loudness On/Off	13

Other Functions

Displaying the Text	14
Displaying Time	14
Using the Front AUX Input Terminal (CDE-103EBT/CDE-102E only)	15

SETUP

Bluetooth Setting

Setting the Bluetooth Connection (BT IN)	16
--	----

Sound Customizing

Subwoofer On and Off	16
Setting the Subwoofer System	16

Visual Customizing

Changing Lighting Colour (CDE-103EBT only)	16
Dimmer Control (CDE-103EBT/CDE-102E/ CDE-101E only)	16
Scroll Type Setting	16
Scroll Setting (TEXT SCR)	16
Demonstration	16

MP3/WMA/AAC

Playing MP3/WMA/AAC Data (PLAY MODE)	16
---	----

External Device

Turning Mute Mode On/Off (INT MUTE)	16
Connecting to an External Amplifier (POWER IC)	17
Setting the AUX+ SETUP Mode	17
Setting the AUX NAME mode (CDE-103EBT/CDE-102E only)	17

BLUETOOTH (CDE-103EBT only)

Setup Before Using	18
About Bluetooth	18
Before Using Hands-Free Function	18
How to connect to a Bluetooth compatible device (Pairing)	18
Bluetooth SETUP	18
Bluetooth Setup Operation	18
Setting the Bluetooth Device	19
Setting the Search Mode	19
Setting the Received Calls automatically (Auto Answer)	19
Deleting a Bluetooth Device from the list	19
Displaying the phone service provider name	19
Adjusting the volume for the microphone input	19
Selecting the output speaker	19
Displaying the firmware version	19
Updating the firmware	19
Hands-Free Phone Control	20
About the Hands-Free Phone	20
Answering a Call	20
Hanging up the Telephone	20
Redial Function	20
Calling	20
Redialing a Number In Outgoing History	20
Dialing a Number In Incoming History	20
Dialing a Number In Incoming Missed Call History	20
Dialing a Number In The Phone Book	21
Voice Dial Operation	21
Adjusting the volume when receiving a Call	21
Call Switching Operation	21

USB memory (Optional)

Controlling USB memory (Optional)	21
Playing MP3/WMA/AAC Files with the USB memory (Optional)	21
USB Memory Connection (Optional)	22
About MP3/WMA/AAC File of USB Memory	22

iPhone/iPod (Optional)

Playback	23
Searching for a desired Song	23
Quick Search	23
Direct Search Function	24
Select Playlist/Artist/Album/Genre/Composer	24
Random Play Shuffle (M.I.X.)	24
Repeat Play	25
Displaying the Text	25

Information

In Case of Difficulty	26
Specifications	29

Installation and Connections

Warning	30
Caution	30
Precautions	30
Installation	31
Mounting the Microphone (CDE-103EBT only)	31
Connections	32

Operating Instructions

WARNING

WARNING

This symbol means important instructions. Failure to heed them can result in serious injury or death.

DO NOT OPERATE ANY FUNCTION THAT TAKES YOUR ATTENTION AWAY FROM SAFELY DRIVING YOUR VEHICLE.

Any function that requires your prolonged attention should only be performed after coming to a complete stop. Always stop the vehicle in a safe location before performing these functions. Failure to do so may result in an accident.

KEEP THE VOLUME AT A LEVEL WHERE YOU CAN STILL HEAR OUTSIDE NOISES WHILE DRIVING.

Excessive volume levels that obscure sounds such as emergency vehicle sirens or road warning signals (train crossings, etc.) can be dangerous and may result in an accident. LISTENING AT LOUD VOLUME LEVELS IN A CAR MAY ALSO CAUSE HEARING DAMAGE.

MINIMIZE DISPLAY VIEWING WHILE DRIVING.

Viewing the display may distract the driver from looking ahead of the vehicle and cause an accident.

DO NOT DISASSEMBLE OR ALTER.

Doing so may result in an accident, fire or electric shock.

USE ONLY IN CARS WITH A 12 VOLT NEGATIVE GROUND.

(Check with your dealer if you are not sure.) Failure to do so may result in fire, etc.

KEEP SMALL OBJECTS SUCH AS BATTERIES OUT OF THE REACH OF CHILDREN.

Swallowing them may result in serious injury. If swallowed, consult a physician immediately.

USE THE CORRECT AMPERE RATING WHEN REPLACING FUSES.

Failure to do so may result in fire or electric shock.

DO NOT BLOCK VENTS OR RADIATOR PANELS.

Doing so may cause heat to build up inside and may result in fire.

USE THIS PRODUCT FOR MOBILE 12V APPLICATIONS.

Use for other than its designed application may result in fire, electric shock or other injury.

DO NOT PLACE HANDS, FINGERS OR FOREIGN OBJECTS IN INSERTION SLOTS OR GAPS.

Doing so may result in personal injury or damage to the product.

CAUTION

This symbol means important instructions. Failure to heed them can result in injury or material property damage.

HALT USE IMMEDIATELY IF A PROBLEM APPEARS.

Failure to do so may cause personal injury or damage to the product. Return it to your authorized Alpine dealer or the nearest Alpine Service Centre for repairing.

PRECAUTIONS

Product Cleaning

Use a soft dry cloth for periodic cleaning of the product. For more severe stains, please dampen the cloth with water only. Anything else has the chance of dissolving the paint or damaging the plastic.

Temperature

Be sure the temperature inside the vehicle is between +60°C (+140°F) and -10°C (+14°F) before turning your unit on.

Moisture Condensation

You may notice the CD playback sound wavering due to condensation. If this happens, remove the disc from the player and wait about an hour for the moisture to evaporate.

Damaged Disc

Do not attempt to play cracked, warped, or damaged discs. Playing a bad disc could severely damage the playback mechanism.

Maintenance

If you have problems, do not attempt to repair the unit yourself. Return it to your Alpine dealer or the nearest Alpine Service Station for servicing.

Never Attempt the Following

Do not grip or pull out the disc while it is being pulled back into the player by the automatic reloading mechanism.

Do not attempt to insert a disc into the unit when the unit power is off.

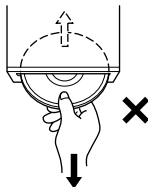

Inserting Discs

Your player accepts only one disc at a time for playback. Do not attempt to load more than one disc.

Make sure the label side is facing up when you insert the disc. "ERROR" will be displayed on your player if you insert a disc incorrectly. If "ERROR" continues to be displayed even though the disc has been inserted correctly, push the RESET switch with a pointed object such as a ballpoint pen.

Playing a disc while driving on a very bumpy road may result in skips, but this will not scratch the disc or damage the player.

New Discs

To prevent the CD from jamming, "ERROR" is displayed if discs with irregular surfaces are inserted or if discs are inserted incorrectly. When a new disc is ejected immediately after initial loading, use your finger to feel around the inside of the centre hole and outside edge of the disc. If you feel any small bumps or irregularities, this could inhibit proper loading of the disc. To remove the bumps, rub the inside edge of the hole and outside edge of the disc with a ballpoint pen or other such instrument, then insert the disc again.

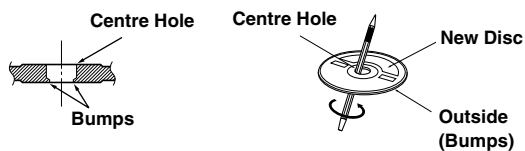

Irregular Shaped Discs

Be sure to use round shape discs only for this unit and never use any special shape discs.

Use of special shape discs may cause damage to the mechanism.



Installation Location

Make sure this unit will not be installed in a location subjected to:

- Direct sun and heat
- High humidity and water
- Excessive dust
- Excessive vibrations

Correct Handling

Do not drop the disc while handling. Hold the disc so you will not leave fingerprints on the surface. Do not affix tape, paper, or gummed labels to the disc. Do not write on the disc.

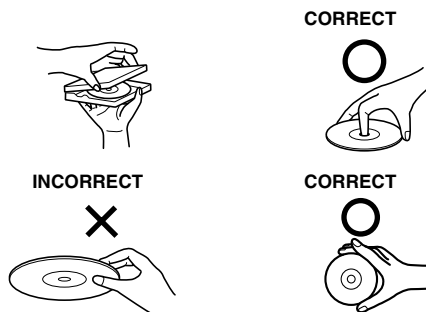

Disc Cleaning

Fingerprints, dust, or soil on the surface of the disc could cause the CD player to skip. For routine cleaning, wipe the playing surface with a clean, soft cloth from the centre of the disc to the outer edge. If the surface is heavily soiled, dampen a clean, soft cloth in a solution of mild neutral detergent before cleaning the disc.



Disc Accessories

There are various accessories available on the market for protecting the disc surface and improving sound quality. However, most of them will influence the thickness and/or diameter of the disc. Using such accessories can cause the disc to be out of standard specifications and may create operational problems. We recommend not using these accessories on discs played in Alpine CD players.



Transparent Sheet

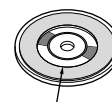

Disc Stabilizer

On handling Compact Discs (CD/CD-R/CD-RW)

- Do not touch the surface.
- Do not expose the disc to direct sunlight.
- Do not affix stickers or labels.
- Clean the disc when it is dusty.
- Make sure that there are no bumps around the disc.
- Do not use commercially available disc accessories.

Do not leave the disc in the car or the unit for a long time. Never expose the disc to direct sunlight. Heat and humidity may damage the CD and you may not be able to play it again.

To customers using CD-R/CD-RW

- If a CD-R/CD-RW cannot be played back, make sure the last recording session was closed (finalised).
- Finalize the CD-R/CD-RW if necessary, and attempt playback again.

About media that can be played

Use only compact discs with the label side showing the CD logo marks below.



If you use unspecified compact discs, correct performance cannot be guaranteed.

You can play CD-Rs (CD-Recordables)/CD-RWs (CD-ReWritables) which have been recorded only on audio devices. You can also play CD-Rs/CD-RWs containing MP3/WMA/AAC formatted audio files.

- Some of the following CDs may not play on this unit:
Flawed CDs, CDs with fingerprints, CDs exposed to extreme temperatures or sunlight (e.g., left in the car or this unit), CDs recorded under unstable conditions, CDs on which a recording failed or a re-recording was attempted, copy-protected CDs which do not conform to the audio CD industry standard.
- Use discs with MP3/WMA/AAC files written in a format compatible with this unit. For details, see pages 10-11.
- ROM data other than audio files contained in a disc will not produce sound when played back.

Protecting the USB connection terminal

- Only a USB memory can be connected to the USB connection terminal on this unit. Correct performance using other USB products cannot be guaranteed. A USB hub is not supported.
- Do not connect a USB memory over 20 mm wide. Also, avoid connecting USB memory and Front Aux at the same time.
- If a USB device is inserted in the unit, it projects out and may be a danger while driving. Use a commercially available USB extension cable, and connect it in a safe way.
- Depending on the connected USB memory device, the unit may not function or some functions may not be performed.
- The audio file format that can be played back on the unit is MP3/WMA/AAC.
- Artist/song name, etc., can be displayed, however characters may not be correctly displayed.

CAUTION

Alpine accepts no responsibility for lost data, etc., even if data, etc. is lost while using this product.

On Handling USB Memory

- To prevent malfunction or damage, note the following points.
Read the USB memory Owner's Manual thoroughly.
Do not touch the terminals by hand or metal.
Do not subject USB memory to excessive shock.
Do not bend, drop, disassemble, modify or soak in the water.
- Avoid usage or storage in the following locations:
Anywhere in the car exposed to direct sunlight or high temperatures.
Anywhere the possibility of high humidity or corrosive substances are present.
- Fix the USB memory in a location where driver operation will not be hindered.
- USB memory may not function correctly at high or low temperature.
- The USB flash memory supports only 512 or 2,048 bytes per sector.
- Use only certified USB memory. Note that even certified USB memory, may not function correctly depending on its type or state.
- USB memory function is not guaranteed. Use USB memory according to the terms of agreement.
- Depending on the settings of the USB memory type, memory state or encoding software, the unit may not play back or display properly.
- A file that is copy-protected (copyright protection) cannot be played back.
- USB memory may take time to start playback. If there is a particular file other than audio in the USB memory, it may take considerable time before the file is played back or searched.
- The unit can play back "mp3", "wma" or "m4a" file extensions.
- Do not add the above extensions to a file other than audio data. This non-audio data will not be recognised. The resulting playback may contain noise that can damage speakers and/or amplifiers.
- It is recommended to back up important data on a personal computer.
- Do not remove the USB device while playback is in progress. Change SOURCE to something other than USB, then remove the USB device to prevent possible damage to its memory.

-
- *Windows Media and the Windows logo are trademarks, or registered trademarks of Microsoft Corporation in the United States and/or other countries.*
 - *iPod is a trademark of Apple Inc., registered in the U.S. and other countries.*
 - *iPhone is a trademark of Apple Inc.*
 - *"Made for iPod" means that an electronic accessory has been designed to connect specifically to iPod and has been certified by the developer to meet Apple performance standards.*
 - *"Works with iPhone" means that an electronic accessory has been designed to connect specifically to iPhone and has been certified by the developer to meet Apple performance standards.*
 - *Apple is not responsible for the operation of this device or its compliance with safety and regulatory standards.*
 - *The Bluetooth word mark and logos are owned by the Bluetooth SIG, Inc. and any use of such marks by Alpine Electronics, Inc. is under licence. Other trademarks and trade names are those of their respective owners.*
 - *"MPEG Layer-3 audio coding technology licensed from Fraunhofer IIS and Thomson."*
 - *"Supply of this product only conveys a license for private, non-commercial use and does not convey a license nor imply any right to use this product in any commercial (i.e. revenue-generation) real time broadcasting (terrestrial, satellite, cable and/or any other media), broadcasting/streaming via internet, intranets and/or other networks or in other electronic content distribution systems, such as pay-audio or audio-on-demand applications. An independent license for such use is required. For details, please visit <http://www.mp3licensing.com>"*

Getting Started

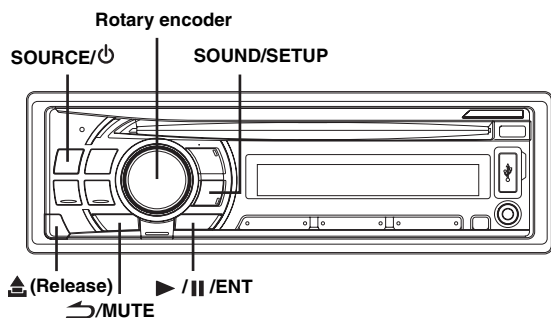

* This illustration is CDE-103EBT.

Accessory List

- Head unit1
- Power cable1
- Microphone (4m) (CDE-103EBT only)1
- Mounting sleeve.....1
- Carrying case.....1
- Bracket key.....2
- Screw (M5 x 8).....4
- Owner's Manual 1 set

Turning Power On and Off

Press **SOURCE/⏻** to turn on the unit.

- The unit can be turned on by pressing any other button except ▲ and ▲ (Release).

Press and hold **SOURCE/⏻** for at least 2 seconds to turn off the unit.

- The first time power is turned on, the volume will start from level 12.

Detaching and Attaching the Front Panel

Detaching

- 1 Turn off the unit power.
- 2 Press ▲ (Release) at the lower left side until the front panel pops out.
- 3 Grasp the left side of the front panel and pull it out.

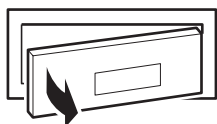

- The front panel may become hot in normal usage (especially the connector terminals on the back of the front panel). This is not a malfunction.
- To protect the front panel, place it in the supplied carrying case.
- When detaching the front panel, do not apply excessive force as it may result in malfunction.

Attaching

- 1 Insert the right side of the front panel into the main unit. Align the groove on the front panel with the projections on the main unit.
- 2 Push the left side of the front panel until it locks firmly into the main unit.

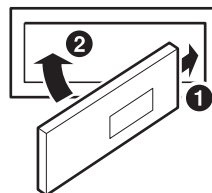

- Before attaching the front panel, make sure that there is no dirt or dust on the connector terminals and no foreign object between the front panel and the main unit.
- Attach the front panel carefully, holding the sides of the front panel to avoid pushing buttons by mistake.

Initial System Start-Up

Be sure to press the RESET switch when using the unit for the first time, after changing the car battery, etc.

- 1 Turn off the unit power.
- 2 Remove the detachable front panel.
- 3 Press **RESET** with a ballpoint pen or similar pointed object.

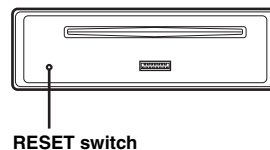

Adjusting Volume

Turn the **Rotary encoder** until the desired sound is obtained.

Lowering Volume Quickly

Activating the Audio Mute function will instantly lower the volume level by 20 dB.

Press ↵ /MUTE to activate the MUTE mode.
The audio level will decrease by about 20 dB.

Pressing ↵ /MUTE again will bring the audio back to its previous level.

Setting Time

- 1 Press and hold **SOUND/SETUP** for at least 2 seconds to activate the **SETUP** mode.
 - 2 Turn the **Rotary encoder** to select the **CLOCK ADJ** mode, and then press **▶/||/ENT**.
The time indication will blink.
 - 3 Turn the **Rotary encoder** to adjust the hours while the time indication is blinking.
 - 4 When the hour has been adjusted, press **▶/||/ENT**.
 - 5 Turn the **Rotary encoder** to adjust the minutes while the time indication is blinking.
 - 6 Press and hold **SOUND/SETUP** for at least 2 seconds to return to normal mode.
- To synchronise the clock to another clock/watch or radio time announcement, press and hold **▶/||/ENT** for at least 2 seconds after setting the "hour." Minutes will reset to "00". If the display shows over "30" minutes when you do this, the time will advance one hour.
 - Pressing **↶/MUTE** will return to the previous mode.
 - If no operation is performed for 60 seconds, the unit will return to normal mode automatically.

Controllable with Remote Control

This unit can be controlled with an optional Alpine remote control. For details, consult your Alpine dealer. Point the optional remote control transmitter at the remote-control sensor.

Remote control sensor

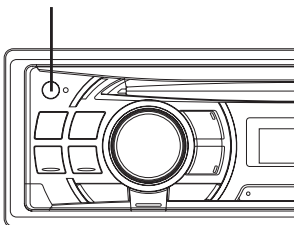

Radio

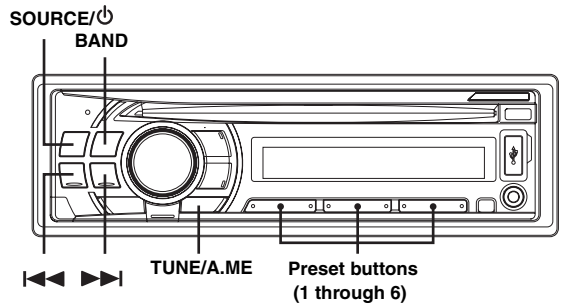

* This illustration is CDE-103EBT.

Listening to Radio

- 1 Press **SOURCE/⏻** to select **TUNER** mode.
 - 2 Press **BAND** repeatedly until the desired radio band is displayed.
F1 (FM1) → F2 (FM2) → AM → F1 (FM1)
 - 3 Press **TUNE/A.ME** to select the tuning mode.
DX SEEK (Distance mode) → SEEK (Local mode) → OFF (Manual mode) → DX SEEK
- The initial mode is *Distance mode*.
- Distance mode:**
Both strong and weak stations will be automatically tuned in (Automatic Seek Tuning).
- Local mode:**
Only strong stations will be automatically tuned in (Automatic Seek Tuning).
- Manual mode:**
The frequency is manually tuned in steps (Manual tuning).
- 4 Press **◀◀** or **▶▶** to tune in the desired station.
Holding down **◀◀** or **▶▶** will change the frequency continuously.

Presetting Stations Manually

- 1 Select the radio band and tune in a desired radio station you wish to store in the preset memory.
 - 2 Press and hold, for at least 2 seconds, any one of the **preset buttons (1 through 6)** into which you wish to store the station.
The selected station is stored.
The display shows the band, preset number and station frequency memorized.
- A total of 18 stations can be stored in the preset memory (6 stations for each band; FM1, FM2 and AM).
 - If you store a station in a preset memory which already has a station, the current station will be cleared and replaced with the new station.

Presetting Stations Automatically

- 1 Press **BAND** repeatedly until the desired radio band is displayed.
 - 2 Press and hold **TUNE/A.ME** for at least 2 seconds. The frequency on the display continues to change while the automatic memory is in progress. The tuner will automatically seek and store 6 strong stations in the selected band. They will be stored into preset buttons 1 to 6 in order of signal strength. When the automatic memory has been completed, the tuner goes to the station stored in preset location No.1.
- If no stations are stored, the tuner will return to the original station you were listening to before the auto memory procedure began.

Tuning to Preset Stations

- 1 Press **BAND** repeatedly until the desired band is displayed.
- 2 Press any one of the station preset buttons (1 through 6) that has your desired radio station in memory. The display shows the band, preset number and frequency of the station selected.

CD/MP3/WMA/AAC

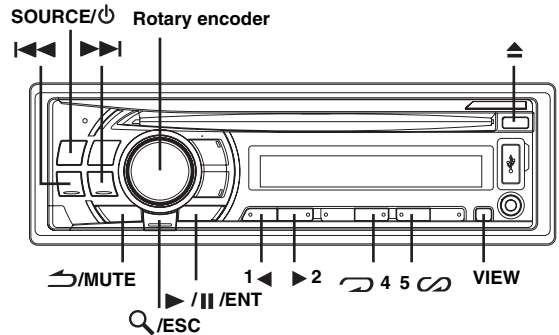

* This illustration is CDE-103EBT.

Playback

- 1 Insert a disc with the label side facing up. The disc will be pulled into the unit automatically, and the "Ⓢ" indicator lights up.

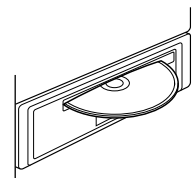

When a disc is already inserted, press SOURCE/⏻ to switch to the DISC mode.

The mode will change every time the button is pressed.

TUNER → DISC → USB AUDIO → iPod*¹/AUX+*²
→ BT AUDIO*³ → AUX*⁴ → TUNER

- *¹ Displayed only when the iPhone/iPod is connected and AUX+ SETUP is set to OFF, refer to "Setting the AUX+ SETUP Mode" (page 17).
- *² Displayed only when the AUX+ SETUP is set to ON, refer to "Setting the AUX+ SETUP Mode" (page 17).
- *³ Only for CDE-102E/CDE-101E/CDE-101EM and BT IN is set to BT ADAPTER. Refer to "Bluetooth Setting" (page 16).
- *⁴ Refer to "Using the Front AUX Input Terminal (CDE-103EBT/CDE-102E only)" (page 15).

- 2 While playing back MP3/WMA/AAC, press 1 ◀ or ▶ 2 to select the desired folder. Pressing and holding 1 ◀ or ▶ 2 will change folders continuously.

3 Press ◀◀ or ▶▶ to select the desired track (file).

Returning to the beginning of the current track (file):

Press ◀◀.

Fast backward:

Press and hold ◀◀.

Advancing to the beginning of the next track (file):

Press ▶▶.

Fast forward:

Press and hold ▶▶.

4 To pause playback, press ▶/||/ENT.

Pressing ▶/||/ENT again will resume playback.

5 To eject the disc, press ⏏.

- Do not remove a CD during its eject cycle. Do not load more than one disc at a time. A malfunction may result from doing either.
- If the CD does not eject, press and hold ⏏ for at least 2 seconds.
- The “Ⓢ” indicator lights up when a disc is inserted.
- Three-inch (8 cm) CDs cannot be used.
- The CD-player can play discs containing audio data, MP3 data, WMA data and AAC data.
- WMA format files that are protected by DRM (Digital Rights Management), AAC format files that have been purchased from the iTunes Store and files that are copy-protected (copyright protection) cannot be played back on this unit.
- The track display for MP3/WMA/AAC data playback is the file numbers recorded on the disc.
- The playback time may not be correctly displayed when a VBR (Variable Bit Rate) recorded file is played back.

MP3/WMA/AAC Play Display

The folder number and file number will be displayed as described below.

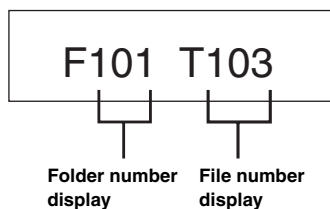

- Press VIEW to switch the display. See “Displaying the Text” (page 14) for information about display switching.

Repeat Play

Press ↻ 4 to play back repeatedly the track being played.

The track (file) will be played repeatedly.

Press ↻ 4 again and select off to deactivate repeat play.

CD mode :

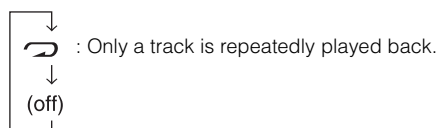

MP3/WMA/AAC mode :

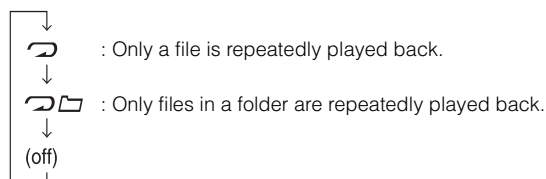

M.I.X. (Random Play)

Press 5 ∞ in the play or pause mode.

The tracks (files) on the disc will be played back in random sequence.

To cancel M.I.X. play, press 5 ∞ again.

CD mode :



MP3/WMA/AAC mode :

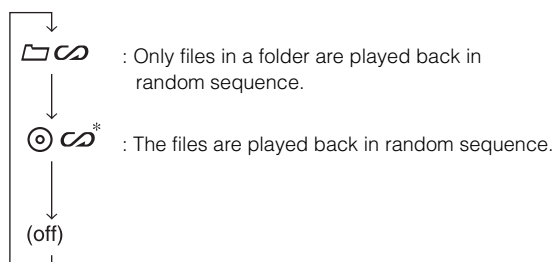

* In the USB mode, all files stored in the USB memory are played back in random sequence, and the “∞” indicator lights up.

Searching for CD Text

On discs utilizing CD Text, songs can be searched and played by using their recorded titles. For discs without CD Text, searches are made using the track numbers associated with each song.

- 1 Press \mathcal{Q} /ESC during play.**
This will set the search mode, and the " \mathcal{Q} " indicator lights up.
 - 2 Turn the Rotary encoder to select the desired track, and then press \blacktriangleright /||/ENT.**
This will play the selected track.
- Press and hold \mathcal{Q} /ESC for at least 2 seconds in the search mode to cancel. Or, the search mode is cancelled if no operation is performed for 10 seconds.
 - When CD Text Search is made during M.I.X. play, the M.I.X. play mode will be cancelled.

File/Folder Name Search (concerning MP3/WMA/AAC)

Folder and file names may be searched and displayed during playback.

- 1 During MP3/WMA/AAC playback, press \mathcal{Q} /ESC to activate the search mode.**
The " \mathcal{Q} " indicator lights up.
- 2 Turn the Rotary encoder to select Folder Name Search mode or File Name Search mode, and then press \blacktriangleright /||/ENT.**

Folder Name Search mode

- 3 Turn the Rotary encoder to select the desired folder.**
 - 4 Press and hold \blacktriangleright /||/ENT for at least 2 seconds to play back the first file in the selected folder.**
- Press and hold \mathcal{Q} /ESC for at least 2 seconds in the search mode to cancel. Or, the search mode is cancelled if no operation is performed for 10 seconds.
 - To search for files in the Folder Name Search mode, press \blacktriangleright /||/ENT. Files in the folder may be searched.
 - Press \mathcal{M} /MUTE to exit Folder Name Search mode in step 3 in order to select File Name Search mode.
 - The root folder is displayed as "- - - - -".
 - When Folder Name Search is made during M.I.X. play, the M.I.X. play mode will be cancelled.

File Name Search mode

- 3 Press 1 \blacktriangleleft or \blacktriangleright 2 to select another Folder.**
 - 4 Select the desired file by turning the Rotary encoder.**
 - 5 Press \blacktriangleright /||/ENT to play back the selected file.**
- Press and hold \mathcal{Q} /ESC for at least 2 seconds in the search mode to cancel. Or, the search mode is cancelled if no operation is performed for 10 seconds.
 - Press \mathcal{M} /MUTE in the search mode to return to the previous mode.
 - When File Name Search is made during M.I.X. play, the M.I.X. play mode will be cancelled.

Quick Search

You can search for tracks (files).

- 1 Press and hold \mathcal{Q} /ESC for at least 2 seconds in the CD/MP3/WMA/AAC mode to activate Quick Search mode.**
The " \mathcal{Q} " indicator lights up.
 - 2 Turn the Rotary encoder to select a desired track (file).**
The selected track is played back immediately.
- Press and hold \mathcal{Q} /ESC for at least 2 seconds in the search mode to cancel. Or, the search mode is cancelled if no operation is performed for 10 seconds.

About MP3/WMA/AAC

CAUTION

Except for private use, duplicating audio data (including MP3/WMA/AAC data) or distributing, transferring, or copying it, whether for free or for a fee, without permission of the copyright holder is strictly prohibited by the Copyright Act and by international treaty.

What is MP3?

MP3, whose official name is "MPEG-1 Audio Layer 3," is a compression standard prescribed by the ISO, the International Standardization Organization and MPEG which is a joint activity institution of the IEC.

MP3 files contain compressed audio data. MP3 encoding is capable of compressing audio data at extremely high ratios, reducing the size of music files to as much as one-tenth their original size. This is achieved while still maintaining near CD quality. The MP3 format realises such high compression ratios by eliminating the sounds that are either inaudible to the human ear or masked by other sounds.

What is WMA?

WMA, or "Windows Media™ Audio," is compressed audio data. WMA is similar to MP3 audio data and can achieve CD quality sound with small file sizes.

What is AAC?

AAC is the abbreviation for "Advanced Audio Coding," and is a basic format of audio compression used by MPEG2 or MPEG4.

Method for creating MP3/WMA/AAC files

Audio data is compressed using software with MP3/WMA/AAC codecs. For details on creating MP3/WMA/AAC files, refer to the user's manual for that software.

MP3/WMA/AAC files that are playable on this device have the file extensions "mp3" / "wma" / "m4a." Files with no extension cannot be played back (WMA ver. 7.1, 8 and 9 are supported). Protected files are not supported, neither are raw AAC files (using the ".aac" extension).

There are many different versions of the AAC format. Confirm that the software being used conforms to the acceptable formats listed above. It's possible that the format may be unplayable even though the extension is valid. Playback of AAC files encoded by iTunes is supported.

Supported playback sampling rates and bit rates

MP3

Sampling rates: 48 kHz, 44.1 kHz, 32 kHz, 24 kHz, 22.05 kHz, 16 kHz, 12 kHz, 11.025 kHz, 8 kHz

Bit rates: 8 - 320 kbps

WMA

Sampling rates: 48 kHz, 44.1 kHz, 32 kHz

Bit rates: 48 - 192 kbps

AAC

Sampling rates: 48 kHz, 44.1 kHz, 32 kHz, 24 kHz, 22.05 kHz, 16 kHz, 12 kHz, 11.025 kHz, 8 kHz

Bit rates: 16 - 320 kbps

This device may not play back correctly depending on sampling rates.

ID3 tags/WMA tags

This device supports ID3 tag v1 and v2, and WMA tag.

If tag data is in an MP3/WMA/AAC file, this device can display the title (track title), artist name, and album name ID3 tag/WMA tag data.

This device can only display single-byte alphanumeric characters (up to 30 for ID3 tags and up to 15 for WMA tags) and the underscore. For non-supported characters, "NO SUPPORT" is displayed.

If information contains characters other than ID3 tag information, the audio file may not be played back.

The tag information may not be correctly displayed, depending on the contents.

Producing MP3/WMA/AAC discs

MP3/WMA/AAC files are prepared, then written to a CD-R or CD-RW using CD-R writing software. A disc can hold up to 510 files/folders (including Root Folders), and the maximum number of folders is 255.

Playback may not be performed if a disc exceeds the limitations described above.

Media supported

The media that this device can play back are CD-ROMs, CD-Rs, and CD-RWs.

Corresponding File Systems

This device supports discs formatted with ISO9660 Level 1 or Level 2.

Under the ISO9660 standard, there are some restrictions to remember.

The maximum nested folder depth is 8 (including the root directory). The number of characters for a folder/file name is limited.

Valid characters for folder/file names are letters A-Z (all caps), numbers 0-9, and '_' (underscore).

This device also can play back discs in Joliet, Romeo, etc., and other standards that conform to ISO9660. However, sometimes the file names, folder names, etc., are not displayed correctly.

Formats supported

This device supports CD-ROM XA, Mixed Mode CD, Enhanced CD (CD-Extra) and Multi-Session.

This device cannot correctly play back discs recorded with Track At Once or packet writing.

Order of files

Files are played back in the order that the writing software writes them to the disc. Therefore, the playback order may not be what is expected. Verify the writing order in the software's documentation. The playback order of the folders and files is as follows.

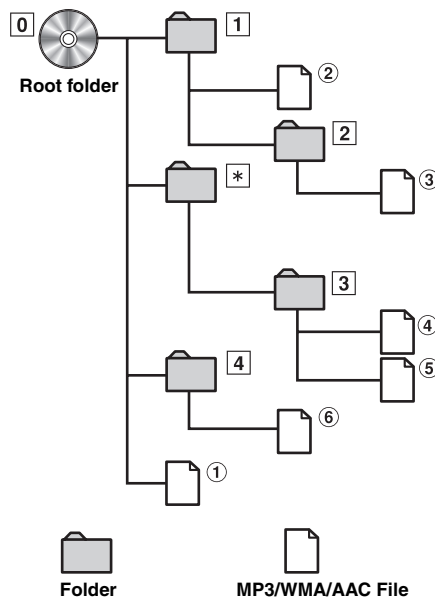

* The folder No./ folder Name will not be displayed if no file is contained in the folder.

Terminology

Bit rate

This is the "sound" compression rate specified for encoding. The higher the bit rate, the higher the sound quality, but also the larger the files.

Sampling rate

This value shows how many times per second the data is sampled (recorded). For example, music CDs use a sampling rate of 44.1 kHz, so the sound is sampled (recorded) 44,100 times per second. The higher the sampling rate, the higher the sound quality, but also the larger the volume of data.

Encoding

Converting music CDs, WAVE (AIFF) files, and other sound files into the specified audio compression format.

Tag

Song information such as track titles, artist names, album names, etc., written into MP3/WMA/AAC files.

Root folder

The root folder (or root directory) is found at the top of the file system. The root folder contains all folders and files. It is created automatically for all burned discs.

Sound Setting

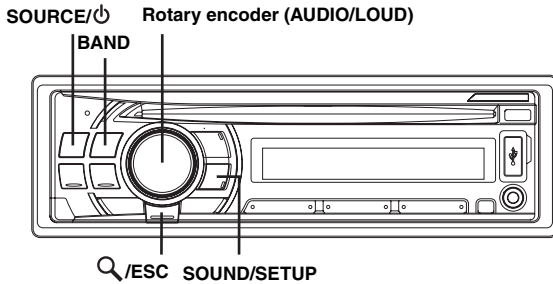

* This illustration is CDE-103EBT.

Adjusting Subwoofer Level/Bass Level/Treble Level/Balance (Between Left and Right)/Fader (Between Front and Rear)/Defeat

- 1 Press **Rotary encoder (AUDIO)** repeatedly to choose the desired mode.

Each press changes the mode as follows:

SUBWOOFER* → BASS LEVEL → TRE LEVEL → BALANCE → FADER → DEFEAT → VOLUME → SUBWOOFER

Subwoofer : +0 ~ +15
Bass level: -7 ~ +7
Treble level: -7 ~ +7
Balance : L15 ~ R15
Fader : R15 ~ F15
Defeat : ON/OFF
Volume : 0 ~ 35

- If no operation is performed for 5 seconds after selecting the SUBWOOFER, BASS LEVEL, TRE LEVEL, BALANCE, FADER or DEFEAT mode, the unit automatically returns to normal mode.

* When the subwoofer mode is set to OFF, its level cannot be adjusted.

- 2 Turn the **Rotary encoder** until the desired sound is obtained in each mode.

By setting DEFEAT ON, previously adjusted settings of BASS LEVEL and TRE LEVEL will return to the factory defaults.

Setting the Bass Control

You can change the Bass Frequency emphasis to create your own tonal preference.

- 1 Press **SOUND/SETUP** repeatedly to select the **BASS** mode.

BASS → TREBLE → HPF → BASS

Setting the Bass Centre Frequency

- 2-1 Press **BAND** to select the desired bass centre frequency.

80 Hz → 100 Hz → 200 Hz → 60 Hz → 80 Hz

Emphasises the displayed bass frequency ranges.

Setting the Bass Bandwidth

- 2-2 Press **SOURCE/⏻** to select the desired bass bandwidth.



Changes the boosted bass bandwidth to wide or narrow. A wider setting will boost a wide range of frequencies above and below the centre frequency. A narrower setting will boost only frequencies near the centre frequency.

Setting the Bass Level

- 2-3*¹ Turn the **Rotary encoder** to select the desired bass level (-7~+7).

You can emphasise or weaken the bass level.

- 3 Press and hold **Q/ESC** for at least 2 seconds to return to normal mode.

- If no operation is performed for 15 seconds, the unit will return to normal mode automatically.
- The bass level settings will be individually memorized for each source (FM, AM, CD, etc.) until the setting is changed. The bass frequency and bass bandwidth settings adjusted for one source are effective for all other sources (FM, AM, CD, etc.).
- The function is inoperable when DEFEAT is set to ON.

*¹ The adjustment can also be made by pressing **Rotary encoder**. Refer to "Adjusting Subwoofer Level/Bass Level/Treble Level/Balance (Between Left and Right)/Fader (Between Front and Rear)/Defeat" (page 12).

Setting the Treble Control

You can change the Treble Frequency emphasis to create your own tonal preference.

- 1 Press **SOUND/SETUP** repeatedly to select the **TREBLE** mode.

BASS → TREBLE → HPF → BASS

Setting the Treble Centre Frequency

- 2-1 Press **BAND** to select the desired treble centre frequency.

10.0 kHz → 12.5 kHz → 15.0 kHz → 17.5 kHz → 10.0 kHz

Emphasises the displayed treble frequency ranges.

Setting the Treble Level

- 2-2*2 Turn the **Rotary encoder** to select the desired treble level (-7~+7).

You can emphasise the treble level.

- 3 Press and hold **Q/ESC** for at least 2 seconds to return to normal mode.

- If no operation is performed for 15 seconds, the unit will return to normal mode automatically.
- The treble level settings will be individually memorized for each source (FM, AM, CD, etc.) until the setting is changed. The Treble frequency settings adjusted for one source are effective for all other sources (FM, AM, CD, etc.).
- The function is inoperable when DEFEAT is set to ON.

*2 The adjustment can also be made by pressing **Rotary encoder**. Refer to "Adjusting Subwoofer Level/Bass Level/Treble Level/Balance (Between Left and Right)/Fader (Between Front and Rear)/Defeat" (page 12).

Adjusting the High Pass Filter

The High Pass Filter on this unit can be adjusted to suit your personal taste.

- 1 Press **SOUND/SETUP** repeatedly to select the **HPF** mode.

BASS → TREBLE → HPF → BASS

- 2 Turn the **Rotary encoder** to select the desired **HPF** frequency.

OFF ↔ 60 Hz ↔ 80 Hz ↔ 100 Hz

All frequencies above the selected cutoff are output.

- 3 Press and hold **Q/ESC** for at least 2 seconds to return to normal mode.

- If no operation is performed for 15 seconds, the unit will return to normal mode automatically.
- The function is inoperable when DEFEAT is set to ON.

Turning Loudness On/Off

Loudness introduces a special low- and high-frequency emphasis at low listening levels. This compensates for the ear's decreased sensitivity to bass and treble sound.

Press and hold **Rotary encoder (LOUD)** for at least 2 seconds to activate or deactivate the loudness mode.

- The function is inoperable when DEFEAT is set to ON.

Other Functions

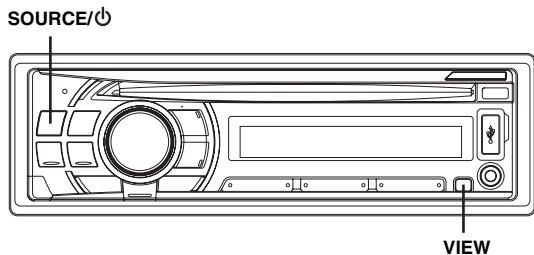

* This illustration is CDE-103EBT.

Displaying the Text

Text information, such as the disc name and the track name, will be displayed if playing a CD text compatible disc. It is also possible to display the folder name, the file name and the tag, etc., while playing MP3/WMA/AAC files.

Press VIEW.

The display will change every time the button is pressed.

- When the TEXT SCR is set to SCR MANU, press and hold VIEW for at least 2 seconds, the current text will be scrolled one time (except Radio mode).

The display in Radio mode:

FREQUENCY → CLOCK → FREQUENCY

The display in CD mode:

TRACK NO./ELAPSED TIME → TRACK NO./CLOCK →
TEXT (DISC NAME)*¹ → TEXT (TRACK NAME)*¹ →
TRACK NO./ELAPSED TIME

The display in MP3/WMA/AAC mode:

FILE NO./ELAPSED TIME → FOLDER NO./FILE NO. →
FILE NO./CLOCK → FOLDER NAME → FILE NAME →
ARTIST NAME*² → ALBUM NAME*² → SONG NAME*² →
FILE NO./ELAPSED TIME

The display in AUX mode (CDE-103EBT/CDE-102E only):

AUX NAME → AUX NAME/CLOCK → AUX NAME

The display in BT AUDIO mode (CDE-102E/CDE-101E/CDE-101EM only):

The Following display will be shown only when a telephone or Bluetooth Streaming device with Metadata capabilities is correctly connected with a Bluetooth INTERFACE (KCE-400BT). (Alpine KCE-400BT) (Sold Separately). (For details on Bluetooth INTERFACE, refer to the Owner's Manual of KCE-400BT).

BT A/ELAPSED TIME → BT A/CLOCK → ARTIST NAME*² →
ALBUM NAME*² → SONG NAME*² → BT A/ELAPSED TIME

*¹ Displayed during playback of a disc with CD text.

*² ID3 tag/WMA tag

If an MP3/WMA/AAC file contains ID3 tag/WMA tag information, the ID3 tag/WMA tag information is displayed (e.g., song name, artist name, and album name). All other tag data is ignored.

About the indication display

When displaying Text, the following indicators are lit according to the mode.

Indicator/ Mode	CD Mode	MP3/WMA/AAC/ USB AUDIO Mode	iPhone/iPod/BT AUDIO* ⁴ Mode
	—	Folder Name* ² being displayed	—
	—	Artist Name* ¹ being displayed	Artist Name* ¹ being displayed
	Text (Disc Name* ³) being displayed	Album Name* ¹ being displayed	Album Name* ¹ being displayed
	Text (Track Name* ³) being displayed	Song Name* ¹ / File Name being displayed	Song Name* ¹ being displayed

*¹ Tag information

If there is no tag information, "ARTIST"/"ALBUM"/"SONG" is displayed.

*² The root folder of disc is displayed as "FOLDER". The root folder of USB memory is displayed as "ROOT".

*³ If there is no Text (Disc Name or Track Name), "DISC TEXT"/"TRACK TEXT" is displayed.

*⁴ CDE-102E/CDE-101E/CDE-101EM only.

About "Text"

Text:

Text compatible CDs contain text information such as the disc name and track name. Such text information is referred to as "text."

- Some characters may not be displayed correctly with this device, depending on the character type.
- "NO SUPPORT" is displayed when the desired text information cannot be displayed on this unit.
- The text or tag information may not be correctly displayed, depending on the contents.

Displaying Time

Press VIEW repeatedly until the time is displayed.

Each press changes the display.

For details, see "Displaying the Text" (page 14).

- Selecting any tuner or CD function while in the clock priority mode will interrupt the time display momentarily. The function selected will be displayed for about 5 seconds before the time returns to the display.

Using the Front AUX Input Terminal (CDE-103EBT/CDE-102E only)

Connect a portable music player, etc. by simply connecting it to the input on the front panel. An optional adapter cable is required (standard RCA to 3.5 ϕ mini-phono plug or 3.5 ϕ to 3.5 ϕ mini phono plug).

Press **SOURCE**/ \odot , and select the **AUX** mode to listen to the portable device.

TUNER \rightarrow DISC \rightarrow USB AUDIO \rightarrow iPod^{*1}/AUX+^{*2} \rightarrow
BT AUDIO^{*3} \rightarrow AUX \rightarrow TUNER

^{*1} Displayed only when the iPhone/iPod is connected and AUX+ SETUP is set to OFF, refer to "Setting the AUX+ SETUP Mode" (page 17).

^{*2} Displayed only when the AUX+ SETUP is set to ON, refer to "Setting the AUX+ SETUP Mode" (page 17).

^{*3} CDE-102E/CDE-101E/CDE-101EM only. Displayed only when BT IN is set to BT ADAPTER. Refer to "Bluetooth Setting" (page 16).

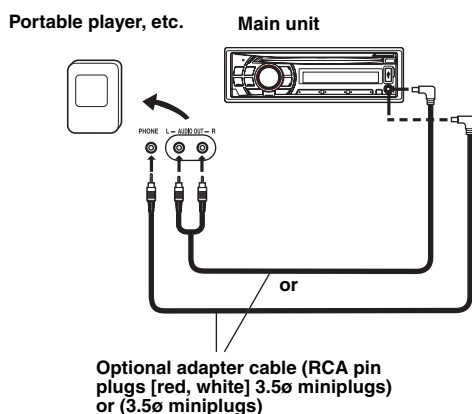

SETUP

You can flexibly customize the unit to suit your own preferences and usage. From the SETUP menu, Sound Customizing, Visual Customizing, etc., can be modified.

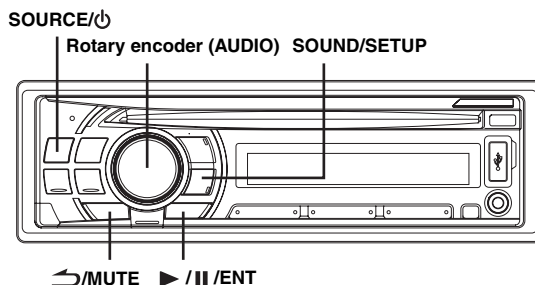

^{*} This illustration is CDE-103EBT.

Use steps 1 to 4 to select one of the SETUP modes to modify. See the applicable section below for details about the selected SETUP item.

- 1 Press and hold **SOUND/SETUP** for at least 2 seconds to activate the SETUP mode.
- 2 Turn the **Rotary encoder** to select the desired SETUP menu, and then press **▶/||/ENT**.
(e.g. Select SUBWOOFER)

BT IN^{*1} \leftrightarrow CLOCK ADJ^{*2} \leftrightarrow PLAY MODE \leftrightarrow INT MUTE^{*3} \leftrightarrow
AUX+ SETUP \leftrightarrow AUX+ NAME^{*4} \leftrightarrow AUX NAME^{*5} \leftrightarrow
POWER IC \leftrightarrow DEMO \leftrightarrow SUBWOOFER \leftrightarrow SUBW SYS^{*6} \leftrightarrow
ILLUMINATI^{*7} \leftrightarrow DIMMER^{*8} \leftrightarrow SCROLLTYPE \leftrightarrow TEXT SCR
 \leftrightarrow BT IN
- ^{*1} Displayed only when INT MUTE is set to OFF, and the mode is set to other than BT AUDIO.
- ^{*2} Refer to "Setting Time" (page 7).
- ^{*3} Displayed only when BT IN is OFF.
- ^{*4} Displayed only when AUX+ SETUP is ON.
- ^{*5} CDE-103EBT/CDE-102E only.
- ^{*6} Displayed only when SUBWOOFER is ON.
- ^{*7} CDE-103EBT only.
- ^{*8} CDE-103EBT/CDE-102E/CDE-101E only.
- 3 Turn the **Rotary encoder** to change the setting.
(e.g. Select SUBW ON or SUBW OFF.)
- 4 Press and hold **SOUND/SETUP** for at least 2 seconds to return to normal mode.
 - Press **↶/MUTE** to return to the previous mode.
 - If no operation is performed for 60 seconds, the unit will return to normal mode automatically.

Bluetooth Setting

Setting the Bluetooth Connection (BT IN)

BT ADAPTER / BT OFF (Initial setting)

With Bluetooth technology, you can place a hands-free call by a Bluetooth-equipped mobile phone.

CDE-102E/CDE-101E/CDE-101EM:

If an optional Bluetooth INTERFACE (KCE-400BT) is connected, make this setting when the Bluetooth function is used. For details, refer to the Owner's Manual of the optional Bluetooth INTERFACE (KCE-400BT). Set ADAPTER when the Bluetooth INTERFACE (KCE-400BT) is connected.

- The  button can be used only when the optional Bluetooth INTERFACE (KCE-400BT) is connected.
- If the mobile phone compatible with the Voice Dial function is connected, the Voice Dial function can be used.

CDE-103EBT:

Set ADAPTER when the Bluetooth function is used. For details on the set up procedure, refer to "Bluetooth SETUP" on page 18.

Sound Customizing

Subwoofer On and Off

SUBW ON (Initial setting) / SUBW OFF

When the subwoofer is on, perform the steps below to adjust the subwoofer output level.

- 1 In the normal mode, press Rotary encoder (AUDIO) repeatedly to select the SUBWOOFER mode.
SUBWOOFER → BASS LEVEL → TRE LEVEL → BALANCE → FADER → DEFEAT → VOLUME → SUBWOOFER
- 2 Adjust the level by turning the Rotary encoder.

Setting the Subwoofer System

SUBW SYS 1 (Initial setting) / SUBW SYS 2

Select either SYS 1 or SYS 2 for the desired subwoofer effect.

- SUBW SYS 1: Subwoofer level changes according to the main volume setting.
- SUBW SYS 2: Subwoofer level change is different from the main volume setting. For example, even at low volume settings, the subwoofer is still audible.

Visual Customizing

Changing Lighting Colour (CDE-103EBT only)

ILUM TYPE1 (Initial setting) / TYPE2 / TYPE3 / TYPE4

You can change the lighting colour of the following four buttons. SOURCE/, BAND, , .

- TYPE1 : When the colour of the four buttons is blue, the colour of the other is red.
- TYPE2 : When the colour of the four buttons is green, the colour of the other is green.
- TYPE3 : When the colour of the four buttons is amber, the colour of the other is red.
- TYPE4 : When the colour of the four buttons is red, the colour of the other is red.

Dimmer Control (CDE-103EBT/CDE-102E/CDE-101E only)

DIM AUTO (Initial setting) / DIM MANUAL

Set the DIMMER control to AUTO to decrease the illumination brightness of the unit with the head lights of the vehicle ON. This mode is useful if you feel the unit's backlighting is too bright at night.

- The function is inoperable when the ILLUMINATI is set to other than TYPE1 for CDE-103EBT, refer to "Changing Lighting Colour (CDE-103EBT only)" on page 16.

Scroll Type Setting

SCR TYPE1 / SCR TYPE2 (Initial setting)

Choose from two scrolling methods.

Select the type you prefer.

- SCR TYPE1: The characters scroll from right to left, a single character at a time.
- SCR TYPE2: Words are built up from left to right, a single character at a time. When the display is filled, it is cleared and the remaining words are displayed the same way until all words of the title have been shown.

Scroll Setting (TEXT SCR)

SCR AUTO / SCR MANU (Initial setting)

This CD player can scroll the disc and track names recorded on CD-TEXT discs, as well as the text information of MP3/WMA/AAC files, folder names and tags.

- SCR AUTO: The CD text information, the text information of folder and file names, and the tags are scrolled automatically.
- SCR MANU: The display is scrolled when a disc is loaded or when a track is changed, etc.

- The unit scrolls CD text names, folder names, file names or tag display.

Demonstration

DEMO ON / DEMO OFF (Initial setting)

This unit has a demonstration feature for the display.

- To quit Demo mode, set to DEMO OFF.

MP3/WMA/AAC

Playing MP3/WMA/AAC Data (PLAY MODE)

CD-DA (Initial setting) / CDDA/MP3

This unit can play back CDs containing both CD and MP3/WMA/AAC data (created in Enhanced CD (CD Extra) format). However, in some situations, playback of an enhanced CD may be difficult. In this case, you can select playback of a single session only, containing the CD data. When a disc contains both CD and MP3/WMA/AAC data, playback starts from the CD data portion of the disc.

- CD-DA: Only the CD data in Session 1 can be played back.
- CDDA/MP3: CD data, MP3/WMA/AAC files in mixed mode, and multi-session discs can be played back.

- Perform this setting before inserting a disc. If a disc has already been inserted, remove it first.

External Device

Turning Mute Mode On/Off (INT MUTE)

MUTE ON / MUTE OFF (Initial setting)

If a device having the interrupt feature is connected, audio will be automatically muted whenever the interrupt signal is received from the device.

Connecting to an External Amplifier (POWER IC)

POW ON (Initial setting) / POW OFF

When an external amplifier is connected, sound quality can be improved by stopping the power supply of the built-in amplifier.

POW OFF: Use this mode when the line output of this unit is used to drive an external amplifier. In this setting, the head unit's internal amplifier is turned OFF and cannot drive speakers.

CDE-103EBT/CDE-102E:

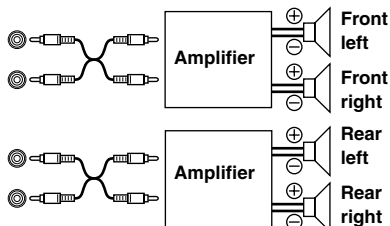

CDE-101E/CDE-101EM:

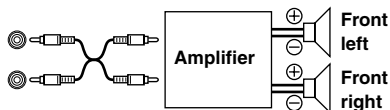

POW ON : The speakers are driven by the built-in amplifier.

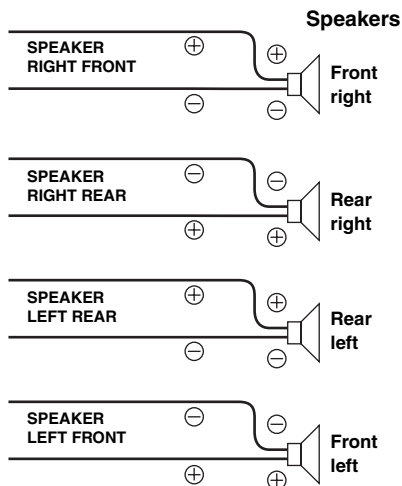

- No sound is produced by the system when the power output is set to OFF.

Setting the AUX+ SETUP Mode

AUX+ ON / AUX+ OFF (Initial setting)

An external device (such as a portable music player) can be connected to the Full Speed connector of this unit. A conversion cable (KCE-237B) for building up the AUX IN (optional) is required.

A portable music device and an iPhone/iPod cannot be connected to the Full Speed connector at the same time.

AUX+ ON: Set to ON when a portable device is connected. If **SOURCE/⏻** is pressed and AUX+ is selected, the sound of the portable device is input to the unit.

AUX+ OFF: Set to OFF when an iPhone/iPod is connected.

You can change the AUX+ name display when AUX+ SETUP is set to ON. Press **▶/||/ENT** when AUX+ SETUP is set to ON, and select AUX+ NAME by turning the **Rotary encoder**, then press **▶/||/ENT**. After that, turn the **Rotary encoder** to select the desired AUX+ name.

Setting the AUX NAME mode (CDE-103EBT/CDE-102E only)

AUXILIARY*¹ (Initial setting) / TV / DVD / PORTABLE*² / GAME

You can change the AUX NAME display in the SETUP mode.

*¹ After the setting is completed, AUX is displayed on the unit.

*² After the setting is completed, PMD is displayed on the unit.

BLUETOOTH (CDE-103EBT only)

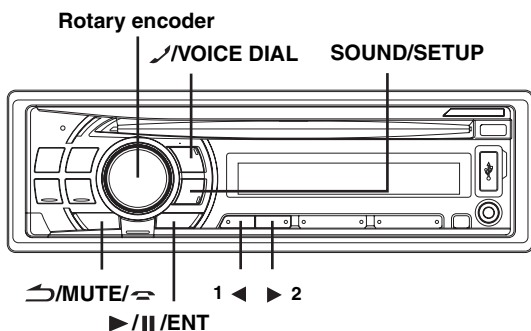

* This illustration is CDE-103EBT.P

Setup Before Using

About Bluetooth

Bluetooth is a wireless technology allowing communication between a mobile device or personal computer over short distances. This enables a hands-free call or data transmission between Bluetooth compatible devices.

- Depending on the Bluetooth version, a Bluetooth compatible device may not be able to communicate with this unit.
- Proper function of this unit with all Bluetooth compatible devices is not guaranteed. For handling of the BT compatible device, consult your ALPINE dealer or ALPINE website.
- Depending on the surroundings, Bluetooth wireless connection may be unstable.
- When you place a call, or perform setup operations, be sure to stop your car in a safe place.
- Depending on the connected Bluetooth compatible device(s), the function may differ. Also refer to the Owner's Manual of the connected device(s).

Before Using Hands-Free Function

Before using the hands-free phone/audio function, the following settings need to be made.

- 1 Be sure to set "INT MUTE" to OFF. Refer to the SETUP function on page 15.**
 - To enable sound pass-through of the Bluetooth compatible device, make sure that INT MUTE is turned OFF (Initial setting on the unit is OFF).
- 2 Set "BT IN" to BT ADAPTER (page 16).**
 - Before using a hands-free phone, it must be paired with this unit. Refer to "Bluetooth SETUP" (pages 18-19).

How to connect to a Bluetooth compatible device (Pairing)

For details on the control from a Bluetooth compatible device, refer to the Owner's Manual of the Bluetooth compatible device.

- 1 Set a Bluetooth connection from a Bluetooth compatible device.**
- 2 The PIN code ("0000") is displayed on the connected unit.**
 - The PIN code is fixed as "0000."
- 3 Input the PIN code ("0000") in a Bluetooth compatible device.**
- 4 If this unit is successfully connected to a Bluetooth compatible device, "CONNECTED" is displayed, and then the unit returns to normal mode.**
 - The registration number 5 is the guest mode. Content that is registered as the guest mode is deleted when you set ignition from ACC to OFF. If all the 5 positions (including guest mode) have been registered, you cannot register the 6th device. To register another device, you need to delete one of the device from position 1 to 5 first.
 - If a Bluetooth compatible device is successfully connected, the next time when the ignition key of the car is turned to on, the unit will automatically connect to the previously connected device. However, the connection may fail. If the auto connection fails, try the connection manually.
 - Set "Setting the Search Mode" (page 19) to VISI M ON to enable this unit to recognise a mobile phone. For mobile phone passkey (passcode) input operation, refer to the mobile's Owner's Manual.

Bluetooth SETUP

Bluetooth Setup Operation

The following steps 1 to 4 are common to the various Bluetooth functions. For details, refer to each individual function.

- While calling, Bluetooth Setup operation cannot be performed.
 - Set "BT IN" to BT ADAPTER, and then perform Bluetooth SETUP operation.
- 1 Press and hold SOUND/SETUP for at least 2 seconds to activate the SETUP mode.**
 - 2 Turn the Rotary encoder to select the desired items and then press ▶/II/ENT.**

BT IN ↔ PAIRED DEV* ↔ VISIBLE M* ↔ AUTO ANS* ↔ CLEAR DEV* ↔ SEV NAME* ↔ MIC INPUT* ↔ SPEAKER SL* ↔ FW VERSION* ↔ FW UPDATE*

* When "BT IN" is set to BT ADAPTER, the above items are displayed.
 - 3 Turn the Rotary encoder to change the settings.**
 - 4 Press and hold SOUND/SETUP for at least 2 seconds.**

The SETUP mode is cancelled.

Setting the Bluetooth Device

Select one of 5 connected Bluetooth compatible devices that you previously registered (the fifth registered by guest mode*).

Setting item: PAIRED DEV

Turn the Rotary encoder to select a Bluetooth compatible device you want to use (you want to change connection) and then press ►/||/ENT.

- If the connection is successfully changed, "CONNECTED" is displayed for 2 seconds and the  indicator lights up, then the display returns to the SETUP screen.
- If you input the wrong passcode or communications fail, "FAILED" is displayed.
- If you want to connect another Bluetooth compatible device, after disconnecting the current Bluetooth compatible device, connect the Bluetooth compatible device you want to change to. The PIN code is fixed as "0000".

* Guest mode:

Use this mode for a temporary pairing. Registration (in guest mode) is cancelled once the ignition key goes from ACC to off.

Setting the Search Mode

You can set whether this unit can be recognised or not from a Bluetooth compatible device. Normally set this to VISI M ON.

Setting item: VISIBLE M

- VISI M ON: Enable recognition of this unit from the Bluetooth compatible device.
- VISI M OFF: Disable recognition of this unit from the Bluetooth compatible device.

- Depending on the mobile phone, it may be necessary to input a passcode. For inputting the mobile phone's passcode, refer to the mobile phone's Owner's Manual.

Setting the Received Calls automatically (Auto Answer)

When a call is received, you can set whether to receive it automatically or not.

Setting item: AUTO ANS

- AT ANS ON: When a call is received, it will be taken automatically.
- AT ANS OFF: When a call is received, it will not be received automatically, press  to receive a call.

- Even if this setting is set to ON/OFF, the received call setting on the mobile phone takes priority.

Deleting a Bluetooth Device from the list

You can delete the history of a previously connected Bluetooth compatible device.

Setting item: CLEAR DEV

- 1 Turn the Rotary encoder to select the Bluetooth compatible device to be deleted and then press ►/||/ENT.**
- 2 Turn the Rotary encoder to select CLEAR YES if you want to delete and then press ►/||/ENT.**

- Selecting CLEAR NO will cancel the setting.

Displaying the phone service provider name

Setting item : SEV NAME

The service provider name of the connected Bluetooth compatible device will be displayed. If a Bluetooth compatible device is not connected, "ID UNSENT" will also be displayed.

- Depending on the character type some phone service provider name cannot be displayed.

Adjusting the volume for the microphone input

You can emphasise or weaken the microphone input volume level.

Setting item : MIC INPUT

Turn the **Rotary encoder** to select the desired volume level (0~7).

- The setting cannot be adjusted during a phone call. Adjust the setting before placing a call.

Selecting the output speaker

You can select the connected speaker in car to output the sound signal of telephone.

Setting item : SPEAKER SL

- ALL: The sound be output from all of speakers in car.
- F-L: The sound only be output from the front left speaker.
- F-R: The sound only be output from the front right speaker.
- F-LR: The sound be output from the front left and front right speaker.

- The setting cannot be adjusted during a phone call. Adjust the setting before placing a call.

Displaying the firmware version

Setting item : FW VERSION

The current firmware version will be displayed.

Updating the firmware

Setting item: FW UPDATE

With this setting, the Bluetooth firmware update function can be activated, but other devices and software may be required. For details, consult ALPINE website.

Hands-Free Phone Control

About the Hands-Free Phone

Hands-free calls are possible when using a HSP (Head Set Profile) and HFP (Hands-Free Profile) compatible mobile phone with this unit.

- Avoid answering a hands-free call in heavy traffic or on narrow or winding streets.
- Close the windows while calling to reduce background noise.
- If both calling parties are using hands-free devices, or the call is made in a noisy location, difficulty hearing the other person's voice is normal.
- Depending on telephone line conditions or certain mobile devices used, voices may sound unnatural.
- When using a microphone, speak as directly as you can into the microphone to pick up the best sound quality.
- Certain mobile phone features are dependent on the capabilities and settings of your service provider's network. Additionally, certain features may not be activated by your service provider, and/or the provider's network settings may limit the feature's functionality. Always contact your service provider about feature availability and functionality.

All features, functionality, and other product specifications, as well as the information contained in the Owner's Manual are based upon the latest available information and are believed to be accurate at the time of printing.

Alpine reserves the right to change or modify any information or specifications without notice or obligation.

Answering a Call

Incoming calls are announced by the received call ring tone and a displayed message (PHONE).

Press .

The call starts.

- When "Setting the Received Calls automatically (Auto Answer)" (page 19) is set to AT ANS ON, you can receive a call automatically.
- While calling, the source sound on the unit is muted. After calling, playback will resume.

Hanging up the Telephone

Press and hold  **for at least 2 seconds.**

The call finishes.

- While receiving you can also hang up by pressing and holding  for at least 2 seconds.

Redial Function

You can redial the person you have previously called.

After finishing a call "-----" will be displayed, press  **within 5 seconds.**

The telephone is redialed.

- If you receive a call from an unknown number, you cannot use the redial function to call back.

Calling

Call History is recorded for the last dialed/received/missed calls. There are various ways of making calls based on the "Calling." The following steps 1 to 5 are common to the various ways of making these calls. For details, refer to each individual category for making calls.

1 Press .

The outgoing method list is displayed.

2 Turn the Rotary encoder to select the outgoing mode.

Setting items : DIALED / RECEIVED / MISSED / PHONE BOOK

DIALED : Dialed history

RECEIVED : Received history

MISSED : Missed incoming history

PHONE BOOK : Mobile phonebook

3 Press / / ENT.

The outgoing mode is activated, and each mode list is displayed.







- It may take some time for the list to be displayed, and also directly after connection, the list may not be brought up to date.

4 Turn the Rotary encoder to select a name or a telephone number from the list.

- The names of PHONE BOOK are listed alphabetically with the same beginning alphabetical character, and can be skipped to the next alphabetical character by pressing **1**  or **2**. e.g. Press **2** to the section beginning with alphabet B from A.

5 Press / / ENT.

The selected telephone will be called.

If one name has several numbers registered in the telephone book, press  /  / ENT after selecting the name*, then turn the Rotary encoder to choose the desired number and press  /  / ENT, the telephone will be called. Press and hold  /  / ENT for at least 2 seconds after selecting the name, the default number of the name will be called. Depending on the connected mobile phone, this function may not be performed.

* If the name cannot be recognised, default number will be displayed.

- The names registered in the telephone book are displayed. If the name is not registered, a number is displayed. If both name and number cannot be displayed, "ID UNSENT" will be displayed.
- If you place a call directly from the paired mobile phone, the phone number is not displayed, you cannot redial from the unit in this case.

Redialing a Number In Outgoing History

Previously dialed telephone numbers are stored in dialed calls history. You can redial a number by searching from dialed calls history.

Setting item: DIALED

Dialing a Number In Incoming History

Telephone numbers from received calls are stored in the Received List. You can redial these numbers by searching here.

Setting item: RECEIVED

Dialing a Number In Incoming Missed Call History

Telephone numbers for received calls that are missed, are stored in the Missed List. You can redial these numbers by searching here.

Setting item: MISSED

Dialing a Number In The Phone Book

Up to 1,000 telephone numbers are downloadable from a mobile phone. Dial a call by selecting a person from the phone book list.

Setting item: PHONE BOOK

- If a name cannot be obtained via the phonebook, “-----” is displayed.
- The order of the list display depends on the design of the mobile phone.
- If the call history or phonebook of the mobile phone is added or deleted while it is connected to the unit, the list displayed on the unit may not be brought up to date. If it is not updated, you cannot correctly place a call.

Voice Dial Operation

You can call the telephone by performing voice operation.

1 Press and hold **VOICE DIAL** for at least 2 seconds.

The speak mode is activated, and “SPEAK” is displayed.

2 Say the telephone number, name you want to call into the microphone.

- You can perform this operation only when a voice dial compatible mobile phone is connected. If the mobile phone is not compatible with the voice dial, “NO SUPPORT” is displayed for 2 seconds.
- The Voice Dial function performance depends on the recognition range of the mobile phone and mounting location of the microphone. Note when the microphone is mounted.
- Voice dial operation depends on the function of the mobile phone. For details, refer to the Owner’s Manual of the mobile phone.
- If a called person that you say is not found, “NO CALL” is displayed for 2 seconds.
- If you place a call via voice dial, you cannot display a phone number or name.

Adjusting the volume when receiving a Call

While calling, you can adjust the volume.

Turn the Rotary encoder to adjust the volume.

- You may need to increase volume from your regular audio listening source level. However, increasing the volume excessively may result in feedback. If feedback is noticed as feedback is directly related to the volume, turn down the volume as low as acceptable to eliminate it. Positioning the microphone in a direction away from the main car speakers (e.g. clipped on sun visor) may also reduce feedback at high volume.

Call Switching Operation

While making a call, this function allows you to initiate the transfer of the audio between the mobile phone and the speakers in the car.

While calling, press and hold **II/ENT** for at least 2 seconds to switch the call sound between the unit and mobile phone.

- Depending on the mobile phone, this operation may not be performed.

USB memory (Optional)

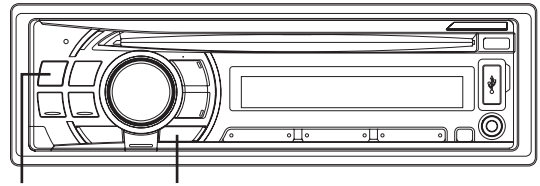

SOURCE/II/ENT

* This illustration is CDE-103EBT.

Controlling USB memory (Optional)

A USB memory device may be connected to this unit. With USB memory connected, playback of files on the device is controlled from this unit.

- The controls on this unit for USB memory operation are operative only when a USB memory is connected.

Playing MP3/WMA/AAC Files with the USB memory (Optional)

If you connect a USB memory containing MP3/WMA/AAC, you can play these files on this unit.

1 Press **SOURCE/II/ENT** to switch to the USB AUDIO mode.

The mode will change every time the button is pressed.

TUNER → DISC → USB AUDIO → iPod*/AUX+*²
→ BT AUDIO*³ → AUX*⁴ → TUNER

- ^{*1} Displayed only when the iPhone/iPod is connected and AUX+ SETUP is set to OFF, refer to “Setting the AUX+ SETUP Mode” (page 17).
- ^{*2} Displayed only when the AUX+ SETUP is set to ON, refer to “Setting the AUX+ SETUP Mode” (page 17).
- ^{*3} Only for CDE-102E/CDE-101E/CDE-101EM and BT IN is set to BT ADAPTER. Refer to “Bluetooth Setting” (page 16).
- ^{*4} Refer to “Using the Front AUX Input Terminal (CDE-103EBT/CDE-102E only)” (page 15).

2 To pause playback, press **II/ENT**.

Pressing **II/ENT** again will resume the playback.

- The root folder is displayed as “ROOT” in the Folder Name Search mode.
- When a search is made in the USB mode, any song being played back will be stopped.
- This unit plays back files on a USB memory device with the same controls and modes as playback of CDs containing MP3/WMA/AAC. For details, refer to “CD/MP3/WMA/AAC” on pages 8 to 11.
- Before disconnecting USB memory, be sure to change to another source or set to pause.
- The playback time may not be correctly displayed when a VBR (Variable Bit Rate) recorded file is played back.

USB Memory Connection (Optional)

Connect USB memory

- 1 Open the cover of the USB connection terminal.
- 2 Connect the USB memory directly to the USB connection terminal, or via the USB cable.

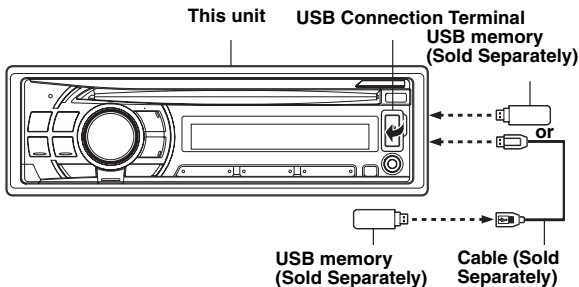

Remove USB memory

- 1 Carefully, pull out the USB memory from the USB cable or the USB connection terminal.
 - 2 Close the cover of the USB connection terminal.
- Change to a source other than the USB memory mode, then remove the USB memory. If the USB memory is removed in the USB memory mode, data may be damaged.
 - When removing USB memory, pull it out straight.
 - If sound is not output or USB memory is not recognised even when USB memory is connected, remove USB memory once, then connect it again.
 - Route the USB cable away from other cables, etc.
 - After removing the USB memory, close the cover of the USB connection terminal to prevent dust or foreign objects from entering and causing a malfunction.

About MP3/WMA/AAC File of USB Memory

Playing back MP3/WMA/AAC

MP3/WMA/AAC files are prepared, then stored to a USB memory. This unit can recognise at least 100 folders (including root folder) and 100 files per folder stored in USB memory. Playback may not be performed if a USB memory exceeds the limitations described above. Do not make a file's playback time more than 1 hour.

Media supported

This device can play back USB memory media.

Corresponding File Systems

This device supports FAT 12/16/32 for USB memory device.

iPhone/iPod (Optional)

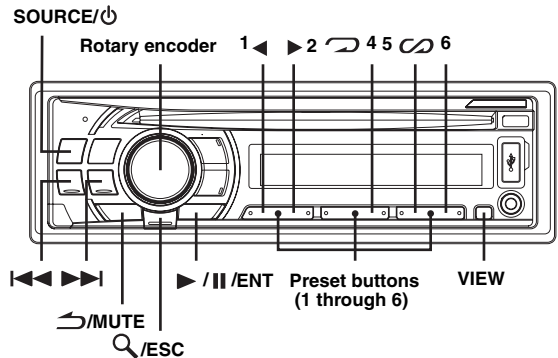

* This illustration is CDE-103EBT.

An iPhone/iPod can be connected to this unit by using the proprietary ALPINE FULL SPEED™ Connection Cable (KCE-433iV) (sold separately). When this unit is connected by using the cable, the controls on the iPod are not functional.

- Set *AUX+ SETUP* to OFF when an iPhone/iPod is connected (refer to "Setting the AUX+ SETUP Mode" on page 17).
- If the Bluetooth INTERFACE (KCE-400BT) and an iPhone/iPod are connected at the same time, be sure to disconnect the iPhone/iPod from Bluetooth INTERFACE (KCE-400BT) while turning ACC to OFF (CDE-102E/CDE-101E/CDE-101EM only).
- If you connect an iPhone to this unit, it can be used as an iPod. If you use iPhone as a hands-free phone, use the unit (CDE-103EBT only) in which the Bluetooth function is built, or use the Bluetooth INTERFACE (KCE-400BT) (sold separately) (CDE-102E/CDE-101E/CDE-101EM only).
- Internet and telephone functions of iPod touch or iPhone, etc., can also be used when connecting to the unit. However, using these functions will stop or pause the playing songs, at this time do not operate the unit to avoid a malfunction.
- Do not leave an iPhone/iPod in a car, as its mechanism is sensitive to high temperature and humidity conditions, and damage may result.

iPhone/iPod models usable with this unit

- The unit can be used with the following iPhone/iPod models.
 - iPhone 3G (version 2.0)
 - iPhone (version 1.1.4)
 - iPod touch (version 1.0.4)
 - iPod classic (version 1.1.1)
 - iPod nano (3rd generation) (version 1.1)
 - iPod nano (2nd generation) (version 1.1.3)
 - iPod with video (version 1.2.3)
 - iPod nano (1st generation) (version 1.3.1)
- For clarity in identifying your model of iPod, please see Apple's own document "Identifying iPod models" at <http://support.apple.com/kb/HT1353>.
- This unit does not support video playback from iPhone/iPod, even using a video-compatible cable.
- If the unit is used with versions of iTunes earlier than 7.6, correct function and performance are not guaranteed.

Playback

1 Press SOURCE/⏻ to switch to the iPod mode.

TUNER → DISC → USB AUDIO → iPod*¹/AUX+*²
→ BT AUDIO*³ → AUX*⁴ → TUNER

*¹ Displayed only when the iPhone/iPod is connected and AUX+ SETUP is set to OFF, refer to “Setting the AUX+ SETUP Mode” (page 17).

*² Displayed only when the AUX+ SETUP is set to ON, refer to “Setting the AUX+ SETUP Mode” (page 17).

*³ Only for CDE-102E/CDE-101E/CDE-101EM and BT IN is set to BT ADAPTER. Refer to “Bluetooth Setting” (page 16).

*⁴ Refer to “Using the Front AUX Input Terminal (CDE-103EBT/ CDE-102E only)” (page 15).

2 Press ◀◀ or ▶▶ to select the desired song.

Return to the beginning of the current song:

Press ◀◀.

Fast backward through current song:

Press and hold ◀◀.

Advance to the beginning of the next song:

Press ▶▶.

Fast forward through current song:

Press and hold ▶▶.

3 To pause playback, press ▶/||/ENT.

Pressing ▶/||/ENT again will resume playback.

- A song playing on the iPhone/iPod while it is connected to this unit will continue to play from where it was paused after disconnection.
- If you listen to an episode from a selected podcast or audiobook, the episode can be changed by pressing 1 ◀ or ▶ 2.
- An episode may have several chapters, the chapter can be changed by pressing ◀◀ or ▶▶.

Searching for a desired Song

An iPhone/iPod can contain hundreds of songs. By using file tag information and keeping these songs organized in playlists, this unit's search functions will ease song searches.

Each music category has its own individual hierarchy. Use the Playlist/Artist/Album/Song/Podcast/Genre/Composer/Audiobook search mode to narrow searches based on the table below.

Hierarchy 1	Hierarchy 2	Hierarchy 3	Hierarchy 4
Playlist	Song	—	—
Artist*	Album*	Song	—
Album*	Song	—	—
Song	—	—	—
Podcast	Episode	—	—
Genre*	Artist*	Album*	Song
Composer*	Album*	Song	—
Audiobook	—	—	—

For example: Searching by Artist name

The following example explains how an ARTIST search is performed. Another search mode can be used for the same operation, although the hierarchy differs.

1 Press Q/ESC to activate the search selection mode.
The “Q” indicator lights up.

2 Turn the Rotary encoder to select the ARTIST search mode, and then press ▶/||/ENT.

PLAYLIST ↔ ARTIST ↔ ALBUM ↔ SONG ↔ PODCAST
↔ GENRE ↔ COMPOSER ↔ AUDIOBOOK ↔ PLAYLIST

3 Turn the Rotary encoder to select the desired Artist, and then press ▶/||/ENT.

4 Turn the Rotary encoder to select the desired Album, and then press ▶/||/ENT.

5 Turn the Rotary encoder to select the desired Song, and then press ▶/||/ENT.

- After pressing and holding ▶/||/ENT for at least 2 seconds while in each hierarchy (except SONG and AUDIOBOOK hierarchy), all songs of the selected hierarchy are played back.
- After selecting [ALL] in the search mode with “*”, press and hold ▶/||/ENT for at least 2 seconds to play back all songs in the iPhone/iPod or selected search mode.
- While in the search mode, if you press and hold Q/ESC for 2 seconds, or no operation is performed for 10 seconds, the search mode is cancelled.
- In the search mode, pressing ⇐/MUTE will return to the previous mode.
- When search is made during M.I.X. play, the M.I.X. play mode will be cancelled.
- “NO SONG” will be displayed if there are no songs in the selected playlist in the PLAYLIST search mode.
- “NO PODCAST” will be displayed if there is no podcast data in the iPhone/iPod in the PODCAST search mode.
- “NOAUDIOBOOK” will be displayed if there is no audiobook data in the iPhone/iPod in the AUDIOBOOK search mode.
- If “iPod name” stored in the iPhone/iPod is selected in the desired Playlist search mode, and ▶/||/ENT is pressed, you can search for all songs in the iPhone/iPod. Also, if you press and hold ▶/||/ENT for at least 2 seconds, all songs in the iPhone/iPod are played back.
- Depending on the iPhone/iPod, podcast search is not supported.
- If any one of the preset buttons (1 through 6) is pressed in the search mode, a search can be made quickly by skipping to the specified location. For details, refer to “Direct Search Function” on page 24.

Quick Search

You can search a song from all songs in the iPhone/iPod without selecting an album, artist, etc.

1 Press and hold Q/ESC for at least 2 seconds to activate the Quick Search mode.
The “Q” indicator lights up.

2 Turn the Rotary encoder to select a desired song.
The selected song is played back immediately.

- Press and hold Q/ESC for at least 2 seconds in the search mode to cancel. Or, the search mode is cancelled if no operation is performed for 10 seconds.
- If many songs are in the iPhone/iPod, it takes time to search for songs.
- If any one of the preset buttons (1 through 6) is pressed in the search mode, a search can be made quickly by skipping to the specified location. For details, refer to “Direct Search Function” on page 24.
- This function is inactive during repeat (↻) playback.

Direct Search Function

The unit's direct search function can be used to search for an album, song, etc., more efficiently. In PLAYLIST/ARTIST/ALBUM/SONG/PODCAST/GENRE/COMPOSER/AUDIOBOOK mode, you can quickly target any song.

In the search mode, press any one of the preset buttons (1 through 6) to quickly skip over a designated percent of your song content.

Song search example:

If there are 100 songs in your iPhone/iPod, they are divided into 6 groups using percentages (shown below). These groups are assigned to the preset buttons (1 through 6).

Example 1:

Suppose the song you are searching for is located at around the middle (50%) of your library: press button 4 to jump to the 50th song and turn the Rotary encoder to find the desired song.

Example 2:

Suppose the song you are searching for is located near the end (83%) of your library: press button 6 to jump to the 83rd song and turn the Rotary encoder to find the desired song.

	All 100 songs (100%)					
	0%	17%	33%	50%	67%	83%
Preset buttons	1	2	3	4	5	6
Songs	First song	17th song	33rd song	50th song	67th song	83rd song

Select Playlist/Artist/Album/Genre/Composer

Playlist/Artist/Album/Genre/Composer can be easily changed. For example, if you listen to a song from a selected album, the album can be changed.

Press 1 ◀ or ▶ 2 to select the desired Playlist/Artist/Album/Genre/Composer.

- If the song search mode was used to select a song, this function is inactive.
- If an album is selected during an artist search, other albums by that artist are searchable.
- This function is inactive during shuffle (🌀) playback.

Random Play Shuffle (M.I.X.)

The Shuffle function of the iPhone/iPod is displayed as 🌀 on this unit.

Shuffle Albums:

The songs on each album are played back in proper order. Upon completion of all the songs on the album, the next album is selected randomly. This continues until all albums have been played.

Shuffle Songs:

Song shuffle randomly plays back songs within a selected category (playlist, album, etc.). The songs within the category are played just once until all songs have been played.

1 Press 5 🌀.

The songs are played back in random sequence.

📁 🌀 → 🌀 → (off) → 📁 🌀
(Shuffle Albums) (Shuffle Songs)

2 To cancel M.I.X. play, select (off) with the above procedure.

- If a song is selected in the album search mode before selecting M.I.X. play, the songs will not play back randomly even when Shuffle Albums is selected.

Shuffle ALL:

Shuffle ALL plays all songs in the iPhone/iPod randomly. Any one song does not play back again until all songs have been played back.

1 Press 6.

The songs are played back in random sequence.

🌀 → (off) → 🌀
(Shuffle ALL)

2 To cancel M.I.X. play, select (off) with the above procedure.

- If Shuffle ALL is selected, the selected songs being played back in the search mode are cancelled.

Repeat Play

Only Repeat One is available for the iPhone/iPod.

Repeat One:



A single song is repeatedly played back.

1 Press 4.

The song is played back repeatedly.

 → (off) → 
(Repeat One)

2 To cancel repeat play, select (off) with the above procedure.

- During repeat playback, no other songs are selectable by pressing  or .

Displaying the Text

You can display the tag information of a song in the iPhone/iPod.

Press **VIEW**.

Each press changes the display.

- When the *TEXT SCR* is set to *SCR MANU*, press and hold **VIEW** for at least 2 seconds, the current text will be scrolled one time.

TRACK NO./ELAPSED TIME → TRACK NO./CLOCK →
ARTIST NAME* → ALBUM NAME* →
SONG TITLE* → TRACK NO./ELAPSED TIME

* TAG information

“ARTIST”/“ALBUM”/“SONG” is displayed if there is no tag information.

- Only alphanumeric characters (ASCII) can be displayed.
- If the artist, album or song name, created in iTunes, has too many characters, songs may not be played back when connected to the adapter. Therefore, a maximum of 250 characters is recommended. The maximum number of characters for the head unit is 64 (64 byte).
- Some characters may not be correctly displayed.
- “NO SUPPORT” is displayed if text information is not supported by the unit.

Information

In Case of Difficulty

If you encounter a problem, please turn the power off, then on again. If the unit is still not functioning normally, please review the items in the following checklist. This guide will help you isolate the problem if the unit is at fault. Otherwise, make sure the rest of your system is properly connected or consult your authorized Alpine dealer.

Basic

No function or display.

- Vehicle's ignition is off.
 - If connected following instructions, the unit will not operate with the vehicle's ignition off.
- Improper power lead (Red) and battery lead (Yellow) connections.
 - Check power lead and battery lead connections.
- Blown fuse.
 - Check the fuse of the unit; replace with the proper value if necessary.
- Internal micro-computer malfunctioned due to interference noise etc.
 - Press the RESET switch with a ballpoint pen or other pointed article.

Radio

Unable to receive stations.

- No antenna or open connection in cable.
 - Make sure the antenna is properly connected; replace the antenna or cable if necessary.

Unable to tune stations in the seek mode.

- You are in a weak signal area.
 - Make sure the tuner is in the DX mode.
- If the area you are in is a primary signal area, the antenna may not be grounded and connected properly.
 - Check your antenna connections; make sure the antenna is properly grounded at its mounting location.
- The antenna may not be the proper length.
 - Make sure the antenna is fully extended; if broken, replace the antenna with a new one.

Broadcast is noisy.

- The antenna is not the proper length.
 - Extend the antenna fully; replace it if it is broken.
- The antenna is poorly grounded.
 - Make sure the antenna is grounded properly at its mounting location.

CD

CD Player not functioning.

- Out of operating temperature range +50°C (+120°F) for CD.
 - Allow the vehicle's interior (or trunk) temperature to cool.

CD playback sound is wavering.

- Moisture condensation in the CD Module.
 - Allow enough time for the condensation to evaporate (about 1 hour).

CD insertion not possible.

- A CD is already in the CD player.
 - Eject the CD and remove it.
- The CD is being improperly inserted.
 - Make sure the CD is being inserted following instructions in the CD Player Operation section.

Unable to fast forward or backward the CD.

- The CD has been damaged.
 - Eject the CD and discard it; using a damaged CD in your unit can cause damage to the mechanism.

CD playback sound skips due to vibration.

- Improper mounting of the unit.
 - Securely re-mount the unit.
- The disc is very dirty.
 - Clean the disc.
- The disc has scratches.
 - Change the disc.
- The pick-up lens is dirty.
 - Do not use a commercially available lens cleaner disc. Consult your nearest Alpine dealer.

CD playback sound skips without vibration.

- The disc is dirty or scratched.
 - Clean the disc; damaged disc should be replaced.

Error displays (built-in CD player only).

- Mechanical error.
 - Press . After the error indication disappears, insert the disc again. If the above-mentioned solution does not solve the problem, consult your nearest Alpine dealer.

CD-R/CD-RW playback not possible.

- Close session (finalisation) has not been performed.
 - Perform finalisation and attempt playback again.

MP3/WMA/AAC

MP3, WMA or AAC is not played back.

- Writing error occurred. The MP3/WMA/AAC format is not compatible.
 - Make sure the MP3/WMA/AAC has been written in a supported format. Refer to "About MP3/WMA/AAC" (pages 10-11), then rewrite in the format supported by this device.

Audio

The sound is not output from the speakers.

- Unit has no output signal of the internal amplifier.
 - POWER IC is switched to "POW ON" (page 17).

iPod

iPod does not play and no sound is output.

- The iPod has not been recognised.
 - Reset this unit and the iPod. Refer to "Initial System Start-Up" (page 6). To reset the iPod, refer to the Owner's Manual of the iPod.

Indication for CD Player

NO DISC

- No CD is inserted.
 - Insert a CD.
- Although a disc is inserted, "NO DISC" is displayed and the unit does not start to play or eject the disc.
 - Remove the disc by following these steps:
 - Press the **▲** button again for at least 2 seconds.
 - If the disc still does not eject, consult your Alpine dealer.

ERROR

- Mechanism error.
 - 1) Press the **▲** button and eject the CD.
 - If not ejecting, consult your Alpine dealer.
 - 2) When the error indication remains after ejecting, press the **▲** button again.
 - If the error indication still does not turn off after pressing the **▲** button for a few times, consult your Alpine dealer.
- *When "ERROR" is displayed:
If the disc cannot be ejected by pressing **▲**, press the RESET switch (refer to page 6) and press **▲** again.
If the disc still cannot be ejected, consult your Alpine dealer.*

PROTECT

- A copy-protected WMA file was played back.
 - You can only play back non-copy-protected files.

UNSUPPORTED

- A sampling rate/bit rate not supported by the unit is used.
 - Use a sampling rate/bit rate that is supported by the unit.

Indication for USB memory

ERROR

- Abnormal current is run to the USB connector device (an error message may be displayed if the USB device that is not compatible with the unit is connected).
USB memory is a malfunction or it is shorted.
 - Connect another USB memory.

UNIT ERROR

- A USB device that is not supported by the unit is connected.
 - Connect a USB device that is supported by the unit.

NO DEVICE

- A USB memory is not connected.
 - Make sure the USB memory device is correctly connected and the cable is not excessively bent.

NO FILE

- No song (file) is stored in the USB memory.
 - Connect the USB memory device after storing songs (files).

UNSUPPORTED

- A sampling rate/bit rate not supported by the unit is used.
 - Use a sampling rate/bit rate that is supported by the unit.

PROTECT

- A copy-protected WMA file was played back.
 - You can only play back non-copy-protected files.

NO SUPPORT

- Text information that is not recognizable by the unit has been input.
 - Use a USB memory device with input text information that is supported by the unit.

Indication for iPod Mode

NO IPOD

- The iPhone/iPod is not connected.
 - Make sure the iPhone/iPod is correctly connected (refer to “Connections”).
 - Make sure the cable is not bent excessively.
-

NO SONG

- There are no songs in the iPhone/iPod.
 - Download songs to the iPhone/iPod and connect to this unit.
-

ERROR-01

- Communication error.
 - Turn the ignition key off, and then set to ON again.
 - Reset the iPod.
 - Check the display by reconnecting between the iPhone/iPod and this unit, using the iPhone/iPod cable.
-

ERROR-02

- Caused by the iPhone/iPod Software Version not being compatible with this unit.
 - Update the iPhone/iPod Software Version to be compatible with this unit.
-

ERROR-03

- The iPhone/iPod is not verified.
 - Reset the iPod.
 - Try another iPhone/iPod, if available.
-

ERROR-04

- Power surge error.
 - Excessive voltage/current is supplied to the iPhone/iPod.
 - Try another iPhone/iPod, if available.
-

Bluetooth mode

NO UNIT

- The Bluetooth device is not connected.
 - Connect the Bluetooth device.
-

Indication for all Modes

DC ERROR

- Malfunction occurred as a result of the speaker cable shorting on the car chassis.
 - Route the cable correctly, and set POWER IC to POW ON (page 17).
 - If the above solution does not work, consult your nearest dealer.
-

Specifications

FM TUNER SECTION

Tuning Range	87.5-108.0 MHz
Mono Usable Sensitivity	9.3 dBf (0.8 μ V/75 ohms)
50 dB Quieting Sensitivity	13.5 dBf (1.3 μ V/75 ohms)
Alternate Channel Selectivity	80 dB
Signal-to-Noise Ratio	65 dB
Stereo Separation	35 dB
Capture Ratio	2.0 dB

AM TUNER SECTION

Tuning Range	531-1,602 kHz
Sensitivity (IEC Standard)	22.5 μ V/27 dB

CD PLAYER SECTION

Frequency Response	5-20,000 Hz (\pm 1 dB)
Wow & Flutter (% WRMS)	Below measurable limits
Total Harmonic Distortion	0.008% (at 1 kHz)
Dynamic Range	95 dB (at 1 kHz)
Signal-to-Noise Ratio	105 dB
Channel Separation	85 dB (at 1 kHz)

PICKUP

Wave length	795 nm
Laser power	CLASS I

USB SECTION

USB requirements	USB 1.1/2.0
Max. Power Consumption	500 mA
USB Class	Mass Storage
File System	FAT 12/16/32
MP3 Decoding	MPEG-1/2 AUDIO Layer-3
WMA Decoding	Windows Media™ Audio
AAC Decoding	AAC-LC format “.m4a” file
Number of Channels	2-Channel (Stereo)
Frequency Response*	5-20,000 Hz (\pm 1 dB)
Total Harmonic Distortion	0.008% (at 1 kHz)
Dynamic Range	95 dB (at 1 kHz)
Signal-to-Noise Ratio	105 dB
Channel Separation	85 dB (at 1 kHz)

* Frequency response may differ depending on the encoder software/bit rate.

BLUETOOTH SECTION (CDE-103EBT Only)

Bluetooth Specification	Bluetooth V 2.0
Output Power	+4 dBm Max. (Power class 2)
HFP	(Hands-Free Profile)
HSP	(Head Set Profile)

GENERAL

Power Requirement	14.4 V DC (11-16 V allowable)
Maximum Power Output	50 W \times 4
Maximum Pre-Output Voltage	2 V/10 k ohms
Bass	\pm 14 dB at 100 Hz
Treble	\pm 14 dB at 10 kHz
Weight	1.5 kg (3 lbs. 4 oz)

CHASSIS SIZE

Width	178 mm (7")
Height	50 mm (2")
Depth	161 mm (6-3/8")

NOSEPIECE SIZE

Width	170 mm (6-3/4")
Height	46 mm (1-13/16")
Depth	25 mm (1")

- Due to continuous product improvement, specifications and design are subject to change without notice.

Installation and Connections

Before installing or connecting the unit, please read the following and pages 3 to 5 of this manual thoroughly for proper use.

Warning

MAKE THE CORRECT CONNECTIONS.

Failure to make the proper connections may result in fire or product damage.

USE ONLY IN CARS WITH A 12 VOLT NEGATIVE GROUND.

(Check with your dealer if you are not sure.) Failure to do so may result in fire, etc.

BEFORE WIRING, DISCONNECT THE CABLE FROM THE NEGATIVE BATTERY TERMINAL.

Failure to do so may result in electric shock or injury due to electrical shorts.

DO NOT ALLOW CABLES TO BECOME ENTANGLED IN SURROUNDING OBJECTS.

Arrange wiring and cables in compliance with the manual to prevent obstructions when driving. Cables or wiring that obstruct or hang up on places such as the steering wheel, shift lever, brake pedals, etc. can be extremely hazardous.

DO NOT SPLICE INTO ELECTRICAL CABLES.

Never cut away cable insulation to supply power to other equipment. Doing so will exceed the current carrying capacity of the wire and result in fire or electric shock.

DO NOT DAMAGE PIPE OR WIRING WHEN DRILLING HOLES.

When drilling holes in the chassis for installation, take precautions so as not to contact, damage or obstruct pipes, fuel lines, tanks or electrical wiring. Failure to take such precautions may result in fire.

DO NOT USE BOLTS OR NUTS IN THE BRAKE OR STEERING SYSTEMS TO MAKE GROUND CONNECTIONS.

Bolts or nuts used for the brake or steering systems (or any other safety-related system), or tanks should NEVER be used for installations or ground connections. Using such parts could disable control of the vehicle and cause fire etc.

KEEP SMALL OBJECTS SUCH AS BATTERIES OUT OF THE REACH OF CHILDREN.

Swallowing them may result in serious injury. If swallowed, consult a physician immediately.

DO NOT INSTALL IN LOCATIONS WHICH MIGHT HINDER VEHICLE OPERATION, SUCH AS THE STEERING WHEEL OR SHIFT LEVER.

Doing so may obstruct forward vision or hamper movement etc. and results in serious accident.

Caution

HAVE THE WIRING AND INSTALLATION DONE BY EXPERTS.

The wiring and installation of this unit requires special technical skill and experience. To ensure safety, always contact the dealer where you purchased this product to have the work done.

USE SPECIFIED ACCESSORY PARTS AND INSTALL THEM SECURELY.

Be sure to use only the specified accessory parts. Use of other than designated parts may damage this unit internally or may not securely install the unit in place. This may cause parts to become loose resulting in hazards or product failure.

ARRANGE THE WIRING SO IT IS NOT CRIMPED OR PINCHED BY A SHARP METAL EDGE.

Route the cables and wiring away from moving parts (like the seat rails) or sharp or pointed edges. This will prevent crimping and damage to the wiring. If wiring passes through a hole in metal, use a rubber grommet to prevent the wire's insulation from being cut by the metal edge of the hole.

DO NOT INSTALL IN LOCATIONS WITH HIGH MOISTURE OR DUST.

Avoid installing the unit in locations with high incidence of moisture or dust. Moisture or dust that penetrates into this unit may result in product failure.

Precautions

- Be sure to disconnect the cable from the (-) battery post before installing your CDE-103EBT/CDE-102E/CDE-101E/CDE-101EM. This will reduce any chance of damage to the unit in case of a short-circuit.
- Be sure to connect the colour coded leads according to the diagram. Incorrect connections may cause the unit to malfunction or damage to the vehicle's electrical system.
- When making connections to the vehicle's electrical system, be aware of the factory installed components (e.g. on-board computer). Do not tap into these leads to provide power for this unit. When connecting the CDE-103EBT/CDE-102E/CDE-101E/CDE-101EM to the fuse box, make sure the fuse for the intended circuit of the CDE-103EBT/CDE-102E/CDE-101E/CDE-101EM has the appropriate amperage. Failure to do so may result in damage to the unit and/or the vehicle. When in doubt, consult your Alpine dealer.
- The CDE-103EBT/CDE-102E/CDE-101E/CDE-101EM uses female RCA-type jacks for connection to other units (e.g. amplifier) having RCA connectors. You may need an adaptor to connect other units. If so, please contact your authorized Alpine dealer for assistance.
- Be sure to connect the speaker (-) leads to the speaker (-) terminal. Never connect left and right channel speaker cables to each other or to the vehicle body.

IMPORTANT

Please record the serial number of your unit in the space provided below and keep it as a permanent record. The serial number or the engraved serial number is located on the bottom of the unit.

SERIAL NUMBER: _____
INSTALLATION DATE: _____
INSTALLATION TECHNICIAN: _____
PLACE OF PURCHASE: _____

Installation

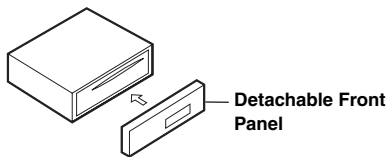

Caution

When you install this unit in your car, do not remove the detachable front panel. If the detachable front panel is removed during installation, you might press too hard and warp the metal plate that holds it in place.

- The main unit must be mounted within 35 degrees of the horizontal plane, back to front.

Less than 35°

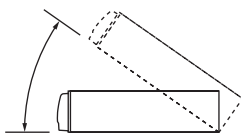

1

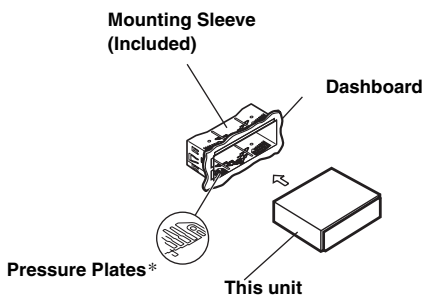

* If the installed mounting sleeve is loose in the dashboard, the pressure plates may be bent slightly to remedy the problem.

Remove the mounting sleeve from the main unit (see "Removal" on page 31).

2

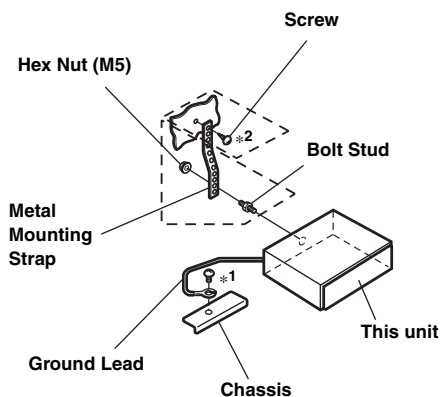

Reinforce the head unit with the metal mounting strap (not supplied). Secure the ground lead of the unit to a clean metal spot using a screw (*1) already attached to the vehicle's chassis.

- For the screw marked "*2", use an appropriate screw for the chosen mounting location.

Connect each input lead coming from an amplifier to the corresponding output lead coming from the left rear of the CDE-103EBT/CDE-102E/CDE-101E/CDE-101EM. Connect all other leads of the CDE-103EBT/CDE-102E/CDE-101E/CDE-101EM according to details described in the CONNECTIONS section.

3

Slide the CDE-103EBT/CDE-102E/CDE-101E/CDE-101EM into the dashboard until it clicks. This ensures that the unit is properly locked and will not accidentally come out from the dashboard. Install the detachable front panel.

Removal

- Remove the detachable front panel.
- Insert the bracket keys into the unit, along the guides on either side. The unit can now be removed from the mounting sleeve.

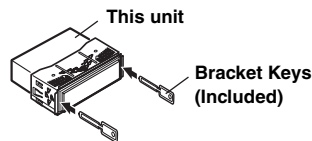

- Pull the unit out, keeping it unlocked as you do so.

<JAPANESE CAR>

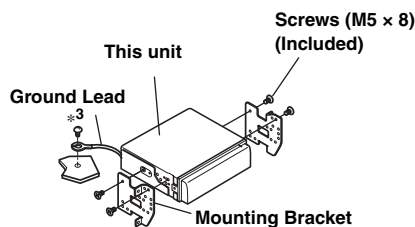
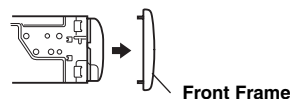

Secure the ground lead of the unit to a clean metal spot using a screw (*3) already attached to the vehicle's chassis.

Mounting the Microphone (CDE-103EBT only)

For the sake of safety, mount the microphone in the following location.

- In a stable and secure location.
- In a location that does not inhibit safely driving the vehicle.
- Mount the microphone in a location where the driver's voice can easily be picked up.

Choose a location for the microphone that can easily pick up the driver's voice. Requiring the driver to move towards the microphone for audibility causes a distraction that could be dangerous.

Connections

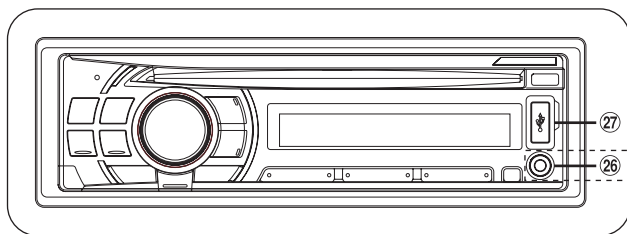
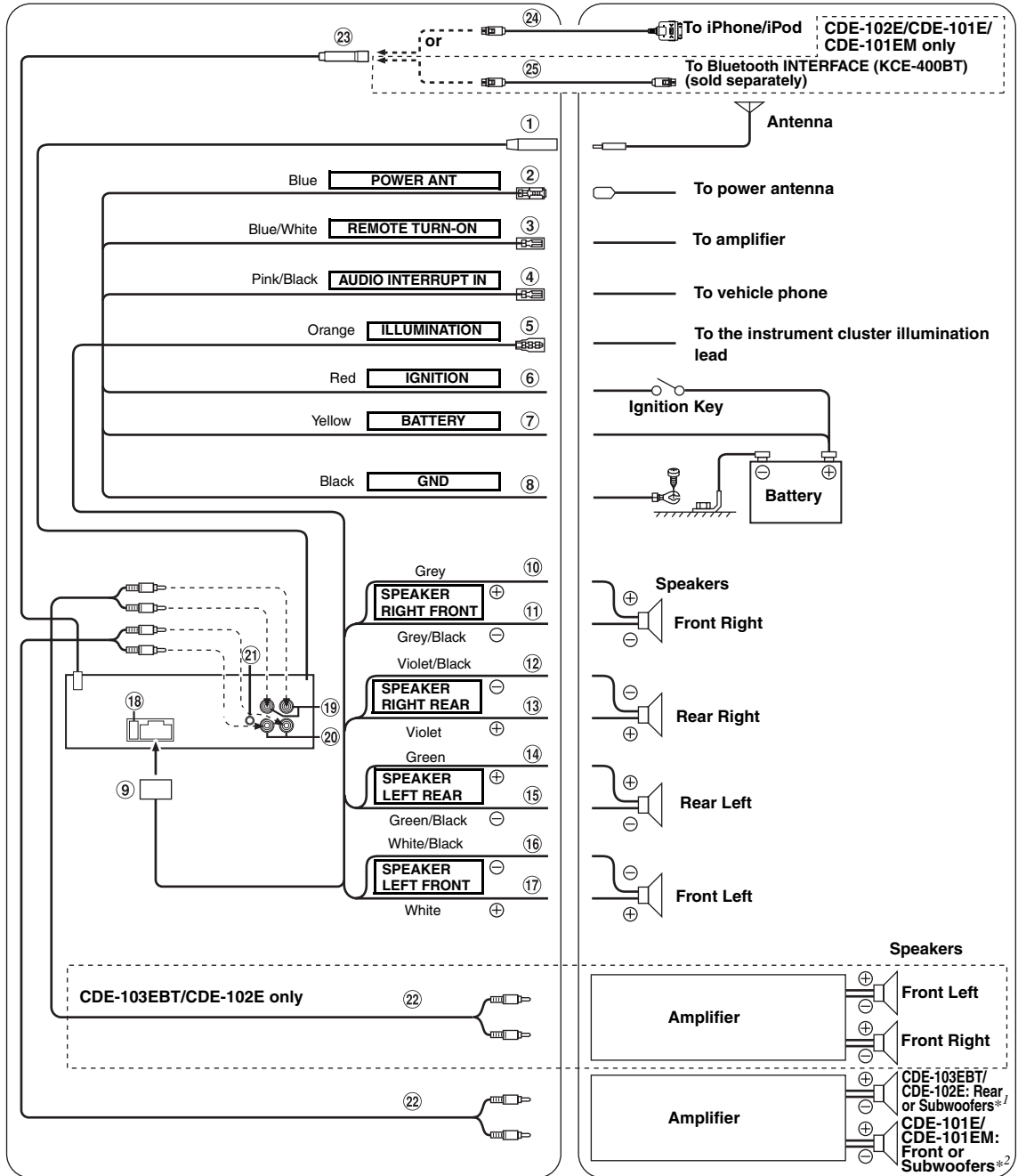

*¹ When Subwoofer is OFF: Output is for Rear speakers. When Subwoofer is ON: Output is for Subwoofer.
 *² When Subwoofer is OFF: Output is for Front speakers. When Subwoofer is ON: Output is for Subwoofer.
 For details on how to set the Subwoofer to ON/OFF, see "Subwoofer On and Off" on page 16.

- ① **Antenna Receptacle**
- ② **Power Antenna Lead (Blue)**
Connect this lead to the +B terminal of your power antenna, if applicable.
 - *This lead should be used only for controlling the vehicle's power antenna. Do not use this lead to turn on an amplifier or a signal processor, etc.*
- ③ **Remote Turn-On Lead (Blue/White)**
Connect this lead to the remote turn-on lead of your amplifier or signal processor.
- ④ **Audio Interrupt In Lead (Pink/Black)**
Connect this lead to the Audio interface output of a cellular phone which provides ground shorting when a call is received.
- ⑤ **Illumination Lead (Orange)**
This lead may be connected to the vehicle's instrument cluster illumination lead. This will allow the backlighting of this unit to dim whenever the vehicle's lights are turned on.
- ⑥ **Switched Power Lead (Ignition) (Red)**
Connect this lead to an open terminal on the vehicle's fuse box or another unused power source which provides (+)12V only when the ignition is turned on or in the accessory position.
- ⑦ **Battery Lead (Yellow)**
Connect this lead to the positive (+) post of the vehicle's battery.
- ⑧ **Ground Lead (Black)**
Connect this lead to a good chassis ground on the vehicle. Make sure the connection is made to bare metal and is securely fastened using the sheet metal screw provided.
- ⑨ **Power Supply Connector**
- ⑩ **Right Front (+) Speaker Output Lead (Grey)**
- ⑪ **Right Front (-) Speaker Output Lead (Grey/Black)**
- ⑫ **Right Rear (-) Speaker Output Lead (Violet/Black)**
- ⑬ **Right Rear (+) Speaker Output Lead (Violet)**
- ⑭ **Left Rear (+) Speaker Output Lead (Green)**
- ⑮ **Left Rear (-) Speaker Output Lead (Green/Black)**
- ⑯ **Left Front (-) Speaker Output Lead (White/Black)**
- ⑰ **Left Front (+) Speaker Output Lead (White)**
- ⑱ **Fuse Holder (10A)**
- ⑲ **Front Output RCA Connectors (CDE-103EBT/CDE-102E only)**
RED is right and WHITE is left.
- ⑳ **Rear/Subwoofer Output RCA Connectors (CDE-103EBT/CDE-102E only)**
Front/Subwoofer Output RCA Connectors (CDE-101E/CDE-101EM only)
RED is right and WHITE is left.
- ㉑ **MIC Input Connector (CDE-103EBT only)**
To Microphone.
- ㉒ **RCA Extension Cable (sold separately)**
- ㉓ **Full Speed Connector**
Control iPhone/iPod signals.
Connect this to an iPhone/iPod by using FULL SPEED™ Connection Cable (KCE-433iV) (sold separately) or to an external device (such as a portable player) by using conversion cable (KCE-237B) for building up the AUX IN (sold separately).
 - *Refer to "Setting the AUX+ SETUP Mode" (page 17).*
 - AUX+ ON : When the external device is connected.
 - AUX+ OFF : When an iPhone/iPod is connected.
 You can also connect this to an optional Bluetooth INTERFACE (KCE-400BT) (CDE-102E/CDE-101E/CDE-101EM only). To use a hands-free mobile phone, an optional Bluetooth INTERFACE (KCE-400BT) connection is required. For details on connection, refer to the Owner's Manual of the Bluetooth INTERFACE (KCE-400BT).
- ㉔ **FULL SPEED™ Connection Cable (KCE-433iV) (sold separately)**
- ㉕ **KCE-400BT Connection Cable (Included with KCE-400BT)**
- ㉖ **Front AUX Input Terminal (CDE-103EBT/CDE-102E only)**
This terminal allows for input of audio from an external device (such as a portable player), using a commercially-available converter cable.
- ㉗ **USB Connection Terminal**
Connect USB memory (sold separately)

To prevent external noise from entering the audio system.

- Locate the unit and route the leads at least 10 cm away from the car harness.
- Keep the battery power leads as far away from other leads as possible.
- Connect the ground lead securely to a bare metal spot (remove any paint, dirt or grease if necessary) of the car chassis.
- If you add an optional noise suppressor, connect it as far away from the unit as possible. Your Alpine dealer carries various noise suppressors, contact them for further information.
- Your Alpine dealer knows best about noise prevention measures so consult your dealer for further information.

Free Manuals Download Website

<http://myh66.com>

<http://usermanuals.us>

<http://www.somanuals.com>

<http://www.4manuals.cc>

<http://www.manual-lib.com>

<http://www.404manual.com>

<http://www.luxmanual.com>

<http://aubethermostatmanual.com>

Golf course search by state

<http://golfingnear.com>

Email search by domain

<http://emailbydomain.com>

Auto manuals search

<http://auto.somanuals.com>

TV manuals search

<http://tv.somanuals.com>