



MP3 CD Receiver

CDE-130R / CDE-130RM / CDE-130RR

MP3



**USB
PLAYBACK**

- **OWNER'S MANUAL**
Please read before using this product.
- **BEDIENUNGSANLEITUNG**
Lesen Sie diese Bedienungsanleitung bitte vor Gebrauch des Gerätes.
- **MODE D'EMPLOI**
Veuillez lire avant d'utiliser cet appareil.
- **MANUAL DE OPERACIÓN**
Léalo antes de utilizar este equipo.
- **ISTRUZIONI PER L'USO**
Si prega di leggere prima di utilizzare il attrezzatura.
- **ANVÄNDARHANDLEDNING**
Innan du använder utrustningen bör du läsa igenom denna användarhandledning.
- **GEBRUIKERSHANDLEIDING**
Lees deze aanwijzingen aandachtig alvorens dit toestel te gebruiken.
- **РУКОВОДСТВО ПО ЭКСПЛУАТАЦИИ**
Прочтите настоящее руководство перед началом использования оборудования.
- **INSTRUKCJA OBSŁUGI**
Prosimy zapoznać się z tą instrukcją przed przystąpieniem do użytkowania urządzenia.
- **ΕΓΧΕΙΡΙΔΙΟ ΧΡΗΣΤΗ**
Παρακαλούμε διαβάστε το πριν χρησιμοποιήσετε τη συσκευή.

ALPINE ELECTRONICS GmbH
Wilhelm-Wagenfeld-Straße 1-3,
80807 München, Germany
Phone 089-32 42 640

ALPINE ELECTRONICS OF U.K., LTD.
ALPINE House
Fletchamstead Highway,
Coventry CV4 9TW, U.K.
Phone 0870-33 33 763

ALPINE ELECTRONICS FRANCE S.A.R.L.
(RCS PONTOISE B 338 101 280)
98, Rue de la Belle Etoile, Z.I. Paris Nord II,
B.P. 50016, 95945 Roissy Charles de Gaulle
Cedex, France
Phone 01-48638989

ALPINE ITALIA S.p.A.
Viale C. Colombo 8, 20090 Trezzano
Sul Naviglio (MI), Italy
Phone 02-484781

ALPINE ELECTRONICS DE ESPAÑA, S.A.
Portal de Gamarra 36, Pabellón, 32
01013 Vitoria (Alava)-APDO 133, Spain
Phone 945-283588

ALPINE ELECTRONICS (BENELUX) GmbH
Leuvensesteenweg 510-B6,
1930 Zaventem, Belgium
Phone 02-725 1315

Operating Instructions

WARNING

WARNING

This symbol means important instructions. Failure to heed them can result in serious injury or death.

DO NOT OPERATE ANY FUNCTION THAT TAKES YOUR ATTENTION AWAY FROM SAFELY DRIVING YOUR VEHICLE.

Any function that requires your prolonged attention should only be performed after coming to a complete stop. Always stop the vehicle in a safe location before performing these functions. Failure to do so may result in an accident.

KEEP THE VOLUME AT A LEVEL WHERE YOU CAN STILL HEAR OUTSIDE NOISES WHILE DRIVING.

Excessive volume levels that obscure sounds such as emergency vehicle sirens or road warning signals (train crossings, etc.) can be dangerous and may result in an accident. LISTENING AT LOUD VOLUME LEVELS IN A CAR MAY ALSO CAUSE HEARING DAMAGE.

MINIMIZE DISPLAY VIEWING WHILE DRIVING.

Viewing the display may distract the driver from looking ahead of the vehicle and cause an accident.

DO NOT DISASSEMBLE OR ALTER.

Doing so may result in an accident, fire or electric shock.

USE ONLY IN CARS WITH A 12 VOLT NEGATIVE GROUND.

(Check with your dealer if you are not sure.) Failure to do so may result in fire, etc.

KEEP SMALL OBJECTS SUCH AS BATTERIES OUT OF THE REACH OF CHILDREN.

Swallowing them may result in serious injury. If swallowed, consult a physician immediately.

USE THE CORRECT AMPERE RATING WHEN REPLACING FUSES.

Failure to do so may result in fire or electric shock.

DO NOT BLOCK VENTS OR RADIATOR PANELS.

Doing so may cause heat to build up inside and may result in fire.

USE THIS PRODUCT FOR MOBILE 12V APPLICATIONS.

Use for other than its designed application may result in fire, electric shock or other injury.

DO NOT PLACE HANDS, FINGERS OR FOREIGN OBJECTS IN INSERTION SLOTS OR GAPS.

Doing so may result in personal injury or damage to the product.

CAUTION

This symbol means important instructions. Failure to heed them can result in injury or material property damage.

HALT USE IMMEDIATELY IF A PROBLEM APPEARS.

Failure to do so may cause personal injury or damage to the product. Return it to your authorized Alpine dealer or the nearest Alpine Service Centre for repairing.

PRECAUTIONS

Product Cleaning

Use a soft dry cloth for periodic cleaning of the product. For more severe stains, please dampen the cloth with water only. Anything else has the chance of dissolving the paint or damaging the plastic.

Temperature

Be sure the temperature inside the vehicle is between +55°C (+131°F) and -10°C (+14°F) before turning your unit on.

Moisture Condensation

You may notice the CD playback sound wavering due to condensation. If this happens, remove the disc from the player and wait about an hour for the moisture to evaporate.

Damaged Disc

Do not attempt to play cracked, warped, or damaged discs. Playing a bad disc could severely damage the playback mechanism.

Maintenance

If you have problems, do not attempt to repair the unit yourself. Return it to your Alpine dealer or the nearest Alpine Service Station for servicing.

Never Attempt the Following

Do not grip or pull out the disc while it is being pulled back into the player by the automatic reloading mechanism.

Do not attempt to insert a disc into the unit when the unit power is off.

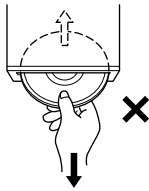

Inserting Discs

Your player accepts only one disc at a time for playback. Do not attempt to load more than one disc.

Make sure the label side is facing up when you insert the disc. Playing a disc while driving on a very bumpy road may result in skips, but this will not scratch the disc or damage the player.

New Discs

To prevent the CD from jamming, the LCD is displayed as error if discs with irregular surfaces are inserted or if discs are inserted incorrectly. When a new disc is ejected immediately after initial loading, use your finger to feel around the inside of the centre hole and outside edge of the disc. If you feel any small bumps or irregularities, this could inhibit proper loading of the disc. To remove the bumps, rub the inside edge of the hole and outside edge of the disc with a ballpoint pen or other such instrument, then insert the disc again.

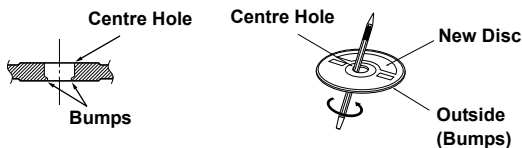

Irregular Shaped Discs

Be sure to use round shape discs only for this unit and never use any special shape discs.

Use of special shape discs may cause damage to the mechanism.



Installation Location

Make sure this unit will not be installed in a location subjected to:

- Direct sun and heat
- High humidity and water
- Excessive dust
- Excessive vibrations

Correct Handling

Do not drop the disc while handling. Hold the disc so you will not leave fingerprints on the surface. Do not affix tape, paper, or gummed labels to the disc. Do not write on the disc.

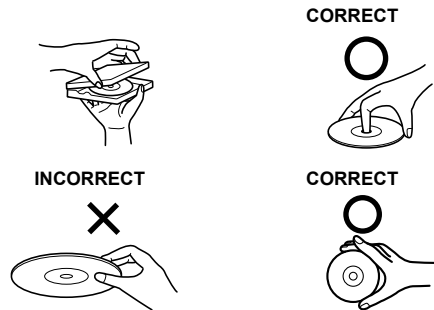

Disc Cleaning

Fingerprints, dust, or soil on the surface of the disc could cause the CD player to skip. For routine cleaning, wipe the playing surface with a clean, soft cloth from the centre of the disc to the outer edge. If the surface is heavily soiled, dampen a clean, soft cloth in a solution of mild neutral detergent before cleaning the disc.



Disc Accessories

There are various accessories available on the market for protecting the disc surface and improving sound quality. However, most of them will influence the thickness and/or diameter of the disc. Using such accessories can cause the disc to be out of standard specifications and may create operational problems. We recommend not using these accessories on discs played in Alpine CD players.

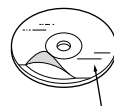

Transparent Sheet

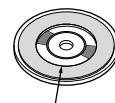

Disc Stabilizer

On handling Compact Discs (CD/CD-R/CD-RW)

- Do not touch the surface.
- Do not expose the disc to direct sunlight.
- Do not affix stickers or labels.
- Clean the disc when it is dusty.
- Make sure that there are no bumps around the disc.
- Do not use commercially available disc accessories.

Do not leave the disc in the car or the unit for a long time.

Never expose the disc to direct sunlight. Heat and humidity may damage the CD and you may not be able to play it again.

To customers using CD-R/CD-RW

- If a CD-R/CD-RW cannot be played back, make sure the last recording session was closed (finalized).
- Finalize the CD-R/CD-RW if necessary, and attempt playback again.

About media that can be played

Use only compact discs with the label side showing the CD logo marks below.



If you use unspecified compact discs, correct performance cannot be guaranteed.

You can play CD-Rs (CD-Recordables)/CD-RWs (CD-ReWritables) which have been recorded only on audio devices.

You can also play CD-Rs/CD-RWs containing MP3 formatted audio files.

- Some of the following CDs may not play on this unit:
Flawed CDs, CDs with fingerprints, CDs exposed to extreme temperatures or sunlight (e.g., left in the car or this unit), CDs recorded under unstable conditions, CDs on which a recording failed or a re-recording was attempted, copy-protected CDs which do not conform to the audio CD industry standard.
- Use discs with MP3 files written in a format compatible with this unit. For details, see "About MP3".
- ROM data other than audio files contained in a disc will not produce sound when played back.

Protecting the USB connection terminal

- Only a USB memory can be connected to the USB connection terminal on this unit. Correct performance using other USB products cannot be guaranteed. A USB hub is not supported.
- Do not connect a USB memory over 20 mm wide. Also, avoid connecting USB memory and Front Aux at the same time.
- Depending on the connected USB memory device, the unit may not function or some functions may not be performed.
- The audio file format that can be played back on the unit is MP3.
- Artist/song name, etc., can be displayed, however characters may not be correctly displayed.

CAUTION

Alpine accepts no responsibility for lost data, etc., even if data, etc. is lost while using this product.

On Handling USB Memory

- To prevent malfunction or damage, note the following points.
Read the USB memory Owner's Manual thoroughly.
Do not touch the terminals by hand or metal.
Do not subject USB memory to excessive shock.
Do not bend, drop, disassemble, modify or soak in the water.
 - Avoid usage or storage in the following locations:
Anywhere in the car exposed to direct sunlight or high temperatures.
Anywhere the possibility of high humidity or corrosive substances are present.
 - Fix the USB memory in a location where driver operation will not be hindered.
 - USB memory may not function correctly at high or low temperature
 - The USB flash memory supports a maximum of 4 GB per partition. The unit recognizes only one partition.
 - Use only certified USB memory. Note that even certified USB memory, may not function correctly depending on its type or state.
 - USB memory function is not guaranteed. Use USB memory according to the terms of agreement.
 - Depending on the settings of the USB memory type, memory state or encoding software, the unit may not play back or display properly.
 - A file that is copy-protected (copyright protection) cannot be played back.
 - USB memory may take time to start playback. If there is a particular file other than audio in the USB memory, it may take considerable time before the file is played back or searched.
 - The unit can play back "mp3" file extensions.
 - Do not add the above extensions to a file other than audio data. This non-audio data will not be recognised. The resulting playback may contain noise that can damage speakers and/or amplifiers.
 - It is recommended to back up important data on a personal computer.
 - Do not remove the USB device while playback is in progress. Change SOURCE to something other than USB, then remove the USB device to prevent possible damage to its memory.
-
- **"MPEG Layer-3 audio coding technology licensed from Fraunhofer IIS and Thomson."**
 - **"Supply of this product only conveys a license for private, non-commercial use and does not convey a license nor imply any right to use this product in any commercial (i.e. revenue-generation) real time broadcasting (terrestrial, satellite, cable and/or any other media), broadcasting/streaming via internet, intranets and/or other networks or in other electronic content distribution systems, such as pay-audio or audio-on-demand applications. An independent license for such use is required. For details, please visit <http://www.mp3licensing.com>"**

Getting Started

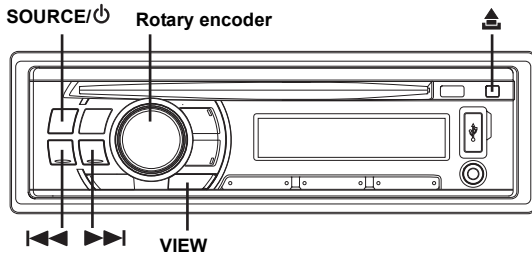

Accessory List

- Head unit1
- Power cable.....1
- Mounting sleeve.....1
- Carrying case.....1
- Bracket key.....2
- Rubber Cap.....1
- Bolt Stud1
- Owner's Manual 1 set

Turning Power On and Off

Press **SOURCE/⏻** to turn on the unit.

- *The first time power is turned on, the volume will start from level 18.*

Press and hold **SOURCE/⏻** for at least 2 seconds to turn off the unit.

Detaching and Attaching the Front Panel

Detaching

- 1 Turn off the unit power.
- 2 Press **▲ (Release)** at the upper right side until the front panel pops out.
- 3 Grasp the right side of the front panel and pull it out.

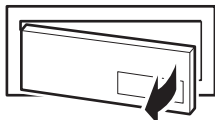

- *The front panel may become hot in normal usage (especially the connector terminals on the back of the front panel). This is not a malfunction.*
- *To protect the front panel, place it in the supplied carrying case.*
- *When detaching the front panel, do not apply excessive force as it may result in malfunction.*

Attaching

- 1 Insert the left side of the front panel into the main unit. Align the groove on the front panel with the projections on the main unit.
- 2 Push the right side of the front panel until it locks firmly into the main unit.

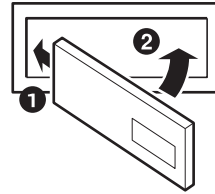

- *Before attaching the front panel, make sure that there is no dirt or dust on the connector terminals and no foreign object between the front panel and the main unit.*
- *Attach the front panel carefully, holding the sides of the front panel to avoid pushing buttons by mistake.*

Adjusting Volume

Turn the **Rotary encoder** until the desired sound is obtained.

Adjusting Volume : 0 ~ 40

Controllable with Remote Control

This unit can be controlled with an optional Alpine remote control. For details, consult your Alpine dealer. Point the optional remote control transmitter at the remote-control sensor.

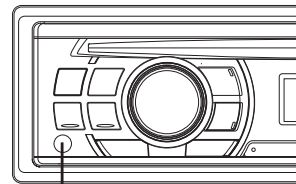

Remote control sensor

Radio

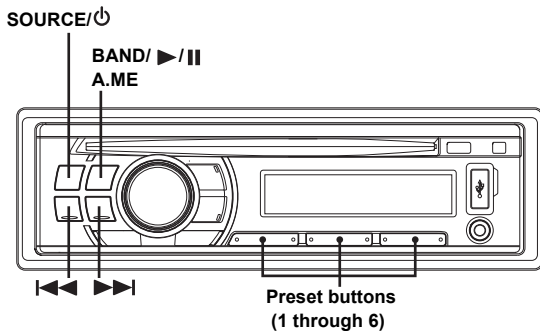

Listening to Radio

- 1 Press **SOURCE/⏻** to select RADIO mode.
- 2 Press **BAND/▶/||** repeatedly until the desired radio band is displayed.
FM1 → FM2 → FM3 → MW → LW → FM1
- 3 Press **◀◀** or **▶▶** to tune in the desired station.
Press and hold **◀◀** or **▶▶** for at least 0.5 seconds to seek station.

Presetting Stations Manually

- 1 Select the radio band and tune in a desired radio station you wish to store in the preset memory.
 - 2 Press and hold, for at least 2 seconds, any one of the **preset buttons (1 through 6)** into which you wish to store the station.
The selected station is stored.
The display shows the band, preset number and station frequency memorized.
- A total of 30 stations can be stored in the preset memory (6 stations for each band; FM1, FM2, FM3, MW and LW).
 - If you store a station in a preset memory which already has a station, the current station will be cleared and replaced with the new station.

Presetting Stations Automatically

- 1 Press **BAND/▶/||** repeatedly until the desired radio band is displayed.
 - 2 Press and hold **A.ME** for at least 2 seconds.
The frequency on the display continues to change while the automatic memory is in progress. The radio will automatically seek and store 6 strong stations in the selected band. They will be stored into preset buttons 1 to 6 in order of signal strength.
- If no stations are stored, the radio will return to the original station you were listening to before the auto memory procedure began.

Tuning to Preset Stations

- 1 Press **BAND/▶/||** repeatedly until the desired band is displayed.
- 2 Press any one of the station **preset buttons (1 through 6)** that has your desired radio station in memory.
The display shows the band, preset number and frequency of the station selected.

RDS

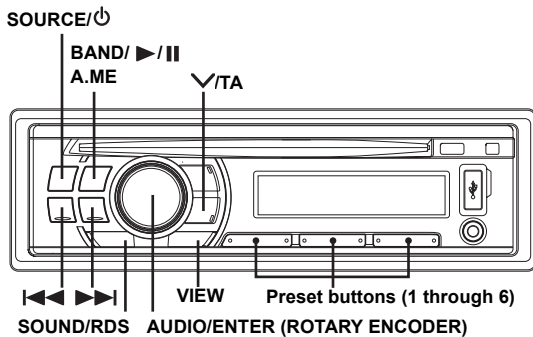

Setting RDS Reception Mode and Receiving RDS Stations

The RDS (Radio Data System) is a radio information system using the 57 kHz subcarrier of regular FM broadcast. The RDS allows you to receive a variety of information such as traffic information, station names, and to automatically re-tune to a stronger transmitter that is broadcasting the same programme.

The RDS digital data include the following:

| | |
|-----|---------------------------------|
| PI | Programme Identification |
| PS | Programme Service Name |
| AF | List of Alternative Frequencies |
| TP | Traffic Programme |
| TA | Traffic Announcement |
| EON | Enhanced Other Networks |

Recalling Preset RDS Stations

- Select the band, and then press any one of the station preset buttons (1 through 6) that has your desired radio station in memory.**
The display shows the band, preset number and frequency of the station selected.
- If the preset station's signal is weak:**
The unit automatically searches and tunes to a stronger station in the AF (Alternative Frequencies) list.
- If the preset station and the stations in the AF list cannot be received:**
When the PI SEEK setting is on (refer to "PI SEEK Setting" on page 6), the unit searches again for a station in the PI (Programme Identification) list.
If there are still no stations receivable in the area, the unit displays the frequency of the preset station and the preset number disappears.
If the signal level of the Regional (Local) station being tuned becomes too weak to receive, press the same preset button to tune in a Regional station in other district.

Note

- For presetting the RDS stations, refer to the Radio Operation section. The RDS stations can be preset in the FM1, FM2 and FM3 bands only.

AF (Alternative Frequencies) Setting

- Press and hold **SOUND/RDS** for at least 2 seconds to activate the SETUP mode.
- Turn the **Rotary encoder** to select the AF mode, and then press **Rotary encoder**.
- Turn the **Rotary encoder** to select ON or OFF.
- Press and hold **SOUND/RDS** for at least 2 seconds to return to normal mode.

Notes

- Press **VIEW** to return to normal mode.
- If no operation is performed for 60 seconds, the unit will return to normal mode automatically.

Receiving RDS Regional (Local) Stations

- Press and hold **SOUND/RDS** for at least 2 seconds to activate the SETUP mode.
- Turn the **Rotary encoder** to select the REGIONAL mode, and then press **Rotary encoder**.
- Turn the **Rotary encoder** to select ON or OFF. In the OFF mode, the unit automatically keeps receiving the related local RDS station.
- Press and hold **SOUND/RDS** for at least 2 seconds to return to normal mode.

Notes

- Press **VIEW** to return to normal mode.
- If no operation is performed for 60 seconds, the unit will return to normal mode automatically.

PI SEEK Setting

- Press and hold **SOUND/RDS** for at least 2 seconds to activate the SETUP mode.
- Turn the **Rotary encoder** to select the PI SEEK mode, and then press **Rotary encoder**.
- Turn the **Rotary encoder** to select ON or OFF.
- Press and hold **SOUND/RDS** for at least 2 seconds to return to normal mode.

Notes

- Press **VIEW** to return to normal mode.
- If no operation is performed for 60 seconds, the unit will return to normal mode automatically.

Receiving Traffic Information

1 Press and hold ∇ for at least 2 seconds so that the “TA” indicator lights up.

2 Press \lll or \ggg to select your desired traffic information station.

When a traffic information station is tuned in, the “TP” indicator lights up.

Traffic information is heard only when it is being broadcast. If traffic information is not being broadcast, the unit is set in the standby mode. When a traffic information broadcast begins, the unit automatically receives it and the display shows “TRF-INFO” for 5 seconds.

When the traffic information broadcast is over, the unit will automatically set in the standby mode.

Notes

- If you do not want to listen to the traffic information being received, lightly press **BAND/▶/|| IA.ME** to skip that traffic information message. The TA mode will remain in the ON position to receive the next traffic information message.
- If the volume level is changed while receiving traffic information, the changed volume level will be memorized. When traffic information is received next time, the volume level will be automatically adjusted to the level memorized.
- In the TA mode, the SEEK tuning selects only the TP stations.

Receiving Traffic Information While Playing CD or Radio

1 Press and hold ∇ for at least 2 seconds so that the “TA” indicator lights up.

2 Press \lll or \ggg to select a traffic information station if necessary.

When a traffic information broadcast starts, the unit automatically mutes the CD player or the regular FM broadcast.

When the traffic information broadcast finishes, the unit automatically returns to the original source play before the traffic information broadcast began.

When traffic information stations cannot be received:

In the CD mode:

When the TP signal can no longer be received, the traffic information station of another frequency will be selected automatically.

Note

- The receiver is equipped with the EON (Enhanced Other Networks) function in order to keep track of additional alternate frequencies to the AF list. The “EON” indicator lights up while an RDS EON station is being received. If the station being received does not broadcast the traffic information, the receiver automatically tunes in the related station that broadcasts the traffic information when it occurs.

3 Press and hold ∇ for at least 2 seconds to deactivate the Traffic Information mode.

The “TA” indicator switches off.

Displaying Radio Text

Text messages from a radio station can be displayed.

1 Press VIEW while receiving FM in the radio mode to select the Radio Text display.

The display will change every time the button is pressed.

If there is PS (Programme Service Name):

PS (Programme Service Name)* → RADIO TEXT → PS (Programme Service Name)

* If VIEW is pressed and held for at least 2 seconds while displaying PS in the radio mode, frequency will be displayed for 5 seconds.

If there is no PS (Programme Service Name):

FREQUENCY → RADIO TEXT → FREQUENCY

The display shows “WAITING” for a few seconds, then starts showing the text message. If the text message is more than 8 characters, it will scroll.

Note

- If there is no receivable text message or the unit cannot receive a text message properly, the display shows “NO TEXT”.

CD/MP3

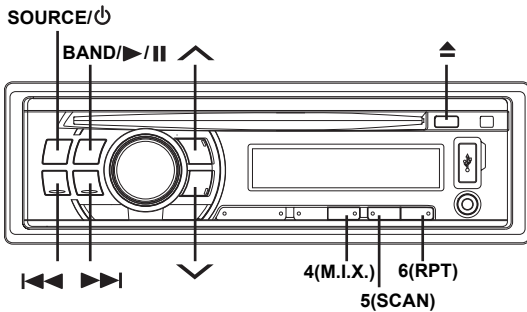

Playback

- 1 Insert a disc with the label side facing up.**
The disc will be pulled into the unit automatically, and the "DISC IN" indicator lights up.

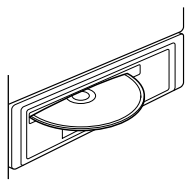

When a disc is already inserted, press **SOURCE/⏻** to switch to the DISC mode.

The mode will change every time the button is pressed.

RADIO → CD*¹ → USB*² → AUX → RADIO

*¹ Displayed only when a disc has been inserted.

*² Displayed only when USB memory is connected.

- 2 While playing back MP3, press ▲ or ▼ to select the desired folder.**

- 3 Press ⏪ or ⏩ to select the desired track (file).**

Returning to the beginning of the current track (file):
Press ⏪.

Fast backward:
Press and hold ⏪.

Advancing to the beginning of the next track (file):
Press ⏩.

Fast forward:
Press and hold ⏩.

- 4 To pause playback, press BAND/▶/||.**
Pressing **BAND/▶/||** again will resume playback.

- 5 To eject the disc, press ▲.**

- Do not remove a CD during its eject cycle. Do not load more than one disc at a time. A malfunction may result from doing either.
- The "DISC IN" indicator lights up when a disc is inserted.
- Three-inch (8 cm) CDs cannot be used.
- The CD-player can play disc containing audio data and MP3 data.
- The track display for MP3 data playback is the file numbers recorded on the disc.
- The playback time may not be correctly displayed when a VBR (Variable Bit Rate) recorded file is played back.

MP3 Play Display

The folder number and file number will be displayed as described below.

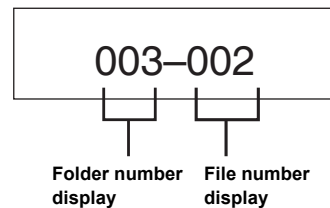

- Press **VIEW** to switch the display. See "Displaying the Text" for information about display switching.

Repeat Play

Press **6(RPT)** to repeatedly play back the current track. The "RPT" indicator lights up, and the track (file) will be played repeatedly.

Press 6(RPT) again to cancel.

Folder Repeat Play (MP3)

Press and hold **6(RPT)** for at least 2 seconds.

The "FOLDER" and "RPT" indicators appear in the display, and only files in the current folder are repeatedly played back.

Press and hold 6(RPT) again to cancel.

M.I.X. (Random Play)

Press 4(M.I.X.) in the play or pause mode.

The "∞ M.I.X." indicator lights up, and the tracks (files) on the disc will be played back in random sequence.

Press 4(M.I.X.) again to cancel.

Folder M.I.X. (Random Play) (MP3)

Press and hold 4(M.I.X.) for at least 2 seconds.

The "FOLDER" and "∞ M.I.X." indicators appear in the display, and all files in the current folder are played back in random sequence.

Press and hold 4(M.I.X.) again to cancel.

Scanning Programs

Press 5(SCAN) to activate the scan mode.

The first 10 seconds of each track (file) will be played back in succession.

Press 5(SCAN) again to cancel.

Folder Scanning Programs (MP3)

Press and hold 5(SCAN) for at least 2 seconds.

From the next folder, the first 10 seconds of the first file in each folder is played back in sequence.

Press and hold 5(SCAN) again to cancel.

About MP3

CAUTION

Except for private use, duplicating audio data (including MP3 data) or distributing, transferring, or copying it, whether for free or for a fee, without permission of the copyright holder is strictly prohibited by the Copyright Act and by international treaty.

What is MP3?

MP3, whose official name is "MPEG-1 Audio Layer 3," is a compression standard prescribed by the ISO, the International Standardization Organization and MPEG which is a joint activity institution of the IEC.

MP3 files contain compressed audio data. MP3 encoding is capable of compressing audio data at extremely high ratios, reducing the size of music files to as much as one-tenth their original size. This is achieved while still maintaining near CD quality. The MP3 format realises such high compression ratios by eliminating the sounds that are either inaudible to the human ear or masked by other sounds.

Method for creating MP3 files

Audio data are compressed using software with MP3 codec. For details on creating MP3 files, refer to the user's manual for that software.

MP3 files that are playable on this device have the file extension "mp3". Files with no extension cannot be played back.

Supported playback sampling rates and bit rates

MP3

Sampling rates: 48 kHz, 44.1 kHz, 32 kHz, 24 kHz, 22.05 kHz, 16 kHz, 12 kHz, 11.025 kHz, 8 kHz

Bit rates: 8 - 320 kbps

This device may not play back correctly depending on sampling rates.

ID3 tags

This device supports ID3 tag.

If tag data is in an MP3 file, this device can display the title (track title), artist name, and album name ID3 tag data.

This device can only display up to 64 characters. (Unicoded file and folder names are up to 32 characters.)

For non-supported characters and symbols an asterisk is displayed.

If information contains characters other than ID3 tag information, the audio file may not be played back.

The tag information may not be correctly displayed, depending on the contents.

Producing MP3 discs

MP3 files are prepared, then written to a CD-R or CD-RW using CD-R writing software. A disc can hold up to 512 files/folders (including Root Folders), and the maximum number of folders is 255.

Playback may not be performed if a disc exceeds the limitations described above.

Media supported

The media that this device can play back are CD-ROMs, CD-Rs, and CD-RWs.

Corresponding File Systems

This device supports discs formatted with ISO9660 Level 1 or Level 2.

Under the ISO9660 standard, there are some restrictions to remember.

The maximum nested folder depth is 8 (including the root directory). The number of characters for a folder/file name is limited.

Valid characters for folder/file names are letters A-Z, a-z, numbers 0-9 and symbols.

This device also can play back discs in Joliet, Romeo, etc., and other standards that conform to ISO9660. However, sometimes the file names, folder names, etc., are not displayed correctly.

Formats supported

This device supports Multi-Session.

This device cannot correctly play back discs recorded with Track At Once or packet writing.

Apple HFS, UDF 1.50, Mixed Mode CD and Enhanced CD (CD-Extra) are not supported.

Order of files

Files are played back in the order that the writing software writes them to the disc. Therefore, the playback order may not be what is expected. Verify the writing order in the software's documentation. The playback order of the folders and files is as follows.

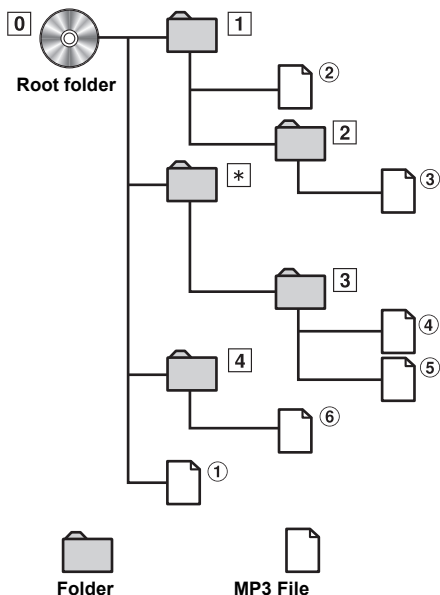

* The folder No./ folder Name will not be displayed if no file is contained in the folder.

Terminology

Bit rate

This is the "sound" compression rate specified for encoding. The higher the bit rate, the higher the sound quality, but also the larger the files.

Sampling rate

This value shows how many times per second the data is sampled (recorded). For example, music CDs use a sampling rate of 44.1 kHz, so the sound is sampled (recorded) 44,100 times per second. The higher the sampling rate, the higher the sound quality, but also the larger the volume of data.

Encoding

Converting music CDs, WAVE (AIFF) files, and other sound files into the specified audio compression format.

Tag

Song information such as track titles, artist names, album names, etc., written into MP3 files.

Root folder

The root folder (or root directory) is found at the top of the file system. The root folder contains all folders and files. It is created automatically for all burned discs.

Sound Setting

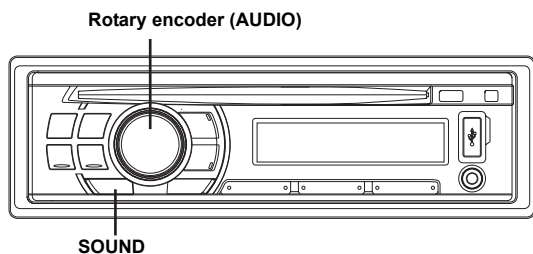

Equalizer Presets (Factory's EQ)

6 typical equalizer settings are preset at the factory for a variety of musical source material.

Press **SOUND** repeatedly until the desired Factory's EQ type is displayed.

With each press of the button, the equalizer mode will display the selected equalizer characteristic.

FLAT(OFF) → ROCK → POP → JAZZ → VOCAL → CLUB
→ FLAT(OFF)

Adjusting Bass Level/Treble Level/Balance (Between Left and Right)/Fader (Between Front and Rear)

1 Press **Rotary encoder (AUDIO)** repeatedly to choose the desired mode.

Each press changes the mode as follows:

BASS → TREBLE → BALANCE → FADER → Return to normal mode

Bass: -12 ~ +12dB

Treble: -12 ~ +12dB

Balance : L15 ~ R15

Fader : R15 ~ F15

- If no operation is performed for 5 seconds after selecting the BASS, TREBLE, BALANCE or FADER mode, the unit automatically returns to normal mode.

2 Turn the **Rotary encoder** until the desired sound is obtained in each mode.

Other Functions

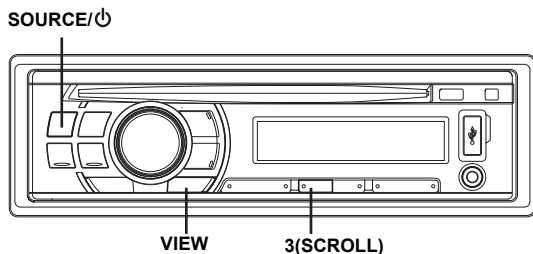

Displaying the Text

Text information, such as the disc name and the track name, will be displayed if playing a CD text compatible disc. It is also possible to display the folder name, the file name and the tag, etc., while playing MP3 files.

Press **VIEW**.

The display will change every time the button is pressed.

- To scroll text, press 3(SCROLL).

The display in Radio mode:

If there is PS (Programme Service Name)

PS (Programme Service Name)*¹ → RADIO TEXT → PS (Programme Service Name)

If there is no PS (Programme Service Name)

FREQUENCY → RADIO TEXT → FREQUENCY

The display in CD mode:

TRACK NO./ELAPSED TIME → TEXT (DISC NAME)*² → TEXT (TRACK NAME)*² → TRACK NO./ELAPSED TIME

The display in MP3 mode:

FOLDER NO./FILE NO. → ELAPSED TIME → FOLDER NAME → FILE NAME → ALBUM NAME*³ → SONG NAME*³/ARTIST NAME*³ → FOLDER NO./FILE NO.

*¹ If **VIEW** is pressed and held for at least 2 seconds in the PS display mode, frequency will be displayed for 5 seconds.

*² Displayed during playback of a disc with CD text.

*³ ID3 tag

If an MP3 file contains ID3 tag information, the ID3 tag information is displayed (e.g., song name, artist name, and album name). All other tag data is ignored.

About "Text"

Text:

Text compatible CDs contain text information such as the disc name and track name. Such text information is referred to as "text."

- Some characters may not be displayed correctly with this device, depending on the character type.
- "NO TEXT" is displayed if text information cannot be displayed on this unit.
- The text or tag information may not be correctly displayed, depending on the contents.

Using the Front AUX Input Terminal

Connect a portable music player, etc. by simply connecting it to the input on the front panel. An optional adapter cable is required (standard RCA to 3.5ø mini-phono plug or 3.5ø to 3.5ø mini phono plug).

Press **SOURCE/⏻**, and select the **AUX** mode to listen to the portable device.

RADIO → CD*¹ → USB*² → AUX → RADIO

*¹ Displayed only when a disc has been inserted.

*² Displayed only when USB memory is connected.

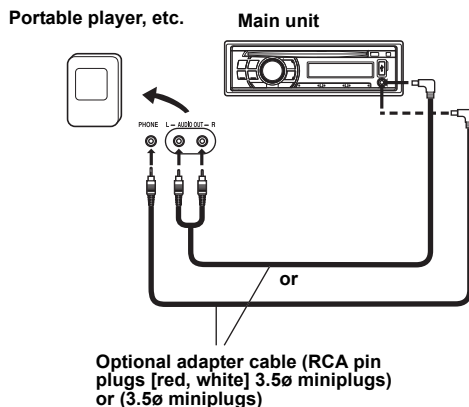

USB memory (Optional)

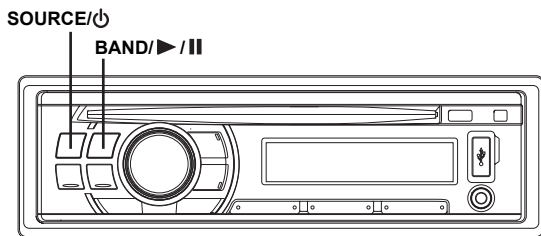

Controlling USB memory (Optional)

A USB memory device may be connected to this unit. With USB memory connected, playback of files on the device is controlled from this unit.

- The controls on this unit for USB memory operation are operative only when a USB memory is connected.

Playing MP3 Files with the USB memory (Optional)

If you connect a USB memory containing MP3, you can play these files on this unit.

- 1 Press **SOURCE/⏻** to switch to the **USB AUDIO mode**.

The mode will change every time the button is pressed.

RADIO → CD*¹ → USB*² → AUX → RADIO

*¹ Displayed only when a disc has been inserted.

*² Displayed only when USB memory is connected.

- 2 To pause playback, press **BAND/▶/||**.

Pressing **BAND/▶/||** again will resume the playback.

- The root folder is displayed as "ROOT" in the Folder Name Search mode.
- This unit plays back files on a USB memory device with the same controls and modes as playback of CDs containing MP3. For details, refer to "CD/MP3".
- Before disconnecting USB memory, be sure to change to another source or set to pause.
- The playback time may not be correctly displayed when a VBR (Variable Bit Rate) recorded file is played back.

USB Memory Connection (Optional)

Connect USB memory

- 1 Open the cover of the USB connection terminal.
- 2 Connect the USB memory directly to the USB connection terminal.

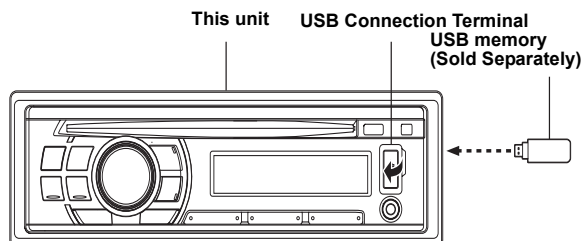

Remove USB memory

- 1 Carefully pull out the USB memory from the USB connection terminal.
 - 2 Close the cover of the USB connection terminal.
- Change to a source other than the USB memory mode, then remove the USB memory. If the USB memory is removed in the USB memory mode, data may be damaged.
 - When removing USB memory, pull it out straight.
 - If sound is not output or USB memory is not recognised even when USB memory is connected, remove USB memory once, then connect it again.
 - After removing the USB memory, close the cover of the USB connection terminal to prevent dust or foreign objects from entering and causing a malfunction.

About MP3 File of USB Memory

Playing back MP3

MP3 files are prepared, then stored to a USB memory. This unit can recognise at least 999 folders (including root folder) and 255 files per folder stored in USB memory. Playback may not be performed if a USB memory exceeds the limitations described above.

Do not make a file's playback time more than 1,000 minutes.

Media supported

This device can play back USB memory media.

Corresponding File Systems

This device supports FAT 12/16/32 for USB memory device.

Information

In Case of Difficulty

If you encounter a problem, please turn the power off, then on again. If the unit is still not functioning normally, please review the items in the following checklist. This guide will help you isolate the problem if the unit is at fault. Otherwise, make sure the rest of your system is properly connected or consult your authorized Alpine dealer.

Basic

No function or display.

- Vehicle's ignition is off.
 - If connected following instructions, the unit will not operate with the vehicle's ignition off.
- Improper power lead (Red) and battery lead (Yellow) connections.
 - Check power lead and battery lead connections.
- Blown fuse.
 - Check the fuse of the unit; replace with the proper value if necessary.

Radio

Unable to receive stations.

- No antenna or open connection in cable.
 - Make sure the antenna is properly connected; replace the antenna or cable if necessary.

Unable to tune stations in the seek mode.

- If the area you are in is a primary signal area, the antenna may not be grounded and connected properly.
 - Check your antenna connections; make sure the antenna is properly grounded at its mounting location.
- The antenna may not be the proper length.
 - Make sure the antenna is fully extended; if broken, replace the antenna with a new one.

Broadcast is noisy.

- The antenna is not the proper length.
 - Extend the antenna fully; replace it if it is broken.
- The antenna is poorly grounded.
 - Make sure the antenna is grounded properly at its mounting location.

CD

CD Player not functioning.

- Out of operating temperature range +70°C (+158°F) for CD.
 - Allow the vehicle's interior (or trunk) temperature to cool.

CD playback sound is wavering.

- Moisture condensation in the CD Module.
 - Allow enough time for the condensation to evaporate (about 1 hour).

CD insertion not possible.

- A CD is already in the CD player.
 - Eject the CD and remove it.
- The CD is being improperly inserted.
 - Make sure the CD is being inserted following instructions in the CD Player Operation section.

Unable to fast forward or backward the CD.

- The CD has been damaged.
 - Eject the CD and discard it; using a damaged CD in your unit can cause damage to the mechanism.

CD playback sound skips due to vibration.

- Improper mounting of the unit.
 - Securely re-mount the unit.
- The disc is very dirty.
 - Clean the disc.
- The disc has scratches.
 - Change the disc.
- The pick-up lens is dirty.
 - Do not use a commercially available lens cleaner disc. Consult your nearest Alpine dealer.

CD playback sound skips without vibration.

- The disc is dirty or scratched.
 - Clean the disc; damaged disc should be replaced.

Error displays (built-in CD player only).

- Mechanical error.
 - Press ▲. After the error indication disappears, insert the disc again. If the above-mentioned solution does not solve the problem, consult your nearest Alpine dealer.

CD-R/CD-RW playback not possible.

- Close session (finalization) has not been performed.
 - Perform finalization and attempt playback again.

MP3

MP3 is not played back.

- Writing error occurred. The MP3 format is not compatible.
 - Make sure the MP3 has been written in a supported format. Refer to "About MP3", then rewrite in the format supported by this device.

Indication for CD Player

CD ERR1

- The disc is dirty or upside down.
 - Press the **▲** button and eject the CD.
If not ejecting, consult your Alpine dealer.
-

CD ERR2

- The disc has scratches.
 - Press the **▲** button and eject the CD.
If not ejecting, consult your Alpine dealer.
-

CD ERR3

- Mechanism error.
 - Consult your Alpine dealer.
-

CD ERR4

- A sampling rate/bit rate not supported by the unit is used.
 - Use a sampling rate/bit rate that is supported by the unit.
-

Indication for USB memory

USB ERR1

- No song (file) is stored in the USB memory.
 - Connect the USB memory device after storing songs (files).
 - A USB device that is not supported by the unit is connected.
 - Connect a USB device that is supported by the unit.
-

USB ERR2

- Abnormal current is run to the USB connector device (an error message may be displayed if the USB device that is not compatible with the unit is connected).
USB memory is a malfunction or it is shorted.
 - Disconnect the USB memory device and turn off the power and turn on Connect another USB memory.
-

USB ERR3

- Communication error.
 - Turn the ignition key off, and then set to ON again.
-

USB ERR4

- A sampling rate/bit rate not supported by the unit is used.
 - Use a sampling rate/bit rate that is supported by the unit.
-

Specifications

FM TUNER SECTION

| | |
|-------------------------------|----------------|
| Tuning Range | 87.5-108.0 MHz |
| Mono Usable Sensitivity | 0.7 μ V |
| Alternate Channel Selectivity | 80 dB |
| Signal-to-Noise Ratio | 65 dB |
| Stereo Separation | 35 dB |
| Capture Ratio | 2.0 dB |

MW TUNER SECTION

| | |
|----------------------------|--------------------|
| Tuning Range | 531-1,602 kHz |
| Sensitivity (IEC Standard) | 25.1 μ V/28 dB |

LW TUNER SECTION

| | |
|----------------------------|--------------------|
| Tuning Range | 153-281 kHz |
| Sensitivity (IEC Standard) | 31.6 μ V/30 dB |

CD PLAYER SECTION

| | |
|---------------------------|-------------------------------|
| Sampling Range | 8 times oversampling |
| DA Converter | 1 bit DAC System |
| Pick-up Type | 3-beam Photo Detector Pick Up |
| Light Source | Semiconductor laser |
| Wave length | 790 nm |
| Laser Power | CLASS I |
| Frequency Response | 20-20,000 Hz (\pm 1 dB) |
| Signal-to-Noise Ratio | 96 dB |
| Total Harmonic Distortion | 0.01% (at 1 kHz) |
| Wow & Flutter | Below measurable limits |
| Channel Separation | 85 dB |

USB SECTION

| | |
|------------------------------|--------------------|
| USB requirements | 1.1/2.0 Full Speed |
| Maximum Supply Compatibility | 500 mA |

Front AUX input

| | |
|--------------------------|-------------------------------|
| Input Impedance | 10 kohms |
| Allowable external input | 2.0 V |
| Connector | 3.5 mm ϕ Stereo mini-pin |

GENERAL

| | |
|--------------------------------------|---|
| Power Requirement | 12 V DC (11-16 V allowable), Test voltage 14.4 V, Negative ground |
| Current Consumption | Less than 2.1 A (CD mode; 0.5 W \times 4) |
| Maximum Power Output | 50 W \times 4 (at 1 kHz) volume control maximum |
| Power Output | 18 W \times 4 (1 kHz, 1 %, 4 ohms) |
| Speaker Impedance | 4-8 ohms |
| Pre-Output Voltage | 2 V (CD mode, 1 kHz, 0dB) |
| Pre-Output Impedance | 200 ohms |
| Dimensions (W \times H \times D) | 178 \times 50 \times 160 mm |
| Weight | 1.2 kg |

- *Due to continuous product improvement, specifications and design are subject to change without notice.*

Installation and Connections

Before installing or connecting the unit, please read the following and "Operating Instructions" of this manual thoroughly for proper use.

Warning

MAKE THE CORRECT CONNECTIONS.

Failure to make the proper connections may result in fire or product damage.

USE ONLY IN CARS WITH A 12 VOLT NEGATIVE GROUND.

(Check with your dealer if you are not sure.) Failure to do so may result in fire, etc.

BEFORE WIRING, DISCONNECT THE CABLE FROM THE NEGATIVE BATTERY TERMINAL.

Failure to do so may result in electric shock or injury due to electrical shorts.

DO NOT ALLOW CABLES TO BECOME ENTANGLED IN SURROUNDING OBJECTS.

Arrange wiring and cables in compliance with the manual to prevent obstructions when driving. Cables or wiring that obstruct or hang up on places such as the steering wheel, shift lever, brake pedals, etc. can be extremely hazardous.

DO NOT SPLICE INTO ELECTRICAL CABLES.

Never cut away cable insulation to supply power to other equipment. Doing so will exceed the current carrying capacity of the wire and result in fire or electric shock.

DO NOT DAMAGE PIPE OR WIRING WHEN DRILLING HOLES.

When drilling holes in the chassis for installation, take precautions so as not to contact, damage or obstruct pipes, fuel lines, tanks or electrical wiring. Failure to take such precautions may result in fire.

DO NOT USE BOLTS OR NUTS IN THE BRAKE OR STEERING SYSTEMS TO MAKE GROUND CONNECTIONS.

Bolts or nuts used for the brake or steering systems (or any other safety-related system), or tanks should NEVER be used for installations or ground connections. Using such parts could disable control of the vehicle and cause fire etc.

KEEP SMALL OBJECTS SUCH AS BATTERIES OUT OF THE REACH OF CHILDREN.

Swallowing them may result in serious injury. If swallowed, consult a physician immediately.

DO NOT INSTALL IN LOCATIONS WHICH MIGHT HINDER VEHICLE OPERATION, SUCH AS THE STEERING WHEEL OR SHIFT LEVER.

Doing so may obstruct forward vision or hamper movement etc. and results in serious accident.

Caution

HAVE THE WIRING AND INSTALLATION DONE BY EXPERTS.

The wiring and installation of this unit requires special technical skill and experience. To ensure safety, always contact the dealer where you purchased this product to have the work done.

USE SPECIFIED ACCESSORY PARTS AND INSTALL THEM SECURELY.

Be sure to use only the specified accessory parts. Use of other than designated parts may damage this unit internally or may not securely install the unit in place. This may cause parts to become loose resulting in hazards or product failure.

ARRANGE THE WIRING SO IT IS NOT CRIMPED OR PINCHED BY A SHARP METAL EDGE.

Route the cables and wiring away from moving parts (like the seat rails) or sharp or pointed edges. This will prevent crimping and damage to the wiring. If wiring passes through a hole in metal, use a rubber grommet to prevent the wire's insulation from being cut by the metal edge of the hole.

DO NOT INSTALL IN LOCATIONS WITH HIGH MOISTURE OR DUST.

Avoid installing the unit in locations with high incidence of moisture or dust. Moisture or dust that penetrates into this unit may result in product failure.

Precautions

- Be sure to disconnect the cable from the (-) battery post before installing your CDE-130R/CDE-130RM/CDE-130RR. This will reduce any chance of damage to the unit in case of a short-circuit.
- Be sure to connect the colour coded leads according to the diagram. Incorrect connections may cause the unit to malfunction or damage to the vehicle's electrical system.
- When making connections to the vehicle's electrical system, be aware of the factory installed components (e.g. on-board computer). Do not tap into these leads to provide power for this unit. When connecting the CDE-130R/CDE-130RM/CDE-130RR to the fuse box, make sure the fuse for the intended circuit of the CDE-130R/CDE-130RM/CDE-130RR has the appropriate amperage. Failure to do so may result in damage to the unit and/or the vehicle. When in doubt, consult your Alpine dealer.
- The CDE-130R/CDE-130RM/CDE-130RR uses female RCA-type jacks for connection to other units (e.g. amplifier) having RCA connectors. You may need an adaptor to connect other units. If so, please contact your authorized Alpine dealer for assistance.
- Be sure to connect the speaker (-) leads to the speaker (-) terminal. Never connect left and right channel speaker cables to each other or to the vehicle body.

IMPORTANT

Please record the serial number of your unit in the space provided below and keep it as a permanent record. The serial number or the engraved serial number is located on the top of the unit.

SERIAL NUMBER: _____
INSTALLATION DATE: _____
INSTALLATION TECHNICIAN: _____
PLACE OF PURCHASE: _____

Installation

Caution

Do not block the unit's heat sink, thus preventing air circulation. If blocked, heat will accumulate inside the unit and may cause a fire.

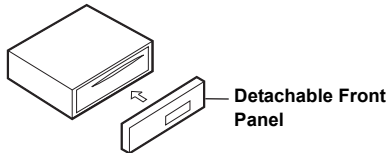
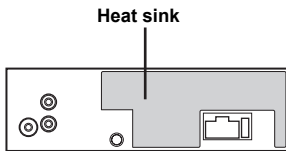

Caution

When you install this unit in your car, do not remove the detachable front panel. If the detachable front panel is removed during installation, you might press too hard and warp the metal plate that holds it in place.

- The main unit must be mounted within 30 degrees of the horizontal plane, back to front.

Less than 30°

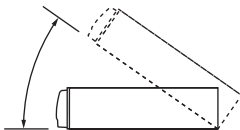

1

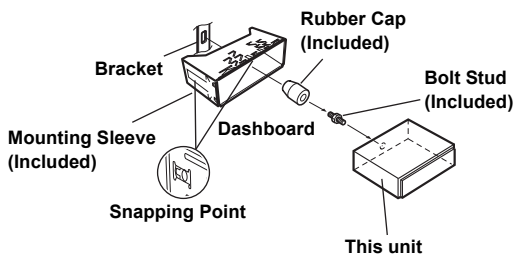

Remove the mounting sleeve from the main unit (see "Removal").

2

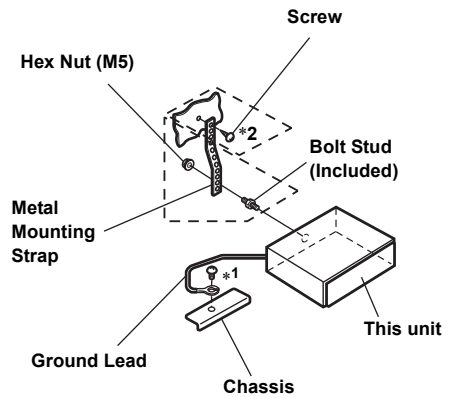

Reinforce the head unit with the metal mounting strap (not supplied). Secure the ground lead of the unit to a clean metal spot using a screw (*1) already attached to the vehicle's chassis.

- For the screw marked "*2", use an appropriate screw for the chosen mounting location.

Connect each input lead coming from an amplifier to the corresponding output lead coming from the left rear of the CDE-130R/CDE-130RM/CDE-130RR. Connect all other leads of the CDE-130R/CDE-130RM/CDE-130RR according to details described in the CONNECTIONS section.

3

Slide the CDE-130R/CDE-130RM/CDE-130RR into the dashboard until it clicks. This ensures that the unit is properly locked and will not accidentally come out from the dashboard. Install the detachable front panel.

Removal

- Remove the detachable front panel.
- Insert the bracket keys into the unit, along the guides on either side. The unit can now be removed from the mounting sleeve.

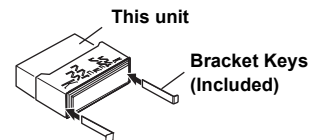

- Pull the unit out, keeping it unlocked as you do so.

<JAPANESE CAR>

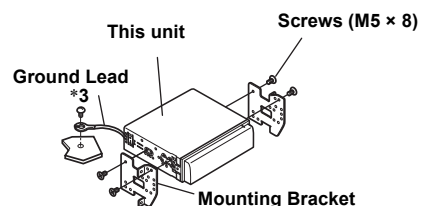
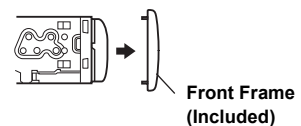

Secure the ground lead of the unit to a clean metal spot using a screw (*3) already attached to the vehicle's chassis.

Connections

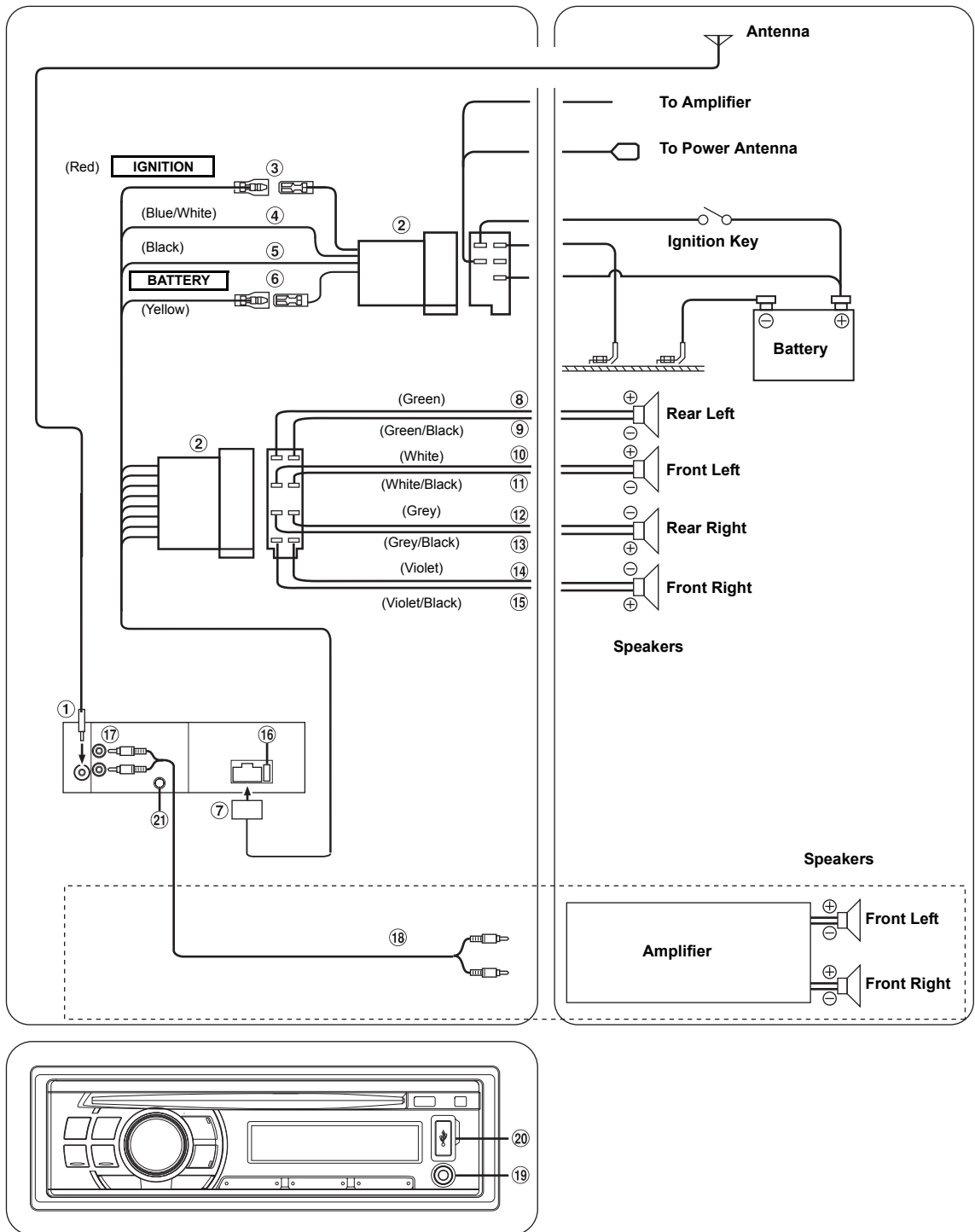

- ① **Antenna Receptacle**
- ② **ISO Connector**
- ③ **Switched Power Lead (Ignition) (Red)**
Connect this lead to an open terminal on the vehicle's fuse box or another unused power source which provides (+) 12V only when the ignition is turned on or in the accessory position.
- ④ **Power Antenna Lead (Blue/White)**
Connect this lead to the +B terminal of your power antenna, if applicable.
Note
• *This lead should be used only for controlling the vehicle's power antenna. Do not use this lead to turn on an amplifier or a signal processor, etc.*
- ⑤ **Ground Lead (Black)**
Connect this lead to a good chassis ground on the vehicle. Make sure the connection is made to bare metal and is securely fastened using the sheet metal screw provided.
- ⑥ **Battery Lead (Yellow)**
Connect this lead to the positive (+) post of the vehicle's battery.
- ⑦ **ISO Power Supply Connector**
- ⑧ **Rear Left (+) Speaker Output Lead (Green)**
- ⑨ **Rear Left (-) Speaker Output Lead (Green/Black)**
- ⑩ **Front Left (+) Speaker Output Lead (White)**
- ⑪ **Front Left (-) Speaker Output Lead (White/Black)**
- ⑫ **Rear Right (-) Speaker Output Lead (Grey)**
- ⑬ **Rear Right (+) Speaker Output Lead (Grey/Black)**
- ⑭ **Front Right (-) Speaker Output Lead (Violet)**
- ⑮ **Front Right (+) Speaker Output Lead (Violet/Black)**
- ⑯ **Fuse Holder (15A)**
- ⑰ **Front Output RCA Connectors**
RED is right and WHITE is left.
- ⑱ **RCA Extension Cable (sold separately)**
- ⑲ **Front AUX Input Terminal**
This terminal allows for input of audio from an external device (such as a portable player), using a commercially-available converter cable.
- ⑳ **USB Connection Terminal**
Connect USB memory (sold separately)
- ㉑ **Steering Remote Control Interface Connector**
To steering remote control interface box.
You can operate this unit from the vehicle's control unit when an Alpine Steering Remote Control Interface Box (optional) is connected. For details, contact your Alpine dealer.

To prevent external noise from entering the audio system.

- Locate the unit and route the leads at least 10 cm away from the car harness.
- Keep the battery power leads as far away from other leads as possible.
- Connect the ground lead securely to a bare metal spot (remove any paint, dirt or grease if necessary) of the car chassis.
- If you add an optional noise suppressor, connect it as far away from the unit as possible. Your Alpine dealer carries various noise suppressors, contact them for further information.
- Your Alpine dealer knows best about noise prevention measures so consult your dealer for further information.

Free Manuals Download Website

<http://myh66.com>

<http://usermanuals.us>

<http://www.somanuals.com>

<http://www.4manuals.cc>

<http://www.manual-lib.com>

<http://www.404manual.com>

<http://www.luxmanual.com>

<http://aubethermostatmanual.com>

Golf course search by state

<http://golfingnear.com>

Email search by domain

<http://emailbydomain.com>

Auto manuals search

<http://auto.somanuals.com>

TV manuals search

<http://tv.somanuals.com>