

FOR CAR USE ONLY/NUR FÜR AUTOMOBIL GEBRAUCH/POUR APPLICATION AUTOMOBILE UNIQUEMENT/PARA USO EN AUTOMÓVILES/SOLO PER L'UTILIZZO IN AUTOMOBILE/ENDAST FÖR BILBRUK/ALLEN VOOR GEBRUIK IN DE AUTO/ТОЛЬКО ДЛЯ ИСПОЛЬЗОВАНИЯ В АВТОМОБИЛЯХ/DO UŻYCIA TYLKO W SAMOCHODZIE/ΓΙΑ ΧΡΗΣΗ ΜΟΝΟ ΣΕ ΑΥΤΟΚΙΝΗΤΟ

# ALPINE®

## RDS MP3/WMA/AAC CD Receiver

# CDE-9880R/ CDE-9882Ri

**MP3**



**AAC**



**USB  
PLAYBACK**

- **OWNER'S MANUAL**  
Please read before using this equipment.
- **BEDIENUNGSANLEITUNG**  
Lesen Sie diese Bedienungsanleitung bitte vor Gebrauch des Gerätes.
- **MODE D'EMPLOI**  
Veuillez lire avant d'utiliser cet appareil.
- **MANUAL DE OPERACIÓN**  
Léalo antes de utilizar este equipo.
- **ISTRUZIONI PER L'USO**  
Si prega di leggere prima di utilizzare il attrezzatura.
- **ANVÄNDARHANDLEDNING**  
Innan du använder utrustningen bör du läsa igenom denna användarhandledning.
- **GEBRUIKERSHANDLEIDING**  
Lees deze aanwijzingen aandachtig alvorens dit toestel te gebruiken.
- **РУКОВОДСТВО ПО ЭКСПЛУАТАЦИИ**  
Прочтите настоящее руководство перед началом использования оборудования.
- **INSTRUKCJA OBSŁUGI**  
Prosimy zapoznać się z tą instrukcją przed przystąpieniem do użytkowania urządzenia.
- **ΕΓΧΕΙΡΙΔΙΟ ΧΡΗΣΤΗ**  
Παρακαλούμε διαβάστε το πριν χρησιμοποιήσετε τη συσκευή.

**ALPINE ELECTRONICS MARKETING, INC.**  
1-1-8 Nishi Gotanda,  
Shinagawa-ku,  
Tokyo 141-0031, Japan  
Phone 03-5496-8231

**ALPINE ELECTRONICS OF AMERICA, INC.**  
19145 Gramercy Place, Torrance,  
California 90501, U.S.A.  
Phone 1-800-ALPINE-1 (1-800-257-4631)

**ALPINE ELECTRONICS OF CANADA, INC.**  
777 Supertest Road, Toronto,  
Ontario M3J 2M9, Canada  
Phone 1-800-ALPINE-1 (1-800-257-4631)

**ALPINE ELECTRONICS OF AUSTRALIA PTY. LTD.**  
161-165 Princes Highway, Hallam  
Victoria 3803, Australia  
Phone 03-8787-1200

**ALPINE ELECTRONICS GmbH**  
Frankfurter Ring 117,  
80807 München, Germany  
Phone 089-32 42 640

**ALPINE ELECTRONICS OF U.K. LTD.**  
Alpine House  
Fletchamstead Highway, Coventry CV4 9TW, U.K.  
Phone 0870-33 33 763

**ALPINE ELECTRONICS FRANCE S.A.R.L.**  
(RCS PONTOISE B 338 101 280)  
98, Rue de la Belle Etoile, Z.I. Paris Nord II,  
B.P. 50016, 95945 Roissy Charles de Gaulle  
Cedex, France  
Phone 01-48638989

**ALPINE ITALIA S.p.A.**  
Viale C. Colombo 8, 20090 Trezzano  
Sul Naviglio (MI), Italy  
Phone 02-484781

**ALPINE ELECTRONICS DE ESPAÑA, S.A.**  
Portal de Gamarra 36, Pabellón, 32  
01013 Vitoria (Alava)-APDO 133, Spain  
Phone 945-283588

**ALPINE ELECTRONICS (BENELUX) GmbH**  
Leuvensesteenweg 510-B6,  
1930 Zaventem, Belgium  
Phone 02-725-13 15

EN

DE

FR

ES

IT

SE

NL

RU

PL

GR



# Contents

## Operating Instructions

### WARNING

<b>WARNING</b> .....	<b>3</b>
<b>CAUTION</b> .....	<b>3</b>
<b>PRECAUTIONS</b> .....	<b>3</b>

### Getting Started

Accessory List .....	6
Turning Power On and Off .....	6
Detaching and Attaching the Front Panel .....	6
Initial System Start-Up .....	7
Adjusting Volume .....	7
Lowering Volume Quickly .....	7

### Radio

Listening to Radio .....	8
Presetting Stations Manually .....	8
Presetting Stations Automatically .....	8
Tuning to Preset Stations .....	8
Frequency Search Function .....	8

### RDS

Setting RDS Reception Mode and Receiving RDS Stations .....	9
Recalling Preset RDS Stations .....	9
Receiving RDS Regional (Local) Stations .....	9
PI SEEK Setting .....	10
Setting PTY31 (Emergency Broadcast) reception .....	10
Receiving Traffic Information .....	10
PTY (Programme Type) Tuning .....	10
Receiving Traffic Information While Playing CD or Radio .....	10
Priority News .....	11
Displaying Radio Text .....	11

### CD/MP3/WMA/AAC

Playback .....	11
Repeat Play .....	12
M.I.X. (Random Play) .....	12
Searching for CD Text .....	12
File/Folder Name Search (concerning MP3/WMA/AAC) .....	13
Quick Search .....	13
About MP3/WMA/AAC .....	13

### Sound Setting

Adjusting Subwoofer Level/Bass Level/Treble Level/Balance (Between Left and Right)/Fader (Between Front and Rear)/Defeat .....	15
Setting the Subwoofer Level .....	15
Setting the Bass Control .....	15
Setting the Treble Control .....	16
Adjusting the High Pass Filter .....	16
Turning Subwoofer ON/OFF .....	16
Setting the Subwoofer System .....	16
Turning Loudness On/Off .....	16

### Other Functions

Displaying the Text .....	17
---------------------------	----

### SETUP

#### BLUETOOTH IN

Setting the Bluetooth Connection .....	18
--	----

#### Sound Customizing

Adjusting Source Signal Levels .....	18
--------------------------------------	----

#### Visual Customizing

Changing Lighting Colour .....	18
Adjusting Display Contrast .....	18
Dimmer Control .....	19
Scroll Type Setting .....	19
Scroll Setting (TEXT SCROLL) .....	19
Setting the Language Font .....	19
Demonstration .....	19

#### MP3/WMA/AAC

Playing MP3/WMA/AAC Data (PLAY MODE) .....	19
--	----

## External Device

Connecting to an External Amplifier .....	19
Turning Mute Mode On / Off (INT MUTE) ....	20
Setting the AUX+ SETUP Mode .....	20
Setting the AUX+ NAME mode .....	20
Setting the AUX+ Level (AUX IN GAIN) .....	20

## USB memory (Optional)

Controlling USB memory (Optional) .....	20
Playing MP3/WMA/AAC Files with the USB memory (Optional) .....	20

## iPod® (Optional)

Playback .....	21
Searching for a desired Song .....	21
Quick Search .....	22
Direct Search Function .....	22
Select Playlist/Artist/Album/Genre/ Composer .....	22
Random Play Shuffle (M.I.X.) .....	23
Repeat Play .....	23
Displaying the Text .....	23

## Information

In Case of Difficulty .....	24
Specifications .....	26

---

## Installation and Connections

<b>Warning</b> .....	<b>27</b>
<b>Caution</b> .....	<b>27</b>
<b>Precautions</b> .....	<b>27</b>
Installation .....	28
Connections .....	30

# Operating Instructions

## WARNING

### WARNING

This symbol means important instructions. Failure to heed them can result in serious injury or death.

#### **DO NOT OPERATE ANY FUNCTION THAT TAKES YOUR ATTENTION AWAY FROM SAFELY DRIVING YOUR VEHICLE.**

Any function that requires your prolonged attention should only be performed after coming to a complete stop. Always stop the vehicle in a safe location before performing these functions. Failure to do so may result in an accident.

#### **KEEP THE VOLUME AT A LEVEL WHERE YOU CAN STILL HEAR OUTSIDE NOISES WHILE DRIVING.**

Excessive volume levels that obscure sounds such as emergency vehicle sirens or road warning signals (train crossings, etc.) can be dangerous and may result in an accident. LISTENING AT LOUD VOLUME LEVELS IN A CAR MAY ALSO CAUSE HEARING DAMAGE.

#### **DO NOT DISASSEMBLE OR ALTER.**

Doing so may result in an accident, fire or electric shock.

#### **USE ONLY IN CARS WITH A 12 VOLT NEGATIVE GROUND.**

(Check with your dealer if you are not sure.) Failure to do so may result in fire, etc.

#### **KEEP SMALL OBJECTS SUCH AS BATTERIES OUT OF THE REACH OF CHILDREN.**

Swallowing them may result in serious injury. If swallowed, consult a physician immediately.

#### **USE THE CORRECT AMPERE RATING WHEN REPLACING FUSES.**

Failure to do so may result in fire or electric shock.

#### **DO NOT BLOCK VENTS OR RADIATOR PANELS.**

Doing so may cause heat to build up inside and may result in fire.

#### **USE THIS PRODUCT FOR MOBILE 12V APPLICATIONS.**

Use for other than its designed application may result in fire, electric shock or other injury.

#### **DO NOT PLACE HANDS, FINGERS OR FOREIGN OBJECTS IN INSERTION SLOTS OR GAPS.**

Doing so may result in personal injury or damage to the product.

### CAUTION

This symbol means important instructions. Failure to heed them can result in injury or material property damage.

#### **HALT USE IMMEDIATELY IF A PROBLEM APPEARS.**

Failure to do so may cause personal injury or damage to the product. Return it to your authorized Alpine dealer or the nearest Alpine Service Centre for repairing.

### PRECAUTIONS

#### **Product Cleaning**

Use a soft dry cloth for periodic cleaning of the product. For more severe stains, please dampen the cloth with water only. Anything else has the chance of dissolving the paint or damaging the plastic.

#### **Temperature**

Be sure the temperature inside the vehicle is between +60°C (+140°F) and -10°C (+14°F) before turning your unit on.

#### **Moisture Condensation**

You may notice the CD playback sound wavering due to condensation. If this happens, remove the disc from the player and wait about an hour for the moisture to evaporate.

#### **Damaged Disc**

Do not attempt to play cracked, warped, or damaged discs. Playing a bad disc could severely damage the playback mechanism.

#### **Maintenance**

If you have problems, do not attempt to repair the unit yourself. Return it to your Alpine dealer or the nearest Alpine Service Station for servicing.

---

## Never Attempt the Following

Do not grip or pull out the disc while it is being pulled back into the player by the automatic reloading mechanism.

Do not attempt to insert a disc into the unit when the unit power is off.

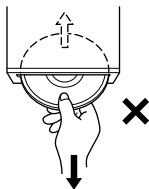

---

## Inserting Discs

Your player accepts only one disc at a time for playback. Do not attempt to load more than one disc.

Make sure the label side is facing up when you insert the disc. "ERROR" will be displayed on your player if you insert a disc incorrectly. If "ERROR" continues to be displayed even though the disc has been inserted correctly, push the RESET switch with a pointed object such as a ballpoint pen.

Playing a disc while driving on a very bumpy road may result in skips, but this will not scratch the disc or damage the player.

---

## New Discs

To prevent the CD from jamming, "ERROR" is displayed if discs with irregular surfaces are inserted or if discs are inserted incorrectly. When a new disc is ejected immediately after initial loading, use your finger to feel around the inside of the centre hole and outside edge of the disc. If you feel any small bumps or irregularities, this could inhibit proper loading of the disc. To remove the bumps, rub the inside edge of the hole and outside edge of the disc with a ballpoint pen or other such instrument, then insert the disc again.

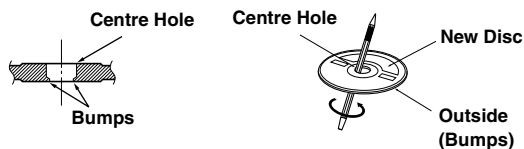

---

## Irregular Shaped Discs

Be sure to use round shape discs only for this unit and never use any special shape discs.

Use of special shape discs may cause damage to the mechanism.



---

## Installation Location

Make sure this unit will not be installed in a location subjected to:

- Direct sun and heat
- High humidity and water
- Excessive dust
- Excessive vibrations

---

## Correct Handling

Do not drop the disc while handling. Hold the disc so you will not leave fingerprints on the surface. Do not affix tape, paper, or gummed labels to the disc. Do not write on the disc.

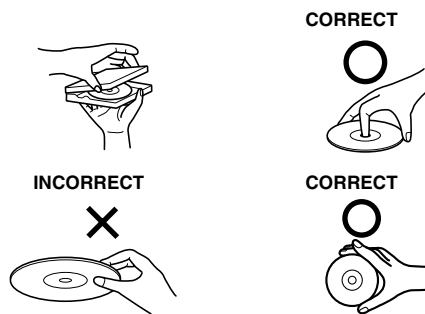

---

## Disc Cleaning

Fingerprints, dust, or soil on the surface of the disc could cause the CD player to skip. For routine cleaning, wipe the playing surface with a clean, soft cloth from the centre of the disc to the outer edge. If the surface is heavily soiled, dampen a clean, soft cloth in a solution of mild neutral detergent before cleaning the disc.



---

## Disc Accessories

There are various accessories available on the market for protecting the disc surface and improving sound quality. However, most of them will influence the thickness and/or diameter of the disc. Using such accessories can cause the disc to be out of standard specifications and may create operational problems. We recommend not using these accessories on discs played in Alpine CD players.



Transparent Sheet

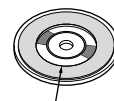

Disc Stabilizer

---

## On handling Compact Discs (CD/CD-R/CD-RW)

- Do not touch the surface.
- Do not expose the disc to direct sunlight.
- Do not affix stickers or labels.
- Clean the disc when it is dusty.
- Make sure that there are no bumps around the disc.
- Do not use commercially available disc accessories.

**Do not leave the disc in the car or the unit for a long time. Never expose the disc to direct sunlight.** Heat and humidity may damage the CD and you may not be able to play it again.

## To customers using CD-R/CD-RW

- If a CD-R/CD-RW cannot be played back, make sure the last recording session was closed (finalized).
- Finalize the CD-R/CD-RW if necessary, and attempt playback again.

---

## About media that can be played

Use only compact discs with the label side showing the CD logo marks below.



If you use unspecified compact discs, correct performance cannot be guaranteed.

You can play CD-Rs (CD-Recordables)/CD-RWs (CD-ReWritables) which have been recorded only on audio devices. You can also play CD-Rs/CD-RWs containing MP3/WMA/AAC formatted audio files.

- Some of the following CDs may not play on this unit:  
Flawed CDs, CDs with fingerprints, CDs exposed to extreme temperatures or sunlight (e.g., left in the car or this unit), CDs recorded under unstable conditions, CDs on which a recording failed or a re-recording was attempted, copy-protected CDs which do not conform to the audio CD industry standard.
- Use discs with MP3/WMA/AAC files written in a format compatible with this unit. For details, see pages 13-14.
- ROM data other than audio files contained in a disc will not produce sound when played back.

---

## Protecting the USB connector

- Only a USB memory can be connected to the USB connector on this unit. Correct performance using other USB products cannot be guaranteed.
- If the USB connector is used, be sure to connect it to the unit using a USB extension cable (sold separately). A USB hub is not supported.
- Depending on the connected USB memory device, the unit may not function or some functions may not be performed.
- The audio file format that can be played back on the unit is MP3/WMA/AAC.
- Artist/song name, etc., can be displayed, however characters may not be correctly displayed.

---

## CAUTION

*Alpine accepts no responsibility for lost data, etc., even if data, etc., is lost while using this product.*

---

## On Handling USB Memory

- To prevent malfunction or damage, note the following points.  
Read the USB memory Owner's Manual thoroughly.  
Do not touch the terminals by hand or metal.  
Do not subject USB memory to excessive shock.  
Do not bend, drop, disassemble, modify or soak in the water.
- Avoid usage or storage in the following locations:  
Anywhere in the car exposed to direct sunlight or high temperatures.  
Anywhere the possibility of high humidity or corrosive substances are present.
- Fix the USB memory in a location where driver operation will not be hindered.
- USB memory may not function correctly at high or low temperature.
- Use only certified USB memory. Note that even certified USB memory, may not function correctly depending on its type or state.
- USB memory function is not guaranteed. Use USB memory according to the terms of agreement.
- Depending on the settings of the USB memory type, memory state or encoding software, the unit may not play back or display properly.
- A file that is copy-protected (copyright protection) cannot be played back.
- USB memory may take time to start playback. If there is a particular file other than audio in the USB memory, it may take considerable time before the file is played back or searched.
- The unit can play back "mp3", "wma" or "m4a" file extensions.
- Do not add the above extensions to a file other than audio data. This non-audio data will not be recognized. The resulting playback may contain noise that can damage speakers and/or amplifiers.
- It is recommended to back up important data on a personal computer.
- Do not remove the USB device while playback is in progress. Change SOURCE to something other than USB, then remove the USB device to prevent possible damage to its memory.

- 
- *Windows Media and the Windows logo are trademarks, or registered trademarks of Microsoft Corporation in the United States and/or other countries.*
  - *iPod is a trademark of Apple Inc., registered in the U.S. and other countries.*
  - **"MPEG Layer-3 audio coding technology licensed from Fraunhofer IIS and Thomson."**
  - **"Supply of this product only conveys a license for private, non-commercial use and does not convey a license nor imply any right to use this product in any commercial (i.e. revenue-generation) real time broadcasting (terrestrial, satellite, cable and/or any other media), broadcasting/streaming via internet, intranets and/or other networks or in other electronic content distribution systems, such as pay-audio or audio-on-demand applications. An independent license for such use is required. For details, please visit <http://www.mp3licensing.com>"**

# Getting Started

⏏ (OPEN) MUTE

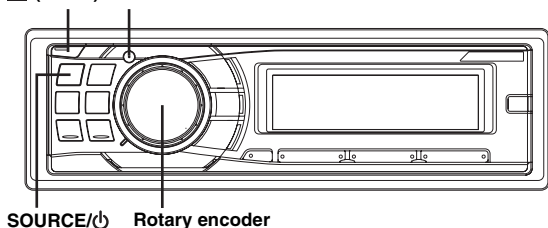

SOURCE/⏏ Rotary encoder

## Accessory List

• Head unit .....	1
• Power cable .....	1
• FULL SPEED™ Connection Cable (CDE-9882Ri only) .....	1
• Mounting sleeve .....	1
• Carrying case .....	1
• Rubber Cap .....	1
• Hex Bolt .....	1
• Screw (M5 x 8) .....	4
• Owner's Manual .....	1 set

## Turning Power On and Off

Press **SOURCE/⏏** to turn on the unit.

- The unit can be turned on by pressing any other button except **⏏ (OPEN)**.

Press and hold **SOURCE/⏏** for at least 2 seconds to turn off the unit.

- The first time power is turned on, the volume will start from level 12.

## Detaching and Attaching the Front Panel

### Detaching

- 1 Turn off the unit power.
- 2 Press **⏏ (OPEN)** to open the front panel.

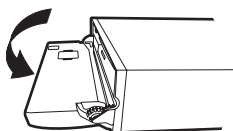

To close the front panel, press the left side until it locks as shown in the figure below.

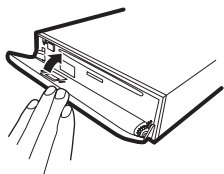

- 3 Grasp the front panel firmly, slide to the left **1**, and then pull **2** to remove.

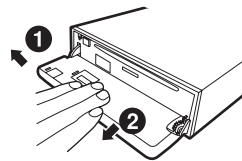

- The front panel may become hot in normal usage (especially the connector terminals on the back of the front panel). This is not a malfunction.
- To protect the front panel, place it in the supplied carrying case.
- When detaching the front panel, do not apply excessive force as it may result in malfunction.
- Do not leave the front panel open, or drive the car with the panel open as it may result in an accident or malfunction.

### Attaching

- 1 Insert the right side of the front panel into the main unit. Align the groove on the front panel with the projections on the main unit.
- 2 Push the left side of the front panel until it locks firmly into the main unit.

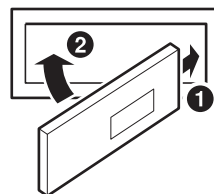

- Before attaching the front panel, make sure that there is no dirt or dust on the connector terminals and no foreign object between the front panel and the main unit.
- Attach the front panel carefully, holding the sides of the front panel to avoid pushing buttons by mistake.



---

## Initial System Start-Up

---

Be sure to press the RESET switch when using the unit for the first time, after changing the car battery, etc.

- 1 Turn off the unit power.
- 2 Press  (**OPEN**) to open the front panel, and then remove it.
- 3 Press **RESET** with a ballpoint pen or similar pointed object.

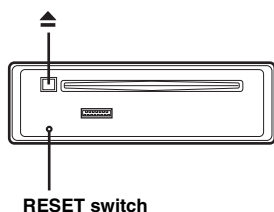

---

## Adjusting Volume

---

Turn the **Rotary encoder** until the desired sound is obtained.

---

## Lowering Volume Quickly

---

Activating the Audio Mute function will instantly lower the volume level by 20 dB.

Press **MUTE** to activate the **MUTE** mode.

The audio level will decrease by about 20 dB.

Pressing **MUTE** again will bring the audio back to its previous level.

### **Controllable with Remote Control**

This unit can be controlled with an optional Alpine remote control. For details, consult your Alpine dealer. Point the optional remote control transmitter at the remote control sensor.

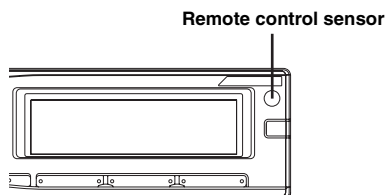

### **Connectable to Steering Remote Control Interface Box**

You can operate this unit from the vehicle's control unit when an Alpine Steering Remote Control Interface Box (optional) is connected. For details, contact your Alpine dealer.

# Radio

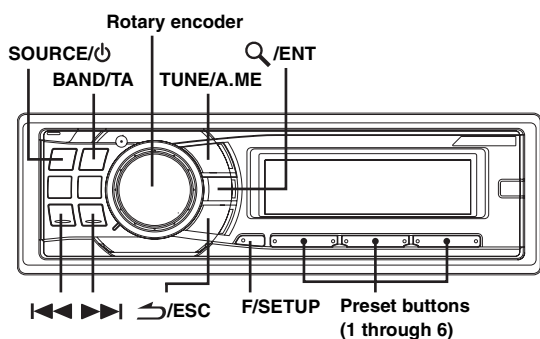

## Listening to Radio

- 1 Press **SOURCE/⏻** to select **TUNER** mode.
- 2 Press **BAND/TA** repeatedly until the desired radio band is displayed.  
F1 (FM1) → F2 (FM2) → F3 (FM3) → MW → LW → F1 (FM1)
- 3 Press **TUNE/A.ME** to select the tuning mode.  
DX SEEK (Distance mode) → SEEK (Local mode) → OFF (Manual mode) → DX SEEK

• The initial mode is Distance mode.

### Distance mode:

Both strong and weak stations will be automatically tuned in (Automatic Seek Tuning).

### Local mode:

Only strong stations will be automatically tuned in (Automatic Seek Tuning).

### Manual mode:

The frequency is manually tuned in steps (Manual tuning).

- 4 Press **⏪** or **⏩** to tune in the desired station.  
Holding down **⏪** or **⏩** will change the frequency continuously.

## Presetting Stations Manually

- 1 Select the radio band and tune in a desired radio station you wish to store in the preset memory.
- 2 Press and hold, for at least 2 seconds, any one of the **preset buttons (1 through 6)** into which you wish to store the station.  
The selected station is stored.  
The display shows the band, preset number and station frequency memorized.

- A total of 30 stations can be stored in the preset memory (6 stations for each band; FM1, FM2, FM3, MW and LW).
- If you store a station in a preset memory which already has a station, the current station will be cleared and replaced with the new station.
- If the **◀F▶** indicator is illuminated, turn off the indicator by pressing **F/SETUP**, then you can perform the operation.

## Presetting Stations Automatically

- 1 Press **BAND/TA** repeatedly until the desired radio band is displayed.
  - 2 Press and hold **TUNE/A.ME** for at least 2 seconds.  
The frequency on the display continues to change while the automatic memory is in progress. The tuner will automatically seek and store 6 strong stations in the selected band. They will be stored into preset buttons 1 to 6 in order of signal strength.  
When the automatic memory has been completed, the tuner goes to the station stored in preset location No.1.
- If no stations are stored, the tuner will return to the original station you were listening to before the auto memory procedure began.

## Tuning to Preset Stations

- 1 Press **BAND/TA** repeatedly until the desired band is displayed.
  - 2 Press any one of the station **preset buttons (1 through 6)** that has your desired radio station in memory.  
The display shows the band, preset number and frequency of the station selected.
- If the **◀F▶** indicator is illuminated, turn off the indicator by pressing **F/SETUP**, and then you can perform the operation.

## Frequency Search Function

You can search for a radio station by its frequency.

- 1 Press and hold **Q/ENT** for at least 2 seconds in **Radio mode** to activate **Frequency search mode**.
  - 2 Turn the **Rotary encoder** to select the desired frequency.
  - 3 Press **Q/ENT** to receive the selected frequency.
- Press and hold **↶/ESC** for at least 2 seconds in the search mode to cancel. Or, the search mode will be cancelled if no operation is performed for 10 seconds.

# RDS

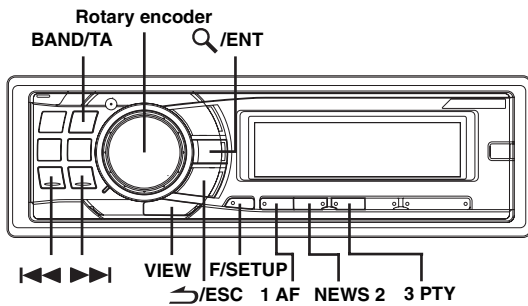

## Setting RDS Reception Mode and Receiving RDS Stations

The RDS (Radio Data System) is a radio information system using the 57 kHz subcarrier of regular FM broadcast. The RDS allows you to receive a variety of information such as traffic information, station names, and to automatically re-tune to a stronger transmitter that is broadcasting the same programme.

- 1 Press **F/SETUP** so that the **◀F▶** indicator lights up.
- 2 Press **1 AF** to activate the RDS mode.
- 3 Press **◀◀** or **▶▶** to tune in the desired RDS station.
- 4 Press **1 AF** again to deactivate the RDS mode.
- 5 Press **F/SETUP** to activate the normal mode.  
The **◀F▶** indicator goes out.

- When the "Setting PTY31 (Emergency Broadcast) reception" (refer to page 10) is set to on, if the unit receives the PTY31 (Emergency Broadcast) signal, the unit will show "ALARM" in the display automatically.
- Operate the unit while the **◀F▶** indicator lights up. If no operation is performed for 10 seconds, the **◀F▶** indicator goes out.

The RDS digital data includes the following:

PI	Programme Identification
PS	Programme Service Name
AF	List of Alternative Frequencies
TP	Traffic Programme
TA	Traffic Announcement
EON	Enhanced Other Networks

## Recalling Preset RDS Stations

- 1 Press **F/SETUP** so that the **◀F▶** indicator lights up.
- 2 Press **1 AF** to activate the RDS mode.
- 3 Press **F/SETUP** to activate the normal mode.  
The **◀F▶** indicator goes out.
- 4 Make sure that the **◀F▶** indicator light goes out, then press the preset button in which your desired RDS station is preset.  
If the preset station's signal is weak, the unit automatically searches and tunes to a stronger station in the AF (Alternative Frequencies) list.
- 5 If the preset station and the stations in the AF list cannot be received:

When the PI SEEK setting is on (refer to "PI SEEK Setting" on page 10), the unit searches again for a station in the PI (Programme Identification) list.

If there are still no stations receivable in the area, the unit displays the frequency of the preset station and the preset number disappears.

If the signal level of the Regional (Local) station being tuned becomes too weak to receive, press the same preset button to tune in a Regional station in other district.

- For presetting the RDS stations, refer to the Radio Operation section. The RDS stations can be preset in the F1, F2 and F3 bands only.
- Operate the unit while the **◀F▶** indicator lights up. If no operation is performed for 10 seconds, the **◀F▶** indicator goes out.

## Receiving RDS Regional (Local) Stations

- 1 Press and hold **F/SETUP** for at least 2 seconds to activate the **SETUP** mode.
- 2 Turn the **Rotary encoder** to select the **RDS REGIONAL** mode, and then press **Q/ENT**.
- 3 Turn the **Rotary encoder** to select **ON** or **OFF**.  
In the **OFF** mode, the unit automatically keeps receiving the related local RDS station.
- 4 Press and hold **F/SETUP** for at least 2 seconds to return to normal mode.
  - Press **↵/ESC** to return to the previous mode.
  - If no operation is performed for 60 seconds, the unit will return to normal mode automatically.

---

## PI SEEK Setting

---

- 1 Press and hold **F/SETUP** for at least 2 seconds to activate the **SETUP** mode.
- 2 Turn the **Rotary encoder** to select the **PI SEEK** mode, and then press **Q/ENT**.
- 3 Turn the **Rotary encoder** to select **ON** or **OFF**.
- 4 Press and hold **F/SETUP** for at least 2 seconds to return to normal mode.

- Press **↵/ESC** to return to the previous mode.
- If no operation is performed for 60 seconds, the unit will return to normal mode automatically.

---

## Setting PTY31 (Emergency Broadcast) reception

---

Turn PTY31 (Emergency Broadcast) reception ON/OFF.

- 1 Press and hold **F/SETUP** for at least 2 seconds to activate the **SETUP** mode.
- 2 Turn the **Rotary encoder** to select **ALERT PTY31**, and then press **Q/ENT**.
- 3 Turn the **Rotary encoder** to select **ON** or **OFF**.  
If you set to ON, emergency broadcasts are received regardless of source. "ALARM" is displayed during reception.
- 4 Press and hold **F/SETUP** for at least 2 seconds to return to normal mode.

When an emergency broadcast is received, the volume level will be automatically changed to the memorized level in the traffic information mode. For details, refer to "Receiving Traffic Information" on page 10.

- Pressing **↵/ESC** during the procedure will return to the previous mode.
- If no operation is performed for 60 seconds in the **SETUP** mode, the setting mode is cancelled.

---

## Receiving Traffic Information

---

- 1 Press and hold **BAND/TA** for at least 2 seconds so that the "TA" indicator lights up.
- 2 Press **◀▶** or **▶▶** to select your desired traffic information station.

When a traffic information station is tuned in, the "TP" indicator lights up.  
Traffic information is heard only when it is being broadcast. If traffic information is not being broadcast, the unit is set in the standby mode. When a traffic information broadcast begins, the unit automatically receives it and the display shows "TRF-INFO" for 5 seconds.  
When the traffic information broadcast is over, the unit will automatically set in the standby mode.

- If the traffic information broadcast signal falls below a certain level, the unit remains in the receiving mode for 1 minute. If the signal remains below a certain level for over 1 minute, the "TA" indicator blinks.
- If you do not want to listen to the traffic information being received, lightly press **BAND/TA** to skip that traffic information message. The TA mode will remain in the ON position to receive the next traffic information message.
- If the volume level is changed while receiving traffic information, the changed volume level will be memorized. When traffic information is received next time, the volume level will be automatically adjusted to the level memorized.
- In the TA mode, the SEEK tuning selects only the TP stations.

---

## PTY (Programme Type) Tuning

---

- 1 Press **F/SETUP** so that the **◀F▶** indicator lights up.
- 2 Press **3 PTY** to activate the PTY mode, while the unit is in **Radio (FM receiving)** mode.  
The Programme Type of the station being currently received will be displayed for 10 seconds.  
If there is no receivable PTY broadcast, "NO PTY" will be displayed for 10 seconds.  
If no RDS station can be received, the display shows "NO PTY".
- 3 Press **◀◀** or **▶▶** within 10 seconds after activating the PTY mode to choose the desired programme type while the **PTY (programme type)** is being displayed.  
Each press scrolls the programme type by one.
- 4 Press **3 PTY** within 10 seconds after selecting the programme type to start searching for a station in the selected programme type.  
The chosen programme type display blinks during searching and lights when a station is found.  
If no PTY station is found, "NO PTY" will be displayed for 10 seconds.
- 5 Press **F/SETUP** to activate the normal mode.  
• Operate the unit while the **◀F▶** indicator lights up. If no operation is performed for 10 seconds, the **◀F▶** indicator goes out.

---

## Receiving Traffic Information While Playing CD or Radio

---

- 1 Press and hold **BAND/TA** for at least 2 seconds so that the "TA" indicator lights up.
- 2 Press **◀◀** or **▶▶** to select a traffic information station if necessary.

When a traffic information broadcast starts, the unit automatically mutes the CD player or the regular FM broadcast.

When the traffic information broadcast finishes, the unit automatically returns to the original source play before the traffic information broadcast began.

### When traffic information stations cannot be received:

In the CD mode:

When the TP signal can no longer be received, the traffic information station of another frequency will be selected automatically.

- The receiver is equipped with the EON (Enhanced Other Networks) function in order to keep track of additional alternate frequencies to the AF list. The "EON" indicator lights up while an RDS EON station is being received. If the station being received does not broadcast the traffic information, the receiver automatically tunes in the related station that broadcasts the traffic information when it occurs.

### 3 Press and hold **BAND/TA** for at least 2 seconds to deactivate the Traffic Information mode.

The "TA" indicator goes out.

## Priority News

This function allows you to preset to give priority to the News programme. You will never miss the News programme as the unit automatically gives priority to the News programme whenever it begins broadcasting, and interrupts the programme you are currently listening. This feature is functional when your unit is set to a mode other than the LW and MW modes.

### 1 Press **F/SETUP** to activate the function mode while the unit is in Radio (FM receiving) mode.

### 2 Press **NEWS 2** to activate the **PRIORITY NEWS** mode.

The "NEWS" indicator appears in the display.

To disable the PRIORITY NEWS function, press **NEWS 2**.

- In the **PRIORITY NEWS** function, unlike in the **TA** function, the volume does not increase automatically.

### 3 Press **F/SETUP** to activate the normal mode, while the unit is in Radio (FM receiving) mode.

- Operate the unit while the **◀F▶** indicator lights up. If no operation is performed for 10 seconds, the **◀F▶** indicator goes out.

## Displaying Radio Text

Text messages from a radio station can be displayed.

### Press **VIEW** while receiving FM in the radio mode to select the Radio Text display.

The display will change every time the button is pressed.

#### If there is **PS (Programme Service Name)**:

PS (Programme Service Name)\* → RADIO TEXT →  
PS (Programme Service Name)

- \* Press and hold **VIEW** for at least 2 seconds if **PS** is displayed in the radio mode, frequency will be displayed for 5 seconds.

#### If there is no **PS (Programme Service Name)**:

FREQUENCY → RADIO TEXT → FREQUENCY

The display shows "WAITING" for a few seconds, then starts scrolling the text message.

- If there is no receivable text message or the unit cannot receive a text message properly, the display shows "NO TEXT".

## CD/MP3/WMA/AAC

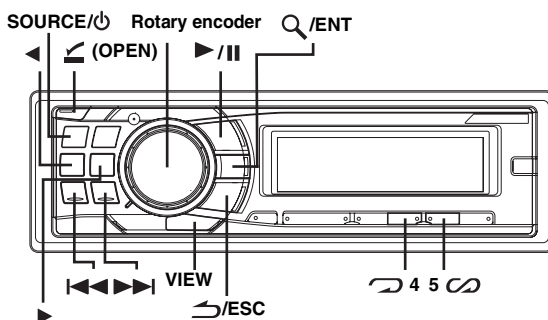

## Playback

### 1 Press **◀ (OPEN)**.

The front panel will open.

### 2 Insert a disc with the label side facing up.

The disc will be pulled into the unit automatically.

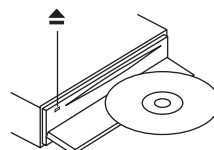

Close the front panel manually, and the "DISC IN" indicator lights up.

When a disc is already inserted, press **SOURCE/⏻** to switch to the DISC mode.

The mode will change every time the button is pressed.

TUNER → DISC → USB AUDIO → iPod\*<sup>1</sup>/AUX+\*<sup>2</sup> →  
BT AUDIO\*<sup>3</sup> → TUNER

\*<sup>1</sup> Displayed only when the iPod is connected and **AUX+ SETUP** is set to **OFF**, refer to "Setting the AUX+ SETUP Mode" (page 20).

\*<sup>2</sup> Displayed only when the **AUX+ SETUP** is set to **ON**, refer to "Setting the AUX+ SETUP Mode" (page 20).

\*<sup>3</sup> Only when **BLUETOOTH IN** is set to **ADAPTE**, refer to "Setting the Bluetooth Connection" (page 18).

### 3 While playing back MP3/WMA/AAC, press **◀** or **▶** to select the desired folder.

Pressing and holding **◀** or **▶** will change folders continuously.

### 4 Press **◀◀** or **▶▶** to select the desired track (file).

#### Returning to the beginning of the current track (file):

Press **◀◀**.

#### Fast backward:

Press and hold **◀◀**.

#### Advancing to the beginning of the next track (file):

Press **▶▶**.

#### Fast forward:

Press and hold **▶▶**.

### 5 To pause playback, press **▶/II**.

Pressing **▶/II** again will resume playback.

## 6 After pressing **↵** (OPEN) to open the front panel, press **⏏** to eject the disc.

- Do not remove a CD during its eject cycle. Do not load more than one disc at a time. A malfunction may result from doing either.
- If the CD does not eject, press and hold **⏏** for at least 2 seconds.
- The “DISC IN” indicator lights up when a disc is inserted.
- The CD-player can play discs containing audio data, MP3 data, WMA data and AAC data.
- WMA format files that are protected by DRM (Digital Rights Management), AAC format files that have been purchased from iTunes Music Store and files that are copy-protected (copyright protection) cannot be played back on this unit.
- “MP3” is displayed during MP3 playback.
- “WMA” is displayed during WMA playback.
- “AAC” is displayed during AAC playback.
- The track display for MP3/WMA/AAC data playback is the file numbers recorded on the disc.
- The playback time may not be correctly displayed when a VBR (Variable Bit Rate) recorded file is played back.

### MP3/WMA/AAC Play Display

The folder number and file number will be displayed as described below.

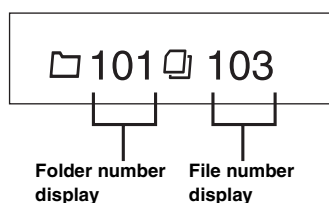

- Press **VIEW** to switch the display. See “Displaying the Text” (page 17) for information about display switching.

## Repeat Play

Press **↶** 4 to play back repeatedly the track being played.

The track (file) will be played repeatedly.

Press **↶** 4 again and select off to deactivate repeat play.

CD mode :

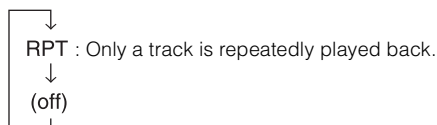

MP3/WMA/AAC mode :

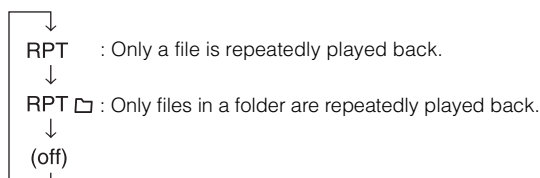

## M.I.X. (Random Play)

Press **5** **↻** in the play or pause mode.

The tracks (files) on the disc will be played back in random sequence.

To cancel M.I.X. play, press **5** **↻** again.

CD mode :

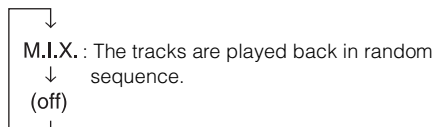

MP3/WMA/AAC mode :

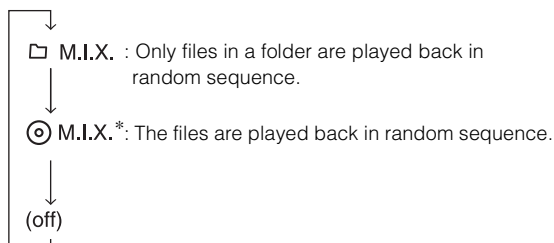

\* In the USB mode, all files stored in the USB memory are played back in random sequence, and the “M.I.X.” indicator lights up.

- When a song is played back during Random (M.I.X.) play in the USB mode, the song can be played back again randomly even if not all songs on the USB Memory have been played back.

## Searching for CD Text

On discs utilizing CD Text, songs can be searched and played by using their recorded titles. For discs without CD Text, searches are made using the track numbers associated with each song.

**1** Press **Q/ENT** during play.

This will set the search mode.

**2** Turn the **Rotary encoder** to select the desired track, and then press **Q/ENT**.

This will play the selected track.

- Press and hold **↶/ESC** for at least 2 seconds in the search mode to cancel. Or, the search mode is cancelled if no operation is performed for 10 seconds.
- When CD Text Search is made during M.I.X. play, the M.I.X. play mode will be cancelled.

---

## File/Folder Name Search (concerning MP3/WMA/AAC)

---

Folder and file names may be searched and displayed during playback.

- 1** During MP3/WMA/AAC playback, press **Q/ENT** to activate the search mode.
  - 2** Turn the **Rotary encoder** to select **Folder Name Search mode** or **File Name Search mode**, and then press **Q/ENT**.
- 

### Folder Name Search mode

- 3** Turn the **Rotary encoder** to select the desired folder.
- 4** Press and hold **Q/ENT** for at least 2 seconds to play back the first file in the selected folder.
  - Press and hold **↵/ESC** for at least 2 seconds in the search mode to cancel. Or, the search mode is cancelled if no operation is performed for 10 seconds.
  - To search for files in the Folder Name Search mode, press **Q/ENT**. Files in the folder may be searched.
  - Press **↵/ESC** to exit Folder Name Search mode in step 3 in order to select File Name Search mode.
  - The root folder of DISC is displayed as "-----".
  - When Folder Name Search is made during M.I.X. play, the M.I.X. play mode will be cancelled.

### File Name Search mode

- 3** Press **◀** or **▶** to select another Folder.
- 4** Select the desired file by turning the **Rotary encoder**.
- 5** Press **Q/ENT** to play back the selected file.
  - Press and hold **↵/ESC** for at least 2 seconds in the search mode to cancel. Or, the search mode is cancelled if no operation is performed for 10 seconds.
  - Press **↵/ESC** in the search mode to return to the previous mode.
  - When File Name Search is made during M.I.X. play, the M.I.X. play mode will be cancelled.

---

## Quick Search

---

You can search for tracks (files).

- 1** Press and hold **Q/ENT** for at least 2 seconds in the **CD/MP3/WMA/AAC** mode to activate **Quick Search mode**.
- 2** Turn the **Rotary encoder** to select a desired track (file).

The selected track is played back immediately.

  - Press and hold **↵/ESC** for at least 2 seconds in the search mode to cancel. Or, the search mode is cancelled if no operation is performed for 10 seconds.

---

## About MP3/WMA/AAC

---

### **CAUTION**

*Except for private use, duplicating audio data (including MP3/WMA/AAC data) or distributing, transferring, or copying it, whether for free or for a fee, without permission of the copyright holder is strictly prohibited by the Copyright Act and by international treaty.*

### **What is MP3?**

MP3, whose official name is "MPEG-1 Audio Layer 3," is a compression standard prescribed by the ISO, the International Standardization Organization and MPEG which is a joint activity institution of the IEC.

MP3 files contain compressed audio data. MP3 encoding is capable of compressing audio data at extremely high ratios, reducing the size of music files to as much as one-tenth their original size. This is achieved while still maintaining near CD quality. The MP3 format realises such high compression ratios by eliminating the sounds that are either inaudible to the human ear or masked by other sounds.

### **What is WMA?**

WMA, or "Windows Media™ Audio," is compressed audio data. WMA is similar to MP3 audio data and can achieve CD quality sound with small file sizes.

### **What is AAC?**

AAC is the abbreviation for "Advanced Audio Coding," and is a basic format of audio compression used by MPEG2 or MPEG4.

### **Method for creating MP3/WMA/AAC files**

Audio data is compressed using software with MP3/WMA/AAC codecs. For details on creating MP3/WMA/AAC files, refer to the user's manual for that software.

MP3/WMA/AAC files that are playable on this device have the file extensions "mp3"/"wma"/"m4a". Files with no extension cannot be played back (WMA ver. 7.1, 8 and 9 are supported). Protected files are not supported, neither are raw AAC files (using the ".aac" extension).

There are many different versions of the AAC format. Confirm that the software being used conforms to the acceptable formats listed above. It's possible that the format may be unplayable even though the extension is valid. Playback of AAC files encoded by iTunes is supported.

## Supported playback sampling rates and bit rates

### MP3

Sampling rates: 48 kHz, 44.1 kHz, 32 kHz, 24 kHz, 22.05 kHz, 16 kHz, 12 kHz, 11.025 kHz, 8 kHz

Bit rates: 32 - 320 kbps

### WMA

Sampling rates: 48 kHz, 44.1 kHz, 32 kHz

Bit rates: 48 - 192 kbps

### AAC

Sampling rates: 48 kHz, 44.1 kHz, 32 kHz, 24 kHz, 22.05 kHz, 16 kHz, 12 kHz, 11.025 kHz, 8 kHz

Bit rates: 16 - 320 kbps

This device may not play back correctly depending on sampling rates.

In the USB mode, the playback time may not be correctly displayed when a VBR (Variable Bit Rate) recorded file is played back.

## ID3 tags/WMA tags

This device supports ID3 tag v1 and v2, and WMA/AAC tag. If tag data is in an MP3/WMA/AAC file, this device can display the title (track title), artist name, and album name ID3 tag/WMA/AAC tag data.

This device can only display single-byte alphanumeric characters (up to 30 for ID3 tags and up to 15 for WMA tags) and the underscore. For non-supported characters, "NO SUPPORT" is displayed.

The tag information may not be correctly displayed, depending on the contents.

## Playing back MP3/WMA/AAC

MP3/WMA/AAC files are prepared, then written to a CD-R, CD-RW using CD-R writing software or stored to a USB memory. A disc can hold up to 510 files/folders (including Root Folders), and the maximum number of folders is 255. This unit can recognize at least 100 folders (including root folder) and 100 files per folder stored in USB memory.

Playback may not be performed if a disc or USB memory exceeds the limitations described above.

Do not make a file's playback time more than 1 hour.

## Media supported

The media that this device can play back are CD-ROMs, CD-Rs, and CD-RWs.

This device also can play back USB memory media.

## Corresponding File Systems

This device supports discs formatted with ISO9660 Level 1 or Level 2.

Under the ISO9660 standard, there are some restrictions to remember.

The maximum nested folder depth is 8 (including the root directory). The number of characters for a folder/file name is limited.

Valid characters for folder/file names are letters A-Z (all caps), numbers 0-9, and '\_' (underscore).

This device also can play back discs in Joliet, Romeo, etc., and other standards that conform to ISO9660. However, sometimes the file names, folder names, etc., are not displayed correctly. This device also supports FAT 12/16/32 for USB memory device.

## Formats supported

This device supports CD-ROM XA, Mixed Mode CD, Enhanced CD (CD-Extra) and Multi-Session.

This device cannot correctly play back discs recorded with Track At Once or packet writing.

## Order of files

Files are played back in the order that the writing software writes them to the disc. Therefore, the playback order may not be what is expected. Verify the writing order in the software's documentation. The playback order of the folders and files is as follows.

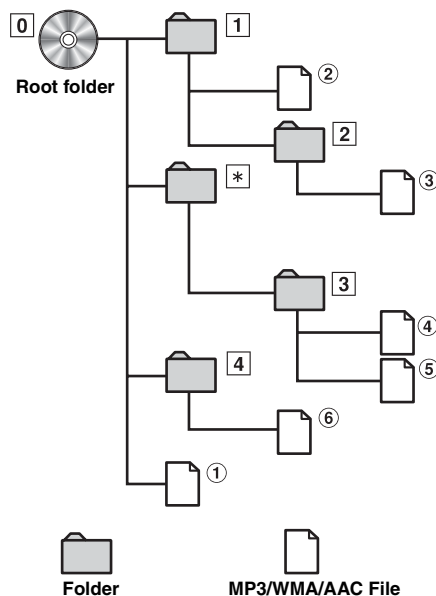

\* The folder No./folder Name will not be displayed if no file is contained in the folder.

## Terminology

### Bit rate

This is the "sound" compression rate specified for encoding. The higher the bit rate, the higher the sound quality, but also the larger the files.

### Sampling rate

This value shows how many times per second the data is sampled (recorded). For example, music CDs use a sampling rate of 44.1 kHz, so the sound is sampled (recorded) 44,100 times per second. The higher the sampling rate, the higher the sound quality, but also the larger the volume of data.

### Encoding

Converting music CDs, WAVE (AIFF) files, and other sound files into the specified audio compression format.

### Tag

Song information such as track titles, artist names, album names, etc., written into MP3/WMA/AAC files.

### Root folder

The root folder (or root directory) is found at the top of the file system. The root folder contains all folders and files. It is created automatically for all burned discs.



# Sound Setting

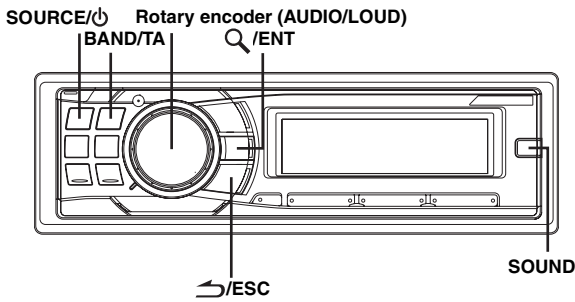

## Adjusting Subwoofer Level/Bass Level/Treble Level/Balance (Between Left and Right)/Fader (Between Front and Rear)/Defeat

- 1 Press **Rotary encoder (AUDIO)** repeatedly to choose the desired mode.

Each press changes the mode as follows:

SUBW LEVEL\* → BASS LEVEL → TREBLE LEVEL → BALANCE → FADER → DEFEAT → VOLUME → SUBW LEVEL

Subwoofer level : 0 ~ +15  
 Bass level: -7 ~ +7  
 Treble level: -7 ~ +7  
 Balance : L15 ~ R15  
 Fader : R15 ~ F15  
 Defeat : ON/OFF  
 Volume : 0 ~ 35

- If no operation is performed for 5 seconds after selecting the SUBW LEVEL, BASS LEVEL, TREBLE LEVEL, BALANCE, FADER or DEFEAT mode, the unit automatically returns to normal mode.

\* When the subwoofer mode is set to OFF, its level cannot be adjusted. Refer to "Turning Subwoofer ON/OFF" (page 16).

- 2 Turn the **Rotary encoder** until the desired sound is obtained in each mode.

By setting DEFEAT ON, previously adjusted settings of BASS and TREBLE will return to the factory defaults.

## Setting the Subwoofer Level

You can change the Subwoofer Level to create your own tonal preference.

- 1 Press **SOUND** to activate the Sound Setting mode.
- 2 Turn the **Rotary encoder** to select the **SUBW LEVEL** Adjustment mode, and then press **Q/ENT**.  
 SUBW LEVEL\*<sup>1</sup> ↔ BASS\*<sup>2</sup> ↔ TREBLE\*<sup>2</sup> ↔ HPF\*<sup>2</sup> ↔ SUBW LEVEL
- 3 Turn the **Rotary encoder** to select the desired subwoofer level (0~+15).

- If no operation is performed for 15 seconds, the unit will return to normal mode automatically.
- When subwoofer is set to OFF and DEFEAT is set to ON, pressing the SOUND button momentarily will not be functional.

\*<sup>1</sup> When the subwoofer mode is set to OFF, its level cannot be adjusted. The adjustment can also be made by pressing **Rotary encoder (AUDIO)**. Refer to "Adjusting Subwoofer Level/Bass Level/Treble Level/Balance (Between Left and Right)/Fader (Between Front and Rear)/Defeat" (page 15).

\*<sup>2</sup> The function is inoperable when DEFEAT is set to ON.

## Setting the Bass Control

You can change the Bass Frequency emphasis to create your own tonal preference.

- 1 Press **SOUND** to activate the Sound Setting mode.
- 2 Turn the **Rotary encoder** to select the **BASS** Adjustment mode, and then press **Q/ENT**.

SUBW LEVEL\*<sup>3</sup> ↔ BASS\*<sup>4</sup> ↔ TREBLE\*<sup>4</sup> ↔ HPF\*<sup>4</sup> ↔ SUBW LEVEL

## Setting the Bass Centre Frequency

- 3-1 Press **BAND/TA** to select the desired bass centre frequency.

80 Hz → 100 Hz → 200 Hz → 60 Hz → 80 Hz

Emphasizes the displayed bass frequency ranges.

## Setting the Bass Bandwidth

- 3-2 Press **SOURCE/⏻** to select the desired bass bandwidth.

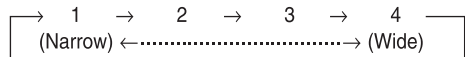

Changes the boosted bass bandwidth to wide or narrow. A wider setting will boost a wide range of frequencies above and below the centre frequency. A narrower setting will boost only frequencies near the centre frequency.

## Setting the Bass Level

- 3-3\*<sup>5</sup> Turn the **Rotary encoder** to select the desired bass level (-7~+7).  
 You can emphasize or weaken the bass level.
- 4 Press and hold **↵/ESC** for at least 2 seconds to return to normal mode.

- If no operation is performed for 15 seconds, the unit will return to normal mode automatically.
- The bass level settings will be individually memorized for each source (FM, MW (LW), CD, etc.) until the setting is changed. The bass frequency and bass bandwidth settings adjusted for one source are effective for all other sources (FM, MW (LW), CD etc.).
- When subwoofer is set to OFF and DEFEAT is set to ON, pressing the SOUND button momentarily will not be functional.

\*<sup>3</sup> When the subwoofer mode is set to OFF, its level cannot be adjusted. Refer to "Turning Subwoofer ON/OFF" (page 16).

\*<sup>4</sup> The function is inoperable when DEFEAT is set to ON.

\*<sup>5</sup> The adjustment can also be made by pressing **Rotary encoder (AUDIO)**. Refer to "Adjusting Subwoofer Level/Bass Level/Treble Level/Balance (Between Left and Right)/Fader (Between Front and Rear)/Defeat" (page 15).

---

## Setting the Treble Control

---

You can change the Treble Frequency emphasis to create your own tonal preference.

**1 Press SOUND to activate the Sound Setting mode.**

**2 Turn the Rotary encoder to select the TREBLE Adjustment mode, and then press Q/ENT.**

SUBW LEVEL\*<sup>6</sup> ↔ BASS\*<sup>7</sup> ↔ TREBLE\*<sup>7</sup> ↔ HPF\*<sup>7</sup> ↔ SUBW LEVEL

### Setting the Treble Centre Frequency

**3-1 Press BAND/TA to select the desired treble centre frequency.**

10.0 kHz → 12.5 kHz → 15.0 kHz → 17.5 kHz → 10.0 kHz

Emphasizes the displayed treble frequency ranges.

### Setting the Treble Level

**3-2\*<sup>8</sup> Turn the Rotary encoder to select the desired treble level (-7~+7).**

You can emphasize the treble level.

**4 Press and hold ↵/ESC for at least 2 seconds to return to normal mode.**

- If no operation is performed for 15 seconds, the unit will return to normal mode automatically.
- The treble level settings will be individually memorized for each source (FM, MW (LW), CD, etc.) until the setting is changed. The Treble frequency settings adjusted for one source are effective for all other sources (FM, MW (LW), CD, etc.).
- When subwoofer is set to OFF and DEFEAT is set to ON, pressing the SOUND button momentarily will not be functional.

\*<sup>6</sup> When the subwoofer mode is set to OFF, its level cannot be adjusted. Refer to "Turning Subwoofer ON/OFF" (page 16).

\*<sup>7</sup> The function is inoperable when DEFEAT is set to ON.

\*<sup>8</sup> The adjustment can also be made by pressing Rotary encoder (AUDIO). Refer to "Adjusting Subwoofer Level/Bass Level/Treble Level/Balance (Between Left and Right)/Fader (Between Front and Rear)/Defeat" (page 15).

---

## Adjusting the High Pass Filter

---

The High Pass Filter on this unit can be adjusted to suit your personal taste.

**1 Press SOUND to activate the Sound Setting mode.**

**2 Turn the Rotary encoder to select the HPF Adjustment mode, and then press Q/ENT.**

SUBW LEVEL\*<sup>9</sup> ↔ BASS\*<sup>10</sup> ↔ TREBLE\*<sup>10</sup> ↔ HPF\*<sup>10</sup> ↔ SUBW LEVEL

**3 Turn the Rotary encoder to select the desired HPF frequency.**

OFF ↔ 80 Hz ↔ 120 Hz ↔ 160 Hz

**4 Press and hold ↵/ESC for at least 2 seconds to return to normal mode.**

- If no operation is performed for 15 seconds, the unit will return to normal mode automatically.
- When subwoofer is set to OFF and DEFEAT is set to ON, pressing the SOUND button momentarily will not be functional.

\*<sup>9</sup> When the subwoofer mode is set to OFF, its level cannot be adjusted. Refer to "Turning Subwoofer ON/OFF" (page 16).

\*<sup>10</sup> The function is inoperable when DEFEAT is set to ON.

---

## Turning Subwoofer ON/OFF

---

When the subwoofer is on, you can adjust the subwoofer output level (refer to page 15).

**1 Press and hold SOUND for at least 2 seconds to activate the Subwoofer selection mode.**

**2 Turn the Rotary encoder to select the SUBWOOFER mode, and then press Q/ENT.**

SUBWOOFER ↔ SUBW SYSTEM ↔ SUBWOOFER

**3 Turn the Rotary encoder to select SUBW ON/OFF.**

SUBW ON (Initial Setting) ↔ SUBW OFF

**4 Press and hold ↵/ESC for at least 2 seconds to return to normal mode.**

- If no operation is performed for 15 seconds, the unit will return to normal mode automatically.

---

## Setting the Subwoofer System

---

When the subwoofer is on, you can select either SYS 1 or SYS 2 for the desired subwoofer effect.

**1 Press and hold SOUND for at least 2 seconds to activate the Subwoofer selection mode.**

**2 Turn the Rotary encoder to select the SUBW SYSTEM mode, and then press Q/ENT.**

SUBWOOFER ↔ SUBW SYSTEM ↔ SUBWOOFER

**3 Turn the Rotary encoder to select SUBW SYS 1 or SUBW SYS 2, and then press Q/ENT.**

Select either SYS 1 or SYS 2 for the desired subwoofer effect.

SUBW SYS 1 (Initial Setting) ↔ SUBW SYS 2

SUBW SYS 1: Subwoofer level changes according to the main volume setting.

SUBW SYS 2: Subwoofer level changes is different from the main volume setting. For example, even at low volume settings, the subwoofer is still audible.

**4 Press and hold ↵/ESC for at least 2 seconds to return to normal mode.**

- If no operation is performed for 15 seconds, the unit will return to normal mode automatically.
- This function is inoperable when Subwoofer mode is set to OFF.

---

## Turning Loudness On/Off

---

Loudness introduces a special low- and high-frequency emphasis at low listening levels. This compensates for the ear's decreased sensitivity to bass and treble sound.

**Press and hold Rotary encoder (LOUD) for at least 2 seconds to activate or deactivate the loudness mode.**

- The function is inoperable when DEFEAT is set to ON.

# Other Functions

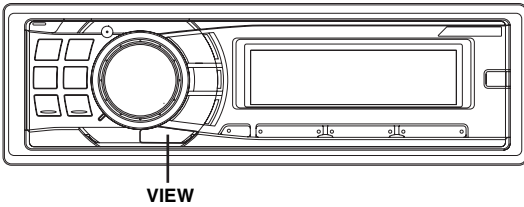

## Displaying the Text

Text information, such as the disc name and the track name, will be displayed if playing a CD text compatible disc. It is also possible to display the folder name, the file name and the tag, etc., while playing MP3/WMA/AAC files.

### Press VIEW.

The display will change every time the button is pressed.

- When the TEXT SCROLL is set to SCROLL MANU, press and hold VIEW for at least 2 seconds, the current text will be scrolled one time (except Radio mode).

### The display in Radio mode:

#### If there is PS (Programme Service Name)

PS (Programme Service Name)\*<sup>1</sup> → RADIO TEXT → PS (Programme Service Name)

#### If there is no PS (Programme Service Name)

FREQUENCY → RADIO TEXT → FREQUENCY

### The display in CD mode:

TRACK NO./ELAPSED TIME → TEXT (DISC NAME)\*<sup>2</sup> → TEXT (TRACK NAME)\*<sup>2</sup> → TRACK NO./ELAPSED TIME

### The display in MP3/WMA/AAC mode:

FILE NO./ELAPSED TIME → FOLDER NO./FILE NO. → FOLDER NAME → FILE NAME → ARTIST NAME\*<sup>3</sup> → ALBUM NAME\*<sup>3</sup> → SONG NAME\*<sup>3</sup> → FILE NO./ELAPSED TIME

### The display in BT AUDIO mode:

The following display will be shown only when a telephone with iRadio function is correctly connected with a Bluetooth Interface Module and correctly set. (For details, refer to the Owner's Manual of the Bluetooth Interface Module).

PRESET NO. → ARTIST NAME\*<sup>4</sup> → ALBUM NAME\*<sup>4</sup> → SONG NAME\*<sup>4</sup> → PRESET NO.

\*<sup>1</sup> Press and hold VIEW for at least 2 seconds in the PS display mode, frequency will be displayed for 5 seconds.

\*<sup>2</sup> Displayed during playback of a disc with CD text.

\*<sup>3</sup> ID3 tag/WMA tag

If an MP3/WMA/AAC file contains ID3 tag/WMA tag information, the ID3 tag/WMA tag information is displayed (e.g., song name, artist name, and album name). All other tag data is ignored.

If the Scroll Setting (page 19) is set to "SCROLL AUTO", the tag information will scroll automatically.

\*<sup>4</sup> When a BT AUDIO signal is received, text information such as artist, album, song is displayed.

If there is no text information, "ARTIST"/"ALBUM"/"SONG" will be displayed.

## About the indication display

When displaying Text, the following indicators are lit according to the mode.

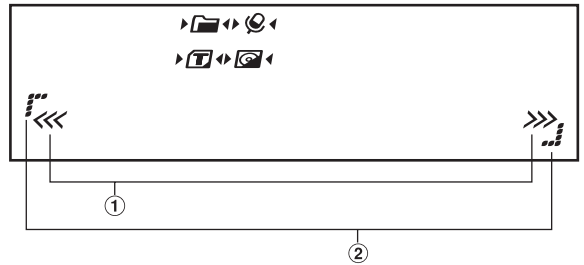

- ① Blinks in search mode when the Rotary encoder is turned. Also blinks when operation, such as fast forward etc., is performed.
- ② Lights up in SETUP mode or SOUND setting menu mode.

Indicator/ Mode	CD Mode	MP3/WMA/AAC/ USB Audio Mode	iPod/BT Audio Mode
Folder icon	—	Folder Name* <sup>2</sup> being displayed	—
CD icon	—	Artist Name* <sup>1</sup> being displayed	Artist Name* <sup>1</sup> being displayed
Disc icon	Text (Disc Name* <sup>3</sup> ) being displayed	Album Name* <sup>1</sup> being displayed	Album Name* <sup>1</sup> being displayed
Track icon	Text (Track Name* <sup>3</sup> ) being displayed	Song Name* <sup>1</sup> / File Name being displayed	Song Name* <sup>1</sup> being displayed

### \*<sup>1</sup> Tag information

If there is no tag information, "ARTIST"/"ALBUM"/"SONG" is displayed.

\*<sup>2</sup> The root folder of Disc is displayed as "FOLDER", the root folder of USB is displayed as "ROOT".

\*<sup>3</sup> If there is no Text (Disc Name or Track Name), "DISC TEXT"/"TRACK TEXT" is displayed.

## About "Text"

### Text:

Text compatible CDs contain text information such as the disc name and track name. Such text information is referred to as "text."

- Some characters may not be displayed correctly with this device, depending on the character type.
- The text or tag information may not be correctly displayed, depending on the contents.

# SETUP

You can flexibly customize the unit to suit your own preferences and usage. From the SETUP menu, Sound Customizing, Visual Customizing, etc., can be modified.

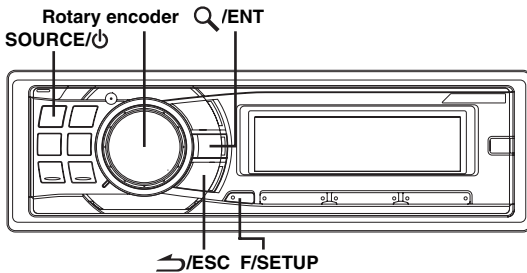

Use steps 1 to 4 to select one of the SETUP modes to modify. See the applicable section below for details about the selected SETUP item.

**1** Press and hold **F/SETUP** for at least 2 seconds to activate the SETUP mode.

**2** Turn the **Rotary encoder** to select the desired **SETUP** menu, and then press **Q/ENT**.  
(e.g. Select POWER IC)

BLUETOOTH IN\*<sup>1</sup> ↔ FM-LEVEL ↔ RDS REGIONAL\*<sup>2</sup> ↔  
PI SEEK\*<sup>3</sup> ↔ ALERT PTY31\*<sup>4</sup> ↔ ILLUMINATION ↔  
LCD CONTRAST ↔ DIMMER ↔ PLAY MODE ↔  
SCROLL TYPE ↔ TEXT SCROLL ↔ INT MUTE\*<sup>5</sup> ↔  
AUX+ SETUP ↔ AUX+ NAME\*<sup>6</sup> ↔ AUX IN GAIN\*<sup>6</sup> ↔  
POWER IC ↔ LANGUAGE ↔ DEMO ↔ BLUETOOTH IN

\*<sup>1</sup> Displayed only when INT MUTE is set to OFF, and the mode is set to other than BT AUDIO.

\*<sup>2</sup> Refer to "Receiving RDS Regional (Local) Stations" (page 9).

\*<sup>3</sup> Refer to "PI SEEK Setting" (page 10).

\*<sup>4</sup> Refer to "Setting PTY31 (Emergency Broadcast) reception" (page 10).

\*<sup>5</sup> Displayed only when BLUETOOTH IN is OFF.

\*<sup>6</sup> Displayed only when AUX+ SETUP is ON.

**3** Turn the **Rotary encoder** to change the setting.  
(e.g. Select POWER IC ON or POWER IC OFF.)

**4** Press and hold **F/SETUP** for at least 2 seconds to return to normal mode.

- Press **↵/ESC** to return to the previous mode.
- If no operation is performed for 60 seconds, the unit will return to normal mode automatically.

## BLUETOOTH IN

### Setting the Bluetooth Connection

#### BT IN ADAPTE / BT IN OFF (Initial setting)

If an optional Bluetooth Box is connected, you can place a hands-free call by a Bluetooth-equipped mobile phone.

Make this setting when the Bluetooth Box is connected and the Bluetooth function is used. For details, refer to the Owner's Manual of the optional Bluetooth Box.

Set ADAPTE when the Bluetooth Box is connected.

- If the Bluetooth Box compatible with the Voice Dial function is connected, the Voice Dial function can be used.

## Sound Customizing

### Adjusting Source Signal Levels

#### FM-LEVEL HI (Initial setting) / FM-LEVEL LOW

If the difference in volume level between the CD player and FM radio is too great, adjust the FM signal level.

## Visual Customizing

### Changing Lighting Colour

#### ILLUMI TYPE1 (initial setting) / ILLUMI TYPE2

TYPE1 ↔ TYPE2

- CDE-9880R:

You can change the lighting colour of the unit's buttons.

TYPE1: The colour of the unit's buttons is green.

TYPE2: The colour of the unit's buttons is amber

- CDE-9882Ri:

You can change the lighting colour of the following six buttons.

SOURCE/⏻, BAND/TA, ◀, ▶, ◀◀, ▶▶.

TYPE1: When the colour of the six buttons is blue, the colour of the other is red.

TYPE2: When the colour of the six buttons is red, the colour of the other is red.

### Adjusting Display Contrast

#### CONTRAST

You can adjust the display contrast for better visibility.

You can adjust in a range of -5 and +3.

- The initial setting at the factory is "0".

## Dimmer Control

### **DIMMER AUTO (Initial setting) / DIMMER MANU**

Set the DIMMER control to AUTO to decrease the illumination brightness of the unit with the head lights of the vehicle ON. This mode is useful if you feel the unit's backlighting is too bright at night.

- *If your vehicle should have a dimmer control for the dashboard lights, never connect the DIMMER cable (orange) of the radio to this dimmer control.*

## Scroll Type Setting

### **SCROLL TYPE1 / SCROLL TYPE2 (Initial setting)**

Choose from two scrolling methods.

Select the type you prefer.

**SCROLL TYPE1:** The characters scroll from right to left, a single character at a time.

**SCROLL TYPE2:** Words are built up from left to right, a single character at a time. When the display is filled, it is cleared and the remaining words are displayed the same way until all words of the title have been shown.

## Scroll Setting (TEXT SCROLL)

### **SCROLL AUTO / SCROLL MANU (Initial setting)**

This CD player can scroll the disc and track names recorded on CD-TEXT discs, as well as the text information of MP3/WMA/AAC files, folder names and tags.

**SCROLL AUTO:** The CD text information, the text information of folder and file names, and the tags are scrolled automatically.

**SCROLL MANU:** The display is scrolled when a disc is loaded or when a track is changed, etc.

- *The unit scrolls CD text names, folder names, file names or tag display.*

## Setting the Language Font

### **LANGUAGE 1 (initial setting) / LANGUAGE 2 / LANGUAGE 3**

Three types of font can be selected.

LANGUAGE 1: Normal font

LANGUAGE 2: European font

LANGUAGE 3: Russian font

## Demonstration

### **DEMO ON / DEMO OFF (Initial setting)**

This unit has a demonstration feature for the display.

- *To quit Demo mode, set to DEMO OFF.*

## MP3/WMA/AAC

### **Playing MP3/WMA/AAC Data (PLAY MODE)**

#### **CD-DA (Initial setting) / CD-DA&MP3**

This unit can play back CDs containing both CD and MP3/WMA/AAC data (created in Enhanced CD (CD Extra) format). However, in some situations, playback of an enhanced CD may be difficult. In this case, you can select playback of a single session only, containing the CD data. When a disc contains both CD and MP3/WMA/AAC data, playback starts from the CD data portion of the disc.

**CD-DA :** Only the CD data in Session 1 can be played back.

**CD-DA&MP3 :** CD data, MP3/WMA/AAC files in mixed mode, and multi-session discs can be played back.

- *Perform this setting before inserting a disc. If a disc has already been inserted, remove it first.*

## External Device

### **Connecting to an External Amplifier**

#### **POWER IC ON (Initial setting) / POWER IC OFF**

When an external amplifier is connected, sound quality can be improved by stopping the power supply of the built-in amplifier.

**POWER IC OFF :** Use this mode when the line output of this unit is used to drive an external amplifier. In this setting, the head unit's internal amplifier is turned OFF and cannot drive speakers.

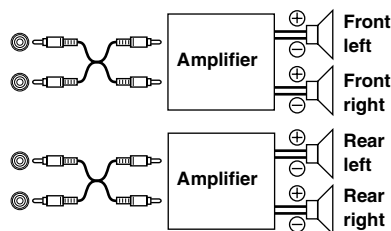

POWER IC ON : The speakers are driven by the built-in amplifier.

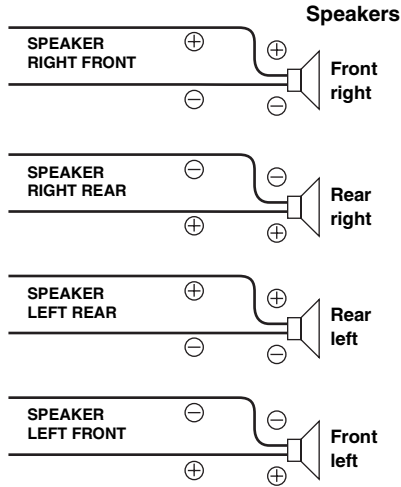

- No sound is produced by the system when the power output is set to OFF.

### Turning Mute Mode On/Off (INT MUTE)

#### MUTE ON / MUTE OFF (Initial setting)

If a device having the interrupt feature is connected, audio will be automatically muted whenever the interrupt signal is received from the device.

### Setting the AUX+ SETUP Mode

#### AUX+ ON / AUX+ OFF (Initial setting)

An external device (such as a portable music player) can be connected to the iPod Direct connector of this unit. An iPod Direct/RCA Interface cable (optional) is required.

A portable music device and an iPod cannot be connected to the iPod Direct connector at the same time.

**AUX+ ON :** Set to ON when a portable device is connected. If SOURCE/⏻ is pressed and AUX+ is selected, the sound of the portable device is input to the unit.

**AUX+ OFF :** Set to OFF when an iPod is connected.

### Setting the AUX+ NAME mode

#### AUXILIARY\* (Initial setting) / TV / DVD / PORTABLE / GAME

You can change the AUX+ NAME display in the SETUP mode, when AUX+ SETUP is ON.

\* After the setting is completed, AUX is displayed on the unit.

### Setting the AUX+ Level (AUX IN GAIN)

#### LOW (Initial setting) / HIGH

After setting to ON in "Setting the AUX+ SETUP Mode", this setting can be carried out.

**LOW:** Decreases the external input audio level.

**HIGH:** Increases the external input audio level.

## USB memory (Optional)

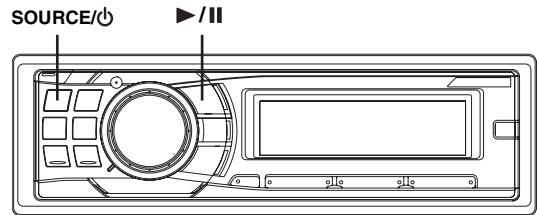

## Controlling USB memory (Optional)

A USB memory can be connected to this unit. With a USB memory connected to this unit, the USB memory will be controllable from this unit.

- The controls on this unit for USB memory operation are operative only when a USB memory is connected.

## Playing MP3/WMA/AAC Files with the USB memory (Optional)

If you connect a USB memory containing MP3/WMA/AAC, you can play these files on this unit.

### 1 Press SOURCE/⏻ to switch to the USB AUDIO mode.

The mode will change every time the button is pressed.

TUNER → DISC → USB AUDIO → iPod\*<sup>1</sup>/AUX+\*<sup>2</sup> → BT AUDIO\*<sup>3</sup> → TUNER

\*<sup>1</sup> Displayed only when the iPod is connected and AUX+ SETUP is set to OFF, refer to "Setting the AUX+ SETUP Mode" (page 20).

\*<sup>2</sup> Displayed only when the AUX+ SETUP is set to ON, refer to "Setting the AUX+ SETUP Mode" (page 20).

\*<sup>3</sup> Only when BLUETOOTH IN is set to ADAPTE, refer to "Setting the Bluetooth Connection" (page 18).

### 2 To pause playback, press ▶/||.

Pressing ▶/|| again will resume the playback.

- The root folder is displayed as "ROOT" in the Folder Name Search mode.
- This unit plays back files on a USB memory device with the same controls and modes as playback of CDs containing MP3/WMA/AAC. For details, refer to "CD/MP3/WMA/AAC" on pages 11 to 14.
- Before disconnecting USB memory, be sure to change to another source or set to pause.
- The playback time may not be correctly displayed when a VBR (Variable Bit Rate) recorded file is played back.

# iPod® (Optional)

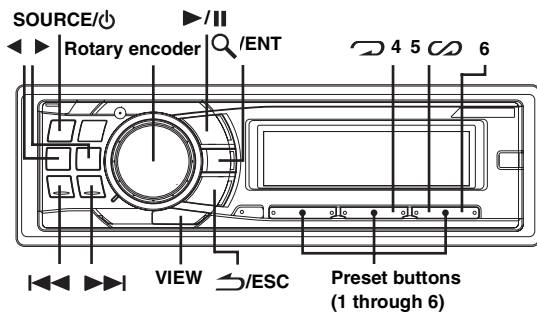

An iPod® can be connected to this unit by using the proprietary ALPINE FULL SPEED™ Connection Cable (KCE-422i) (sold separately). When this unit is connected by using the cable, the controls on the iPod are not functional.

- Set *AUX+ SETUP* to *OFF* when an iPod is connected (refer to “Setting the *AUX+ SETUP* Mode” on page 20).
- If the Bluetooth Box and an iPod are connected at the same time, be sure to disconnect the iPod from the Bluetooth Box while turning *ACC* to *OFF*.

## iPods usable with this unit

- The unit can be used with the fourth generation and above iPod, iPod photo, iPod mini or iPod nano. iPod Shuffle cannot be used, however.
- Touch wheel or scroll wheel type iPods without the dock connector cannot be connected to the unit.
- The unit can be used with the following iPod.

Fourth generation iPod  
Fifth generation iPod  
iPod photo  
iPod mini  
First generation iPod nano  
Second generation iPod nano

- If the unit is used with iPod software versions of iTunes earlier than 7.1.0.59, correct function and performance are not guaranteed.

## Playback

- 1 Press **SOURCE/⏻** to switch to the iPod mode.  
The mode will change every time the button is pressed.

TUNER → DISC → USB AUDIO → iPod\*<sup>1</sup>/AUX+\*<sup>2</sup> →  
BT AUDIO\*<sup>3</sup> → TUNER

- \*<sup>1</sup> Displayed only when the iPod is connected and *AUX+ SETUP* is set to *OFF*, refer to “Setting the *AUX+ SETUP* Mode” (page 20).  
\*<sup>2</sup> Displayed only when the *AUX+ SETUP* is set to *ON*, refer to “Setting the *AUX+ SETUP* Mode” (page 20).  
\*<sup>3</sup> Only when *BLUETOOTH IN* is set to *ADAPTE*, refer to “Setting the Bluetooth Connection” (page 18).

- 2 Press **⏮** or **⏭** to select the desired song.

**Return to the beginning of the current song:**  
Press **⏮**.

**Fast backward through current song:**  
Press and hold **⏮**.

**Advance to the beginning of the next song:**  
Press **⏭**.

**Fast forward through current song:**  
Press and hold **⏭**.

- 3 To pause playback, press **⏸**.  
Pressing **⏸** again will resume playback.

- A song playing on the iPod while it is connected to this unit will continue to play from where it was paused after disconnection.
- If you listen to an episode from a selected podcast or audiobook, the episode can be changed by pressing **⏮** or **⏭**.
- An episode may have several chapters. The chapter can be changed by pressing **⏮** or **⏭**.

## Searching for a desired Song

An iPod can contain hundreds of songs. By using file tag information and keeping these songs organised in playlists, this unit’s search functions will ease song searches. Each music category has its own individual hierarchy. Use the Playlist/Artist/Album/Song/ Podcast/ Genre/Composer/Audiobook search mode to narrow searches based on the table below.

Hierarchy 1	Hierarchy 2	Hierarchy 3	Hierarchy 4
Playlist	Song	—	—
Artist*	Album*	Song	—
Album*	Song	—	—
Song	—	—	—
Podcast	Episode	—	—
Genre*	Artist*	Album*	Song
Composer*	Album*	Song	—
Audiobook	—	—	—

For example: Searching by Artist name

The following example explains how an **ARTIST** search is performed. Another search mode can be used for the same operation, although the hierarchy differs.

- 1 Press **Q/ENT** to activate the search selection mode.
- 2 Turn the **Rotary encoder** to select the **ARTIST** search mode, and then press **Q/ENT**.  
PLAYLIST ↔ ARTIST ↔ ALBUM ↔ SONG ↔ PODCAST  
↔ GENRE ↔ COMPOSER ↔ AUDIOBOOK ↔ PLAYLIST
- 3 Turn the **Rotary encoder** to select the desired **Artist**, and then press **Q/ENT**.
- 4 Turn the **Rotary encoder** to select the desired **Album**, and then press **Q/ENT**.

## 5 Turn the Rotary encoder to select the desired Song, and then press **Q/ENT**.

The selected song is played back.

- After pressing and holding **Q/ENT** for at least 2 seconds while in each hierarchy (except Song and Audiobook hierarchy), all songs of the selected hierarchy are played back.
- After selecting [ALL] in the search mode with "\*", press and hold **Q/ENT** for at least 2 seconds to play back all songs in the iPod or selected search mode.
- While in the search mode, if you press and hold **↵/ESC** for 2 seconds, or no operation is performed for 10 seconds, the search mode is cancelled.
- In the search mode, pressing **↵/ESC** will return to the previous mode.
- When search is made during M.I.X. play, the M.I.X. play mode will be cancelled.
- "NO SONG" will be displayed if there are no songs in the selected playlist in the PLAYLIST search mode.
- "NO PODCAST" will be displayed if there is no podcast data in the iPod in the PODCAST search mode.
- "NO AUDIOBOOK" will be displayed if there is no audiobook data in the iPod in the AUDIOBOOK search mode.
- If "iPod name" stored in the iPod is selected in the desired Playlist search mode, and **Q/ENT** is pressed, you can search for all songs in the iPod. Also, if you press and hold **Q/ENT** for at least 2 seconds, all songs in the iPod are played back.
- Depending on the iPod, podcast search is not supported.
- If any one of the **preset buttons (1 through 6)** is pressed in the search mode, a search can be made quickly by skipping to the specified location. For details, refer to "Direct Search Function" on page 22.

## Quick Search

You can search a song from all songs in the iPod without selecting an album, artist, etc.

- 1 Press and hold **Q/ENT** for at least 2 seconds to activate the Quick Search mode.**
- 2 Turn the Rotary encoder to select a desired song.**  
The selected song is played back immediately.

- Press and hold **↵/ESC** for at least 2 seconds in the search mode to cancel. Or, the search mode is cancelled if no operation is performed for 10 seconds.
- If many songs are in the iPod, it takes time to search for songs.
- If any one of the **preset buttons (1 through 6)** is pressed in the search mode, a search can be made quickly by skipping to the specified location. For details, refer to "Direct Search Function" on page 22.
- This function is inactive during repeat (RPT) playback.

## Direct Search Function

The unit's direct search function can be used to search for an album, song, etc., more efficiently. In Playlist/Artist/Album/Song/Podcast/Genre/Composer/Audiobook mode, you can quickly target any song.

### In the search mode, press any one of the preset buttons (1 through 6) to quickly skip over a designated percent of your song content.

Song search example:

If there are 100 songs in your iPod, they are divided into 6 groups using percentages (shown below). These groups are assigned to the preset buttons (1 through 6).

Example 1:

Suppose the song you are searching for is located at around the middle (50%) of your library: press button 4 to jump to the 50th song and turn the Rotary encoder to find the desired song.

Example 2:

Suppose the song you are searching for is located near the end (83%) of your library: press button 6 to jump to the 83rd song and turn the Rotary encoder to find the desired song.

	All 100 songs (100%)					
	0%	17%	33%	50%	67%	83%
Preset buttons	1	2	3	4	5	6
Songs	First song	17th song	33rd song	50th song	67th song	83rd song

## Select Playlist/Artist/Album/Genre/Composer

Playlist/Artist/Album/Genre/Composer can be easily changed.

For example, if you listen to a song from a selected album, the album can be changed.

### Press **◀** or **▶** to select the desired Playlist/Artist/Album/Genre/Composer.

- If the song search mode was used to select a song, this function is inactive.
- If an album is selected during an artist search, other albums by that artist are searchable.
- This function is inactive during shuffle (M.I.X.) playback.



---

## Random Play Shuffle (M.I.X.)

---

The Shuffle function of the iPod is displayed as M.I.X. on this unit.

### Shuffle Albums:



The songs on each album are played back in proper order. Upon completion of all the songs on the album, the next album is selected randomly. This continues until all albums have been played.

### Shuffle Songs:

Song shuffle randomly plays back songs within a selected category (playlist, album, etc.). The songs within the category are played just once until all songs have been played.

#### 1 Press 5 .

The songs are played back in random sequence.

 M.I.X. → M.I.X. → (off) →  M.I.X.  
(Shuffle Albums) (Shuffle Songs)

#### 2 To cancel M.I.X. play, select (off) with the above procedure.

- If a song is selected in the album search mode before selecting M.I.X. play, the songs will not play back randomly even when Shuffle Albums is selected.

### Shuffle ALL:

Shuffle ALL plays all songs in the iPod randomly. Any one song does not play back again until all songs have been played back.

#### 1 Press 6.

The songs are played back in random sequence.

M.I.X. → (off) → M.I.X.  
(Shuffle ALL)

#### 2 To cancel M.I.X. play, select (off) with the above procedure.

- If Shuffle ALL is selected, the selected songs being played back in the search mode are cancelled.

---

## Repeat Play

---

Only Repeat One is available for the iPod.

### Repeat One:



A single song is repeatedly played back.

#### 1 Press 4.

The song is played back repeatedly.

RPT → (off) → RPT  
(Repeat One)

#### 2 To cancel repeat play, select (off) with the above procedure.

- During repeat playback, no other songs are selectable by pressing  or .

---

## Displaying the Text

---

You can display the tag information of a song in the iPod.

### Press VIEW.

Each press changes the display.

- When the TEXT SCROLL is set to MANU, press and hold VIEW for at least 2 seconds, the current text will be scrolled one time.

TRACK NO./ELAPSED TIME → ARTIST NAME\* →  
ALBUM NAME\* → SONG NAME\* →  
TRACK NO./ELAPSED TIME

#### \* TAG information

“ARTIST”/“ALBUM”/“SONG” is displayed if there is no tag information.

- Only alphanumeric characters (ASCII) can be displayed.
- If the artist, album or song name, created in iTunes, has too many characters, songs may not be played back when connected to the adapter. Therefore, a maximum of 250 characters is recommended. The maximum number of characters for the head unit is 128 (128 byte).
- Some characters may not be correctly displayed.
- “NO SUPPORT” is displayed if text information is not supported by the unit.

# Information

## In Case of Difficulty

If you encounter a problem, please turn the power off, then on again. If the unit is still not functioning normally, please review the items in the following checklist. This guide will help you isolate the problem if the unit is at fault. Otherwise, make sure the rest of your system is properly connected or consult your authorized Alpine dealer.

### Basic

#### No function or display.

- Vehicle's ignition is off.
  - If connected following instructions, the unit will not operate with the vehicle's ignition off.
- Improper power lead (Red) and battery lead (Yellow) connections.
  - Check power lead and battery lead connections.
- Blown fuse.
  - Check the fuse of the unit; replace with the proper value if necessary.
- Internal micro-computer malfunctioned due to interference noise etc.
  - Press the RESET switch with a ballpoint pen or other pointed article.

### Radio

#### Unable to receive stations.

- No antenna or open connection in cable.
  - Make sure the antenna is properly connected; replace the antenna or cable if necessary.

#### Unable to tune stations in the seek mode.

- You are in a weak signal area.
  - Make sure the tuner is in the DX mode.
- If the area you are in is a primary signal area, the antenna may not be grounded and connected properly.
  - Check your antenna connections; make sure the antenna is properly grounded at its mounting location.
- The antenna may not be the proper length.
  - Make sure the antenna is fully extended; if broken, replace the antenna with a new one.

#### Broadcast is noisy.

- The antenna is not the proper length.
  - Extend the antenna fully; replace it if it is broken.
- The antenna is poorly grounded.
  - Make sure the antenna is grounded properly at its mounting location.

### CD

#### CD Player not functioning.

- Out of operating temperature range +50°C (+120°F) for CD.
  - Allow the vehicle's interior (or trunk) temperature to cool.

#### CD playback sound is wavering.

- Moisture condensation in the CD Module.
  - Allow enough time for the condensation to evaporate (about 1 hour).

#### CD insertion not possible.

- A CD is already in the CD player.
  - Eject the CD and remove it.
- The CD is being improperly inserted.
  - Make sure the CD is being inserted following instructions in the CD Player Operation section.

#### Unable to fast forward or backward the CD.

- The CD has been damaged.
  - Eject the CD and discard it; using a damaged CD in your unit can cause damage to the mechanism.

#### CD playback sound skips due to vibration.

- Improper mounting of the unit.
  - Securely re-mount the unit.
- The disc is very dirty.
  - Clean the disc.
- The disc has scratches.
  - Change the disc.
- The pick-up lens is dirty.
  - Do not use a commercially available lens cleaner disc. Consult your nearest Alpine dealer.

#### CD playback sound skips without vibration.

- The disc is dirty or scratched.
  - Clean the disc; damaged disc should be replaced.

#### Error displays (built-in CD player only).

- Mechanical error.
  - Press . After the error indication disappears, insert the disc again. If the above-mentioned solution does not solve the problem, consult your nearest Alpine dealer.

#### CD-R/CD-RW playback not possible.

- Close session (finalization) has not been performed.
  - Perform finalization and attempt playback again.

### MP3/WMA/AAC

#### MP3, WMA or AAC is not played back.

- Writing error occurred. The MP3/WMA/AAC format is not compatible.
  - Make sure the MP3/WMA/AAC has been written in a supported format. Refer to "About MP3/WMA/AAC" (pages 13-14), then rewrite in the format supported by this device.

### Audio

#### The sound is not output from the speakers.

- Unit has no output signal of the internal amplifier.
  - POWER IC is switched to "ON" (page 19).

### iPod

#### iPod does not play and no sound is output.

- The iPod has not been recognized.
  - Reset this unit and the iPod. Refer to "Initial System Start-Up" (page 7). To reset the iPod, refer to the Owner's Manual of the iPod.

## Indication for CD Player

### NO DISC

- No CD is inserted.
  - Insert a CD.
- Although a disc is inserted, "NO DISC" is displayed and the unit does not start to play or eject the disc.
  - Remove the disc by following these steps:  
Press the ▲ button again for at least 2 seconds.  
If the disc still does not eject, consult your Alpine dealer.

### ERROR

- Mechanism error.
  - 1) Press the ▲ button and eject the CD.  
If not ejecting, consult your Alpine dealer.
  - 2) When the error indication remains after ejecting, press the ▲ button again.  
If the error indication still does not turn off after pressing the ▲ button for a few times, consult your Alpine dealer.
- When "ERROR" is displayed:  
*If the disc cannot be ejected by pressing ▲, press the RESET switch (refer to page 7) and press ▲ again.  
If the disc still cannot be ejected, consult your Alpine dealer.*

### PROTECT

- A copy-protected WMA file was played back.
  - You can only play back non-copy-protected files.

### UNSUPPORTED

- A sampling rate/bit rate not supported by the unit is used.
  - Use a sampling rate/bit rate that is supported by the unit.

## Indication for USB memory

### ERROR

- Abnormal current is run to the USB connector device (an error message may be displayed if the USB device that is not compatible with the unit is connected).  
USB memory is a malfunction or it is shorted.
  - Connect another USB memory.

### DEVICE ERROR

- A USB device that is not supported by the unit is connected.
  - Connect a USB device that is supported by the unit.

### NO USB UNIT

- A USB memory is not connected.
  - Make sure the USB memory device is correctly connected and the cable is not excessively bent.

### NO FILE

- No song (file) is stored in the USB memory.
  - Connect the USB memory device after storing songs (files).

### UNSUPPORTED

- A sampling rate/bit rate not supported by the unit is used.
  - Use a sampling rate/bit rate that is supported by the unit.

### PROTECT

- A copy-protected WMA file was played back.
  - You can only play back non-copy-protected files.

### NO SUPPORT

- Text information that is not recognizable by the unit has been input.
  - Use a USB memory device with input text information that is supported by the unit.

## Indication for iPod Mode

### NO iPod

- The iPod is not connected.
  - Make sure the iPod is correctly connected (refer to "Connections").  
Make sure the cable is not bent excessively.

### NO SONG

- There are no songs in the iPod.
  - Download songs to the iPod and connect to this unit.

### ERROR-01

- Communication error
  - Turn the ignition key off, and then set to ON again.
  - Check the display by reconnecting between the iPod and this unit, using the iPod cable.

### ERROR-02

- Caused by the iPod Software Version not being compatible with this unit.
  - Update the iPod Software Version to be compatible with this unit.

## Specifications

### FM TUNER SECTION

Tuning Range	87.5-108.0 MHz
Mono Usable Sensitivity	0.7 $\mu$ V
Alternate Channel Selectivity	80 dB
Signal-to-Noise Ratio	65 dB
Stereo Separation	35 dB
Capture Ratio	2.0 dB

### MW TUNER SECTION

Tuning Range	531-1,602 kHz
Sensitivity (IEC Standard)	25.1 $\mu$ V/28 dB

### LW TUNER SECTION

Tuning Range	153-281 kHz
Sensitivity (IEC Standard)	31.6 $\mu$ V/30 dB

### CD PLAYER SECTION

Frequency Response	5-20,000 Hz ( $\pm$ 1 dB)
Wow & Flutter (% WRMS)	Below measurable limits
Total Harmonic Distortion	0.008% (at 1 kHz)
Dynamic Range	95 dB (at 1 kHz)
Signal-to-Noise Ratio	105 dB
Channel Separation	85 dB (at 1 kHz)

### PICKUP

Wave length	795 nm
Laser power	CLASS I

### USB SECTION

USB requirements	USB 1.1/2.0
Max. Power Consumption	500 mA
USB Class	Mass Storage
File System	FAT 12/16/32
MP3 Decoding	MPEG-1/2 AUDIO Layer-3
WMA Decoding	Windows Media™ Audio
AAC Decoding	AAC-LC format “.m4a” file
Number of Channels	2-Channel (Stereo)
Frequency Response*	5-20,000 Hz ( $\pm$ 1 dB)
Total Harmonic Distortion	0.008% (at 1 kHz)
Dynamic Range	95 dB (at 1 kHz)
Signal-to-Noise Ratio	105 dB
Channel Separation	85 dB (at 1 kHz)

\* Frequency response may differ depending on the encoder software/bit rate.

### GENERAL

Power Requirement	14.4 V DC (11-16 V allowable)
Maximum Power Output	50 W $\times$ 4
Maximum Pre-Output Voltage	2 V/10 k ohms
Bass	$\pm$ 14 dB at 60 Hz
Treble	$\pm$ 14 dB at 10 kHz
Weight	1.5 kg (3 lbs. 4 oz)

### CHASSIS SIZE

Width	178 mm (7")
Height	50 mm (2")
Depth	160 mm (6-1/4")

### NOSEPIECE SIZE

Width	170 mm (6-3/4")
Height	46 mm (1-13/16")
Depth	24 mm (15/16")

- Due to continuous product improvement, specifications and design are subject to change without notice.

## CAUTION

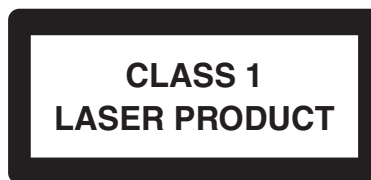

(Bottom side of player)

---

---

# Installation and Connections

Before installing or connecting the unit, please read the following and pages 3 and 5 of this manual thoroughly for proper use.

## Warning

---

### MAKE THE CORRECT CONNECTIONS.

Failure to make the proper connections may result in fire or product damage.

---

### USE ONLY IN CARS WITH A 12 VOLT NEGATIVE GROUND.

(Check with your dealer if you are not sure.) Failure to do so may result in fire, etc.

---

### BEFORE WIRING, DISCONNECT THE CABLE FROM THE NEGATIVE BATTERY TERMINAL.

Failure to do so may result in electric shock or injury due to electrical shorts.

---

### DO NOT SPLICE INTO ELECTRICAL CABLES.

Never cut away cable insulation to supply power to other equipment. Doing so will exceed the current carrying capacity of the wire and result in fire or electric shock.

---

### DO NOT DAMAGE PIPE OR WIRING WHEN DRILLING HOLES.

When drilling holes in the chassis for installation, take precautions so as not to contact, damage or obstruct pipes, fuel lines, tanks or electrical wiring. Failure to take such precautions may result in fire.

---

### DO NOT USE BOLTS OR NUTS IN THE BRAKE OR STEERING SYSTEMS TO MAKE GROUND CONNECTIONS.

Bolts or nuts used for the brake or steering systems (or any other safety-related system), or tanks should NEVER be used for installations or ground connections. Using such parts could disable control of the vehicle and cause fire etc.

---

### KEEP SMALL OBJECTS SUCH AS BATTERIES OUT OF THE REACH OF CHILDREN.

Swallowing them may result in serious injury. If swallowed, consult a physician immediately.

---

### DO NOT INSTALL IN LOCATIONS WHICH MIGHT HINDER VEHICLE OPERATION, SUCH AS THE STEERING WHEEL OR SHIFT LEVER.

Doing so may obstruct forward vision or hamper movement etc. and results in serious accident.

## Caution

---

### HAVE THE WIRING AND INSTALLATION DONE BY EXPERTS.

The wiring and installation of this unit requires special technical skill and experience. To ensure safety, always contact the dealer where you purchased this product to have the work done.

---

### USE SPECIFIED ACCESSORY PARTS AND INSTALL THEM SECURELY.

Be sure to use only the specified accessory parts. Use of other than designated parts may damage this unit internally or may not securely install the unit in place. This may cause parts to become loose resulting in hazards or product failure.

---

### ARRANGE THE WIRING SO IT IS NOT CRIMPED OR PINCHED BY A SHARP METAL EDGE.

Route the cables and wiring away from moving parts (like the seat rails) or sharp or pointed edges. This will prevent crimping and damage to the wiring. If wiring passes through a hole in metal, use a rubber grommet to prevent the wire's insulation from being cut by the metal edge of the hole.

---

### DO NOT INSTALL IN LOCATIONS WITH HIGH MOISTURE OR DUST.

Avoid installing the unit in locations with high incidence of moisture or dust. Moisture or dust that penetrates into this unit may result in product failure.

---

## Precautions

- Be sure to disconnect the cable from the (-) battery post before installing your CDE-9880R/CDE-9882Ri. This will reduce any chance of damage to the unit in case of a short-circuit.
- Be sure to connect the colour coded leads according to the diagram. Incorrect connections may cause the unit to malfunction or damage to the vehicle's electrical system.
- When making connections to the vehicle's electrical system, be aware of the factory installed components (e.g. on-board computer). Do not tap into these leads to provide power for this unit. When connecting the CDE-9880R/CDE-9882Ri to the fuse box, make sure the fuse for the intended circuit of the CDE-9880R/CDE-9882Ri has the appropriate amperage. Failure to do so may result in damage to the unit and/or the vehicle. When in doubt, consult your Alpine dealer.
- The CDE-9880R/CDE-9882Ri uses female RCA-type jacks for connection to other units (e.g. amplifier) having RCA connectors. You may need an adaptor to connect other units. If so, please contact your authorized Alpine dealer for assistance.
- Be sure to connect the speaker (-) leads to the speaker (-) terminal. Never connect left and right channel speaker cables to each other or to the vehicle body.

---

#### IMPORTANT

Please record the serial number of your unit in the space provided below and keep it as a permanent record. The serial number or the engraved serial number is located on the bottom of the unit.

SERIAL NUMBER: \_\_\_\_\_

INSTALLATION DATE: \_\_\_\_\_

INSTALLATION TECHNICIAN: \_\_\_\_\_

PLACE OF PURCHASE: \_\_\_\_\_

# Installation

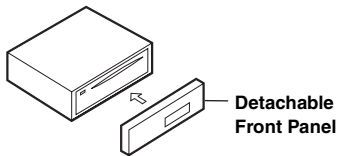

### Caution

When you install this unit in your car, do not remove the detachable front panel. If the detachable front panel is removed during installation, you might press too hard and warp the metal plate that holds it in place.

- The main unit must be mounted within 35 degrees of the horizontal plane, back to front.

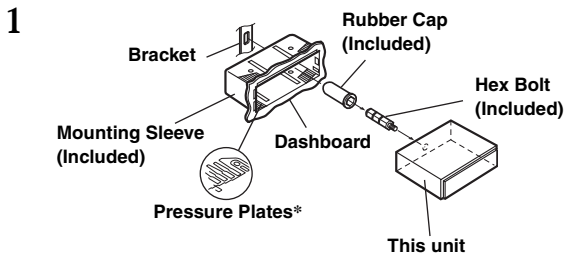
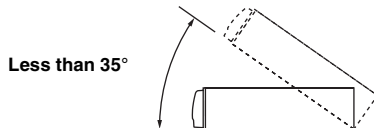

- \* If the installed mounting sleeve is loose in the dashboard, the pressure plates may be bent slightly to remedy the problem.

**Remove the mounting sleeve from the main unit (see "Removal" on page 28). Slide the mounting sleeve into the dashboard and fix it with the metal shackles.**

2

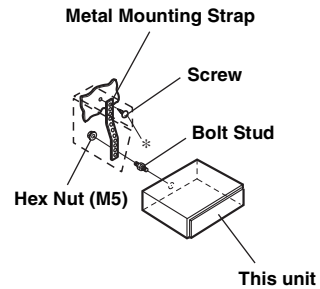

When your vehicle has the Bracket, mount the long hex bolt onto the rear panel of the CDE-9880R/CDE-9882Ri and put the Rubber Cap on the hex bolt. If your vehicle does not have the Mounting Support, reinforce the head unit with the metal mounting strap (not supplied). Connect all other leads of the CDE-9880R/CDE-9882Ri according to details described in the CONNECTIONS section.

- For the screw \*, provide a proper screw to the chassis installing location.

3 Slide the CDE-9880R/CDE-9882Ri into the dashboard. When the unit is in place, make sure the locking pins are fully seated in the down position. This can be done by pressing firmly in on the unit while pushing the locking pin down with a small screwdriver. This ensures that the unit is properly locked and will not accidentally come out from the dashboard. Install the detachable front panel.

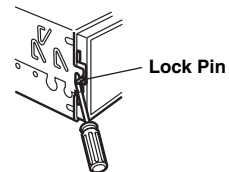

### Removal

- Remove the detachable front panel.
- Use a small screwdriver (or similar tool) to push the locking pins to the "up" position (see above drawing). As each pin is unlocked, gently pull out on the unit to make sure it does not re-lock before unlocking the second pin.
- Pull the unit out, keeping it unlocked as you do so.

## <JAPANESE CAR>

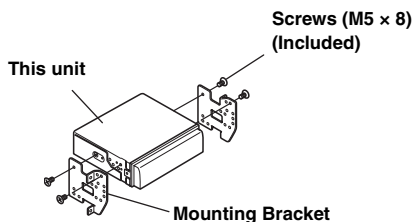
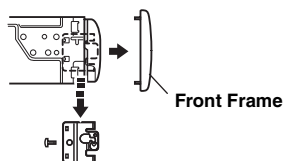

### **USB memory Connection (sold separately)**

#### **Connect USB memory**

Connect USB memory to USB cable.

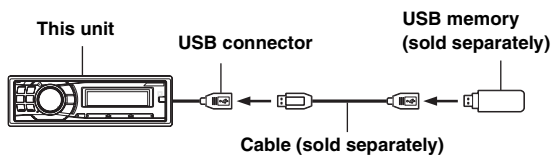

#### **Remove USB memory**

Pull out USB memory squarely from the USB cable.

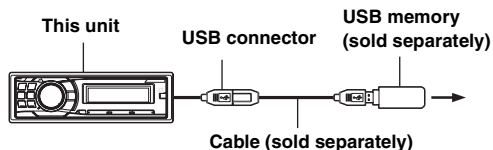

- When removing USB memory, pull it out straight.
- If sound is not output or USB memory is not recognized even when USB memory is connected, remove USB memory once, then connect it again.
- Change to a source other than the USB memory mode, then remove the USB memory. If the USB memory is removed in the USB memory mode, data may be damaged.
- Route the USB cable away from another cables, etc.

# Connections

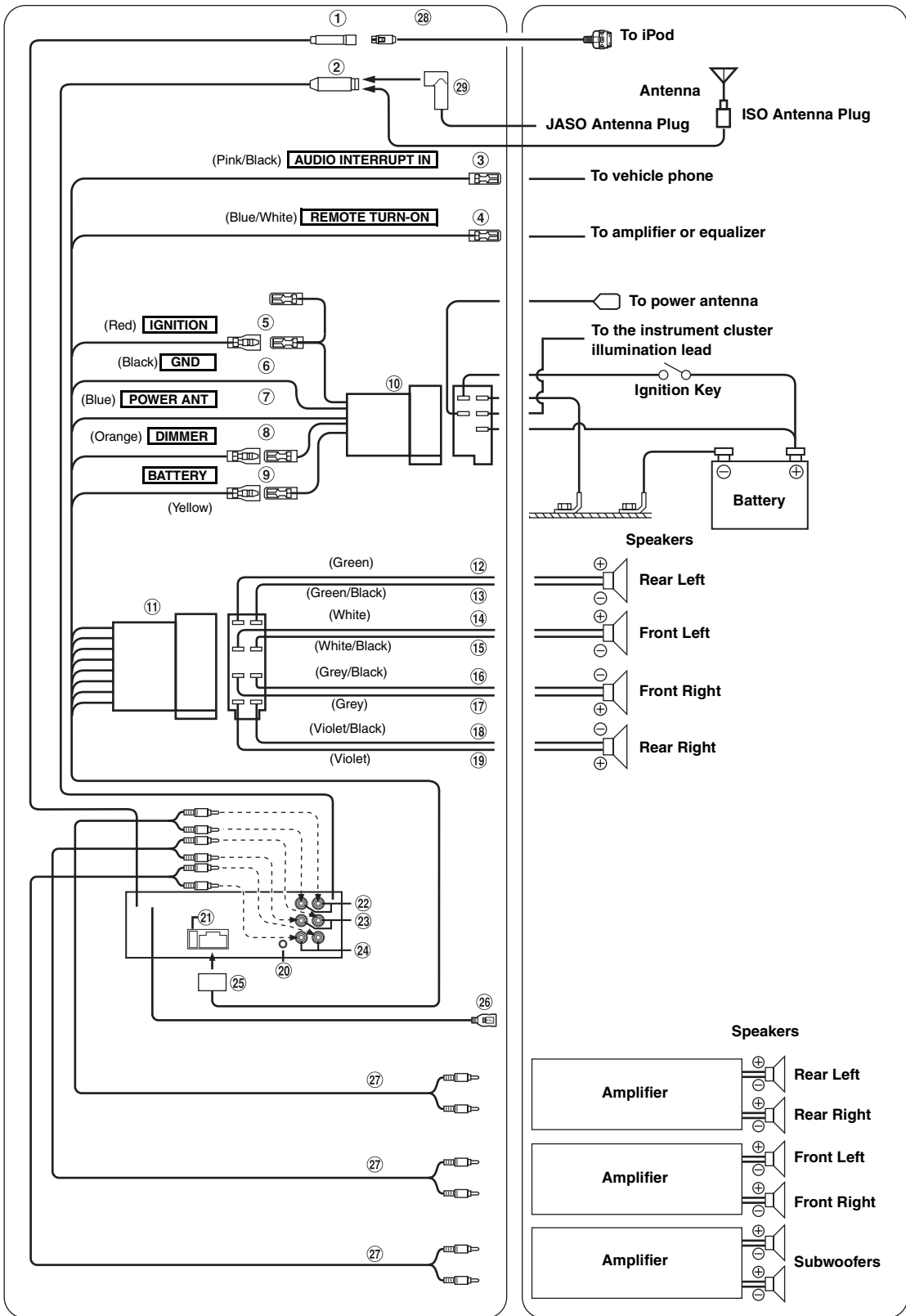



① **iPod Direct Connector**

Control iPod signals.  
Connect this to an iPod by using the FULL SPEED™ Connection Cable (KCE-422i) (sold separately) or connect this to an external device (such as a portable player) by using iPod Direct/RCA Interface cable (sold separately).

\* Refer to "Setting the AUX+ SETUP Mode" (page 20).

AUX+ON : When the external device is connected.  
AUX+OFF : When an iPod is connected.

② **Antenna Receptacle**

③ **Audio Interrupt In Lead (Pink/Black)**

Connect this lead to the Audio Interface output of a cellular phone which provides ground shorting when a call is received.

④ **Remote Turn-On Lead (Blue/White)**

Connect this lead to the remote turn-on lead of your amplifier or signal processor.

⑤ **Switched Power Lead (Ignition) (Red)**

Connect this lead to an open terminal on the vehicle's fuse box or another unused power source which provides (+) 12V only when the ignition is turned on or in the accessory position.

⑥ **Ground Lead (Black)**

Connect this lead to a good chassis ground on the vehicle. Make sure the connection is made to bare metal and is securely fastened using the sheet metal screw provided.

⑦ **Power Antenna Lead (Blue)**

Connect this lead to the +B terminal of your power antenna, if applicable.

• *This lead should be used only for controlling the vehicle's power antenna. Do not use this lead to turn on an amplifier or a signal processor, etc.*

⑧ **Dimmer Lead (Orange)**

This lead may be connected to the vehicle's instrument cluster illumination lead. This will enable the vehicle's dimmer control to dim the backlighting of the unit.

⑨ **Battery Lead (Yellow)**

Connect this lead to the positive (+) post of the vehicle's battery.

⑩ **ISO Power Supply Connector**

⑪ **ISO Connector (Speaker Output)**

⑫ **Left Rear (+) Speaker Output Lead (Green)**

⑬ **Left Rear (-) Speaker Output Lead (Green/Black)**

⑭ **Left Front (+) Speaker Output Lead (White)**

⑮ **Left Front (-) Speaker Output Lead (White/Black)**

⑯ **Right Front (-) Speaker Output Lead (Grey/Black)**

⑰ **Right Front (+) Speaker Output Lead (Grey)**

⑱ **Right Rear (-) Speaker Output Lead (Violet/Black)**

⑲ **Right Rear (+) Speaker Output Lead (Violet)**

⑳ **Steering Remote Control Interface Connector**

To steering remote control interface box.

㉑ **Fuse Holder (10A)**

㉒ **Rear Output RCA Connectors**

RED is right and WHITE is left.

㉓ **Front Output RCA Connectors**

RED is right and WHITE is left.

㉔ **Subwoofer Output RCA Connectors**

RED is right and WHITE is left.

㉕ **Power Supply Connector**

㉖ **USB Connector**

Connect USB cable.

㉗ **RCA Extension Cable (sold separately)**

㉘ **FULL SPEED™ Connection Cable (KCE-422i) (CDE-9880R, sold separately; CDE-9882Ri supplied)**

㉙ **ISO/JASO Antenna Adaptor (sold separately)**

An ISO/JASO antenna adaptor may be required, depending on the vehicle.

**To prevent external noise from entering the audio system.**

- Locate the unit and route the leads at least 10 cm away from the car harness.
- Keep the battery power leads as far away from other leads as possible.
- Connect the ground lead securely to a bare metal spot (remove any paint, dirt or grease if necessary) of the car chassis.
- If you add an optional noise suppressor, connect it as far away from the unit as possible. Your Alpine dealer carries various noise suppressors, contact them for further information.
- Your Alpine dealer knows best about noise prevention measures so consult your dealer for further information.

## Free Manuals Download Website

<http://myh66.com>

<http://usermanuals.us>

<http://www.somanuals.com>

<http://www.4manuals.cc>

<http://www.manual-lib.com>

<http://www.404manual.com>

<http://www.luxmanual.com>

<http://aubethermostatmanual.com>

Golf course search by state

<http://golfingnear.com>

Email search by domain

<http://emailbydomain.com>

Auto manuals search

<http://auto.somanuals.com>

TV manuals search

<http://tv.somanuals.com>