



DVA-5205P

DVD/VIDEO CD/ CD PLAYER

- **OWNER'S MANUAL (Page 2-71)**
Please read this manual to maximize your enjoyment of the outstanding performance and feature capabilities of the equipment, then retain the manual for future reference.
- **MODE D'EMPLOI (Page 72-141)**
Veuillez lire ce mode d'emploi pour tirer pleinement profit des excellentes performances et fonctions de cet appareil, et conservez-le pour toute référence future.
- **MANUAL DE OPERACION (Página 142-211)**
Lea este manual, por favor, para disfrutar al máximo de las excepcionales prestaciones y posibilidades funcionales que ofrece el equipo, luego guarde el manual para usarlo como referencia en el futuro.





Precautions



Warning

This symbol means important instructions.

Failure to heed them can result in serious injury or death.

DO NOT DISASSEMBLE OR ALTER. Doing so may result in an accident, fire or electric shock.

KEEP SMALL OBJECTS SUCH AS BATTERY OUT OF THE REACH OF CHILDREN. Swallowing them may result in serious injury. If swallowed, consult a physician immediately.

USE THE CORRECT AMPERE RATING WHEN REPLACING FUSES. Failure to do so may result in fire or electric shock.

USE ONLY IN CARS WITH A 12 VOLT NEGATIVE GROUND. (Check with your dealer if you are not sure.) Failure to do so may result in fire, etc.

DO NOT OPERATE ANY FUNCTION THAT TAKES YOUR ATTENTION AWAY FROM SAFELY DRIVING YOUR VEHICLE. Any function that requires your prolonged attention should only be performed after coming to a complete stop. Always stop the vehicle in a safe location before performing these functions. Failure to do so may result in an accident.

DO NOT WATCH VIDEO WHILE DRIVING. Watching the video may distract the driver from looking ahead of the vehicle and cause an accident.

KEEP THE VOLUME AT A LEVEL WHERE YOU CAN STILL HEAR OUTSIDE NOISE WHILE DRIVING. Failure to do so may result in an accident.

USE THIS PRODUCT FOR MOBILE 12V APPLICATIONS. Use for other than its designed application may result in fire, electric shock or other injury.

DO NOT PLACE HANDS, FINGERS OR FOREIGN OBJECTS IN INSERTION SLOTS OR GAPS. Doing so may result in personal injury or damage to the product.

DO NOT BLOCK VENTS OR RADIATOR PANELS. Doing so may cause heat to build up inside and may result in fire.



 **Caution**

This symbol means important instructions.

Failure to heed them can result in injury or property damage.

DO NOT MIX NEW BATTERIES WITH OLD BATTERIES. INSERT WITH THE CORRECT BATTERY POLARITY. When inserting the batteries, be sure to observe proper polarity (+ and -) as instructed. Rupture or chemical leakage from the battery may cause fire or personal injury.

HALT USE IMMEDIATELY IF A PROBLEM APPEARS. Failure to do so may cause personal injury or damage to the product. Return it to your authorized Alpine dealer or the nearest Alpine Service Center for repairing.





Precautions

Temperature

Be sure the temperature inside the vehicle is between +60°C (+140°F) and -10°C (+14°F) before turning your unit on.

Moisture Condensation

You may notice the CD playback sound wavering due to condensation. If this happens, remove the disc from the player and wait about an hour for the moisture to evaporate.

Damaged Disc

Do not attempt to play cracked, warped, or damaged discs. Playing a bad disc could severely damage the playback mechanism.

Maintenance

If you have problems, do not attempt to repair the unit yourself. Return it to your Alpine dealer or the nearest Alpine Service Station for servicing.

Never Attempt the Following

Do not grip or pull out the disc while it is being pulled back into the player by the automatic reloading mechanism.

Do not attempt to insert a disc into the unit when the unit power is off.

Inserting Discs

Your player accepts only one disc at a time for playback. Do not attempt to load more than one disc.

Make sure the label side is facing up when you insert the disc. Your player will automatically eject any disc that is inserted incorrectly.

Playing a disc while driving on a very bumpy road may result in skips, but this will not scratch the disc or damage the player.

Irregular Shaped Discs

Make sure the discs you use in this unit do not have any irregularities. The outer and inner edges should be round and smooth. Use of irregularly shaped discs may cause damage to the mechanism.

New Discs

As a protective measure to prevent the CD from jamming, the CD player will automatically eject discs with irregular surfaces or inserted incorrectly. When a new disc is inserted into the player and ejected after initial loading, using your finger, feel around the inside of the centre hole and outside edge of the disc. If you feel any small bumps or irregularities, this could inhibit proper loading of the disc. To remove the bumps, rub the inside edge of the hole and outside edge of the disc with a ball-point pen or other such instrument, then insert the disc again.

Installation Location

Make sure the DVA-5205P will not be installed in a location subjected to:

- Direct sun and heat
- High humidity and water
- Excessive dust
- Excessive vibrations



Precautions

Warnings and Cautions	2
Contents	5



Quick Guide

About DVDs	6
Discs playable on this DVD player	7
When using remote control	8
Loading and unloading discs	9
Turning the power on and off	10
Switching between NTSC and PAL configuration	11
Adjusting the volume	11
Playing discs	12
Stopping playback	13
Fast-forwarding/fast-reversing	14
Finding the beginnings of chapters or tracks	14
Playing still frames (pausing)	15
Frame-by-frame playback	15
Slow motion playback	15



Convenient Functions

Searching by title number	16
Searching directly by chapter or track number ..	17
Searching by elapsed time	18
Chapter/track/title repeat playback	19
Switching the audio language	19
Switching the angle	20
Switching the subtitles (subtitle language)	20
Displaying the subtitles	21
Displaying the disc status	21
Video output ON/OFF	23

SET UP

Changing the Default Settings

Changing the default settings (setup)	24
Changing the language settings	24
Changing the TV screen settings	26
Changing the country code setting	27
Setting the rating level (parental lock)	28
Changing the downsampling setting	30
Changing the digital output setting	32
Changing the LED indicator setting	34

Custom setting – Changing the Closed Caption setting	35
Custom setting – Changing the Ai-NET settings	36
Custom setting – Changing the H.U. Control settings	38



Digital Audio Processor (Optional)

Operating the digital audio processor (optional)	40
Adjusting the parametric equalizer	41
Adjusting the surround settings	42
Storing the surround settings	43
Recalling the surround settings	44
Adjusting the time compensation	45
Using the Pro Logic mode	45
ADJUST – Setting the speaker mode	46
ADJUST – Adjusting the acoustic image ...	47
ADJUST – Mixing the rear audio channels	48
ADJUST – Center speaker time compensation	49
ADJUST – Rear speaker time compensation ...	50
ADJUST – Achieving powerful sound at low volumes ..	51
ADJUST – Adjusting the speaker level	52
MODE – Adjusting the volume, fader and balance	53
MODE – Adjusting the subwoofer	54
MODE – Turning the defeat function on and off	55



Operating from the Head Unit (CDA-7865R)

Operating from the head unit	56
Operating from the head unit's remote control unit	58

Others

Terminology	60
List of language codes	61
List of country codes	63
In case of difficulty	66
Specifications	67
Functions of remote control unit buttons ...	68



About DVDs

Music CDs and DVDs have grooves (tracks) in which the digital data is recorded. The data is represented as microscopic pits recorded into the track – these pits are read by a laser beam to play the disc. On DVDs, the density of the tracks and pits is twice that of CDs, so DVDs can contain more data in less space.

CD-ROMs

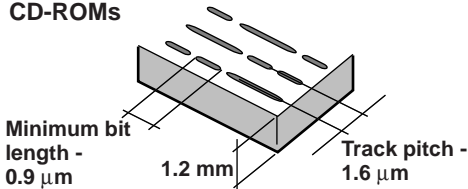

DVDs

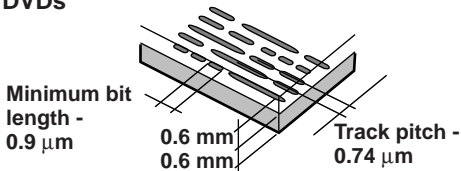

A 12 cm disc can contain one movie or about four hours of music.

In addition, DVDs provide sharp picture quality with vivid colors thanks to a horizontal resolution of over 500 lines (compared to less than 300 for VHS tape). With the addition of an optional, digital audio processor (PXA-H510), you can recreate the power and presence of a movie theater with Dolby Digital 5.1-channel Surround.

Moreover, DVDs offer a variety of functions.

- **Multiple audio*** (page 19)

Movies can be recorded in up to eight languages. The desired language can be selected from the remote control unit.

- **Subtitles function*** (page 20)

Movies can include subtitles in up to 32 languages. The desired subtitle language can be selected from the remote control unit.

- **Multi angle function*** (page 20)

When the DVD contains a movie shot from multiple angles, the desired angle can be selected from the remote control unit.

- **Multi story function***

With this function, a single movie includes various story lines. You can select different story lines to view various versions of the same movie. Operation differs from disc to disc. Story line selection screens including instructions appear during the movie. Just follow the instructions.

Note: * The functions audio languages, subtitle languages, angles, etc., differ from disc to disc. For details, refer to the disc's instructions.



Discs playable on this DVD player

• Playable discs

The discs listed below can be played on this DVD player. Other discs cannot be played.

	Mark (logo)	Recorded content	Disc size	Max. playing time
DVD Video		Audio + Video (Moving pictures)	12 cm*	One-sided disc Approx. 4 hours
				Two-sided disc Approx. 8 hours
			8 cm	One-sided disc Approx. 80 Minutes
				Two-sided disc Approx. 160 Minutes
Video CD		Audio + Video (Moving pictures)	12 cm	Approx. 74 Minutes
			8 cm	Approx. 20 Minutes
Music CD		Audio	12 cm	Approx. 74 Minutes
			8 cm (CD single)	Approx. 20 Minutes

* Two-layer DVD disc compatible

• Discs that cannot be played

DVD-ROMs, DVD-R/DVD-RAMs, CD-ROMs, CD-R/CD-RWs, photo CDs, etc.

• DVD region number (playable region number)

This DVD player will playback any disc whose region number is 2 (or All). DVDs on which you do not find a region number "2" or mark "ALL" listed below, cannot be played on this DVD player.



• Video CDs

This DVD player is compatible with playback control (PBC) compatible video CDs (version 2.0).

"PBC" is a function by which you can use menu screens recorded on the disc to find the scene you want to watch and view various types of information in dialog style.

• Disc terminology

Title

If titles are programmed for the DVD, these are the largest unit of division of the information recorded on the disc.

Chapter

Each Title may also be divided into smaller divisions called Chapters. These can be specific scenes or musical selections.

* This product incorporates copyright protection technology that is protected by method claims of certain U.S. patents and other intellectual property rights owned by Macrovision Corporation and other rights owners. Use of this copyright protection technology must be authorized by Macrovision Corporation, and is intended for home and other limited viewing uses only unless otherwise authorized by Macrovision Corporation. Reverse engineering or disassembly is prohibited.

* **Manufactured under license from Dolby Laboratories. "Dolby", "Pro Logic" and the double-D symbol are trademarks of Dolby Laboratories.**

* **"DTS" and "DTS Digital Out" are trademarks of Digital Theater Systems, inc.**





When using remote control

When using remote control

• Mode Switch

To operate the DVD Player, make sure the mode switch is on "DVD". DVD operations are shown as the blue characters on the remote control unit.

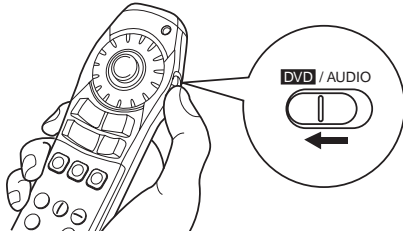

Switching to "AUDIO" mode, makes it possible to operate Alpine audio products as well. Audio operations are shown as the white characters on the remote control unit.

- Point the remote control at the remote sensor within about 2 meter.
- It may not be possible to operate the remote control unit if the remote control sensor is exposed to direct sunlight.
- The remote control is a small, light weight precision device. To avoid damage, short battery life, operational errors and poor button response, observe the following.
 - Do not apply any shock.
 - Do not put in a trouser pocket.
 - Keep away from food, moisture and dirt.
 - Do not place in direct sunshine.

Replacing the batteries

- 1 Opening the battery cover**
Push on the cover and slide it as indicated by the arrows then the cover will be removed.

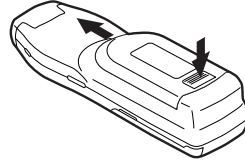

- 2 Replacing the battery**
Remove the old batteries. Insert new ones matching the (+) and (-) polarities as shown in the diagram inside the remote control.

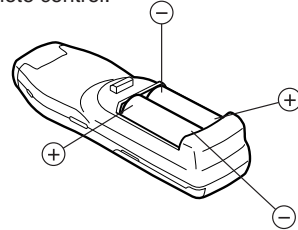

- 3 Closing the cover**
Push the cover in the arrow direction until a click is heard.

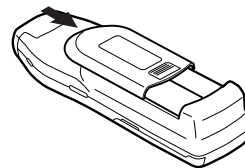

Note: Use two AA size batteries.



Warning

DO NOT OPERATE ANY FUNCTION THAT TAKES YOUR ATTENTION AWAY FROM SAFELY DRIVING YOUR VEHICLE. Any function that requires your prolonged attention should only be performed after coming to a complete stop. Always stop the vehicle in a safe location before performing these functions. Failure to do so may result in an accident.



Loading and unloading discs



Turn on the power before loading and unloading discs.
(Refer to page 10 "Turning the power on and off".)

Loading discs

- 1 Press the door in gently then slide it downwards.**

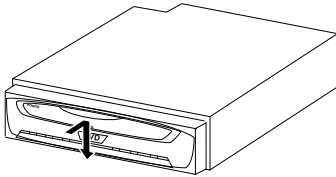

- 2 Insert the disc with the side containing words or diagrams facing upwards.**

Once the disc is partially inserted, it is drawn in automatically. Playback starts.

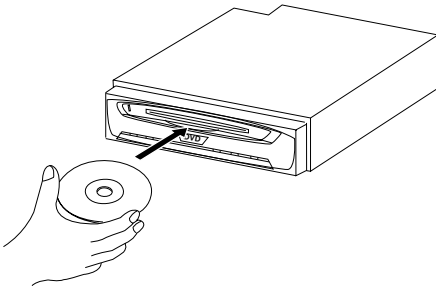

- 3 Close the door.**
Be sure to close the door to prevent dust from getting inside.

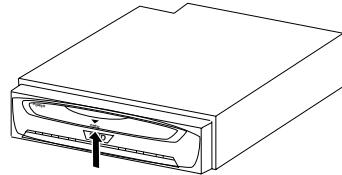

Unloading discs

- 1 Press the door in gently then slide it downwards. The disc is automatically ejected part way.**
If the disc is not removed, it is automatically drawn back into the player after a while.

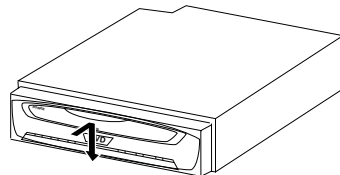

Notes:

- If the ignition key is on ACC or ON, a disc can be inserted even when the power is OFF. The power then goes ON automatically.
- For two-sided DVDs, play one side of the disc to the end, then unload the disc, turn it over and reload it to play the other side. Refer to the indications on the disc ("Side 1"/"Side 2").
- Never insert map discs for navigation purposes as they could damage the equipment.
- If wrong disc, upside-down discs or dirty discs have been inserted, "DISC ERROR" is displayed. Open the door and remove the disc.

Notes:

- If the ignition key is on ACC or ON, a disc can be removed even when the power is OFF. After removing the disc, the power goes OFF again automatically.
- Even if you open the door, the disc will not be ejected in the ACC OFF mode or in the disc loading mode ("LOADING" is displayed).

⚠ Caution Never close the door while the disc is being unloaded. Doing so could scratch the disc or damage the player.



Turning the power on and off

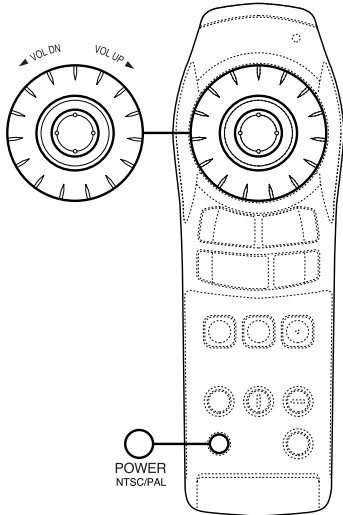

Turning the power on and off

- 1 Press "POWER".
The power turns on.



Caution When connected with an Alpine head unit
If the DVA-5205P is connected to anything other than the CVA-1005R/IVA-M700R/IVA-C800R (for ex.: CVA-1000R), the default DVD setting must be changed. See page 36, "Custom setting – Changing the Ai-NET settings" to change the SETUP to CD mode and see page 38, "Custom setting – Changing the H.U. CONTROL settings" to change the SETUP to ON mode before using it.

- 2 To turn the power off, press "POWER" again.

Play Position Memory Function

- Even if you turn power off or switch the Ignition Key to OFF during playback or change the video source, playback will continue from the point where playback stopped when the power is turned ON again.
The play position memory is released if the disc is removed or the Reset switch is pressed.

Notes:

- With this unit connected to an Ai-NET compatible head unit, there will be about a 3 second delay during power-up from the remote control. This is caused by the systems communications being carried out by the various components and is not a defect.
- When connected with an Ai-NET compatible head unit, the power cannot be turned off from the remote control unit. Turn off the DVA-5205P's power by switching the head unit's source. For details, refer to "Operating from the head unit" (page 56).

• Reading this manual



Stopping playback



Stopping playback

Press the stop button during playback to stop playback. That position is stored in the memory.

- 1 Press "■" during playback.



CHG



These indicate the discs for which the function can be used.

DVD ...DVDs

Video CD ...Video CDs

CD ...Music CDs



- Using the PRE-STOP function (DVD, Video CD only)

When the PRE-STOP function is used, the position at which playback is stopped is stored in the memory, and playback resumes from that position.

- 1 Press "■" once during playback.
"PRE-STOP" is displayed.



- 2 Press "▶" in the PRE-STOP mode.
Playback starts from the position at which it was stopped.

This indicates supplementary explanation of operation of this system.



Switching between NTSC and PAL configuration

Switch the video output configuration to NTSC or PAL according to the type of television and the disc recording method.

- 1 Press "NTSC/PAL" for at least 5 seconds.



Notes:

- PAL is the standard and there is no need to change the setting. The system is set to PAL at time of shipment from the factory.
- The image output configuration must be correct. Otherwise the following message appears and playback does not start: "VIDEO SIGNAL SYSTEM IS NOT CORRECT".

Adjusting the volume

Adjust the volume for connecting only with the Digital Audio Processor (PXA-H510).

- 1 Move the rotary encoder to the right or left.

Turn to the right to increase the volume.
Turn to the left to decrease the volume.

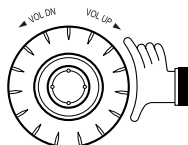

Note: If an Ai-NET product (head unit) has been connected in addition to the Digital Audio Processor (PXA-H510), or if this equipment is connected singly to a TV monitor, adjust the volume on the connected equipment.

Tips

• Using the Number Keys.

This describes use of the Number Keys, particularly the "+10" key.

To input 10: Press the "+10" key once and then press the "0" key.

To input 16: Press the "+10" key once and then press the "6" key.

To input 23: Press the "+10" key twice and then press the "3" key.

* Each time the "+10" key is pressed, the number increases by 10.



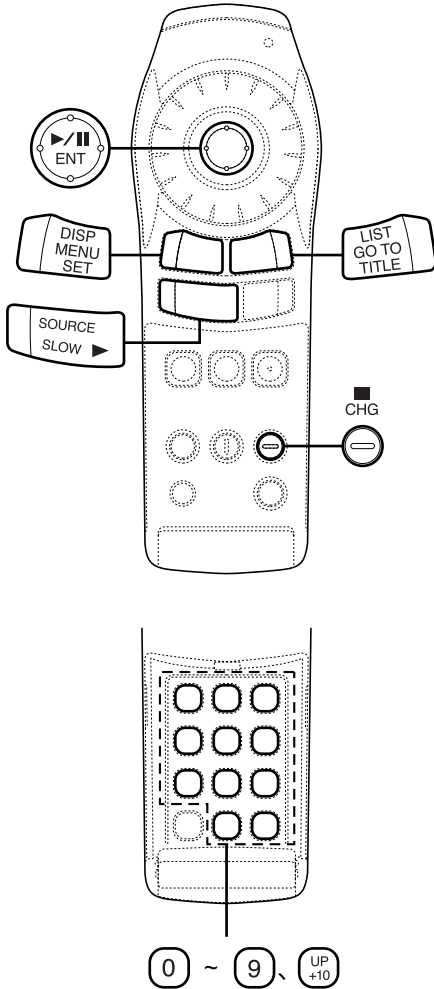

Playing discs



⚠ Caution

- With some DVDs, certain operations are disabled. Such operations are not possible on such DVDs.
- The DVD functions described in this manual are not supported by all DVDs. See the individual DVDs instructions for details on the features supported.
- Fingerprints on a disc may adversely affect playback. If a problem occurs, remove the disc and check for fingerprints on the playback side. Clean the disc if necessary.
- When using the remote control, be careful to press one button at time. Pressing multiple buttons at the same time may cause erroneous operation.
- Even if you switch the power or the Ignition Key to OFF during playback or change the video source, playback will continue from the point where it stopped when the power is turned ON again. If the disc is removed or the Reset switch is pressed, the play position memory is released.

- 1 Press "▶". Playback starts.

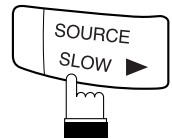

• If a menu screen appears

On DVDs and video CDs with playback control (PBC), menu screens may appear automatically. If this happens, perform the operation described below to start playback.

Note: For many discs, the menu screen can also be displayed by pressing "MENU" or "TITLE" (for at least 2 seconds).



DVD menu

Use the "Joystick" or the number keys ("0" to "9" and "+10") to select the desired item, then press "ENT" or "▶".

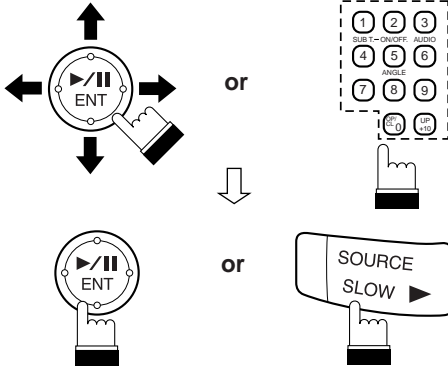

Note: For some discs it is not possible to select items from the menu screen using the number keys ("0" to "9" and "+10").

Video CD menu

Use the number keys ("0" to "9" and "+10") to select the desired number, then press "ENT" or "▶".

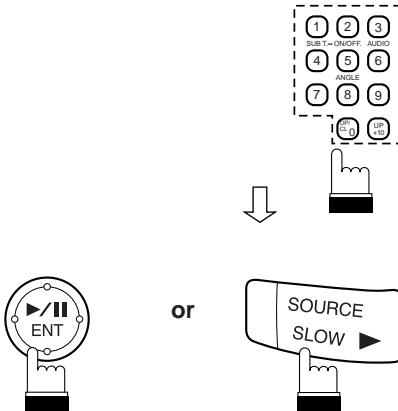

Note: The menu screen does not appear when the PBC function is turned off. If this is the case, press "MENU" to turn on the PBC function.

Stopping playback



Press the stop button during playback to stop playback. That position is stored in the memory.

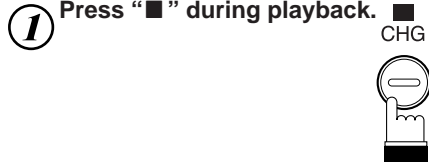

Tips: Using the PRE-STOP function (DVD, Video CD only)
When the PRE-STOP function is used, the position at which playback is stopped is stored in the memory, and playback resumes from that position.

1 Press "■" once during playback.
"PRE-STOP" is displayed.



2 Press "▶" in the PRE-STOP mode.
Playback starts from the position at which it was stopped.



Canceling the PRE-STOP function
Either press "■" again in the PRE-STOP mode or eject the disc and turn the power or the ignition key off to clear the memory.

Notes:

- For some discs, the position at which playback was stopped may not be accurate.
- Playback starts at the beginning of the disc **whenever** ignition is turned off or another Ai-NET source is selected.



Fast-forwarding/fast-reversing

Finding the beginnings of chapters or tracks

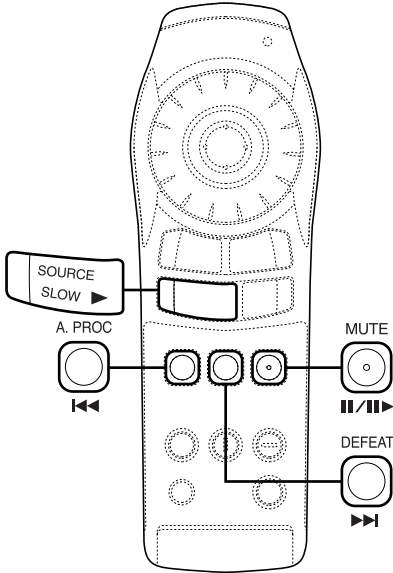

Fast-forwarding/ fast-reversing



1 During playback, press “◀◀” (fast-reverse) or “▶▶” (fast-forward) for at least 2 seconds.

A.PROC



or

DEFEAT



Press “▶” to return to normal playback.

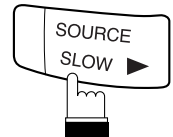

Notes:

- No sound or subtitles are played during fast-forwarding/fast-reversing.
- For DVDs and video CDs with playback control (PBC), the menu screen may reappear during fast-forwarding/fast-reversing.

Finding the begin- nings of chapters or tracks



1 During playback, press “◀◀” or “▶▶”.

The chapter/track switches each time the button is pressed, and playback of the selected chapter/track starts.

A.PROC



or

DEFEAT



- ▶▶: Press this to start playback from the beginning of the following chapter or track.
- ◀◀: Press this to start playback from the beginning of the current chapter or track.

Playing still frames (pausing) Frame-by-frame playback Slow motion playback



Note: Some DVDs do not have chapters.

Supplementary explanation

“**Chapters**” are divisions of movies or musical selections on DVDs.

“**Tracks**” are divisions of movies or musical selections on video and music CDs.

Playing still frames (pausing)



1 During playback, press “||/||▶” once.

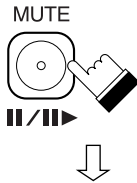

Press “▶” to resume playback.

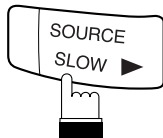

Notes:

- No sound is played during the still frame mode.
- When a playback starts after about 5 minutes of temporary still (pause), a picture or sound may stop for an instant period, but this is not a failure.

Frame-by-frame playback



1 In the pause mode, press “||/||▶”. The picture advances by one frame each time the button is pressed.



Press “▶” to resume normal playback.

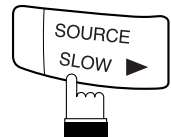

Note: No sound is played during frame-by-frame playback.

Slow motion playback



1 During playback, press “SLOW” for at least 2 seconds.

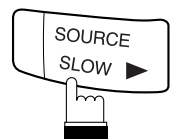

Press “▶” to resume normal playback.

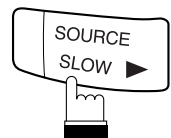

Notes:

- During the slow motion playback, the playback speed may change or the playback may skip to the next picture depending on the disc, but this is not a failure.
- No sound is played during slow motion playback.
- Slow playback is not available when playing back a slide show.



Searching by title number

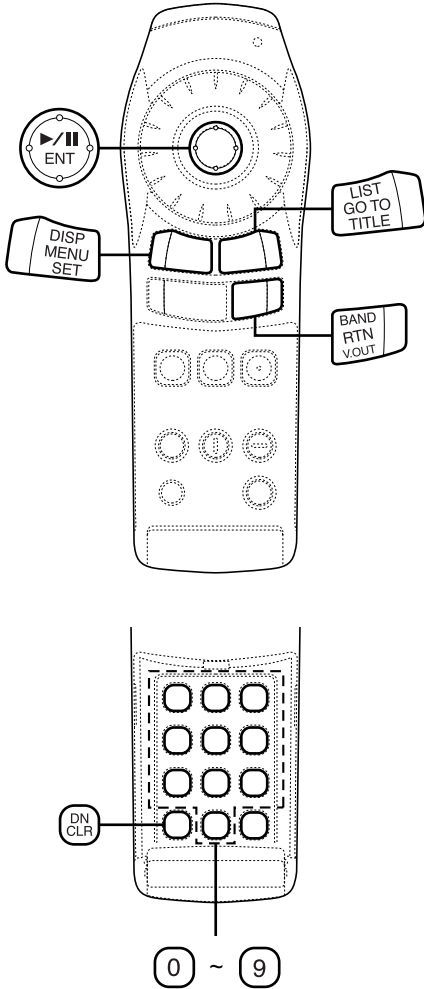

Searching by title number (DVD)

Use this function to easily find positions on the DVD using the DVD's title menu.

1 During playback, press "GO TO".

The mode switches each time the button is pressed. Select "TITLE".

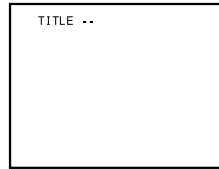

TITLE → CHAPT → TIME → Normal playback

2 Input the number of the title you want to play using the number keys ("0" to "9").

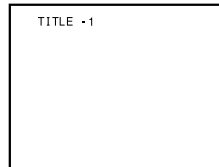
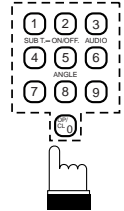

(When title number 1 is input)

Notes:

- This function cannot be used on discs on which no title numbers are recorded.
- To input the title number, the "+10" key is not used. Use the number keys "0" to "9".
- Press "CLR" to delete the last digit in the title number. Press "CLR" for at least 2 seconds to clear all title numbers.
- Press "RTN" to cancel the title search mode and resume normal playback.

Searching directly by chapter or track number



- 3** Press "ENT".
Playback starts from the selected title number.



Notes:

- This function cannot be used on discs on which no chapter numbers are recorded.
- To input the chapter or track number, the "+10" key is not used. Use the number keys "0" to "9".
- Press "CLR" to delete the last digit in the chapter/track number. Press "CLR" for at least 2 seconds to clear "Chapter" and "Track" numbers.
- Press "RTN" to cancel the chapter/track search mode and resume normal playback.
- With video discs containing playback control (PBC), function of "searching directly by track number" is not available under the PBC ON status. Press "MENU" to turn the PBC function off.

Searching directly by chapter or track number



Use this function to easily move to the beginnings of the chapters or tracks on the disc.

- 3** Press "ENT".
Playback starts from the selected chapter or track.



- 1** During playback, press "GO TO".
The mode switches each time the button is pressed. Select "CHAPT" or "TRACK".

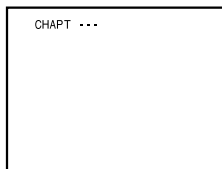

DVD Video
TITLE → CHAPT → TIME → Normal playback

Video-CD/CD
TRACK → TIME → Normal playback

- 2** Input the number of the chapter or track you want to play using the number keys ("0" to "9").

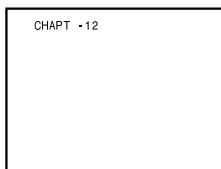
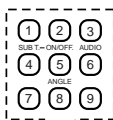

(When chapter number 12 is input)





Searching by elapsed time

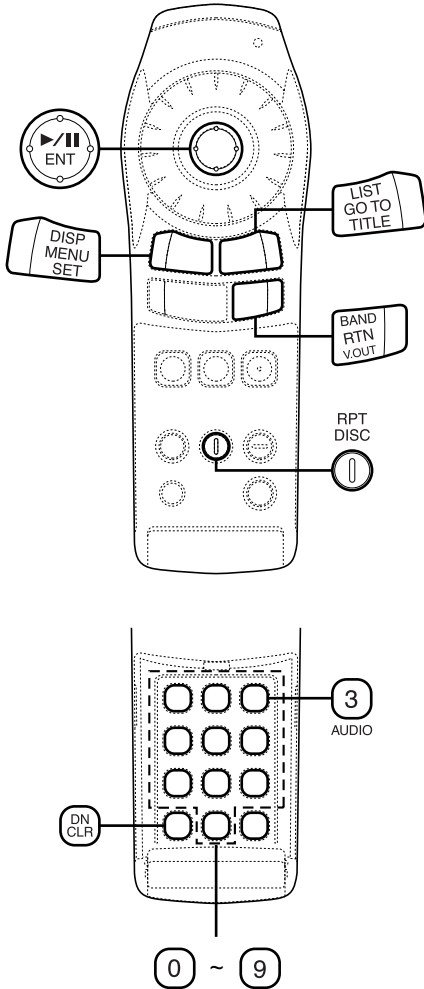

Searching by elapsed time



Use this function to search by specifying the elapsed time.

- 1** During playback, press “GO TO”. The mode switches each time the button is pressed. Select “TIME”.

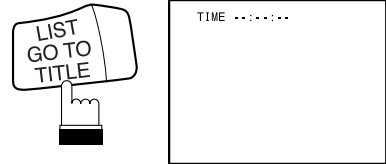

- 2** Input the elapsed time from which you want to start playback using the number keys (“0” to “9”).

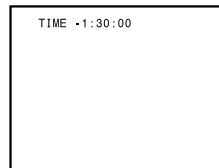
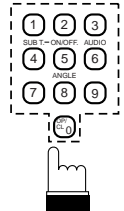

(When 1 hour, 30 minutes is input as the elapsed time)

Notes:

- Input the hours first, followed by the minutes, then the seconds.
- To input the elapsed time, the “+10” key is not used. Use the number keys “0” to “9”.
- Press “CLR” to delete the last digit in the elapsed time. Press “CLR” for at least 2 seconds to erase all the set times.
- Press “RTN” to cancel the elapsed time search mode and resume normal playback.
- With DVDs, the precision of the elapsed time search function differs from disc to disc.
- With video discs containing playback control (PBC), function of “searching by elapsed time” is not available under the PBC ON status. Press “MENU” to turn the PBC function off.



- 3** Press “ENT”.
Playback starts from the specified elapsed time.



Switching the audio language



On DVDs including multiple audio modes or multiple audio languages, the audio language can be switched during playback.

- 1** During playback, press “AUDIO” for at least 2 seconds.



The sound switches between the different audio modes recorded on the disc each time the button is pressed.

Chapter/track/ title repeat playback



Use this function to play the disc’s titles, chapters or tracks repeatedly.

- 1** During playback, press “RPT”.

The repeat mode switches each time the button is pressed.

RPT
DISC



Notes:

- The language selected with the default settings is set when the power is turned on or the disc is replaced. If the disc does not include that language, the disc’s default language is set.
- For some discs it is not possible to switch the audio language during playback.
- Some time may be required for the audio language to change.

DVD

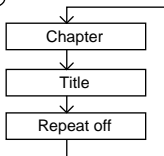

The chapter is played repeatedly.

The title is played repeatedly.

The mode returns to normal playback. (setting at factory shipping)

- 1** During playback, press “AUDIO” for at least 2 seconds.



The combination of the left and right channels changes each time the button is pressed.

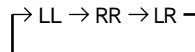

Video CD CD

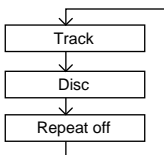

The track is played repeatedly.

The entire disc is played repeatedly.

(setting at factory shipping)

Note: The track/disc repeat modes cannot be used on video CDs with playback control (PBC). Press “MENU” to turn the PBC function off.



Switching the angle Switching the subtitles (subtitle language)

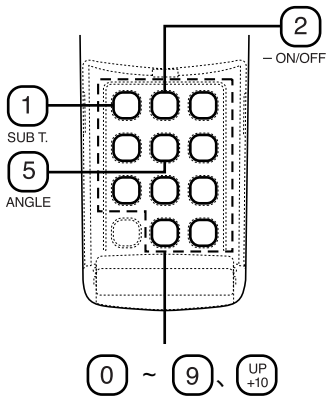
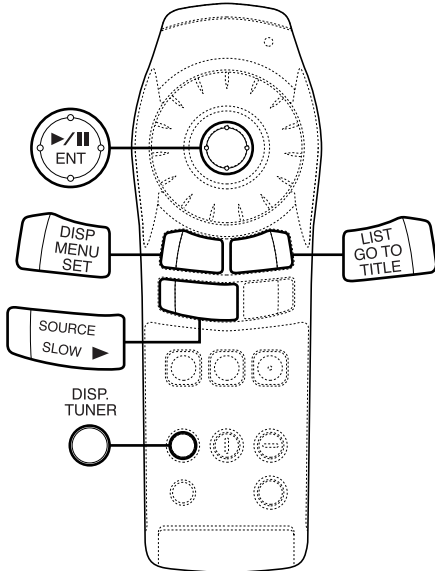

Switching the angle DVD

With DVDs on which images photographed from multiple angles are recorded, the angle can be switched during playback.

- 1** During playback, press “ANGLE” for at least 2 seconds.



The angle switches between the angles recorded on the disc each time the button is pressed.

Notes:

- Some time may be required for the angle to change.
- Depending on the disc, the angle may switch in one of two ways.
 - Seamless : The angle switches smoothly.
 - Non-seamless : When the angle is switched, a still picture is displayed first, after which the angle switches.

Switching the subtitles (subtitle language) DVD

With DVDs on which multiple subtitle languages are recorded, the subtitle language can be switched during playback.

- 1** During playback, press “SUB T.” for at least 2 seconds.



The subtitle language switches between the languages recorded on the disc each time the button is pressed.

Notes:

- Some time may be required for the subtitle language to change.
- The language selected with the default settings is set when the power is turned on or the disc is replaced. If the disc does not include that language, the disc's default language is set.



Displaying the subtitles



With DVDs on which subtitles are recorded, you can select whether to display the subtitles or not during playback.

- 1 During playback, press “– ON/OFF” for at least 2 seconds. 

The currently displayed subtitles are turned on and off each time the button is pressed.

Note: For some discs, the subtitles will be displayed even when this is set to off.

Displaying the disc status



Use the procedure described below to display the status (title number, chapter number, etc.) of the currently playing DVD on the screen.

- 1 During playback, press “DISP.”. 

The playback status is displayed.

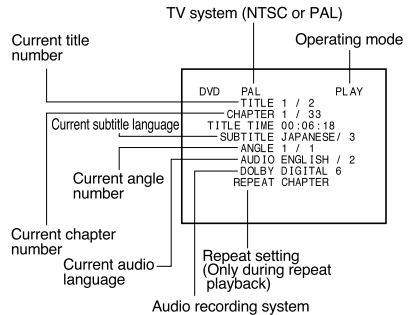

- **Switching from the menu**
For some discs, the audio language, angle and subtitles can be switched from the disc menu.

- 1 Press “MENU” or “TITLE” (for at least 2 seconds), select the item, then press “ENT”.



- 2 Use the “Joystick” or the number keys (“0” to “9” and “+10”) to select the language or angle, then press “ENT” or “▶”.

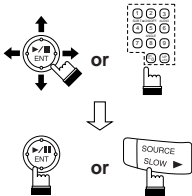

- 2 Press “DISP.” once more to turn the display off.  



Displaying the disc status

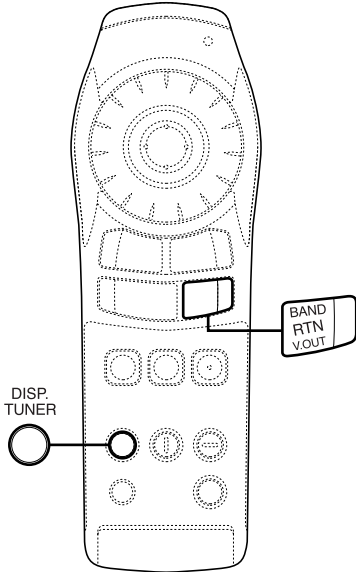

Displaying the disc status



Use the procedure described below to display the status (track number, etc.) of the currently playing video CD or music CD on the screen.

1 During playback, press "DISP.".

The playback status is displayed.

DISP. TUNER

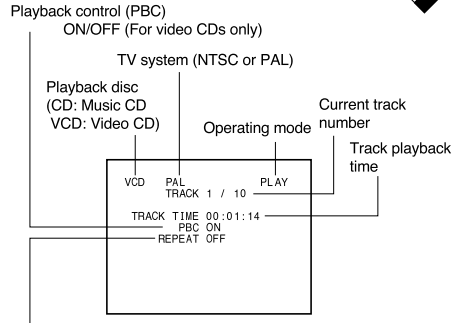

Repeat setting (Default setting-disc repeat)

Note: For music CDs, the playing status is displayed even when "DISP." is not pressed.

2 Press "DISP." once more to turn the display off.

DISP. TUNER





Video output ON/OFF (Only when CVA-1005R/IVA-M700R/ IVA-C800R is connected)

When this unit is used with the CVA-1005R/IVA-M700R/IVA-C800R + the TME-M750 (Extra Monitor for Rear Seat), the DVD video can be viewed independently of what's being viewed on the CVA-1005R/IVA-M700R/IVA-C800R.

For example, DVD video can be monitored on the Rear Monitor, while a Navigation map is displayed on the CVA-1005R/IVA-M700R/IVA-C800R. If an audio source is selected, the main audio system will be used to listen to the CVA-1005R/IVA-M700R/IVA-C800R. Use the RCA connectors at the rear of the DVA-5205P to feed audio to your Rear monitor.

Note: This output is at a fixed level and requires a preamp with a volume control to adjust listening levels.

- 1 Set AUX OUT of "Selecting Rear Monitor" on the CVA-1005R/IVA-M700R/IVA-C800R side to AUX 1.
- 2 Change the source on the CVA-1005R/IVA-M700R/IVA-C800R side to MD, CD, radio, etc.
- 3 Use the "Playing 2 Sources Simultaneously" function on the CVA-1005R/IVA-M700R/IVA-C800R side to select DVD with the V.SEL button.

- 4 Press "V.OUT" on the remote control unit for this equipment at least 2 seconds.

To release, press "V.OUT" for at least 2 seconds.

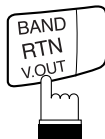

Note: Refer to the Instruction Manual of the CVA-1005R/IVA-M700R/IVA-C800R for operation on the CVA-1005R/IVA-M700R/IVA-C800R side.



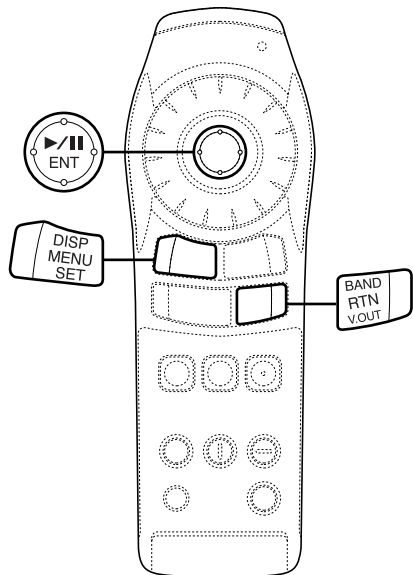

Changing the default settings (setup)

The factory default settings can be changed to suit your personal preferences and usage.

- 1** In the stop mode, press “SET” for at least 2 seconds.

The default setting menu appears.

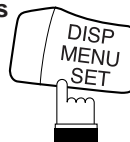

Note: This operation cannot be performed in the PRE-STOP mode.

- 2** Use the “Joystick” to make the selection, then press “ENT”.

For the procedure after selecting the setting item, refer to the pages indicated on the table below.

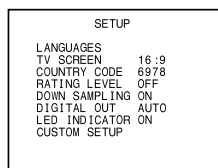
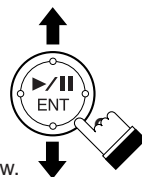

Item	Description	See page
LANGUAGES	Set the audio language, subtitle language and menu language.	→P24
TV SCREEN	Set the screen size according to the type of TV monitor being used.	→P26
COUNTRY CODE	Set the country code when setting the rating level.	→P27
RATING LEVEL	Set the rating level (parental lock).	→P28
DOWN SAMPLING	Takes DVD digital sound and converts it into 48 kHz/16 bit sampling digital sound.	→P30
DIGITAL OUT	Set the digital output.	→P32
LED INDICATOR	Set whether the front panel's LED indicators are on or off.	→P34
CUSTOM SETUP	Set the Closed Caption and Ai-NET setting.	→P35

Note: When the settings are changed, the old settings are overwritten. Make a note of the current settings before making changes. The settings are not cleared even when the vehicle's battery is disconnected.

Changing the language settings

The audio language, subtitle language and menu language can be set according to your preferences.

- 1** Select “LANGUAGES” under “Changing the default settings (SET UP)” on page 24.

Changing the language settings

- 2** Use the “Joystick” to make the selection, then press “ENT”.

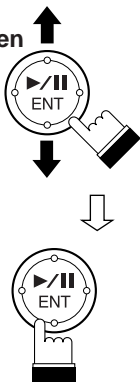
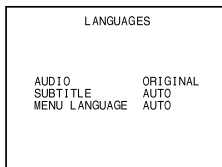

AUDIO

Set the audio language produced from the speakers.

SUBTITLE

Set the language of the subtitles displayed on the screen.

MENU LANGUAGE

Set the language used for the menus (title menu, etc.).

The setup screen for the selected language is displayed.



AUDIO
(audio languages)

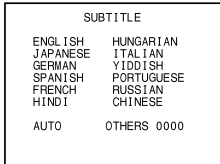

SUBTITLE
(subtitle languages)

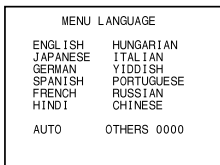

MENU LANGUAGE
(menu languages)

ORIGINAL

The disc is played with the audio language set as the priority language for the disc. (AUDIO only)

AUTO

The disc is played with the subtitle language set as the priority language for the disc. (SUBTITLE/MENU LANGUAGE only)

OTHERS

Set this to play the disc with a language other than one of the languages displayed. Use the keys “0” to “9” to input the 4-digit language code, then press “ENT”. For the language codes, refer to “List of language codes” (page 61).

- 3** Use the “Joystick” to select the desired language, then press “ENT”.

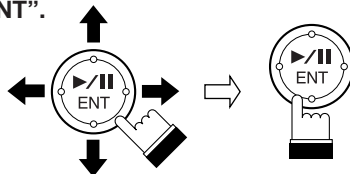

Displays the setting contents.

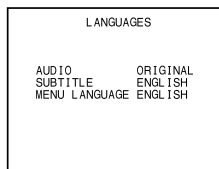

Notes:

- If the disc does not include the selected language, the disc's default language is set.
- Languages set upon shipment from the factory:
Audio language : ORIGINAL
Subtitle language : AUTO
Menu language : AUTO
- Press “RTN” to return to the previous screen.

- 4** Press “SET” for at least 2 seconds.

The settings are stored and the set up mode is canceled.

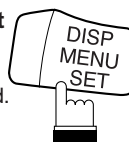

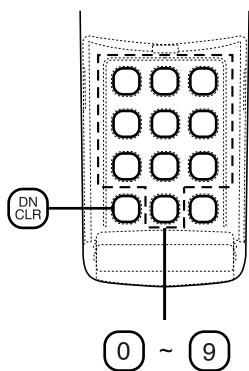
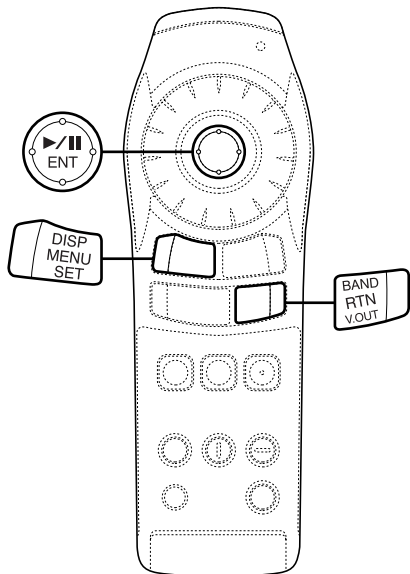

Changing the TV screen settings

Use the procedure described below to set the output screen according to the type of TV monitor being used.

1 Select "TV SCREEN" under "Changing the default settings (SET UP)" on page 24.

2 Use the "Joystick" to make the selection, then press "ENT".

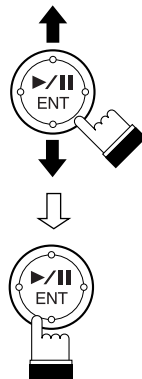
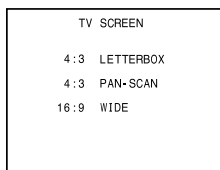

4 : 3 LETTERBOX

Select this when connected to a conventional 4:3 size (normal TV aspect ratio) monitor. There may be black stripes visible at the top and bottom of the screen. The width of these stripes will depend upon the original aspect ratio of the theatrical release of the movie.



4 : 3 PAN-SCAN

Select this when connected to a conventional 4:3 size monitor. The picture will fill the entire TV screen. However, due to the mismatch in aspect ratio, parts of the movie at the extreme left and right sides will not be visible.



Changing the country code setting

16 : 9 WIDE

Select this when connected to a wide screen TV. This is selected upon shipment from the factory.



Displays the setting contents.

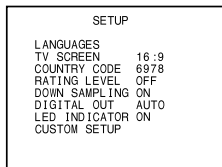

Notes:

- For some discs, the picture may not be set to the selected screen size. (For details, refer to the explanation on the disc's jacket.)
- Press "RTN" to return to the previous screen.

3 Press "SET" for at least 2 seconds.

The settings are stored and the set up mode is canceled.

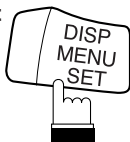

Changing the country code setting

Set the country code when setting the rating level (Parental lock).

1 Select "COUNTRY CODE" under "Changing the default settings (SET UP)" on page 24.

2 Press "ENT" to reset the country code.

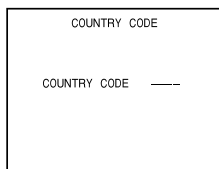

3 Use keys "0" to "9" to input the 4-digit country code, then press "ENT".

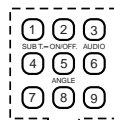
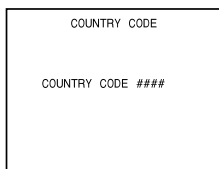

SET UP

Displays the setting contents.

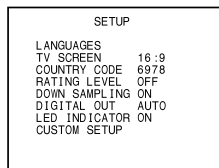

Notes:

- For the country codes, refer to "List of country codes" (Page 63).
- Can be erased one digit at a time each time "CLR" is pressed.
- Press "RTN" to return to the previous screen.

4 Press "SET" for at least 2 seconds.

The settings are stored and the set up mode is canceled.

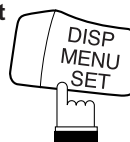

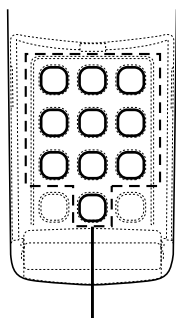
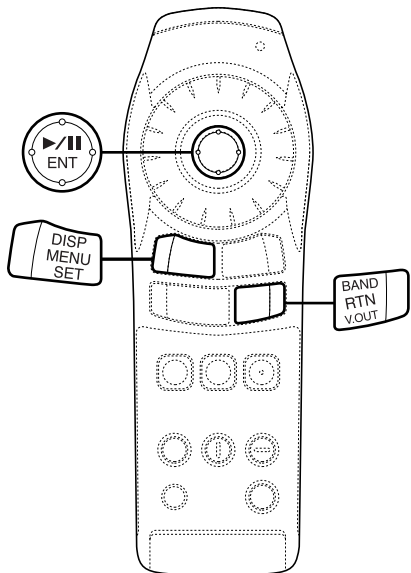

0 ~ 9

Setting the rating level (parental lock)

Use this function to restrict the viewing of movies to children of appropriate age levels only.

1 Select "RATING LEVEL" under "Changing the default settings (SET UP)" on page 24.

2 Press "ENT".
The password input mode is set.

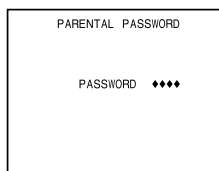

3 Use keys "0" to "9" to input the 4-digit password.

The default password is 1111 upon shipment from the factory.

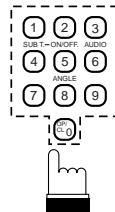
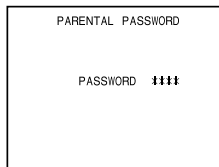

Input numbers are displayed "x".

4 Press "ENT".

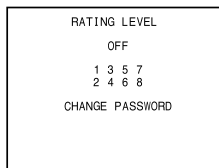

Setting the rating level (parental lock)

- 5** Use the “Joystick” to select the rating level, then press “ENT”. Select “OFF” to cancel the parental lock or if you do not want to set a rating level. The higher the number, the higher the rating level.

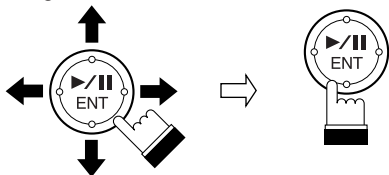

Displays the setting contents.

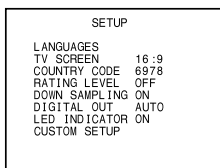

Note: Press “RTN” to return to the previous screen.

- 6** Press “SET” for at least 2 seconds.

The settings are stored and the set up mode is canceled.

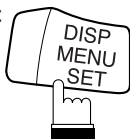

Notes:

- If you want to change the password, select “CHANGE PASSWORD”, then input the new password (4 digits).
- Write down the password on a piece of paper and store the piece of paper somewhere in case you forget it.
- On unrated DVDs, playback will not be restricted even if the rating level is set.
- Once set, this rating level remains in memory until changed. To enable the play of discs of higher rating levels or to cancel the parental lock, the setting must be changed.
- Not all DVDs provide a Parental Lock feature. If you are unsure about a DVD, play it first to confirm. Do not leave DVDs accessible to young children for whom you deem them inappropriate.



• **Changing the rating level temporarily**

Some discs may request that you change the rating level set in the default settings during playback. In this case, the following message appears on the screen:

Still picture

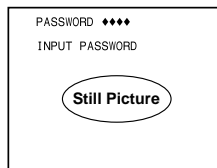

When this appears, if you do not input the correct password either playback does not continue or a picture for a different rating level is played.

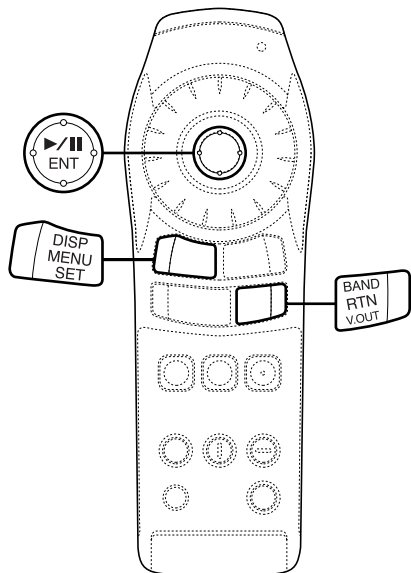

Changing the down sampling setting

Converts linear PCM (LPCM) voice signals recorded on the DVD disc to downsampling 48 kHz/16 bit digital signals and outputs them from the optical cable.

- 1 Select "DOWN SAMPLING" under "Changing the default settings (SET UP)" on page 24.
- 2 Move the "Joystick" up and down to choose "ON" or "OFF" and, then press "ENT".

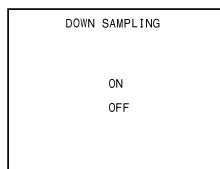
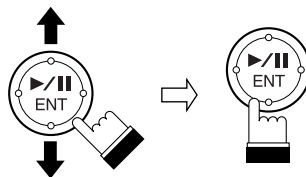

ON

The digital signals recorded on the DVD disc with 96 kHz/24bit, 48 kHz/24bit, 48 kHz/20bit sampling are converted into digital signals with 48 kHz/16bits sampling for output from the optical cable. Set to ON at time of shipment from factory.

OFF

The digital signals recorded on the DVD disc with 96 kHz/24bit, 48 kHz/24bit, 48 kHz/20bit sampling are not converted into digital signals with 48 kHz/16bits sampling. They are not output from the optical cable.

Displays the setting contents.

```
SETUP
LANGUAGES
TV SCREEN 16:9
COUNTRY CODE 6978
RATING LEVEL OFF
DOWN SAMPLING ON
DIGITAL OUT AUTO
LED INDICATOR ON
CUSTOM SETUP
```

Note: Press "RTN" to return to the previous screen.

3 Press "SET" for at least 2 seconds.

The settings are stored and the set up mode is canceled.

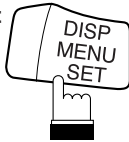

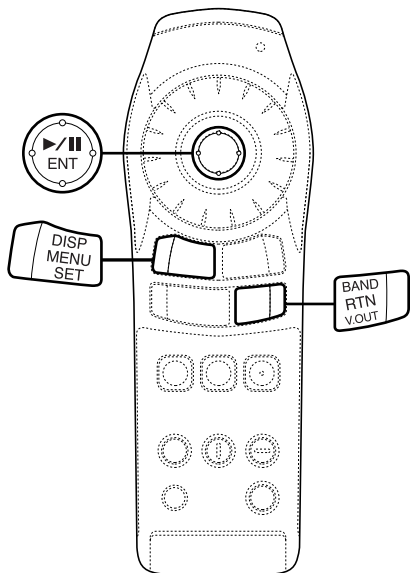

Changing the digital output setting

Use the following procedure to set the audio signal output from the DVA-5205P.

① Select “DIGITAL OUT” under “Changing the default settings (SET UP)” on page 24.

② Use the “Joystick” to make the selection, then press “ENT”.

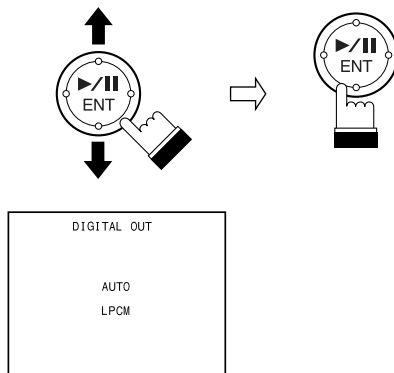

AUTO

The digital output is switched automatically according to the type of audio signals being played.

Be sure to select “AUTO” when you want to connect a digital audio processor and play Dolby Digital audio. “AUTO” is selected upon shipment from the factory.

LPCM

The audio signals recorded on the disc are converted into 48 kHz/16 bit (for DVDs) or 44.1 kHz (for video CDs and CDs) linear PCM audio signals for output.

Changing the digital output setting

Displays the setting contents.

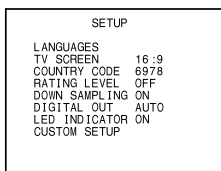

3 Press “SET” for at least 2 seconds.

The set up are stored and the set up mode is canceled.

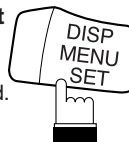

Note: Press “RTN” to return to the previous screen.

• Audio output/Optical digital audio output

Disc	Audio recording format	Digital output setting	Down sampling setting	Optical digital audio output (when a digital audio processor is connected)	Analog audio output (Ai-NET, RCA output)
DVD	DTS	AUTO	ON	DTS	X
			OFF	DTS	X
		LPCM	ON	X	X
			OFF	X	X
	Dolby Digital	AUTO	ON	Dolby Digital	O
			OFF	Dolby Digital	O
		LPCM	ON	LPCM (48kHz/16 bit)	O
			OFF	X	O
	Linear PCM (48 kHz)	AUTO	ON	LPCM (48kHz/16 bit)	O
			OFF	X	O
		LPCM	ON	LPCM (48kHz/16 bit)	O
			OFF	X	O
	Linear PCM (96 kHz)	AUTO	ON	LPCM (48kHz/16 bit)	O
			OFF	X	O
		LPCM	ON	LPCM (48kHz/16 bit)	O
			OFF	X	O
Video CD	MPEG	AUTO or LPCM	ON or OFF	LPCM (44.1kHz)	O
CD	Linear PCM	AUTO or LPCM	ON or OFF	LPCM (44.1kHz)	O

SET UP

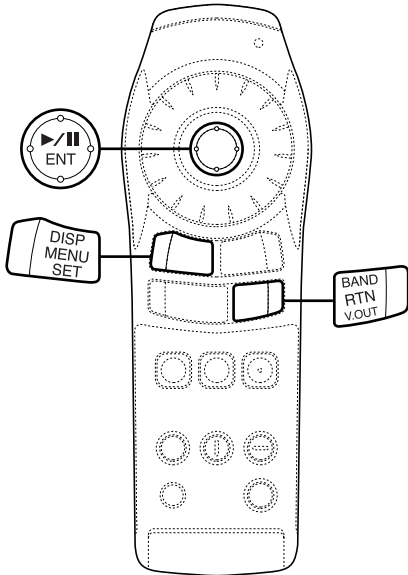

Changing the LED indicator setting

Use the following procedure to set whether or not the product's LED indicators are on or off.

- 1 Select "LED INDICATOR" under "Changing the default settings (SET UP)" on page 24.
- 2 Use the "Joystick" to select the "ON" or "OFF", then press "ENT".

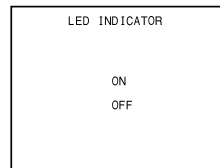
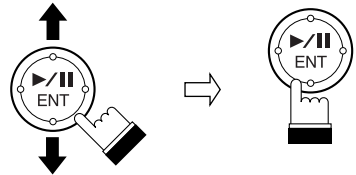

ON

The LED indicators are lit, indicating the product's operating status. "ON" is selected upon shipment from the factory.

OFF

The LED indicators are turned off. When "OFF" is set, the indicators do not light even when the power is on.

Custom setting – Changing the Closed Caption setting

Displays the setting contents.

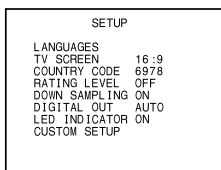

Note: Press "RTN" to return to the previous screen.

- 3 Press "SET" for at least 2 seconds. The settings are stored and the set up mode is canceled.



Custom setting – Changing the Closed Caption setting

DVD includes so-called "closed captions" which describe the scene to persons with impaired hearing. It is possible to turn the closed captions ON and OFF.

- 1 Select "CUSTOM SETUP" under "Changing the default settings (SET UP)" on page 24.

- 2 Move the "Joystick" up and down to select "CLOSED CAPTION", then press "ENT".

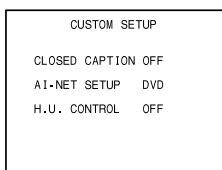
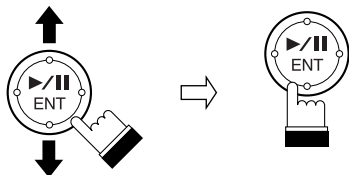

- 3 Move the "Joystick" up and down to select "ON" or "OFF", then press "ENT".

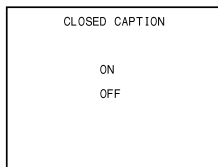
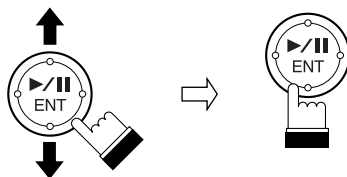

ON

Displays the closed captions.

OFF

Does not display the closed captions. Set to OFF at time of shipment from factory.

Displays the setting contents.

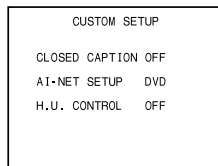

Notes:

- Please be aware that closed captions are different from titles.
- Press "RTN" to return to the previous screen.

- 4 Press "SET" for at least 2 seconds. The settings are stored and the set up mode is canceled.

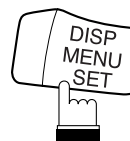

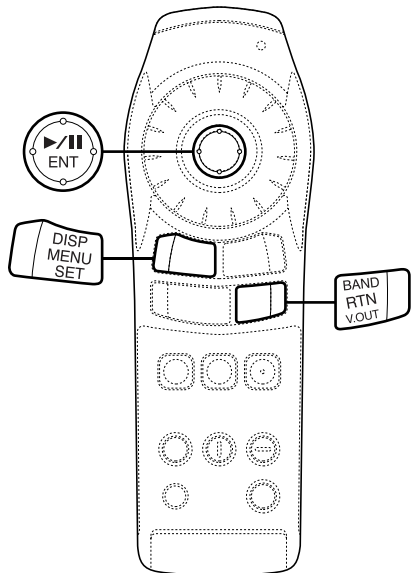

Custom setting – Changing the Ai-NET settings

The Ai-NET settings are used to output the sound of connected Ai-NET products.

- 1 Select "CUSTOM SETUP" under "Changing the default settings (SET UP)" on page 24.
- 2 Use the "Joystick" to select "Ai-NET SETUP", then press "ENT".

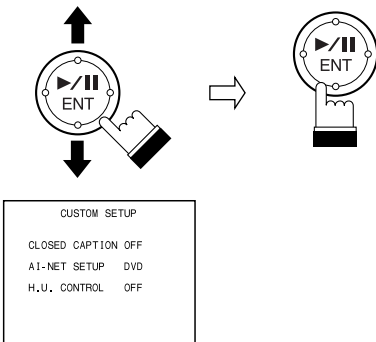

- 3 Use the "Joystick" to select "DVD" or "CD", then press "ENT".

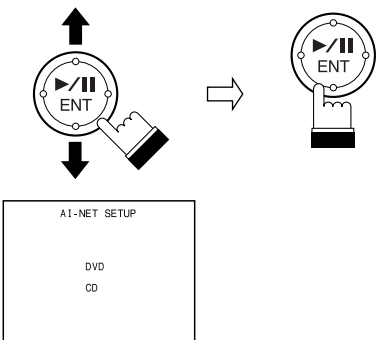

Custom setting – Changing the Ai-NET settings

DVD

Set to "DVD" when connected to the CVA-1005R/IVA-M700R/IVA-C800R.

Operations can be performed using the CVA-1005R/IVA-M700R/IVA-C800R's main menu screen.

For details, refer to the operating instructions of the CVA-1005R/IVA-M700R/IVA-C800R. "DVD" is selected upon shipment from the factory.

CD

Set to "CD" when connected to an Ai-NET product (head unit) other than the CVA-1005R/IVA-M700R/IVA-C800R (for ex.: CVA-1000R). Operations can be performed from the head unit.

For details, refer to "Operating from the head unit" (page 56).

Displays the setting contents.

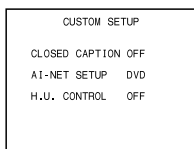

Notes:

- Press "RTN" to return to the previous screen.
- If the Ai-NET setting is "CD" when used with the CVA-1005R/IVA-M700R/IVA-C800R, operation from the main menu screen is not possible.
- If the Ai-NET setting is "DVD" when used with any Ai-NET compatible head unit other than the CVA-1005R/IVA-M700R/IVA-C800R, volume is the only operation possible from the head unit.
- To call the DVD video by using the CVA-1000R, switch the mode to "AUX" with the V. SEL button on the CVA-1000R.
- When the Ai-NET setting is "CD", the operable functions and displays may differ depending on the Ai-NET compatible head unit connected.

4 Press "SET" for at least 2 seconds.

The settings are stored and the set up mode is canceled.

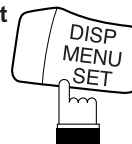

5 Turn off the vehicle's ignition, then turn it on again.

Notes:

Cases in which DVDs cannot be played on the CVA-1005R/IVA-M700R/IVA-C800R side

- When "DVD" is not displayed on the CVA-1005R/IVA-M700R/IVA-C800R side menu screen
- When DVDs cannot be played even when AUX1 is selected

This is because the DVA-5205P's Ai-NET setting is set to "CD".

Use the procedure described below to change the setting.

1. Remove the disc from the DVA-5205P.
2. Turn on the power of the DVA-5205P and CVA-1005R/IVA-M700R/IVA-C800R.
Also start up the CVA-1005R/IVA-M700R/IVA-C800R monitor.
3. Press the CVA-1005R/IVA-M700R/IVA-C800R SOURCE switch and select "CD" from the menu.
4. Press the SOURCE switch, then select "V.SEL" from the menu.
5. In the V.SEL mode, select "AUX1". This displays the DVA-5205P screen.
6. On the DVA-5205P, set the Ai-NET setting to "DVD". Refer to "Changing the Ai-NET settings" (pages 36 and 37).
7. Turn the car's ignition switch off, then turn it back on.

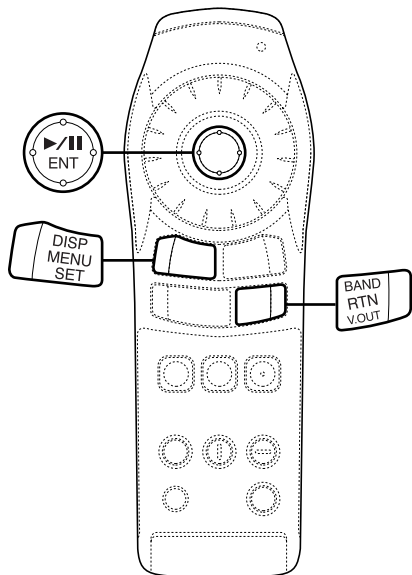

Custom setting – Changing the H.U. CONTROL settings

When connecting this equipment with an Ai-NET compatible head unit or an Ai-NET compatible AV head unit (CVA-1005R/IVA-M700R/IVA-C800R), set the equipment so that it is possible to control from the head unit.

1 Select “CUSTOM SETUP” under “Changing the default settings (SET UP)” on page 24.

2 Move the “Joystick” up and down to select “H.U. CONTROL”, then press “ENT”.

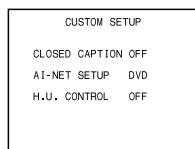
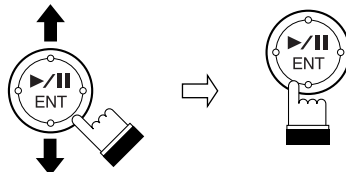

3 Move the “Joystick” up and down to select “ON” or “OFF”, then press “ENT”.

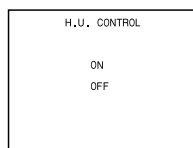
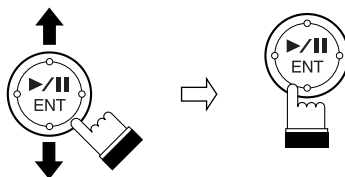

Custom setting – Changing the H.U. CONTROL settings

ON

Possible to operate from an Ai-NET compatible head unit or an Ai-NET compatible AV head unit (CVA-1005R/IVA-M700R/IVA-C800R).

OFF

Not possible to operate from an Ai-NET compatible head unit or an Ai-NET compatible AV head unit (CVA-1005R/IVA-M700R/IVA-C800R). Set to OFF at time of shipment from factory.

Displays the setting contents.

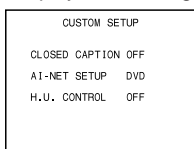

Note: Press "RTN" to return to the previous screen.

4 Press "SET" for at least 2 seconds.

The settings are stored and the set up mode is canceled.

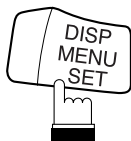



Operating the digital audio processor (optional)

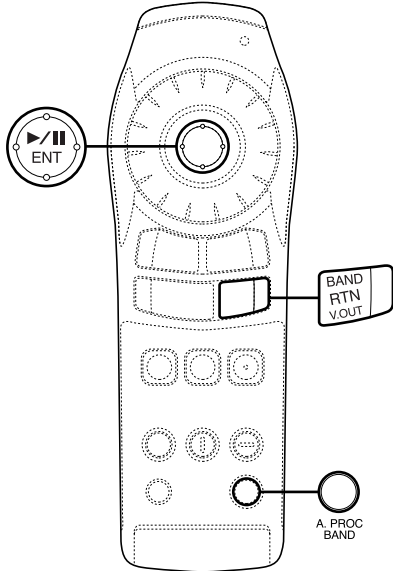

Operating the digital audio processor (optional)



When used with a digital audio processor (PXA-H510), operation is possible from the remote control unit included with the DVA-5205P. Also refer to the PXA-H510's operating instructions.

- 1** During playback, press "A.PROC".
The setting menu appears.



- 2** Use the "Joystick" to make the selection, then press "ENT".
For the procedure after making a selection, refer to the pages indicated on the table below.

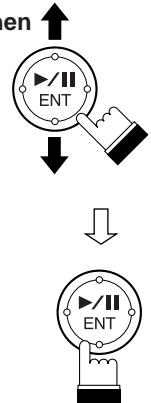

AUDIO-PROCESSOR	
PARAMETRIC-EQ	
SURROUND	
PRIVATE-MEMORY	
TIME-CORRECTION	
DOLBY SURROUND MODE	
ADJUST MODE	
	DEFEAT

Item	Description	See page
PARAMETRIC-EQ	Adjust the parametric equalizer's band frequency, band width and level.	→P41
SURROUND	Select one of six surround modes according to the music source using DSP (digital signal processing).	→P42
PRIVATE-MEMORY	Store and recall up to six parametric equalizer adjustments and settings.	→P43
TIME-CORRECTION	Eliminate time delays resulting from the distance between the listening position and the speakers.	→P45
DOLBY SURROUND MODE	Switch between the Dolby Digital input and the Pro Logic input.	→P45
ADJUST	Adjust the speaker mode, speaker level, etc.	→P46
MODE	Adjust the volume, fader, balance, etc.	→P53



Adjusting the parametric equalizer

1 Select "PARAMETRIC-EQ" under "Operating the digital audio processor (optional)" on page 40.

2 Use the "Joystick" to select the band to be set, then press "ENT". The band whose frequency is indicated in yellow can be adjusted. The parametric equalizer's setting screen consists of two pages. Press "BAND" for at least 2 seconds to switch between pages 1 and 2.

	FREQ	Q-FACT	LV
FRNT1	1.0KHz	5.0	-5
FRNT2	12.5KHz	1.0	+5
FRNT3	20.0KHz	2.0	0
FRNT4	80.0 Hz	5.0	-5
CNTR1	12.5KHz	1.0	+5
CNTR2	200.0 Hz	2.0	0

	FREQ	Q-FACT	LV
REAR1	12.5KHz	1.0	+5
REAR2	200.0 Hz	2.0	0
REAR3	1. KHz	5.0	-5
REAR4	12.5KHz	1.0	+5
SUBW1	80.0 Hz	2.0	0

3 Use the "Joystick" to adjust the frequency, then press "ENT".

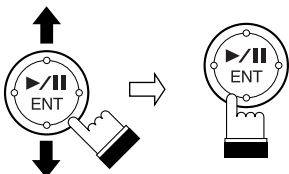

4 Use the "Joystick" to select the band width (Q-FACT), then press "ENT".

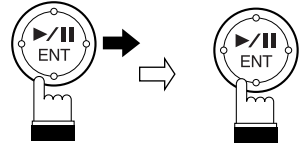

5 Use the "Joystick" to adjust the band width, then press "ENT".

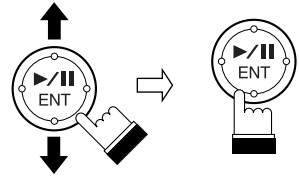

6 Use the "Joystick" to select the level (LV), then press "ENT".

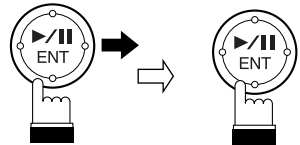

7 Use the "Joystick" to adjust the level, then press "ENT".

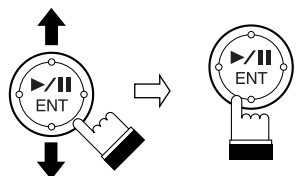

Note: Press "RTN" to return to the previous screen.

8 Press "A.PROC" to close the digital audio processor screen and return to the playback screen.





Adjusting the surround settings

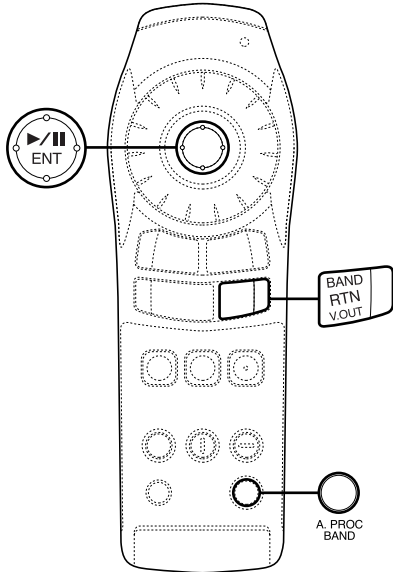

Adjusting the surround settings

This adjustment is not possible when Dolby Digital or Pro Logic is turned on for the DVA-5205P's audio output.

- 1 Select "SURROUND" under "Operating the digital audio processor (optional)" on page 40.
- 2 Use the "Joystick" to select the surround mode, then press "ENT". There are six surround modes.

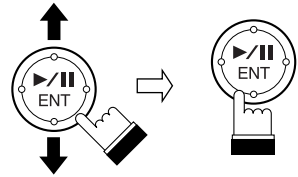

SURROUND	
NORMAL	
STADIUM	
LIVE	
CHURCH	
DANCE	LV TIME
HALL	-4 +4

- 3 Press "ENT". The level (LV) value turns yellow.



- 4 Use the "Joystick" to adjust the level (LV), then press "ENT".

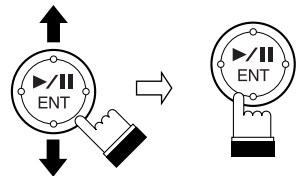



- ⑤ Use the “Joystick” to select the time (echo time), then press “ENT”.

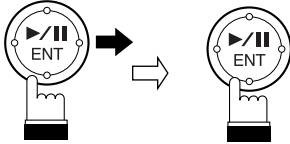

- ⑥ Use the “Joystick” to adjust the time, then press “ENT”.

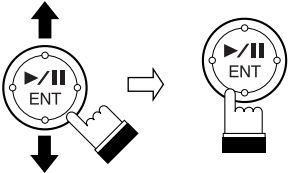

Note: Press “RTN” to return to the previous screen.

- ⑦ Press “A.PROC” to close the digital audio processor screen and return to the playback screen.



- ② Use the “Joystick” to select “WRITE”, then press “ENT”.

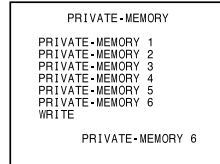
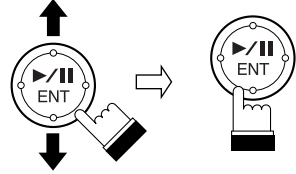

- ③ Use the “Joystick” to select the memory location at which you want to store the settings (“PRIVATE-MEMORY 1” to “PRIVATE-MEMORY 6”), then press “ENT”.

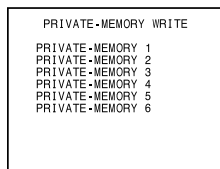
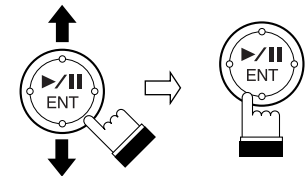

Note: Press “RTN” to return to the previous screen.

Storing the surround settings



- ① Select “PRIVATE-MEMORY” under “Operating the digital audio processor (optional)” on page 40.

- ④ Press “A.PROC” to close the digital audio processor screen and return to the playback screen.





Recalling the surround settings

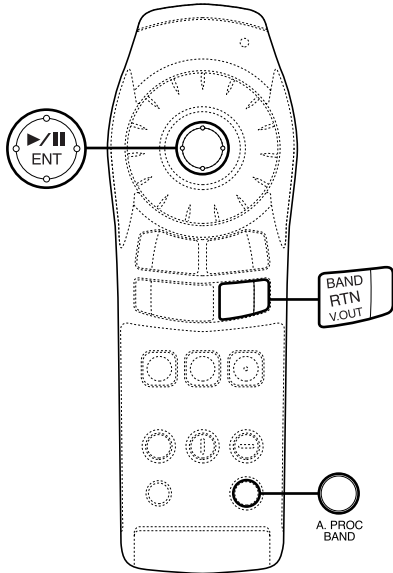

Recalling the surround settings



- 1 Select "PRIVATE-MEMORY" under "Operating the digital audio processor (optional)" on page 40.
- 2 Use the "Joystick" to select the memory location you want to recall ("PRIVATE-MEMORY 1" to "PRIVATE-MEMORY 6"), then press "ENT".

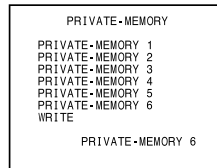
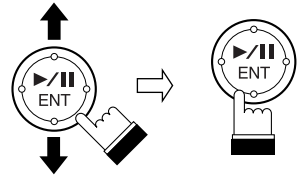

Note: Press "RTN" to return to the previous screen.

- 3 Press "A.PROC" to close the digital audio processor screen and return to the play-back screen.



Adjusting the time compensation Using the Pro Logic mode



Adjusting the time compensation



1 Select “TIME-CORRECTION” under “Operating the digital audio processor (optional)” on page 40.

2 Use the “Joystick” to select the speaker to be adjusted, then press “ENT”.

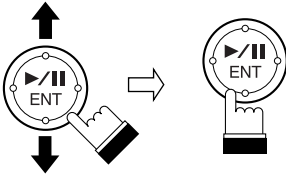

TIME-CORRECTION	
	DELAY
FRONT L	0.0 _{sec}
FRONT R	5.5 _{sec}
REAR L	10.0 _{sec}
REAR R	15.5 _{sec}
SUB-W	20.0 _{sec}

3 Use the “Joystick” to adjust the time, then press “ENT”.

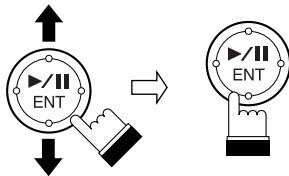

Note: Press “RTN” to return to the previous screen.

4 Press “A.PROC” to close the digital audio processor screen and return to the play-back screen.



Using the Pro Logic mode



1 Select “DOLBY SURROUND MODE” under “Operating the digital audio processor (optional)” on page 40.

2 Use the “Joystick” to make the selection, then press “ENT”.

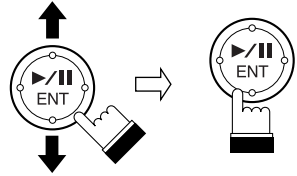

DOLBY SURROUND MODE	
DOLBY DIGITAL	
DOLBY PRO LOGIC	
OFF	
DOLBY PRO LOGIC	

DOLBY DIGITAL

“DOLBY DIGITAL” is set automatically when the disc is Dolby Digital compatible and the DVD video player’s audio output setting is set to “AUTO”.

DOLBY PRO LOGIC

“DOLBY PRO LOGIC” or “OFF” can be selected when the disc is Dolby Pro Logic compatible and the DVD video player’s audio output setting is set to “LPCM”. When “OFF” is selected, the surround settings cannot be adjusted.

Note: Press “RTN” to return to the previous screen.

3 Press “A.PROC” to close the digital audio processor screen and return to the play-back screen.





ADJUST – Setting the speaker mode

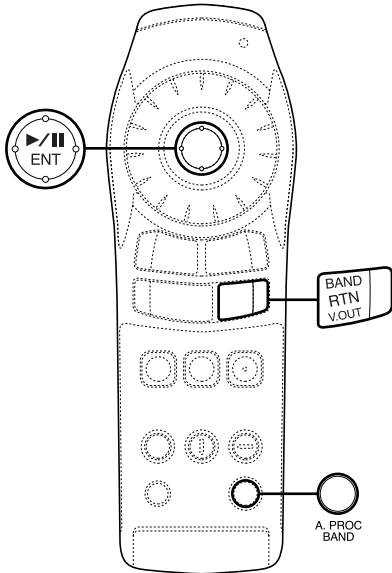

ADJUST – Setting the speaker mode



This adjustment cannot be made when Dolby Pro Logic is set to "OFF".

- 1 Select "ADJUST" under "Operating the digital audio processor (optional)" on page 40.
- 2 Use the "Joystick" to select the speaker to be set ("FRONT", "CENTER" or "REAR"), then press "ENT".

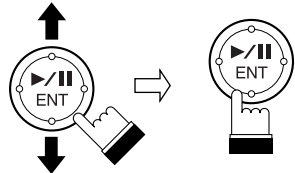

ADJUST		
SP FRONT	OUT	LV
CENTER	LARGE	
REAR	ON	
B1-PHANTOM	OFF	--
REAR MIX	---	--
CENTER DELAY		5
REAR DELAY		--
LISTENING	L-NIGHT	

- 3 Use the "Joystick" to switch the mode.

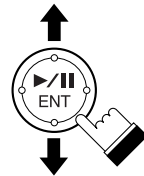

FRONT

LARGE/SMALL

CENTER

OFF/LARGE/SMALL

REAR

OFF/LARGE/SMALL

Note: Press "RTN" to return to the previous screen.

ADJUST – Adjusting the acoustic image



4 Press “A.PROC” to close the digital audio processor screen and return to the play-back screen.



4 Use the “Joystick” to select the level item, then press “ENT”.

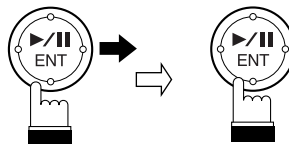

ADJUST – Adjusting the acoustic image



This adjustment cannot be made when Dolby Pro Logic is set to “OFF”.

1 Select “ADJUST” under “Operating the digital audio processor (optional)” on page 40.

5 Use the “Joystick” to adjust the level, then press “ENT”.

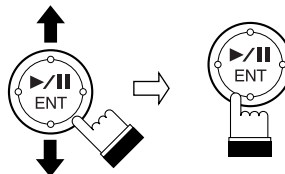

Note: Press “RTN” to return to the previous screen.

2 Use the “Joystick” to select “BI-PHANTOM”, then press “ENT”.

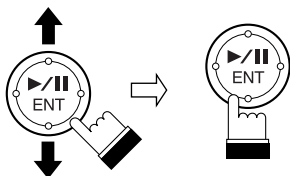

6 Press “A.PROC” to close the digital audio processor screen and return to the play-back screen.



ADJUST		
SP FRONT	OUT	LV
CENTER	LARGE	
REAR	ON	
BI-PHANTOM	OFF	—
REAR MIX	—	—
CENTER DELAY		5
REAR DELAY		—
L LISTENING	L-NIGHT	

3 Use the “Joystick” to select the mode (“ON” or “OFF”), then press “ENT”.

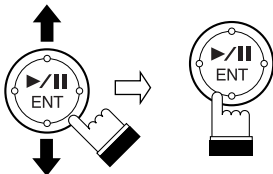

Note: The “BI-PHANTOM” setting is automatically set to “OFF” when the center speaker is set to “OFF”.





ADJUST – Mixing the rear audio channels

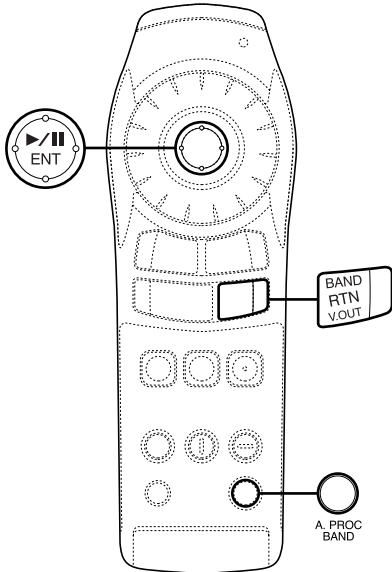

ADJUST – Mixing the rear audio channels



Use this function to mix the audio signals for the front to those output from the rear speakers.

1 Select “ADJUST” under “Operating the digital audio processor (optional)” on page 40.

2 Use the “Joystick” to select “REAR MIX”, then press “ENT”.

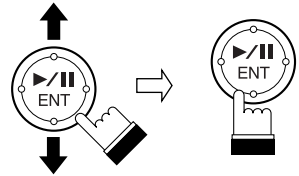

ADJUST			
SP FRONT	OUT	LV	
CENTER	LARGE	ON	
REAR	OFF	OFF	
B1-PHANTOM	OFF	—	
REAR MIX	—	—	
CENTER DELAY	—	5	
REAR DELAY	—	—	
L LISTENING	L-NIGHT		

3 Use the “Joystick” to select the mode (“ON” or “OFF”), then press “ENT”.

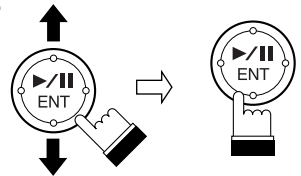

Note: The “REAR MIX” setting is automatically set to “OFF” when the rear speaker is set to “OFF”.

4 Use the “Joystick” to select the level item, then press “ENT”.

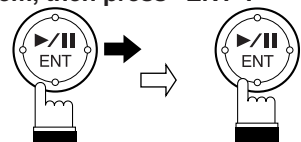

ADJUST – Center speaker time compensation



- 5 Use the “Joystick” to adjust the level, then press “ENT”.

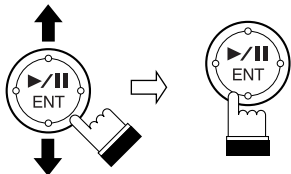

Note: Press “RTN” to return to the previous screen.

- 6 Press “A.PROC” to close the digital audio processor screen and return to the play-back screen.



ADJUST – Center speaker time compensation



Compensation is not possible when the center speaker is set to “OFF”.

- 1 Select “ADJUST” under “Operating the digital audio processor (optional)” on page 40.
- 2 Use the “Joystick” to select “CENTER DELAY”, then press “ENT”.

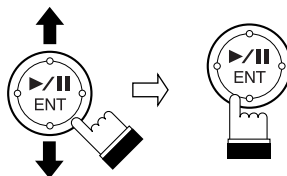

ADJUST	
SP FRONT	OUT. LV
CENTER	LARGE
REAR	ON
BI+PHANTOM	OFF
REAR MIX	OFF
CENTER DELAY	---
REAR DELAY	---
LISTENING	5
	L-NIGHT

- 3 Use the “Joystick” to adjust the level, then press “ENT”.

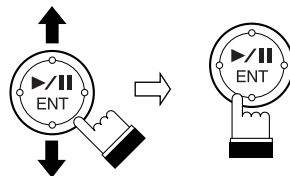

Note: Press “RTN” to return to the previous screen.

- 4 Press “A.PROC” to close the digital audio processor screen and return to the play-back screen.





ADJUST – Rear speaker time compensation

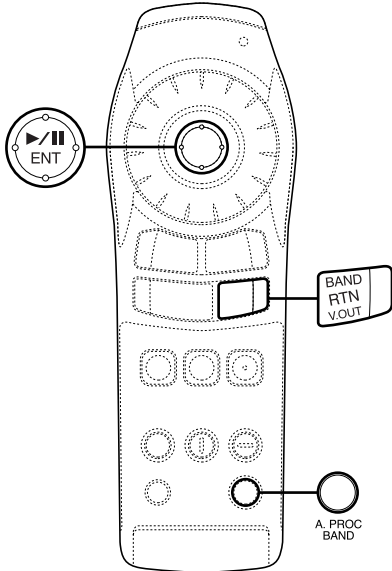

ADJUST – Rear speaker time compensation



Compensation is not possible when the rear speakers are set to “OFF”.

- 1 Select “ADJUST” under “Operating the digital audio processor (optional)” on page 40.
- 2 Use the “Joystick” to select “REAR DELAY”, then press “ENT”.

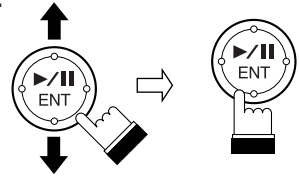

ADJUST			
SP FRONT	OUT	LV	
CENTER	LARGE	ON	
REAR	OFF	OFF	
BI-PHANTOM	OFF	—	
REAR MIX	—	—	
CENTER DELAY	—	5	
REAR DELAY	—	—	
L LISTENING	L-NIGHT	—	

- 3 Use the “Joystick” to adjust the level, then press “ENT”.

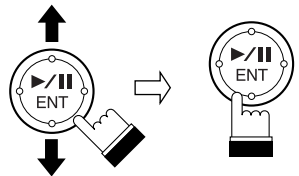

Note: Press “RTN” to return to the previous screen.

- 4 Press “A.PROC” to close the digital audio processor screen and return to the playback screen.



ADJUST – Achieving powerful sound at low volumes



ADJUST – Achieving powerful sound at low volumes



This setting is only possible with Dolby Digital outputs.

1 Select “ADJUST” under “Operating the digital audio processor (optional)” on page 40.

4 Press “A.PROC” to close the digital audio processor screen and return to the play-back screen.



2 Use the “Joystick” to select “LISTENING”, then press “ENT”.

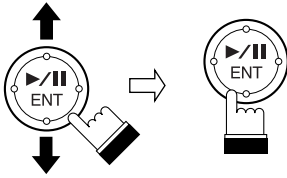

ADJUST	
SP FRONT	OUT. LV
CENTER	LARGE ON
REAR	OFF
BT-PHANTOM	OFF
REAR MIX	—
CENTER DELAY	5
REAR DELAY	—
LISTENING	L-NIGHT

3 Use the “Joystick” to select the mode.

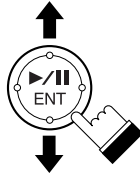

L-NIGHT

For powerful sound at low volumes (to compensate for high levels of background noise such as road noise)

STANDARD

For more powerful sound at regular volumes

MAXIMUM

For the regular sound

Note: Press “RTN” to return to the previous screen.





ADJUST – Adjusting the speaker level

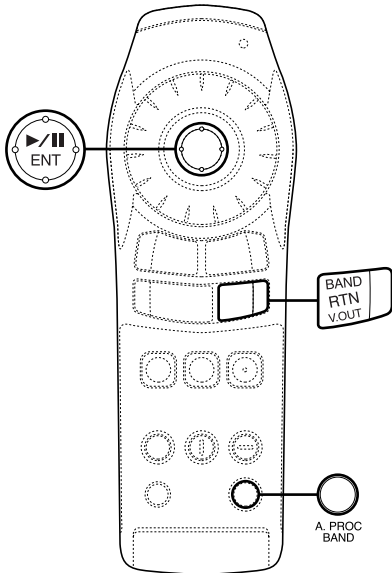

ADJUST – Adjusting the speaker level



1 Select “ADJUST” under “Operating the digital audio processor (optional)” on page 40.

2 Press “BAND” for at least 2 seconds to switch the “ADJUST” screen.

ADJUST			
TEST TONE	LV	OUTPUT	ON
FRONT L	-10	FL	C FR
CENTER	+10	BL	BL
FRONT R	0		
REAR R	+10	BR	BR
REAR L	0	RL	RL



3 Use the “Joystick” to select “TEST TONE”, then press “ENT”.

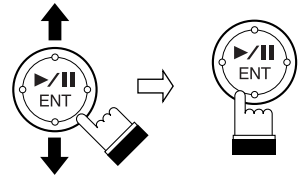

4 Use the “Joystick” to select “ON”, then press “ENT”.

Test tones are produced for two seconds from each speaker.

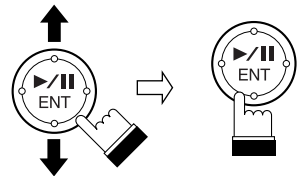

Note: Test tones are not produced from the center and rear speakers when these speakers are set to “OFF”.

MODE – Adjusting the volume, fader and balance



- 5 Use the “Joystick” to select the speaker, then press “ENT”.
Adjust so that the volume level from the different speakers is the same.

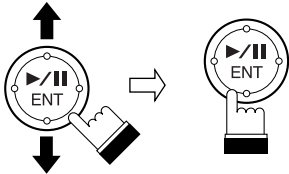

- 6 Use the “Joystick” to adjust the level, then press “ENT”.

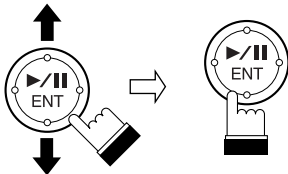

Note: Press “RTN” to return to the previous screen.

- 7 Once the levels of all the speakers have been adjusted, either set “TEST TONE” to “OFF” or press “A.PROC” to close the digital audio processor screen and return to the playback screen.



MODE – Adjusting the volume, fader and balance



When a head unit is connected using Ai-NET connections, adjust the volume, fader and balance from the head unit.

- 1 Select “MODE” under “Operating the digital audio processor (optional)” on page 40.

- 2 Use the “Joystick” to select the item to be adjusted, then press “ENT”.

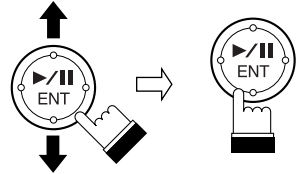

	MODE	35
VOLUME	F	8
FADER	L	15
BALANCE	OUT	LV
	ON	15
SUB-W	ON	
DEFEAT	ON	

- 3 Use the “Joystick” to adjust.

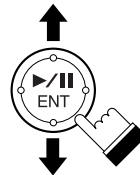

Note: Press “RTN” to return to the previous screen.

- 4 Press “A.PROC” to close the digital audio processor screen and return to the playback screen.





MODE – Adjusting the subwoofer

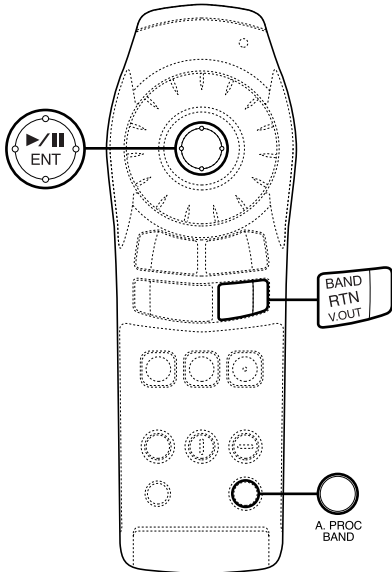

MODE – Adjusting the subwoofer



- 1 Select “MODE” under “Operating the digital audio processor (optional)” on page 40.

- 2 Use the “Joystick” to select “SUB-W”, then press “ENT”.

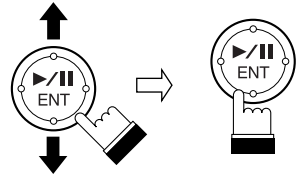

MODE	
VOLUME	35
FADER	F 8
BALANCE	L 15
SUB-W	ON
DEFEAT	ON
	L V 15

- 3 Use the “Joystick” to select the mode (“ON” or “OFF”), then press “ENT”.

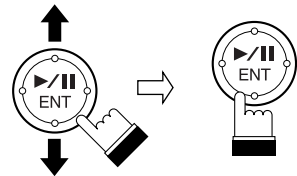

Note: The subwoofer cannot be adjusted when set to “OFF”.

- 4 Use the “Joystick” to select the level item, then press “ENT”.

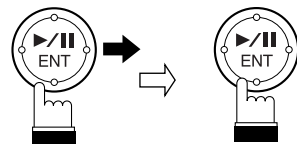



- 5 Use the “Joystick” to adjust the level, then press “ENT”.

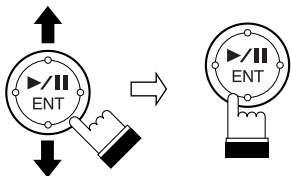

Note: Press “RTN” to return to the previous screen.

- 6 Press “A.PROC” to close the digital audio processor screen and return to the play-back screen.



MODE – Turning the defeat function on and off



- 1 Select “MODE” under “Operating the digital audio processor (optional)” on page 40.

- 2 Use the “Joystick” to select “DEFEAT”, then press “ENT”.

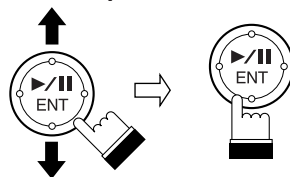

MODE		35
VOLUME	FADER	F 8
BALANCE		L 15
SUB-W		ON
DEFEAT		ON
OUT		LV
		15

- 3 Use the “Joystick” to select the mode (“ON” or “OFF”), then press “ENT”.

ON : The response is flat.
OFF : Off

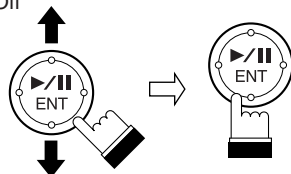

Notes:

- When “DEFEAT” is set to “ON”, the “PARAMETRIC-EQ”, “SURROUND”, “PRIVATE-MEMORY” and “TIME-CORRECTION” settings cannot be adjusted.
- Press “RTN” to return to the previous screen.

- 4 Press “A.PROC” to close the digital audio processor screen and return to the play-back screen.



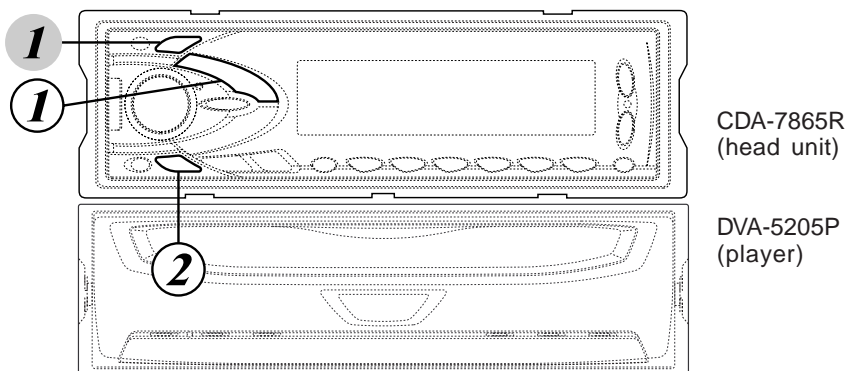

Operating from the head unit

The DVA-5205P can also be operated from the head unit. This section describes operations from the CDA-7865R (the recommended head unit). Note that some of the functions cannot be operated from the DVA-5205P.

Playing DVDs, video CDs and CDs

1 Press "SOURCE" and select the CD (DVA-5205P) mode.

The mode switches each time the button is pressed.

→ TUNER → CD (Built-in) → CD(DVA-5205P) → CHANGER * →

(* only when a changer is connected.)

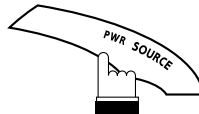

The DVA-5205P's power is on when the CD mode is selected, off when other modes are selected.

2 To set the pause mode, press "▶/||".

Press "▶/||" again to resume playback.

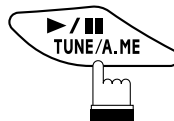

Note: Playback starts at the beginning of the disc **whenever** ignition is turned off or another Ai-NET source is selected.

Displaying the CD title

Press "TITLE" to display the CD title, etc., on the head unit's display.

- 1** Press "TITLE" on the head unit.
The display pattern changes each time the button is pressed.

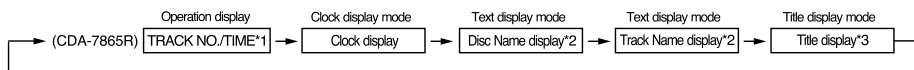

Notes:

- *1 In the TRACK NO./TIME display mode the time display shows 0:00 and does not move.
- *2 Displayed during playback of a text compatible CD (when using an optional text compatible). "NO TEXT" will be displayed when the CD is not text compatible.
- *3 "-----" will be displayed when the title has not been inputted.

<Functions operable from the CDA-7865R>

Switch	Operation
SOURCE	Turns the power on and off. When pressed again, the source switches. The DVD player's power is on when the CD mode is selected, off when other modes are selected.
TITLE	Switches the display pattern. / Sets the title input mode.
RPT	DVD: Chapter repeat Video CD/CD: Switches between track repeat and disc repeat
▶▶	Starts playback from the beginning of the following chapter/track. When pressed and held in, fast-forwards the disc.
◀◀	Starts playback from the beginning of the current chapter/track. When pressed and held in, fast-reverses the disc.
▶/	Switches between play and pause.
Rotary Encoder	Adjust the volume.

Notes:

- The functions and operations may differ when using with a head unit other than the CDA-7865R.
- For video CDs with playback control (PBC), turn PBC off.
- Titles can be input for video CDs and CDs. For details, refer to the operating instructions of the connected head unit.



Operating from the head unit's remote control unit

The DVA-5205P can be operated from the remote control unit included with the head unit.

Remote control operations

Remote Control unit		Operation		
		RUE-4185	RUE-4160	RUE-4167
P10	Power on/off	○	○	○
P14	Fast-forward/fast-reverse	○	○	○
P15	Still picture (pause)	○	○	○
P14	Chapter/track search	○	○	○

- There may be restrictions to some of the functions and displays depending on the Ai-NET compatible product (head unit/remote control unit) being used.

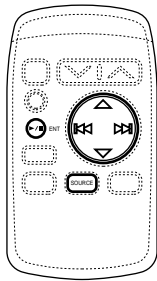

RUE-4185

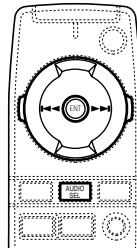

RUE-4160

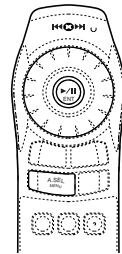

RUE-4167

Operating DVDs, video CDs and CDs

First see "Remote control operations" (page 58).

- 1 Press "SOURCE", "AUDIO SEL" or "A. SEL" to set the CD (DVA-5205P) mode.**
 The DVA-5205P's power is on when the CD mode is selected, off when other modes are selected.
- 2 To set the pause mode, press "▶/||" or "ENT".**
 Press "▶/||" or "ENT" again to resume playback.
- 3 Press and hold "◀◀" or "▶▶" continuously to make FF or RW operation. (RUE-4185, RUE-4160)**
 Tilt and hold the joystick in left or right direction to make FF or RW operation. (RUE-4167)
- 4 Press "◀◀" or "▶▶" to make a track or chapter skip. (RUE-4185, RUE-4160)**
 Tilt the joystick in left or right direction to make a track or chapter skip. (RUE-4167)



Notes:

- For adjusting the volume and other basic operations, refer to the head unit's operating instructions.
- For video CDs with playback control (PBC), turn PBC off.

⚠ Warning DO NOT OPERATE ANY FUNCTION THAT TAKES YOUR ATTENTION AWAY FROM SAFELY DRIVING YOUR VEHICLE. Any function that requires your prolonged attention should only be performed after coming to a complete stop. Always stop the vehicle in a safe location before performing these functions. Failure to do so may result in an accident.

Terminology

Dolby Digital

Dolby Digital is a digital audio compression technology developed by Dolby Laboratories. It is compatible with not only stereo (2-channel) sound, but also 5.1-channel surround sound. The signals for the different channels are completely independent, so large quantities of audio data can be recorded efficiently on discs, and since the sound is digital there is little loss of sound quality.

- * The separately sold digital audio processor (PXA-H510) is required to enjoy Dolby Digital sound.

DTS

This is a home-use digital sound format of the DTS Sound System. This is a high quality sound system, developed by Digital Theater Systems Corp for use in movie theaters.

DTS has six independent sound tracks. The theater presentation is fully realized in the home and other settings. DTS is the abbreviation for Digital Theater System.

- * To enjoy DTS surround sound you need the separately sold DTS digital audio processor. The DVD video software must also have a DTS sound track.

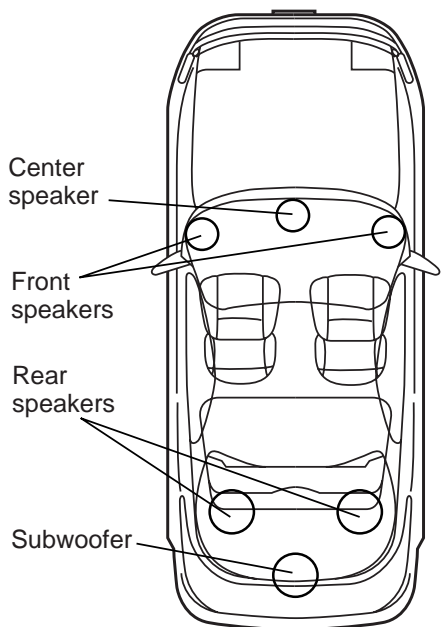

Speaker layout for enjoying Dolby Digital sound/dts sound

Dolby Pro Logic

Dolby Pro Logic is a Dolby Surround format encoded onto two channels. Proper decoding reproduces four channels (front left/right, center and rear surround (monaural)) upon playback.

- * The separately sold digital audio processor (PXA-H510) is required to enjoy Dolby Pro Logic sound.

Linear PCM audio (LPCM)

LPCM is a signal recording format used for music CDs. Whereas music CDs are recorded at 44.1 kHz/16 bits, DVDs are recorded at 48 kHz/16 bits to 95 kHz/24 bits, thereby achieving higher sound quality than music CDs.

Rating levels (parental lock)

This is a function of the DVD for restricting the viewing age as stipulated by laws in different countries. The way in which viewing is restricted differs from DVD to DVD. Sometimes the DVD cannot be played at all, other times certain scenes are skipped, and other times certain scenes are replaced with other scenes.

List of language codes

List of language codes

(For details, see page 25.)

Abbreviation	Code	Language	Abbreviation	Code	Language
AA	6565	Afar	HY	7289	Armenian
AB	6566	Abkhazian	IA	7365	Interlingua
AF	6570	Afrikaans	IE	7369	Interlingue
AM	6577	Amharic	IK	7375	Inupiak
AR	6582	Arabic	IN	7378	Indonesian
AS	6583	Assamese	IS	7383	Icelandic
AY	6589	Aymara	IT	7384	Italian
AZ	6590	Azerbaijani	IW	7387	Hebrew
BA	6665	Bashkir	JA	7465	Japanese
BE	6669	Byelorussian	JI	7473	Yiddish
BG	6671	Bulgarian	JW	7487	Javanese
BH	6672	Bihari	KA	7565	Georgian
BI	6673	Bislama	KK	7575	Kazakh
BN	6678	Bengali, Bangla	KL	7576	Greenlandic
BO	6679	Tibetan	KM	7577	Cambodian
BR	6682	Breton	KN	7578	Kannada
CA	6765	Catalan	KO	7579	Korean
CO	6779	Corsican	KS	7583	Kashmiri
CS	6783	Czech	KU	7585	Kurdish
CY	6789	Welsh	KY	7589	Kirghiz
DA	6865	Danish	LA	7665	Latin
DE	6869	German	LN	7678	Lingala
DZ	6890	Bhutani	LO	7679	Laotian
EL	6976	Greek	LT	7684	Lithuanian
EN	6978	English	LV	7686	Latvian, Lettish
EO	6979	Esperanto	MG	7771	Malagasy
ES	6983	Spanish	MI	7773	Maori
ET	6984	Estonian	MK	7775	Macedonian
EU	6985	Basque	ML	7776	Malayalam
FA	7065	Persian	MN	7778	Mongolian
FI	7073	Finnish	MO	7779	Moldavian
FJ	7074	Fiji	MR	7782	Marathi
FO	7079	Faroese	MS	7783	Malay
FR	7082	French	MT	7784	Maltese
FY	7089	Frisian	MY	7789	Burmese
GA	7165	Irish	NA	7865	Nauru
GD	7168	Scots Gaelic	NE	7869	Nepali
GL	7176	Galician	NL	7876	Dutch
GN	7178	Guarani	NO	7879	Norwegian
GU	7185	Gujarati	OC	7967	Occitan
HA	7265	Hausa	OM	7977	(Afan) Oromo
HI	7273	Hindi	OR	7982	Oriya
HR	7282	Croatian	PA	8065	Punjabi
HU	7285	Hungarian	PL	8076	Polish

List of language codes

List of language codes (Continued)

(For details, see page 25.)

Abbreviation	Code	Language	Abbreviation	Code	Language
PS	8083	Pashto, Pushto	SW	8387	Swahili
PT	8084	Portuguese	TA	8465	Tamil
QU	8185	Quechua	TE	8469	Telugu
RM	8277	Rhaeto-Romance	TG	8471	Tajik
RN	8278	Kirundi	TH	8472	Thai
RO	8279	Romanian	TI	8473	Tigrinya
RU	8285	Russian	TK	8475	Turkmen
RW	8287	Kinyarwanda	TL	8476	Tagalog
SA	8365	Sanskrit	TN	8478	Setswana
SD	8368	Sindhi	TO	8479	Tongan
SG	8371	Sangho	TR	8482	Turkish
SH	8372	Serbo-Croatian	TS	8483	Tsonga
SI	8373	Singhalese	TT	8484	Tatar
SK	8375	Slovak	TW	8487	Twi
SL	8376	Slovenian	UK	8575	Ukrainian
SM	8377	Samoan	UR	8582	Urdu
SN	8378	Shona	UZ	8590	Uzbek
SO	8379	Somali	VI	8673	Vietnamese
SQ	8381	Albanian	VO	8679	Volapuk
SR	8382	Serbian	WO	8779	Wolof
SS	8383	Siswati	XH	8872	Xhosa
ST	8384	Sesotho	YO	8979	Yoruba
SU	8385	Sundanese	ZH	9072	Chinese
SV	8386	Swedish	ZU	9085	Zulu

List of country codes

(For details, see page 27.)

Abbreviation	Code	Country	Abbreviation	Code	Country
AD	6568	Andorra	CL	6776	Chile
AE	6569	United Arab Emirates	CM	6777	Cameroon
AF	6570	Afghanistan	CN	6778	China
AG	6571	Antigua and Barbuda	CO	6779	Colombia
AI	6573	Anguilla	CR	6782	Costa Rica
AL	6576	Albania	CU	6785	Cuba
AM	6577	Armenia	CV	6786	Cape Verde
AN	6578	Netherlands Antilles	CX	6788	Christmas Island
AO	6579	Angola	CY	6789	Cyprus
AQ	6581	Antarctica	CZ	6790	Czech Republic
AR	6582	Argentina	DE	6869	Germany
AS	6583	American Samoa	DJ	6874	Djibouti
AT	6584	Austria	DK	6875	Denmark
AU	6585	Australia	DM	6877	Dominica
AW	6587	Aruba	DO	6879	Dominican Republic
AZ	6590	Azerbaijan	DZ	6890	Algeria
BA	6665	Bosnia and Herzegovina	EC	6967	Ecuador
BB	6666	Barbados	EE	6969	Estonia
BD	6668	Bangladesh	EG	6971	Egypt
BE	6669	Belgium	EH	6972	Western Sahara
BF	6670	Burkina Faso	ER	6982	Eritrea
BG	6671	Bulgaria	ES	6983	Spain
BH	6672	Bahrain	ET	6984	Ethiopia
BI	6673	Burundi	FI	7073	Finland
BJ	6674	Benin	FJ	7074	Fiji
BM	6677	Bermuda	FK	7075	Falkland Islands
BN	6678	Brunei Darussalam	FM	7077	Micronesia, Federated States of
BO	6679	Bolivia	FO	7079	Faroe Islands
BR	6682	Brazil	FR	7082	France
BS	6683	Bahamas	GA	7165	Gabon
BT	6684	Bhutan	GB	7166	United Kingdom
BV	6686	Bouvet Island	GD	7168	Grenada
BW	6687	Botswana	GE	7169	Georgia
BY	6689	Belarus	GF	7170	French Guiana
BZ	6690	Belize	GH	7172	Ghana
CA	6765	Canada	GI	7173	Gibraltar
CC	6767	Cocos (Keeling) Islands	GL	7176	Greenland
CD	6768	Congo, the Democratic Republic of the	GM	7177	Gambia
CF	6770	Central African Republic	GN	7178	Guinea
CG	6771	Congo	GP	7180	Guadeloupe
CH	6772	Switzerland	GQ	7181	Equatorial Guinea
CI	6773	Cote d'Ivoire	GR	7182	Greece
CK	6775	Cook Islands			

List of country codes

List of country codes (Continued)

(For details, see page 27.)

Abbreviation	Code	Country	Abbreviation	Code	Country
GS	7183	South Georgia and the South Sandwich Islands	LS	7683	Lesotho
GT	7184	Guatemala	LT	7684	Lithuania
GU	7185	Guam	LU	7685	Luxembourg
GW	7187	Guinea-Bissau	LV	7686	Latvia
GY	7189	Guyana	LY	7689	Libyan Arab Jamahiriya
HK	7275	Hong Kong	MA	7765	Morocco
HM	7277	Heard Island and McDonald Islands	MC	7767	Monaco
HN	7278	Honduras	MD	7768	Moldova, Republic of
HR	7282	Croatia	MG	7771	Madagascar
HT	7284	Haiti	MH	7772	Marshall Islands
HU	7285	Hungary	MK	7775	Macedonia, The former Yugoslav Republic of
ID	7368	Indonesia	ML	7776	Mali
IE	7369	Ireland	MM	7777	Myanmar
IL	7376	Israel	MN	7778	Mongolia
IN	7378	India	MO	7779	Macau
IO	7379	British Indian Ocean Territory	MP	7780	Northern Mariana Islands
IQ	7381	Iraq	MQ	7781	Martinique
IR	7382	Iran, Islamic Republic of	MR	7782	Mauritania
IS	7383	Iceland	MS	7783	Montserrat
IT	7384	Italy	MT	7784	Malta
JM	7477	Jamaica	MU	7785	Mauritius
JO	7479	Jordan	MV	7786	Maldives
JP	7480	Japan	MW	7787	Malawi
KE	7569	Kenya	MX	7788	Mexico
KG	7571	Kyrgyzstan	MY	7789	Malaysia
KH	7572	Cambodia	MZ	7790	Mozambique
KI	7573	Kiribati	NA	7865	Namibia
KM	7577	Comoros	NC	7867	New Caledonia
KN	7578	Saint Kitts and Nevis	NE	7869	Niger
KP	7580	Korea, Democratic People's Republic of	NF	7870	Norfolk Island
KR	7582	Korea, Republic of	NG	7871	Nigeria
KW	7587	Kuwait	NI	7873	Nicaragua
KY	7589	Cayman Islands	NL	7876	Netherlands
KZ	7590	Kazakstan	NO	7879	Norway
LA	7665	Lao People's Democratic Republic	NP	7880	Nepal
LB	7666	Lebanon	NR	7882	Nauru
LC	7667	Saint Lucia	NU	7885	Niue
LI	7673	Liechtenstein	NZ	7890	New Zealand
LK	7675	Sri Lanka	OM	7977	Oman
LR	7682	Liberia	PA	8065	Panama
			PE	8069	Peru
			PF	8070	French Polynesia
			PG	8071	Papua New Guinea

List of country codes

List of country codes (Continued)

(For details, see page 27.)

Abbreviation	Code	Country	Abbreviation	Code	Country
PH	8072	Philippines	TJ	8474	Tajikistan
PK	8075	Pakistan	TK	8475	Tokelau
PL	8076	Poland	TM	8477	Turkmenistan
PM	8077	Saint Pierre and Miquelon	TN	8478	Tunisia
PN	8078	Pitcairn	TO	8479	Tonga
PR	8082	Puerto Rico	TP	8480	East Timor
PT	8084	Portugal	TR	8482	Turkey
PW	8087	Palau	TT	8484	Trinidad and Tobago
PY	8089	Paraguay	TV	8486	Tuvalu
QA	8165	Qatar	TW	8487	Taiwan, Province of China
RE	8269	Reunion	TZ	8490	Tanzania, United Republic of
RO	8279	Romania	UA	8565	Ukraine
RU	8285	Russian Federation	UG	8571	Uganda
RW	8287	Rwanda	UM	8577	United States Minor Outlying Islands
SA	8365	Saudi Arabia	US	8583	United States
SB	8366	Solomon Islands	UY	8589	Uruguay
SC	8367	Seychelles	UZ	8590	Uzbekistan
SD	8368	Sudan	VA	8665	Holy See (Vatican City State)
SE	8369	Sweden	VC	8667	Saint Vincent and the Grenadines
SG	8371	Singapore	VE	8669	Venezuela
SH	8372	Saint Helena	VG	8671	Virgin Island, British
SI	8373	Slovenia	VI	8673	Virgin Islands, U.S.
SJ	8374	Svalbard and Jan Mayen	VN	8678	Viet Nam
SK	8375	Slovakia	VU	8685	Vanuatu
SL	8376	Sierra Leone	WF	8770	Wallis and Futuna
SM	8377	San Marino	WS	8783	Samoa
SN	8378	Senegal	YE	8969	Yemen
SO	8379	Somalia	YT	8984	Mayotte
SR	8382	Suriname	YU	8985	Yugoslavia
ST	8384	Sao Tome and Principe	ZA	9065	South Africa
SV	8386	El Salvador	ZM	9077	Zambia
SY	8389	Syrian Arab Republic	ZW	9087	Zimbabwe
SZ	8390	Swaziland			
TC	8467	Turks and Caicos Islands			
TD	8468	Chad			
TF	8470	French Southern Territories			
TG	8471	Togo			
TH	8472	Thailand			

In case of difficulty

- If operation freezes, the screen goes black or the unit should otherwise not function properly, try turning the power off then back on. Alternatively, try the following methods in the order listed until the DVA-5205P returns to normal playback mode:
 - 1) Change the source from DVD to another source then return to DVD mode.
 - 2) Turn the car's ignition OFF and back ON again.
 - 3) Press the RESET button on the face of the DVA-5205P.
- This guide will help you isolate the problem if the unit is at fault. Otherwise, make sure the rest of your system is properly connected or consult your authorized Alpine dealer.

Symptom	Cause	Remedy
Unit does not operate.	Fuse is blown.	Replace with a fuse of the specified capacity. (See installation instructions.)
	Monitor's power is not turned on.	Turn on the monitor's power.
	Condensation.	Wait a while (about 1 hour) for the condensation to dry.
Operation is unstable.	Remote control unit's batteries are worn.	Replace the remote control unit's batteries with new ones.
	Remote control sensor or transmitter is dirty.	Clean the sensor or transmitter.
No picture is produced.	Monitor's mode is not switched to the mode you want to see.	Switch to the mode you want to see.
	Monitor's parking brake cord is not connected.	Connect the monitor's parking brake cord and set the parking brake.
	Monitor's parking brake is not set.	(For details, refer to the monitor's instructions.)
Playback does not start.	Disc is loaded upside-down.	Check the disc and load it with the labeled side facing upward.
	Disc is dirty.	Clean the disc.
	A disc not able to playback with this unit is loaded.	Check if the disc is able to be played back.
	Parental lock is set.	Cancel the parental lock or change the rating level.
	Setup menu is displayed.	Press "SET" to turn the menu off.
Picture is unclear or noisy.	Disc is being fast-forwarded or fast-reversed.	The picture may be slightly disturbed, but this is normal.
	Vehicle's battery power is weak.	Check the battery power and wiring. (The unit may malfunction if the battery power is under 11 volts with a load applied.)
	Monitor's fluorescent tube is worn.	Replace the monitor's fluorescent tube.
Image stops sometimes.	Disc is scratched.	Replaced with a non-scratched disc.
NO DISC	No disc is loaded.	Load a disc.
	Disc is dirty.	Clean the disc.
NOT VALID	Remote control operation is not possible.	For some discs or playing modes, certain operations are not possible. This is not a malfunction.
REGIONAL CODE VIOLATION	Disc does not match regional code number.	Load a disc that matches the regional code number.
VIDEO SIGNAL SYSTEM IS NOT CORRECT	NTSC disc is loaded.	Load a PAL disc.
HI-TEMP	Protective circuit is activated to high temperature.	Turn the power (main unit power when not connected) OFF on the connected head unit and then turn the power ON again. If the display still does not disappear, leave the power OFF until the temperature decreases and then turn the power ON again.

Specifications

Signal system	NTSC/PAL
Horizontal resolution	500 lines or greater
Video output level	1Vp-p (75 ohms)
Video S/N ratio	DVD: 60 dB
Audio S/N ratio	DVD: 95 dB
	CD: 93 dB
Frequency response	DVD: 5 Hz to 22 kHz (± 1 dB) (48 kHz sampling)
	DVD: 5 Hz to 44 kHz (± 1 dB) (96 kHz sampling)
	CD: 5 Hz to 20 kHz (± 1 dB)
Dynamic range	DVD: 90 dB or greater
	CD: 93 dB or greater
Wow & flutter	Below measurable limit
Channel separation	80 dB
Harmonic distortion	0.03%
Audio output	800 mV
Power supply	DC 14.4V (operating range: 11 to 16V)
Operating temperature range	-10° to $+60^{\circ}\text{C}$
Weight	1.6 kg (3 lbs. 8 oz)
External dimensions (W x H x D)	178 x 50 x 185 mm (7" x 2" x 7-1/4")

- For improvement purposes, specifications and design are subject to change without notice.
- The illustrations in this manual may appear different from the actual product due to printing conditions.

Functions of remote control unit buttons

Operating the DVA-5205P DVD Video Player

When operating the DVA-5205P set the DVD/AUDIO switch to the "DVD" side.

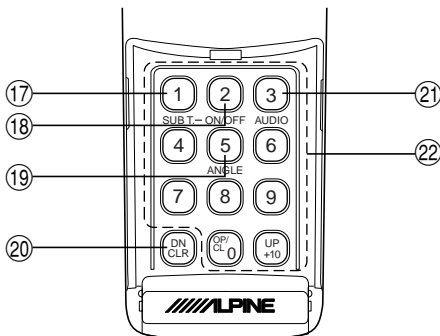
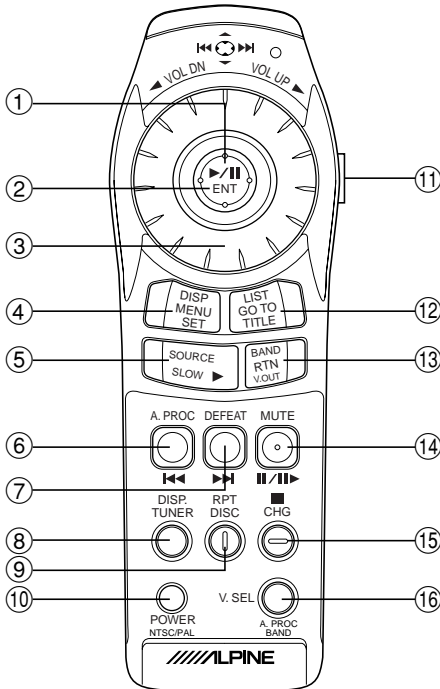

- ① **Joy Stick** (→ P13, 21, 24, 25, 26, 29, 30, 32, 34, 35, 36, 38, 40, 41, 42, 43, 44, 45, 46, 47, 48, 49, 50, 51, 52, 53, 54, 55)

Selects the items displayed on the screen.

- ② **ENT button** (→ P13, 17, 19, 21, 24, 25, 26, 27, 28, 29, 30, 32, 34, 35, 36, 38, 40, 41, 42, 43, 44, 45, 46, 47, 48, 49, 50, 51, 52, 53, 54, 55)

Determines the selected item.

- ③ **Rotary Encoder** (→ P11)

Adjusts the volume when only the Digital Audio Processor is connected.

- ④ **MENU button** (→ P12, 13, 17, 18, 19, 21)

Displays the DVD menu.

SET button (→ P24, 25, 27, 29, 31, 33, 35, 37, 39)

Press and hold for 2 seconds to summon the SET UP (initial setting) screen.

- ⑤ **▶ Button** (→ P12, 13, 14, 15, 21)

Playback.

SLOW Button (→ P15)

Press and hold for 2 seconds for slow motion playback.

- ⑥ **◀◀ Button** (→ P14)

Seeks the start for video and audio data.

Press and hold for 2 seconds for Rewind of video and audio data.

- ⑦ **▶▶▶ Button** (→ P14)

Seeks the start for video and audio data.

Press and hold for 2 seconds for Fast Forward of video and audio data.

- ⑧ **DISP. Button** (→ P21, 22)

Displays the playback state on the screen.

Functions of remote control unit buttons

- ⑨ **RPT Button (→ P19)**
Repeat playback.
- ⑩ **POWER Button (→ P10)**
Turns the power ON and OFF.
- NTSC/PAL Button (→ P11)**
Press and hold for 5 seconds to change between NTSC and PAL.
- ⑪ **DVD/AUDIO Switch (→ P8)**
Used to switch between DVD and Audio operation.
- ⑫ **GO TO Button (→ P16, 17, 18)**
Used to go directly to start of selection.
- TITLE Button (→ P12, 21)**
Press and hold for 2 seconds to display the Title Menu.
- ⑬ **RTN Button (→ P16, 17, 18, 25, 27, 29, 31, 33, 35, 37, 39, 41, 43, 44, 45, 46, 47, 49, 50, 51, 53, 55)**
Used to return the selection screen just prior to the present screen.
- V.OUT Button (→ P23)**
Used to switch between Video and Audio output to the rear monitor.
- ⑭ **II / III▶ Button (→ P15)**
Used for Pause and Frame-by-Frame playback.
- ⑮ **■ Button (→ P13)**
Used to stop playback.
- ⑯ **A.PROC Button (→ P40, 41, 43, 44, 45, 47, 49, 50, 51, 53, 55)**
Used to summon the processor control screen when connected with the Digital Audio Processor.
- BAND Button (→ P41, 52)**
Press and hold for 2 seconds to switch the menu screen when controlling the Digital Audio Processor.
- ⑰ **SUB T. Button (→ P20)**
Press and hold for 2 seconds to change the subtitles.
- ⑱ **-ON/OFF Button (→ P21)**
Press and hold for 2 seconds to turn the subtitles ON and OFF.
- ⑲ **ANGLE Button (→ P20)**
Press and hold for 2 seconds to change the angle.
- ⑳ **CLR Button (→ P16, 17, 18, 27)**
Remove numbers (one character at a time) that have been selected and input.
Press and hold for 2 seconds. All the characters which were selected and input are erased.
- ㉑ **AUDIO Button (→ P19)**
Press and hold for 2 seconds to change the audio output.
- ㉒ **10-Key Pad (→ P11, 13, 16, 17, 18, 21, 25, 27, 28)**
Used to input numbers.

Note: Operation may not be accepted depending on the type of disc and the playback conditions. At such a time the following mark is displayed on the screen: ⊙

Functions of remote control unit buttons

Operating audio for the Alpine Ai-NET

When operating audio for the Alpine Ai-NET, set the DVD/AUDIO switch to the "AUDIO" side.

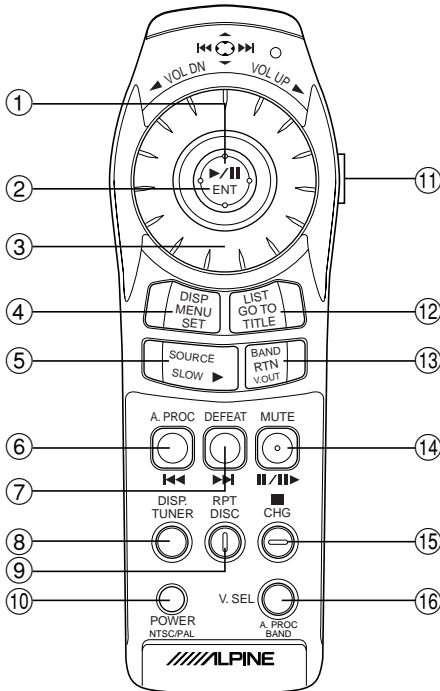

- ① **Joy Stick**
Music Sensor/Fast Forward/Rewind/
Disc Change/Preset Selection/SEEK
- ② **ENT Button**
Play/Pause
- ③ **Rotary Encoder**
Volume adjustment
- ④ **DISP Button**
Spectrum Analyzer display ON/OFF
- ⑤ **SOURCE Button**
Source switching
- ⑥ **A.PROC Button**
Audio Processor Switch
- ⑦ **DEFEAT Button**
Defeat Mode ON/OFF.
- ⑧ **TUNER Button**
Switches to Radio Mode.
- ⑨ **DISC Button**
Slave CD/MD mode switching.
- ⑩ **Power Button**
Power ON/OFF switching.
- ⑪ **DVD/AUDIO Switch**
Switching between DVD and Audio
operation.
- ⑫ **LIST Button**
Changes the title list display.
Press and hold for 2 seconds to switch
to title input screen.
- ⑬ **BAND Button**
Radio Band switching
- ⑭ **MUTE Button**
Mute
- ⑮ **CHG Button**
Switches to CHANGE Mode.
- ⑯ **V.SEL Button**
V.SEL Switching

Note: Some controls may not be possible depending on the audio device being used.





SERIAL NUMBER/NUMERO DE SERIE/NUMERO DE SERIE: _____

INSTALLATION DATE/DATE D'INSTALLATION/FECHA DE INSTALACION: _____

INSTALLATION TECHNICIAN/INSTALLATEUR/INSTALADOR: _____

PLACE OF PURCHASE/LIEU D'ACHAT/LUGAR DE ADQUISICION: _____

Alpine Electronics, Inc.

Tokyo office: 1-1-8 Nishi Gotanda,
Shinagawa-ku, Tokyo 141-8501, Japan
Tel.: (03) 3494-1101

Alpine Electronics of America, Inc.

19145 Gramercy Place, Torrance,
California 90501, U.S.A.
Tel.: 1-800-ALPINE-1 (1-800-257-4631)

Alpine Electronics of Canada, Inc.

Suite 203, 7300 Warden Ave. Markham,
Ontario L3R 9Z6, Canada
Tel.: 1-800-ALPINE-1 (1-800-257-4631)

Alpine Electronics of Australia Pty. Ltd.

6-8 Fiveways Boulevard Keysborough,
Victoria 3173, Australia
Tel.: (03) 9769-0000

Alpine Electronics GmbH

Kreuzerkamp 7-11 40878 Ratingen,
Germany
Tel.: 02102-45 50

Alpine Italia S.p.A.

Via C. Colombo 8, 20090 Trezzano Sul
Naviglio MI, Italy
Tel.: 02-48 47 81

Alpine Electronics France S.A.R.L.

(RCS PONTOISE B 338 101 280)
98, Rue De La Belle Etoile, Z.I. Paris Nord II
B.P. 50016 F-95945, Roissy,
Charles de Gaulle Cedex, France
Tel.: 01-48 63 89 89

Alpine Electronics of U. K., Ltd.

13 Tanners Drive, Blakelands,
Milton Keynes MK14 5BU, U.K.
Tel.: 01908-61 15 56

ALPINE ELECTRONICS DE ESPAÑA, S.A.

Portal De Gamarra 36, Pabellón 32
01013 Vitoria (Alava) - Apdo. 133, Spain
Tel.: 34-45-283588

Designed by ALPINE Japan

Printed in Japan (S)

68P30540Y28-O

Sankei Kikaku Co., Ltd.
1-13-38, Hinodai,
Hino, Tokyo, Japan

Free Manuals Download Website

<http://myh66.com>

<http://usermanuals.us>

<http://www.somanuals.com>

<http://www.4manuals.cc>

<http://www.manual-lib.com>

<http://www.404manual.com>

<http://www.luxmanual.com>

<http://aubethermostatmanual.com>

Golf course search by state

<http://golfingnear.com>

Email search by domain

<http://emailbydomain.com>

Auto manuals search

<http://auto.somanuals.com>

TV manuals search

<http://tv.somanuals.com>