



# DVI-9990

## DVD-Audio/Video Tuner

**Guide for Installation and Connections**

**English**

**Guide d'installation et de connexions**

**Français**

**Guía de instalación y conexiones**

**Español**



**ALPINE ELECTRONICS MARKETING, INC.**

1-1-8 Nishi Gotanda,  
Shinagawa-ku, Tokyo 141-0031, Japan  
Phone 03-5496-8231

**ALPINE ELECTRONICS OF AMERICA, INC.**

19145 Gramercy Place, Torrance,  
California 90501, U.S.A.  
Phone 1-800-ALPINE-1 (1-800-257-4631)

**ALPINE ELECTRONICS OF CANADA, INC.**

7300 Warden Ave., Suite 203, Markham,  
Ontario L3R 9Z6, Canada  
Phone 1-800-ALPINE-1 (1-800-257-4631)

**ALPINE ELECTRONICS OF AUSTRALIA PTY. LTD.**

6-8 Fiveways Boulevard Keysborough,  
Victoria 3173, Australia  
Phone 03-9769-0000

**ALPINE ELECTRONICS GmbH**

Frankfurter Ring 117, 80807 München,  
Germany  
Phone 089-32 42 640

**ALPINE ELECTRONICS OF U.K. LTD.**

Alpine House  
Fletchamstead Highway,  
Coventry CV4 9TW, U.K.  
Phone 0870-33 33 763

**ALPINE ELECTRONICS FRANCE S.A.R.L.**

(RCS PONTOISE B 338 101 280)  
98, Rue de la Belle Etoile, Z.I. Paris  
Nord II, B.P. 50016, 95945 Roissy  
Charles de Gaulle Cedex, France  
Phone 01-48638989

**ALPINE ITALIA S.P.A.**

Viale C. Colombo 8, 20090 Trezzano  
Sul Naviglio (MI), Italy  
Phone 02-484781

**ALPINE ELECTRONICS DE ESPAÑA, S.A.**

Portal de Gamarra 36, Pabellón, 32  
01013 Vitoria (Alava) - APDO 133, Spain  
Phone 945-283588

# PRECAUTIONS



## GUIDE FOR INSTALLATION AND CONNECTIONS

- Please read this GUIDE FOR INSTALLATION AND CONNECTIONS and the OWNER'S MANUAL thoroughly to familiarize yourself with each control and function. We at ALPINE hope that your new DVI-9990 will give you many years of listening enjoyment. In case of problems when installing your unit, please contact your authorized ALPINE dealer.

### Points to Observe for Safe Usage

- Read this manual carefully before starting operation and use this system safely. We cannot be responsible for problems resulting from failure to observe the instructions in this manual.
- This manual uses various pictorial displays to show how to use this product safely and to avoid harm to yourself and others and damage to your property. Here is what these pictorial displays mean. Understanding them is important for reading this manual.

- **Meaning of displays**

 <b>Warning</b>	This symbol means important instructions. Failure to heed them can result in serious injury or death.
 <b>Caution</b>	This symbol means important instructions. Failure to heed them can result in injury or property damage.

### **Warning**

**DO NOT DISASSEMBLE OR ALTER.** Doing so may result in an accident, fire or electric shock.

**USE THE CORRECT AMPERE RATING WHEN REPLACING FUSES.** Failure to do so may result in fire or electric shock.

**MAKE THE CORRECT CONNECTIONS.** Failure to make the proper connections may result in fire or product damage.

**USE ONLY IN CARS WITH A 12 VOLT NEGATIVE GROUND.** (Check with your dealer if you are not sure.) Failure to do so may result in fire, etc.

**BEFORE WIRING, DISCONNECT THE CABLE FROM THE NEGATIVE BATTERY TERMINAL.** Failure to do so may result in electric shock or injury due to electrical shorts.

**DO NOT ALLOW CABLES TO BECOME ENTANGLED IN SURROUNDING OBJECTS.** Arrange wiring and cables in compliance with the manual to prevent obstructions when driving. Cables or wiring that obstruct or hang up on places such as the steering wheel, gear lever, brake pedals, etc. can be extremely hazardous.

**DO NOT SPLICE INTO ELECTRICAL CABLES.** Never cut away cable insulation to supply power to other equipment. Doing so will exceed the current carrying capacity of the wire and result in fire or electric shock.

---

**DO NOT DAMAGE PIPE OR WIRING WHEN DRILLING HOLES.** When drilling holes in the chassis for installation, take precautions so as not to contact, damage or obstruct pipes, fuel lines, tanks or electrical wiring. Failure to take such precautions may result in fire.

---

**DO NOT USE BOLTS OR NUTS IN THE BRAKE OR STEERING SYSTEMS TO MAKE GROUND CONNECTIONS.** Bolts or nuts used for the brake or steering systems (or any other safety-related system), or tanks should NEVER be used for installations or ground connections. Using such parts could disable control of the vehicle and cause fire etc.

---

**DO NOT BLOCK VENTS OR RADIATOR PANELS.** Doing so may cause heat to build up inside and may result in fire.

---

**KEEP SMALL OBJECTS SUCH AS BATTERIES OUT OF THE REACH OF CHILDREN.** Swallowing them may result in serious injury. If swallowed, consult a physician immediately.

---

**DO NOT INSTALL IN LOCATIONS WHICH MIGHT HINDER VEHICLE OPERATION, SUCH AS THE STEERING WHEEL OR GEARSHIFT.** Doing so may obstruct forward vision or hamper movement etc. and results in serious accident.

---

## **Caution**

**HAVE THE WIRING AND INSTALLATION DONE BY EXPERTS.** The wiring and installation of this unit requires special technical skill and experience. To ensure safety, always contact the dealer where you purchased this product to have the work done.

---

**USE SPECIFIED ACCESSORY PARTS AND INSTALL THEM SECURELY.** Be sure to use only the specified accessory parts. Use of other than designated parts may damage this unit internally or may not securely install the unit in place. This may cause parts to become loose resulting in hazards or product failure.

---

**ARRANGE THE WIRING SO IT IS NOT CRIMPED OR PINCHED BY A SHARP METAL EDGE.** Route the cables and wiring away from moving parts (like the seat rails) or sharp or pointed edges. This will prevent crimping and damage to the wiring. If wiring passes through a hole in metal, use a rubber grommet to prevent the wire's insulation from being cut by the metal edge of the hole.

---

**DO NOT INSTALL IN LOCATIONS WITH HIGH MOISTURE OR DUST.** Avoid installing the unit in locations with high incidence of moisture or dust. Moisture or dust that penetrates into this unit may result in product failure.

---

## **Precautions**

---

- Be sure to disconnect the cable from the (–) battery post before installing your DVI-9990. This will reduce any chance of damage to the unit in case of a short-circuit.
- Be sure to connect the color coded leads according to the diagram. Incorrect connections may cause the unit to malfunction or damage to the vehicle's electrical system.
- When making connections to the vehicle's electrical system, be aware of the factory installed components (e.g. on-board computer). Do not tap into these leads to provide power for this unit. When connecting the DVI-9990 to the fuse box, make sure the fuse for the intended circuit of the DVI-9990 has the appropriate amperage. Failure to do so may result in damage to the unit and/or the vehicle. When in doubt, consult your ALPINE dealer.
- The DVI-9990 uses female RCA-type jacks for connection to other units (e.g. amplifier) having RCA connectors. You may need an adaptor to connect other units. If so, please contact your authorized ALPINE dealer for assistance.

## Contents

<b>PRECAUTIONS</b>	<b>2</b>
<b>Accessories</b>	<b>5</b>
<b>Installation</b>	<b>6</b>
<b>Connections</b>	<b>9</b>
<b>Connections with other equipments</b>	<b>10</b>

- To use this unit, a Multimedia Manager (PXI-H990, sold separately) or DAC unit (DAI-C990, sold separately) is required. This unit is powered by connecting with the PXI-H990 or DAI-C990.

## IMPORTANT

Please record the serial number of your unit in the space provided below and keep it as a permanent record. The serial number plate is located on the bottom of the unit.

SERIAL NUMBER: \_\_\_\_\_  
INSTALLATION DATE: \_\_\_\_\_  
INSTALLATION TECHNICIAN: \_\_\_\_\_  
PLACE OF PURCHASE: \_\_\_\_\_

### **To prevent external noise from entering the audio system.**

- Locate the unit and route the leads at least 10 cm away from the car harness.
- Keep the battery power leads as far away from other leads as possible.
- Connect the ground lead securely to a bare metal spot (remove any paint, dirt or grease if necessary) of the car chassis.
- If you add an optional noise suppressor, connect it as far away from the unit as possible. Your Alpine dealer carries various noise suppressors. Contact them for further information.
- Your Alpine dealer knows best about noise prevention measures so consult your dealer for further information.

# Accessories

Power cable



RCA Extension cable (video)



S video cable

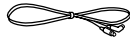

Flat screw (M5 x 6)



x 4

Front frame

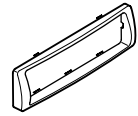

## Parts for remote control

Remote control



Battery (AAA)

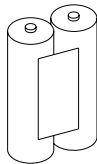

Reinforcement screw (M3 x 12)



x 2

Remote control holder

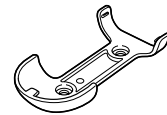

Double-sided adhesive tape

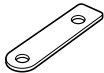

# Installation

## Installation Location

Before deciding on the mounting location, check that opening and closing the display will not hamper gear shifting in that position.

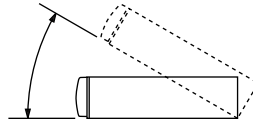

- Install at an angle of within 35 degrees from the horizontal.

1

### Mounting Sleeve (Included)

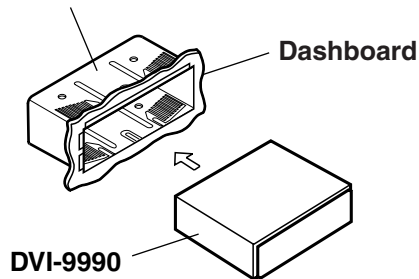

Remove the Detachable Front Panel (refer to page 9 of Owner's Manual). Remove the front frame from main unit (see "Removal" on page 7). Slide the mounting sleeve into the dashboard.

2

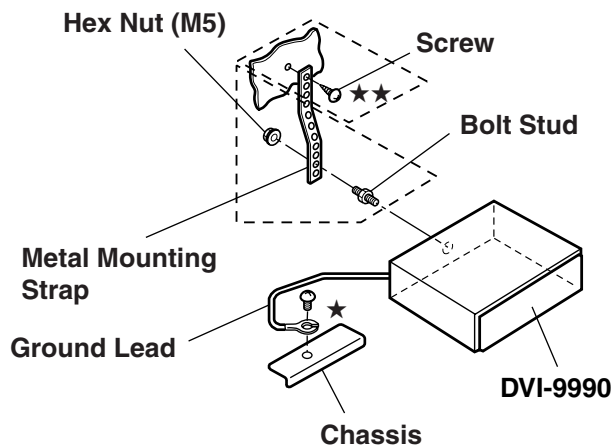

Reinforce the head unit with the metal mounting strap (not supplied). Secure the ground lead of the unit to a clean metal spot using a screw (★) already attached to the vehicle's chassis.

### NOTE

For the screw marked ★★, use an appropriate screw for the chosen mounting location.

Connect each input lead coming from the product you are connecting with to the corresponding output lead coming from the left rear of the DVI-9990. Connect all other leads of the DVI-9990 according to details described in the "Connections" section.

### 3

Slide the DVI-9990 into the dashboard. When the unit is in place, make sure the locking pins are fully seated in the down position. This can be done by pressing firmly in on the unit while pushing the locking pin down with a small screwdriver. This ensures that the unit is properly locked and will not accidentally come out from the dashboard. Install the Detachable Front Panel.

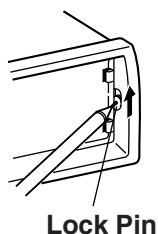

#### Removal

- 1 Remove the DETACHABLE FRONT PANEL.
- 2 Use a small screwdriver (or similar tool) to push the locking pins to the "up" position (see above drawing). As each pin is unlocked, gently pull out on the unit to make sure it does not re-lock before unlocking the second pin.
- 3 Pull the unit out, keeping it unlocked as you do so.

#### < JAPANESE CAR >

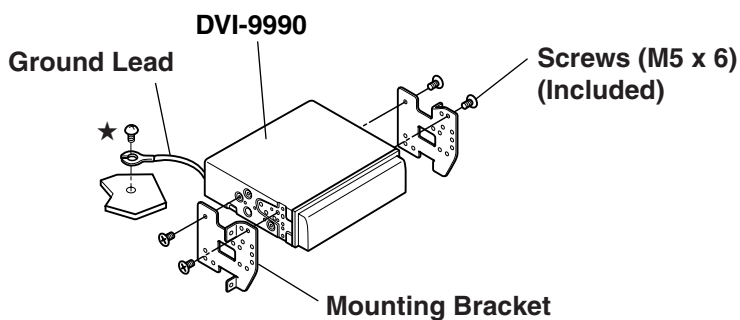
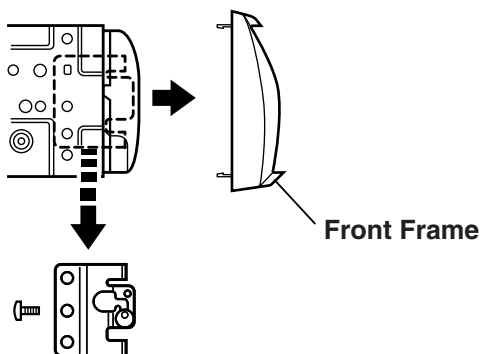

#### NOTE

Secure the ground lead of the unit to a clean metal spot using a screw (★) already attached to the vehicle's chassis.



## Mounting the remote control holder

- If the remote control is in direct sunlight, remove it from the holder and keep it in the glove box.
- When the holder cannot be mounted securely with Velcro tape, mount it by using screws.

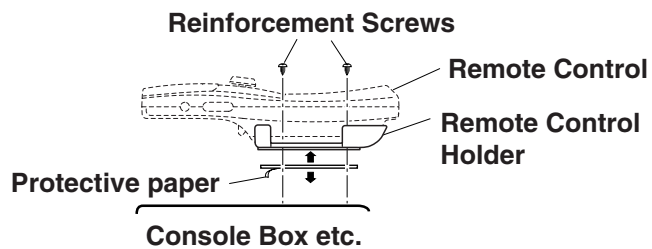

# Connections

## • Basic Connection

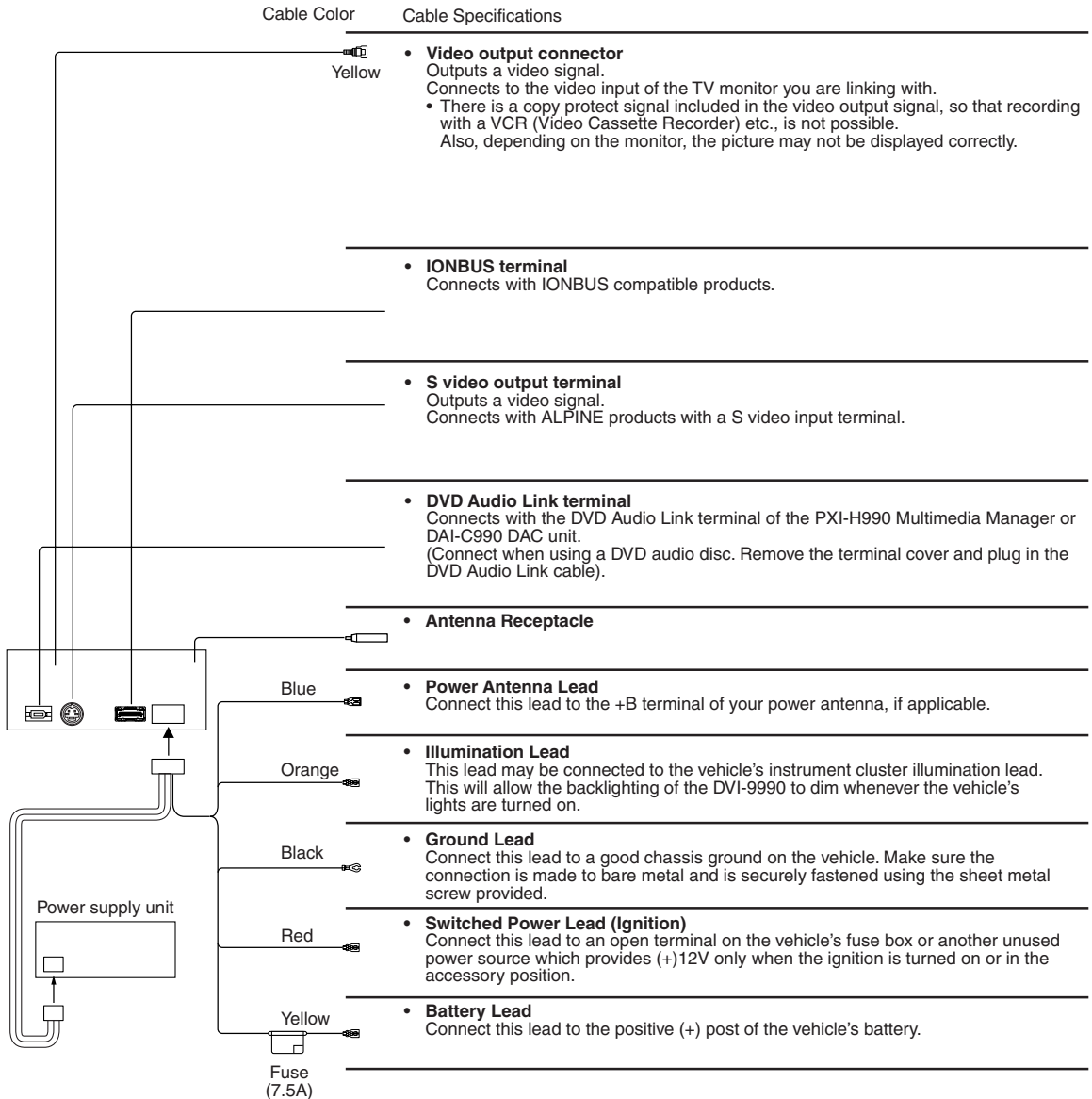

### NOTES

- Do not install the power supply unit where it will be exposed to moisture such as under the floor mat or near the air conditioner. This may cause a malfunction.
- Do not bundle the power supply unit cable with the audio cables. Noise may be induced into your system.
- The power supply unit temperature can become hot. This is not a malfunction.

# Connections with other equipments

## • System Connection <Example 1>

### Connectable system products

IONBUS compatible monitor	TMI-M990
Multimedia Manager or DAC unit	PXI-H990 or DAI-C990
Ai-NET/IONBUS converter	KCI-500B
Ai-NET compatible changer	CHA-S634 or CHA-1214
XM Radio Receiver	TUA-T021XM or TUA-T020XM

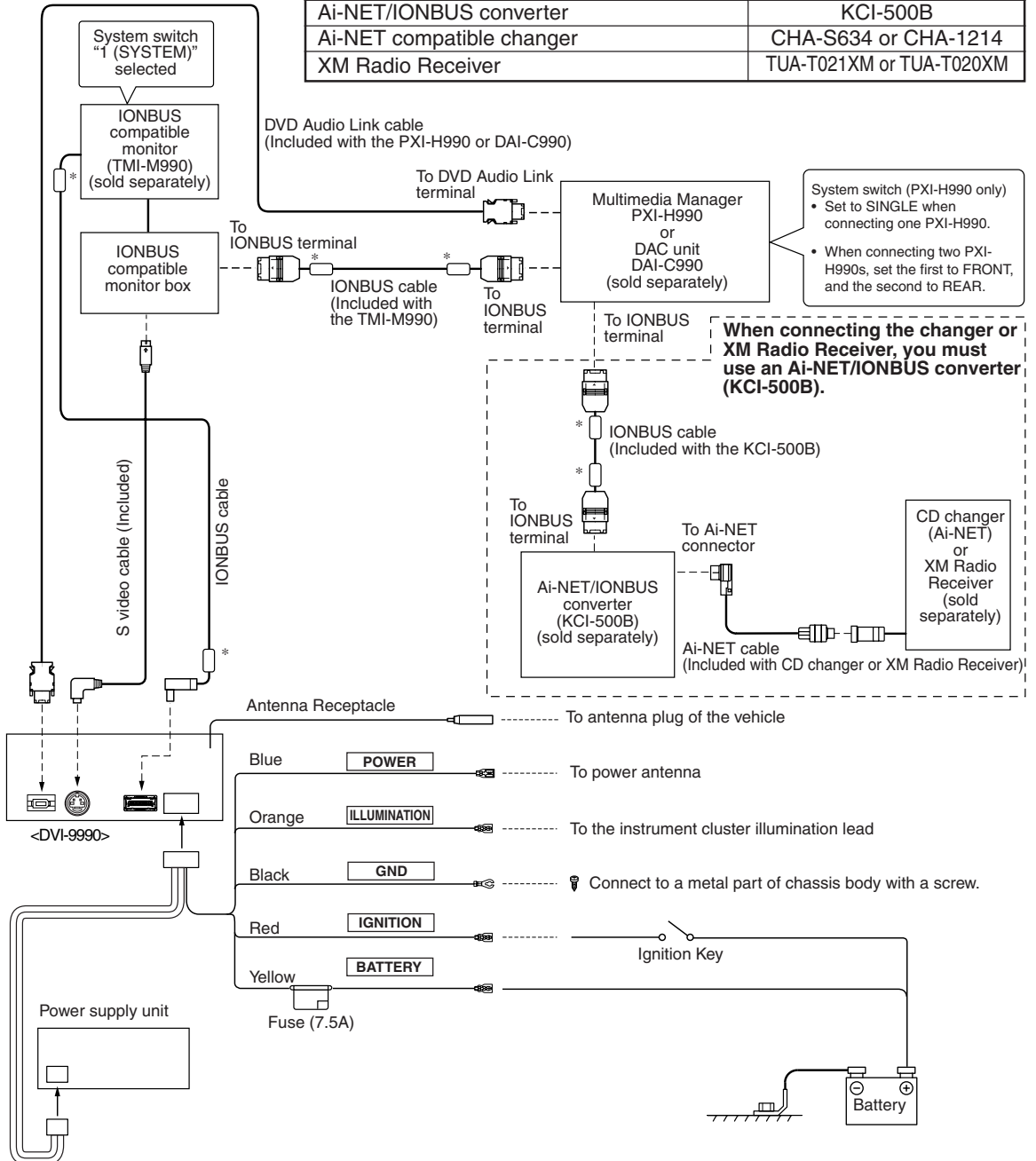

### NOTES

- Do not install the power supply unit where it will be exposed to moisture such as under the floor mat or near the air conditioner. This may cause a malfunction.
- Do not bundle the power supply unit cable with the audio cables. Noise may be induced into your system.
- The power supply unit temperature can become hot. This is not a malfunction.
- \* For the Ferrite Core, refer to the Owner's Manual of the product that the IONBUS cable is attached to.

## • System Connection <Example 2>

### Connectable system products

Multimedia Manager or DAC unit	PXI-H990 or DAI-C990
External TV monitor	IONBUS incompatible TV monitor

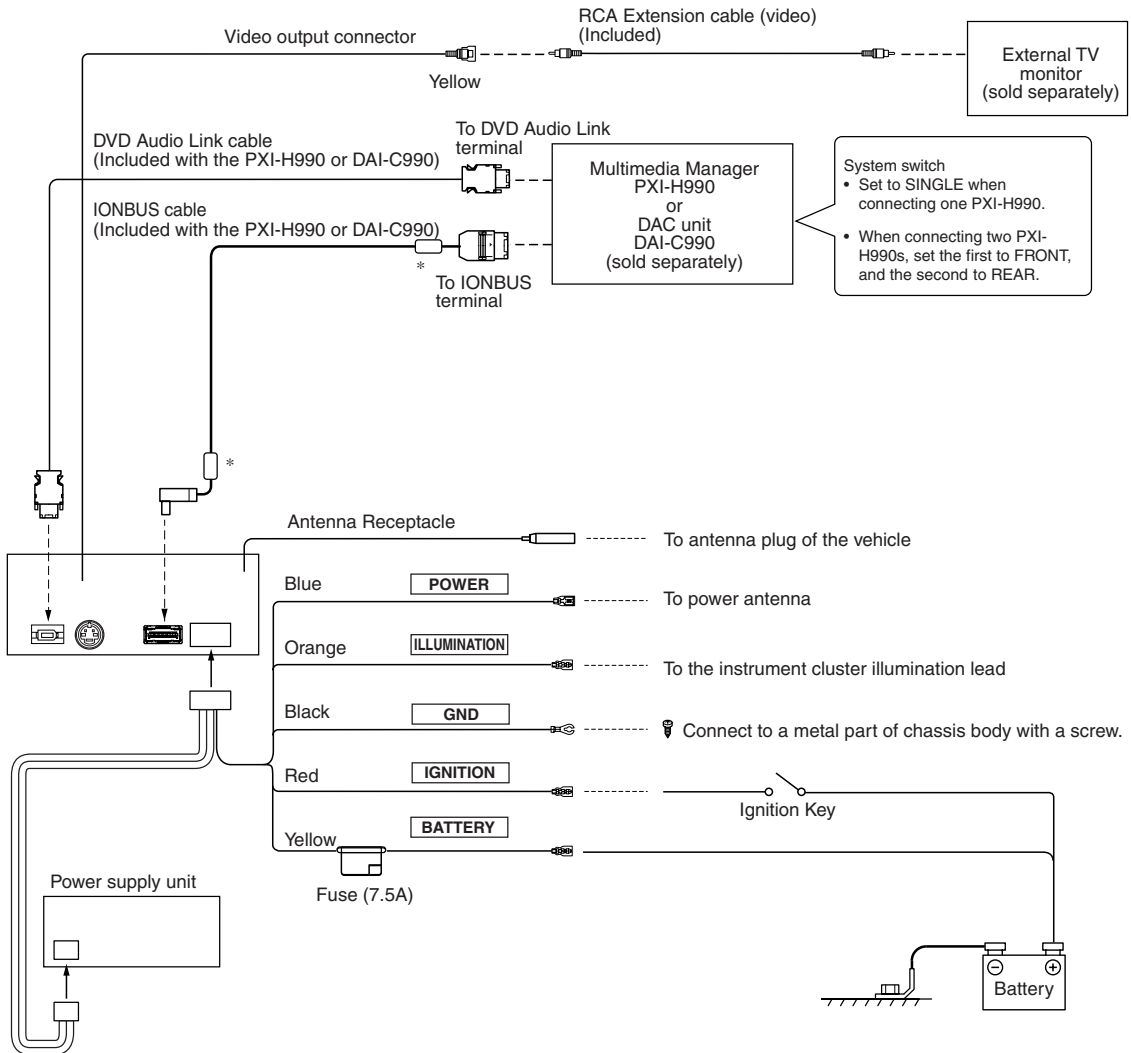

### NOTES

- Do not install the power supply unit where it will be exposed to moisture such as under the floor mat or near the air conditioner. This may cause a malfunction.
- Do not bundle the power supply unit cable with the audio cables. Noise may be induced into your system.
- The power supply unit temperature can become hot. This is not a malfunction.
- \* For the Ferrite Core, refer to the Owner's Manual of the product that the IONBUS cable is attached to.

## Free Manuals Download Website

<http://myh66.com>

<http://usermanuals.us>

<http://www.somanuals.com>

<http://www.4manuals.cc>

<http://www.manual-lib.com>

<http://www.404manual.com>

<http://www.luxmanual.com>

<http://aubethermostatmanual.com>

Golf course search by state

<http://golfingnear.com>

Email search by domain

<http://emailbydomain.com>

Auto manuals search

<http://auto.somanuals.com>

TV manuals search

<http://tv.somanuals.com>