

Aprilaire®

Model 8620 Thermostat with Event-Based™ Air Cleaning and Humidity or Ventilation Control



Owner's Manual

Includes
Operating Instructions and
Warranty Information

READ AND SAVE THESE INSTRUCTIONS

TABLE OF CONTENTS

ABOUT YOUR NEW THERMOSTAT

Thermostat features	3
Controls & display overview	4-5

OPERATION

Select system mode (EM HEAT/HEAT/OFF/COOL/AUTO)	6
Change temperature set point	6
Select fan setting (ON/AUTO/CIRC)	7
Clean screen	7
Maintenance reminders	8
Screen lockout	8
Battery installation	9

INDOOR AIR QUALITY FUNCTIONS

Event-Based™ air cleaning	10-11
Humidity control	12
Automatic mode	12-13
Manual mode	14-15
If dehumidification is installed	16-18
If dehumidification is done with air conditioner ...	19
Fresh Air	20-21

PROGRAM SCHEDULE AND HOLDS

Set time and date	22
Understanding program schedules	23-24
Progressive recovery	24
Changing program schedules	25-26
Heat Blast™	27
Program schedule holds	
Temporary	27-28
Permanent	28
Vacation	29-30

SETUP MENU

How to enter the setup menu to change settings	31
User system settings table	32-33

WARRANTY

Limited warranty	34
Warranty registration	34

ABOUT YOUR NEW THERMOSTAT

WARNING

Do not use sharp instruments to press touch screen. Only use your fingertips.

THERMOSTAT FEATURES

- Indoor air quality control.
 - Humidification automatic or manual control.
 - Dehumidification.
 - Event-Based™ air cleaning.
 - Ventilation with temperature and humidity limits.

Note: The 8620 can only control one of the following per installation: ventilation, whole home dehumidifier or humidifier.
- Temperature control.
- Heat Blast™ raises the room temperature 3°F to 5°F.
- Large touch screen with adjustable backlight – constant backlight available.
- Message center provides feedback, instructions and service reminders.
- 7 day programmability or separately programmable weekday/weekend schedules.
- User interface can be removed from the wall for easy programming (batteries must be installed).
- 24VAC or battery powered, with front battery door access for fast, easy replacement.
- Displays room temperature, room humidity, temperature setting, and outdoor temperature.
- Programmable fan control with fan circulation mode.
- Easy to use temperature control can override program schedule at any time.

ABOUT YOUR NEW THERMOSTAT

CONTROLS & DISPLAY OVERVIEW – HOME SCREEN

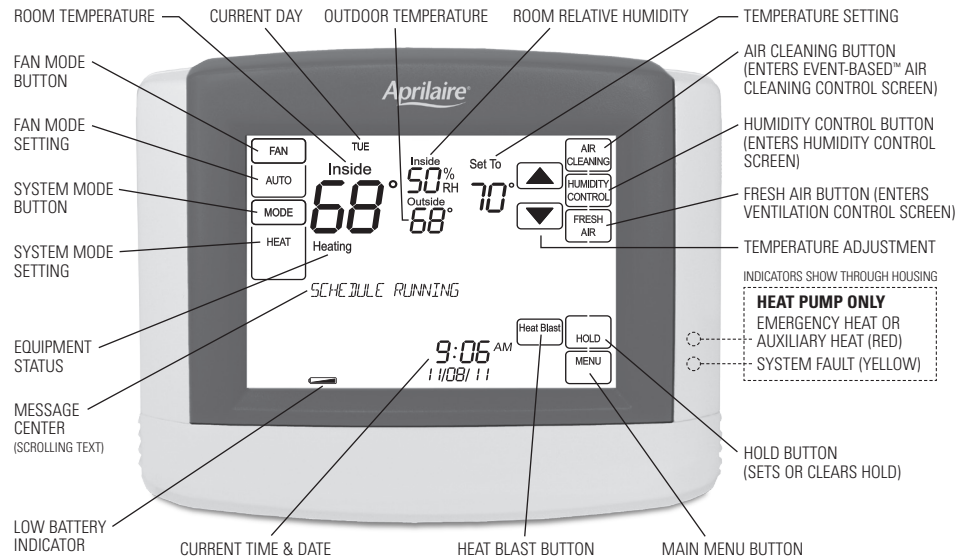

NOTES: BACKLIGHT IS ACTIVATED WITH FIRST BUTTON PRESS AND AUTOMATICALLY TURNS OFF.

NOT ALL BUTTONS WILL BE DISPLAYED IN EVERY INSTALLATION.

ABOUT YOUR NEW THERMOSTAT

CONTROLS & DISPLAY OVERVIEW – MAIN MENU

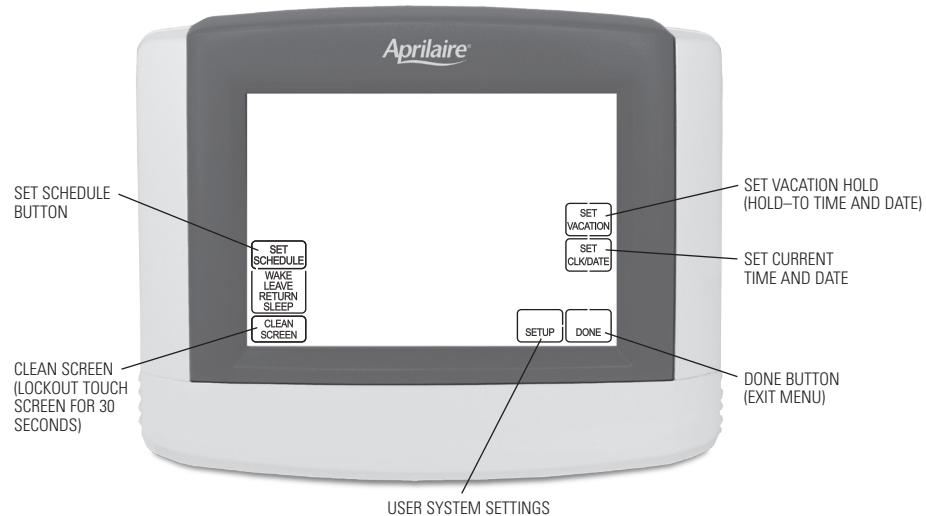

OPERATION

SELECT SYSTEM MODE

(EM HEAT/HEAT/OFF/COOL/AUTO)

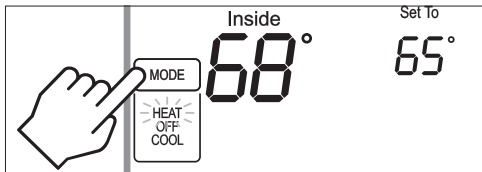

Press **[MODE]** to select:

EM HEAT: (only for heat pumps with auxiliary heat)
Thermostat controls auxiliary heat. Heat pump will not operate in EM HEAT mode.

HEAT: Thermostat controls only the heating system.

OFF: Heating and cooling systems are off.

COOL: Thermostat controls only the cooling system.

AUTO: (if enabled in installer setup) Thermostat automatically selects heating or cooling depending on the indoor temperature.

Press **[DONE]** to save and exit, Or **[CANCEL]** to exit without saving. The thermostat will save and exit if nothing is pressed within 10 seconds.

CHANGE TEMPERATURE SET POINT

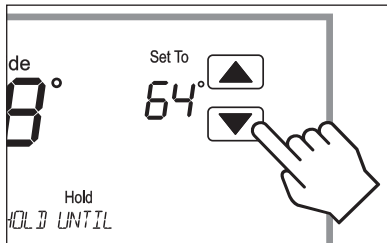

Press **▲** or **▼** to adjust the current set point.
(See Program Schedule Holds on pages 27-30 for more information.)

OPERATION

SELECT FAN SETTING (ON/AUTO/CIRC)

When the fan mode is changed during a program event it remains in that mode until the next event starts. The fan must be programmed to FAN ON in the schedule to run continuously through all events.

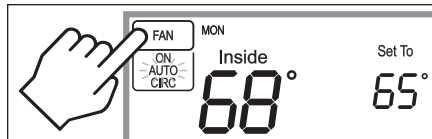

Press **[FAN]** to select:

ON: Fan runs continuously. Use this mode for maximum air circulation/filtering.

AUTO: Fan runs only when the heating or cooling system is on.

CIRC: Same as AUTO, but ensures the fan is on for at least 30 minutes per hour. Use this mode for a balance of energy savings and air circulation/cleaning.

Press **[DONE]** to save and exit, Or **[CANCEL]** to exit without saving. The thermostat will save and exit if nothing is pressed within 10 seconds.

CLEAN SCREEN

Press **[MENU]** to enter the main menu.

Press **[CLEAN SCREEN]** to disable the touch screen for 30 seconds for cleaning.

Note: Use a soft damp cloth to clean the screen. Use water or household glass cleaner. Do not spray liquids directly on the screen.

OPERATION

MAINTENANCE REMINDERS

Maintenance reminders are set up by the installer to indicate when the equipment is due for service. If a maintenance reminder is displayed, call your HVAC dealer for service. They can be cleared by pressing **[MENU]** to enter the main menu. Press ▲ and ▼ select YES to Service Reminders and then press **[Next]**. Press ▲ and ▼ to select YES for each reminder you would like to reset. Press **[Next]** to go to the next reminder or **[Back]** to go to a previous reminder. Press **[DONE]** to reset the selected service reminders.

SCREEN LOCKOUT

The user can disable certain features of the thermostat. (See User System Setting Table on pages 32-33 for details.) This feature can be overridden by pressing and holding **[MENU]** for 7 seconds.

OPERATION

BATTERY INSTALLATION

The thermostat can be battery powered, AC powered or both. When wired for AC power, the batteries are optional and only provide back-up power to the clock.

The thermostat has a memory backup that saves the thermostat's settings in case of a power interruption. The system settings will be retained but the clock will reset after 90 seconds with no battery or AC power.

The reset button located under the battery cover can be used to reset the thermostat to factory defaults.

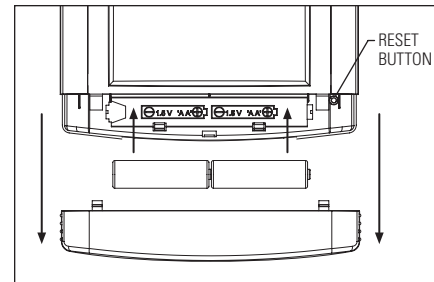

WARNING

The reset button should only be used by the installer.

INDOOR AIR QUALITY FUNCTIONS

EVENT-BASED™ AIR CLEANING

Press **[AIR CLEANING]** on the Home screen to enter the Air Cleaning screen.

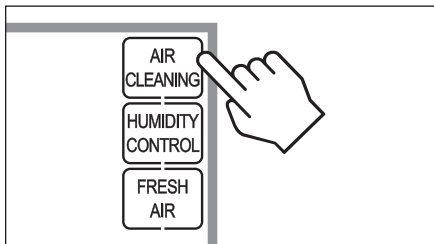

If installed, air cleaning can operate in five different modes. Air cleaning will activate the fan for the purpose of air cleaning.

Off: The air cleaner will not call the fan for the purpose of air cleaning. **Note:** If air cleaning is installed, air cleaning will still occur during normal fan operation during heating, cooling or other indoor air quality events.

Constant Clean: This option will provide the maximum amount of air cleaning available. The air cleaner will be active for 24 hours a day, seven days a week.

Automatic: The air cleaner will run a minimum of 30 minutes every hour. The air cleaner will monitor the amount of time your heating and cooling system runs; if 30 minutes is not reached the air cleaner will automatically turn on. This will maximize the amount of air cleaning while minimizing energy consumption.

Event Clean (3 hour cycle): When selected, the air cleaner will run for 3 hours continuously and then return to the most recent mode of Off, Automatic, or Constant Clean. This option only cleans the air when needed; an example would be after vacuuming.

Allergies (24 hour cycle): When seasonal allergies spike and outside air quality is at its worst, choose this option. Your air cleaner will run continuously for 24 hours, then return to the most recent mode of Off, Automatic, or Constant Clean.

Note: The thermostat will manage fan and air cleaning selections when the selections overlap.

INDOOR AIR QUALITY FUNCTIONS

EVENT-BASED™ AIR CLEANING (CONTINUED)

Air Cleaning Screen

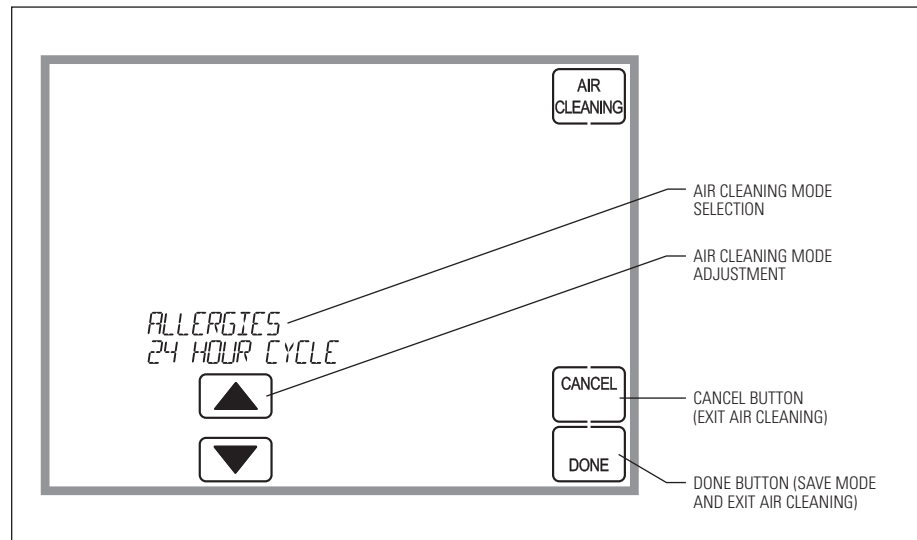

INDOOR AIR QUALITY FUNCTIONS

HUMIDITY CONTROL

Press **[HUMIDITY CONTROL]** on the Home screen to enter the Humidity Control screen.



The Humidity Control screen is used to access control for both humidification and dehumidification.

If humidification is installed it can be controlled in two modes, automatic or manual.

Automatic or manual mode is configured by the installer. To determine which mode the thermostat is set to, see the diagrams on pages 13 and 15.

In **automatic mode** you will receive the optimum amount of humidity so that your home and its furnishings are protected from the damaging effects of excess condensation or low humidity during heating season. The thermostat automatically adjusts your home's Relative Humidity based on the outdoor temperature.

The humidity setting needs to be set initially to meet your home's conditions. Please follow these steps when adjusting your thermostat.

1. Adjust the humidity setting to "3" which is within normal range. During the next 24-48 hours it may be necessary to adjust the setting for more or less humidity, depending on your personal comfort and home's requirements.
2. During the coldest portion of the first heating season, minor adjustments may be necessary. This is dependent upon your home's construction.

The Relative Humidity in your home will now be accurately controlled to meet your needs and should not need further adjustment during future heating seasons.

INDOOR AIR QUALITY FUNCTIONS

HUMIDITY CONTROL (CONTINUED)

Humidity Control Screen for Humidification in Automatic Mode

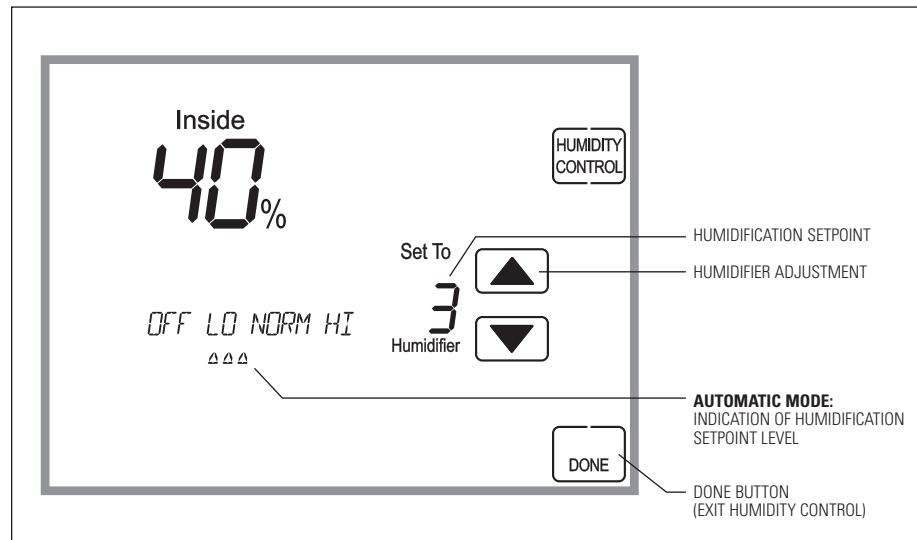

INDOOR AIR QUALITY FUNCTIONS

HUMIDITY CONTROL (CONTINUED)

In manual mode it is important to anticipate a drop in outdoor temperature and reduce the setting accordingly to avoid excessive condensation. Use the following table to determine the proper Relative Humidity setting.

Outdoor Temperature/Indoor Relative Humidity	
Outside Temperature	Recommended Relative Humidity
+50°F	50%
+40°F	45%
+30°F	40%
+20°F	35%
+10°F	30%
0°F	25%
-10°F	20%
-20°F	15%

INDOOR AIR QUALITY FUNCTIONS

HUMIDITY CONTROL (CONTINUED)

Humidity Control Screen for Humidification in Manual Mode

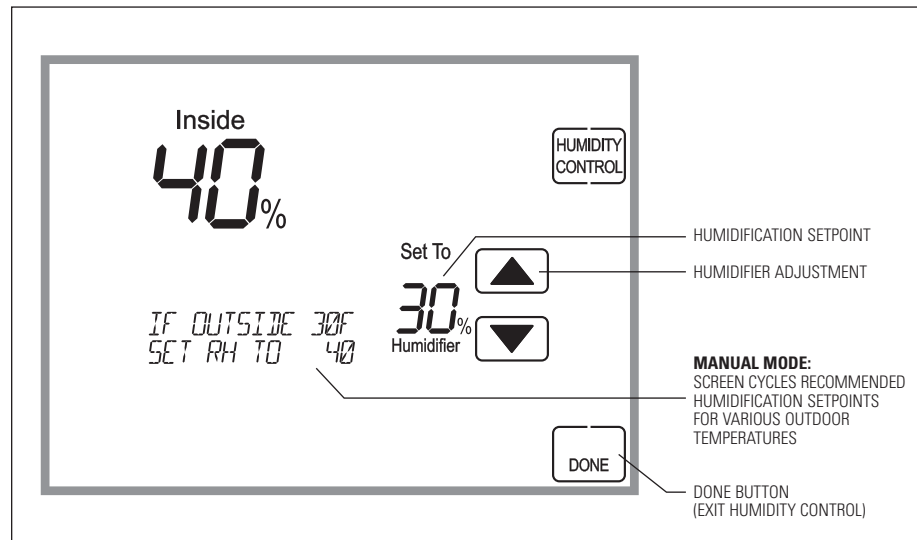

INDOOR AIR QUALITY FUNCTIONS

HUMIDITY CONTROL (CONTINUED)

If dehumidification is installed the thermostat can be configured, through the installer set-up, to control dehumidification with either a whole home dehumidifier or with the air conditioner (cooling unit).

The thermostat will allow you to set the desired humidity (% Relative Humidity) level in your home and can be used to turn the dehumidification On or Off.

Use the dehumidification adjustment to set the dehumidification setpoint to 60% when first installed. Allow dehumidification to run until the initial setpoint is reached, before deciding if you want to change the humidity setting.

▲ **Raise the setting if you prefer the air to be less dry;** this will reduce the amount of time that dehumidification runs.

▼ **Lower the setting if you prefer the air to be more dry;** this will increase the amount of time that dehumidification runs.

Your comfort is the best measure of how to adjust your setting. When first installed, your dehumidifier has to remove all the moisture that is initially in your home. The home acts like a sponge so the moisture in the materials of your home is at the same level as the air. After drying the air, the materials of the home will release the moisture back into the air until they are again at the same level. As a result, it is not uncommon for dehumidification to operate for an extended period of time when it is first installed.

INDOOR AIR QUALITY FUNCTIONS

HUMIDITY CONTROL (CONTINUED)

Energy Saving Tip #1:

Adjust the setting to be as high as is comfortable to reduce dehumidification run time – if it feels clammy or smells damp or moldy lower the setting. To save energy, turn the dehumidifier control OFF when you open your windows just as you would with air conditioning.

Energy Saving Tip #2:

If vacating your home for an extended period in the summer, set the Relative Humidity at 60% and set the cooling setpoint as high as you are comfortable setting it to in cooling mode. Consult with appropriate professionals regarding the highest temperature that is safe for your pets or possessions. This will keep the humidity at a controlled level to help prevent mold while minimizing the amount of the cooling energy used. Vacation hold is a convenient way to adjust the dehumidification and cooling setpoint when you will be away.

INDOOR AIR QUALITY FUNCTIONS

HUMIDITY CONTROL (CONTINUED)

Humidity Control Screen with only Dehumidification Installed

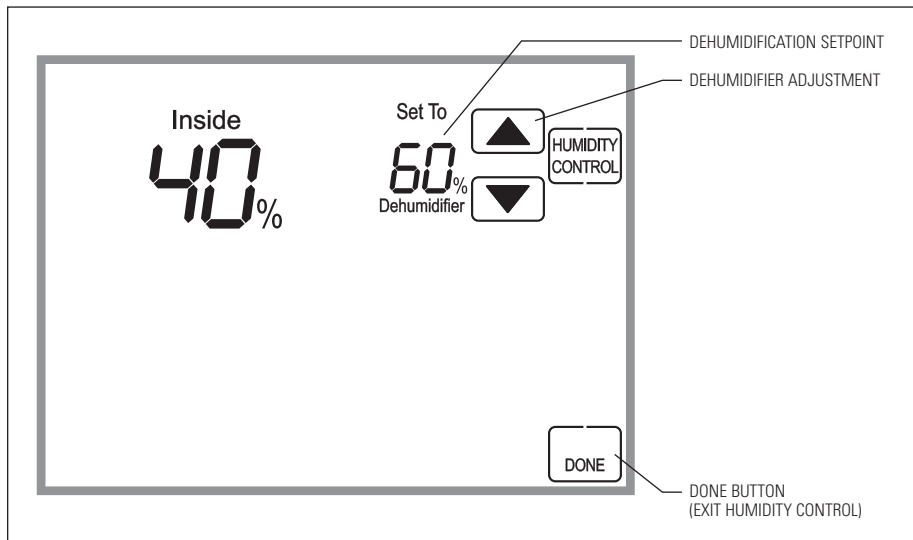

INDOOR AIR QUALITY FUNCTIONS

HUMIDITY CONTROL (CONTINUED)

If dehumidification is done with the air conditioner, the thermostat will cool up to 3°F beyond the cooling setpoint for dehumidification. Note overcooling may not be sufficient to meet the dehumidification setpoint.

INDOOR AIR QUALITY FUNCTIONS

FRESH AIR

Press **[FRESH AIR]** on the Home screen to enter the Fresh Air screen.

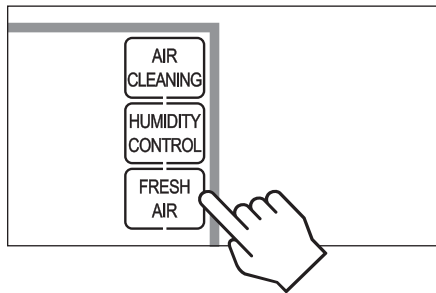

If ventilation is installed, Fresh Air can operate in four different modes.

Off: Ventilation will not run.

Automatic: Ventilation will cycle based on the parameters set by the installer to meet your home's ventilation requirements.

3 Hour Event: Ventilation will be constantly energized for 3 hours and then the fresh air mode will return to Off or Automatic depending on which was mode was most recently active. This option is used when fresh air is needed. An example would be after cooking.

24 Hour Event: Ventilation will be constantly energized for 24 hours and then the fresh air mode will return to Off or Automatic depending on which was mode was most recently active. This option is used when a large amount of fresh air is desired. An example would be a day with desirable outdoor conditions.

INDOOR AIR QUALITY FUNCTIONS

FRESH AIR (CONTINUED)

Fresh Air Screen

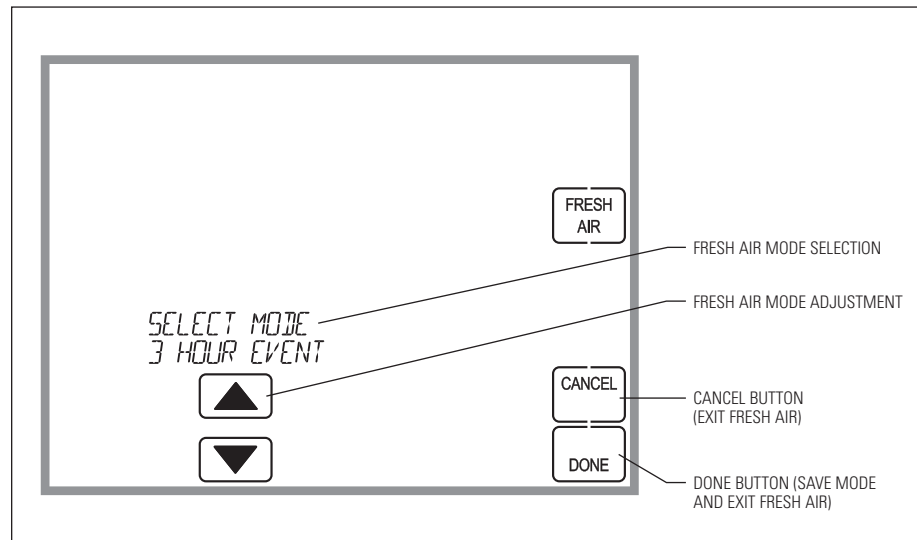

PROGRAM SCHEDULE AND HOLDS

SET TIME AND DATE

Press **[MENU]** to enter the main menu.

Press **[SET CLK/DATE]** to enter clock menu.

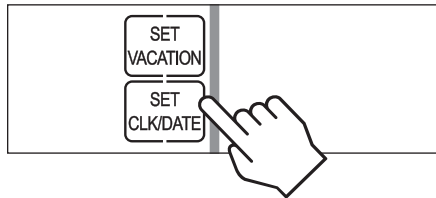

Press ▲ or ▼ to set the hour.

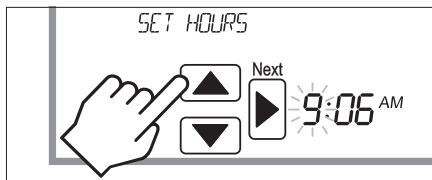

Press **[Next]**, then ▲ or ▼ to set the minute.

Press **[Next]**, then ▲ or ▼ to set the month.

Press **[Next]**, then ▲ or ▼ to set the day.

Press **[Next]**, then ▲ or ▼ to set the year.

Press **[DONE]** to save and exit, Or **[CANCEL]** to exit without saving. The thermostat will save and exit if nothing is pressed within 20 seconds.

PROGRAM SCHEDULE AND HOLDS

UNDERSTANDING PROGRAM SCHEDULES

The daily schedule is split into four sections:

WAKE: temperature you would prefer to wake up to.

LEAVE: temperature when you are away from the house.

RETURN: temperature you would prefer to return home to.

SLEEP: temperature you would prefer while sleeping.

The times shown in the table below are the defaults. The start time and temperature of each section can be changed to fit your schedule. (See Changing Program Schedules section on pages 25-26.)

This thermostat is pre-set to use the following program settings (see table below). We recommend these settings, since they can reduce your heating/cooling expenses. The fan program is pre-set to AUTO for all events.

Event designator	Start time	Set temperature		Fan
		Heat	Cool	
WAKE	6:00AM	70°F (21°C)	78°F (26°C)	AUTO
LEAVE	8:00AM	62°F (17°C)	85°F (29°C)	AUTO
RETURN	5:00PM	70°F (21°C)	78°F (26°C)	AUTO
SLEEP	10:00PM	62°F (17°C)	82°F (28°C)	AUTO

PROGRAM SCHEDULE AND HOLDS

UNDERSTANDING PROGRAM SCHEDULES (CONTINUED)

Optionally, the thermostat can be set to a two event schedule. (See Setup Menu on page 31.)

Event designator	Start time	Set temperature		Fan
		Heat	Cool	
WAKE	6:00AM	70°F (21°C)	78°F (26°C)	AUTO
SLEEP	10:00PM	62°F (17°C)	82°F (28°C)	AUTO

Use the table below to assist in modifying the schedule.

Event designator	Start time	Set temperature		Fan
		Heat	Cool	
WAKE				
LEAVE				
RETURN				
SLEEP				

PROGRESSIVE RECOVERY

The Progressive Recovery feature allows the thermostat to activate the heating and cooling equipment **PRIOR** to a scheduled event in order to reach the desired temperature at the start of that scheduled event.

Example: If the WAKE time is 6 am, and the temperature is 70°, the heat will come on before 6 am, so the temperature is 70° by the time you wake at 6 am.

PROGRAM SCHEDULE AND HOLDS

CHANGING PROGRAM SCHEDULES

Press **[MENU]** to enter the main menu.

Press **[SET SCHEDULE]** to enter schedule programming.

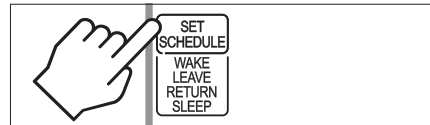

Press **▲** or **▼** to select the day.

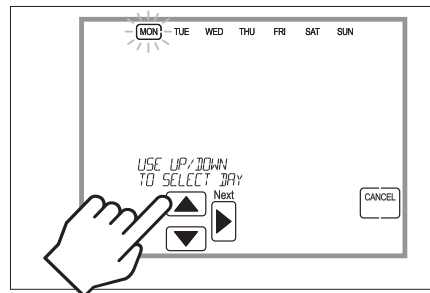

Note: This step is not displayed for weekday/weekend schedules.

Press **[Next]**, then **▲** or **▼** to set the start time of the first event.



Press **[Next]**, then **▲** or **▼** to set the setpoints of the first event.

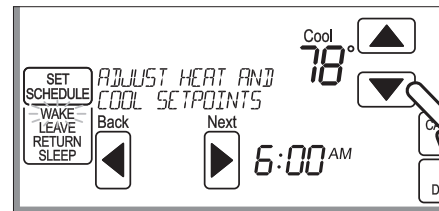

PROGRAM SCHEDULE AND HOLDS

CHANGING PROGRAM SCHEDULES (CONTINUED)

Press **[Next]**, then **[FAN]** to set the fan mode of the first event.

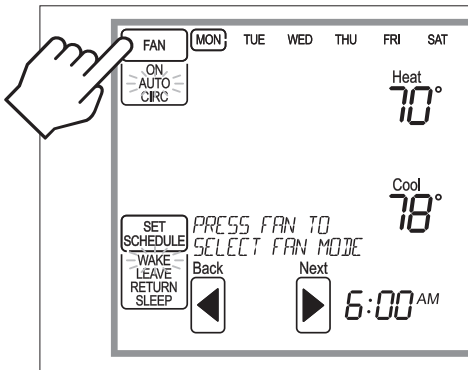

Press **[Next]** to advance to the next event.

Repeat above process for each remaining event.

Press **[DONE]** to save the schedule for the day.

The thermostat will display the COPY option.

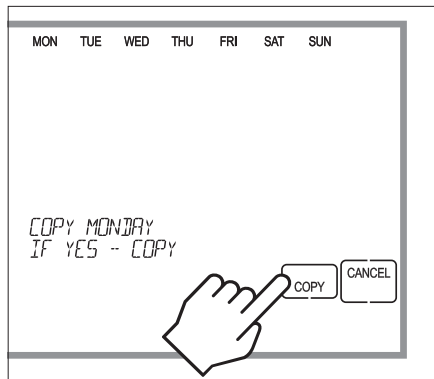

Press **[COPY]** to copy the schedule of the day just programmed to any other day.

OR

Press **[CANCEL]** to proceed to the next day and repeat the above process.

PROGRAM SCHEDULE AND HOLDS

HEAT BLAST™

Heat Blast™ will raise the current room temperature 3°F to 5°F based on the installer set-up, and then resume normal operation.

Press **[Heat Blast]** to activate Heat Blast.

Note: Heat Blast button is only available if it is enabled in the Installer Setup and the thermostat is in Heat or Emergency Heat mode.

To cancel Heat Blast press **[CANCEL]**, or **[Heat Blast]**, or the temperature adjust buttons.

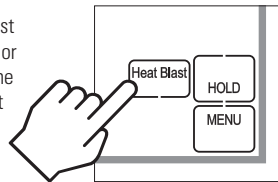

PROGRAM SCHEDULE HOLDS – TEMPORARY

TEMPORARY PROGRAM HOLD

Press **▲** or **▼** to immediately adjust the temperature when the schedule is running. This will temporarily hold the temperature setting until the next scheduled event.

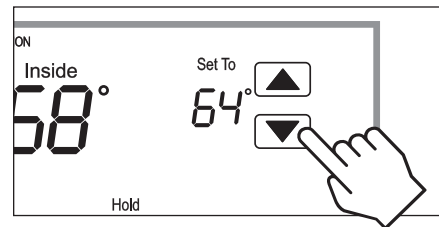

PROGRAM SCHEDULE AND HOLDS

PROGRAM SCHEDULE HOLDS – TEMPORARY (CONTINUED)

Press ▲ or ▼ to adjust the end time of the hold. If end time is not adjusted, the Temporary Hold will end at the start of the next event.

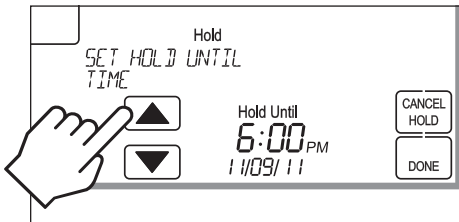

To cancel the Temporary Hold, press [CANCEL HOLD].

PROGRAM SCHEDULE HOLDS – PERMANENT

PERMANENT PROGRAM HOLD

Press [HOLD] to permanently hold the temperature at its current setting while the schedule is running. This will override the temperature settings for all events. With the thermostat in Permanent Hold, the temperature setting and fan mode can be adjusted and will stay at that setting until the hold is cancelled.

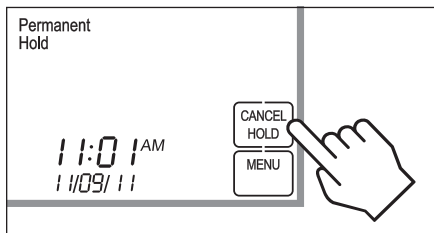

To cancel the Permanent Hold, press [CANCEL HOLD].

PROGRAM SCHEDULE AND HOLDS

PROGRAM SCHEDULE HOLDS – VACATION

VACATION PROGRAM HOLD

This energy saving feature allows you to suspend the programmed schedule for extended periods of time. The temperature and dehumidification setpoint (optional) you select will be maintained 24 hours a day until the vacation program hold end date and time. Once the end date and time have been surpassed, the previously programmed schedule will resume. If you return earlier than expected, press [CANCEL HOLD] to resume the programmed schedule.

Press [MENU] to enter the main menu.

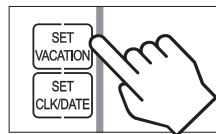

Press [SET VACATION] to enter vacation program hold.

Press ▲ or ▼ to adjust the temperature setting.

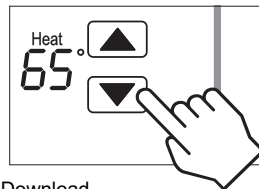

Press [NEXT], then adjust the dehumidification setting.

Note: If dehumidification in vacation mode is not enabled this step will be skipped.

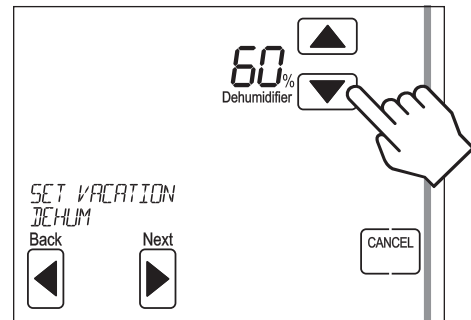

PROGRAM SCHEDULE AND HOLDS

PROGRAM SCHEDULE HOLDS – VACATION (CONTINUED)

Press **[Next]**, then **[FAN]** to set the fan mode.

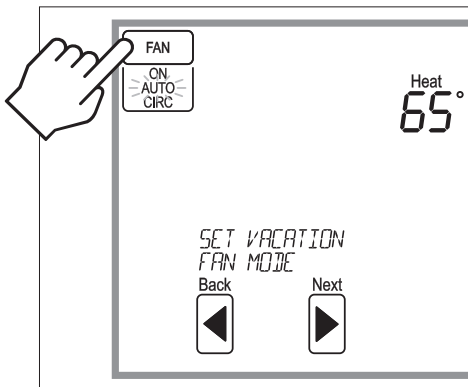

Press **[Next]**, then ▲ or ▼ to set end date.

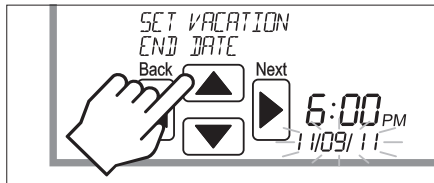

Press **[Next]**, then ▲ or ▼ to set end time.

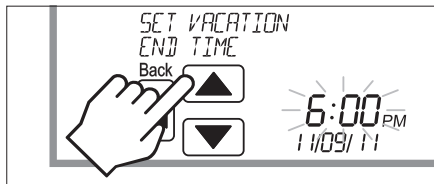

Press **[DONE]** to save and exit, Or **[CANCEL]** to exit without saving. The thermostat will save and exit if nothing is pressed within 20 seconds.

SETUP MENU

HOW TO ENTER THE SETUP MENU TO CHANGE SETTINGS

Press **[MENU]** to enter the main menu.

Press **[SETUP]** to enter the setup menu.

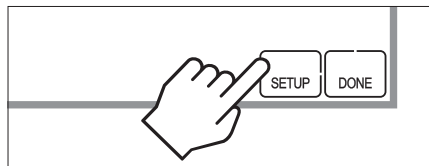

Press **[Next]** or **[Back]** to page through the settings (the setting is displayed in the message center).

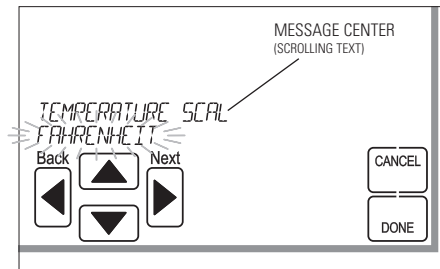

Press ▲ or ▼ to adjust the setting. (Selected option flashes.)

Press **[DONE]** to save and exit, Or **[CANCEL]** to exit without saving.

The thermostat will discard changes and exit if nothing is pressed within 60 seconds.

SETUP MENU

USER SYSTEM SETTINGS TABLE

The following table is the list of the settings and their details. Default settings are shown in **bold**.

User system setting	Description	Factory default setting (bold) and setting range
Temperature scale	Set the thermostat to Fahrenheit or Celsius mode	Fahrenheit Celsius
Screen lockout	Screen lockout level	OFF : No lockout Partial lockout Full lockout
Partial lockout type	(only available when Screen lockout is set to partial lockout)	Allow changes to Fan Mode, System Mode and Setpoints Allow changes to Fan Mode and Setpoints only Allow changes to Setpoints only
Max Temp Setpoint Change in Lockout	Select temperature setpoint limits (only available when screen lockout is set to partial)	3 degrees 0 to 20 degrees
Max Dehum Setpoint Change in Lockout	Select dehumidification setpoint limits (only available when screen lockout is set to partial)	5 percent Relative Humidity 0 to 15 percent Relative Humidity
Events per day	Number of program events per day.	4 events per day 2 events per day

SETUP MENU

USER SYSTEM SETTINGS TABLE (CONTINUED)

User system setting	Description	Factory default setting (bold) and setting range
Backlight intensity	Backlight intensity as a percentage of full on	100 Selection of 0 – 100%
Daylight savings	Enable or disable auto daylight savings	OFF Second Sunday in March to the first Sunday in November First Sunday in April to the last Sunday in October
Reset Service reminders	Clears the Change Air Filter and HVAC and Dehumidifier Service reminders if they are active and resets the start date to the current date. Clears the Change Water Panel reminder if it is active. If the reminders is set to timed, the clock will be reset.	No Yes

THERMOSTAT FIVE YEAR LIMITED WARRANTY

Your Research Products Corporation Aprilaire® Thermostat is expressly warranted for five (5) years from date of installation to be free from defects in materials or workmanship.

Research Products Corporation's exclusive obligation under this warranty shall be to supply, without charge, a replacement for any thermostat which is found to be defective within such five (5) year period and which is returned, together with the date of installation, no later than thirty (30) days after said five (5) year period by you to either your original supplier or to Research Products Corporation, Madison, Wisconsin 53701.

THIS WARRANTY SHALL NOT OBLIGATE RESEARCH PRODUCTS CORPORATION FOR ANY LABOR COSTS AND SHALL NOT APPLY TO DEFECTS IN WORKMANSHIP OR MATERIALS FURNISHED BY YOUR INSTALLER AS CONTRASTED TO DEFECTS IN THE THERMOSTAT ITSELF.

IMPLIED WARRANTIES OF MERCHANTABILITY OF FITNESS FOR A PARTICULAR PURPOSE SHALL BE LIMITED IN DURATION TO THE AFORESAID FIVE YEAR PERIOD. RESEARCH PRODUCTS CORPORATION'S LIABILITY FOR INCIDENTAL OR CONSEQUENTIAL DAMAGES, OTHER THAN DAMAGES FOR PERSONAL INJURIES, RESULTING FROM ANY BREACH OF THE AFORESAID IMPLIED WARRANTIES OR THE ABOVE LIMITED WARRANTY IS EXPRESSLY EXCLUDED. THIS LIMITED WARRANTY IS VOID IF DEFECT(S) RESULT FROM FAILURE TO HAVE THIS THERMOSTAT INSTALLED BY A QUALIFIED HEATING AND AIR CONDITIONING CONTRACTOR. IF THE LIMITED WARRANTY IS VOID DUE TO FAILURE TO USE A QUALIFIED CONTRACTOR, ALL DISCLAIMERS OF IMPLIED WARRANTIES SHALL BE EFFECTIVE UPON INSTALLATION.

Some states do not allow limitations on how long an implied warranty lasts or the exclusion or limitation of incidental or consequential damages, so the above exclusions or limitations may not apply to you.

This warranty gives you specific legal rights and you may also have other rights which vary from state to state.

This equipment if installed in strict accordance with the manufacturer's instructions, complies with the limits for a Class B computing device pursuant to Subpart J of Part 15 of FCC Rules.

WARRANTY REGISTRATION

Visit us on-line at www.aprilaire.com to register your Aprilaire product. If you do not have on-line access, please mail a postcard with your name, address, phone number, product purchased and date of purchase to: Research Products Corporation, P.O. BOX 1467, Madison, WI 53701

Your Warranty Registration information will not be sold or shared outside of this company.



P.O. Box 1467 • Madison, WI 53701-1467 • Phone: 800/334-6011 • Fax: 608/257-4357

www.aprilaire.com

10009856 4.12
B2205747B

U.S. Patent Number 8,146,376 (and other patents pending)
© 2012 Aprilaire – A division of Research Products Corporation

Download from Www.Somanuals.com. All Manuals Search And Download.

Free Manuals Download Website

<http://myh66.com>

<http://usermanuals.us>

<http://www.somanuals.com>

<http://www.4manuals.cc>

<http://www.manual-lib.com>

<http://www.404manual.com>

<http://www.luxmanual.com>

<http://aubethermostatmanual.com>

Golf course search by state

<http://golfingnear.com>

Email search by domain

<http://emailbydomain.com>

Auto manuals search

<http://auto.somanuals.com>

TV manuals search

<http://tv.somanuals.com>