

Aspire 4625/4625G Series Service Guide

Service guide files and updates are available on the ACER/CSD web; for more information, please refer to <http://csd.acer.com.tw>

PRINTED IN TAIWAN

Revision History

Please refer to the table below for the updates made on Aspire 4625/4625G service guides.

Date	Chapter	Updates

Copyright

Copyright © 2010 by Acer Incorporated. All rights reserved. No part of this publication may be reproduced, transmitted, transcribed, stored in a retrieval system, or translated into any language or computer language, in any form or by any means, electronic, mechanical, magnetic, optical, chemical, manual or otherwise, without the prior written permission of Acer Incorporated.

Disclaimer

The information in this guide is subject to change without notice.

Acer Incorporated makes no representations or warranties, either expressed or implied, with respect to the contents hereof and specifically disclaims any warranties of merchantability or fitness for any particular purpose. Any Acer Incorporated software described in this manual is sold or licensed "as is". Should the programs prove defective following their purchase, the buyer (and not Acer Incorporated, its distributor, or its dealer) assumes the entire cost of all necessary servicing, repair, and any incidental or consequential damages resulting from any defect in the software.

Acer is a registered trademark of Acer Corporation.

Intel is a registered trademark of Intel Corporation.

Other brand and product names are trademarks and/or registered trademarks of their respective holders.

Conventions

The following conventions are used in this manual:

SCREEN MESSAGES	Denotes actual messages that appear on screen.
NOTE	Gives bits and pieces of additional information related to the current topic.
WARNING	Alerts you to any damage that might result from doing or not doing specific actions.
CAUTION	Gives precautionary measures to avoid possible hardware or software problems.
IMPORTANT	Reminds you to do specific actions relevant to the accomplishment of procedures.



NOTE: This symbol where placed in the Service Guide designates a component that should be recycled according to the local regulations.

Preface

Before using this information and the product it supports, please read the following general information.

1. This Service Guide provides you with all technical information relating to the BASIC CONFIGURATION decided for Acer's "global" product offering. To better fit local market requirements and enhance product competitiveness, your regional office MAY have decided to extend the functionality of a machine (e.g. add-on card, modem, or extra memory capability). These LOCALIZED FEATURES will NOT be covered in this generic service guide. In such cases, please contact your regional offices or the responsible personnel/channel to provide you with further technical details.
2. Please note WHEN ORDERING FRU PARTS, that you should check the most up-to-date information available on your regional web or channel. If, for whatever reason, a part number change is made, it will not be noted in the printed Service Guide. For ACER-AUTHORIZED SERVICE PROVIDERS, your Acer office may have a DIFFERENT part number code to those given in the FRU list of this printed Service Guide. You MUST use the list provided by your regional Acer office to order FRU parts for repair and service of customer machines.

System Specifications	1
Features	1
System Block Diagram	6
Your Acer Aspire Notebook tour	7
Front View	7
Closed Front View	9
Left View	9
Right View	10
Bottom View	10
Indicators	11
TouchPad Basics	12
Using the Keyboard	13
Lock Keys and embedded numeric keypad	13
Windows Keys	14
Hot Keys	15
Hardware Specifications and Configurations	16
 System Utilities	 29
BIOS Setup Utility	29
Navigating the BIOS Utility	29
Aspire JV41 BIOS	30
Information	30
Main	31
Security	32
Boot	34
Exit	35
BIOS Flash Utilities	36
DOS Flash Utility	37
WinFlash Utility	38
Remove HDD/BIOS Password Utilities	39
 Machine Disassembly and Replacement	 45
Disassembly Requirements	45
General Information	46
Pre-disassembly Instructions	46
Disassembly Process	46
External Module Disassembly Process	47
External Modules Disassembly Flowchart	47
Removing the Battery Pack	48
Removing the SD dummy card	49
Removing the Lower Cover	50
Removing the Optical Drive Module	51
Removing the DIMM Modules	53
Removing the WLAN Module	54
Removing the Hard Disk Drive Module	56
Main Unit Disassembly Process	57
Main Unit Disassembly Flowchart	57
Removing the Keyboard	58
Removing the Upper Cover	59
Removing the Power Switch Board	62
Removing the Function Board	63
Removing the USB Board	65
Removing the Bluetooth Module	66
Removing the LCD Module	67

Table of Contents

Removing the Mainboard	70
Removing the Thermal Module	71
Removing the PCH Thermal Module	73
Removing the CPU	73
Removing the RTC Battery	74
LCD Module Disassembly Process	75
LCD Module Disassembly Flowchart	75
Removing the LCD Bezel	76
Removing the Camera Module	77
Removing the LCD Panel	78
Removing the FPC Cable	79
Removing the Microphone Module	80
Removing the Antennas	81
Removing the Hinges	82
LCD Module Reassembly Procedure	83
Replacing the MIC and WiFi Antennas	83
Replacing the FPC Cable	84
Replacing the LCD Panel	85
Replacing the Webcam	86
Replacing the LCD Bezel	87
Main Module Reassembly Procedure	88
Replacing the RTC Battery	88
Replacing the CPU	88
Replacing the Thermal Module	89
Replacing the PCH Thermal Module	90
Replacing the LCD Module	92
Replacing the Bluetooth Module	95
Replacing the USB Board	96
Replacing the Function Board	97
Replacing the Power Switch Board	97
Replacing the Upper Cover	98
Replacing the Keyboard	101
Replacing the ODD Module	102
Replacing the Hard Disk Drive Module	102
Replacing the WLAN Board	104
Replacing the DIMM Modules	104
Replacing the Lower Covers	105
Replacing the Dummy Cards	106
Replacing the Battery Pack	106

Troubleshooting

107

Common Problems	107
Power On Issue	108
No Display Issue	109
Random Loss of BIOS Settings	110
LCD Failure	111
Built-In Keyboard Failure	111
TouchPad Failure	112
Internal Speaker Failure	112
HDD Not Operating Correctly	114
ODD Failure	115
Wireless Function Failure	118
Thermal Unit Failure	118
External Mouse Failure	119
Other Failures	119

Table of Contents

Intermittent Problems	120
Undetermined Problems	120
Post Codes	121
Jumper and Connector Locations	125
Top View	125
Bottom View	126
Clearing Password Check and BIOS Recovery	127
Clearing Password Check	127
Clear CMOS Jumper	127
BIOS Recovery by Crisis Disk	128
FRU (Field Replaceable Unit) List	129
Aspire 4625/4625G Exploded Diagrams	130
LCD Assembly	130
FRU List	133
Screw List	145
Model Definition and Configuration	146
Aspire 4625/4625G	146
Test Compatible Components	157
Microsoft® Windows® 7 Environment Test	158
Online Support Information	165
Index	167

Table of Contents

System Specifications

Features

Below is a brief summary of the computer's many features:

NOTE: Items denoted with an (*) are only available for selected models.

Operating System

- Genuine Windows® 7 Home Premium 64-bit*
- Genuine Windows® 7 Home Basic 64-bit*

Platform

- **AMD Phenom™ II** quad-core mobile processor **N930** (2 MB L2 cache, 2 GHz, 1333 MHz FSB, 35 W)
- **AMD Phenom™ II** triple-core mobile processor **N830** (1.5 MB L2 cache, 2.10 GHz, 1333 MHz FSB, 35 W)
- AMD M880G Chipset

System Memory

- Dual-channel DDR3 SDRAM support:
 - Up to 4 GB of DDR3 1066 MHz memory, upgradeable to 8 GB using two soDIMM modules

Display

- 14" HD 1366 x 768 pixel resolution, high-brightness (200-nit) Acer CineCrystal™ LED-backlit TFT LCD, supporting simultaneous multi-window viewing via Acer GridVista™
- 16:9 aspect ratio
- Super-slim design

Graphics

- ATI Radeon™ HD 4250 Graphics with 384 MB of dedicated system memory, supporting Unified Video Decoder 2 (UVD2), OpenGL® 2.0, OpenEXR High Dynamic-Range (HDR) technology, Shader Model 4.0, Microsoft® DirectX® 10.1
- Dual independent display support
- 16.7 million colors
- External resolution / refresh rates:
 - VGA port up to 2048x 1536: 85 Hz
 - HDMI™ port up to 1920 x 1080: 60 Hz
- MPEG-2/DVD decoding
- WMV9 (VC-1) and H.264 (AVC) decoding

-
- HDMI™ (High-Definition Multimedia Interface) with HDCP (High-bandwidth Digital Content Protection) support

Audio

- Optimized Dolby Home Theater® v3 audio enhancement, featuring Dolby® Digital Live, Dolby® Pro Logic® IIx, Dolby® Headphone, Dolby® Natural Bass, Dolby® Sound Space Expander, Dolby® Audio Optimization, Dolby® High Frequency Enhancer technologies
- High-definition audio support
- S/PDIF (Sony/Philips Digital Interface) support for digital speakers
- MS-Sound compatible
- Built-in microphone

Storage

- 160/250/320/500/640 GB or larger hard disk drive
- Multi-in-1 card reader, supporting Secure Digital™ (SD) Card, MultiMediaCard™ (MMC), Memory Stick™ (MS), Memory Stick PRO™ (MS PRO), xD-Picture Card™ (xD)

Optical Drive

- 8X DVD-Super Multi double-layer drive:
 - Read: 24X CD-ROM, 24X CD-R, 24X CD-RW, 8X DVD-ROM, 8X DVD-R, 8X DVD+R, 6X DVD-ROM DL, 6X DVD-R DL, 6X DVD+R DL, 6X DVD-RW, 6X DVD+RW, 5X DVD-RAM
 - Write: 24X CD-R, 16X CD-RW, 8X DVD-R, 8X DVD+R, 4X DVD-R DL, 4X DVD+R DL, 6X DVD-RW, 8X DVD+RW, 5X DVD-RAM

Communication

- Acer Video Conference, featuring:
 - Acer Crystal Eye webcam with 1280 x 1024 resolution
- WLAN:
 - Acer InviLink™ Nplify™ 802.11 b/g/n Wi-Fi CERTIFIED™
 - Acer InviLink™ 802.11 b/g Wi-Fi CERTIFIED™
 - Supporting Acer SignalUp™ wireless technology
- WPAN: Bluetooth® 2.1+EDR
- WPAN: Bluetooth® 3.0+HS
- LAN: Gigabit Ethernet, Wake-on-LAN ready

Privacy control

- BIOS user, supervisor, HDD passwords
- Kensington lock slot

Dimensions and weight

- 342 (W) x 245 (D) x 24.8/25.4 (H) mm (13.46 X 9.64 X 0.97/1 inches)
- 2.10 kg (4.6 lbs.) with 6-cell battery

-
- 342 (W) x 245 (D) x 24/47.6 (H) mm (13.46 X 9.64 X 0.94/1.6 inches)
 - 2.26 kg (4.9 lbs.)15 with 9-cell battery

Power adapter and battery

- ACPI 3.0 CPU power management standard: supports Standby and Hibernation power-saving modes
- Acer PowerSmart 3-pin 65 W AC adapter
 - 95 (W) x 50 (D) x 25.4 (H) mm (3.74 x 1.96 x 1 inches)
 - 216 g (0.47 lbs) with 180 cm DC cable
- 66.6 W 6000 mAh 6-cell Li-ion standard battery pack
- Estimated battery life: up to 6.5 hours
- ENERGY STAR®

Special keys and controls

- Keyboard
 - 86-/87-/91-key Acer FineTip keyboard with international language support
- Touchpad
 - Multi-gesture touchpad, supporting two-finger scroll, pinch, rotate, flip
- Media keys
 - Media control keys (printed on keyboard): play/pause, stop, previous, next, volume up, volume down
- Control key
 - Acer PowerSmart or programmable key

I/O interface

- Multi-in-1 card reader (SD™, MMC, MS, MS PRO, xD)
- Four USB 2.0 ports
- HDMI™ port with HDCP support
- External display (VGA) port
- Headphone/speaker jack with S/PDIF support
- Microphone-in jack
- Ethernet (RJ-45) port
- DC-in jack for AC adapter

Software

- Productivity
 - Acer Backup Manager
 - Acer PowerSmart Manager
 - Acer eRecovery Management
 - Adobe® Flash® Player 10
 - Adobe® Reader® 9.1
 - eSobi™

-
- Google™ Setup
 - Google Toolbar™
 - Microsoft® Office Personal 2007 (Service Pack 2) (Japan only, subject to customer request)
 - Microsoft® Office Trial (Service Pack 2)
 - Microsoft® Works SE 9
 - Microsoft® Works 9
 - Microsoft® Works 8.5
 - Norton™ Online Backup
 - Security
 - McAfee® Internet Security Suite 2009 Trial
 - McAfee® Virus Definitions
 - MyWinLocker
 - Multimedia
 - Acer Arcade™ Deluxe
 - NTI Media Maker™
 - Gaming
 - Oberon GameZone (except US, Canada, Hong Kong, Korea)
 - WildTangent® (US, Canada only)
 - Communication and ISP
 - Acer Crystal Eye
 - Acer Video Conference Manager
 - Microsoft® Silverlight™
 - Skype™
 - Windows Live™ Essentials — Wave 3.2 (Mail, Photo Gallery, Live™ Messenger, Movie Maker, Writer)
 - Web links and utilities
 - Acer Accessory Store (Belgium, France, Germany, Italy, Netherlands, Spain, Sweden, UK only)
 - Acer Assist
 - Acer Identity Card
 - Acer Registration
 - Acer Updater
 - eBay® shortcut 2009 (Canada, France, Germany, Italy, Mexico, Spain, UK, US only)
 - Netflix shortcut (US only)

Optional Items

- 1 GB / 2 GB DDR3 1066 MHz soDIMM module
- 6-cell Li-ion battery pack
- 3-pin 65 W AC adapter
- External USB floppy drive
- External USB optical disc drive

Warranty

- One-year International Travellers Warranty (ITW)

Environment

- Temperature:
 - Operating: 41 °F to 95 °F (5 °C to 35 °C)
 - Non-operating: -4 °F to -149 °F (20 °C to 65 °C)
- Humidity (non-condensing):
 - Operating: 20% to 80%
 - Non-operating: 20% to 80%

System Block Diagram

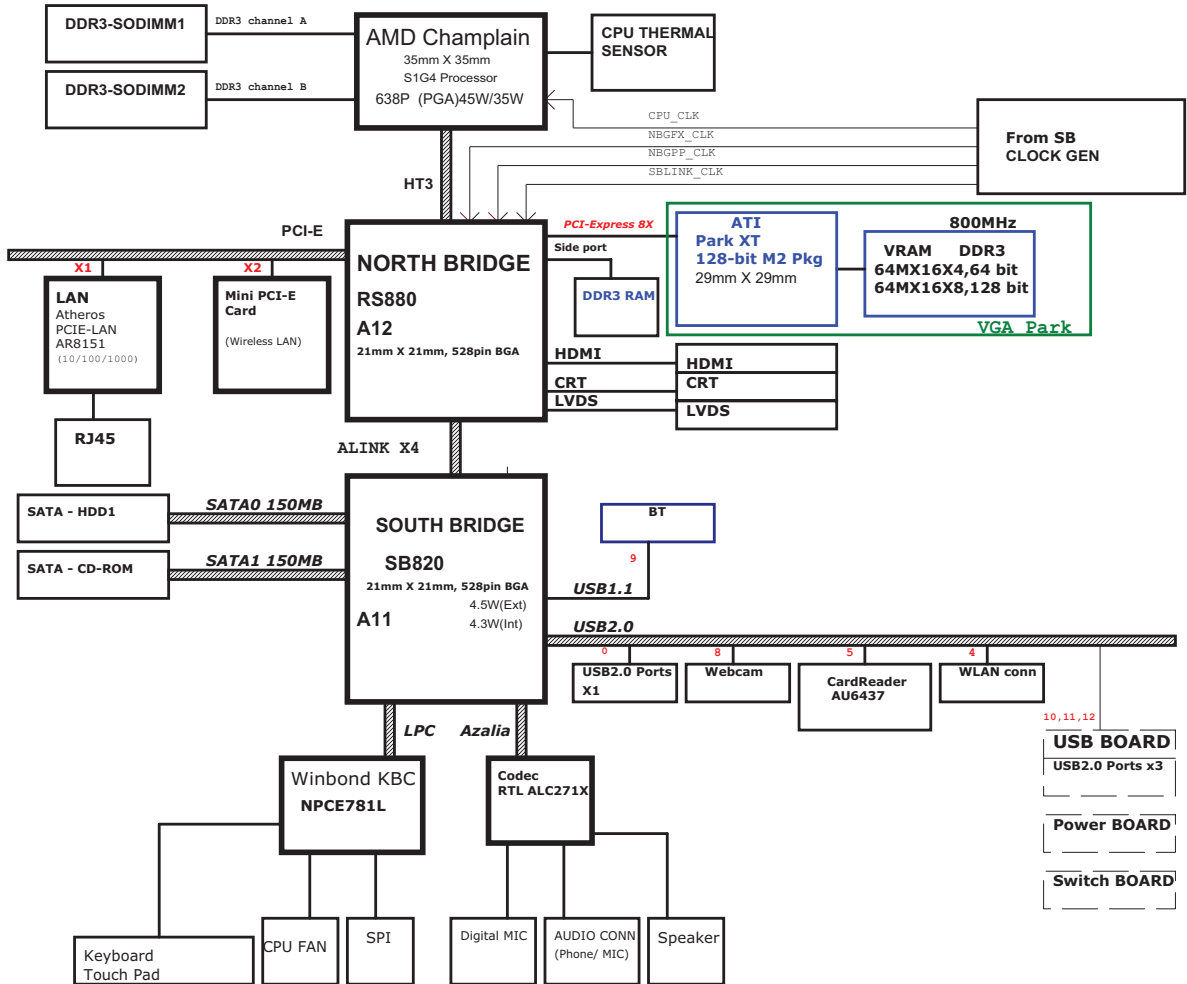





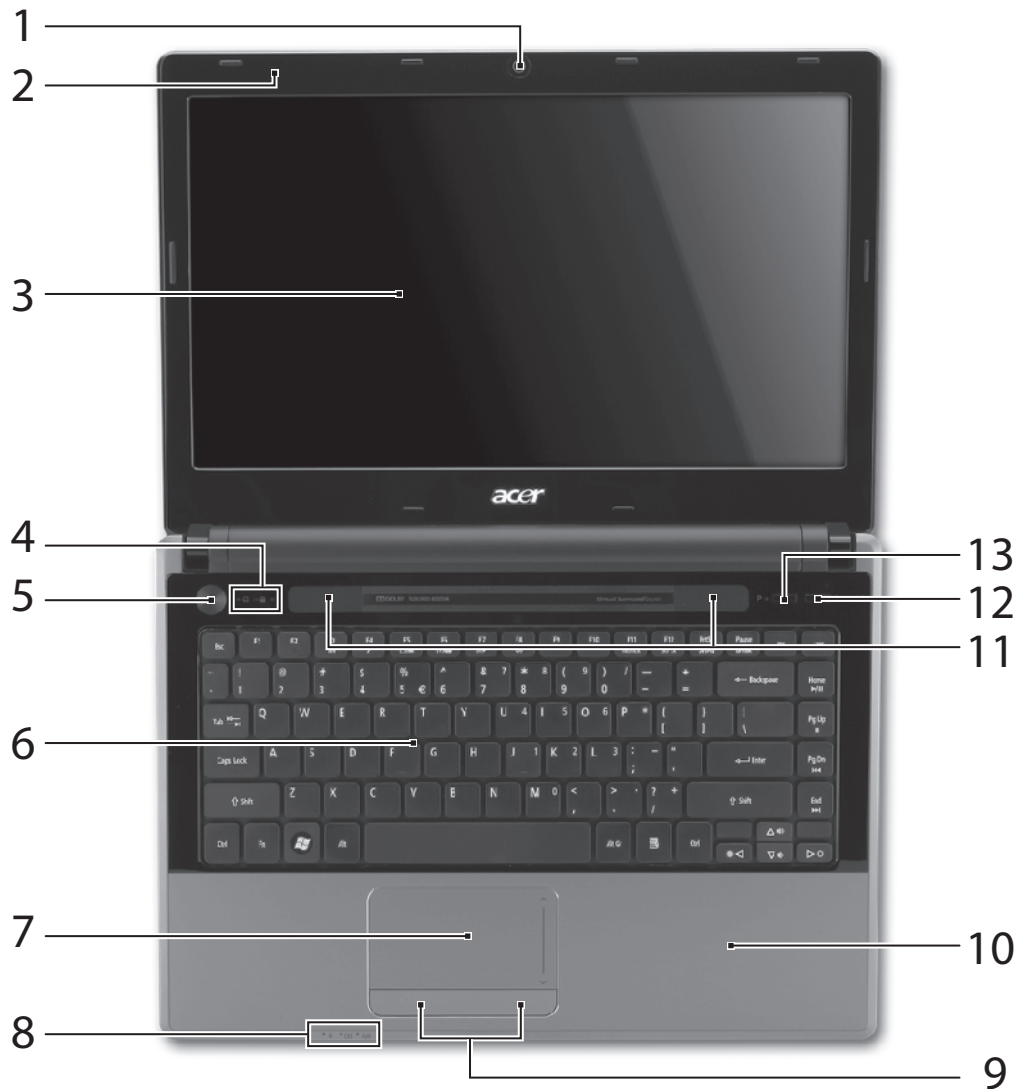



Your Acer Aspire Notebook tour

Front View



No.	Icon	Item	Description
1		Acer Crystal Eye webcam	Web camera for video communication (for selected models).
2		Microphone	Internal microphone for recording sound.
3		Display screen	Also called Liquid-Crystal Display (LCD), displays computer output.

No.	Icon	Item	Description
4		HDD	Indicates when the hard disk drive is active.
		Num Lock indicator	Lights up when Num Lock is activated.
		Caps Lock indicator	Lights up when Caps Lock is activated.
5		Power button	Turns the computer on and off.
6		Keyboard	For entering data into your computer.
7		TouchPad	Touch-sensitive pointing device which functions like a computer mouse.
8		Power Indicator	Indicates the computer's power status.
		Battery Indicator	Indicates the computer's battery status. 1. Charging: The light shows amber when the battery is charging. 2. Fully charged: The light shows blue when in AC mode.
		Communication Indicator	Indicates the computer's communication device status. (Function may vary by configuration.)
9		Click buttons (left and right)	The left and right buttons function like the left and right mouse buttons.
10		Palmrest	Comfortable support area for your hands when you use the computer.
11		Speakers	Left and right speakers deliver stereo audio output.
12		Optical drive eject button	Ejects the optical disk from the drive.
13		Programmable key	User-programmable. (only for certain models)
		PowerSmart key	Puts your computer into power-saving mode. (only for certain models)

Closed Front View



No.	Icon	Item	Description
1		Multi-in-1 card reader	Accepts Secure Digital (SD), MultiMediaCard (MMC), Memory Stick (MS), Memory Stick PRO (MS PRO), xD-Picture Card (xD). Note: Push to remove/install the card. Only one card can operate at any given time.

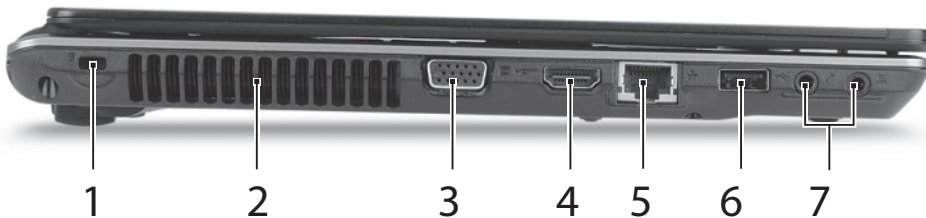

Left View

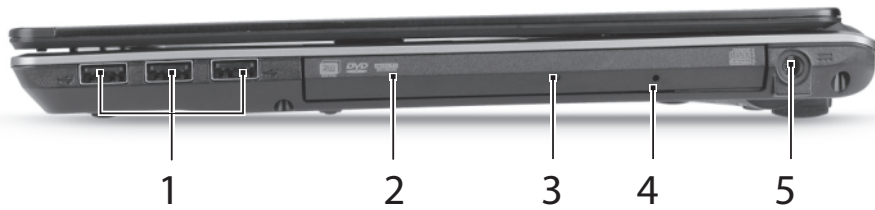

No.	Icon	Item	Description
1		Kensington lock slot	Connects to a Kensington-compatible computer security lock.
2		Ventilation slots	Enable the computer to stay cool, even after prolonged use.
3		External display (VGA) port	Connects to a display device (e.g. external monitor, LCD projector).
4		HDMI	Connect to HDMI devices
5		Ethernet (RJ-45) port	Connects to an Ethernet 10/100/1000-based network.
6		USB 2.0 ports	Connect to USB 2.0 devices (e.g. USB mouse, USB camera).
7		Microphone-in jack	Accepts input from external microphones.
		Headphones/speaker/line-out jack	Connects to audio line-out devices (e.g. speakers, headphones).

Right View



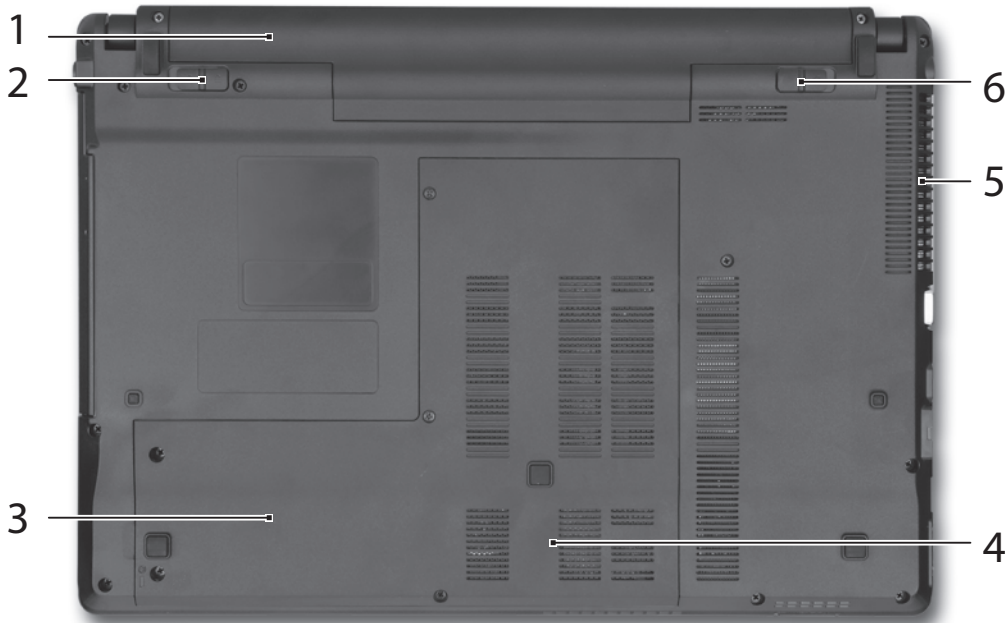

No.	Icon	Item	Description
1		USB 2.0 ports	Connect to USB 2.0 devices (e.g. USB mouse, USB camera).
2		Optical drive	Internal optical drive; accepts CDs or DVDs.
3		Optical disk access indicator	Lights up when the optical drive is active.
4		Emergency eject hole	Ejects the optical drive tray when the computer is turned off. Note: Insert a paper clip into the emergency eject hole to eject the optical drive tray when the computer is off.
5		DC-in jack	Connects to an AC adapter.

Bottom View







No.	Icon	Item	Description
1		Battery bay	Houses the computer's battery pack.
2		Battery lock	Locks the battery in position.

No.	Icon	Item	Description
3		Hard disk bay	Houses the computer's hard disk (secured with screws).
4		Memory compartment	Houses the computer's main memory.
5		Ventilation slots and cooling fan	Enable the computer to stay cool, even after prolonged use. Note: Do not cover or obstruct the fan opening.
6		Batter release latch	Releases the battery for removal.

Indicators

The computer has several easy-to-read status indicators. The front panel indicators are visible even when the computer cover is closed.

Icon	Function	Description
	Power	Indicates the computer's power status.
	Battery	Indicates the computer's battery status. NOTE: 1. Charging: The light shows amber when the battery is charging. 2. Fully charged: The light shows green when in AC mode.
	HDD	Indicates when the hard disk drive is active.
	Communication indicator	Indicates the computer's wireless connectivity device status.

TouchPad Basics

The following items show you how to use the TouchPad:

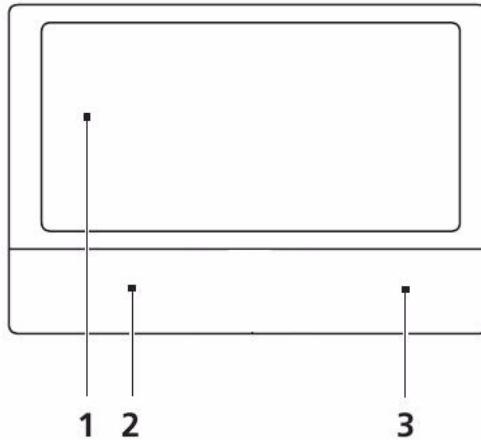

- Move your finger across the TouchPad (1) to move the cursor.
- Press the left (2) and right (3) buttons located beneath the TouchPad to perform selection and execution functions. These two buttons are similar to the left and right buttons on a mouse. Tapping on the TouchPad is the same as clicking the left button.

Function	Left Button (2)	Right Button (3)	Main TouchPad (1)
Execute	Quickly click twice.		Tap twice (at the same speed as double-clicking a mouse button).
Select	Click once.		Tap once.
Drag	Click and hold, then use finger on the TouchPad to drag the cursor.		Tap twice (at the same speed as double-clicking a mouse button); rest your finger on the TouchPad on the second tap and drag the cursor.
Access context menu		Click once.	

NOTE: When using the TouchPad, keep it - and your fingers - dry and clean. The TouchPad is sensitive to finger movement; hence, the lighter the touch, the better the response. Tapping too hard will not increase the TouchPad's responsiveness.

Using the Keyboard

The keyboard has full-sized keys and an embedded numeric keypad, separate cursor, lock, Windows, function and special keys.

Lock Keys and embedded numeric keypad

The keyboard has two lock keys which you can toggle on and off.

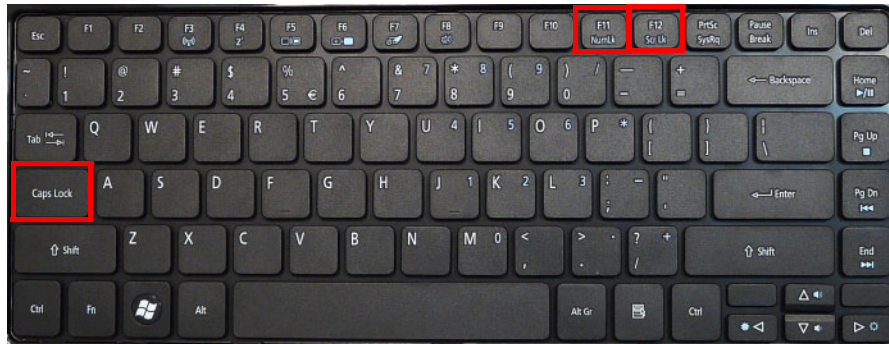



















Lock key	Description
Caps Lock	When Caps Lock is on, all alphabetic characters typed are in uppercase.
Num Lock	When Num Lock is on, the embedded keypad is in numeric mode.
Scroll Lock <Fn> + <F12>	When Scroll Lock is on, the screen moves one line up or down when you press the up or down arrow keys respectively. Scroll Lock does not work with some applications.

The embedded numeric keypad functions like a desktop numeric keypad. It is indicated by small characters located on the upper right corner of the keycaps. To simplify the keyboard legend, cursor-control key symbols are not printed on the keys.

Desired access	Num Lock on	Num Lock off
Number keys on embedded keypad	Type numbers in a normal manner.	
Cursor-control keys on embedded keypad	Hold <Shift> while using cursor-control keys.	Hold <Fn> while using cursor-control keys.
Main keyboard keys	Hold <Fn> while typing letters on embedded keypad.	Type the letters in a normal manner.

Windows Keys

The keyboard has two keys that perform Windows-specific functions.

Key	Description
 Windows key	<p>Pressed alone, this key has the same effect as clicking on the Windows Start button; it launches the Start menu. It can also be used with other keys to provide a variety of functions:</p> <ul style="list-style-type: none"><  >: Open or close the Start menu<  > + <D>: Display the desktop<  > + <E>: Open Windows Explore<  > + <F>: Search for a file or folder<  > + <G>: Cycle through Sidebar gadgets<  > + <L>: Lock your computer (if you are connected to a network domain), or switch users (if you're not connected to a network domain)<  > + <M>: Minimizes all windows<  > + <R>: Open the Run dialog box<  > + <T>: Cycle through programs on the taskbar<  > + <U>: Open Ease of Access Center<  > + <X>: Open Windows Mobility Center<  > + <BREAK>: Display the System Properties dialog box<  > + <SHIFT+M>: Restore minimized windows to the desktop<  > + <TAB>: Cycle through programs on the taskbar<  > + <SPACEBAR>: Bring all gadgets to the front and select Windows Sidebar<CTRL> + <  > + <F>: Search for computers (if you are on a network)<CTRL> + <  > + <TAB>: Use the arrow keys to cycle through programs on the taskbar <p>Note: Depending on your edition of Windows, some shortcuts may not function as described.</p>

Hot Keys

The computer employs hotkeys or key combinations to access most of the computer's controls like screen brightness, volume output and the BIOS utility.

To activate hot keys, press and hold the <Fn> key before pressing the other key in the hotkey combination.

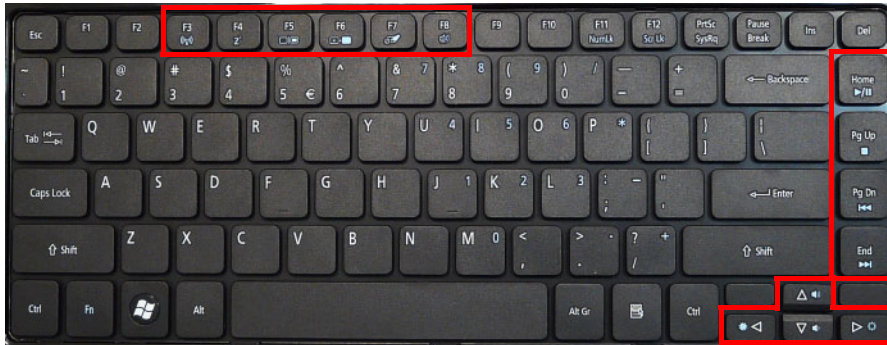

Hotkey	Icon	Function	Description
<Fn> + <F3>		Communication key	Enables / disables the computer's communication devices. (Communication devices may vary by configuration.)
<Fn> + <F4>		Sleep	Puts the computer in Sleep mode.
<Fn> + <F5>		Display toggle	Switches display output between the display screen, external monitor (if connected) and both.
<Fn> + <F6>		Display Off	Turns the display screen backlight off to save power. Press any key to return.
<Fn> + <F7>		Touchpad toggle	Turns the internal touchpad on and off.
<Fn> + <F8>		Speaker toggle	Turns the speakers on and off.
<Fn> + <F11>		NumLk	Turns the embedded numeric keypad on or off.
<Fn> + <▷>		Brightness up	Increases the screen brightness.
<Fn> + <◁>		Brightness down	Decreases the screen brightness.
<Fn> + <△>		Volume up	Increases the sound volume.
<Fn> + <▽>		Volume down	Decreases the sound volume.
<Fn> + <Home>		Play/Pause	Play or pause a selected media file.
<Fn> + <Pg Up>		Stop	Stop playing the selected media file.
<Fn> + <Pg Dn>		Previous	Return to the previous media file.
<Fn> + <End>		Next	Jump to the next media file.

Hardware Specifications and Configurations

Skew Comparison

Part	C1	C2 (UMA)	C3 (UMA)
	ZQ2B(AMD1.8,CMO14 ,SAM1G*2,SGA250G)	ZQ2C(AMD1.6,SA14,1 G*1+2G*1,TOS320G)	ZQ2C(AMD2.1,AU14,2 G*1+4G*1,WDC640G)
AMD CPU	CPU AMD PhenomII P820 1.8G 25W 1.5M L2, Triple-Core	CPU AMD PhenomII P920 1.6G 2M 25W Quad-Core	CPU AMD PhenomII N830 2.1G 35W 1.5M L2, Triple-Core
North Bridge Chip Set	AMD RS880M w/ HDCP EEPROM	AMD RS880M w/ HDCP EEPROM	AMD RS880M w/ HDCP EEPROM
LCD 14" Panel	LED LCD CMO 14" WXGA Glare N140B6-L24 LF 200nit 8ms 650:1 (Power saving)	LED LCD SAMSUNG 14" WXGA Glare LTN140AT12-A01 LF 200nit 16ms 500:1 (Power saving)	LED LCD AUO 14" WXGA Glare B140XW03 V0 LF 200nit 8ms 500:1 (Power saving)
System Memory	Memory SAMSUNG SO-DIMM DDRIII 1066 1GB M471B2873EH1-CF8 LF 64*16 0.055um	Memory HYNIX SO-DIMM DDRIII 1066 1GB HMT112S6BFR6C-G7 N0 LF 64*16 0.055um Memory HYNIX SO-DIMM DDRIII 1066 2GB HMT125S6BFR8C-G7 N0 LF 128*8 0.055um	Memory SAMSUNG SO-DIMM DDRIII 1333 2GB M471B5673FH0-CH9 LF 128*8 46nm Memory SAMSUNG SO-DIMM DDRIII 1333 4GB M471B5273CH0-CH9 LF 256*8 46nm
Hard Drive 9.5mm only - SATA	HDD SEAGATE 2.5" 5400rpm 250GB ST9250315AS Wyatt SATA LF F/ W:0001SDM1	HDD TOSHIBA 2.5" 5400rpm 320GB Capricorn BS ,MK3265GSX SATA 8MB LF F/W:GJ002J	HDD WD 2.5" 5400rpm 640GB WD6400BEVT-22A0RT0, ML320 SATA 8MB LF F/ W:01.01A01
Super-Multi (5.25"/9.5mm-H) SATA	ODD HLDS Super-Multi DRIVE 9.5mm Tray DL 8X GU10N LF W/O bezel SATA (HF + Windows 7)	ODD PANASONIC Super-Multi DRIVE 9.5mm Tray DL 8X UJ892 LF W/O bezel SATA GBAS2.0, (HF + Windows7)	ODD TOSHIBA Super-Multi DRIVE 9.5mm Tray DL 8X TS-U633F LF W/O bezel SATA (HF + Windows 7)
Battery	Battery SIMPLO AS10B Li-Ion 3S2P SAMSUNG 6 cell 6000mAh Main COMMON ID:AS10B7E	Battery SAMSUNG AS10B Li-Ion 3S2P SAMSUNG 6 cell 6000mAh Main COMMON ID:AS10B6E	Battery SIMPLO AS10B Li-Ion 3S2P SAMSUNG 6 cell 6000mAh Main COMMON ID:AS10B7E
AC Adapter	Adapter HIPRO 65W 19V 1.7x5.5x11 Yellow HP-A0652R3B 1LF, LV5 LED LF	Adapter LITE-ON 90W 19V 1.7x5.5x11 Blue PA-1900-34AR, LV5 LED LF	Adapter HIPRO 90W 19V 1.7x5.5x11 Blue HP-A0904A3 B1LF, LV5 LED LF
VRAM for side port	VRAM HYNIX Graphic DDRIII 800 1Gb H5TQ1G63BFR-12C LF		VRAM SAMSUNG Graphic DDRIII 800 1Gb K4W1G1646E-HC12 LF
VRAM	#N/A	VRAM HYNIX Graphic DDRIII 800 1Gb H5TQ1G63BFR-12C LF	VRAM SAMSUNG Graphic DDRIII 800 1Gb K4W1G1646E-HC12 LF

Part	C1	C2 (UMA)	C3 (UMA)
	ZQ2B(AMD1.8,CMO14 ,SAM1G*2,SGA250G)	ZQ2C(AMD1.6,SA14,1 G*1+2G*1,TOS320G)	ZQ2C(AMD2.1,AU14,2 G*1+4G*1,WDC640G)
VGA chip		AMD PARK_XT 40nm 29mm*29mm M2 package	
Wireless Lan Mini Card	Foxconn Wireless LAN Broadcomm 43225 2x2 BGN (HM) T77H103.00	Foxconn Wireless LAN Atheros HB93 2x2 BGN (HM)	Foxconn Wireless LAN Atheros HB97 2x2 BGN (HM)
Blue Tooth	Foxconn Bluetooth ATH AR3011		Foxconn Bluetooth BRM 2046 BT2.1 (T60H928.33) f/w:861
Camera	Suyin 1.3M SY9665SN	Liteon 1.3M LT9665AL (09P2SF119)	Liteon 1.3M LT9665AL (09P2SF119)

NOTE: Parts that are the same across all skews have been removed from this table.

CPU

Item	Specification
CPU	AMD Champlain
Graphics	ATI Park XT
CPU Package	638P (PGA) 35x35mm
Power	
On-die Cache	
Northbridge	RS880MC 21x21mm, 528pin BGA
Southbridge	SB820M 21x21mm, 528pin BGA

Processor Specifications

Item	CPU Speed	Cores	Bus Speed	Cache Size	Package	Core Voltage	Acer P/N
P320	2.1G	2	3.6 GT/s	1MB	RS880	25W	KC.AP002.320
P820	1.8G	3	3.6 GT/s	1.5MB	RS880	25W	KC.PP002.820
P920	1.6G	4	3.6 GT/s	2MB	RS880	25W	KC.PP002.920
P520	2.3G	2	3.6 GT/s	2MB	RS880	25W	KC.TP002.520

CPU Fan True Value Table (Performance Mode)

Fan On (°C)	Fan Off (°C)	RPM
42	38	2600
50	45	3200
58	52	3600
65	60	3900
78	73	4200
94	89	95% Duty

- Throttling 50%: On = 95C; Off = 90C
- OS Shutdown: 98°C
- H/W Shutdown: 95°C

CPU Fan True Value Table (Power Saving Mode)

Fan On (°C)	Fan Off (°C)	RPM
43	38	2600
55	50	3200
65	60	3600
72	69	3900
81	76	4200
94	89	95% Duty

- Throttling 50%: On = 95C; Off = 90C
- OS Shutdown: 98°C
- H/W Shutdown: 95°C

BIOS

Item	Specification
BIOS vendor	Phoenix
BIOS Version	1.xx
BIOS ROM type	1M SPI ROM
Features	<ul style="list-style-type: none">• Flash ROM 1MB• Support ISIPP• Support Acer UI• Support multi-boot• Suspend to RAM (S3)/Disk (S4)• Various hot-keys for system control• DMI utility for BIOS serial number configurable/asset tag• Support PXE• Support Y2K solution• Support WinFlash• Wake on LAN from S3• Wake on LAN from S4 in AC mode

System Memory

Item	Specification
Memory size	8GB maximum
DIMM socket number	2
Supports memory size per socket	4GB
Supports DIMM type	204-pin +1.5V DDRIII
Supports DIMM Speed	400/533/667 MHz
Supports DIMM voltage	1.5V

Memory Combinations

Slot 1	Slot 2	Total Memory
0MB	1024MB	1024MB
0MB	2048MB	2048MB
0MB	4096MB	4096MB
1024MB	0MB	1024MB
1024MB	1024MB	2048MB
1024MB	2048MB	3072MB
2048MB	0MB	2048MB
2048MB	1024MB	3072MB
2048MB	2048MB	4096MB
2048MB	4096MB	6144MB
4096MB	4096MB	8192MB

Above table lists some system memory configurations. You may combine DIMMs with various capacities to form other combinations. In the above table, the configuration of slot 1 and slot 2 could be reversed.

System Board Major Chips

Item	Specification
Northbridge	RS880
Southbridge	SB820
VGA	ATI Park XT
LAN	AR8151
USB	USB 2.0
Super I/O controller	NPCE781
Bluetooth	T60H928.33
Wireless	Atheros HB93, HB97, HB95BG (HM), Broadcom 43225
PCMCIA	N/A
Audio codec	Realtek ALC271X
Card reader	AU6437

I/O Ports

Item	Specification
I/O support	<ul style="list-style-type: none"> • 4-in-1 card reader (SD, MMC, MS, xD) • Four USB 2.0 ports • HDMI™ port • External display (VGA) port • Headphone/speaker/line-out jack • Microphone-in jack • Ethernet (RJ-45) port • DC-in jack for AC adapter

Wireless Module

Item	Specification
Manufacturer	<ul style="list-style-type: none">Atheros HB93, Broadcom 43225, Atheros HB97, Atheros HB95BG
Specifications	<ul style="list-style-type: none">IEEE 802.11b/g and Draft-N1 compliantAdvanced security via 802.11iIndustry-leading power consumptionIncludes Wi-Fi PAN – Intel® My WiFi TechnologyEasy to use Intel® PROSet v12.5 WLAN SoftwareAdvanced IT capabilities with Intel® PROSet Software4Support for Cisco Compatible Extensions* v4Connect with Intel® Centrino® program eligible

LAN Module

Item	Specification
Chipset	<ul style="list-style-type: none">Atheros AR8151 GbE LAN Controller with Integrated Transceiver
Specifications	<ul style="list-style-type: none">Integrated PHY for 10/100/1000 MbpsSupports automatic MDI/MDIX functionsPCI Express base 1.1 compliantWake on LAN support256 byte memory (using eFuse) embedded on chipSupports up to 25% over-clocking without requiring BIOS supportSupports Energy Star 5.0Small footprint 40-pin QFN (5 x 5 mm) package with dramatically improved thermal and electrical characteristics over LQFP packaging

Bluetooth

Item	Specification
Chipset	T60H928.33 miniUSB module
Data throughput	
Protocol	2.1
Interface	USB 2.0
Connector type	8 pin narrow pitch connector

Hard Disk Drive Interface

Item	Specification				
Vendor & Model Name	Seagate	HGST	Toshiba	Western Digital	Samsung
Capacity (MB)	160, 250, 320, 500	160, 250, 320, 500	160, 250, 320, 500	160, 250, 320, 500, 640	60, 80, 120, 160, 250
Bytes per sector	512				
Data heads	2-4				
Drive Format					
Disks	1-2				
Spindle speed (RPM)	5400				
Performance Specifications					
Buffer size	8 MB				
Interface	SATA				
DC Power Requirements					
Voltage tolerance	5V ±5%				

Super-Multi Drive Module

Item	Specification			
Vendor & model name	HLDS GT20N		Sony AD7580S	
Performance Specification	With CD Diskette	With DVD Diskette	With CD Diskette	With DVD Diskette
Transfer rate (MB/sec)	Sustained: 3,600 KB/s (24x) max.	Sustained: 11.08 Mbytes/s (8x) max.	Sustained: 1,571 (typical)	Sustained: 10,993 (typical)
Buffer Memory	2 MB			
Interface	SATA			
Applicable disc formats	DVD-ROM: 4.7GB (Single Layer) 8.5GB (Dual Layer) DVD-R: 3.95GB (Ver. 1.0: read only) 4.7GB (Ver. 2.0 for Authoring: read only) 4.7GB (Ver. 2.1 for General: read & write) (DL) 8.5GB (Ver. 3.0) DVD-RW: 4.7GB (Ver. 1.2/ Rev 1.0, 2.0, 3.0) DVD-RAM: 1.46GB/side, 4.7GB/side (Ver. 2.2) DVD+R: 4.7GB (Ver. 1.3) (DL) 8.5GB (Ver. 1.1) DVD+RW: 4.7GB (Vol.1 Ver.1.3) CD-ROM Mode-1 data disc CD-ROM Mode-2 data disc CD-ROM XA, CD-I, Photo-CD Multi-Session, Video CD CD-Audio Disc Mixed mode CD-ROM disc (data and audio) CD-Extra CD-Text CD-R (Conforming to "Orange Book Part 2": read & write) CD-RW (Conforming to "Orange Book Part 3": read & write)		DVD Read: DVD-ROM (DVD-5, DVD-9, DVD-10, DVD-18), DVD-Video, DVD-Audio, SACD (Hybrid), UDF DVD, DVD-R, DVD-R DL, DVD-R 3.95 GB, DVD-R Authoring, DVD-R Multi-Border, DVD-RW, DVD+R, DVD+R DL, DVD+R Multi-Session, DVD+RW, DVD-RAM V1.0, DVD-RAM V2.0 & 2.1 & 2.2. CD Read: CD-DA, CD-ROM Mode-1, CD-ROM/XA Mode-2 Form-1 and Mode-2 Form-2, CD-i, CD-i Bridge, Video-CD (MPEG-1), Karaoke CD, Photo-CD, Enhanced CD, CD Plus, CD Extra, itrax CD, CD-Text, UDF CD, CD-R, and CD-RW DVD Write: DVD Data & Video CD Read: CD-DA, CD-ROM Mode-1, CD-ROM/XA Mode-2 Form-1 and Mode-2 Form-2, CD-i, Video-CD, CD-Text	
Loading mechanism	Drawer (Solenoid Open) Tact SW (Open) Emergency Release (draw open hole)			
Power Requirement				
Input Voltage	DC 5 V +/- 5%			

Audio Interface

Item	Specification
Codec Controller	Realtek ALC271X high definition audio codec with embedded class-D speaker amplifier
Audio onboard or optional	<ul style="list-style-type: none">Onboard
Mono or Stereo	<ul style="list-style-type: none">Stereo
Resolution	<ul style="list-style-type: none">98dB Signal-to-Noise Ratio (A-weighting) for DAC output90dB Signal-to-Noise Ratio (A-weighting) for ADC input Internal Digital
Compatibility	<ul style="list-style-type: none">Headphone-outS/PDIF, Line-In and Microphone-In.2 stereo ADCs support 16/20/24-bit PCM format recording simultaneously.
Sampling Rate	<ul style="list-style-type: none">All DACs supports 16/20/24-bit, 44.1k/48k/96k/192kHz sample rate.Two independent S/PDIF-OUT converters support 16/20/24-bit, 44.1k/48k/88.2k/96k/192kHz sample rate. One for normal S/PDIF output, the other one output an independent digital stream to HDMI transmitter.
Internal Microphone	<ul style="list-style-type: none">Digital MICRO PHONE ZK2(HFM-M101-006-L19-G)Digital MICRO PHONE ZK2(A-OA2408FM-018)
Internal Speakers	<ul style="list-style-type: none">Two Med-High Speakers (1W/4Û)

Keyboard Controller

Item	Specification
Controller	Winbond NPCE781L
Total number of keypads	99-/100-/103-key keyboard
Windows logo key	Yes
Hotkeys	See "Hot Keys" on page 15.

Battery

Item	Specification
	6 Cell
Vendor & model name	SANYO/SONY/PANASONIC/SAMSUNG/SIMPLO AS2009A
Battery Type	Li-ion
Pack capacity	4400 mAh
Normal Voltage	2.2 Ah
Package configuration	3S2P

RTC Battery

Item	Specification
Part name	CR2032
Pack capacity	220 mAh
Normal voltage	3V

AC Adapter

Item	Specification
Input rating	100 Vac to 240 Vac
Maximum input AC current	100 Vac, 240 Vac / 3.42A load 1.5A
Inrush current	240 Vac; (Cold Start) No damage
Efficiency	100 Vac / 120W load 85% 240 Vac / 120W load 85%

System LED Indicator

Item	Specification
Drive Activity	Power Led: Blue Suspend: Amber
Primary Battery charging state	Amber: Battery Charging

LCD 14"

Item	Specification
Vendor/model name	CMO N140B6-L24 LF, Samsung LTN140AT06-A01/LTN140AT12-A01, LG LP140WH2-TLA2/LP140WH2-TLL1/LP140WH2-TLL1, AUO B140XW02 V1/B140XW03 V0/B140XW03 V0
Screen Diagonal (mm)	14" diagonal
Display Area (mm)	382.08 (H) x 214.92 (V) mm
Display resolution (pixels)	1600 x 900
Pixel Pitch	0.0796 (H) x 0.2388 (V) (TYP.) mm
Display Mode	Normally white
Typical White Luminance (cd/m ²) (also called Brightness)	220 cd/m ²
Contrast Ratio	600
Response Time (Optical Rise Time/Fall Time) msec	8 ms
Weight	540g
Physical Size (mm)	398.1(H) x 232.8 (V) x 5.7 (D) mm
Electrical Interface	LVDS
Support Color	16.7 million colors
Viewing Angle (up/down/right/ left)	40 Degrees (L+R), 15 Degrees (H), 30 Degrees (L)
Temperature Range (°C) Operating Storage (shipping)	0 Min - 60 Max -20 Min - 50 Max

LCD Display Supported Resolution

Resolution	24 bits	30 bits	36 bits	48 bits
640X480p/60Hz 4:3	Yes	Yes	Yes	Yes
720X480p/60Hz 4:3	Yes	Yes	Yes	Yes
640X480p/60Hz 16:9	Yes	Yes	Yes	Yes
1280X720p/60Hz 16:9	Yes	Yes	Yes	Yes
1920X1080p/60Hz 16:9	Yes	Yes	Yes	Yes
1440X480p/60Hz 4:3	Yes	Yes	Yes	Yes
1440X480p/60Hz 16:9	Yes	Yes	Yes	Yes
1920X1080p/50Hz 16:9	Yes	Yes	Yes	Yes
720X576p/50Hz 4:3	Yes	Yes	Yes	Yes
720X576p/50Hz 16:9	Yes	Yes	Yes	Yes
1280X720p/50Hz 16:9	Yes	Yes	Yes	Yes
1920X1080i/50Hz 16:9	Yes	Yes	Yes	Yes
1440X576i/50Hz 4:3	Yes	Yes	Yes	Yes
1440X576i/50Hz 16:9	Yes	Yes	Yes	Yes
1920X1080p/50Hz 16:9	Yes	Yes	Yes	Yes

Video Interface

Item	Specification
Chipset	ATI Park XT
Package	128bit M2 29x29mm
Features	<ul style="list-style-type: none">• PCI Express x8• DirectX 11 compliant• 32 and 64 bit floating point processing per component• OpenGL 3.1 supported• Open CLTM 1.1 supported

VRAM

Item	Specification
Chipset	SAMSUNG or HYNIX
Memory size	64Mx16x4, 64bit 64Mx16x8, 128bit
Interface	GDDR3

HDMI Port

Item	Specification
Compliance level	1.3 compliant
Throughput	Up to 2.5Gbps per lane (250MHz pixel clock)
Number of HDMI port(s)	1
Location	Left side

Card Reader

Item	Specification
Part Name	RealTek RT5160
Package	5-in-1 card reader
General Features	<ul style="list-style-type: none">• PCI-E interface• Push-push type• Dummy card

LCD Inverter (Not available with this model)

Item	Specification
Vendor & model name	
Brightness conditions	
Input voltage (v)	
Input current (mA)	
Output voltage (V, RMS)	
Output current (mA, RMS)	
Output voltage frequency (KHz)	

PCMCIA Port (Not available in this model)

Item	Specification
PCMCIA controller	
Supports card type	
Number of slots	
Access location	
Supports ZV (Zoomed Video) port	
Supports 32-bit CardBus	

System Power Management

Item	Initial	On	Standby	Suspend	Hibernate	Soft Off
Initial		1				
On(S0)			2	3	4	5
Standby(S1)		6				
Suspend(S3)		7				
Hibernate(S4)		8				
Soft Off(S5)		9				

Mechanical off is a condition where all power except the RTC battery has been removed from the system.

1. Initial to On state: When the AC adapter or Battery pack has been plugged into the system, the I WPC781 will be reset and initial all output pins then the system goes into Initial state and waiting for power on event. If the power button is pressed then the system will go into the ON state.
2. ON to Standby state: The system will go into the Standby state when HM55 receives the POS command.
3. ON to Suspend state: The system will go into Suspend state when HM55 receives the S2R command.
4. ON to Hibernate state: The system will go into Hibernate state when HM55 receives the S2D command.
5. ON to Soft Off state: The system will go into Soft Off state when HM55 receives the Soft off command.
6. Standby to ON state: The system will go into ON state when the system receives any wake up events, for example, keyboard, mouse.
7. Suspend to ON state: The system will go into ON state when the power button is pressed.
8. Hibernate to ON state: The system will go into ON state when the power button is pressed.
9. Soft Off to ON state: The system will go into ON state when the power button is pressed.

System Utilities

BIOS Setup Utility

The BIOS Setup Utility is a hardware configuration program built into your computer's BIOS (Basic Input/Output System).

Your computer is already properly configured and optimized, and you do not need to run this utility. However, if you encounter configuration problems, you may need to run Setup. Please also refer to Chapter 4 Troubleshooting when problems arise.

To activate the BIOS Utility, press **F2** during POST (when "Press <F2> to enter Setup" message is prompted on the bottom of screen).

The default parameter of F12 Boot Menu is set to "disabled". If you want to change boot device without entering BIOS Setup Utility, please set the parameter to "enabled".

Press <F12> during POST to enter multi-boot menu. In this menu, user can change boot device without entering BIOS SETUP Utility.

Navigating the BIOS Utility

There are five menu options: Information, Main, Security, Boot, and Exit.

Follow these instructions:

- To choose a menu, use the left and right arrow keys.
- To choose an item, use the up and down arrow keys.
- To change the value of a parameter, press **F5** or **F6**.
- Press **Esc** while you are in any of the menu options to go to the Exit menu.
- In any menu, you can load default settings by pressing **F9**. You can also press **F10** to save any changes made and exit the BIOS Setup Utility.

NOTE: You can change the value of a parameter if it is enclosed in square brackets. Navigation keys for a particular menu are shown on the bottom of the screen. Help for parameters are found in the Item Specific Help part of the screen. Read this carefully when making changes to parameter values. **Please note that system information is subject to different models.**

Aspire JV41 BIOS

Information

The Information screen displays a summary of the computer hardware information.

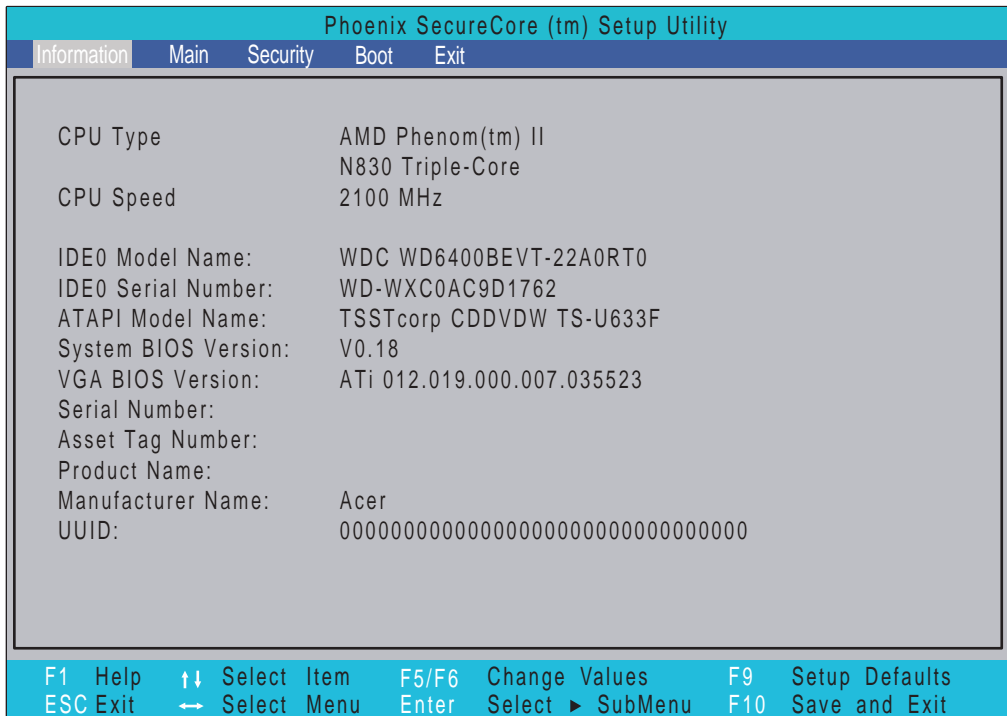

NOTE: The screen above is for your reference only. Actual values may differ according to model.

The table below describes the parameters in this screen.

Parameter	Description
CPU Type	This field shows the CPU type and speed of the system.
CPU Speed	This field shows the speed of the CPU.
IDE0 Model Name	This field shows the model name of HDD installed.
IDE0 Serial Number	This field displays the serial number of HDD installed on the system.
ATAPI Model Name	This field shows the model name of the Optical device installed in the system.
System BIOS Version	Displays system BIOS version.
VGA BIOS Version	This field displays the VGA firmware version of the system.
Serial Number	This field displays the serial number of this unit.
Asset Tag Number	This field displays the asset tag number of the system.
Product Name	This field shows product name of the system.
Manufacturer Name	This field displays the manufacturer of this system.
UUID	Universally Unique Identifier (UUID) is an identifier standard used in software construction, standardized by the Open Software Foundation (OSF) as part of the Distributed Computing Environment (DCE).

Main

The Main screen allows the user to set the system time and date as well as enable and disable boot options and recovery.

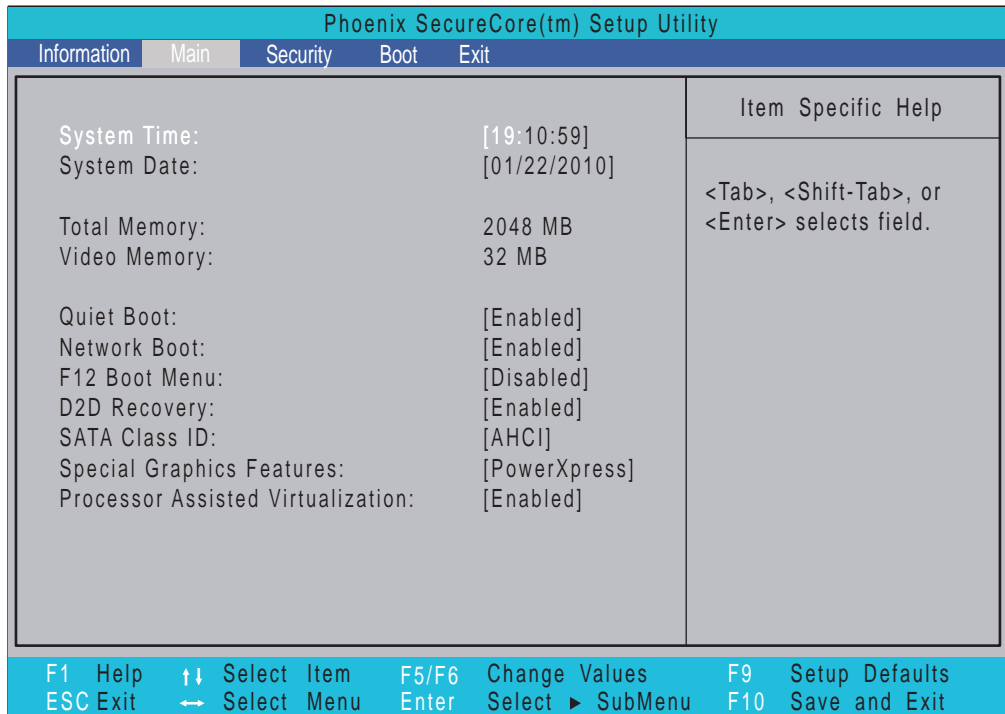

NOTE: The screen above is for your reference only. Actual values may differ.

The table below describes the parameters in this screen.

Parameter	Description	Format/Option
System Time	Sets the system time. The hours are displayed with 24-hour format.	Format: HH:MM:SS
System Date	Sets the system date.	Format MM/DD/YYYY
Total Memory	Displays the total memory available.	N/A
Video Memory	Displays the available memory for Video.	N/A
Quiet Boot	The notebook displays an illustration called the OEM screen during system boot instead of the traditional POST screen that displays the normal diagnostic messages.	Option: Enabled or Disabled
Network Boot	Enables, disables the system boot from LAN (remote server).	Option: Enabled or Disabled
F12 Boot Menu	Enables, disables Boot Menu during POST.	Option: Enabled or Disabled
D2D Recovery	Enables, disables D2D Recovery function. The function allows the user to restore the system to factory defaults.	Option: Enabled or Disabled
SATA CLASS ID	Select SATA controller mode.	Option: IDE Mode or AHCI Mode
Special Graphics Features	Select discreet graphics for switchable graphics, or integrated graphics.	Option: Switchable/Integrated
Processor Assisted Virtualization	Enable CPU hardware virtualization support.	Option: Enabled or Disabled

Security

The Security screen contains parameters that help safeguard and protect your computer from unauthorized use.

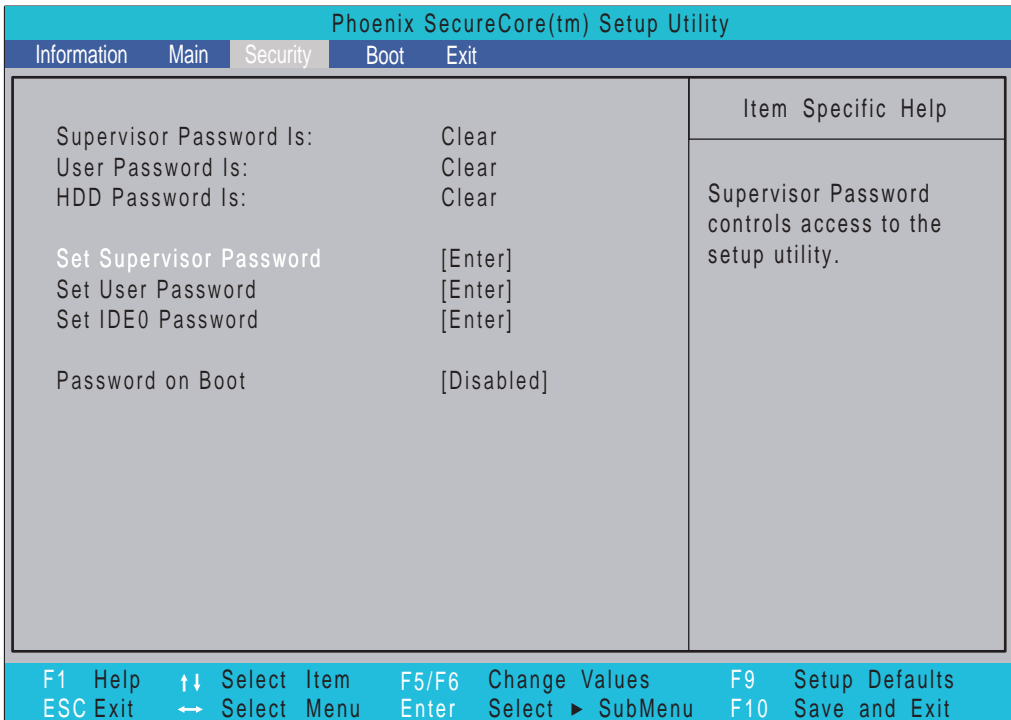

The table below describes the parameters in this screen. Settings in **boldface** are the default and suggested parameter settings.

Parameter	Description	Option
Supervisor Password Is	Shows the setting of the Supervisor password	Clear or Set
User Password Is	Shows the setting of the user password.	Clear or Set
HDD Password Is	Shows the setting of the hard disk password.	Clear or Set
Set Supervisor Password	Press Enter to set the supervisor password. When set, this password protects the BIOS Setup Utility from unauthorized access. The user can not either enter the Setup menu nor change the value of parameters.	N/A
Set User Password	Press Enter to set the user password. When user password is set, this password protects the BIOS Setup Utility from unauthorized access. The user can enter Setup menu only and does not have right to change the value of parameters.	N/A
Set IDE0 Password	Enter HDD Password.	N/A
Password on Boot	Defines whether a password is required or not while the events defined in this group happened. The following sub-options are all requires the Supervisor password for changes and should be grayed out if the user password was used to enter setup.	Disabled or Enabled

NOTE: When you are prompted to enter a password, you have three tries before the system halts. Don't forget your password. If you forget your password, you may have to return your notebook computer to your dealer to reset it.

Setting a Password

Follow these steps as you set the user or the supervisor password:

1. Use the ↑ and ↓ keys to highlight the Set Supervisor Password parameter and press the **Enter** key. The Set Supervisor Password box appears:

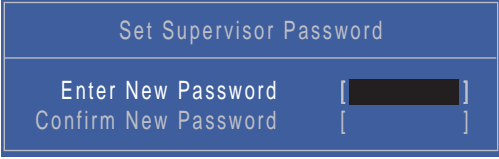

Set Supervisor Password	
Enter New Password	[REDACTED]
Confirm New Password	[REDACTED]

2. Type a password in the “Enter New Password” field. The password length can not exceed 8 alphanumeric characters (A-Z, a-z, 0-9, not case sensitive). Retype the password in the “Confirm New Password” field.

IMPORTANT: Be very careful when typing your password because the characters do not appear on the screen.

3. Press **Enter**. After setting the password, the computer sets the User Password parameter to “Set”.
4. If desired, you can opt to enable the Password on boot parameter.
5. When you are done, press F10 to save the changes and exit the BIOS Setup Utility.

Removing a Password

Follow these steps:

1. Use the ↑ and ↓ keys to highlight the Set Supervisor Password parameter and press the **Enter** key. The Set Password box appears:



Set Supervisor Password	
Enter Current Password	[REDACTED]
Enter New Password	[REDACTED]
Confirm New Password	[REDACTED]

2. Type the current password in the Enter Current Password field and press **Enter**.
3. Press **Enter** twice **without** typing anything in the Enter New Password and Confirm New Password fields. The computer then sets the Supervisor Password parameter to “Clear”.
4. When you have changed the settings, press u to save the changes and exit the BIOS Setup Utility.

Boot

This menu allows the user to decide the order of boot devices to load the operating system. Bootable devices includes the USB diskette drives, the onboard hard disk drive and the DVD drive in the module bay.

Select Boot Devices to select specific devices to support boot.

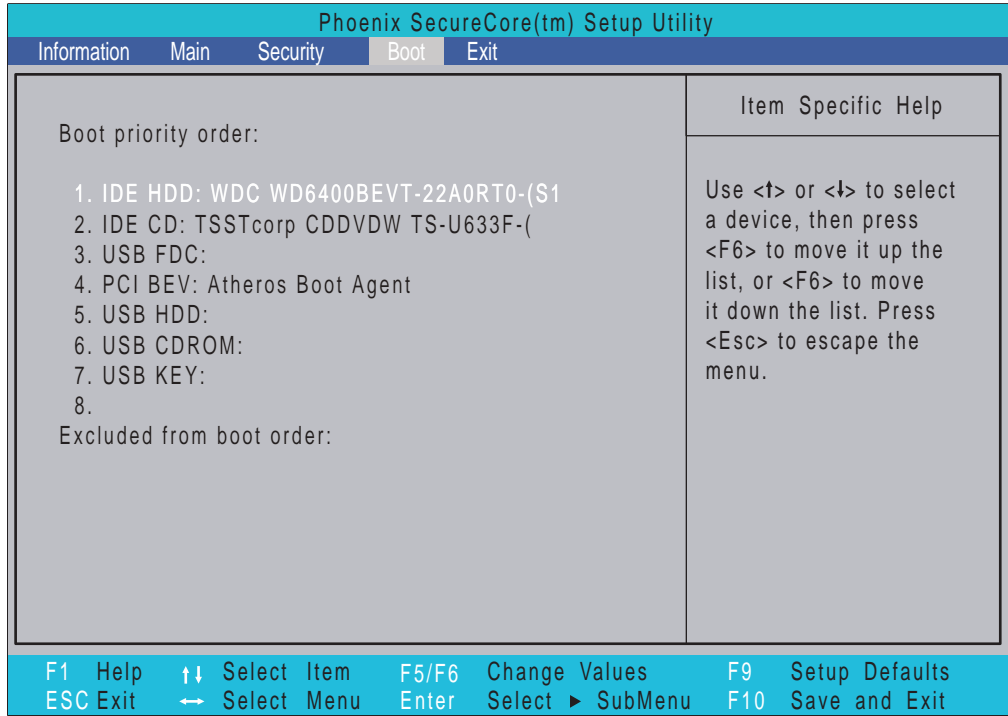

Exit

The Exit screen allows you to save or discard any changes you made and quit the BIOS Utility.

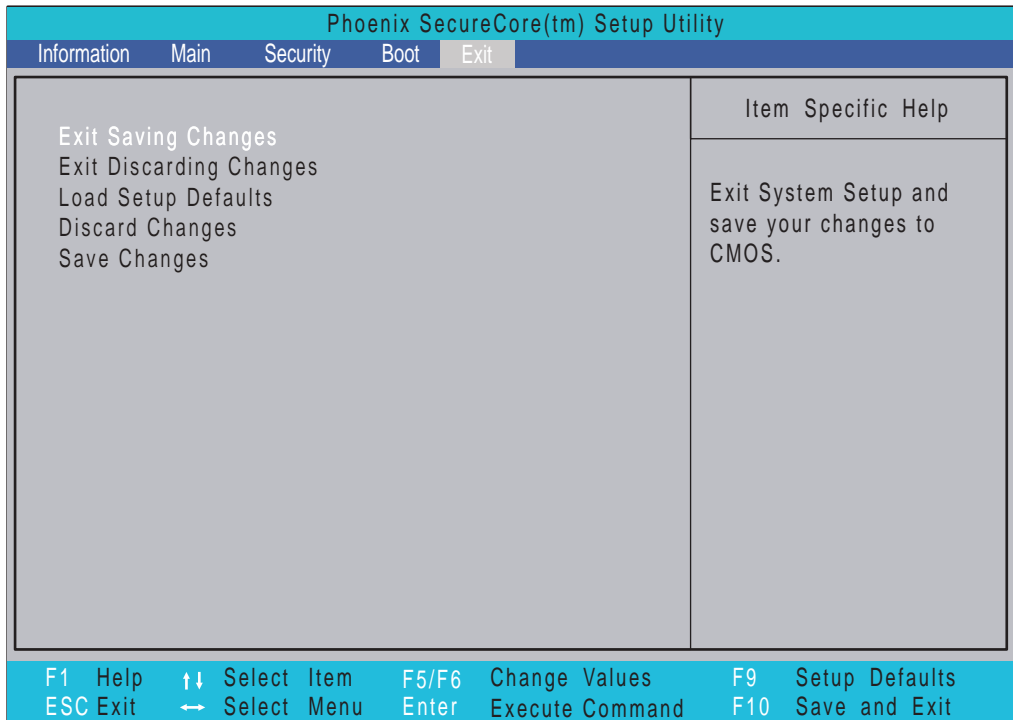

The table below describes the parameters in this screen.

Parameter	Description
Exit Saving Changes	Exit System Setup and save your changes.
Exit Discarding Changes	Exit utility without saving setup data.
Load Setup Default	Load default values for all setup items.
Discard Changes	Load previous values for all setup items.
Save Changes	Save setup data.

BIOS Flash Utilities

The BIOS flash memory update is required for the following conditions:

- New versions of system programs
- New features or options
- Restore a BIOS when it becomes corrupted.

Use the flash utility to update the system BIOS flash ROM.

NOTE: If you do not have a crisis recovery diskette at hand, then you should create a **Crisis Recovery Diskette** before you use the flash utility.

NOTE: Do not install memory-related drivers (XMS, EMS, DPMI) when you use the flash.

NOTE: Please use the AC adaptor power supply when you run the flash utility. If the battery pack does not contain enough power to finish BIOS flash, you may not boot the system because the BIOS is not completely loaded.

Follow the steps below to run the flash.

1. Prepare a bootable diskette.
2. Copy the flash utilities to the bootable diskette.
3. Then boot the system from the bootable diskette. The flash utility has auto-execution function.

DOS Flash Utility

Perform the following steps to use the DOS Flash Utility:

1. Press F2 during boot to enter the Setup Menu.
2. Select **Boot Menu** to modify the boot priority order, for example, if using USB HDD to Update BIOS, move USB HDD to position 1.

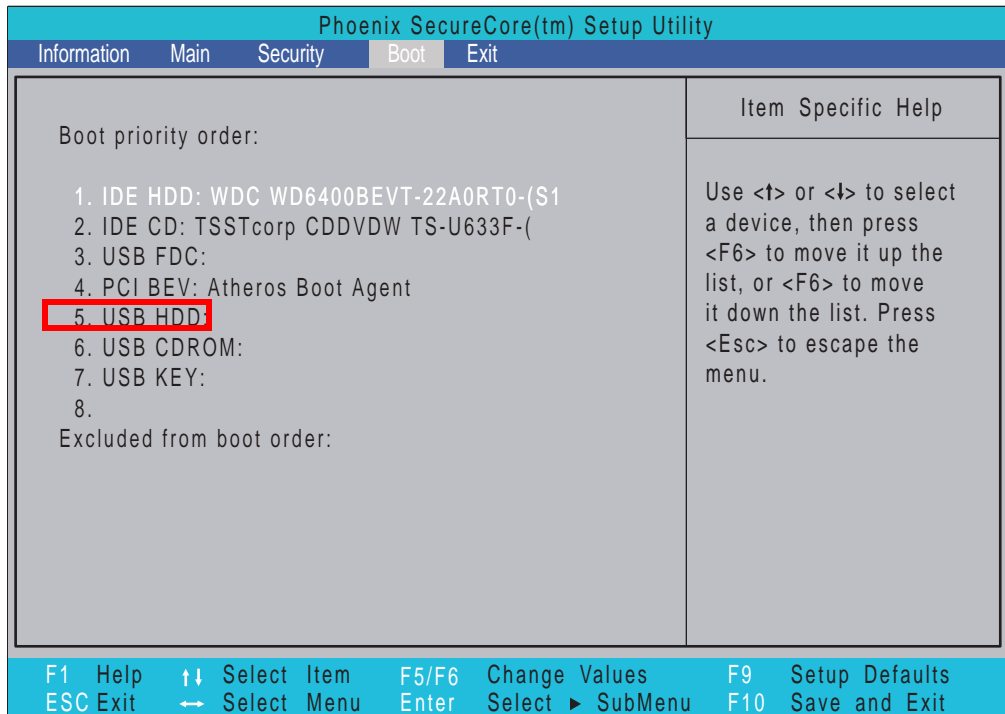

3. Execute the **BIOS.BAT** batch file to update BIOS.

The flash process begins as shown.

4. In flash BIOS, the message **Please do not remove AC Power Source** displays.

NOTE: If the AC power is not connected, the following message displays.

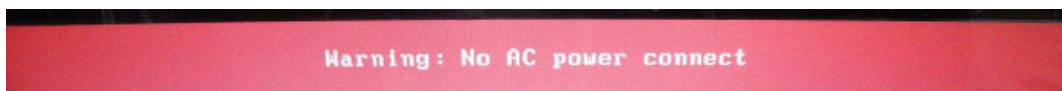

Plug in the AC power to continue.

5. Flash is complete when the message Flash programming complete displays.

WinFlash Utility

Perform the following steps to use the WinFlash Utility:

1. Double-click the WinFlash executable.
2. Click **OK** to begin the update. A progress screen displays.

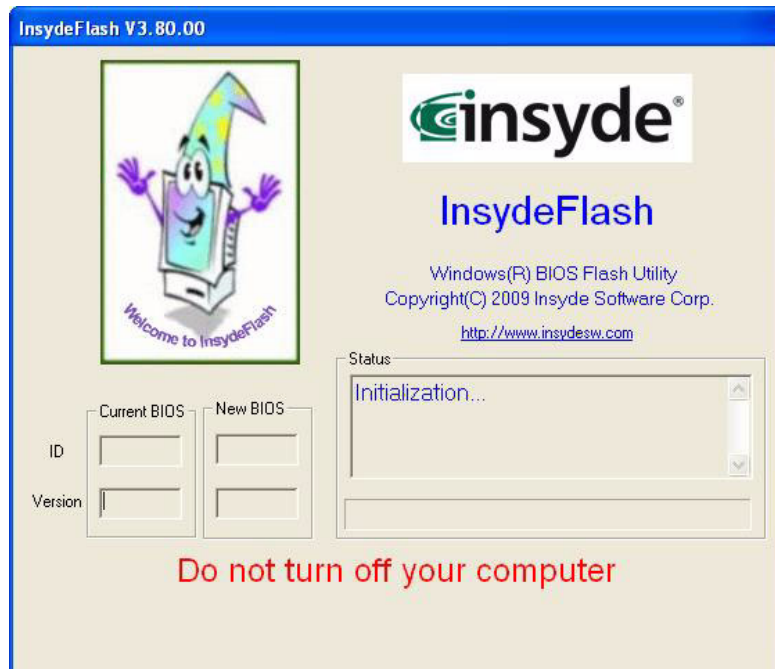

Remove HDD/BIOS Password Utilities

This section provides you with details about removing HDD/BIOS password:

Remove HDD Password:

If you key in the wrong HDD password three times, an error is generated.

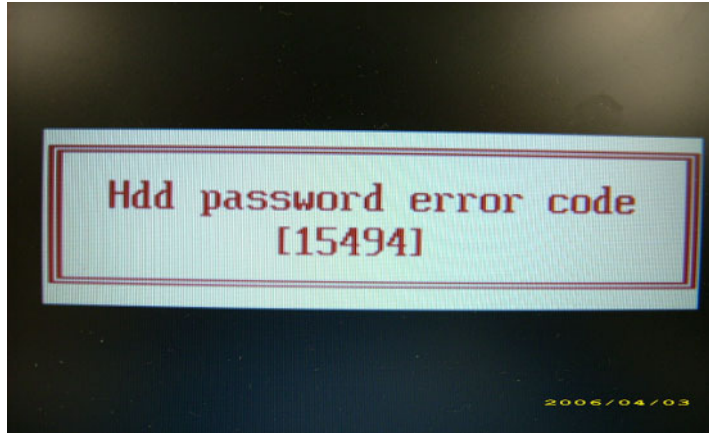

To reset the HDD password, perform the following steps:

1. On another computer, run HDD_PW.exe.
2. Enter "hdd_pw 15494 0"
3. Chose one (1) of the generated passwords.

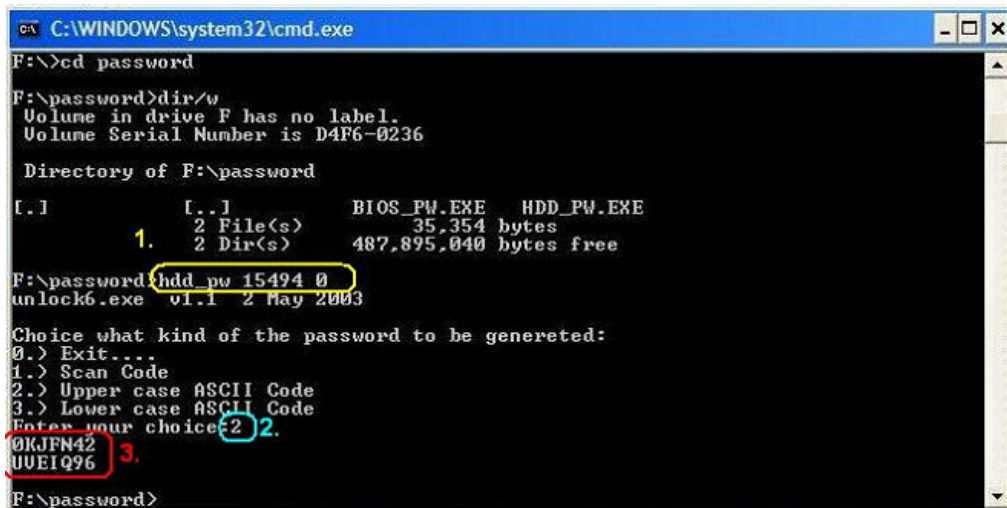

4. Reboot the locked computer and key in one of the passwords from number 3 above.



Removing BIOS Passwords

If you key in the wrong HDD password three times, an error is generated.

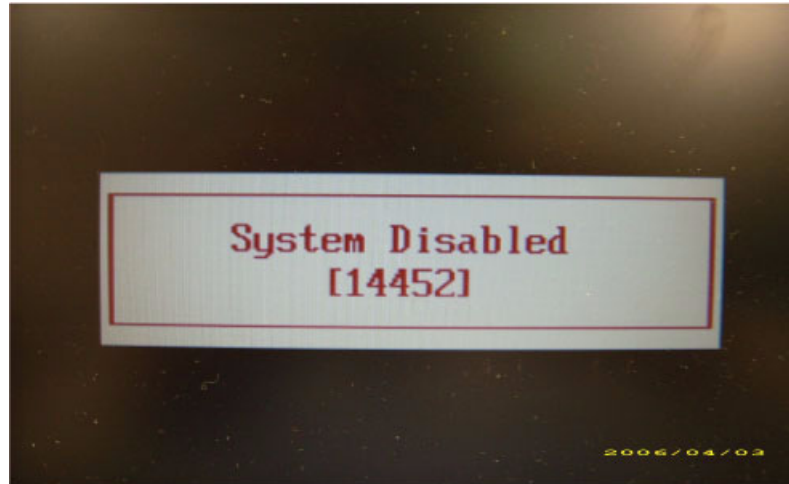

To clean the User or Supervisor passwords, perform the following steps:

To reset the BIOS password, perform the following steps:

1. On another computer, run BIOS_PW.exe.
2. Enter "bios_pw 14452 0"
3. Chose one (1) of the generated passwords.



```
C:\WINDOWS\system32\cmd.exe
Microsoft Windows XP [Version 5.1.2600]
(C) Copyright 1985-2001 Microsoft Corp.

C:\Documents and Settings\M54>d:
D:\>bios_pw 14452 0
unlocRb.exe v1.0 1 July 1997
qjjs7uy
07ygmjd
cjl14tn
6nbzjaj
D:\>
```

4. Reboot the locked computer and key in one of the passwords from number 3 above.

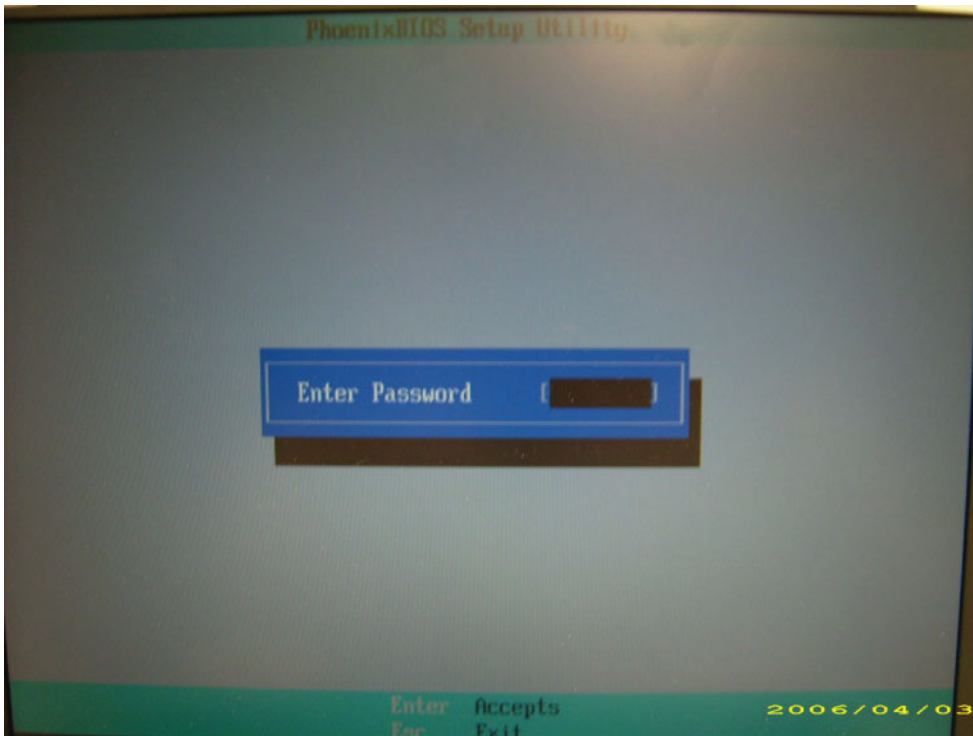

Clearing BIOS Passwords

To clear the User or Supervisor passwords, open the DIMM door and use a metal instrument to short the **G1** jumper.

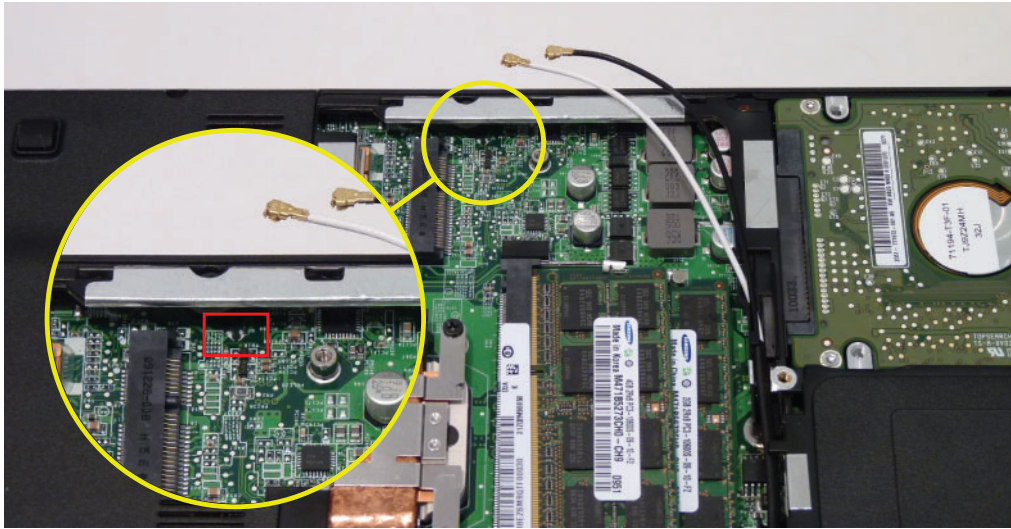

Using Boot Sequence Selector

The Boot Sequence Selector allows the boot order to be changed without accessing the BIOS. To use Boot Sequence Selector, perform the following steps:

1. Enter into DOS.
2. Execute **BS.exe** to display the usage screen.

```
d:\BOOTSEQ>bs

*** Boot Sequence Selector Version 0.03 ***
Create by Rockwell Chuang 10/01/2005.

Usage:
      BS [ 1 | 2 | 3 | 4 ]

BS 1 : [ Floppy ] => [ HardDisk ] => [ CD-ROM ] => [ LAN   ]
BS 2 : [ HardDisk ] => [ CD-ROM ] => [ LAN   ] => [ Floppy ]
BS 3 : [ CD-ROM ] => [ HardDisk ] => [ LAN   ] => [ Floppy ]
BS 4 : [ LAN   ] => [ Floppy ] => [ HardDisk ] => [ CD-ROM ]

d:\BOOTSEQ>
```

3. Select the desired boot sequence by entering the corresponding sequence. For example, enter **BS2** to change the boot sequence to HDD | CD ROM | LAN | Floppy.

Using DMITools

The DMI (Desktop Management Interface) Tool copies BIOS information to EEPROM to be used in the DMI pool for hardware management.

When the BIOS displays "**Verifying DMI pool data**", it is checking that the table correlates with the hardware before sending that information to the operating system (Windows, etc.).

To update the DMI Pool, perform the following steps:

1. Boot into DOS.
2. Execute **qdm30a.exe**. The following screen displays:

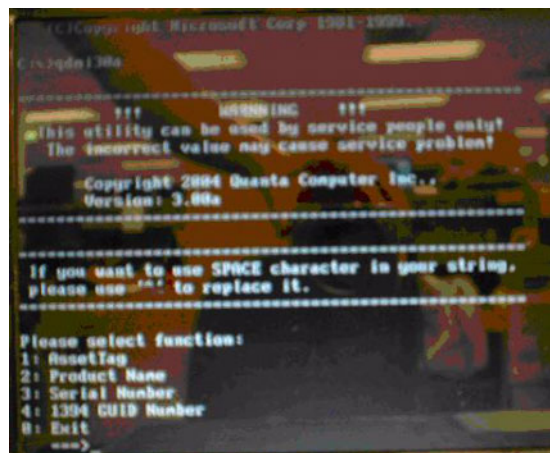

- Type "1" to modify "Asset Tag" values.
- Type "2" to modify "Product Name" values.
- Type "3" to modify "Serial Number" values.
- Type "4" to modify "1394 GUID Number" values.
- Type "0" to Exit the program

3. Run **VEEPROM.exe** to write the values to EEPROM.

Configuring UUID Values

1. Boot into DOS.
2. Run **UUID.bat**

Using the LAN MAC EEPROM Utility

You can use the MAC.BAT utility to write the MAC.CFG file to the EEPROM under DOS mode.

1. Use a text editor (for example: Notepad) to open the MAC.CFG file. You can see the MAC.CFG contents as below:



```
MAC.CFG - 記事本
檔案(F) 編輯(E) 格式(O) 檢視(V) 說明(H)
Title= MAC Address byte
WriteData='001122334455'
StartAddr=7A
WriteLeng=6
KeepByte=0
```

WriteData = '001122334455'	MAC value
StartAddr=7A	MAC address
WriteLeng=6	MAC value length
KeepByte=0	don't care

- WriteData= '001122334455' <----- MAC value
 - StartAddr=7A <----- MAC address
 - WriteLeng=6 <----- MAC value length
 - KeepByte=0 <----- can be any value
2. Boot into DOS.
 3. Execute **MAC.BAT** to write MAC information to eeprom.

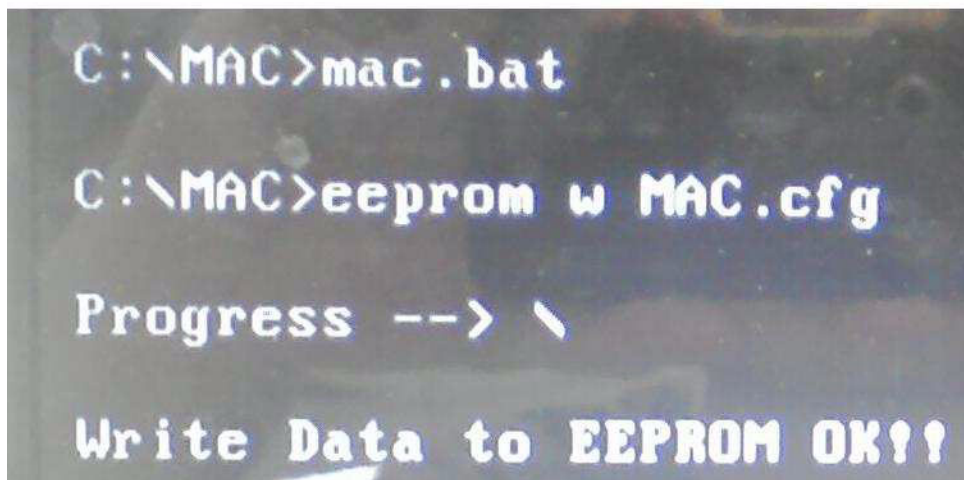

```
C:\MAC>mac.bat
C:\MAC>eeprom w MAC.cfg
Progress --> \
Write Data to EEPROM OK!!
```

Machine Disassembly and Replacement

IMPORTANT: The outside housing and color may vary from the mass produced model.

This chapter contains step-by-step procedures on how to disassemble the notebook computer for maintenance and troubleshooting.

Disassembly Requirements

To disassemble the computer, you need the following tools:

- Wrist grounding strap and conductive mat for preventing electrostatic discharge
- Flat screwdriver
- Philips screwdriver
- Plastic flat screwdriver
- Plastic tweezers

NOTE: The screws for the different components vary in size. During the disassembly process, group the screws with the corresponding components to avoid mismatch when putting back the components.

General Information

Pre-disassembly Instructions

Before proceeding with the disassembly procedure, make sure that you do the following:

1. Turn off the power to the system and all peripherals.
2. Place the system on a flat, stable surface.
3. Unplug the AC adapter and all power and signal cables from the system.



Disassembly Process

The disassembly process is divided into the following stages:

- External module disassembly
- Main unit disassembly

The flowcharts provided in the succeeding disassembly sections illustrate the entire disassembly sequence. Observe the order of the sequence to avoid damage to any of the hardware components. For example, if you want to remove the mainboard, you must first remove the keyboard, then disassemble the inside assembly frame in that order.

Main Screw List

Screw	Quantity	Part Number
M2.5*3	1	86.PSR07.002
M2.0*3	16	86.PSR07.003
M2.0*6	7	86.S6507.001
M2.5*6.5	12	86.ARE07.001
M2.5*4	11	86.PSR07.001

External Module Disassembly Process

IMPORTANT:The outside housing and color may vary from the mass produced model.

External Modules Disassembly Flowchart

The flowchart below gives you a graphic representation on the entire disassembly sequence and instructs you on the components that need to be removed during servicing. For example, if you want to remove the main board, you must first remove the keyboard, then disassemble the inside assembly frame in that order.

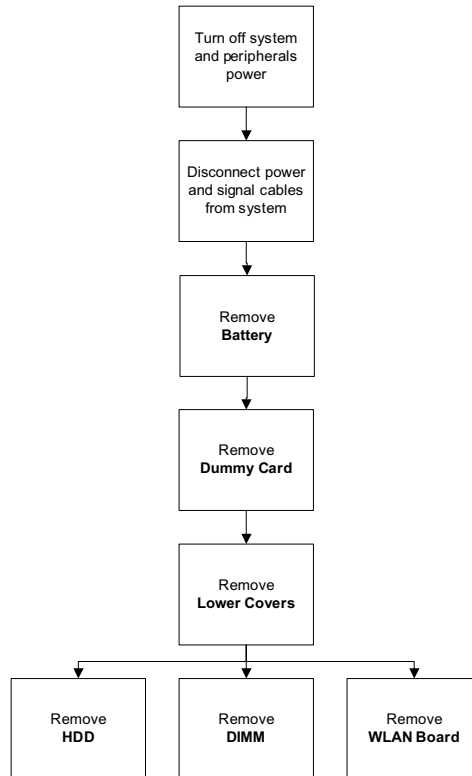

Screw List

Step	Screw	Quantity	Part No.
ODD Module	M2.5*4L	1	86.PSR07.001
ODD Bracket	M2.0*3L	2	86.PSR07.003
WLAN Module	M2.0*3L	1	86.PSR07.003
HDD Carrier	M3.0*4L	2	86.N1407.007

Removing the Battery Pack

1. Turn computer over. Slide the battery lock in the direction shown.

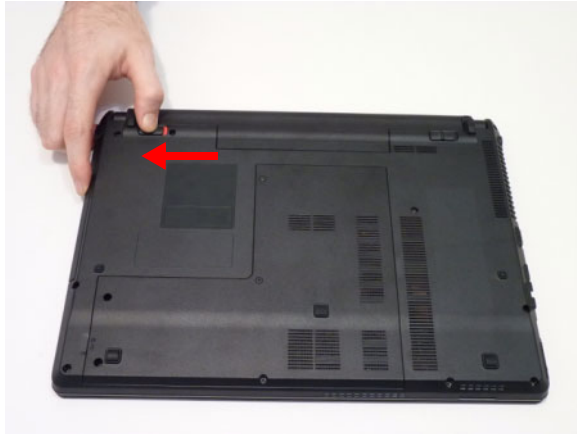

2. Slide and hold the battery release latch to the release position (1), then lift out the battery pack from the main unit (2).

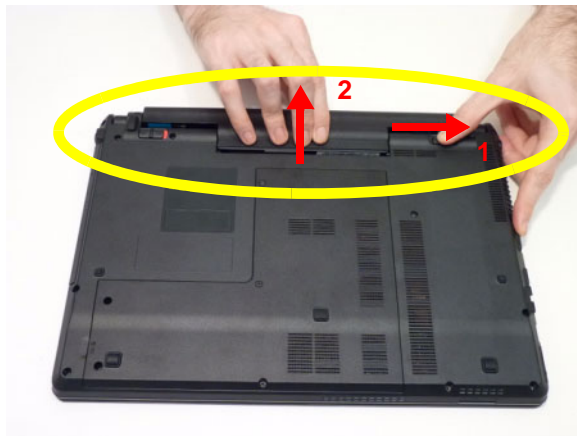

Please detach the battery and follow local regulations for disposal.

Removing the SD dummy card

1. Push the SD dummy card all the way in to eject it.





2. Pull it out from the slot.

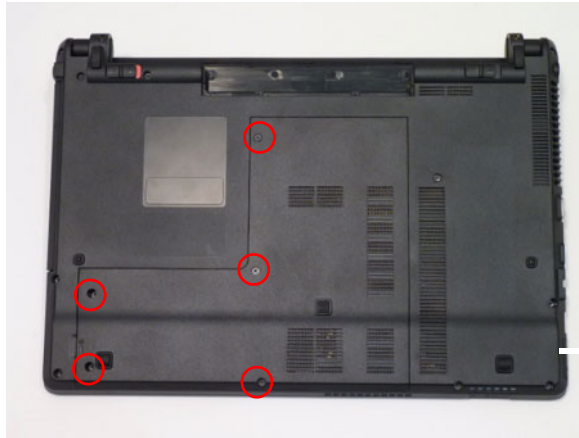

Removing the Lower Cover

1. See "Removing the Battery Pack" on page 48.
2. Remove the six (6) screws from the lower cover.



Step	Size	Quantity	Screw Type
Lower Cover	M2.5*6.5	5	

3. Remove the lower cover as shown.

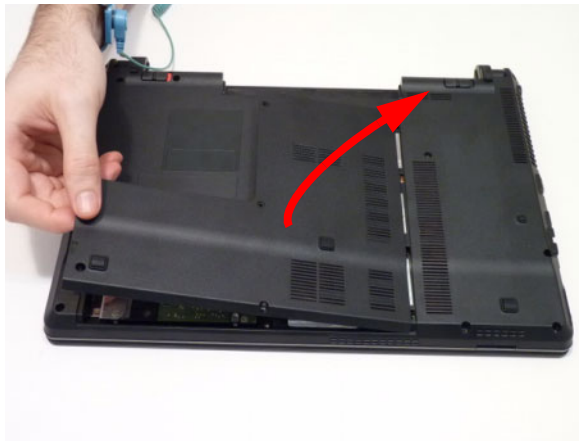

Removing the Optical Drive Module

1. See "Removing the Lower Cover" on page 50.
2. Remove the screw securing the ODD module.

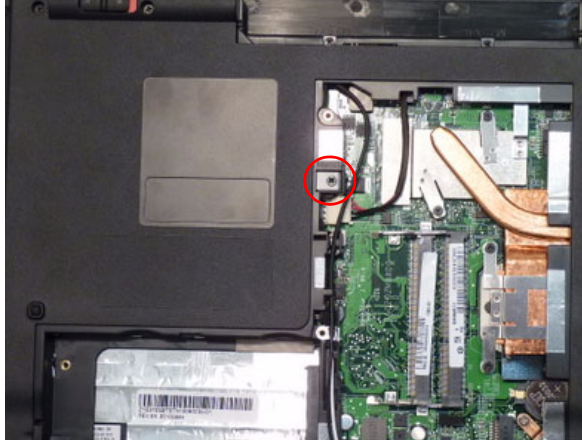

Step	Size	Quantity	Screw Type
ODD Module	M2.5*3	1	

3. Using your fingers, pull the optical drive module out from the chassis.

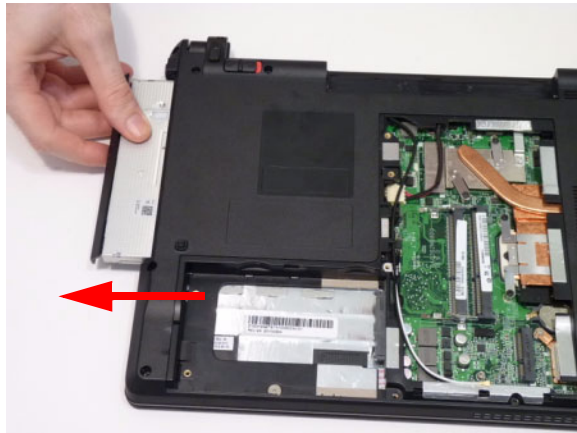

4. Remove the two screws securing the ODD bracket and remove the ODD bracket from the optical disk drive module.



Step	Size	Quantity	Screw Type
ODD Bracket	M2.0*3	2	

5. Remove the ODD bezel by rotating the top edge downward and pulling it clear of the module.



Removing the DIMM Modules

1. See "Removing the Lower Cover" on page 50.
2. Push out the release latches on both sides of the DIMM socket to release the DIMM module.

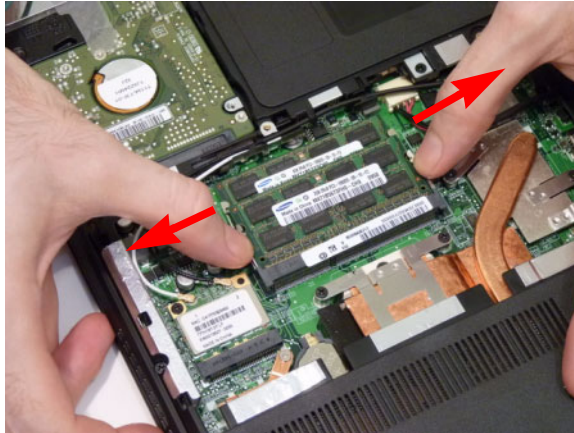

3. Remove the DIMM module.

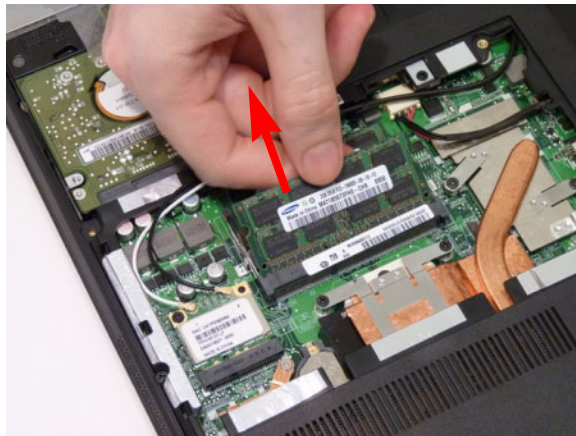

4. Repeat steps for the second DIMM module if present.

Removing the WLAN Module

1. See "Removing the Lower Cover" on page 50.
2. Disconnect the two (2) antenna cables from the WLAN Board



NOTE: Cable placement is **Black** to the TR1 terminal (next to DIMM module) and **White** to the TR2 terminal (closest to the edge of the chassis).

3. Remove the one (1) screw to release the WLAN Board.



Step	Size	Quantity	Screw Type
WLAN Board	M2.0*3	1	

4. Detach and remove the WLAN Board from the WLAN socket.

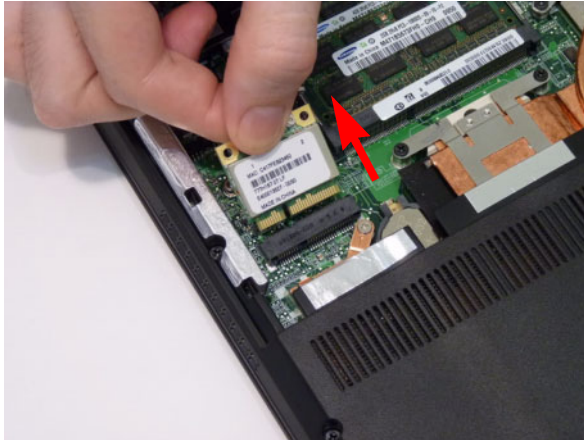

Removing the Hard Disk Drive Module

1. See "Removing the Lower Cover" on page 50.
2. Using the pull-tab, slide the HDD Module in the direction of the arrow to disconnect the interface.

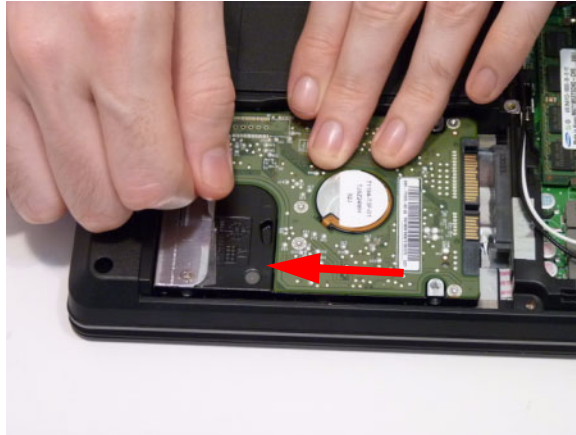

3. Lift the HDD Module clear of the HDD bay.

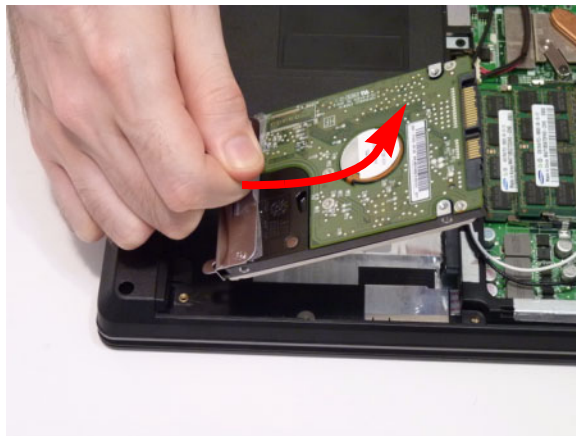

4. Remove the two (2) screws from the carrier.

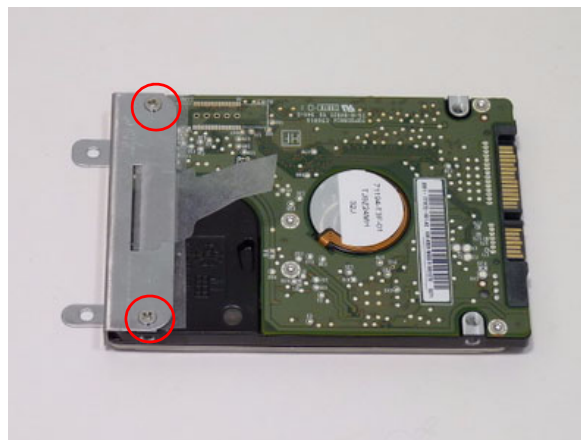

Step	Size	Quantity	Screw Type
HDD Carrier	M3.0*3	2	

5. Remove the carrier from the HDD.

Main Unit Disassembly Process

Main Unit Disassembly Flowchart

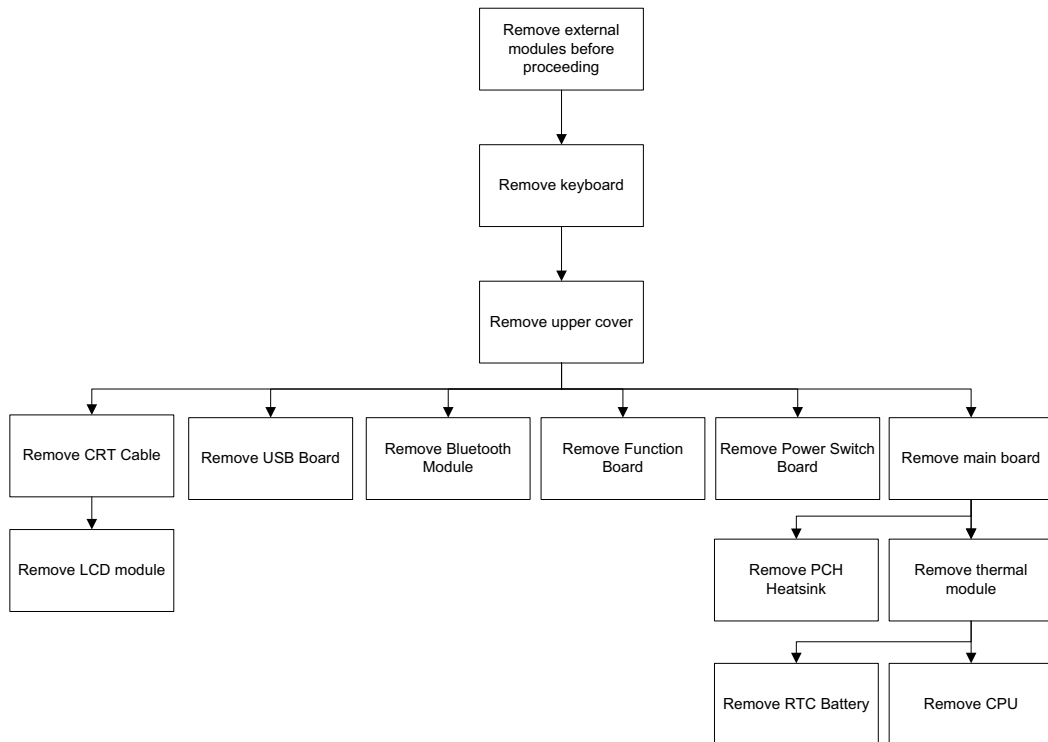

Screw List

Step	Screw	Quantity	Part No.
Lower Cover	M2.5*6.5	11	86.ARE07.001
	M2.5*4	2	86.PSR07.001
	M2.0*6	2	86.S6507.001
	M2.0*3widehead	4	86.ARE07.002
Upper Cover	M2.5*4	5	86.PSR07.001
	M2.0*3widehead	2	86.ARE07.002
Function Board	M2.0*3widehead	2	86.ARE07.002
Power Switch Board	M2.0*3widehead	2	86.ARE07.002
USB Board	M2.5*4	1	86.PSR07.001
Mainboard	M2.5*4	3	86.PSR07.001

Removing the Keyboard

CAUTION: Using metal tools to remove the Keyboard may cause damage to the outer casing. It is recommended that you use only your fingers and plastic tools to remove the Keyboard.

1. See "Removing the Battery Pack" on page 48.
2. Turn the computer over and fully open the lid. There are five (5) securing clips that must be released in order to remove the keyboard.



3. Release each clip, working from one side to the other.

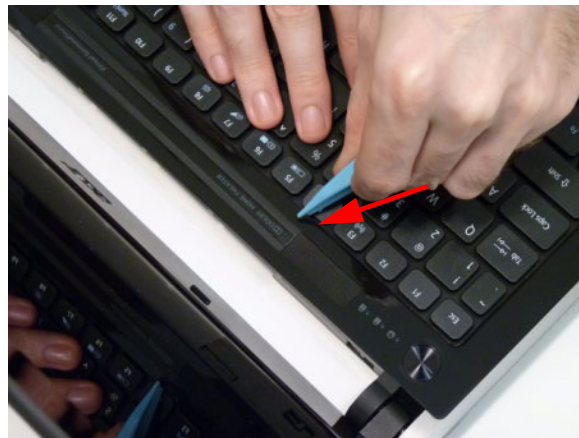

4. Using both hands, gently pry the cover as shown and turn it over.



5. Open the locking latch on the FFC, and disconnect the cable as shown.

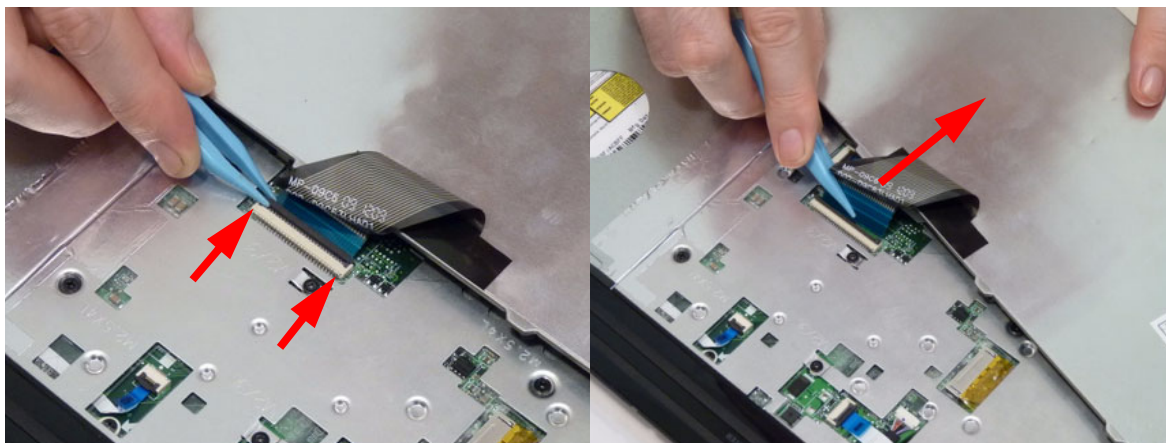

6. Lift the keyboard clear of the chassis.

Removing the Upper Cover

1. See "Removing the Keyboard" on page 58.
2. Turn the computer over. Disconnect the following four cables from the Mainboard:
 - a. Left speaker cable
 - b. Touchpad FFC
 - c. Power Switch FFC
 - d. Function Board FFC

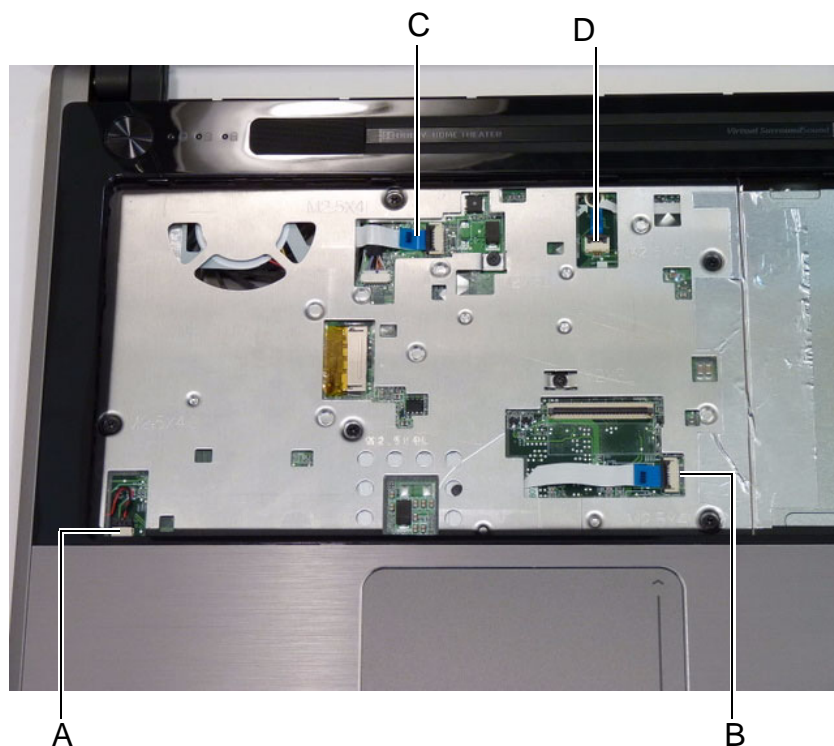

3. Disconnect A as shown.

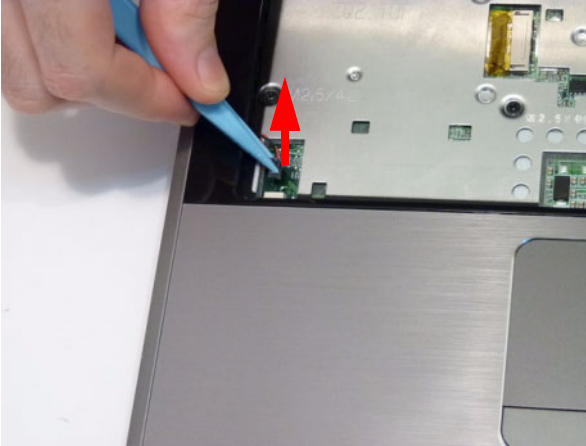

4. Release the locking latch and remove B as shown.

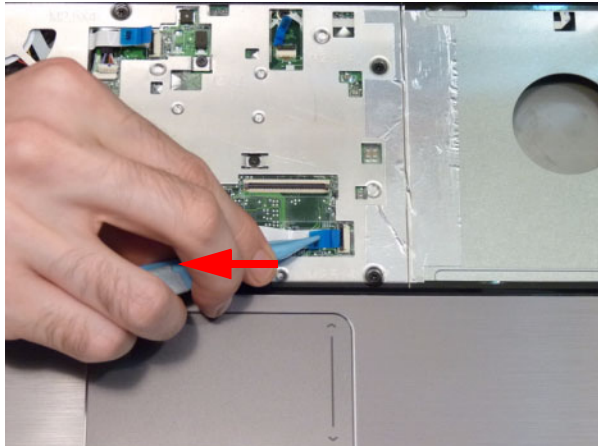

5. Release the locking latch and remove C as shown.

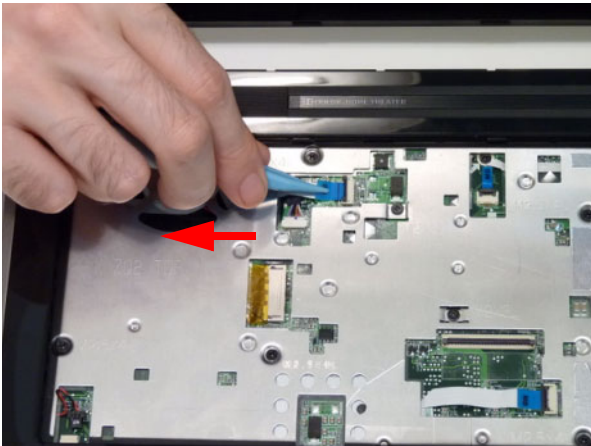





6. Release the locking latch and remove D as shown.

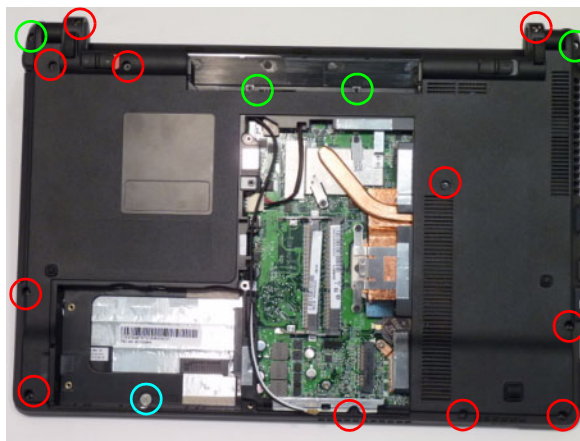

NOTE: Avoid pulling on cables directly to prevent damage to the connectors. Use the pull-tabs on FFC cables whenever available.

7. Remove the sixteen (16) securing screws from the lower cover.





Step	Size	Quantity	Screw Type
Lower Cover (red callout)	M2.5*6.5	11	
Lower Cover (green callout)	M2.5*4L	4	
Lower Cover (blue callout)	M2.0*3widehead	2	

NOTE:

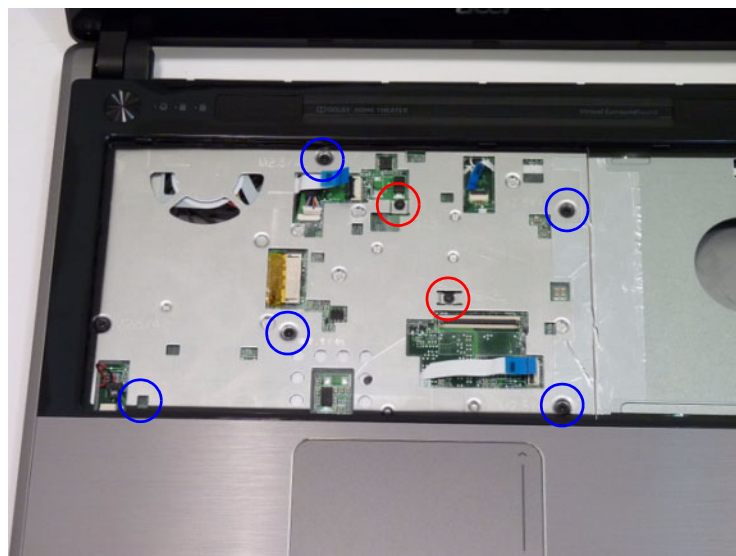
8. Remove the seven (7) screws from the top cover.



Step	Size	Quantity	Screw Type
Upper Cover (red callout)	M2*3L	2	
Upper Cover (blue callout)	M2.5*4L	5	

-
9. Remove the Upper Cover by lifting directly upward from the front as shown.



Removing the Power Switch Board

1. See "Removing the Upper Cover" on page 59.
2. Locate the Power Switch Board in the Upper Cover.

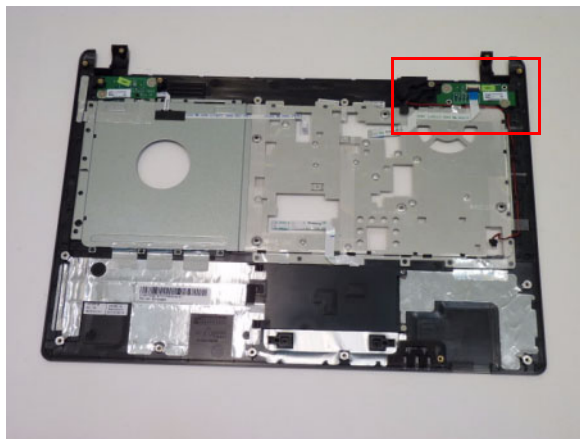

3. Release the securing latch holding the Power Switch Board FFC and remove.

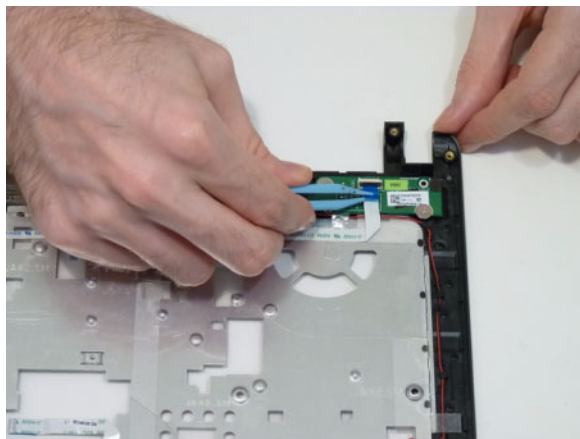

4. Remove the two (2) screws and lift the Power Switch Board clear of the Upper Cover.

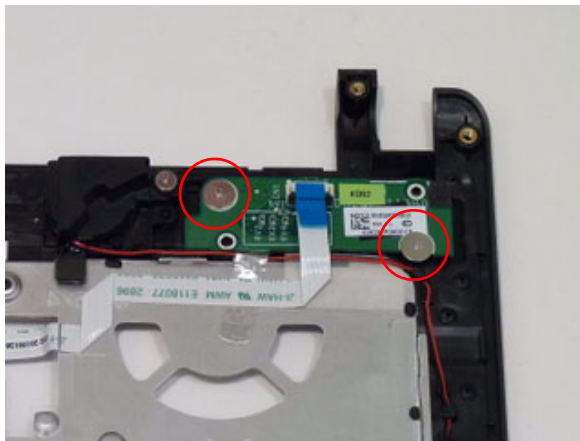

Step	Size	Quantity	Screw Type
Power Switch Board	M2.0*3widehead	2	

Removing the Function Board

1. See "Removing the Upper Cover" on page 59.
2. Locate the Function Board in the Upper Cover.

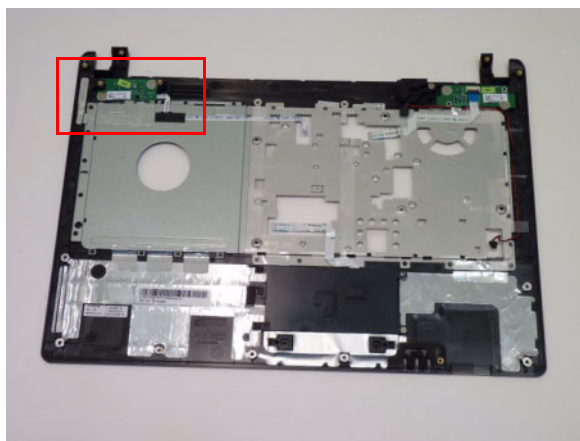

3. Remove the two (2) screws attaching it to the upper cover.



Step	Size	Quantity	Screw Type
Function Board	M2.0*3widehead	2	

4. Lift the Function Board clear of the Upper Cover, but do not remove completely.

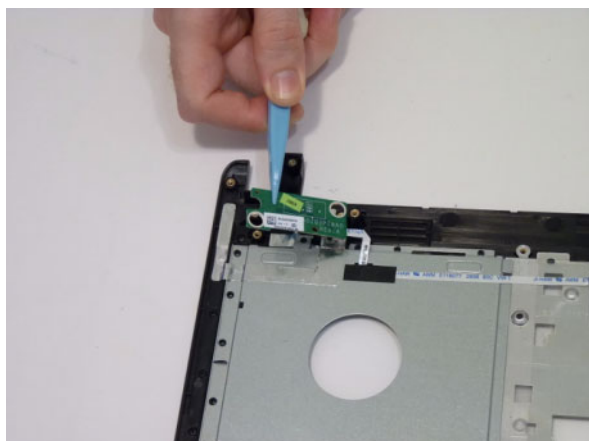

5. Turn the Function Board over. Release the securing latch holding the Function Board FFC and remove.

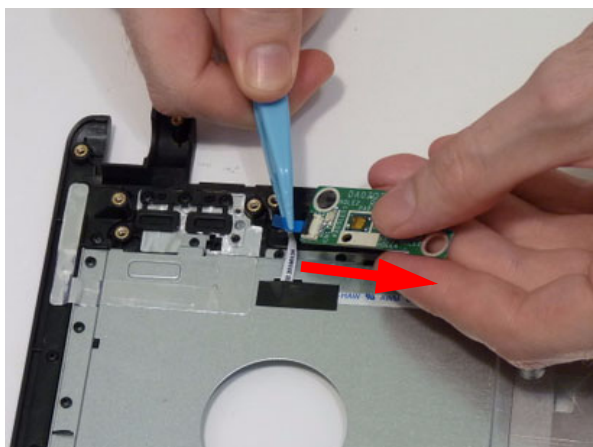

Removing the USB Board

1. See See "Removing the Upper Cover" on page 59.
2. Remove the single securing screw from the USB Board.



Step	Size	Quantity	Screw Type
USB Board	M2.5*4	1	

3. Release the FFC latch and remove the FFC cable from the mainboard connector.

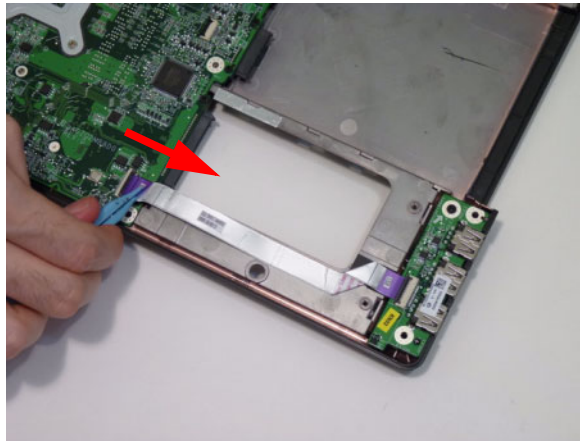

4. Release the FFC latch and remove the FFC cable from the USB connector.

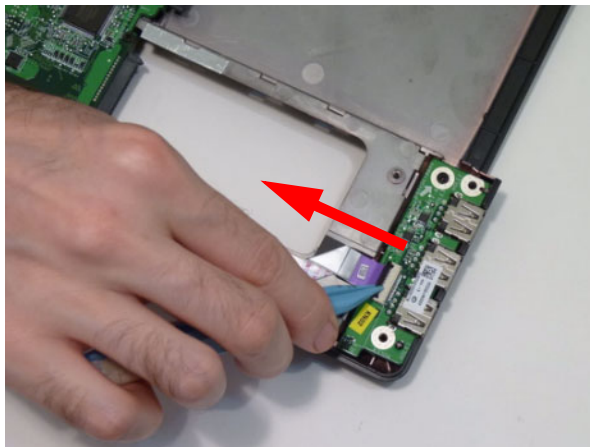

5. Lift the USB Board upward away from the chassis.

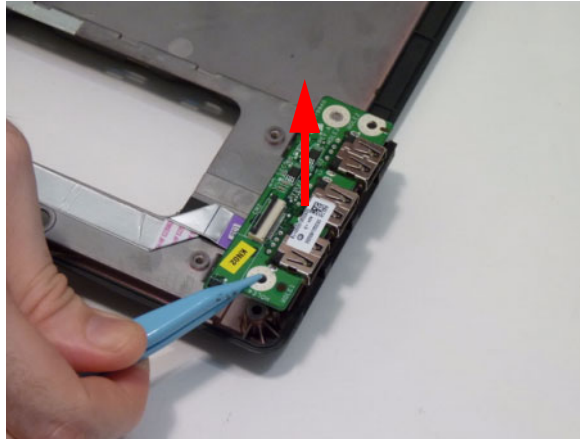

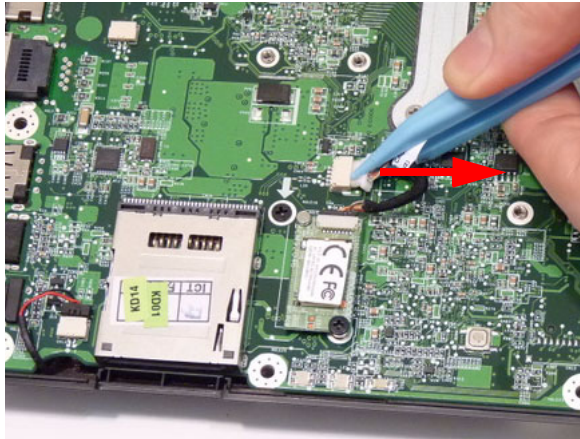

Removing the Bluetooth Module

1. See "Removing the Upper Cover" on page 59.
2. Disconnect the cable from the Mainboard and lift the Bluetooth Module off the mainboard.

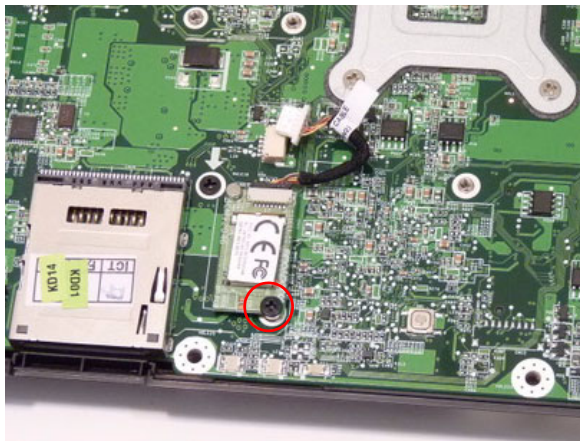

3. Remove the single securing screw from the Bluetooth board.



Step	Size	Quantity	Screw Type
Bluetooth Board	M2.0*3	1	

4. Remove the Bluetooth board from the mainboard and disconnect the cable as shown.

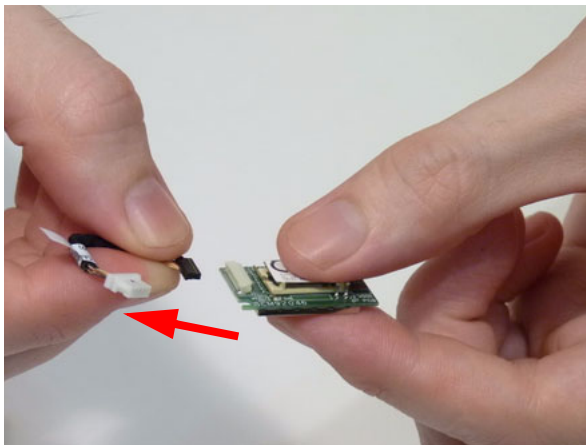

Removing the LCD Module

1. See "Removing the Upper Cover" on page 59.
2. Disengage the WiFi antennas from the guides on the bottom cover.

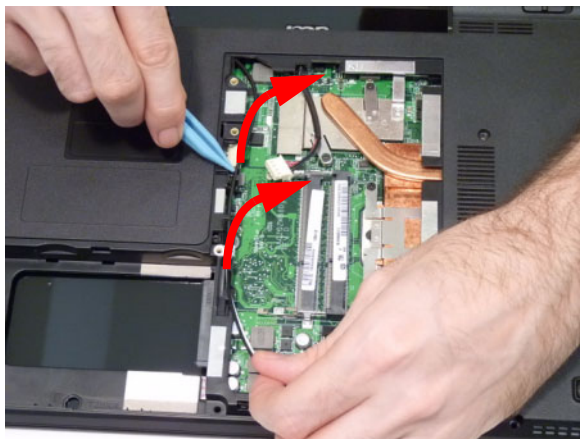

3. Rest the computer on the back of the LCD as shown. Thread the WiFi antennas through the chassis and disengage from the cable guides as shown.

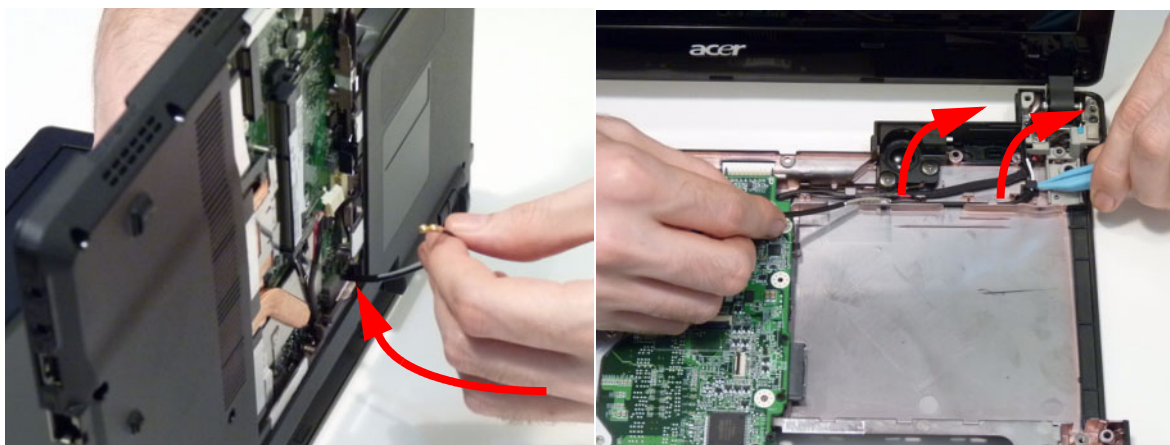

4. Peel back the adhesive holding the LVDS cable.

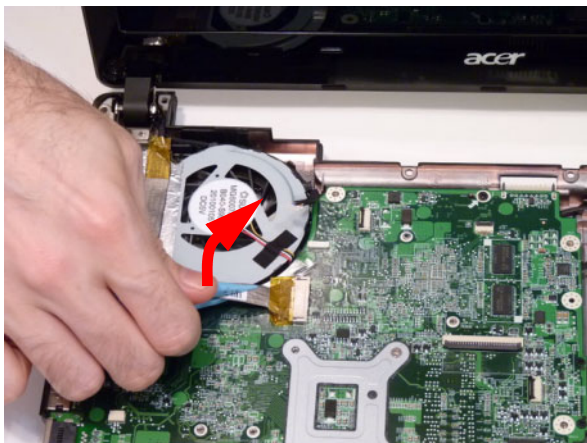

5. Pull up on the LVDS cable to disconnect it from the mainboard.

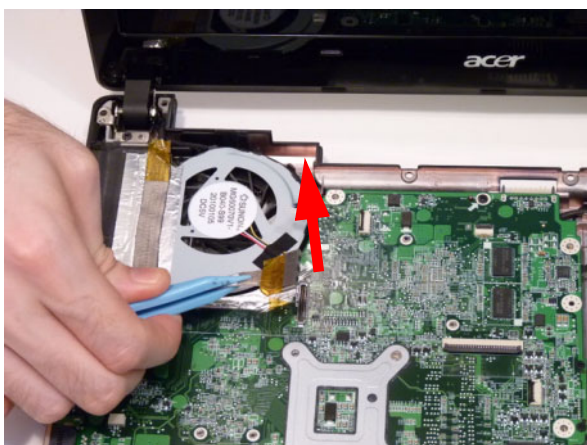

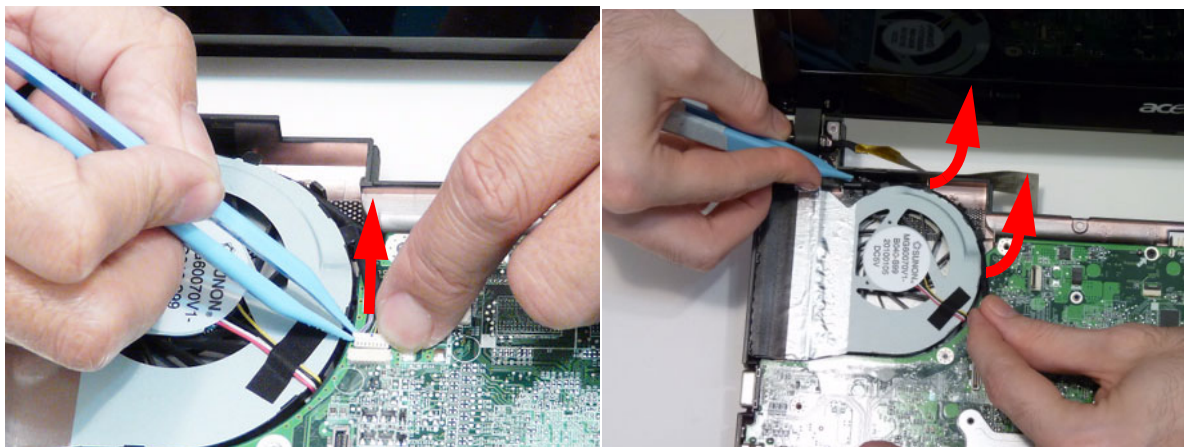

6. Unlock the microphone cable release it from the clasps on the cooling fan.



7. Remove the four securing screws (two each side) from the LCD module.



Step	Size	Quantity	Screw Type
LCD Module (red callouts)	M2.5*6.5	3	
LCD Module (green callout)	M2.5*3	1	

8. Ensure that all cables entering the LCD are free of the chassis and remove the LCD module from the chassis.

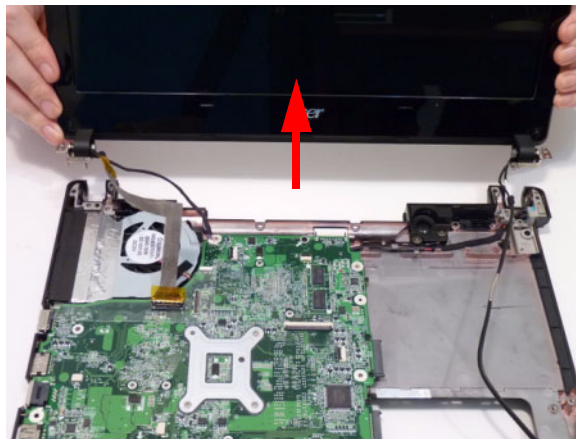

Removing the Mainboard

1. See "Removing the Bluetooth Module" on page 66.
2. See "Removing the LCD Module" on page 67.
3. Disconnect the right speaker cable.

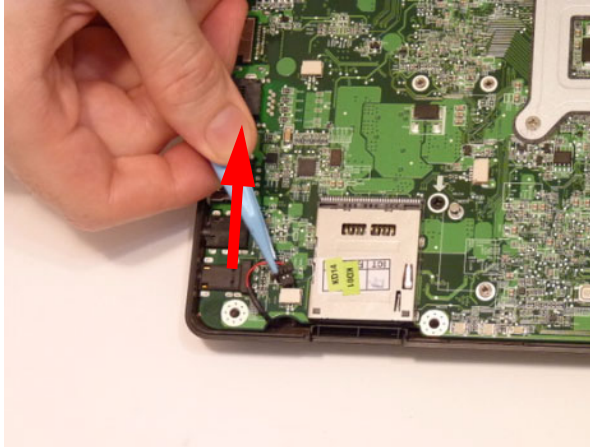

4. Turn the computer over and remove the DC-In cable.

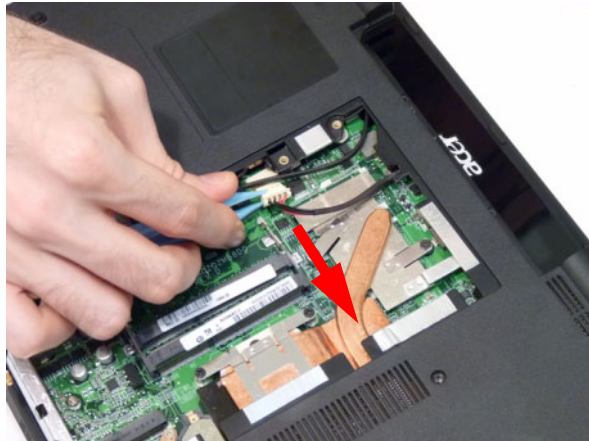

5. Remove the three (3) securing screws from the Mainboard.

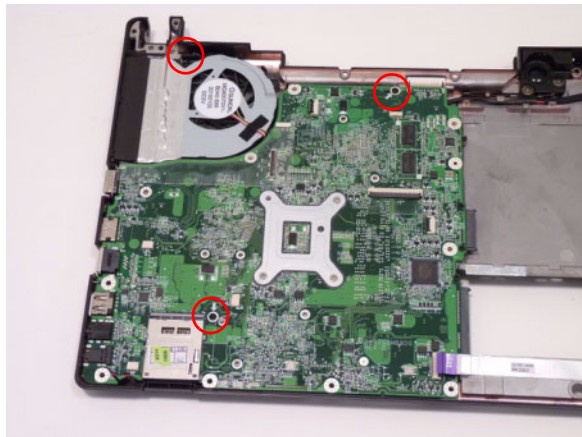

Step	Size	Quantity	Screw Type
Mainboard	M2.5*4	3	

6. Lift the Mainboard right side first and remove it from the Lower Cover.



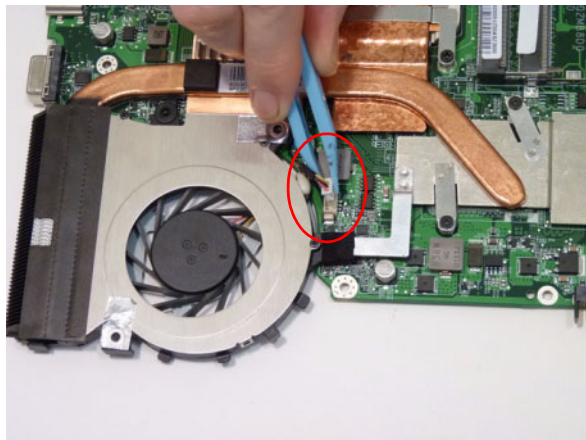

Removing the Thermal Module

1. See "Removing the Mainboard" on page 70.
2. Turn the Mainboard over and disconnect the Fan cable as shown.

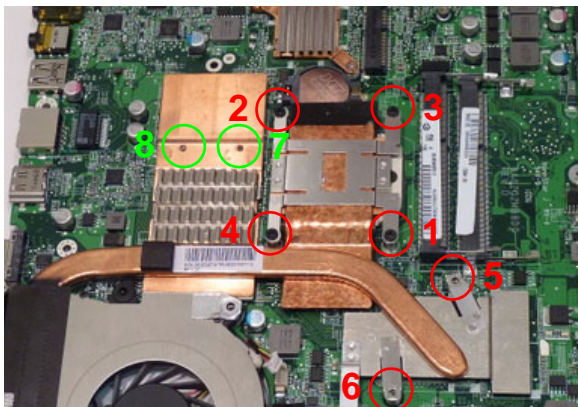

3. Loosen the six (6) captive screws (in numerical order from 1 to 6) and remove the two (2) screws (green callouts - numbers 7 & 8) from the CPU Thermal Module.



Step	Size	Quantity	Screw Type
Thermal Module	M2.0*3	2	

4. Using both hands, lift the Thermal Module clear of the Mainboard.

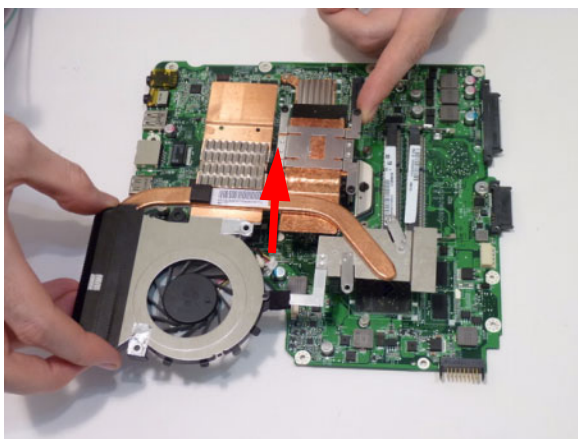

Removing the PCH Thermal Module

1. See "Removing the Mainboard" on page 70.
2. remove the two (2) screws from the PCH Thermal Module.

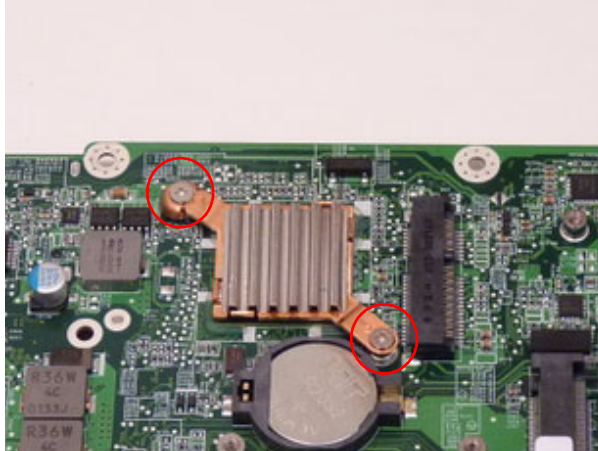

3. Lift the PCH Thermal Module clear of the Mainboard.

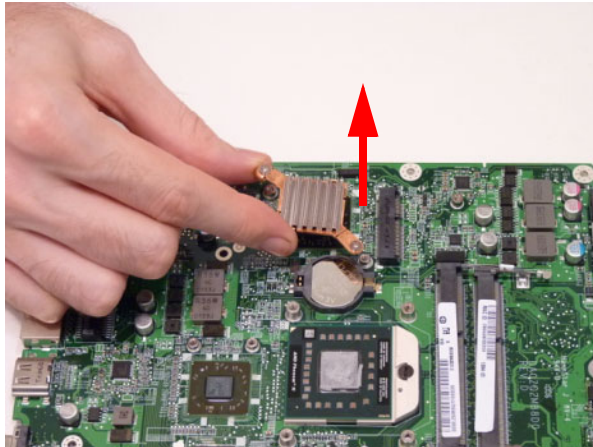

Removing the CPU

1. See "Removing the Thermal Module" on page 71.
2. Using a phillips screw driver, rotate the CPU locking screw 180° counter-clockwise as shown.

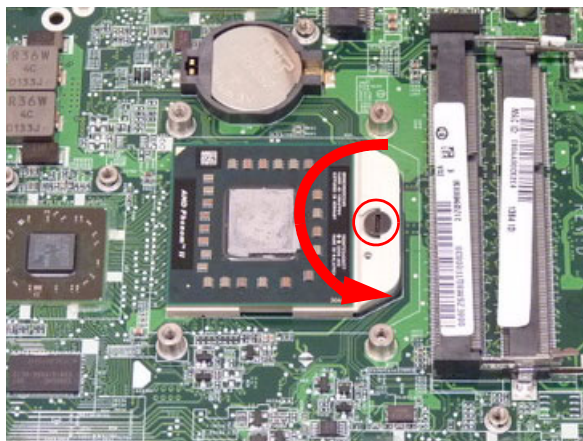

3. Lift the CPU clear of the socket as shown.

IMPORTANT:The pins on the underside of the CPU are very delicate. If they are damaged, the CPU may malfunction. Place the CPU on a clean, dry surface when it is not installed.

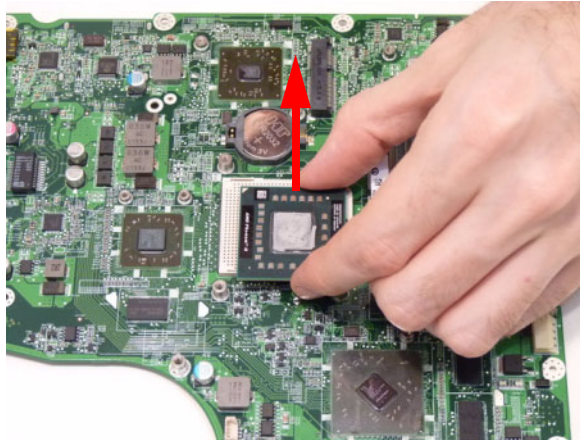

Removing the RTC Battery

1. See "Removing the Mainboard" on page 70.
2. Pry the RTC battery from the mainboard.

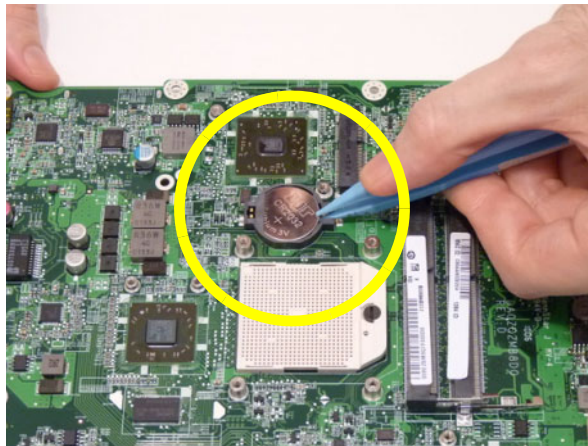

Please detach the RTC battery and follow local regulations for disposal.



Please detach the mainboard and follow local regulations for disposal.

LCD Module Disassembly Process

LCD Module Disassembly Flowchart

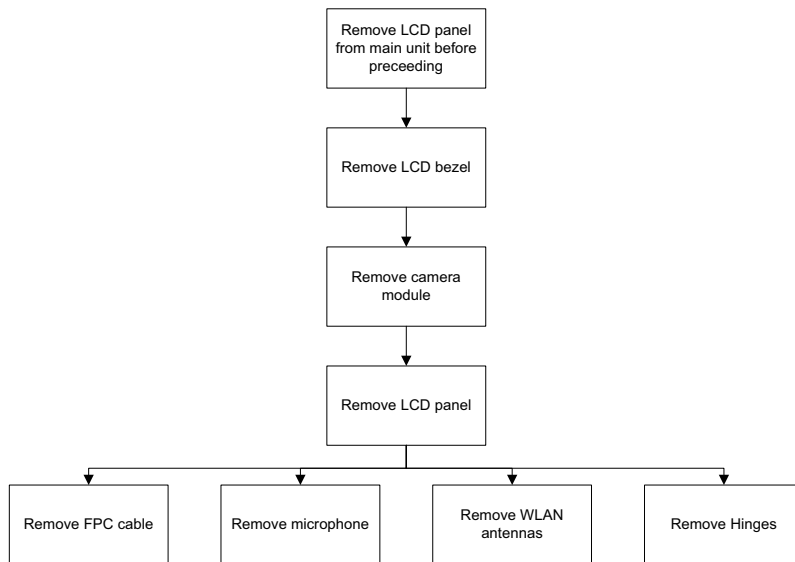

Screw List

Step	Screw	Quantity	Part No.
LCD Bezel	M2.5*4	2	86.PSR07.001
LCD Panel	M2.0*3	4	86.ARE07.002
Hinges	M2.5*3	4	86.TPK07.003

Removing the LCD Bezel

1. See "Removing the LCD Module" on page 67.
2. Remove the two (2) bezel screws.



Step	Size	Quantity	Screw Type
LCD Bezel	M2.5*4	2	

3. Starting from the top-center of the bezel, pry the bezel upwards and away from the panel. Move along the top and sides until the bezel is completely detached.



-
4. Grasp the hinges and lift the Bezel clear of the LCD Module in the direction shown.

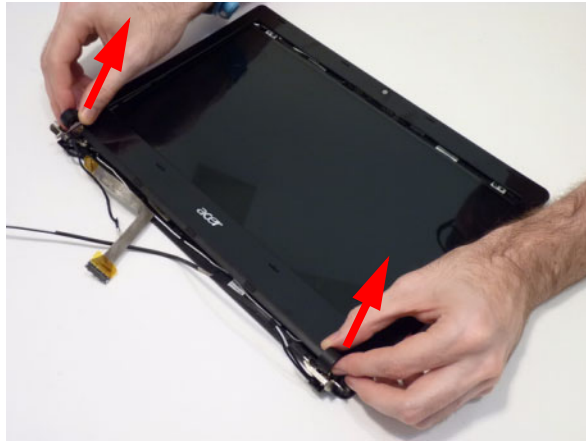

Removing the Camera Module

1. See "Removing the LCD Bezel" on page 76.
2. Disconnect the camera cable.

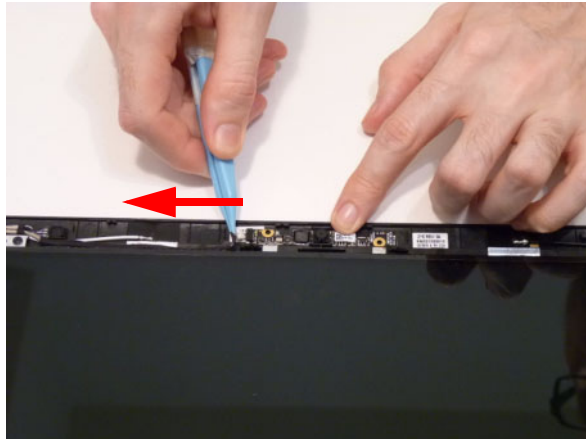

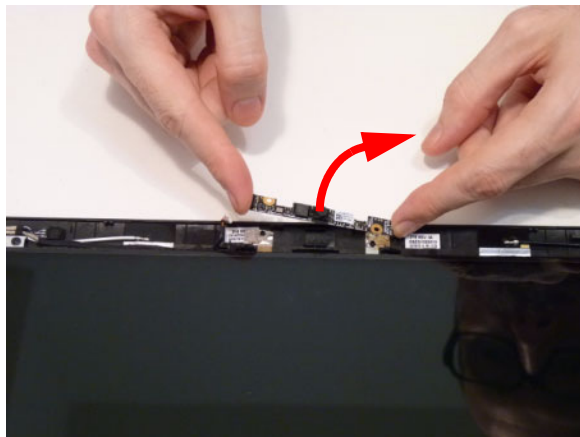

3. Remove the Camera from the module.

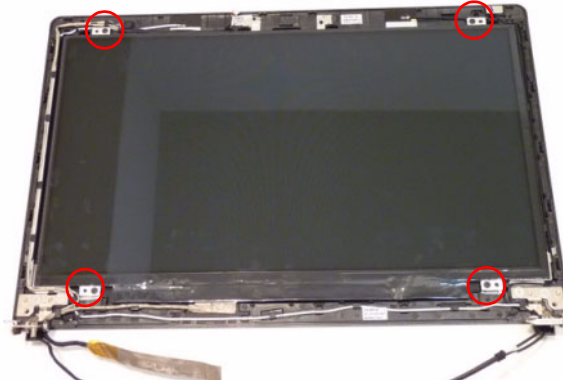

Removing the LCD Panel

1. See "Removing the Camera Module" on page 77.
2. Disengage the various cables from the hinges.
3. Remove the four (4) securing screws from the LCD Panel.



Step	Size	Quantity	Screw Type
LCD Panel	M2.0*3	4	

4. Disengage the LVDS cable from the left hinge and the cable guides.

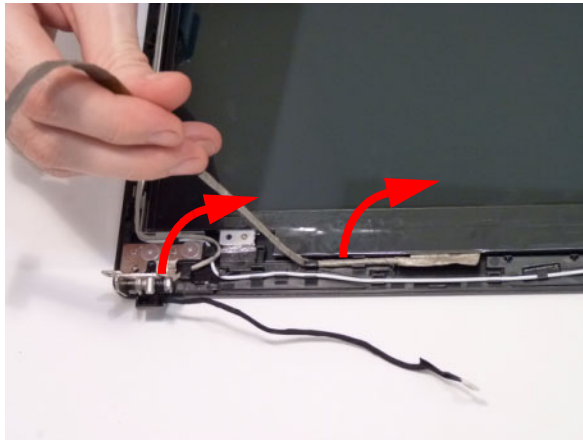

5. Lift the LCD Panel clear of the module as shown.

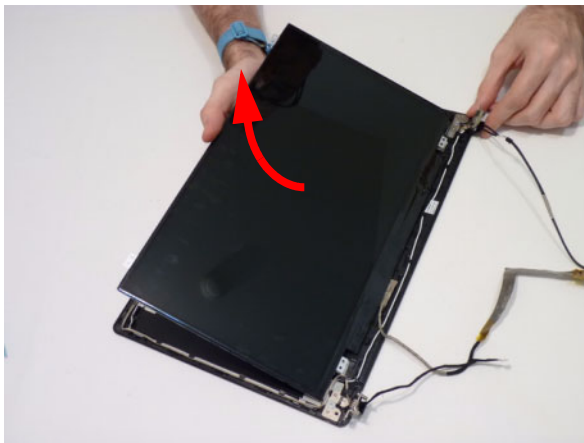

Removing the FPC Cable

1. See "Removing the LCD Panel" on page 78.
2. Turn the LCD panel over to expose the rear. Disengage the adhesive strip securing it in place.

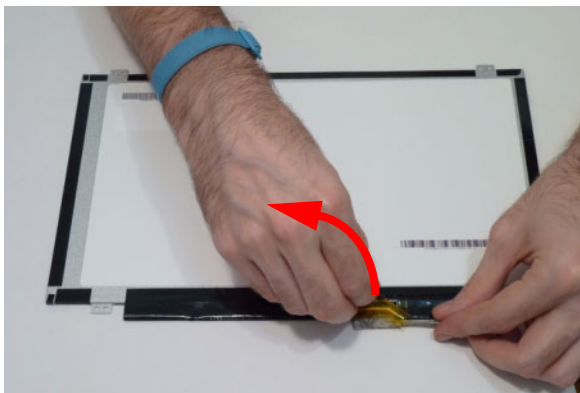

3. Lift the adhesive protector and disconnect the cable from the LCD Panel.

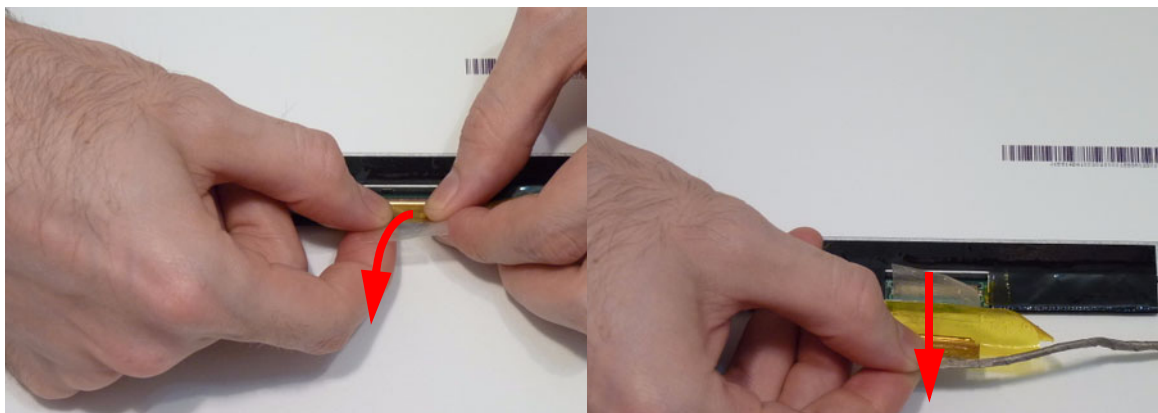

4. Remove the FPC cable from the panel.

Removing the Microphone Module

1. See "Removing the LCD Panel" on page 78.
2. Remove the adhesive tape covering the microphone cable.

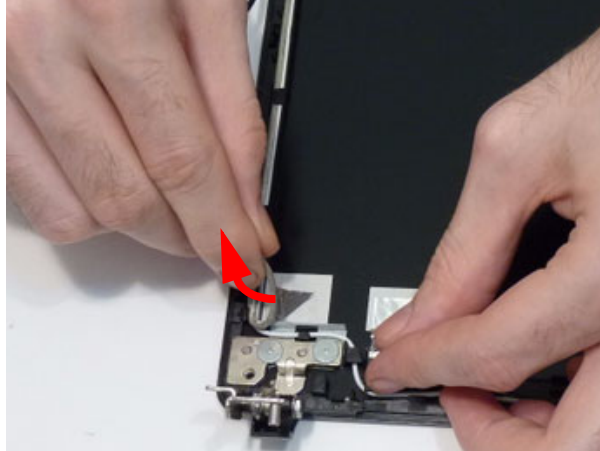

3. Disengage the cable from the cable guides.

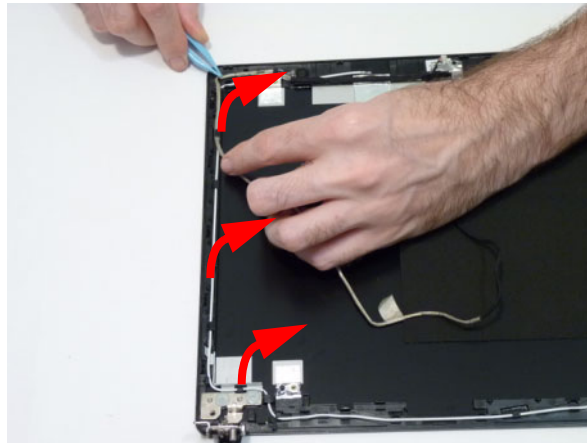

4. Lift the Microphone Module clear of the cover.

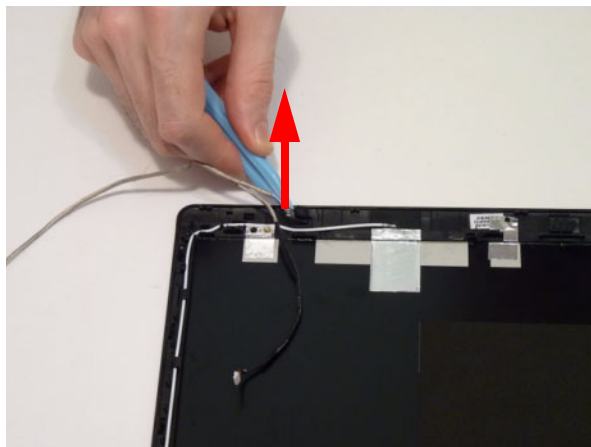

Removing the Antennas

1. See "Removing the LCD Panel" on page 78.
2. Disengage the left antenna cable from the guides.

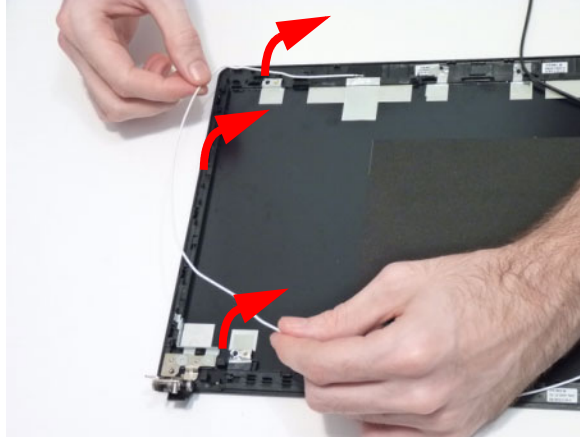

3. Disengage the right antenna cable from the guides.

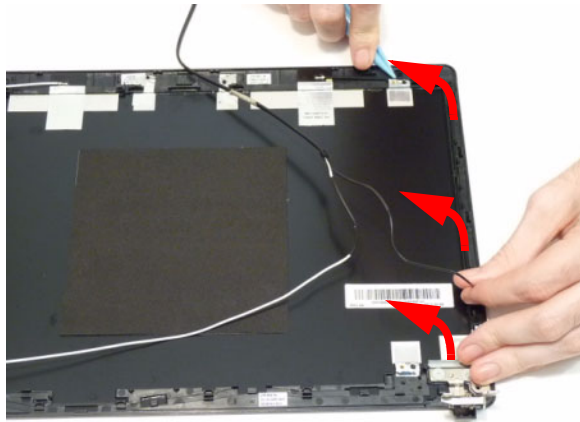

4. Remove the adhesive tape and lift the left side antenna from the LCD module as shown.

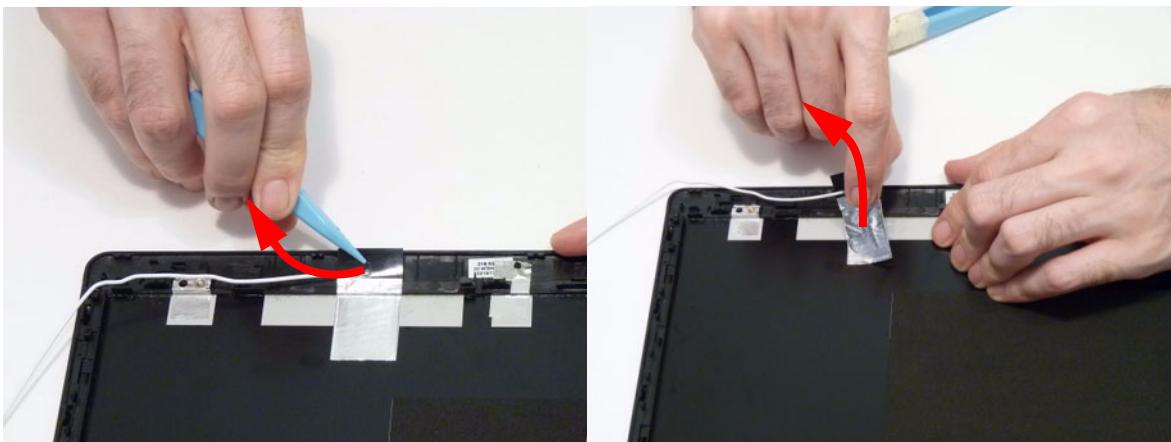

5. Remove the adhesive tape and lift the right side antenna from the LCD module as shown.

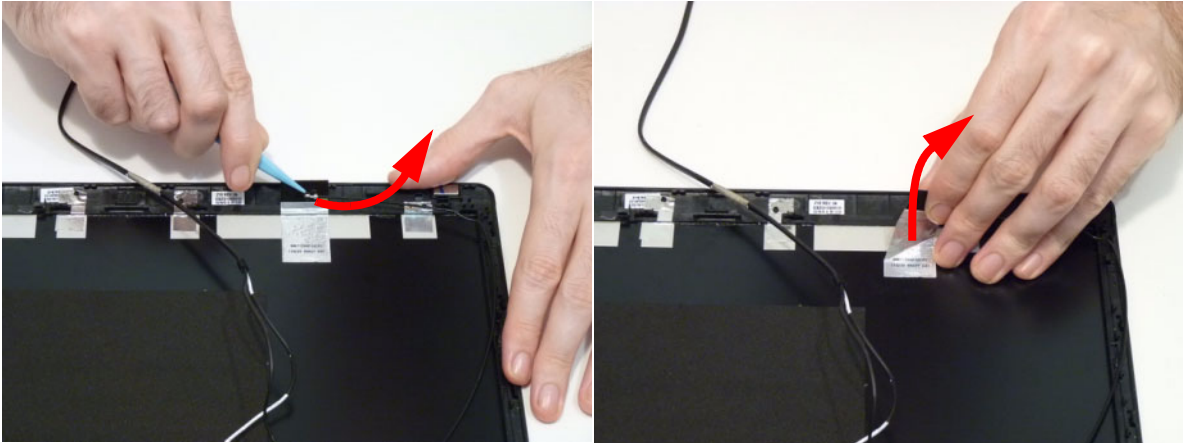

Removing the Hinges

1. See "Removing the LCD Panel" on page 78.
2. Remove the four (4) screws from the hinges



Step	Size	Quantity	Screw Type
LCD Hinges	M2.5*3	4	

3. Remove the hinges from the LCD cover.

LCD Module Reassembly Procedure

Replacing the MIC and WiFi Antennas

1. Replace the left and right antennas as shown. Press down on the adhesive pads to secure the antennas in place.



2. Replace the left antenna cable (white) as shown. Ensure that the cables are secured in the cable guides.

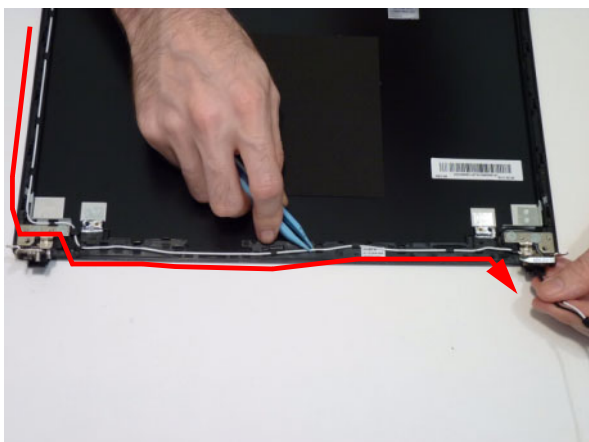

3. Replace the right antenna cables (black) as shown. Ensure that the cables are secured in the cable guides.

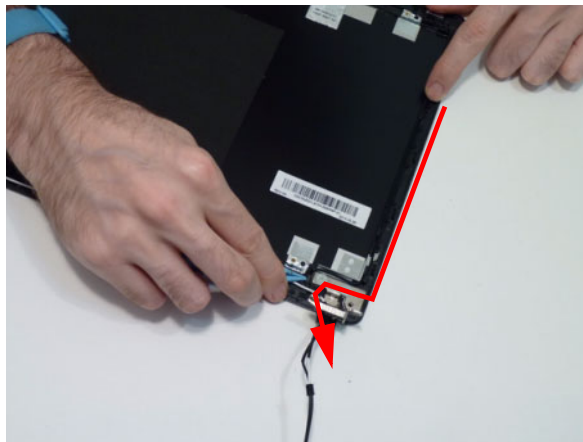

4. Replace the Microphone Module into the top cover.
5. Replace the cable into the cable guides as shown.

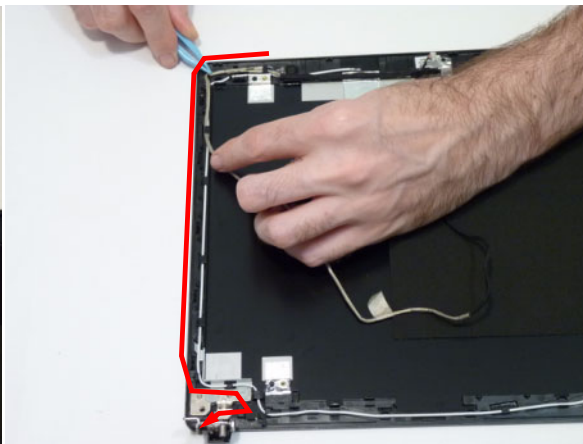
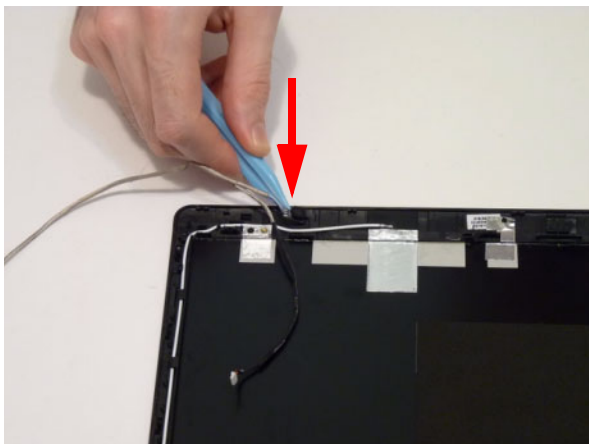

6. Replace the adhesive tape onto the microphone cable.

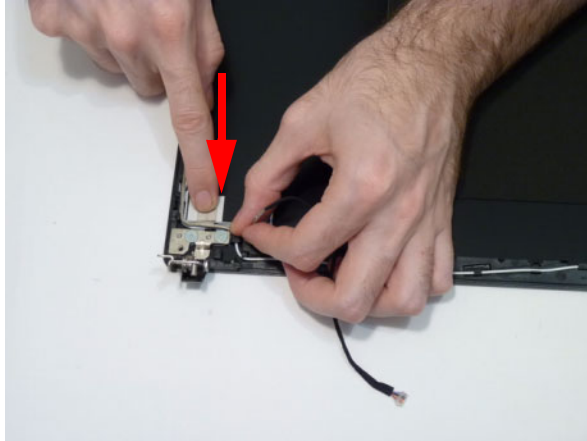

7. Ensure the antenna cables pass through the hinge well as shown.

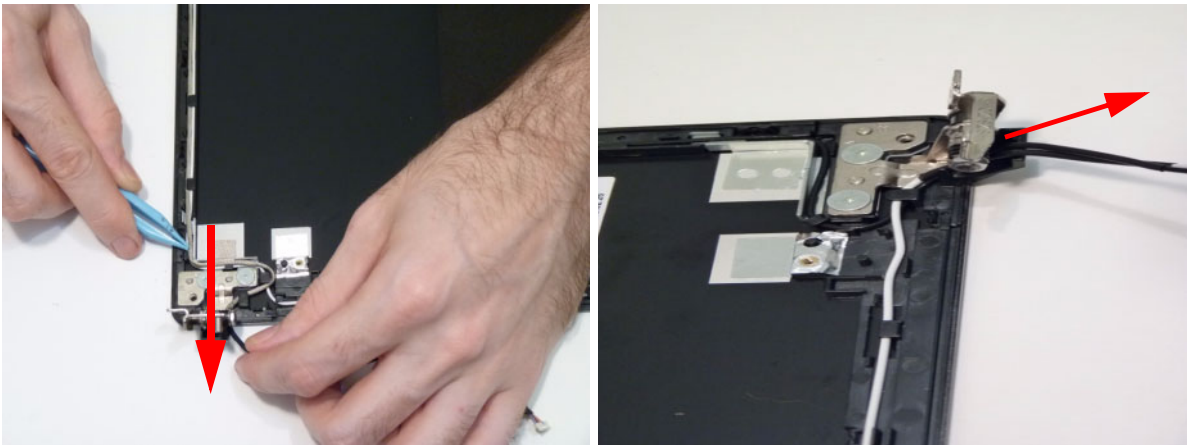

Replacing the FPC Cable

1. Attach the FPC cable to the LCD panel and attach the adhesive protector.

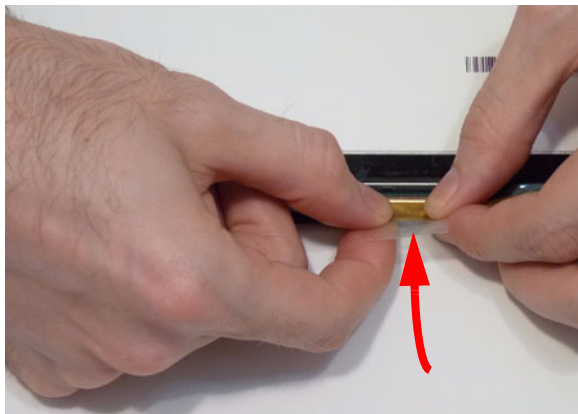

-
2. Press down on the adhesive tape to secure the FPC cable in place.

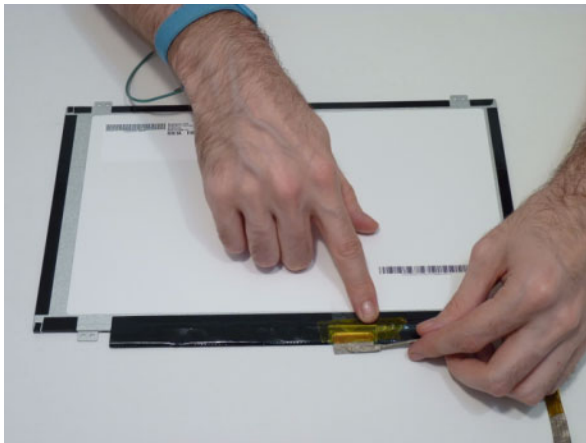

Replacing the LCD Panel

3. Place the LCD Panel into the module as shown.

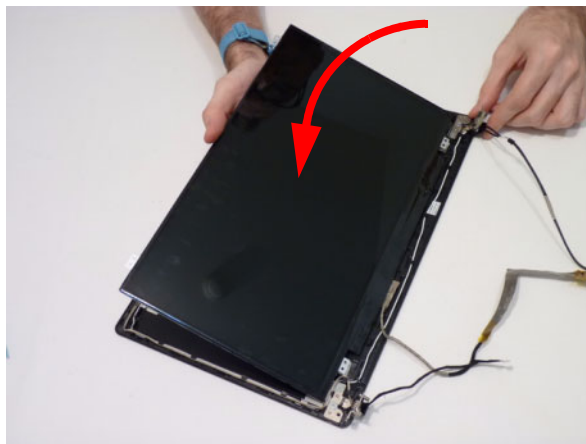

4. Replace the four (4) securing screws to secure the LCD Panel.



Replacing the Webcam

1. Place the camera in the LCD Module.

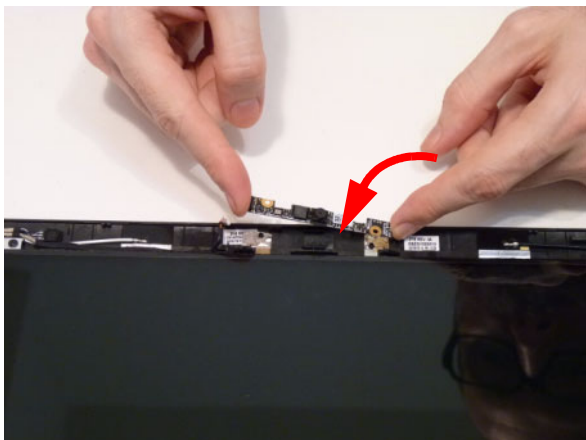

2. Connect the cable to the camera module.

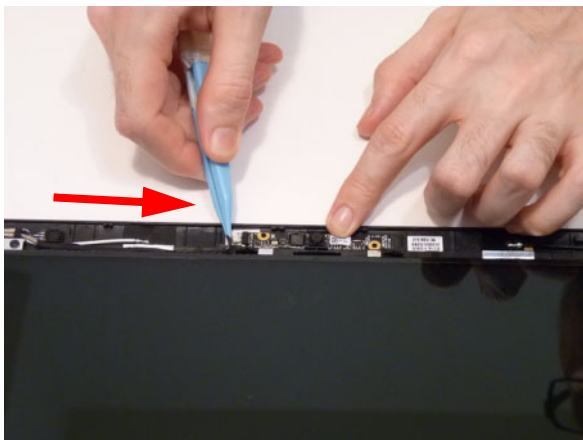

Replacing the LCD Bezel

1. Reattach the hinges first, then press down until there are no gaps between the bezel and the LCD Module.

IMPORTANT: Ensure that the LCD cables pass through the hinge wells and are not trapped by the bezel.

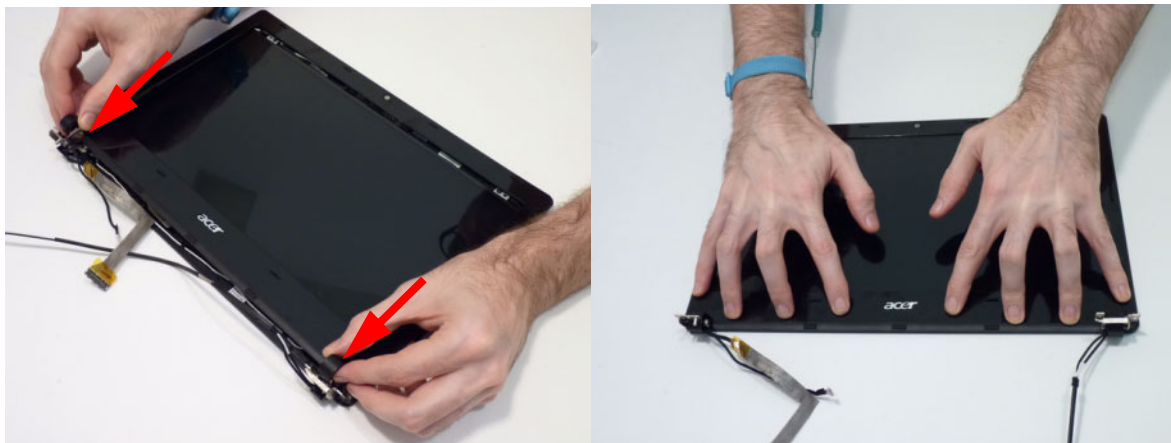

2. Press down around the entire perimeter of the bezel until there are no gaps between the bezel and the LCD Module.

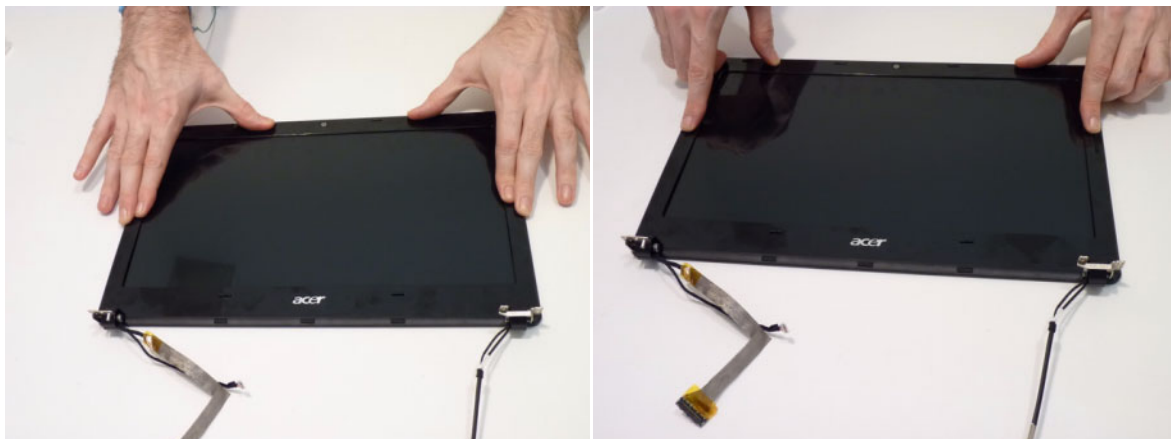

3. Replace the two screws.



Main Module Reassembly Procedure

Replacing the RTC Battery

1. Snap the RTC battery into its socket as shown, plus side (+) up.

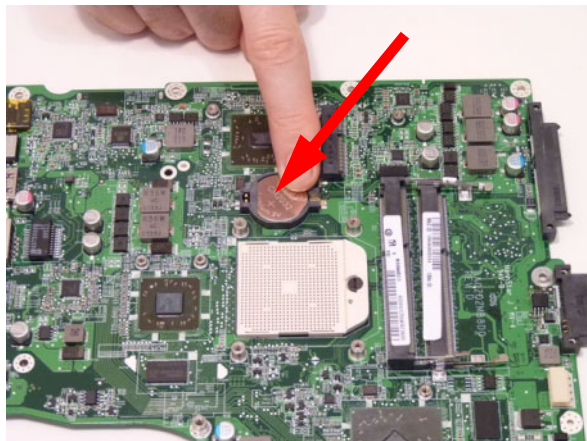

Replacing the CPU

IMPORTANT:The CPU has a Pin1 locator that must be positioned corresponding to the marker on the CPU socket.

1. Place the CPU into the CPU socket as shown, taking note of the Pin1 locator.

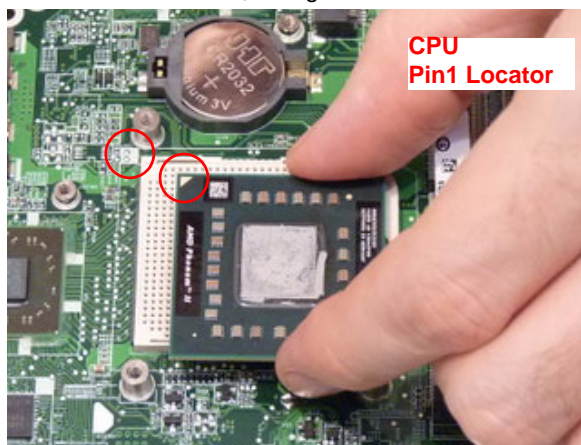

2. Using a flat-bladed screw driver, rotate the CPU locking screw 180° clockwise to secure the CPU in place.

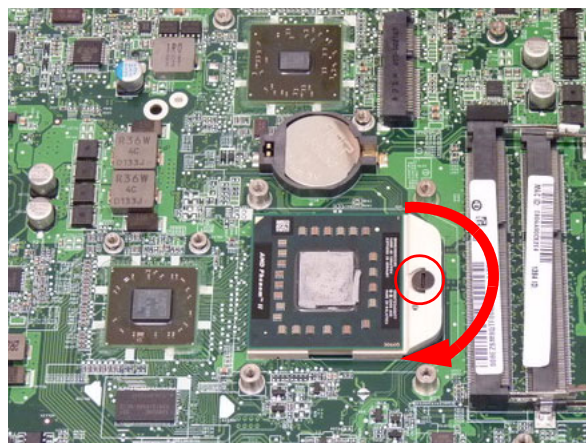

Replacing the Thermal Module

IMPORTANT: Apply a suitable thermal grease and ensure all heat pads are in place before replacing the Thermal Module.

The following thermal grease types are approved for use:

- Silmore GP50
- Honeywell PCM45F-SP
- ShinEtsu 7762

The following thermal pads are approved for use:

- Eapus XR-PE
1. Remove all traces of thermal grease from the CPU using a lint-free cloth or cotton swab and Isopropyl Alcohol, Acetone, or other approved cleaning agent.
 2. Apply a small amount of thermal grease to the centre of the CPU—there is no need to spread the grease manually, the force used during the installation of the Thermal Module is sufficient.
 3. Align the screw holes on the Thermal Module and Mainboard then replace the module. Keep the module as level as possible to spread the thermal grease evenly.
 4. Replace the eight (8) securing screws (in numerical order from screw 1 to screw 8) to secure the Thermal Module in place.

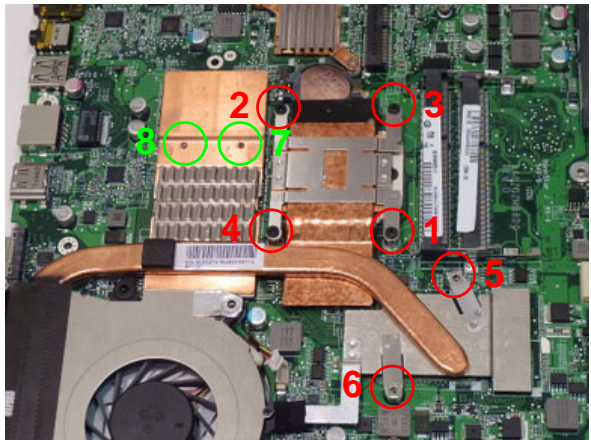
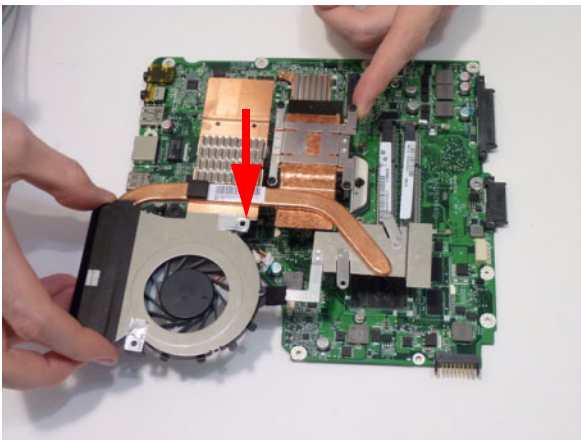

5. Connect the fan cable to the Mainboard.

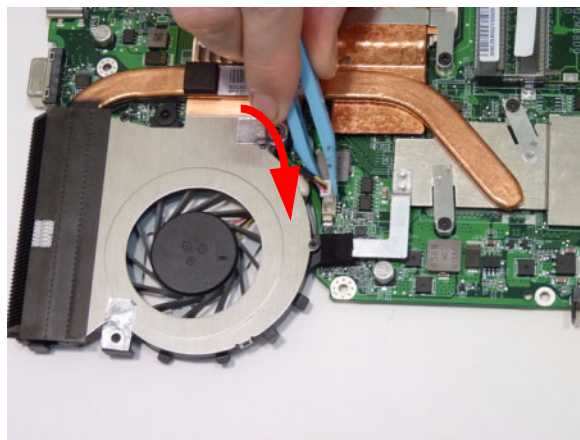

Replacing the PCH Thermal Module

1. Replace the PCH Thermal Module onto the Mainboard.

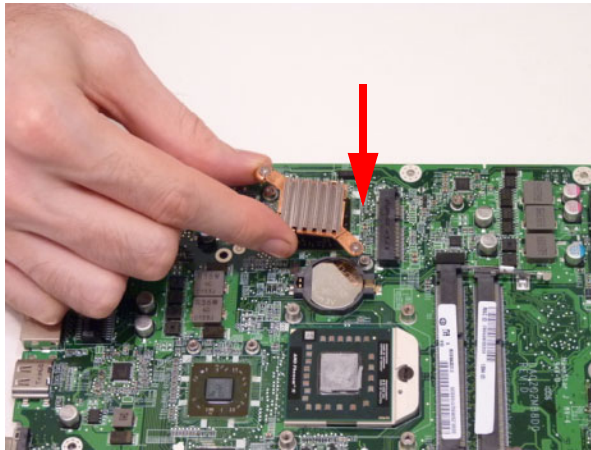

2. Replace the two (2) screws to secure the PCH Thermal Module.

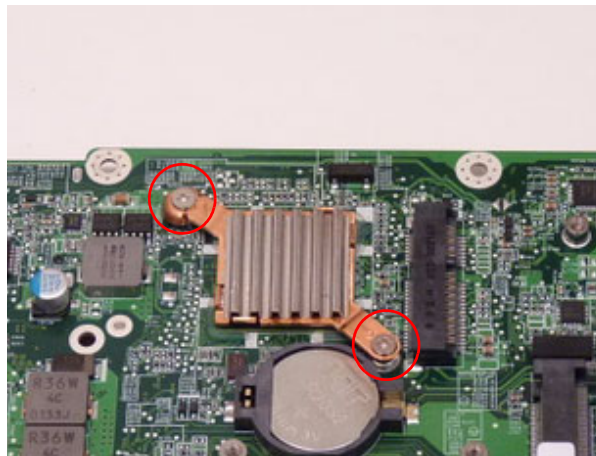

3. Replacing the Mainboard

Disengage the WiFi antennas from the guides on the bottom

1. Place the Mainboard in the chassis, left edge first (1), then rotate it downward into position (2).
2. Replace the three (3) securing screws in the mainboard.

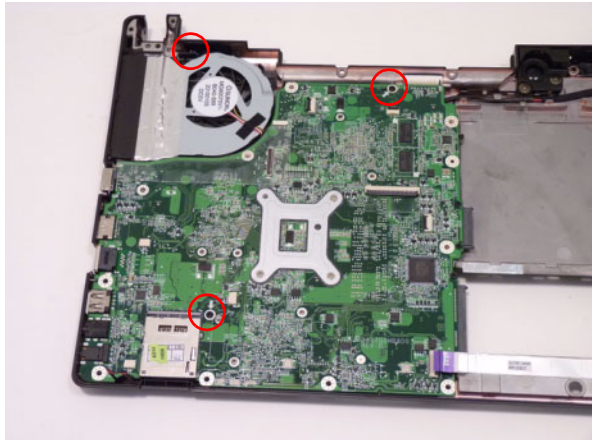
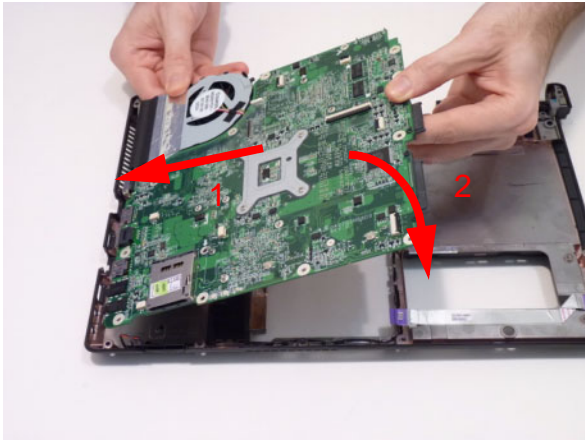

NOTE: Ensure the left side I/O ports are positioned correctly through the casing.

3. Turn the computer over and replace the DC-In cable.
4. Turn the computer over. Feed the microphone cable through the guides on the fan.

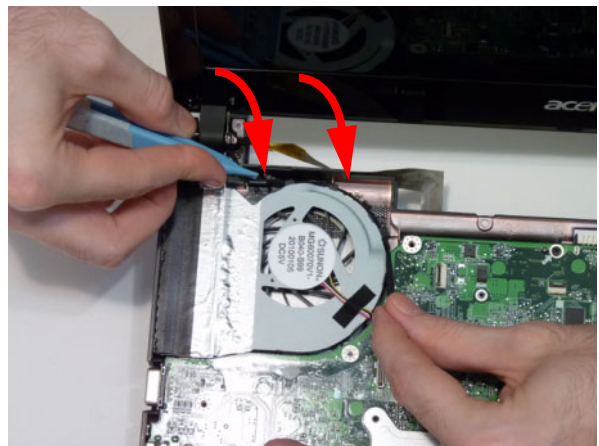

Replacing the LCD Module

1. Replace the LCD module onto the chassis.

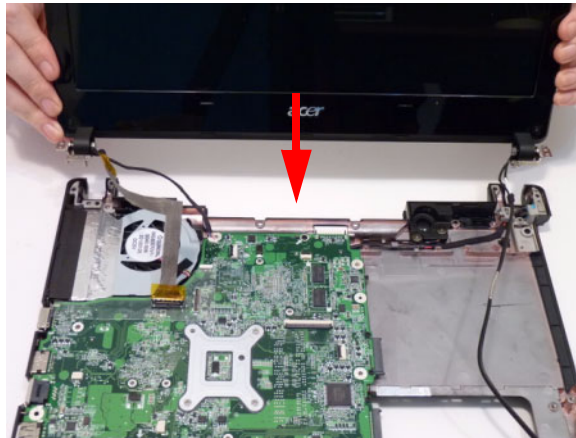

2. Replace the four securing screws (two each side) to the LCD module.



3. Starting at the top, slide your finger down the length of the LVDS cable to reattach the adhesive.

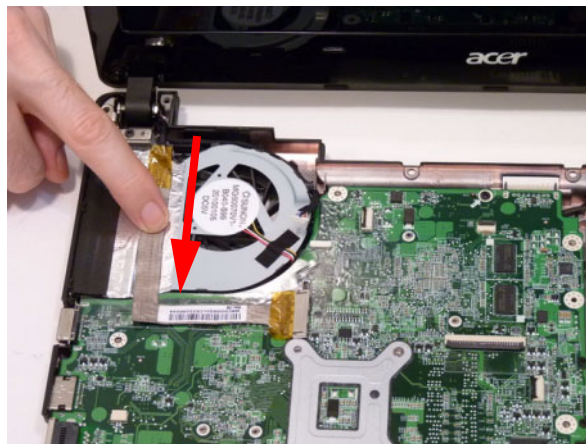

4. Snap the FPC cable into place.

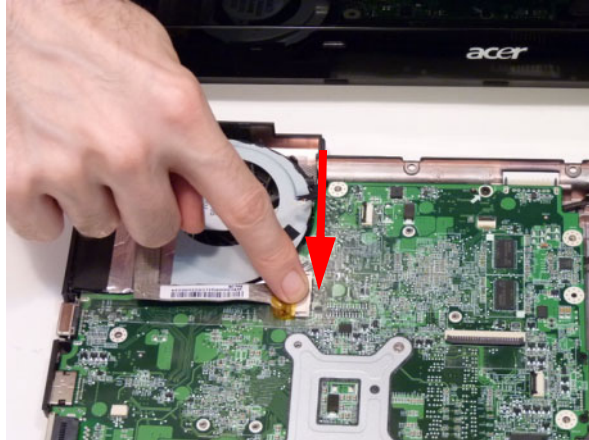

5. Connect the right speaker cable.

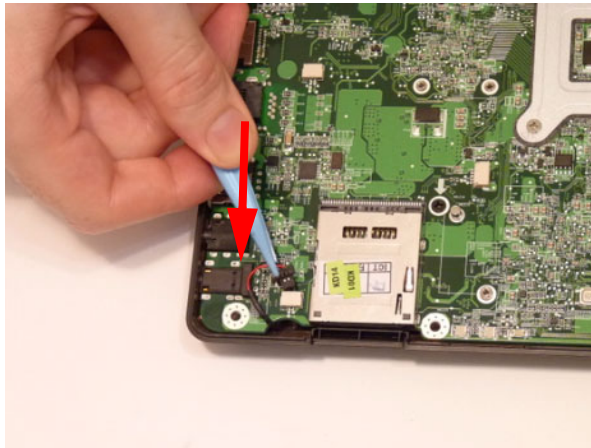

cover.

6. Replace the WLAN cables into the cable guides

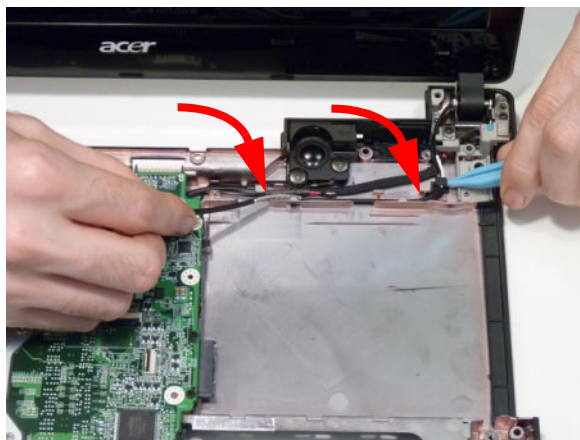

-
7. Rest the computer on the back of the LCD as shown. Pull the WiFi antennas through the hole in the chassis as shown.

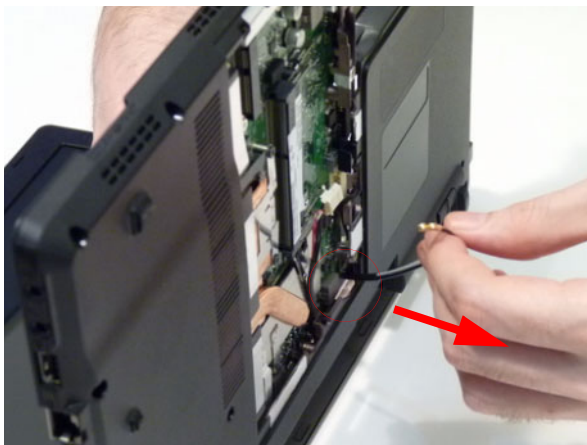

8. Insert the WLAN cables into the cable guides as shown.

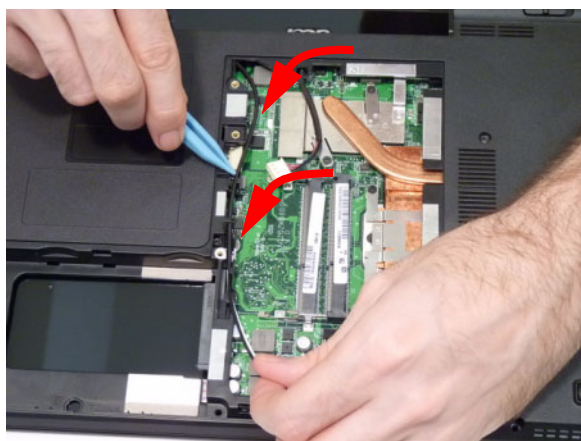

Replacing the Bluetooth Module

NOTE: The Bluetooth Module and USB Board can be replaced independently and in any order.

1. Connect the smaller end of the Bluetooth cable to the Bluetooth Module as shown.
2. Secure the Bluetooth module in place using the one (1) screw.

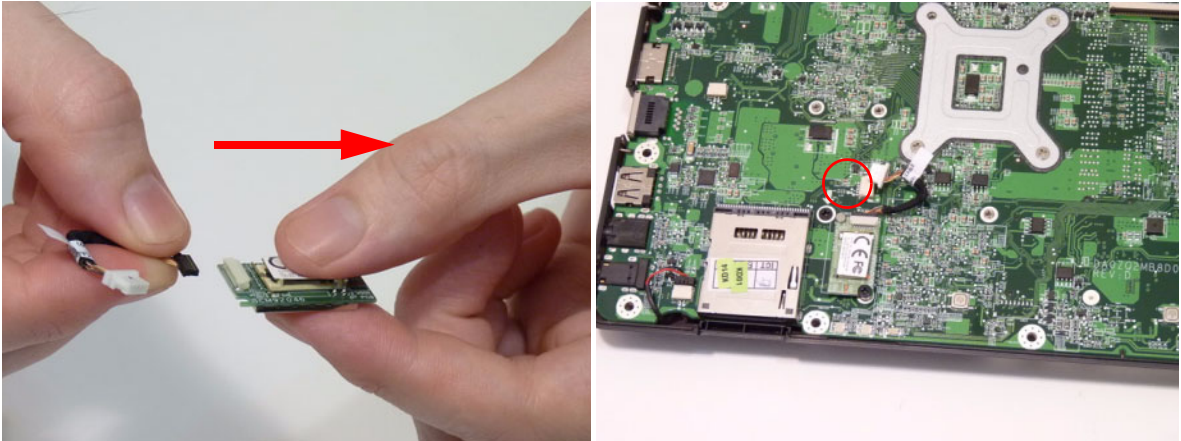

1. Connect the Bluetooth cable to the Mainboard.

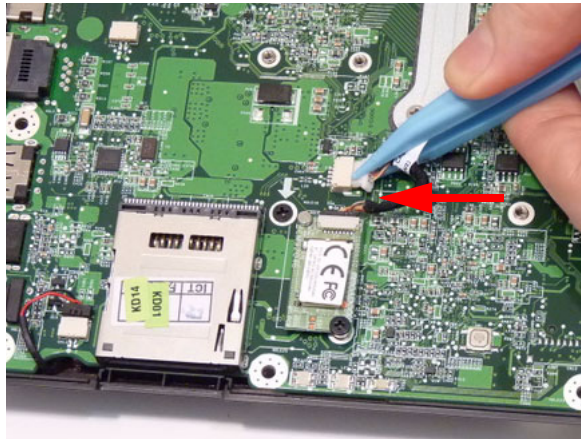

Replacing the USB Board

1. Replace the USB Board in the Lower Cover.
2. Insert the FFC cable in to the connector on the Mainboard and secure the locking latch.

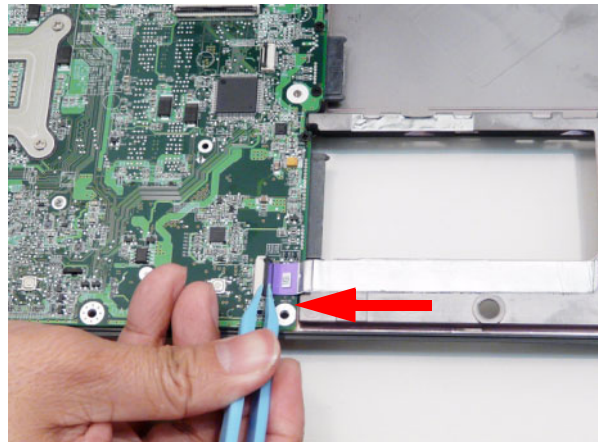
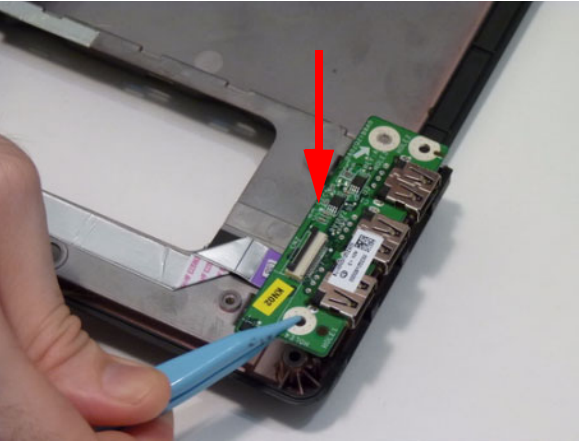

3. Insert the FFC cable in to the connector on the USB Board and secure the locking latch.
4. Replace the single securing screw.

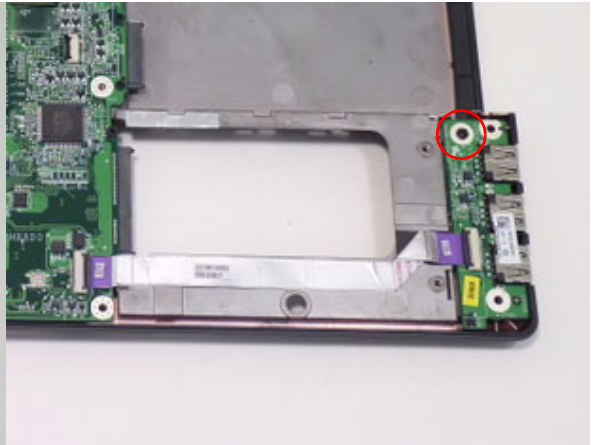
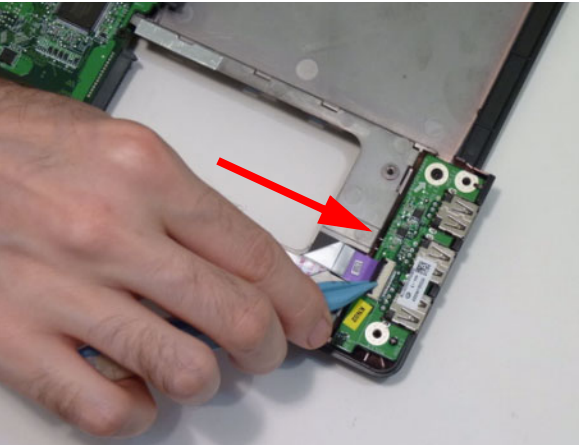

Replacing the Function Board

1. Replace the Function Board FFC and lock it into place.
2. Place the Function Board in to the Upper Cover as shown and replace the two (2) screws.

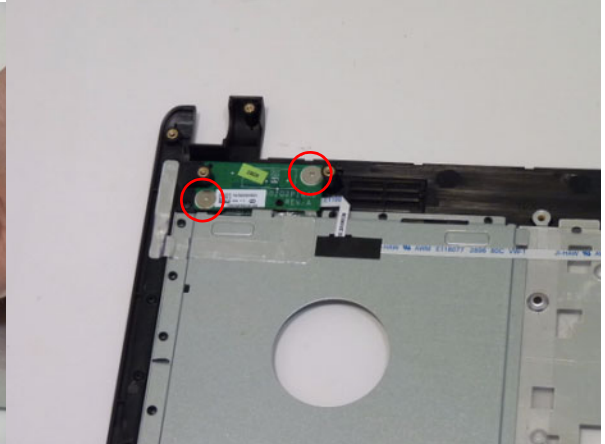
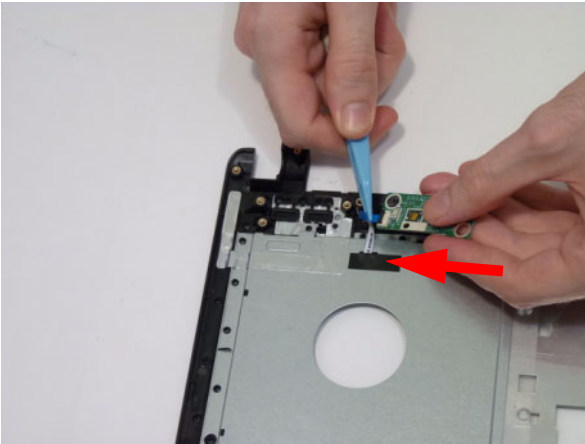

Replacing the Power Switch Board

1. Place the Power Switch Board in to the Upper Cover as shown and replace the two (2) screws.
2. Replace the Power Switch Board FFC and lock it into place.

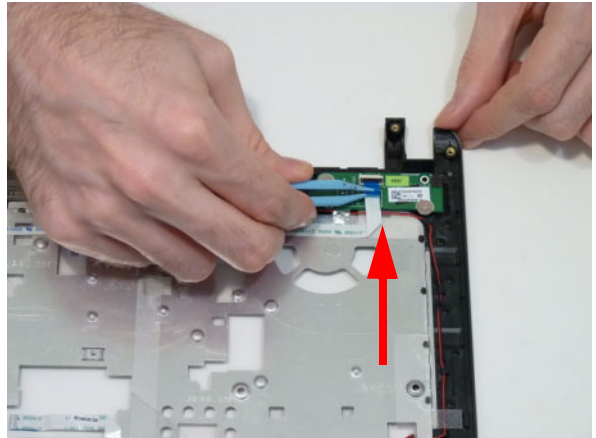
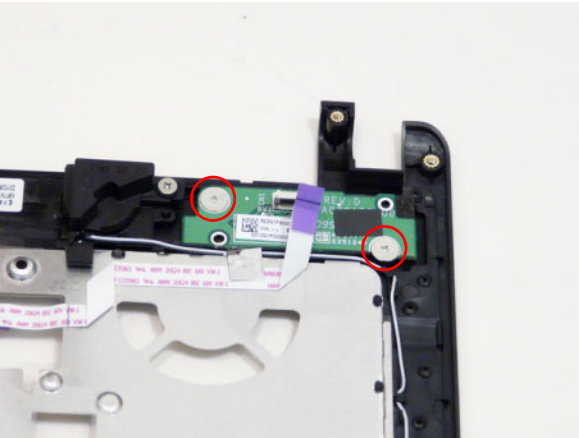

Replacing the Upper Cover

1. Place the Upper Cover on the Lower Cover back edge first.
2. Lower the cover into position and press down the sides as shown.



3. Continue pressing around the edges of the casing until there are no gaps between the Upper and Lower Covers.

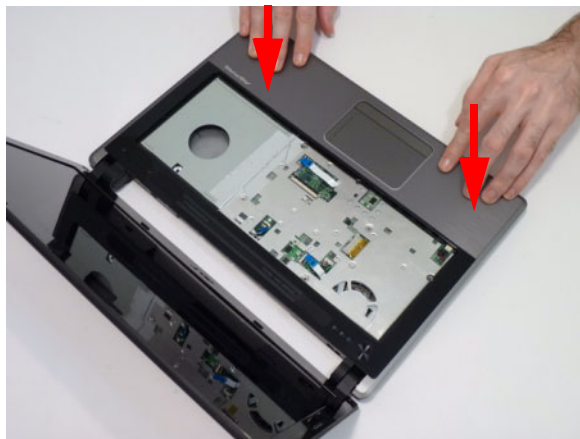

4. Replace the eight (8) securing screws as shown.

NOTE: The securing screws differ in length: M2.5*5 (red callout) and M2.5*3 (green callout). Ensure that the correct screw is used to secure the Upper Cover in place.

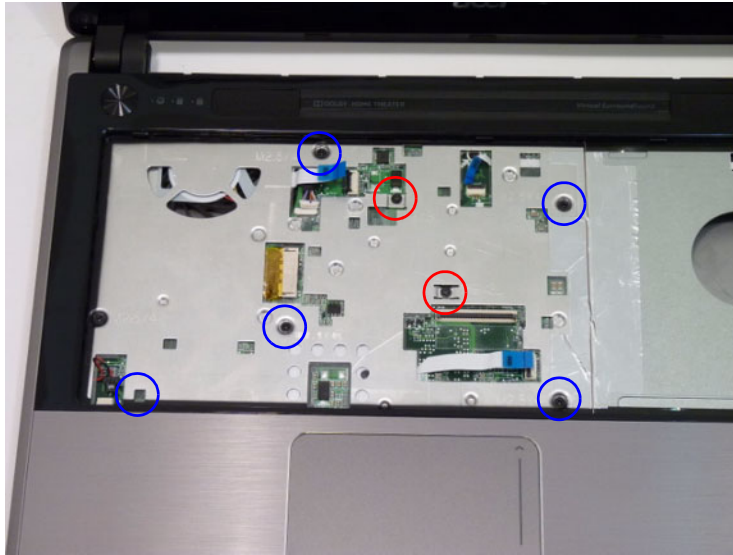

5. Connect the four cables to the Mainboard as shown.

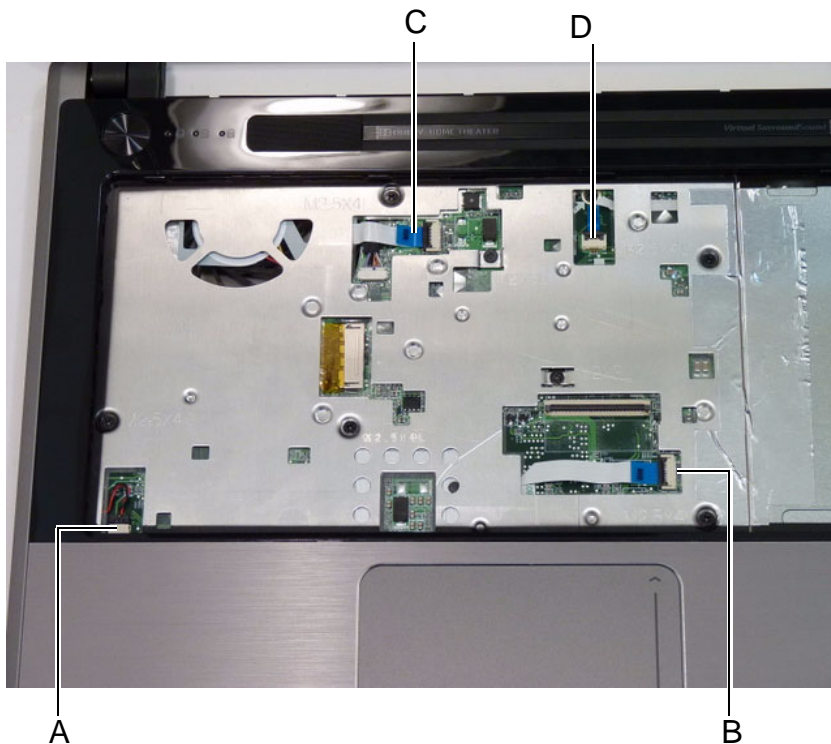

6. Connect A as shown.

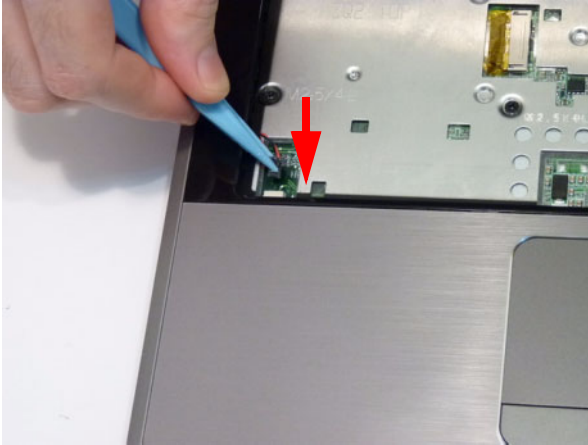

7. Insert B as shown and close the locking latch.

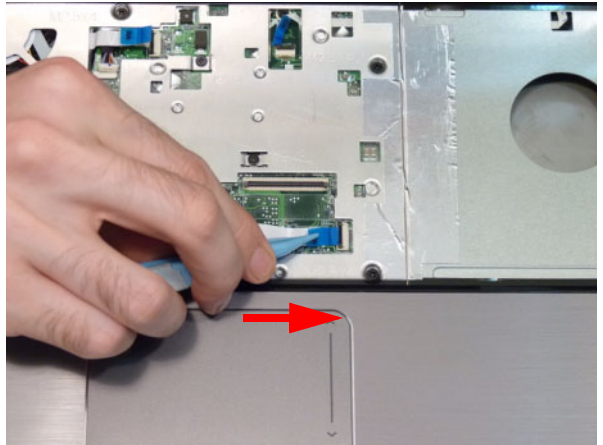

8. Insert C as shown and close the locking latch.



9. Insert D as shown and close the locking latch.

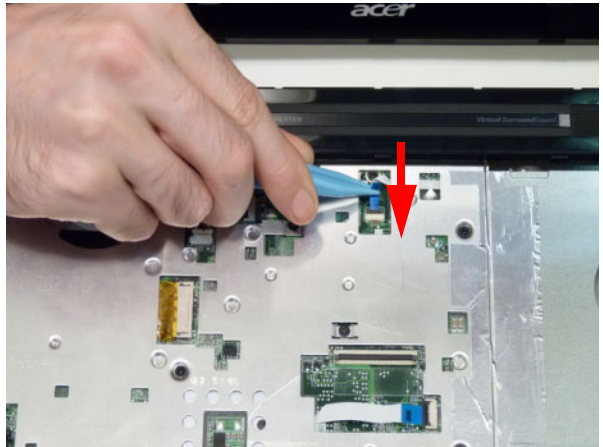

10. Turn the computer over and replace the fourteen screws as shown.

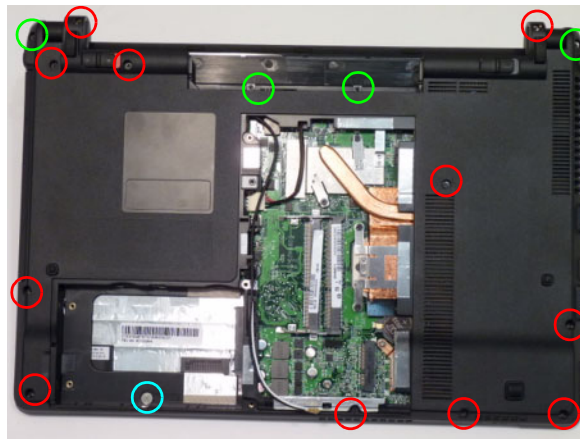

Replacing the Keyboard

1. Place the keyboard face down on the Upper Cover. Reconnect keyboard FFCs to the mainboard, and secure the locking latch.

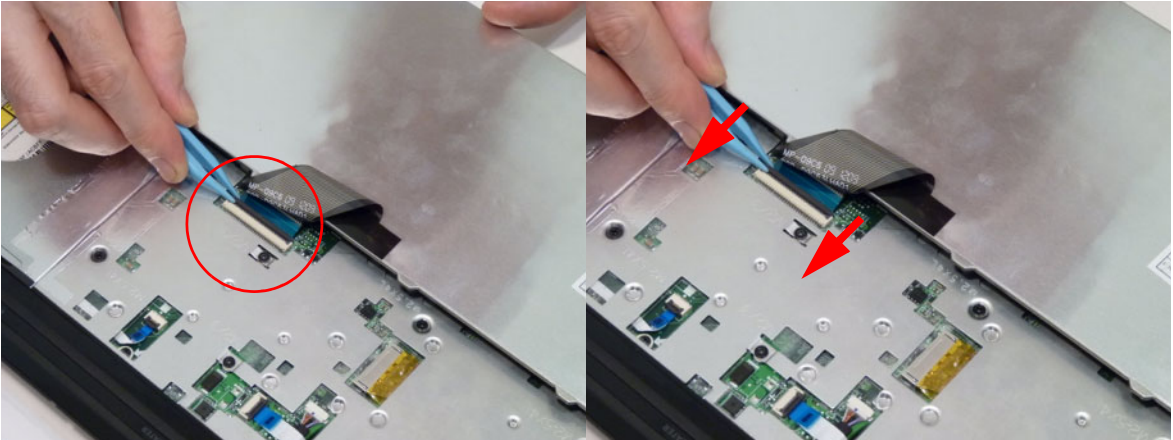

2. Slide the Keyboard front edge first into the Upper Cover, ensuring that the four locating tabs are correctly seated.



3. Press down as indicated to secure the Keyboard in place.



Replacing the ODD Module

1. Press the bezel into the tray, bottom edge first, to secure it to the ODD Module.
2. Secure the ODD bracket with the two screws.

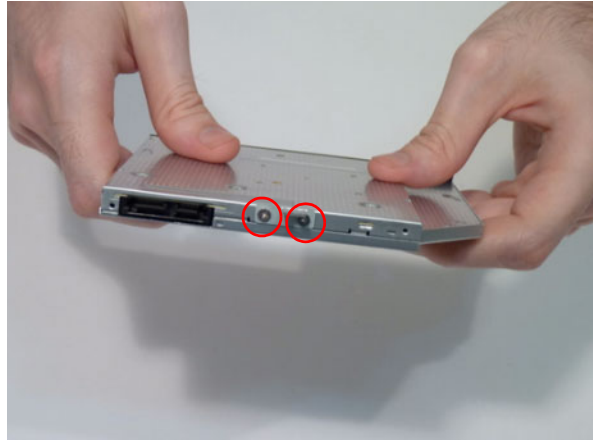
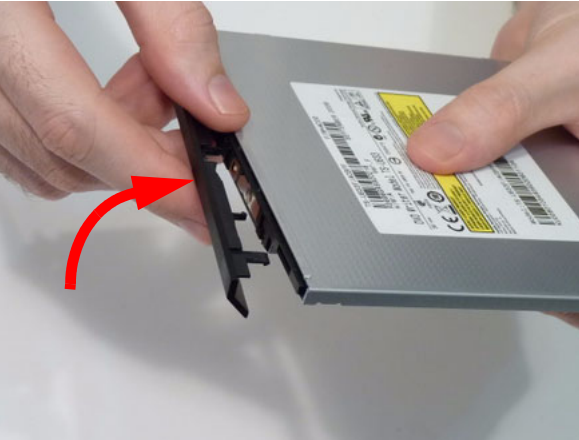

3. Push the ODD Module into the ODD bay until it is flush with the casing.
4. Replace the single screw to secure the Module.

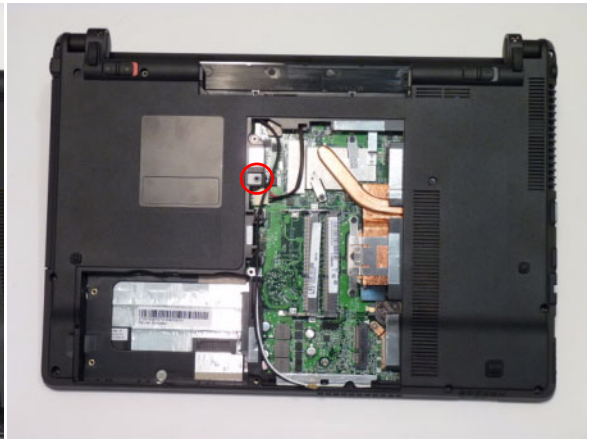
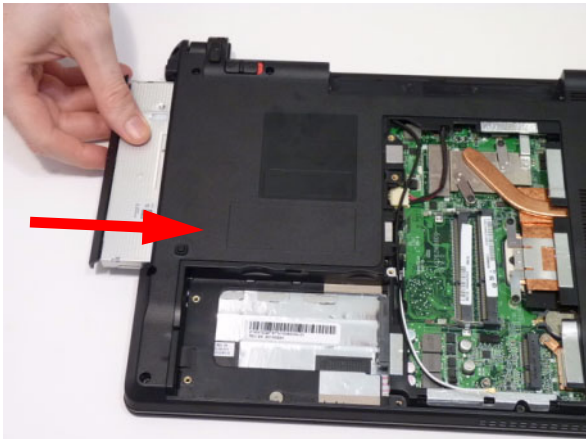

Replacing the Hard Disk Drive Module

1. Replace the HDD carrier and replace the two (2) screws.

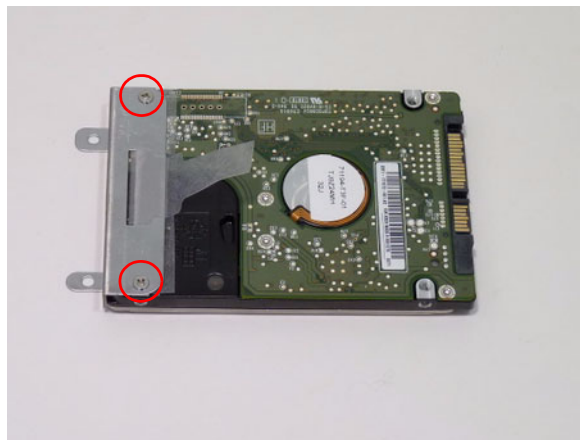

2. Insert the HDD, left side first, and lower it into place.

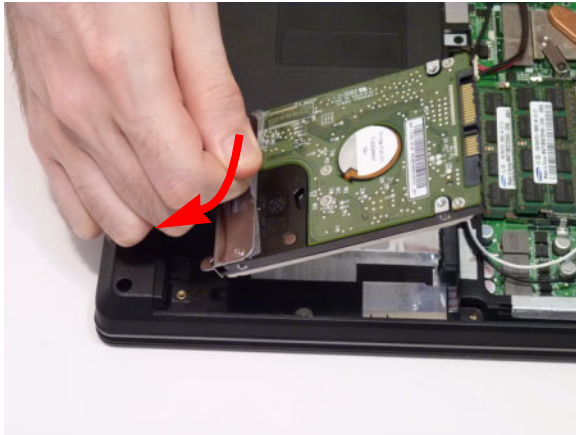

3. Slide the HDD to the right to connect the interface.



Replacing the WLAN Board

1. Insert the WLAN board into the WLAN socket.
2. Replace the one (1) screw to secure the module.

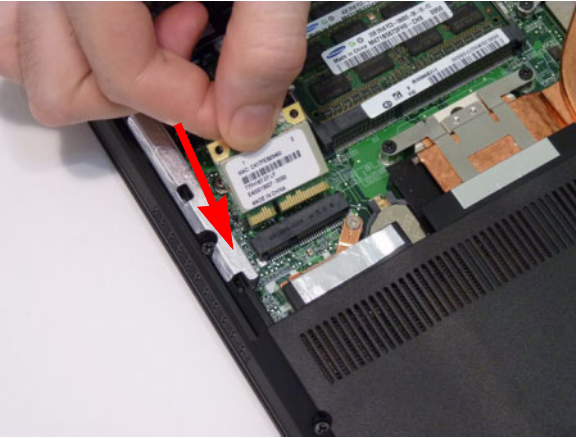

3. Connect the two (2) antenna cables to the module.

NOTE: Cable placement is **Black** to the **TR1** terminal (next to DIMM module) and **White** to the **TR2** terminal (closest to the edge of the chassis).



Replacing the DIMM Modules

1. Insert the DIMM Module in place.
2. Press down to lock the DIMM module in place.

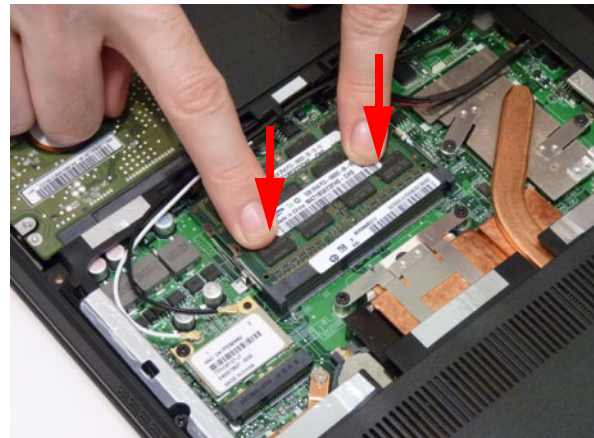
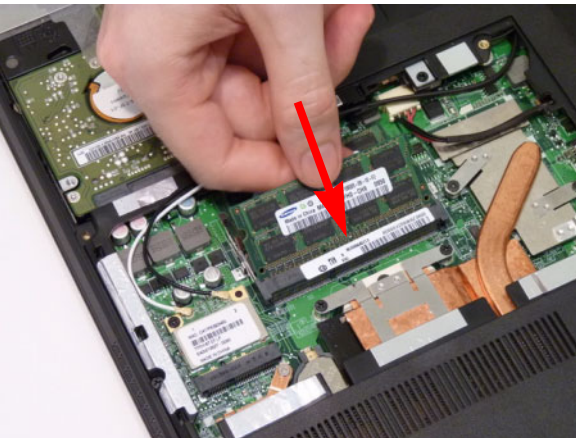

3. Repeat with the second DIMM module if present.

Replacing the Lower Covers

1. Replace the HDD Cover as shown.

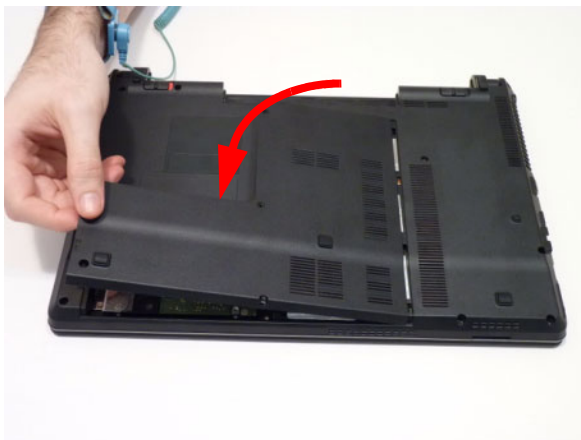

IMPORTANT: Press down around the perimeter of the cover to ensure that all the securing tabs are snapped correctly.

2. Secure the five captive screws to hold the covers in place.

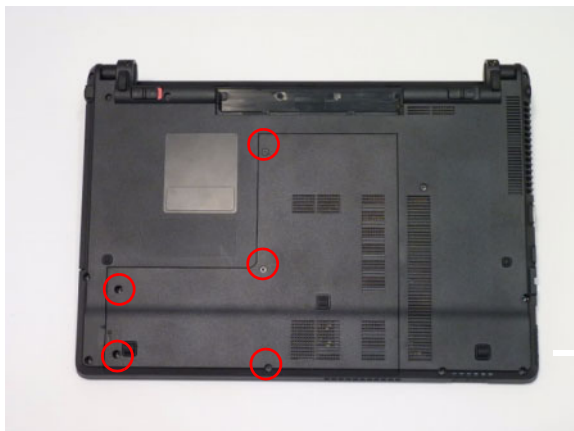

Replacing the Dummy Cards

1. Insert the SD Dummy Card into the slot and push until the card clicks into place and is flush with the casing.



Replacing the Battery Pack

1. Insert the battery pack and press down.
2. Slide the battery lock in the direction shown to secure the battery in place.



Troubleshooting

Common Problems

Use the following procedure as a guide for computer problems.

NOTE: The diagnostic tests are intended to test only Acer products. Non-Acer products, prototype cards, or modified options can give false errors and invalid system responses.

1. Obtain the failing symptoms in as much detail as possible.
2. Verify the symptoms by attempting to re-create the failure by running the diagnostic test or by repeating the same operation.
3. Use the following table with the verified symptom to determine which page to go to.

Symptoms (Verified)	Go To
Power On Issue	Page 108
No Display Issue	Page 109
LCD Failure	Page 111
Internal Keyboard Failure	Page 111
TouchPad Failure	Page 112
Internal Speaker Failure	Page 112
ODD Failure	Page 115
WLAN Failure	Page 118
Thermal Unit Failure	Page 118
Other Functions Failure	Page 119
Intermittent Failures	Page 120
Undermined Failures	Page 120

4. If the Issue is still not resolved, see "Online Support Information" on page 165.

Power On Issue

If the system doesn't power on, perform the following actions one at a time to correct the problem. Do not replace a non-defective FRUs:

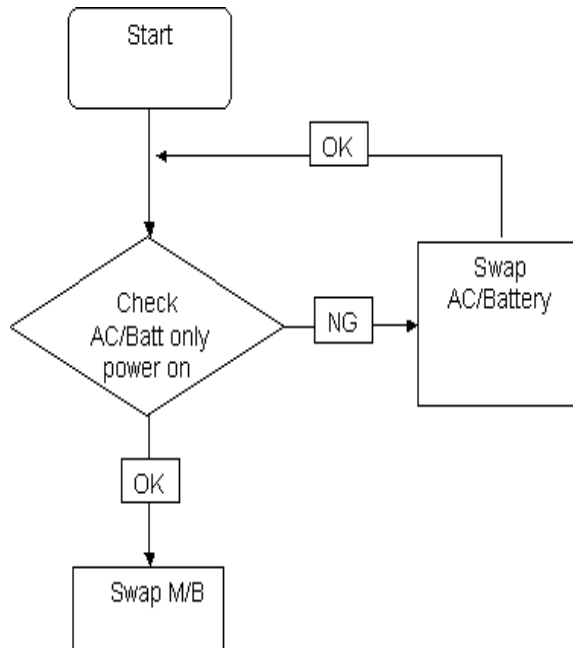

Computer Shutdown Intermittently

If the system powers off at intervals, perform the following actions one at a time to correct the problem.

1. Check the power cable is properly connected to the computer and the electrical outlet.
2. Remove any extension cables between the computer and the outlet.
3. Remove any surge protectors between the computer and the electrical outlet. Plug the computer directly into a known good electrical outlet.
4. Disconnect the power and open the casing to check the Thermal Unit (see "Thermal Unit Failure" on page 118) and fan airways are free of obstructions.
5. Remove all external and non-essential hardware connected to the computer that are not necessary to boot the computer to the failure point.
6. Remove any recently installed software.
7. If the Issue is still not resolved, see "Online Support Information" on page 165.

No Display Issue

If the **Display** doesn't work, perform the following actions one at a time to correct the problem. Do not replace a non-defective FRUs:

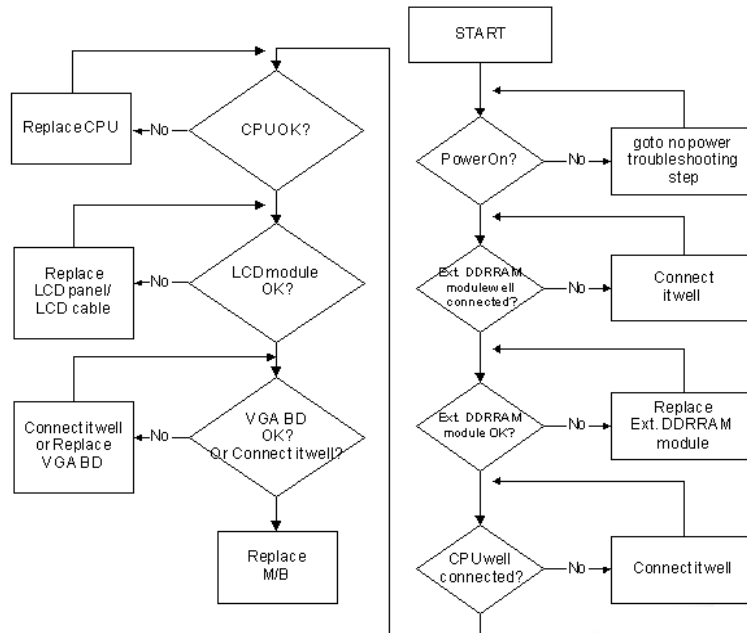

No POST or Video

If the POST or video doesn't display, perform the following actions one at a time to correct the problem.

1. Make sure that the internal display is selected. On this notebook model, switching between the internal display and the external display is done by pressing **Fn+F5**. Reference Product pages for specific model procedures.
2. Make sure the computer has power by checking at least one of the following occurs:
 - Fans start up
 - Status LEDs light up

If there is no power, see "Power On Issue" on page 108.

3. Drain any stored power by removing the power cable and battery and holding down the power button for 10 seconds. Reconnect the power and reboot the computer.
4. Connect an external monitor to the computer and switch between the internal display and the external display is by pressing **Fn+F5** (on this model).

If the POST or video appears on the external display, see "LCD Failure" on page 111.

5. Disconnect power and all external devices including port replicators or docking stations. Remove any memory cards and CD/DVD discs. Restart the computer.

If the computer boots correctly, add the devices one by one until the failure point is discovered.

6. Reseat the memory modules.
7. Remove the drives (see "Disassembly Process" on page 46).
8. If the Issue is still not resolved, see "Online Support Information" on page 165.

Abnormal Video Display

If video displays abnormally, perform the following actions one at a time to correct the problem.

1. Reboot the computer.
2. If permanent vertical/horizontal lines or dark spots display in the same location, the LCD is faulty and should be replaced. See "Disassembly Process" on page 46.
3. If extensive pixel damage is present (different colored spots in the same locations on the screen), the LCD is faulty and should be replaced. See "Disassembly Process" on page 46.
4. Adjust the brightness to its highest level. See the User Manual for instructions on adjusting settings.
NOTE: Ensure that the computer is not running on battery alone as this may reduce display brightness.
If the display is too dim at the highest brightness setting, the LCD is faulty and should be replaced. See "Disassembly Process" on page 46.
5. Check the display resolution is correctly configured:
 - a. Minimize or close all Windows.
 - b. If display size is only abnormal in an application, check the view settings and control/mouse wheel zoom feature in the application.
 - c. If desktop display resolution is not normal, right-click on the desktop and select **Personalize** → **Display Settings**.
 - d. Click and drag the Resolution slider to the desired resolution.
 - e. Click **Apply** and check the display. Readjust if necessary.
6. Roll back the video driver to the previous version if updated.
7. Remove and reinstall the video driver.
8. Check the Device Manager to determine that:
 - The device is properly installed. There are no red Xs or yellow exclamation marks.
 - There are no device conflicts.
 - No hardware is listed under Other Devices.
9. If the Issue is still not resolved, see "Online Support Information" on page 165.
10. Run the Windows Memory Diagnostic from the operating system DVD and follow the onscreen prompts.
11. If the Issue is still not resolved, see "Online Support Information" on page 165.

Random Loss of BIOS Settings

If the computer is experiencing intermittent loss of BIOS information, perform the following actions one at a time to correct the problem.

1. If the computer is more than one year old, replace the CMOS battery.
2. Run a complete virus scan using up-to-date software to ensure the computer is virus free.
3. If the computer is experiencing HDD or ODD BIOS information loss, disconnect and reconnect the power and data cables between devices.
If the BIOS settings are still lost, replace the cables.
4. If HDD information is missing from the BIOS, the drive may be defective and should be replaced.
5. Replace the Motherboard.
6. If the Issue is still not resolved, see "Online Support Information" on page 165.

LCD Failure

If the **LCD** fails, perform the following actions one at a time to correct the problem. Do not replace a non-defective FRUs:

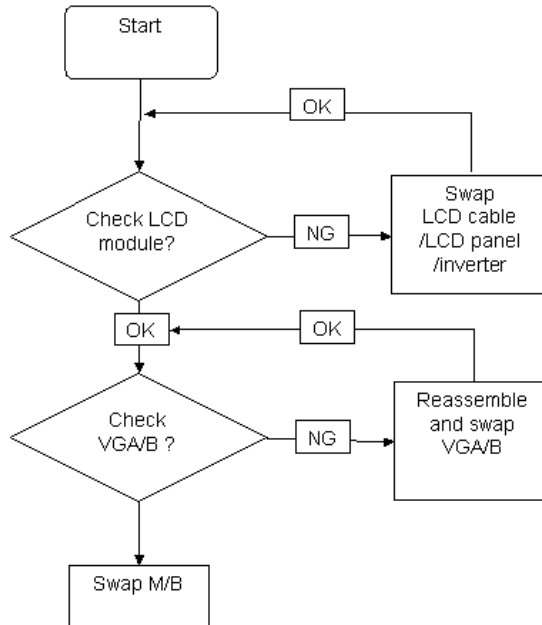

Built-In Keyboard Failure

If the built-in **Keyboard** fails, perform the following actions one at a time to correct the problem. Do not replace a non-defective FRUs:

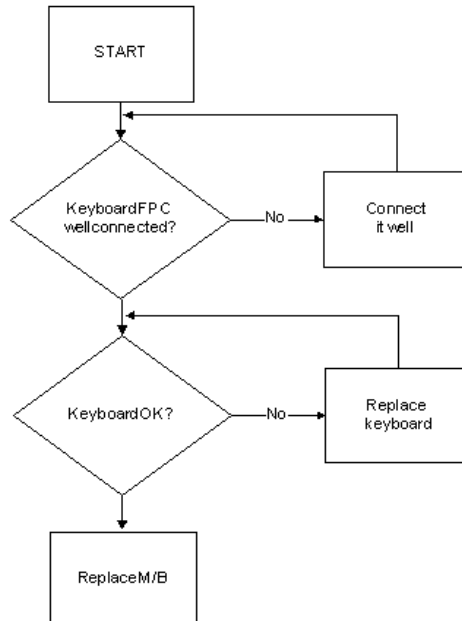

TouchPad Failure

If the **TouchPad** doesn't work, perform the following actions one at a time to correct the problem. Do not replace a non-defective FRUs:

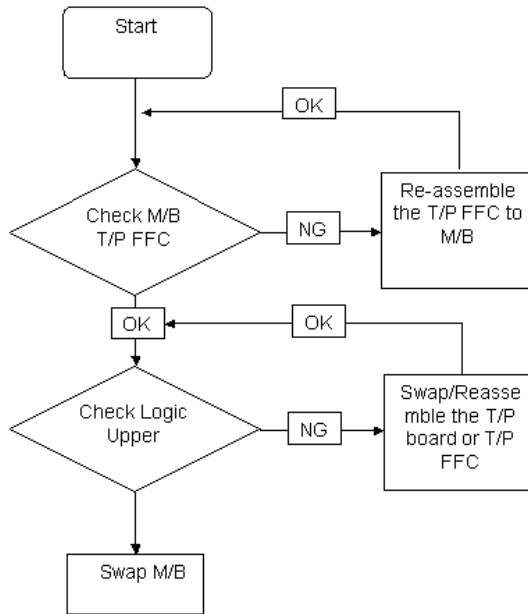

Internal Speaker Failure

If the internal **Speakers** fail, perform the following actions one at a time to correct the problem. Do not replace a non-defective FRUs:

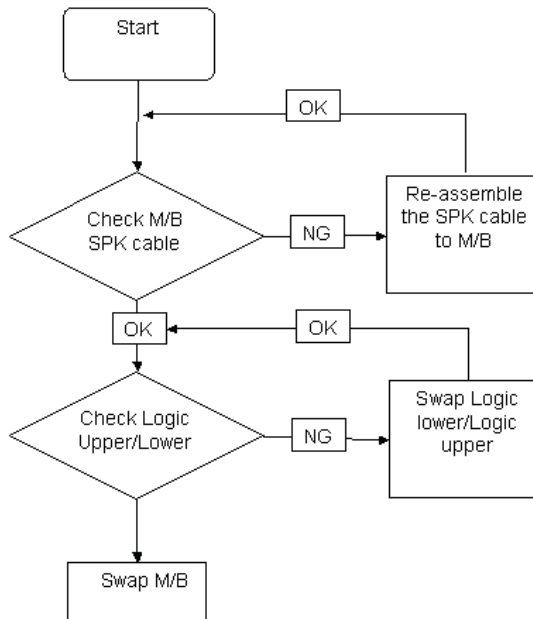

Sound Problems

If sound problems are experienced, perform the following actions one at a time to correct the problem.

1. Reboot the computer.
2. Navigate to **Start** → **Control Panel** → **System and Maintenance** → **System** → **Device Manager**. Check the Device Manager to determine that:
 - The device is properly installed.
 - There are no red Xs or yellow exclamation marks.
 - There are no device conflicts.
 - No hardware is listed under Other Devices.
3. Roll back the audio driver to the previous version, if updated recently.
4. Remove and reinstall the audio driver.
5. Ensure that all volume controls are set mid range:
 - a. Click the volume icon on the taskbar and drag the slider to 50. Ensure that the volume is not muted.
 - b. Click Mixer to verify that other audio applications are set to 50 and not muted.
6. Navigate to **Start** → **Control Panel** → **Hardware and Sound** → **Sound**. Ensure that Speakers are selected as the default audio device (green check mark).

NOTE: If Speakers does not show, right-click on the **Playback** tab and select **Show Disabled Devices** (clear by default).
7. Select Speakers and click **Configure** to start **Speaker Setup**. Follow the onscreen prompts to configure the speakers.
8. Remove and recently installed hardware or software.
9. Restore system and file settings from a known good date using **System Restore**.

If the issue is not fixed, repeat the preceding steps and select an earlier time and date.
10. Reinstall the Operating System.
11. If the Issue is still not resolved, see “Online Support Information” on page 165.

Microphone Problems

If internal or external **Microphones** do not operate correctly, perform the following actions one at a time to correct the problem.

1. Check that the microphone is enabled. Navigate to **Start** → **Control Panel** → **Hardware and Sound** → **Sound** and select the **Recording** tab.
2. Right-click on the **Recording** tab and select **Show Disabled Devices** (clear by default).
3. The microphone appears on the **Recording** tab.
4. Right-click on the microphone and select **Enable**.
5. Select the microphone then click **Properties**. Select the **Levels** tab.
6. Increase the volume to the maximum setting and click **OK**.
7. Test the microphone hardware:
 - a. Select the microphone and click **Configure**.
 - b. Select **Set up microphone**.
 - c. Select the microphone type from the list and click **Next**.
 - d. Follow the onscreen prompts to complete the test.
8. If the Issue is still not resolved, see “Online Support Information” on page 165.

HDD Not Operating Correctly

If the **HDD** does not operate correctly, perform the following actions one at a time to correct the problem.

1. Disconnect all external devices.
2. Run a complete virus scan using up-to-date software to ensure the computer is virus free.
3. Run the Windows 7 Startup Repair Utility:
 - a. insert the Windows 7 Operating System DVD in the ODD and restart the computer.
 - b. When prompted, press any key to start to the operating system DVD.
 - c. The **Install Windows** screen displays. Click **Next**.
 - d. Select **Repair your computer**.
 - e. The **System Recovery Options** screen displays. Click **Next**.
 - f. Select the appropriate operating system, and click **Next**.

NOTE: Click **Load Drivers** if controller drives are required.

- g. Select **Startup Repair**.
- h. Startup Repair attempts to locate and resolve issues with the computer.
- i. When complete, click **Finish**.

If an issue is discovered, follow the onscreen information to resolve the problem.

4. Run the Windows Memory Diagnostic Tool. For more information see Windows Help and Support.
5. Restart the computer and press F2 to enter the BIOS Utility. Check the BIOS settings are correct and that CD/DVD drive is set as the first boot device on the Boot menu.
6. Ensure all cables and jumpers on the HDD and ODD are set correctly.
7. Remove any recently added hardware and associated software.
8. Run the Windows Disk Defragmenter. For more information see Windows Help and Support.
9. Run Windows Check Disk by entering **chkdsk /r** from a command prompt. For more information see Windows Help and Support.
10. Restore system and file settings from a known good date using **System Restore**.

If the issue is not fixed, repeat the preceding steps and select an earlier time and date.
11. Replace the HDD. See "Disassembly Process" on page 46.

ODD Failure

If the **ODD** fails, perform the following actions one at a time to correct the problem. Do not replace a non-defective FRUs:

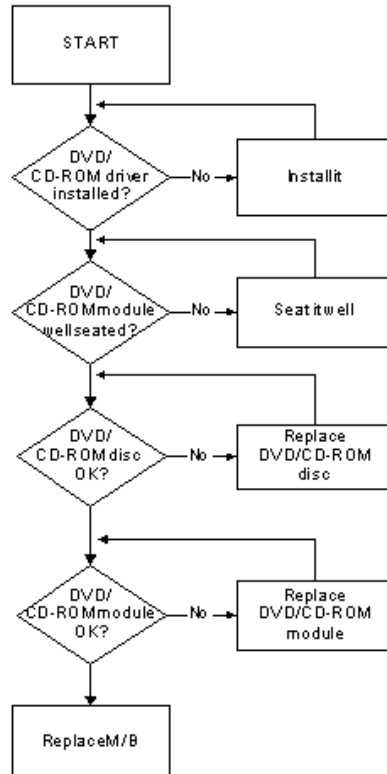

ODD Not Operating Correctly

If the **ODD** exhibits any of the following symptoms it may be faulty:

- Audio CDs do not play when loaded
- DVDs do not play when loaded
- Blank discs do not burn correctly
- DVD or CD play breaks up or jumps
- Optical drive not found or not active:
 - Not shown in My Computer or the BIOS setup
 - LED does not flash when the computer starts up
 - The tray does not eject
- Access failure screen displays
- The ODD is noisy

Perform the following general solutions one at a time to correct the problem.

1. Reboot the computer and retry the operation.
2. Try an alternate disc.
3. Navigate to **Start** → **Computer**. Check that the ODD device is displayed in the **Devices with Removable Storage** panel.
4. Navigate to **Start** → **Control Panel** → **System and Maintenance** → **System** → **Device Manager**.

-
- a. Double-click **IDE ATA/ATAPI controllers**. If a device displays a down arrow, right-click on the device and click **Enable**.
 - b. Double-click **DVD/CD-ROM drives**. If the device displays a down arrow, right-click on the device and click **Enable**.
 - c. Check that there are no yellow exclamation marks against the items in **IDE ATA/ATAPI controllers**. If a device has an exclamation mark, right-click on the device and uninstall and reinstall the driver.
 - d. Check that there are no yellow exclamation marks against the items in **DVD/CD-ROM drives**. If a device has an exclamation mark, right-click on the device and uninstall and reinstall the driver.
 - e. If the exclamation marker is not removed from the item in the lists, try removing any recently installed software and retrying the operation.

Discs Do Not Play

If discs do not play when inserted in the drive, perform the following actions one at a time to correct the problem.

1. Check that the disc is correctly seated in the drive tray and that the label on the disc is visible.
2. Check that the media is clean and scratch free.
3. Try an alternate disc in the drive.
4. Ensure that **AutoPlay** is enabled:
 - a. Navigate to **Start** → **Control Panel** → **Hardware and Sound** → **AutoPlay**.
 - b. Select **Use AutoPlay for all media and devices**.
 - c. In the Audio CD and DVD Movie fields, select the desired player from the drop down menu.
5. Check that the Regional Code is correct for the selected media:

IMPORTANT:Region can only be changed a limited number of times. After Changes remaining reaches zero, the region cannot be changed even Windows is reinstalled or the drive is moved to another computer.

- a. Navigate to **Start** → **Control Panel** → **System and Maintenance** → **System** → **Device Manager**.
- b. Double-click **DVD/CD-ROM drives**.
- c. Right-click **DVD drive** and click **Properties**, then click the **DVD Region** tab.
- d. Select the region suitable for the media inserted in the drive.

Discs Do Not Burn Properly

If discs can not be burned, perform the following actions one at a time to correct the problem.

1. Ensure that the default drive is record enabled:
 - a. Navigate to **Start** → **Computer** and right-click the writable ODD icon. Click **Properties**.
 - b. Select the **Recording** tab. In the **Desktop disc recording** panel, select the writable ODD from the drop down list.
 - c. Click **OK**.
2. Ensure that the software used for burning discs is the factory default. If using different software, refer to the software's user manual.

Playback is Choppy

If playback is choppy or jumps, perform the following actions one at a time to correct the problem.

1. Check that system resources are not running low:
 - a. Try closing some applications.
 - b. Reboot and try the operation again.
2. Check that the ODD controller transfer mode is set to DMA:
 - a. Navigate to **Start** → **Control Panel** → **System and Maintenance** → **System** → **Device Manager**.

-
- b. Double-click **IDE ATA/ATAPI controllers**, then right-click ATA Device 0.
 - c. Click **Properties** and select the **Advanced Settings** tab. Ensure that the **Enable DMA** box is checked and click **OK**.
 - d. Repeat for the other ATA Devices shown if applicable.

Drive Not Detected

If Windows cannot detect the drive, perform the following actions one at a time to correct the problem.

1. Restart the computer and press F2 to enter the BIOS Utility.
2. Check that the drive is detected in the **ATAPI Model Name** field on the Information page.
NOTE: Check that the entry is identical to one of the ODDs specified in "Hardware Specifications and Configurations" on page 16.
3. Turn off the power and remove the cover to inspect the connections to the ODD. See "Disassembly Process" on page 46.
 - a. Check for broken connectors on the drive, motherboard, and cables.
 - b. Check for bent or broken pins on the drive, motherboard, and cable connections.
 - c. Try an alternate cable, if available. If the drive works with the new cable, the original cable should be replaced.
4. Reseat the drive ensuring and all cables are connected correctly.
5. Replace the ODD. See "Disassembly Process" on page 46.

Drive Read Failure

If discs cannot be read when inserted in the drive, perform the following actions one at a time to correct the problem.

1. Remove and clean the failed disc.
2. Retry reading the CD or DVD.
 - d. Test the drive using other discs.
 - e. Play a DVD movie
 - f. Listen to a music CD

If the ODD works properly with alternate discs, the original disc is probably defective and should be replaced.

3. Turn off the power and remove the cover to inspect the connections to the ODD. See "Disassembly Process" on page 46.
 - a. Check for broken connectors on the drive, motherboard, and cables.
 - b. Check for bent or broken pins on the drive, motherboard, and cable connections.
 - c. Try an alternate cable, if available. If the drive works with the new cable, the original cable should be replaced.
4. Replace the ODD. See "Disassembly Process" on page 46.

Wireless Function Failure

If the **WLAN** fails, perform the following actions one at a time to correct the problem. Do not replace a non-defective FRUs:

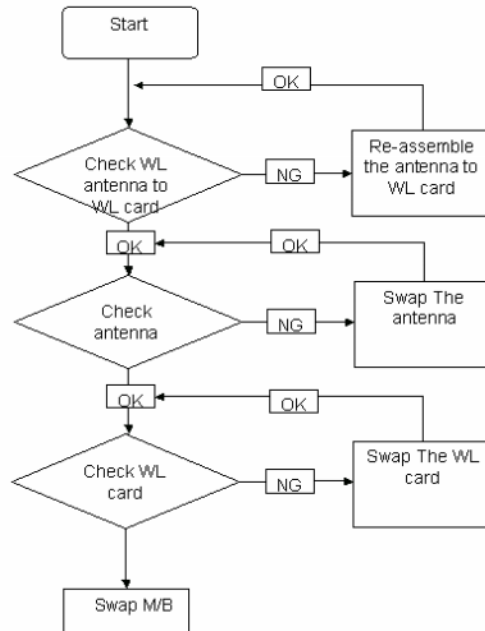

Thermal Unit Failure

If the **Thermal Unit** fails, perform the following actions one at a time to correct the problem. Do not replace a non-defective FRUs:

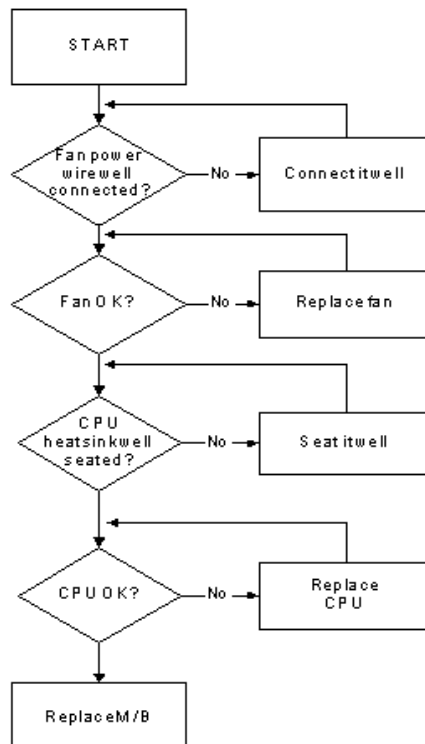

External Mouse Failure

If an external **Mouse** fails, perform the following actions one at a time to correct the problem.

1. Try an alternative mouse.
2. If the mouse uses a wireless connection, insert new batteries and confirm there is a good connection. See the mouse user manual.
3. If the mouse uses a USB connection, try an alternate USB port.
4. Try an alternative program to verify mouse operation. Reinstall the program experiencing mouse failure.
5. Restart the computer.
6. Remove any recently added hardware and associated software.
7. Remove any recently added software and reboot.
8. Restore system and file settings from a known good date using **System Restore**.
If the issue is not fixed, repeat the preceding steps and select an earlier time and date.
9. Run the Event Viewer to check the events log for errors. For more information see Windows Help and Support.
10. Roll back the mouse driver to the previous version if updated recently.
11. Remove and reinstall the mouse driver.
12. Check the Device Manager to determine that:
 - The device is properly installed. There are no red Xs or yellow exclamation marks.
 - There are no device conflicts.
 - No hardware is listed under Other Devices.
13. If the Issue is still not resolved, see "Online Support Information" on page 165.

Other Failures

If the CRT Switch, Dock, LAN Port, external MIC or Speakers, PCI Express Card, 5-in-1 Card Reader or Volume Wheel fail, perform the following general steps to correct the problem. Do not replace a non-defective FRUs:

1. Check Drive whether is OK.
2. Check Test Fixture is ok.
3. Swap M/B to Try.

Intermittent Problems

Intermittent system hang problems can be caused by a variety of reasons that have nothing to do with a hardware defect, such as: cosmic radiation, electrostatic discharge, or software errors. FRU replacement should be considered only when a recurring problem exists.

When analyzing an intermittent problem, do the following:

1. Run the advanced diagnostic test for the system board in loop mode at least 10 times.
2. If no error is detected, do not replace any FRU.
3. If any error is detected, replace the FRU. Rerun the test to verify that there are no more errors.

Undetermined Problems

The diagnostic problems does not identify which adapter or device failed, which installed devices are incorrect, whether a short circuit is suspected, or whether the system is inoperative.

Follow these procedures to isolate the failing FRU (do not isolate non-defective FRU).

NOTE: Verify that all attached devices are supported by the computer.

NOTE: Verify that the power supply being used at the time of the failure is operating correctly. (See "Power On Issue" on page 108.):

1. Power-off the computer.
2. Visually check them for damage. If any problems are found, replace the FRU.
3. Remove or disconnect all of the following devices:
 - Non-Acer devices
 - Printer, mouse, and other external devices
 - Battery pack
 - Hard disk drive
 - DIMM
 - CD-ROM/Diskette drive Module
 - PC Cards
4. Power-on the computer.
5. Determine if the problem has changed.
6. If the problem does not recur, reconnect the removed devices one at a time until you find the failing FRU.
7. If the problem remains, replace the following FRU one at a time. Do not replace a non-defective FRU:
 - System board
 - LCD assembly

Post Codes

These tables describe the POST codes and descriptions during the POST.

Code	POST Routine Description
02h	Verify Real Mode
03h	Disable Non-Maskable Interrupt (NMI)
04h	Get CPU type
06h	Initialize system hardware
08h	Initialize chipset with initial POST values
09h	Set IN POST flag
0Ah	Initialize CPU registers
0Bh	Enable CPU cache
0Ch	Initialize caches to initial POST values
0Eh	Initialize I/O component

Code	Beeps	POST Routine Description
0Fh		Initialize the local bus IDE
10h		Initialize Power Management
11h		Load alternate registers with initial POST values
12h		Restore CPU control word during warm boot
13h		Initialize PCI Bus Mastering devices
14h		Initialize keyboard controller
16h	1-2-2-3	BIOS ROM checksum
17h		Initialize cache before memory autosize
18h		8254 timer initialization
1Ah		8237 DMA controller initialization
1Ch		Reset Programmable Interrupt Controller
20h	1-3-1-1	Test DRAM refresh
22h	1-3-1-3	Test 8742 Keyboard Controller
24h		Set ES segment register to 4 GB
26h		Enable A20 line
28h		Autosize DRAM
29h		Initialize POST Memory Manager
2Ah		Clear 512 KB base RAM
2Ch	1-3-4-1	RAM failure on address line xxxx*
2Eh	1-3-4-3	RAM failure on data bits xxxx* of low byte of memory bus
2Fh		Enable cache before system BIOS shadow
30h	1-4-1-1	RAM failure on data bits xxxx* of high byte of memory bus
32h		Test CPU bus-clock frequency
33h		Initialize Phoenix Dispatch Manager
36h		Warm start shut down
38h		Shadow system BIOS ROM
3Ah		Autosize cache
3Ch		Advanced configuration of chipset registers

Code	Beeps	POST Routine Description
3Dh		Load alternate registers with CMOS values
42h		Initialize interrupt vectors
45h		POST device initialization
46h	2-1-2-3	Check ROM copyright notice
48h		Check video configuration against CMOS
49h		Initialize PCI bus and devices
4Ah		Initialize all video adapters in system
4Bh		QuietBoot start (optional)
4Ch		Shadow video BIOS ROM

Code	Beeps	POST Routine Description
4Eh		Display BIOS copyright notice
50h		Display CPU type and speed
51h		Initialize EISA board
52h		Test keyboard
54h		Set key click if enabled
58h	2-2-3-1	Test for unexpected interrupts
59h		Initialize POST display service
5Ah		Display prompt "Press F2 to enter SETUP"
5Bh		Disable CPU cache
5Ch		Test RAM between 512 and 640 KB
60h		Test extended memory
62h		Test extended memory address lines
64h		Jump to UserPatch1
66h		Configure advanced cache registers
67h		Initialize Multi Processor APIC
68h		Enable external and CPU caches
69h		Setup System Management Mode (SMM) area
6Ah		Display external L2 cache size
6Bh		Load custom defaults (optional)
6Ch		Display shadow-area message
6Eh		Display possible high address for UMB recovery
70h		Display error messages
72h		Check for configuration errors
76h		Check for keyboard errors
7Ch		Set up hardware interrupt vectors
7Eh		Initialize coprocessor if present
80h		Disable onboard Super I/O ports and IRQs
81h		Late POST device initialization
82h		Detect and install external RS232 ports
83h		Configure non-MCD IDE controllers
84h		Detect and install external parallel ports
85h		Initialize PC-compatible PnP ISA devices

Code	Beeps	POST Routine Description
86h		Re-initialize onboard I/O ports.
87h		Configure Motheboard Configurable Devices (optional)
88h		Initialize BIOS Data Area
89h		Enable Non-Maskable Interrupts (NMIs)
8Ah		Initialize Extended BIOS Data Area
8Bh		Test and initialize PS/2 mouse
8Ch		Initialize floppy controller

Code	Beeps	POST Routine Description
8Fh		Determine number of ATA drives (optional)
90h		Initialize hard-disk controllers
91h		Initialize local-bus hard-disk controllers
92h		Jump to UserPatch2
93h		Build MPTABLE for multi-processor boards
95h		Install CD ROM for boot
96h		Clear huge ES segment register
97h		Fixup Multi Processor table
98h	1-2	Search for option ROMs. One long, two short beeps on checksum failure
99h		Check for SMART Drive (optional)
9Ah		Shadow option ROMs
9Ch		Set up Power Management
9Dh		Initialize security engine (optional)
9Eh		Enable hardware interrupts
9Fh		Determine number of ATA and SCSI drives
A0h		Set time of day
A2h		Check key lock
A4h		Initialize Typematic rate
A8h		Erase F2 prompt
AAh		Scan for F2 key stroke
ACh		Enter SETUP
A Eh		Clear Boot flag
B0h		Check for errors
B2h		POST done - prepare to boot operating system
B4h	1	One short beep before boot
B5h		Terminate QuietBoot (optional)
B6h		Check password (optional)
B9h		Prepare Boot
BAh		Initialize DMI parameters
BBh		Initialize PnP Option ROMs
BCh		Clear parity checkers
BDh		Display MultiBoot menu
BEh		Clear screen (optional)

Code	Beeps	POST Routine Description
BFh		Check virus and backup reminders
C0h		Try to boot with INT 19
C1h		Initialize POST Error Manager (PEM)
C2h		Initialize error logging
C3h		Initialize error display function

Code	Beeps	POST Routine Description
C4h		Initialize system error handler
C5h		PnPnd dual CMOS (optional)
C6h		Initialize notebook docking (optional)
C7h		Initialize notebook docking late
C8h		Force check (optional)
C9h		Extended checksum (optional)
D2h		Unknown interrupt

Code	Beeps	For Boot Block in Flash ROM
E0h		Initialize the chipset
E1h		Initialize the bridge
E2h		Initialize the CPU
E3h		Initialize system timer
E4h		Initialize system I/O
E5h		Check force recovery boot
E6h		Checksum BIOS ROM
E7h		Go to BIOS
E8h		Set Huge Segment
E9h		Initialize Multi Processor
EAh		Initialize OEM special code
EBh		Initialize PIC and DMA
ECh		Initialize Memory type
EDh		Initialize Memory size
EEh		Shadow Boot Block
EFh		System memory test
F0h		Initialize interrupt vectors
F1h		Initialize Run Time Clock
F2h		Initialize video
F3h		Initialize System Management Mode
F4h	1	Output one beep before boot
F5h		Boot to Mini DOS
F6h		Clear Huge Segment
F7h		Boot to Full DOS

Jumper and Connector Locations

Top View

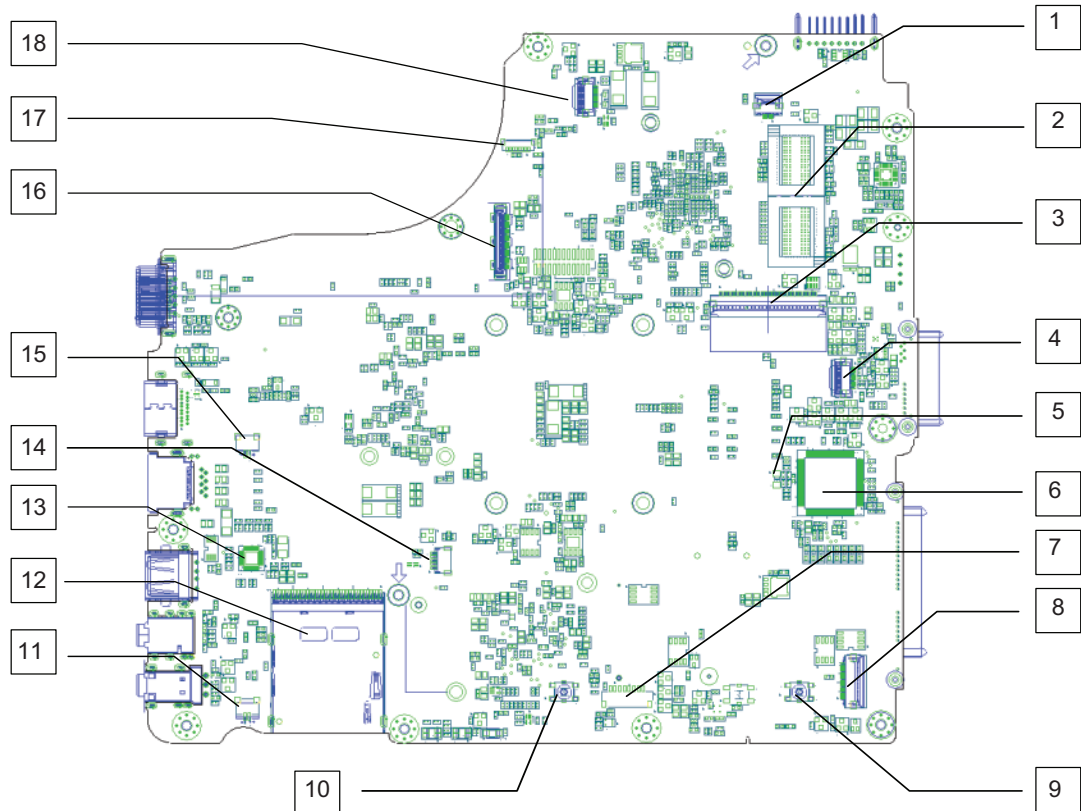

Item	Description	Item	Description
1	CN2/LED Board conn.	10	Glide PAD Left SW
2	U2,U3/Dis VRAM	11	CN13 Int. SPK. conn. (R)
3	CN6/K/B conn.	12	CN10/Card reader conn.
4	Glide PAD FFC conn.	13	U2/LAN control IC
5	Y1/KBC X'tal	14	CN9/BT wire
6	U10/EC/KBC	15	CN8/Int. SPK. conn. (L)
7	CN12/S/W TJAG DEBUG conn.	16	CN4/LCD wire
8	CNN/USB Board conn.	17	CN3/CAMERA Module conn.
9	Glide PAD Right SW	18	CN1/POWER Board conn.

Bottom View

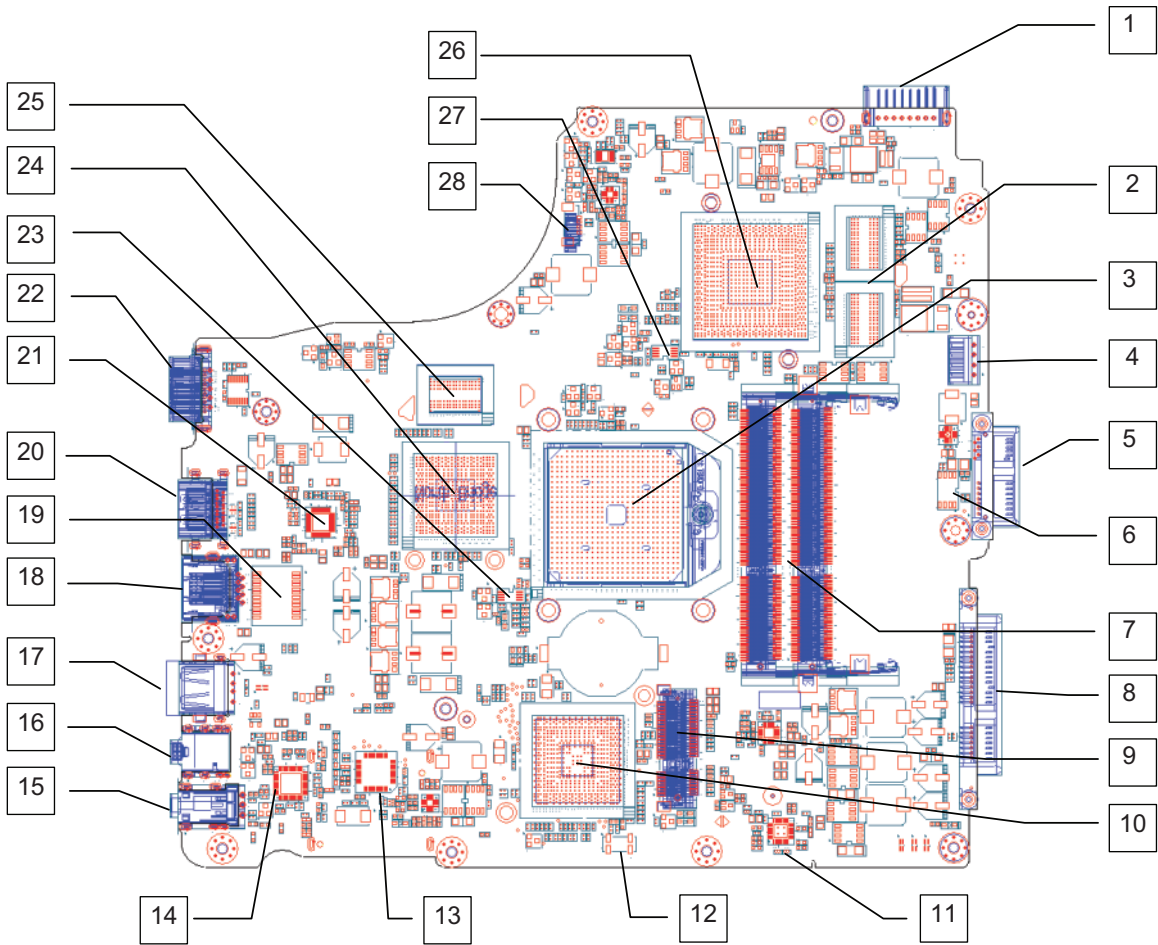

Item	Description	Item	Description
1	PJ1 Battery conn.	15	CN25/Line-out/SPDIF
2	U16/U18 Dis VRAM IC.	16	CN24/EXT Mic conn.
3	U24/CPU Socket	17	CN16/USB conn.
4	PJ2/PWR Jack conn.	18	CN9/LAN conn.
5	CN16/ODD conn.	19	U21/LAN transformer
6	U23/System BIOS	20	CN15/HDMI conn.
7	CN18, CN19/Memory DIMM	21	PU11/CPU core
8	CN22/HDD conn.	22	CN11/CRT conn.
9	CN23/Mini card conn.	23	U25/CPU thermal IC
10	U29/SB Chip	24	U28/N.B.
11	PU14/3V/5V PWM IC	25	U39/Sideport Memory
12	Y8/S.B. X'tal	26	U10/Park VGA IC
13	U18 Card Reader IC	27	U39/Sideport Memory
14	U31/Codec IC	28	CN14 FAN conn.

Clearing Password Check and BIOS Recovery

This section provides you with the standard operating procedures of clearing password and BIOS recovery for the Aspire 4625/4625G. The machine provides one Hardware Open Gap on main board for clearing password check, and one Hotkey for enabling BIOS Recovery.

Clearing Password Check

Steps for Clearing BIOS Password Check

If users set BIOS Password (Supervisor Password and/or User Password) for a security reason, BIOS will ask the password during systems POST or when systems enter to BIOS Setup menu. However, once it is necessary to bypass the password check, users need to short the HW Gap to clear the password by the following steps:

1. Power Off the system, and remove HDD, AC and Battery from the machine.
2. Remove the RTC Battery cable and locate the R671/R675 jumper.
3. Use an electric conductivity tool to short the two points of the HW Gap.
4. Plug in AC, keeping the HW Gap shorted. Press Power Button until BIOS POST is finished, then remove the tool from the HW Gap.
5. Restart the system. Press **F2** key to enter BIOS Setup menu.
6. If there is no Password request, BIOS Password is cleared. Otherwise, please follow the steps and try again.

NOTE: These steps are only for clearing BIOS Password (Supervisor Password and User Password).

Clear CMOS Jumper

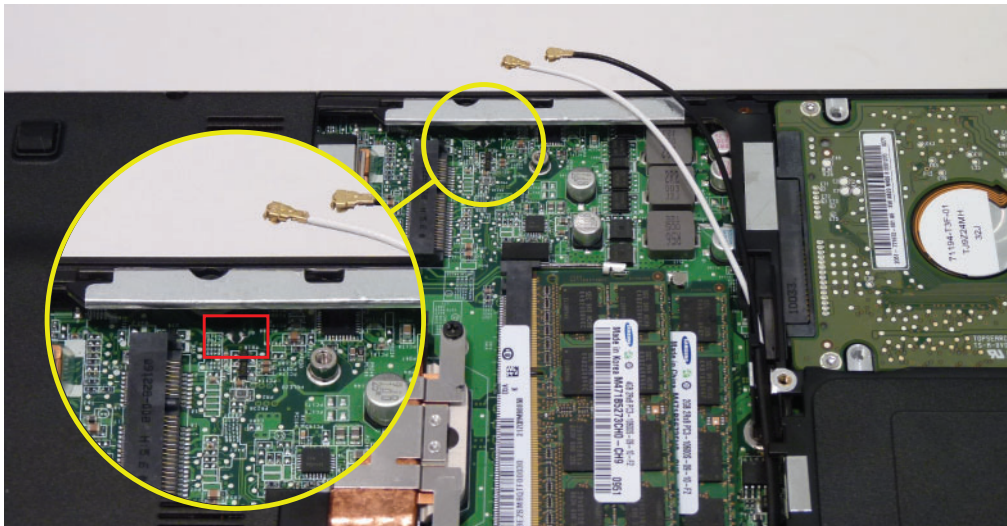

Item	Description
G1	Clear CMOS Jumper

BIOS Recovery by Crisis Disk

BIOS Recovery Boot Block:

BIOS Recovery Boot Block is a special block of BIOS. It is used to boot up the system with minimum BIOS initialization. Users can enable this feature to restore the BIOS firmware to a successful one once the previous BIOS flashing process failed.

BIOS Recovery Hotkey:

The system provides a function hotkey: **Fn+Esc**, to enable the BIOS Recovery process when the system is powered on during BIOS POST. To use this function, it is strongly recommended to have the AC adapter and Battery present. If this function is enabled, the system will force the BIOS to enter a special BIOS block, called Boot Block.

Steps for BIOS Recovery from USB Storage:

Before doing this, prepare the Crisis USB key. The Crisis USB key could be made by executing the Crisis Disk program in another system with Windows 7 OS.

Follow the steps below:

1. Insert a USB stick/floppy.
2. Execute WINCRIS.exe and click **Start** to create the crisis disk.

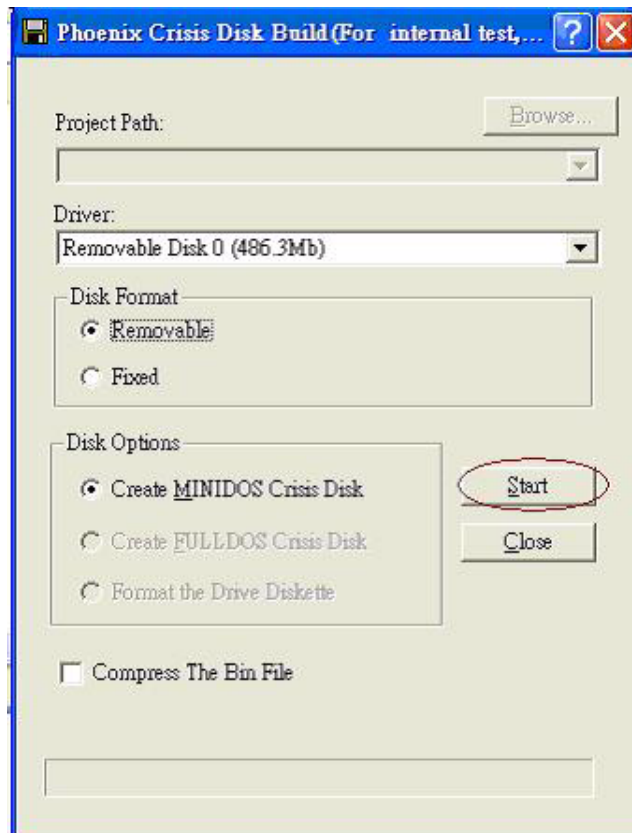

3. Plug USB storage into USB port of the system that needs to be rescued.
4. Press **Fn + ESC** and the power button to power on the system.
5. The system will go into crisis mode and recover BIOS.

FRU (Field Replaceable Unit) List

This chapter gives you the FRU (Field Replaceable Unit) listing in global configurations of Aspire 4625/4625G. Refer to this chapter whenever ordering for parts to repair or for RMA (Return Merchandise Authorization).

Please note that WHEN ORDERING FRU PARTS, you should check the most up-to-date information available on your regional web or channel. For whatever reasons a part number change is made, it will not be noted on the printed Service Guide. For ACER AUTHORIZED SERVICE PROVIDERS, your Acer office may have a DIFFERENT part number code from those given in the FRU list of this printed Service Guide. You MUST use the local FRU list provided by your regional Acer office to order FRU parts for repair and service of customer machines.

NOTE: To scrap or to return the defective parts, you should follow the local government ordinance or regulations on how to dispose it properly, or follow the rules set by your regional Acer office on how to return it.

Aspire 4625/4625G Exploded Diagrams

LCD Assembly

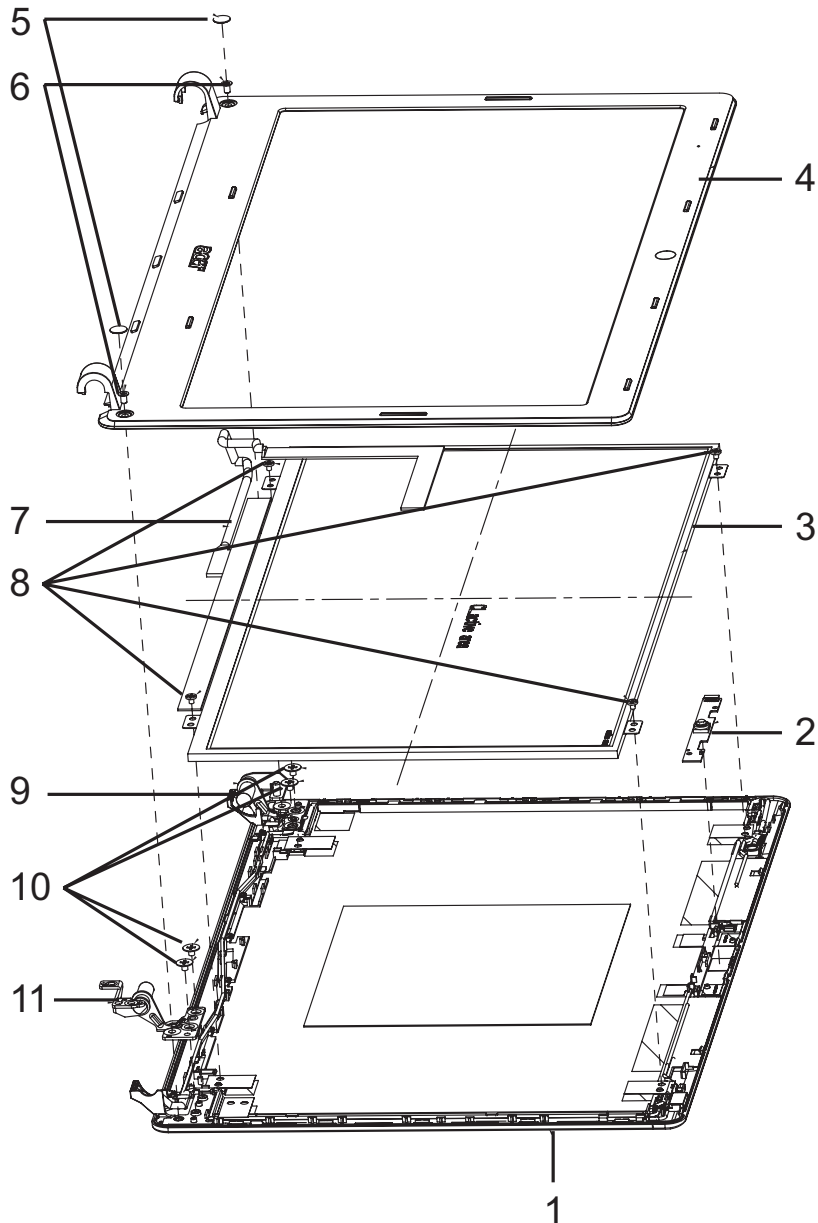

No.	Description	Acer P/N	No.	Description	Acer P/N
1	ZQ1 LCD COVER SUB ASSY (AL/3G)	60.PSR07.003	7	CABLE ASSY ZQ1LCD(19V,40/30P,WXGA,1A)FOX	50.PSR07.002
2	CAMERA CNF915721004970LH(CMOS, 1.3M, SXGA)	AM.21400.067	8	SCREW M2.0*3.0-I(BKAG)(NYLOK) IRON	86.ARE07.002
3	LCD AUO 14" WXGA	LK.14005.011	9	HINGE L SZS ZQ1	33.PSR07.002

No.	Description	Acer P/N	No.	Description	Acer P/N
4	ZQ1 LCD BEZEL SUB ASSY	60.PSR07.004	10	SCREW M2.5*3.0(ZN)(NYLOK) IRON T=0.5'	86.PSR07.002
5	LCD SCREW MYLAR ZQ1	47.PSR07.004	11	HINGE R SZS ZQ1	33.PSR07.003
6	SCREW M2.5*3.0-I(ZN)(NYLOK)IRON T=0.5	86.PSR07.003			

Chassis Assembly

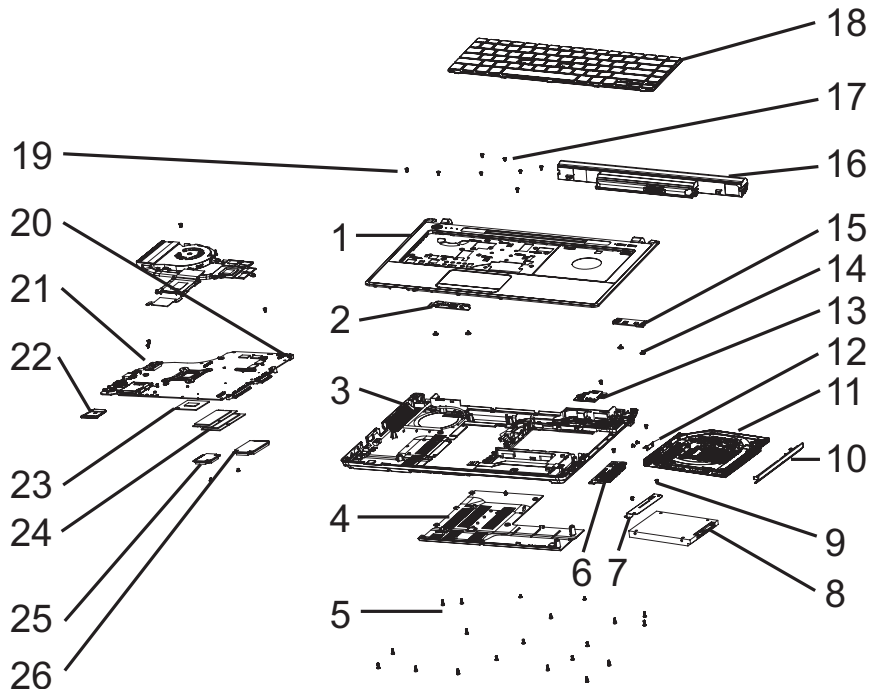





No.	Description	Acer P/N	No.	Description	Acer P/N
1	ZQ1 TOP SUB ASSY	60.PSR07.001	15	PCB ZQ1 SW/ B(4L,44*14,REVD)	
2	PCB ZQ1 POWER SW/ B(4L,59*22,REVD)	55.PSR07.001	16	BATT LI,AS10B6E 3S2P 6.0A(B) STN BSQ	BT.00606.007
3	ZQ1 BASE SUB ASSY (JM/65W)	60.PSR07.002	17	SCREW M2.0*3.0-I(BKAG)(NYLOK) IRON	86.ARE07.002
4	ZQ1 BASE DOOR ASSY (JM/CP)	42.PSR07.001	18	K/ B(UI)ZQ1(AEZQ1R00, 3A)API	
5	SCREW M2.5*6.5-I(BZN)(NYLOK-RED)D4.4 T0.8	86.ARE07.001	14	SCREW M2.5*2-I (NI,NYLOK)IRON	86.EDM07.002
6	ZQ1 USB/B ASSY	55.PSR07.002	19	SCREW M2.5*4.0-I(BKAG)(NYLOK)IRO N	86.PSR07.001

No.	Description	Acer P/N	No.	Description	Acer P/N
7	HDD-BKT ZR6(FBZR6004,REV 3A)	33.EDM07.001	20	ZQ1 MB(SG,PARK,SAM,BT ,WO CPU)ASSY	
8	HDD(160G)WD1600 BEVT-22A23T0 STN BSQ	KH.16008.027	21	WWAN MINICARD EM770W FW:11.126.07.02.00	
9	33ZQ1UB0000		22	CARD READER DUMMY CARD ZR7(EBZR7009,R3A)	42.PSR07.002
10	3GZR7CRTN10		23	CPU(988P)I5-520M 2.4G SLBNB(PGA)STN BSQ	KC.54001.DMP
11	DVD/RW/RAM TS- U633F F/W:AC00 STN BSQ	KU.0080E.027	24	RAM(2GB)DDR3 EBJ21UE8BDS0-AE-F STN BSQ	KN.2GB09.006
12	ODD BKT ZQ1(FBZQ1016,RE V3A)	33.PSR07.001	25	W/L 802.11BGN 112BN.HMWG 1X2 STN BSQ	NI.23600.047
13	ZQ1 3G/B ASSY	55.PSR07.004	26	WWAN MINICARD EM770W FW:11.126.07.02.00	



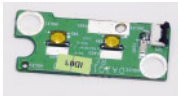

FRU List



Category	Partname	Description	P/N
Adapter			
	Adapter DELTA 65W 19V 1.7x5.5x11 Yellow ADP-65JH DB A, LV5 LED LF	Z06 ADP 19V 3.42A ADP-65JH DBA S.P	AP.06501.026
	Adapter LITE-ON 65W 19V 1.7x5.5x11 Yellow PA-1650-22AC LV5 LED LF	Z06 ADP 19V 3.42A PA-1650-22 AC S.P	AP.06503.024
	Adapter HIPRO 65W 19V 1.7x5.5x11 Yellow HP-A0652R3B 1LF, LV5 LED LF	Z06 ADP 19V 3.42AHP- A0652R3B1LF S.P	AP.0650A.012
	Adapter DELTA 90W 19V 1.7x5.5x11 Blue ADP-90CD DB A, LV5 LED LF	ZK6 ADP 19V 4.74A ADP-90CD DBA S.P	AP.09001.027
	Adapter LITE-ON 90W 19V 1.7x5.5x11 Blue PA-1900-34AR, LV5 LED LF	ZK6 ADP 19V 4.74A PA-1900-34AR S.P	AP.09003.021
	Adapter HIPRO 90W 19V 1.7x5.5x11 Blue HP-A0904A3 B1LF, LV5 LED LF	ZK6 ADP 19V 4.74AHP- A0904A3B1LF S.P	AP.0900A.005
	Adapter DELTA 65W 19V 1.7x5.5x11 Yellow ADP-65VH BA, LV5, Low profile LED LF	ZQ2B ADP 19V 3.42A ADP-65VH BA 90~264VS.P	AP.06501.033
	Adapter Chicony Power 65W 19V 1.7x5.5x11 Yellow CPA09- A065N1, LV5, low profile LED LF	ZQ2B ADP 19V 3.42A,CPA09- A065N1 90~264VS.P	AP.0650A.017
	Adapter LITE-ON 65W 19V 1.7x5.5x11 Yellow PA-1650- 69AW, LV5, Low profile LED LF	ZQ2B ADP 19V 3.42A PA-1650- 69AW 90~264VS.P	AP.06503.029
Battery			
	Battery PANASONIC AS10B Li-Ion 3S2P PANASONIC 6 cell 6000mAh Main COMMON ID:AS10B5E	ZQ1 BATT LI,AS10B5E 3S2P 6.0A(B) S.P	BT.00605.063
	Battery SAMSUNG AS10B Li-Ion 3S2P SAMSUNG 6 cell 6000mAh Main COMMON ID:AS10B6E	ZQ1 BATT LI,AS10B6E 3S2P 6.0A(B) S.P	BT.00606.009
	Battery SIMPLO AS10B Li-Ion 3S2P SAMSUNG 6 cell 6000mAh Main COMMON ID:AS10B7E	ZQ1 BATT LI,AS10B7E 3S2P 6.0A(B) S.P	BT.00607.128
	Battery SIMPLO AS10E Li-Ion 3S3P SAMSUNG 9 cell 9000mAh Main COMMON ID:AS10E7E	ZQ2B BATT LI,AS10E7E 3S3P 9.0A(B)S.P	BT.00907.013
	Battery SANYO AS10B Li-Ion 3S2P SANYO 6 cell 6000mAh Main COMMON ID: AS10B3E	ZQ2B BATT LI,AS10B3E 3S2P 6.0A (B)S.P	BT.00603.116

Category	Partname	Description	P/N
Board			
	Foxconn Wireless LAN Atheros HB93 2x2 BGN (HM)	ZY6 W/L 802.11 B/G/N H MINI(T77H047.31) S.P	NI.23600.062
	TBD	ZQ2 W/L MINICARD 802.11BGN(T77H167.07)S.P	TBD
	Foxconn Wireless LAN Atheros HB95BG (HM) T77H121.10	ZQ2 W/L MINICARD 802.11BG(T77H121.10)S.P	NI.23600.077
	Foxconn Wireless LAN Broadcomm 43225 2x2 BGN (HM) T77H103.00	ZQ2 W/L 802.11 B/G/N T77H103.00S.P	NI.23600.066
	USB MODEM	ZR7 USB MODEM,D-1156UA9B S.P	54.PSH07.001
	Foxconn Bluetooth FOX BRM 2046 BT2.1	ZY9 BLUETOOTH T60H928.33 S.P	BH.21100.004
	BLUETOOTH MODULE MT77H056.00	ZQ1 BLUETOOTH MODULE MT77H056.00 S.P	TBD
	POWER SWITCH BOARD	ZQ1 POWER SW/B S.P	55.PSR07.001
	USB BOARD	ZQ1 USB/B S.P	55.PSR07.002
	FUNCTION BOARD	ZQ1 SW/B S.P	55.PSR07.003
Cables			
	PWR CORD V943B30001218008 DANISH 3P	ZR1 PWR CORD V943B30001218008 DANISH S/P	27.A03V7.006
	PWR CORD(ISR)1.8M 3PBLK FZ010008-038	ZR1 PWR CORD(ISR)1.8M 3PBLK S/P	27.TATV7.005
	PWR CORD V50CB3T3012180QD TW-110V,3P	ZR1 PWR CORD V50CB3T3012180QD TW S/P	27.A99V7.002
	POWER CORD(SWI)1.8M 3PBLACK FZ010008-011	ZR1 POWER CORD(SWI)1.8M 3PBLACK S/P	27.A99V7.004
	POWER CORD(IT) 1.8M 3PBLACK FZ010008-008	ZR1 POWER CORD(IT) 1.8M 3P S/P	27.A99V7.005
	POWER CORD(S.A) 1.8M 3BLACK FZ010008-006	ZR1 POWER CORD(S.A) 1.8M 3BLACK S/P	27.T48V7.001

Category	Partname	Description	P/N
	POWER CORD US 3PIN ROHS	ZB1 PWR CORD US S/P	27.TAXV7.001
	POWER CORD(EU) 1.8M 3PBLACK FM010008-010	ZR1 POWER CORD(EU) 1.8M 3PBLACK S/P	27.TATV7.001
	POWER CORD BRAZIL IMETRO 3 PIN	BL3 POWER CORD BRAZIL 3P S/P	27.S0607.001
	POWER CORD UK 3PIN	ET2S POWER CORD S/P-UK	27.A03V7.004
	POWER CORD ITALIAN 3PIN	EI2 POWER CORD 3P ITALY S.P.	27.A99V7.005
	POWER CORD PRC 3P Y536B30001218008	EW1 POWER CORD S.P. (CHINESE)	27.TATV7.004
	BLUETOOTH CABLE	ZQ1 BLUETOOTH CABLE ASSY(5P/8P,1A)S.P	50.PSR07.001
	DC-IN CABLE 90W	ZQ1 DC-IN CABLE 90W(4P/4P,1A)19V S.P	50.PSR07.006
	DC-IN CABLE 65W	ZQ1 DC-IN CABLE 65W(4P/4P,1A)19V S.P	50.PSR07.005
	FFC CABLE - MB TO POWER/B IN UPPER CASE	ZQ1 CABLE FFC POWER (118MM,12P,1A)3V S.P	50.PSR07.007
	FFC CABLE - MB TO TP IN UPPER CASE	ZQ1 CABLE FFC TP (110MM,12P,1A)3V S.P	50.PSR07.008
	FFC CABLE - MB TO FUNC/B IN UPPER CASE	ZQ1 CABLE FFC FUNC (150MM,6P,1A)3V S.P	50.PSR07.009
		ZQ1 CABLE FFC-MB-USB(146MM, 20P,3A)3V S.P	
		CABLE ASSY MIC(5P/8P,1A)3.3V	

Category	Partname	Description	P/N
Case/Cover/Bracket/Assembly			
	UPPER CASE(W/FFC*3,TP,TP BD,SPK-L)	ZQ2B TOP SUB ASSY (JM)S.P	60.PSH07.001
	UPPER CASE(W/FFC*3,TP,TP BD,SPK-L) W/O TIMELINE LOGO	ZQ2B TOP SUB ASSY (JM)CN S.P	60.PSH07.002
	LOWER CASE(W/DC JACK,USB CABLE,SPK-R,FOR 65W)	ZQ2B BASE SUB ASSY(JM/65W/ WO3G)S.P	60.PSS07.001
	LOWER CASE(W/DC JACK,USB CABLE,SPK-R,FOR 90W)	ZQ2B BASE SUB ASSY(JM/90W/ WO3G)S.P	60.PSH07.003
	BASE COVER	ZQ2B BASE DOOR ASSY (JM/DN)S.P	42.PSH07.001
	DUMMY CARD	ZQ1 READER DUMMY CARD S.P	42.PSR07.002
CPU/Processor			
	CPU AMD AthlonII N330 2.3G 1M 35W Dual-Core	ZQ2 CPU(638P)AMN330 DCR22GM 2.3G(PGA)S.P	KC.AN002.330
	CPU AMD TurionII N530 2.5G 2M 35W Dual-Core	ZQ2 CPU(638P)TMN530 DCR23GM 2.5G(PGA)S.P	KC.TN002.530
	CPU AMD PhenomII N830 2.1G 35W 1.5M L2, Triple-Core	ZQ2 CPU(638P)HMN830 DCR32GM 2.1G(PGA)S.P	KC.PN002.830
	CPU AMD PhenomII N930 2.0G 2M 35W Quad-Core	ZQ2 CPU(638P)HMN930 DCR42GM 2.0G(PGA)S.P	KC.PN002.930
	CPU AMD PhenomII P820 1.8G 25W 1.5M L2, Triple-Core	ZQ2B CPU(638P)HMP820 SGR32GM 1.8G(PGA)S.P	KC.PP002.820
	CPU AMD PhenomII P920 1.6G 2M 25W Quad-Core	ZQ2B CPU(638P)HMP920 SGR42GM 1.6G(PGA)S.P	KC.PP002.920
	CPU AMD AthlonII P320 2.1G 1M 25W Dual-Core	ZQ2 CPU(638P)AMP320 SGR22GM 2.1G(PGA)S.P	KC.AP002.320
	CPU AMD TurionII P520 2.3G 2M 25W Dual-Core	ZQ2 CPU(638P)TMP520 SGR23GM 2.3G(PGA)S.P	KC.TP002.520

Category	Partname	Description	P/N
DVD RW Drive			
	DVD/RW SUPER MULTI 9.5MM MODULE	SM 9.5mm (JM) Module	6M.PSH07.001
	ODD TOSHIBA Super-Multi DRIVE 9.5mm Tray DL 8X TS-U633F LF W/O bezel SATA (HF + Windows 7)	ZQ1B DVD/RW/ RAM TS-U633F F/ W:AC00 S.P	KU.00801.034
	ODD PANASONIC Super-Multi DRIVE 9.5mm Tray DL 8X UJ892 LF W/O bezel SATA GBAS2.0, (HF + Windows7)	ZQ1B DVD+/-RW/ RAM UJ892ABAA-M S.P	KU.00807.068
	ODD HLDS Super-Multi DRIVE 9.5mm Tray DL 8X GU10N LF W/O bezel SATA (HF + Windows 7)	ZQ1B DVD+/-RW/ RAM GU10N S.P	KU.0080D.049
	ODD BEZEL - 9.5mm SUPER MULTI	ZR7 ODD BEZEL SUPER MULTI S.P	42.PSN07.002
	ODD BRACKET	ZQ1 ODD BKT (FBZQ1016,REV3A) S.P	33.PSR07.001
HDD/Hard Disk Drive			
	HDD WD 2.5" 5400rpm 160GB WD1600BEVT-22A23T0 , WD, ML320S SATA 8MB LF F/ W:01.01A01	ZQ1 HDD(160G)WD1600 BEVT-22A23T0 S.P	KH.16008.027
	HDD SEAGATE 2.5" 5400rpm 160GB ST9160314AS Wyatt SATA LF F/W:0001SDM1	ZH7 HDD(160G)ST9160 314AS 9HH13C-188 STN BSQ	KH.16001.042
	HDD TOSHIBA 2.5" 5400rpm 160GB MK1665GSX, Capricorn BS, 320G/P SATA 8MB LF F/ W:GJ001J	ZQ1 HDD(160G) MK1665GSX-EUL S.P	KH.16004.008
	HDD HGST 2.5" 5400rpm 160GB HTS545016B9A300 Panther B SATA LF F/W:C60F Disk imbalance criteria = 0.014g-cm	ZH7 HDD(160G) HTS545016B9A300 S.P	KH.16007.026
	HDD WD 2.5" 5400rpm 250GB WD2500BEVT-22A23T0, WD, ML320S SATA 8MB LF F/ W:01.01A01.	ZQ1 HDD(250G)WD2500 BEVT-22A23T0 S.P	KH.25008.025
	HDD SEAGATE 2.5" 5400rpm 250GB ST9250315AS Wyatt SATA LF F/W:0001SDM1	Z06 HDD(250G)ST9250 315AS 9HH132-188 S.P	KH.25001.016
	HDD TOSHIBA 2.5" 5400rpm 250GB MK2565GSX, Capricorn BS, 320G/P SATA 8MB LF F/ W:GJ001J	ZQ1 HDD(250G) MK2565GSX-EUL S.P	KH.25004.005

Category	Partname	Description	P/N
	HDD HGST 2.5" 5400rpm 250GB HTS545025B9A300 Panther B SATA LF F/W:C60F Disk imbalance criteria = 0.014g-cm	ZH7 HDD(250G)HTS545 025B9A300 S.P	KH.25007.016
	HDD WD 2.5" 5400rpm 320GB WD3200BEVT- 22A23T0,ML320S,WD SATA 8MB LF F/W:01.01A01	ZQ1 HDD(320G)WD3200 BEVT-22A23T0 S.P	KH.32008.019
	HDD SEAGATE 2.5" 5400rpm 320GB ST9320325AS Wyatt SATA LF F/W:0001SDM1	ZH7 HDD(320G)ST9320 325AS 9HH13E-188 S.P	KH.32001.017
	HDD TOSHIBA 2.5" 5400rpm 320GB Capricorn BS ,MK3265GSX SATA 8MB LF F/ W:GJ001J	ZQ1 HDD(320G) MK3265GSX-EUL S.P	KH.32004.004
	HDD HGST 2.5" 5400rpm 320GB HTS545032B9A300 Panther B SATA LF F/W:C60F Disk imbalance criteria = 0.014g-cm	ZH7 HDD(320G) HTS545032B9A300 S.P	KH.32007.008
	HDD WD 2.5" 5400rpm 500GB WD5000BEVT-22A0RT0, ML320M,WD SATA 8MB LF F/ W:01.01A01	ZQ1 HDD(500G)WD5000 BEVT-22A0RT0 S.P	KH.50008.017
	HDD SEAGATE 2.5" 5400rpm 500GB ST9500325AS Wyatt SATA LF F/W:0001SDM1	ZK2 HDD(500G) ST9500325AS S.P	KH.50001.011
	HDD TOSHIBA 2.5" 5400rpm 500GB MK5065GSX,Capricorn BS, 320G/P SATA 8MB LF F/ W:GJ001J	ZQ1 HDD(500G) MK5065GSX-EUL S.P	KH.50004.002
	HDD HGST 2.5" 5400rpm 500GB HTS545050B9A300 Panther B SATA LF F/W:C60F Disk imbalance criteria = 0.014g-cm	ZH7 HDD(500G) HTS545050B9A300 S.P	KH.50007.010
	HDD WD 2.5" 5400rpm 640GB WD6400BEVT-22A0RT0, ML320 SATA 8MB LF F/W:01.01A01	ZY9 HDD(640G)WD64 00BEVT-22A0RT0 S.P	KH.64008.004
		ZQ2 HDD (640G) MK6465GSX- EULS.P	
	HDD BRACKET	ZR6 HDD-BKT S.P	33.EDM07.001

Category	Partname	Description	P/N
Keyboard			
	Keyboard ACER AC4T_A10B AC4T 86KS Black Arabic Texture	ZQ1 K/B(ARAB-EN) S.P	KB.I140A.204
	Keyboard ACER AC4T_A10B AC4T 87KS Black Belgium Texture	ZQ1 K/B(BELGIUM) S.P	KB.I140A.205
	Keyboard ACER AC4T_A10B AC4T 87KS Black Brazilian Portuguese Texture	ZQ1 K/B(BRAZIL) S.P	KB.I140A.206
	Keyboard ACER AC4T_A10B AC4T 87KS Black CZ/SK Texture	ZQ1 K/B(CZ- SLOVAK) S.P	KB.I140A.207
	Keyboard ACER AC4T_A10B AC4T 86KS Black Chinese Texture	ZQ1 K/B(TAIWAN) S.P	KB.I140A.208
	Keyboard ACER AC4T_A10B AC4T 87KS Black Danish Texture	ZQ1 K/B(DANISH) S.P	KB.I140A.209
	Keyboard ACER AC4T_A10B AC4T 87KS Black FR/Arabic Texture	ZQ1 K/B(ARAB-FR) S.P	KB.I140A.210
	Keyboard ACER AC4T_A10B AC4T 87KS Black French Texture	ZQ1 K/B(FRENCH) S.P	KB.I140A.211
	Keyboard ACER AC4T_A10B AC4T 87KS Black German Texture	ZQ1 K/B(GERMAN) S.P	KB.I140A.212
	Keyboard ACER AC4T_A10B AC4T 86KS Black Greek Texture	ZQ1 K/B(GREEK) S.P	KB.I140A.213
	Keyboard ACER AC4T_A10B AC4T 87KS Black Hungarian Texture	ZQ1 K/ B(HUNGARIAN) S.P	KB.I140A.214
	Keyboard ACER AC4T_A10B AC4T 87KS Black Italian Texture	ZQ1 K/B(ITALIAN) S.P	KB.I140A.215
	Keyboard ACER AC4T_A10B AC4T 91KS Black Japanese Texture	ZQ1 K/B(JAPAN) S.P	KB.I140A.216
	Keyboard ACER AC4T_A10B AC4T 86KS Black Korean Texture	ZQ1 K/B(KOREA) S.P	KB.I140A.217
	Keyboard ACER AC4T_A10B AC4T 87KS Black Nordic Texture	ZQ1 K/B(NORDICS) S.P	KB.I140A.218
	Keyboard ACER AC4T_A10B AC4T 87KS Black Norwegian Texture	ZQ1 K/ B(NORWEGIAN) S.P	KB.I140A.219
	Keyboard ACER AC4T_A10B AC4T 87KS Black Portuguese Texture	ZQ1 K/ B(PORTUGUESE) S.P	KB.I140A.220
	Keyboard ACER AC4T_A10B AC4T 86KS Black Russian Texture	ZQ1 K/B(RUSSIAN) S.P	KB.I140A.221
	Keyboard ACER AC4T_A10B AC4T 87KS Black SLO/CRO Texture	ZQ1 K/ B(CROATIAN) S.P	KB.I140A.222

Category	Partname	Description	P/N
	Keyboard ACER AC4T_A10B AC4T 87KS Black Spanish Texture	ZQ1 K/B(SPANISH) S.P	KB.I140A.223
	Keyboard ACER AC4T_A10B AC4T 87KS Black Sweden Texture	ZQ1 K/B(SWEDISH) S.P	KB.I140A.224
	Keyboard ACER AC4T_A10B AC4T 87KS Black Swiss/G Texture	ZQ1 K/B(SWISS) S.P	KB.I140A.225
	Keyboard ACER AC4T_A10B AC4T 86KS Black Thailand Texture	ZQ1 K/B(THAI) S.P	KB.I140A.226
	Keyboard ACER AC4T_A10B AC4T 87KS Black Turkish Texture	ZQ1 K/B(TURKISH) S.P	KB.I140A.227
	Keyboard ACER AC4T_A10B AC4T 87KS Black UK Texture	ZQ1 K/B(UK) S.P	KB.I140A.228
	Keyboard ACER AC4T_A10B AC4T 86KS Black US International Texture	ZQ1 K/B(UI) S.P	KB.I140A.229
	Keyboard ACER AC4T_A10B AC4T 86KS Black US International w/ Hebrew Texture	ZQ1 K/B(HEBREW) S.P	KB.I140A.230
	Keyboard ACER AC4T_A10B AC4T 87KS Black US w/ Canadian French Texture	ZQ1 K/B(US-FR- CAN) S.P	KB.I140A.231
		ZQ1 K/B(CHINA) S.P	
		ZQ1 K/B(SLOVAK) S.P	
		ZQ1 K/B(CZECH) S.P	
		ZQ1 K/B(POLAND) S.P	
		ZQ1 K/B(DUTCH) S.P	
	ZQ1 K/B(FRA-CAN) S.P		
	ZQ1 K/B(LATIN) S.P		
	ZQ1 K/B(US)S.P		
	ZQ1 K/B(ICELAND) S.P		

Category	Partname	Description	P/N
LCD Module			
	LCD MODULE ASSY AL W/ MIC,CCD CABLE,WLAN ANTENNA*2 FOR NON-3G	LCD AL/WO 3G JM	6M.PSH07.002
	LED LCD AUO 14" WXGA Glare B140XW03 V0 LF 200nit 8ms 500:1 (Power saving)	ZQ1 LCD 14" HD B140XW03 V0 (0A) S.P	LK.14005.011
	LED LCD LPL 14" WXGA Glare LP140WH2-TLL1 LF 200nit 16ms 500:1 (Power saving)	ZQ1 LCD 14" HD LP140WH2-TLL1 S.P	LK.14008.006
	LED LCD CMO 14" WXGA Glare N140B6-L24 LF 200nit 8ms 650:1 (Power saving)	ZQ1 LCD 14" HD N140B6-L24 S.P	LK.1400D.007
	LED LCD SAMSUNG 14" WXGA Glare LTN140AT12-A01 LF 200nit 16ms 500:1 (Power saving)	ZQ1 LCD 14" HD LTN140AT12-A01 S.P	LK.14006.012
	HINGE - L	ZQ1 HINGE L (FBZQ1006,REV3A) S.P	33.PSR07.002
	HINGE - R	ZQ1 HINGE R (FBZQ1009,REV3A) S.P	33.PSR07.003
	LCD CABLE	ZQ1 LCD CABLE(19V,40/ 30P,WXGA,1A) S.P	50.PSR07.002
	LCD COVER ASSY AL W/MIC, CCD CABLE,ANTENNA*2, HINGE CAP	ZQ1B LCD COVER SUB (AL/WO3G) S.P	60.PSN07.003
	LCD BEZEL ASSY W/CCD	ZQ1 LCD BEZEL SUB S.P	60.PSR07.004
	Suyin 1.3M SY9665SN	ZQ1 CAMERA 09P2BF127 S.P	AM.21400.068
	Chicony 1.3M CH9665SN (CNF9157)	ZQ1 CAMERA CNF915721004970 LH S.P	AM.21400.067
	Liteon 1.3M LT9665AL (09P2SF119)	ZQ1 CAMERA 09P2SF119 S.P	AM.21400.069
	Liteon 1.3M LT6AASP(09P2BF127)	ZQ1 CAMERA 09P2BF127 S.P	AM.21400.070

Category	Partname	Description	P/N
Mainboard			
	MB AMD UMA W/CARD READER W/O CPU	ZQ2B MB(AMD,UMA,W/O CPU)S.P	MB.PSS06.001
	MB AMD PARK W/CARD READER W/O CPU	ZQ2B MB(AMD,PARK ,W/ O CPU)S.P	MB.PSH06.001
		ZQ2B 6L JM MB (W/ GRN,SAM,W/O CPU)ASSY	
		ZQ2B 6L JM MB (W/ GRN,W/O CPU,VRAM)ASSY	
		ZQ2B 6L JM MB (SAM,W/O CPU,GRN)ASSY	
		ZQ2B 6L JM MB (W/ O CPU,GRN,VRAM)A SSY	
		ZQ2B 6L JM MB (W/ GRN,HYU,W/O CPU)ASSY	
		ZQ2B 6L JM MB (HYU,W/O CPU,GRN)ASSY	
		ZQ2B 6L JV MB (W/ GRN,SAM,W/O CPU)ASSY	
		ZQ2B 6L JV MB (W/ GRN,W/O CPU,VRAM)ASSY	
		ZQ2B 6L JV MB (SAM,W/O CPU,GRN)ASSY	
		ZQ2B 6L JV MB (W/ O CPU,GRN,VRAM)A SSY	
		ZQ2B 6L JV MB (W/ GRN,HYU,W/O CPU)ASSY	
		ZQ2B 6L JV MB (HYU,W/O CPU,GRN)ASSY	

Category	Partname	Description	P/N
Memory			
	Memory ELPIDA SO-DIMM DDRIII 1066 1GB EBJ10UE8BDS0-AE-F LF 128*8 0.065um	ZE8 RAM(1GB)DDR3 EBJ10UE8BDS0- AE-F S.P	KN.1GB09.012
	Memory SAMSUNG SO-DIMM DDRIII 1066 1GB M471B2873EH1-CF8 LF 64*16 0.055um	ZR6 RAM(1G)DDR3 M471B2873EH1- CF8 S.P	KN.1GB0B.028
	Memory HYNIX SO-DIMM DDRIII 1066 1GB HMT112S6BFR6C-G7 N0 LF 64*16 0.055um	ZE9 RAM(1GB)DDR3 HMT112S6BFR6C N0 LF S.P	KN.1GB0G.025
	Memory ELPIDA SO-DIMM DDRIII 1333 1GB EBJ10UE8BDS0-DJ-F LF 128*8 0.065um	ZQ1 RAM(1GB)DDR3 EBJ10UE8BDS0- DJ-F S.P	KN.1GB09.015
	Memory SAMSUNG SO-DIMM DDRIII 1333 1GB M471B2873FHS-CH9 LF 128*8 46nm	ZQ1 RAM(1GB)DDR3 M471B2873FHS- CH9 S.P	KN.1GB0B.035
	Memory ELPIDA SO-DIMM DDRIII 1066 2GB EBJ21UE8BDS0-AE-F LF 128*8 0.065um	ZE8 RAM(2GB)DDR3 EBJ21UE8BDS0- AE-F S.P	KN.2GB09.006
	Memory SAMSUNG SO-DIMM DDRIII 1066 2GB M471B5673EH1-CF8 LF 128*8 0.055um	ZR6 RAM(2GB)DDR3 M471B5673EH1- CF8 S.P	KN.2GB0B.012
	Memory HYNIX SO-DIMM DDRIII 1066 2GB HMT125S6BFR8C-G7 N0 LF 128*8 0.055um	ZK6 RAM(2GB)DDR3 HMT125S6BFR8C- G7 S,P	KN.2GB0G.014
	Memory ELPIDA SO-DIMM DDRIII 1333 2GB EBJ21UE8BDS0-DJ-F LF 128*8 0.065um	ZQ1 RAM(2GB)DDR3 EBJ21UE8BDS0- DJ-F S.P	KN.2GB09.007
	Memory ELPIDA SO-DIMM DDRIII 1333 4GB EBJ41UF8BAS0-DJ-F LF 256*8 0.055um	ZQ1 RAM(4GB)DDR3 EBJ41UF8BAS0- DJ-F S.P	KN.4GB09.001
	Memory SAMSUNG SO-DIMM DDRIII 1333 4GB M471B5273CH0-CH9 LF 256*8 46nm	ZQ2 RAM(4GB)DDR3 M471B5273CH0- CH9S.P	KN.4GB0B.010
	Memory NANYA SO-DIMM DDRIII 1333 2GB NT2GC64B8HC0NS-CG LF 128*8 0.065um	ZQ2 RAM(2GB)DDR3 NT2GC64B8HC0NS -CG S.P	KN.2GB03.017

Category	Partname	Description	P/N
Heatsink			
	THERMAL MODULE - DIS	ZQ2 THERMAL MODULE 35W DISS.P	60.PSH07.004
	THERMAL MODULE - UMA	ZQ2 THERMAL MODULE 35W UMA S.P	60.PSS07.002
	HEAT SINK	ZQ2 HEAT SINK PCH(FBZQ2005,REV3A)S.P	60.PSH07.005
	SPEAKER - L (IN UPPER CASE)	ZQ1B SPK ASSY(WITH L)S.P	23.PSH07.001
	SPEAKER - R (IN LOWER CASE)	ZQ1B SPK ASSY(WITH R)S.P	23.PSH07.002
Miscellaneous			
	HDD RUBBER - 1	ZQ1 HDD RUBBER-1 S.P	47.PSR07.008
	HDD RUBBER - 2	ZQ1 HDD RUBBER-2 S.P	47.PSR07.009
	TOP HDD RUBBER - 1	ZQ1 TOP HDD RUBBER-1 S.P	47.PSR07.010
	LOWER CASE RUBBER FOOT - F	ZQ1 BASE FOOT RUBBER F S.P	47.PSR07.001
	LOWER CASE RUBBER FOOT - M	ZQ1 BASE FOOT RUBBER M S.P	47.PSR07.002
	RUBBER FOOT - REAR	ZQ1 BASE FOOT RUBBER REAR S.P	47.PSR07.003
	BASE COVER RUBBER FOOT - 1	ZQ1 DOOR FOOT RUBBER-1 S.P	47.PSR07.006
	LCD RUBBER - 1	ZQ1 LCD RUBBER-1 S.P	47.PSR07.004
	LCD RUBBER - 2	ZQ1 LCD RUBBER-2 S.P	47.PSR07.005

Screw List

Part Name	Description	P/N
Screw		
	ZR6 SCREW M2.5*2-I (NI,NYLOK)IRON S.P	86.EDM07.002
	ZA3 SCREW M2.0*3.0-I(BKAG)(NYLOK)IRON SP	86.PSR07.003
	ZQ1 SCREW M2.5*3.0-I(ZN) T=0.5 S.P	86.PSR07.002
	TE1 SCREW M2.0*6.0-I SP	86.S6507.001
	SCREW M2.5*4.0-I(BKAG)(NYLOK)IRON	86.PSR07.001
	ZY2 SCREW M2.5*6.5-I(BZN(NYLOK-RED) S.P	86.ARE07.001
	ZY5D SCREW M3*0.5+3.5I S.P	86.N1407.007
	ZY2 SCREW M2.5*3.0-I(BZN) S.P	86.TPK07.003
	AJ2 SCREW M2-0.4*2-I(BNI)(NYLOK)IRON S.P	86.W4107.002

Model Definition and Configuration

Aspire 4625/4625G

Model	RO	Country	Acer Part No	Description
AS4625G-P922G32Mn	CHINA	China	LX.PSH0 1.001	AS4625G-P922G32Mn W7HB64SCATCN1 MC PARK_XT512Cks_3V3 1*2G/320/BT/6L3.0/5R/ cb_bgn_1.3C_AL_SC13
AS4625G-P522G50Mn	TWN	GCTWN	LX.PSH0 2.026	AS4625G-P522G50Mn W7HP64ATTW1 MC PARK_XT512Cks_3V3 1*2G/500_L/BT/6L3.0/ 5R/cb_bgn_1.3C_AL_TC11
AS4625G-P822G50Mn	TWN	GCTWN	LX.PSH0 2.025	AS4625G-P822G50Mn W7HP64ATTW1 MC PARK_XT512Cks_3V3 1*2G/500_L/BT/6L3.0/ 5R/cb_bgn_1.3C_AL_TC11
AS4625G-P922G50Mn	TWN	GCTWN	LX.PSH0 2.024	AS4625G-P922G50Mn W7HP64ATTW1 MC PARK_XT512Cks_3V3 1*2G/500_L/BT/6L3.0/ 5R/cb_bgn_1.3C_AL_TC11
AS4625G-P324G32Mn	AAP	Singapore	LX.PSH0 2.023	AS4625G-P324G32Mn W7HP64ATSG1 MC PARK_XT512Cks_3V3 2*2G/320/BT/6L3.0/5R/ cb_bgn_1.3C_AL_ZH31
AS4625G-P524G50Mn	AAP	Singapore	LX.PSH0 2.022	AS4625G-P524G50Mn W7HP64ATSG1 MC PARK_XT512Cks_3V3 2*2G/500_L/BT/6L3.0/ 5R/cb_bgn_1.3C_AL_ZH31
AS4625G-P524G32Mn	AAP	Singapore	LX.PSH0 2.021	AS4625G-P524G32Mn W7HP64ATSG1 MC PARK_XT512Cks_3V3 2*2G/320/BT/6L3.0/5R/ cb_bgn_1.3C_AL_ZH31
AS4625G-P322G32Mn	AAP	Singapore	LX.PSH0 2.020	AS4625G-P322G32Mn W7HP64ATSG1 MC PARK_XT512Cks_3V3 1*2G/320/BT/6L3.0/5R/ cb_bgn_1.3C_AL_ZH31
AS4625G-P524G64Mn	AAP	Singapore	LX.PSH0 2.019	AS4625G-P524G64Mn W7HP64ATSG1 MC PARK_XT512Cks_3V3 2*2G/640/BT/6L3.0/5R/ cb_bgn_1.3C_AL_ZH31
AS4625G-N836G64Mn	WW	WW	S2.PSH0 2.004	AS4625G-N836G64Mn W7HP64AWW1 MC PARK_XT512Cks_3V3 2G+4G/640/BT/6L3.0/5R/ cb_bgn_1.3C_AL_ES62
AS4625G-N836G64Mn	WW	WW	S2.PSH0 2.004	AS4625G-N836G64Mn W7HP64AWW1 MC PARK_XT512Cks_3V3 2G+4G/640/BT/6L3.0/5R/ cb_bgn_1.3C_AL_ES62
AS4625G-P923G32Mn	WW	WW	S2.PSH0 2.005	AS4625G-P923G32Mn W7HP64AWW1 MC PARK_XT512Cks_3V3 1G+2G/320/BT/6L3.0/5R/ cb_bgn_1.3C_AL_ES62
AS4625G-P923G32Mn	WW	WW	S2.PSH0 2.005	AS4625G-P923G32Mn W7HP64AWW1 MC PARK_XT512Cks_3V3 1G+2G/320/BT/6L3.0/5R/ cb_bgn_1.3C_AL_ES62

Model	RO	Country	Acer Part No	Description
AS4625G-N834G64Mn	AAP	Singapore	LX.PSH0 2.018	AS4625G-N834G64Mn W7HP64ATSG1 MC PARK_XT512Cks_3V3 2*2G/640/BT/6L3.0/5R/cb_bgn_1.3C_AL_ZH31
AS4625G-N834G50Mn	AAP	Singapore	LX.PSH0 2.017	AS4625G-N834G50Mn W7HP64ATSG1 MC PARK_XT512Cks_3V3 2*2G/500_L/BT/6L3.0/5R/cb_bgn_1.3C_AL_ZH31
AS4625G-N834G32Mn	AAP	Singapore	LX.PSH0 2.016	AS4625G-N834G32Mn W7HP64ATSG1 MC PARK_XT512Cks_3V3 2*2G/320/BT/6L3.0/5R/cb_bgn_1.3C_AL_ZH31
AS4625G-N536G64Mn	AAP	Singapore	LX.PSH0 2.015	AS4625G-N536G64Mn W7HP64ATSG1 MC PARK_XT512Cks_3V3 4G+2G/640/BT/6L3.0/5R/cb_bgn_1.3C_AL_ZH31
AS4625G-N534G64Mn	AAP	Singapore	LX.PSH0 2.014	AS4625G-N534G64Mn W7HP64ATSG1 MC PARK_XT512Cks_3V3 2*2G/640/BT/6L3.0/5R/cb_bgn_1.3C_AL_ZH31
AS4625G-N534G50Mn	AAP	Singapore	LX.PSH0 2.013	AS4625G-N534G50Mn W7HP64ATSG1 MC PARK_XT512Cks_3V3 2*2G/500_L/BT/6L3.0/5R/cb_bgn_1.3C_AL_ZH31
AS4625G-N534G32Mn	AAP	Singapore	LX.PSH0 2.012	AS4625G-N534G32Mn W7HP64ATSG1 MC PARK_XT512Cks_3V3 2*2G/320/BT/6L3.0/5R/cb_bgn_1.3C_AL_ZH31
AS4625G-P924G32Mn	AAP	Singapore	LX.PSH0 2.011	AS4625G-P924G32Mn W7HP64ATSG1 MC PARK_XT512Cks_3V3 2*2G/320/BT/6L3.0/5R/cb_bgn_1.3C_AL_ZH31
AS4625G-P924G50Mn	AAP	Singapore	LX.PSH0 2.010	AS4625G-P924G50Mn W7HP64ATSG1 MC PARK_XT512Cks_3V3 2*2G/500_L/BT/6L3.0/5R/cb_bgn_1.3C_AL_ZH31
AS4625G-N334G32Mn	AAP	Singapore	LX.PSH0 2.009	AS4625G-N334G32Mn W7HP64ATSG1 MC PARK_XT512Cks_3V3 2*2G/320/BT/6L3.0/5R/cb_bgn_1.3C_AL_ZH31
AS4625G-N332G32Mn	AAP	Singapore	LX.PSH0 2.008	AS4625G-N332G32Mn W7HP64ATSG1 MC PARK_XT512Cks_3V3 1*2G/320/BT/6L3.0/5R/cb_bgn_1.3C_AL_ZH31
AS4625G-P924G64Mn	AAP	Singapore	LX.PSH0 2.007	AS4625G-P924G64Mn W7HP64ATSG1 MC PARK_XT512Cks_3V3 2*2G/640/BT/6L3.0/5R/cb_bgn_1.3C_AL_ZH31
AS4625G-P824G64Mn	AAP	Singapore	LX.PSH0 2.006	AS4625G-P824G64Mn W7HP64ATSG1 MC PARK_XT512Cks_3V3 2*2G/640/BT/6L3.0/5R/cb_bgn_1.3C_AL_ZH31
AS4625G-P824G50Mn	AAP	Singapore	LX.PSH0 2.005	AS4625G-P824G50Mn W7HP64ATSG1 MC PARK_XT512Cks_3V3 2*2G/500_L/BT/6L3.0/5R/cb_bgn_1.3C_AL_ZH31
AS4625G-P824G32Mn	AAP	Singapore	LX.PSH0 2.004	AS4625G-P824G32Mn W7HP64ATSG1 MC PARK_XT512Cks_3V3 2*2G/320/BT/6L3.0/5R/cb_bgn_1.3C_AL_ZH31
AS4625G-N934G32Mn	AAP	Singapore	LX.PSH0 2.003	AS4625G-N934G32Mn W7HP64ATSG1 MC PARK_XT512Cks_3V3 2*2G/320/BT/6L3.0/5R/cb_bgn_1.3C_AL_ZH31
AS4625G-N934G50Mn	AAP	Singapore	LX.PSH0 2.002	AS4625G-N934G50Mn W7HP64ATSG1 MC PARK_XT512Cks_3V3 2*2G/500_L/BT/6L3.0/5R/cb_bgn_1.3C_AL_ZH31

Model	RO	Country	Acer Part No	Description
AS4625G-N934G64Mn	AAP	Singapore	LX.PSH0 2.001	AS4625G-N934G64Mn W7HP64ATSG1 MC PARK_XT512Cks_3V3 2*2G/640/BT/6L3.0/5R/ cb_bgn_1.3C_AL_ZH31
AS4625G-N934G50Mn	WW	WW	S2.PSH0 C.001	AS4625G-N934G50Mn LINPUSAWW1 PARK_XT512Cks_3V3 2*2G/500_L/6L3.0/5R/ cb_bgn_1.3C_AL_EN11
AS4555G-P324G32Mn	WW	WW	S2.PSH0 2.003	AS4555G-P324G32Mn W7HP64ATWW4 MC PARK_XT512Ckk_3V3 2*2G/320/6L2.2/5R/ cb_bgn_1.3C_AL_IT91
AS4555G-N532G50Mn	WW	WW	S2.PSH0 2.002	AS4555G-N532G50Mn W7HP64ATWW4 MC PARK_XT512Ckk_3V3 2*1G/500_L/6L3.0/5R/ cb_bgn_1.3C_AL_IT91
AS4555-N332G16Mn	WW	WW	S2.PSH0 2.001	AS4555-N332G16Mn W7HP64ATWW4 MC PARK_XT512Ckk_3V3 2*1G/160/6L2.2/5R/ cb_bgn_1.3C_AL_IT91
AS4625-P323G32Mn	PA	ACLA- Portuguese	LX.PSS0 2.022	AS4625-P323G32Mn EM W7HP64EMATXC3 MC UMACKs_3 2G+1G/320/6L3.0/5R/ cb_bgn_1.3C_AL_EN61
AS4625-P323G32Mn	PA	Chile	LX.PSS0 2.021	AS4625-P323G32Mn EM W7HP64EMATCL3 MC UMACKs_3 2G+1G/320/6L3.0/5R/ cb_bgn_1.3C_AL_ES51
AS4625-P323G32Mn	PA	ACLA- Spanish	LX.PSS0 2.020	AS4625-P323G32Mn EM W7HP64EMATEA4 MC UMACKs_3 2G+1G/320/6L3.0/5R/ cb_bgn_1.3C_AL_EN31
AS4625-P323G32Mn	PA	ACLA- Spanish	LX.PSS0 2.019	AS4625-P323G32Mn EM W7HP64EMATEA1 MC UMACKs_3 2G+1G/320/6L3.0/5R/ cb_bgn_1.3C_AL_ES51
AS4625-P323G32Mn	PA	ACLA- Spanish	LX.PSS0 2.018	AS4625-P323G32Mn EM W7HP64EMATEA3 MC UMACKs_3 2G+1G/320/6L3.0/5R/ cb_bgn_1.3C_AL_ES51
AS4625-P822G25Mn	WW	WW	S2.PSS0 2.003	AS4625-P822G25Mn W7HP64AWW1 MC UMACKs_3 2*1G/250/BT/6L3.0/5R/ cb_bgn_1.3C_AL_ES62
AS4625-P822G25Mn	WW	WW	S2.PSS0 2.003	AS4625-P822G25Mn W7HP64AWW1 MC UMACKs_3 2*1G/250/BT/6L3.0/5R/ cb_bgn_1.3C_AL_ES62
AS4625-N932G32Mn	AAP	Singapore	LX.PSS0 2.017	AS4625-N932G32Mn W7HP64ATSG1 MC UMACKs_3 1*2G/320/BT/6L3.0/5R/ cb_bgn_1.3C_AL_ZH31
AS4625-N834G32Mn	AAP	Singapore	LX.PSS0 2.016	AS4625-N834G32Mn W7HP64ATSG1 MC UMACKs_3 2*2G/320/BT/6L3.0/5R/ cb_bgn_1.3C_AL_ZH31
AS4625-N832G32Mn	AAP	Singapore	LX.PSS0 2.015	AS4625-N832G32Mn W7HP64ATSG1 MC UMACKs_3 1*2G/320/BT/6L3.0/5R/ cb_bgn_1.3C_AL_ZH31
AS4625-N333G32Mn	AAP	Singapore	LX.PSS0 2.014	AS4625-N333G32Mn W7HP64ATSG1 MC UMACKs_3 2G+1G/320/BT/6L3.0/5R/ cb_bgn_1.3C_AL_ZH31
AS4625-N332G32Mn	AAP	Singapore	LX.PSS0 2.013	AS4625-N332G32Mn W7HP64ATSG1 MC UMACKs_3 1*2G/320/BT/6L3.0/5R/ cb_bgn_1.3C_AL_ZH31

Model	RO	Country	Acer Part No	Description
AS4625-P924G64Mn	AAP	Singapore	LX.PSS0 2.012	AS4625-P924G64Mn W7HP64ATSG1 MC UMACKs_3 2*2G/640/BT/6L3.0/5R/ cb_bgn_1.3C_AL_ZH31
AS4625-P924G50Mn	AAP	Singapore	LX.PSS0 2.011	AS4625-P924G50Mn W7HP64ATSG1 MC UMACKs_3 2*2G/500_L/BT/6L3.0/5R/ cb_bgn_1.3C_AL_ZH31
AS4625-P924G32Mn	AAP	Singapore	LX.PSS0 2.010	AS4625-P924G32Mn W7HP64ATSG1 MC UMACKs_3 2*2G/320/BT/6L3.0/5R/ cb_bgn_1.3C_AL_ZH31
AS4625-P824G32Mn	AAP	Singapore	LX.PSS0 2.009	AS4625-P824G32Mn W7HP64ATSG1 MC UMACKs_3 2*2G/320/BT/6L3.0/5R/ cb_bgn_1.3C_AL_ZH31
AS4625-P824G50Mn	AAP	Singapore	LX.PSS0 2.008	AS4625-P824G50Mn W7HP64ATSG1 MC UMACKs_3 2*2G/500_L/BT/6L3.0/5R/ cb_bgn_1.3C_AL_ZH31
AS4625-P824G64Mn	AAP	Singapore	LX.PSS0 2.007	AS4625-P824G64Mn W7HP64ATSG1 MC UMACKs_3 2*2G/640/BT/6L3.0/5R/ cb_bgn_1.3C_AL_ZH31
AS4625-N534G32Mn	AAP	Singapore	LX.PSS0 2.006	AS4625-N534G32Mn W7HP64ATSG1 MC UMACKs_3 2*2G/320/BT/6L3.0/5R/ cb_bgn_1.3C_AL_ZH31
AS4625-N534G50Mn	AAP	Singapore	LX.PSS0 2.005	AS4625-N534G50Mn W7HP64ATSG1 MC UMACKs_3 2*2G/500_L/BT/6L3.0/5R/ cb_bgn_1.3C_AL_ZH31
AS4625-N534G64Mn	AAP	Singapore	LX.PSS0 2.004	AS4625-N534G64Mn W7HP64ATSG1 MC UMACKs_3 2*2G/640/BT/6L3.0/5R/ cb_bgn_1.3C_AL_ZH31
AS4625-N934G64Mn	AAP	Singapore	LX.PSS0 2.003	AS4625-N934G64Mn W7HP64ATSG1 MC UMACKs_3 2*2G/640/BT/6L3.0/5R/ cb_bgn_1.3C_AL_ZH31
AS4625-N934G50Mn	AAP	Singapore	LX.PSS0 2.002	AS4625-N934G50Mn W7HP64ATSG1 MC UMACKs_3 2*2G/500_L/BT/6L3.0/5R/ cb_bgn_1.3C_AL_ZH31
AS4625-N934G32Mn	AAP	Singapore	LX.PSS0 2.001	AS4625-N934G32Mn W7HP64ATSG1 MC UMACKs_3 2*2G/320/BT/6L3.0/5R/ cb_bgn_1.3C_AL_ZH31
AS4555-P922G25Mn	WW	WW	S2.PSS0 2.002	AS4555-P922G25Mn W7HP64ATWW4 MC UMACKk 2*1G/250/6L2.2/5R/ cb_bgn_1.3C_AL_IT91
AS4555-N332G16Mn	WW	WW	S2.PSS0 2.001	AS4555-N332G16Mn W7HP64ATWW4 MC UMACKk_3 1*2G/160/6L2.2/5R/ cb_bgn_1.3C_AL_IT91

Model	Country	Acer Part No	BOM Name	CPU	VGA Chip
AS4625G-P922G32Mn	China	LX.PSH01.001	AS4625G_PARK_XT512 Cks_3V3	APP920	PARK_XT
AS4625G-P522G50Mn	GCTWN	LX.PSH02.026	AS4625G_PARK_XT512 Cks_3V3	ATP520	PARK_XT
AS4625G-P822G50Mn	GCTWN	LX.PSH02.025	AS4625G_PARK_XT512 Cks_3V3	APP820	PARK_XT

Model	Country	Acer Part No	BOM Name	CPU	VGA Chip
AS4625G-P922G50Mn	GCTWN	LX.PSH02.024	AS4625G_PARK_XT512 Cks_3V3	APP920	PARK_XT
AS4625G-P324G32Mn	Singapore	LX.PSH02.023	AS4625G_PARK_XT512 Cks_3V3	AAP320	PARK_XT
AS4625G-P524G50Mn	Singapore	LX.PSH02.022	AS4625G_PARK_XT512 Cks_3V3	ATP520	PARK_XT
AS4625G-P524G32Mn	Singapore	LX.PSH02.021	AS4625G_PARK_XT512 Cks_3V3	ATP520	PARK_XT
AS4625G-P322G32Mn	Singapore	LX.PSH02.020	AS4625G_PARK_XT512 Cks_3V3	AAP320	PARK_XT
AS4625G-P524G64Mn	Singapore	LX.PSH02.019	AS4625G_PARK_XT512 Cks_3V3	ATP520	PARK_XT
AS4625G-N836G64Mn	WW	S2.PSH02.004	AS4625G_PARK_XT512 Cks_3V3	APN830	PARK_XT
AS4625G-N836G64Mn	WW	S2.PSH02.004	AS4625G_PARK_XT512 Cks_3V3	APN830	PARK_XT
AS4625G-P923G32Mn	WW	S2.PSH02.005	AS4625G_PARK_XT512 Cks_3V3	APP920	PARK_XT
AS4625G-P923G32Mn	WW	S2.PSH02.005	AS4625G_PARK_XT512 Cks_3V3	APP920	PARK_XT
AS4625G-N834G64Mn	Singapore	LX.PSH02.018	AS4625G_PARK_XT512 Cks_3V3	APN830	PARK_XT
AS4625G-N834G50Mn	Singapore	LX.PSH02.017	AS4625G_PARK_XT512 Cks_3V3	APN830	PARK_XT
AS4625G-N834G32Mn	Singapore	LX.PSH02.016	AS4625G_PARK_XT512 Cks_3V3	APN830	PARK_XT
AS4625G-N536G64Mn	Singapore	LX.PSH02.015	AS4625G_PARK_XT512 Cks_3V3	ATN530	PARK_XT
AS4625G-N534G64Mn	Singapore	LX.PSH02.014	AS4625G_PARK_XT512 Cks_3V3	ATN530	PARK_XT
AS4625G-N534G50Mn	Singapore	LX.PSH02.013	AS4625G_PARK_XT512 Cks_3V3	ATN530	PARK_XT
AS4625G-N534G32Mn	Singapore	LX.PSH02.012	AS4625G_PARK_XT512 Cks_3V3	ATN530	PARK_XT
AS4625G-P924G32Mn	Singapore	LX.PSH02.011	AS4625G_PARK_XT512 Cks_3V3	APP920	PARK_XT
AS4625G-P924G50Mn	Singapore	LX.PSH02.010	AS4625G_PARK_XT512 Cks_3V3	APP920	PARK_XT
AS4625G-N334G32Mn	Singapore	LX.PSH02.009	AS4625G_PARK_XT512 Cks_3V3	AAN330	PARK_XT
AS4625G-N332G32Mn	Singapore	LX.PSH02.008	AS4625G_PARK_XT512 Cks_3V3	AAN330	PARK_XT
AS4625G-P924G64Mn	Singapore	LX.PSH02.007	AS4625G_PARK_XT512 Cks_3V3	APP920	PARK_XT
AS4625G-P824G64Mn	Singapore	LX.PSH02.006	AS4625G_PARK_XT512 Cks_3V3	APP820	PARK_XT
AS4625G-P824G50Mn	Singapore	LX.PSH02.005	AS4625G_PARK_XT512 Cks_3V3	APP820	PARK_XT
AS4625G-P824G32Mn	Singapore	LX.PSH02.004	AS4625G_PARK_XT512 Cks_3V3	APP820	PARK_XT

Model	Country	Acer Part No	BOM Name	CPU	VGA Chip
AS4625G-N934G32Mn	Singapore	LX.PSH02.003	AS4625G_PARK_XT512 Cks_3V3	APN930	PARK_XT
AS4625G-N934G50Mn	Singapore	LX.PSH02.002	AS4625G_PARK_XT512 Cks_3V3	APN930	PARK_XT
AS4625G-N934G64Mn	Singapore	LX.PSH02.001	AS4625G_PARK_XT512 Cks_3V3	APN930	PARK_XT
AS4625G-N934G50Mn	WW	S2.PSH0C.001	AS4625G_PARK_XT512 Cks_3V3	APN930	PARK_XT
AS4555G-P324G32Mn	WW	S2.PSH02.003	AS4625G_PARK_XT512 Cks_3V3	AAP320	PARK_XT
AS4555G-N532G50Mn	WW	S2.PSH02.002	AS4625G_PARK_XT512 Cks_3V3	ATN530	PARK_XT
AS4555-N332G16Mn	WW	S2.PSH02.001	AS4625G_PARK_XT512 Cks_3V3	AAN330	PARK_XT
AS4625-P323G32Mn	ACLA-Portuguese	LX.PSS02.022	AS4625_UMACks_3	AAP320	UMA
AS4625-P323G32Mn	Chile	LX.PSS02.021	AS4625_UMACks_3	AAP320	UMA
AS4625-P323G32Mn	ACLA-Spanish	LX.PSS02.020	AS4625_UMACks_3	AAP320	UMA
AS4625-P323G32Mn	ACLA-Spanish	LX.PSS02.019	AS4625_UMACks_3	AAP320	UMA
AS4625-P323G32Mn	ACLA-Spanish	LX.PSS02.018	AS4625_UMACks_3	AAP320	UMA
AS4625-P822G25Mn	WW	S2.PSS02.003	AS4625_UMACks_3	APP820	UMA
AS4625-P822G25Mn	WW	S2.PSS02.003	AS4625_UMACks_3	APP820	UMA
AS4625-N932G32Mn	Singapore	LX.PSS02.017	AS4625_UMACks_3	APN930	UMA
AS4625-N834G32Mn	Singapore	LX.PSS02.016	AS4625_UMACks_3	APN830	UMA
AS4625-N832G32Mn	Singapore	LX.PSS02.015	AS4625_UMACks_3	APN830	UMA
AS4625-N333G32Mn	Singapore	LX.PSS02.014	AS4625_UMACks_3	AAN330	UMA
AS4625-N332G32Mn	Singapore	LX.PSS02.013	AS4625_UMACks_3	AAN330	UMA
AS4625-P924G64Mn	Singapore	LX.PSS02.012	AS4625_UMACks_3	APP920	UMA
AS4625-P924G50Mn	Singapore	LX.PSS02.011	AS4625_UMACks_3	APP920	UMA
AS4625-P924G32Mn	Singapore	LX.PSS02.010	AS4625_UMACks_3	APP920	UMA
AS4625-P824G32Mn	Singapore	LX.PSS02.009	AS4625_UMACks_3	APP820	UMA
AS4625-P824G50Mn	Singapore	LX.PSS02.008	AS4625_UMACks_3	APP820	UMA

Model	Country	Acer Part No	BOM Name	CPU	VGA Chip
AS4625-P824G64Mn	Singapore	LX.PSS02.007	AS4625_UMACks_3	APP820	UMA
AS4625-N534G32Mn	Singapore	LX.PSS02.006	AS4625_UMACks_3	ATN530	UMA
AS4625-N534G50Mn	Singapore	LX.PSS02.005	AS4625_UMACks_3	ATN530	UMA
AS4625-N534G64Mn	Singapore	LX.PSS02.004	AS4625_UMACks_3	ATN530	UMA
AS4625-N934G64Mn	Singapore	LX.PSS02.003	AS4625_UMACks_3	APN930	UMA
AS4625-N934G50Mn	Singapore	LX.PSS02.002	AS4625_UMACks_3	APN930	UMA
AS4625-N934G32Mn	Singapore	LX.PSS02.001	AS4625_UMACks_3	APN930	UMA
AS4555-P922G25Mn	WW	S2.PSS02.002	AS4625_UMACks_3	APP920	UMA
AS4555-N332G16Mn	WW	S2.PSS02.001	AS4625_UMACks_3	AAN330	UMA

Model	Country	Acer Part No	VRAM 1	Memory 1	Memory 2
AS4625G-P922G32Mn	China	LX.PSH01.001	512M-DDR3 (64*16*4)	SO2GBIII10	N
AS4625G-P522G50Mn	GCTWN	LX.PSH02.026	512M-DDR3 (64*16*4)	SO2GBIII10	N
AS4625G-P822G50Mn	GCTWN	LX.PSH02.025	512M-DDR3 (64*16*4)	SO2GBIII10	N
AS4625G-P922G50Mn	GCTWN	LX.PSH02.024	512M-DDR3 (64*16*4)	SO2GBIII10	N
AS4625G-P324G32Mn	Singapore	LX.PSH02.023	512M-DDR3 (64*16*4)	SO2GBIII10	SO2GBIII10
AS4625G-P524G50Mn	Singapore	LX.PSH02.022	512M-DDR3 (64*16*4)	SO2GBIII10	SO2GBIII10
AS4625G-P524G32Mn	Singapore	LX.PSH02.021	512M-DDR3 (64*16*4)	SO2GBIII10	SO2GBIII10
AS4625G-P322G32Mn	Singapore	LX.PSH02.020	512M-DDR3 (64*16*4)	SO2GBIII10	N
AS4625G-P524G64Mn	Singapore	LX.PSH02.019	512M-DDR3 (64*16*4)	SO2GBIII10	SO2GBIII10
AS4625G-N836G64Mn	WW	S2.PSH02.004	512M-DDR3 (64*16*4)	SO2GBIII10	SO4GBIII10
AS4625G-N836G64Mn	WW	S2.PSH02.004	512M-DDR3 (64*16*4)	SO2GBIII10	SO4GBIII10
AS4625G-P923G32Mn	WW	S2.PSH02.005	512M-DDR3 (64*16*4)	SO1GBIII10	SO2GBIII10
AS4625G-P923G32Mn	WW	S2.PSH02.005	512M-DDR3 (64*16*4)	SO1GBIII10	SO2GBIII10
AS4625G-N834G64Mn	Singapore	LX.PSH02.018	512M-DDR3 (64*16*4)	SO2GBIII10	SO2GBIII10

Model	Country	Acer Part No	VRAM 1	Memory 1	Memory 2
AS4625G-N834G50Mn	Singapore	LX.PSH02.017	512M-DDR3 (64*16*4)	SO2GBIII10	SO2GBIII10
AS4625G-N834G32Mn	Singapore	LX.PSH02.016	512M-DDR3 (64*16*4)	SO2GBIII10	SO2GBIII10
AS4625G-N536G64Mn	Singapore	LX.PSH02.015	512M-DDR3 (64*16*4)	SO4GBIII10	SO2GBIII10
AS4625G-N534G64Mn	Singapore	LX.PSH02.014	512M-DDR3 (64*16*4)	SO2GBIII10	SO2GBIII10
AS4625G-N534G50Mn	Singapore	LX.PSH02.013	512M-DDR3 (64*16*4)	SO2GBIII10	SO2GBIII10
AS4625G-N534G32Mn	Singapore	LX.PSH02.012	512M-DDR3 (64*16*4)	SO2GBIII10	SO2GBIII10
AS4625G-P924G32Mn	Singapore	LX.PSH02.011	512M-DDR3 (64*16*4)	SO2GBIII10	SO2GBIII10
AS4625G-P924G50Mn	Singapore	LX.PSH02.010	512M-DDR3 (64*16*4)	SO2GBIII10	SO2GBIII10
AS4625G-N334G32Mn	Singapore	LX.PSH02.009	512M-DDR3 (64*16*4)	SO2GBIII10	SO2GBIII10
AS4625G-N332G32Mn	Singapore	LX.PSH02.008	512M-DDR3 (64*16*4)	SO2GBIII10	N
AS4625G-P924G64Mn	Singapore	LX.PSH02.007	512M-DDR3 (64*16*4)	SO2GBIII10	SO2GBIII10
AS4625G-P824G64Mn	Singapore	LX.PSH02.006	512M-DDR3 (64*16*4)	SO2GBIII10	SO2GBIII10
AS4625G-P824G50Mn	Singapore	LX.PSH02.005	512M-DDR3 (64*16*4)	SO2GBIII10	SO2GBIII10
AS4625G-P824G32Mn	Singapore	LX.PSH02.004	512M-DDR3 (64*16*4)	SO2GBIII10	SO2GBIII10
AS4625G-N934G32Mn	Singapore	LX.PSH02.003	512M-DDR3 (64*16*4)	SO2GBIII10	SO2GBIII10
AS4625G-N934G50Mn	Singapore	LX.PSH02.002	512M-DDR3 (64*16*4)	SO2GBIII10	SO2GBIII10
AS4625G-N934G64Mn	Singapore	LX.PSH02.001	512M-DDR3 (64*16*4)	SO2GBIII10	SO2GBIII10
AS4625G-N934G50Mn	WW	S2.PSH0C.001	512M-DDR3 (64*16*4)	SO2GBIII10	SO2GBIII10
AS4555G-P324G32Mn	WW	S2.PSH02.003	512M-DDR3 (64*16*4)	SO2GBIII10	SO2GBIII10
AS4555G-N532G50Mn	WW	S2.PSH02.002	512M-DDR3 (64*16*4)	SO1GBIII10	SO1GBIII10
AS4555-N332G16Mn	WW	S2.PSH02.001	512M-DDR3 (64*16*4)	SO1GBIII10	SO1GBIII10
AS4625-P323G32Mn	ACLA-Portuguese	LX.PSS02.022	N	SO2GBIII10	SO1GBIII10
AS4625-P323G32Mn	Chile	LX.PSS02.021	N	SO2GBIII10	SO1GBIII10
AS4625-P323G32Mn	ACLA-Spanish	LX.PSS02.020	N	SO2GBIII10	SO1GBIII10
AS4625-P323G32Mn	ACLA-Spanish	LX.PSS02.019	N	SO2GBIII10	SO1GBIII10

Model	Country	Acer Part No	VRAM 1	Memory 1	Memory 2
AS4625-P323G32Mn	ACLA-Spanish	LX.PSS02.018	N	SO2GBIII10	SO1GBIII10
AS4625-P822G25Mn	WW	S2.PSS02.003	N	SO1GBIII10	SO1GBIII10
AS4625-P822G25Mn	WW	S2.PSS02.003	N	SO1GBIII10	SO1GBIII10
AS4625-N932G32Mn	Singapore	LX.PSS02.017	N	SO2GBIII10	N
AS4625-N834G32Mn	Singapore	LX.PSS02.016	N	SO2GBIII10	SO2GBIII10
AS4625-N832G32Mn	Singapore	LX.PSS02.015	N	SO2GBIII10	N
AS4625-N333G32Mn	Singapore	LX.PSS02.014	N	SO2GBIII10	SO1GBIII10
AS4625-N332G32Mn	Singapore	LX.PSS02.013	N	SO2GBIII10	N
AS4625-P924G64Mn	Singapore	LX.PSS02.012	N	SO2GBIII10	SO2GBIII10
AS4625-P924G50Mn	Singapore	LX.PSS02.011	N	SO2GBIII10	SO2GBIII10
AS4625-P924G32Mn	Singapore	LX.PSS02.010	N	SO2GBIII10	SO2GBIII10
AS4625-P824G32Mn	Singapore	LX.PSS02.009	N	SO2GBIII10	SO2GBIII10
AS4625-P824G50Mn	Singapore	LX.PSS02.008	N	SO2GBIII10	SO2GBIII10
AS4625-P824G64Mn	Singapore	LX.PSS02.007	N	SO2GBIII10	SO2GBIII10
AS4625-N534G32Mn	Singapore	LX.PSS02.006	N	SO2GBIII10	SO2GBIII10
AS4625-N534G50Mn	Singapore	LX.PSS02.005	N	SO2GBIII10	SO2GBIII10
AS4625-N534G64Mn	Singapore	LX.PSS02.004	N	SO2GBIII10	SO2GBIII10
AS4625-N934G64Mn	Singapore	LX.PSS02.003	N	SO2GBIII10	SO2GBIII10
AS4625-N934G50Mn	Singapore	LX.PSS02.002	N	SO2GBIII10	SO2GBIII10
AS4625-N934G32Mn	Singapore	LX.PSS02.001	N	SO2GBIII10	SO2GBIII10
AS4555-P922G25Mn	WW	S2.PSS02.002	N	SO1GBIII10	SO1GBIII10
AS4555-N332G16Mn	WW	S2.PSS02.001	N	SO2GBIII10	N

Model	Country	Acer Part No	HDD 1(GB)	ODD
AS4625G-P922G32Mn	China	LX.PSH01.001	N320GB5.4KS	NSM8XS9.5
AS4625G-P522G50Mn	GCTWN	LX.PSH02.026	N500GB5.4KS	NSM8XS9.5
AS4625G-P822G50Mn	GCTWN	LX.PSH02.025	N500GB5.4KS	NSM8XS9.5

Model	Country	Acer Part No	HDD 1(GB)	ODD
AS4625G-P922G50Mn	GCTWN	LX.PSH02.024	N500GB5.4KS	NSM8XS9.5
AS4625G-P324G32Mn	Singapore	LX.PSH02.023	N320GB5.4KS	NSM8XS9.5
AS4625G-P524G50Mn	Singapore	LX.PSH02.022	N500GB5.4KS	NSM8XS9.5
AS4625G-P524G32Mn	Singapore	LX.PSH02.021	N320GB5.4KS	NSM8XS9.5
AS4625G-P322G32Mn	Singapore	LX.PSH02.020	N320GB5.4KS	NSM8XS9.5
AS4625G-P524G64Mn	Singapore	LX.PSH02.019	N640GB5.4KS	NSM8XS9.5
AS4625G-N836G64Mn	WW	S2.PSH02.004	N640GB5.4KS	NSM8XS9.5
AS4625G-N836G64Mn	WW	S2.PSH02.004	N640GB5.4KS	NSM8XS9.5
AS4625G-P923G32Mn	WW	S2.PSH02.005	N320GB5.4KS	NSM8XS9.5
AS4625G-P923G32Mn	WW	S2.PSH02.005	N320GB5.4KS	NSM8XS9.5
AS4625G-N834G64Mn	Singapore	LX.PSH02.018	N640GB5.4KS	NSM8XS9.5
AS4625G-N834G50Mn	Singapore	LX.PSH02.017	N500GB5.4KS	NSM8XS9.5
AS4625G-N834G32Mn	Singapore	LX.PSH02.016	N320GB5.4KS	NSM8XS9.5
AS4625G-N536G64Mn	Singapore	LX.PSH02.015	N640GB5.4KS	NSM8XS9.5
AS4625G-N534G64Mn	Singapore	LX.PSH02.014	N640GB5.4KS	NSM8XS9.5
AS4625G-N534G50Mn	Singapore	LX.PSH02.013	N500GB5.4KS	NSM8XS9.5
AS4625G-N534G32Mn	Singapore	LX.PSH02.012	N320GB5.4KS	NSM8XS9.5
AS4625G-P924G32Mn	Singapore	LX.PSH02.011	N320GB5.4KS	NSM8XS9.5
AS4625G-P924G50Mn	Singapore	LX.PSH02.010	N500GB5.4KS	NSM8XS9.5
AS4625G-N334G32Mn	Singapore	LX.PSH02.009	N320GB5.4KS	NSM8XS9.5
AS4625G-N332G32Mn	Singapore	LX.PSH02.008	N320GB5.4KS	NSM8XS9.5
AS4625G-P924G64Mn	Singapore	LX.PSH02.007	N640GB5.4KS	NSM8XS9.5
AS4625G-P824G64Mn	Singapore	LX.PSH02.006	N640GB5.4KS	NSM8XS9.5
AS4625G-P824G50Mn	Singapore	LX.PSH02.005	N500GB5.4KS	NSM8XS9.5
AS4625G-P824G32Mn	Singapore	LX.PSH02.004	N320GB5.4KS	NSM8XS9.5
AS4625G-N934G32Mn	Singapore	LX.PSH02.003	N320GB5.4KS	NSM8XS9.5
AS4625G-N934G50Mn	Singapore	LX.PSH02.002	N500GB5.4KS	NSM8XS9.5
AS4625G-N934G64Mn	Singapore	LX.PSH02.001	N640GB5.4KS	NSM8XS9.5
AS4625G-N934G50Mn	WW	S2.PSH0C.001	N500GB5.4KS	NSM8XS9.5
AS4555G-P324G32Mn	WW	S2.PSH02.003	N320GB5.4KS	NSM8XS9.5
AS4555G-N532G50Mn	WW	S2.PSH02.002	N500GB5.4KS	NSM8XS9.5
AS4555-N332G16Mn	WW	S2.PSH02.001	N160GB5.4KS	NSM8XS9.5
AS4625-P323G32Mn	ACLA-Portuguese	LX.PSS02.022	N320GB5.4KS	NSM8XS9.5
AS4625-P323G32Mn	Chile	LX.PSS02.021	N320GB5.4KS	NSM8XS9.5
AS4625-P323G32Mn	ACLA-Spanish	LX.PSS02.020	N320GB5.4KS	NSM8XS9.5
AS4625-P323G32Mn	ACLA-Spanish	LX.PSS02.019	N320GB5.4KS	NSM8XS9.5
AS4625-P323G32Mn	ACLA-Spanish	LX.PSS02.018	N320GB5.4KS	NSM8XS9.5
AS4625-P822G25Mn	WW	S2.PSS02.003	N250GB5.4KS	NSM8XS9.5
AS4625-P822G25Mn	WW	S2.PSS02.003	N250GB5.4KS	NSM8XS9.5
AS4625-N932G32Mn	Singapore	LX.PSS02.017	N320GB5.4KS	NSM8XS9.5

Model	Country	Acer Part No	HDD 1(GB)	ODD
AS4625-N834G32Mn	Singapore	LX.PSS02.016	N320GB5.4KS	NSM8XS9.5
AS4625-N832G32Mn	Singapore	LX.PSS02.015	N320GB5.4KS	NSM8XS9.5
AS4625-N333G32Mn	Singapore	LX.PSS02.014	N320GB5.4KS	NSM8XS9.5
AS4625-N332G32Mn	Singapore	LX.PSS02.013	N320GB5.4KS	NSM8XS9.5
AS4625-P924G64Mn	Singapore	LX.PSS02.012	N640GB5.4KS	NSM8XS9.5
AS4625-P924G50Mn	Singapore	LX.PSS02.011	N500GB5.4KS	NSM8XS9.5
AS4625-P924G32Mn	Singapore	LX.PSS02.010	N320GB5.4KS	NSM8XS9.5
AS4625-P824G32Mn	Singapore	LX.PSS02.009	N320GB5.4KS	NSM8XS9.5
AS4625-P824G50Mn	Singapore	LX.PSS02.008	N500GB5.4KS	NSM8XS9.5
AS4625-P824G64Mn	Singapore	LX.PSS02.007	N640GB5.4KS	NSM8XS9.5
AS4625-N534G32Mn	Singapore	LX.PSS02.006	N320GB5.4KS	NSM8XS9.5
AS4625-N534G50Mn	Singapore	LX.PSS02.005	N500GB5.4KS	NSM8XS9.5
AS4625-N534G64Mn	Singapore	LX.PSS02.004	N640GB5.4KS	NSM8XS9.5
AS4625-N934G64Mn	Singapore	LX.PSS02.003	N640GB5.4KS	NSM8XS9.5
AS4625-N934G50Mn	Singapore	LX.PSS02.002	N500GB5.4KS	NSM8XS9.5
AS4625-N934G32Mn	Singapore	LX.PSS02.001	N320GB5.4KS	NSM8XS9.5
AS4555-P922G25Mn	WW	S2.PSS02.002	N250GB5.4KS	NSM8XS9.5
AS4555-N332G16Mn	WW	S2.PSS02.001	N160GB5.4KS	NSM8XS9.5

Test Compatible Components

This computer's compatibility is tested and verified by Acer's internal testing department. All of its system functions are tested under Windows® 7 environment.

Refer to the following lists for components, adapter cards, and peripherals which have passed these tests. Regarding configuration, combination and test procedures, please refer to the Aspire 4625/4625G Compatibility Test Report released by the Acer Mobile System Testing Department.

Microsoft® Windows® 7 Environment Test

Vendor	Type	Description	Part No.
A cover			
9999995 ONE TIME VENDER	Aluminum	Aluminum	LZ.21000.006
Adapter			
10001023 LITE-ON	65W	Adapter LITE-ON 65W 19V 1.7x5.5x11 Yellow PA-1650-22AC LV5 LED LF	AP.06503.024
10001023 LITE-ON	65W	Adapter LITE-ON 65W 19V 1.7x5.5x11 Yellow (PA-1650-22AG), LV5 Timeline LF	AP.06503.026
10001023 LITE-ON	65W	Adapter LITE-ON 65W 19V 1.7x5.5x11 Yellow PA-1650-69AW, LV5, Low profile LED LF	AP.06503.029
10001023 LITE-ON	90W	Adapter LITE-ON 90W 19V 1.7x5.5x11 Blue PA-1900-34AR, LV5 LED LF	AP.09003.021
10001081 DELTA	65W	Adapter DELTA 65W 19V 1.7x5.5x11 Yellow ADP-65JH DB A, LV5 LED LF	AP.06501.026
10001081 DELTA	65W	Adapter DELTA 65W 19V 1.7x5.5x11 Yellow (ADP-65MH B A) LV5, Timeline LF LF	AP.06501.027
10001081 DELTA	65W	Adapter DELTA 65W 19V 1.7x5.5x11 Yellow ADP-65VH BA, LV5, Low profile LED LF	AP.06501.033
10001081 DELTA	90W	Adapter DELTA 90W 19V 1.7x5.5x11 Blue ADP-90CD DB A, LV5 LED LF	AP.09001.027
10001081 DELTA	90W	Adapter DELTA 90W 19V 1.7x5.5x11 Blue ADP-90CD DBH, LV5 LED LF	AP.09001.031
60002015 HIPRO	65W	Adapter HIPRO 65W 19V 1.7x5.5x11 Yellow HP-A0652R3B 1LF, LV5 LED LF	AP.0650A.012
60002015 HIPRO	65W	Adapter HIPRO 65W 19V 1.7x5.5x11 Yellow HP-A0653R3B 1LF, LV5 Timeline, Rev.02 w/ Korea safety LF w/Korea safety logo	AP.0650A.016
60002015 HIPRO	90W	Adapter HIPRO 90W 19V 1.7x5.5x11 Blue HP-A0904A3 B1LF, LV5 LED LF	AP.0900A.005
60016453 CHICONY POWER	65W	Adapter Chicony Power 65W 19V 1.7x5.5x11 Yellow CPA09-A065N1, LV5, low profile LED LF	AP.0650A.017
Audio Codec			
10004786 REALTEK	ALC271X	Realtek ALC271X	LZ.21000.069
B cover			
9999995 ONE TIME VENDER	Mirror w/Camera	Mirror w/Camera	LZ.21000.009
Battery			
60001535 PANASONI C	6CELL3.0	Battery PANASONIC AS10B Li-Ion 3S2P PANASONIC 6 cell 6000mAh Main COMMON ID:AS10B5E	BT.00605.063
60001921 SANYO	6CELL3.0	Battery SANYO AS10B Li-Ion 3S2P SANYO 6 cell 6000mAh Main COMMON ID: AS10B3E	BT.00603.116

Vendor	Type	Description	Part No.
HDD			
60002162 SIMPLO	6CELL3.0	Battery SIMPLO AS10B Li-Ion 3S2P SAMSUNG 6 cell 6000mAh Main COMMON ID:AS10B7E	BT.00607.128
60002162 SIMPLO	9CELL3.0	Battery SIMPLO AS10E Li-Ion 3S3P SAMSUNG 9 cell 9000mAh Main COMMON ID:AS10E7E	BT.00907.013
60013145 SAMSUNG SDI	6CELL3.0	Battery SAMSUNG AS10B Li-Ion 3S2P SAMSUNG 6 cell 6000mAh Main COMMON ID:AS10B6E	BT.00606.009
10001018 HON HAI	BT 3.0	Foxconn Bluetooth BRM 2046 BT3.0 (T60H928.33) f/w:861	BH.21100.008
10001018 HON HAI	BT 3.0	Foxconn Bluetooth ATH AR3011 (BT3.0)	BH.21100.009
10001018 HON HAI	BT 3.0	Foxconn Bluetooth BRM 2070 (T77H114.01) BT 3.0	BH.21100.010
23707801 FOXCONN TW	BT 2.1	Foxconn Bluetooth BRM 2046 BT2.1 (T60H928.33) f/w:861	BH.21100.004
23707801 FOXCONN TW	BT 2.1	Foxconn Bluetooth ATH AR3011	BH.21100.005
23707801 FOXCONN TW	BT 2.1	Foxconn Bluetooth BRM 2070 (T77H114.01)	BH.21100.007
10001023 LITE-ON	1.3M	Liteon 1.3M LT9665AL (09P2SF119)	AM.21400.069
10001023 LITE-ON	1.3M	Liteon 1.3M LT6AASP(09P2BF127)	AM.21400.070
10001044 CHICONY	1.3M	Chicony 1.3M CH9665SN (CNF9157)	AM.21400.067
PLM00012 Suyin	1.3M	Suyin 1.3M SY9665SN	AM.21400.068
PLM00014 ODM	5 in 1-Build in	5 in 1-Build in MS, MS Pro, SD, SC, XD	CR.21500.013
22554573 AMD	AAP320	CPU AMD AthlonII P320 2.1G 1M 25W Dual- Core	KC.AP002.32 0
22554573 AMD	APP820	CPU AMD PhenomII P820 1.8G 25W 1.5M L2, Triple-Core	KC.PP002.82 0
22554573 AMD	APP920	CPU AMD PhenomII P920 1.6G 2M 25W Quad-Core	KC.PP002.92 0
22554573 AMD	ATP520	CPU AMD TurionII P520 2.3G 2M 25W Dual- Core	KC.TP002.52 0
60001922 TOSHIBA DIGI	N160GB5.4KS	HDD TOSHIBA 2.5" 5400rpm 160GB MK1665GSX, Capricorn BS, 320G/P SATA 8MB LF F/W:GJ002J	KH.16004.008
60001922 TOSHIBA DIGI	N250GB5.4KS	HDD TOSHIBA 2.5" 5400rpm 250GB MK2565GSX, Capricorn BS, 320G/P SATA 8MB LF F/W:GJ002J	KH.25004.005

Vendor	Type	Description	Part No.
60001922 TOSHIBA DIGI	N320GB5.4KS	HDD TOSHIBA 2.5" 5400rpm 320GB Capricorn BS ,MK3265GSX SATA 8MB LF F/ W:GJ002J	KH.32004.004
60001922 TOSHIBA DIGI	N500GB5.4KS	HDD TOSHIBA 2.5" 5400rpm 500GB MK5065GSX,Capricorn BS, 320G/P SATA 8MB LF F/W:GJ002J	KH.50004.002
60001922 TOSHIBA DIGI	N640GB5.4KS	HDD TOSHIBA 2.5" 5400rpm 640GB MK6465GSX,Capricorn BS,320G/P SATA 8MB LF F/W:GJ002J	KH.64004.001
60001994 WD	N160GB5.4KS	HDD WD 2.5" 5400rpm 160GB WD1600BEVT- 22A23T0 , WD, ML320S SATA 8MB LF F/ W:01.01A01	KH.16008.027
60001994 WD	N250GB5.4KS	HDD WD 2.5" 5400rpm 250GB WD2500BEVT- 22A23T0, WD, ML320S SATA 8MB LF F/ W:01.01A01.	KH.25008.025
60001994 WD	N320GB5.4KS	HDD WD 2.5" 5400rpm 320GB WD3200BEVT- 22A23T0,ML320S,WD SATA 8MB LF F/ W:01.01A01	KH.32008.019
60001994 WD	N500GB5.4KS	HDD WD 2.5" 5400rpm 500GB WD5000BEVT- 22A0RT0, ML320M,WD SATA 8MB LF F/ W:01.01A01	KH.50008.017
60001994 WD	N640GB5.4KS	HDD WD 2.5" 5400rpm 640GB WD6400BEVT- 22A0RT0, ML320 SATA 8MB LF F/ W:01.01A01	KH.64008.004
60002005 HGST SG	N160GB5.4KS	HDD HGST 2.5" 5400rpm 160GB HTS545016B9A300 Panther B SATA LF F/ W:C60F Disk imbalance criteria = 0.014g-cm	KH.16007.026
60002005 HGST SG	N250GB5.4KS	HDD HGST 2.5" 5400rpm 250GB HTS545025B9A300 Panther B SATA LF F/ W:C60F Disk imbalance criteria = 0.014g-cm	KH.25007.016
60002005 HGST SG	N320GB5.4KS	HDD HGST 2.5" 5400rpm 320GB HTS545032B9A300 Panther B SATA LF F/ W:C60F Disk imbalance criteria = 0.014g-cm	KH.32007.008
60002005 HGST SG	N500GB5.4KS	HDD HGST 2.5" 5400rpm 500GB HTS545050B9A300 Panther B SATA LF F/ W:C60F Disk imbalance criteria = 0.014g-cm	KH.50007.010
60002036 SEAGATE	N160GB5.4KS	HDD SEAGATE 2.5" 5400rpm 160GB ST9160314AS Wyatt SATA LF F/ W:0001SDM1	KH.16001.042
60002036 SEAGATE	N250GB5.4KS	HDD SEAGATE 2.5" 5400rpm 250GB ST9250315AS Wyatt SATA LF F/ W:0001SDM1	KH.25001.016
60002036 SEAGATE	N320GB5.4KS	HDD SEAGATE 2.5" 5400rpm 320GB ST9320325AS Wyatt SATA LF F/ W:0001SDM1	KH.32001.017
60002036 SEAGATE	N500GB5.4KS	HDD SEAGATE 2.5" 5400rpm 500GB ST9500325AS Wyatt SATA LF F/ W:0001SDM1	KH.50001.011
Keyboard			
60004864 DARFON	AC4T_A10B	Keyboard ACER AC4T_A10B AC4T Internal 14 Standard Black Y2010 Acer Legend Texture	KB.I140A.202
LAN			

Vendor	Type	Description	Part No.
10017383 Atheros	AR8151L	Atheros AR8151L	NI.22400.048
MEM			
10001038 CMO	NLED14WXGAG S	LED LCD CMO 14" WXGA Glare N140B6-L24 LF 200nit 8ms 650:1 (Power saving)	LK.1400D.007
60002215 SAMSUNG	NLED14WXGAG S	LED LCD SAMSUNG 14" WXGA Glare LTN140AT06-A01 LF 200nit 16ms	LK.14006.010
60002215 SAMSUNG	NLED14WXGAG S	LED LCD SAMSUNG 14" WXGA Glare LTN140AT12-A01 LF 200nit 16ms 500:1 (Power saving)	LK.14006.012
60003089 LG	NLED14WXGAG S	LED LCD LPL 14" WXGA Glare LP140WH2- TLA2 LF 200nit 16ms 500:1	LK.14008.005
60003089 LG	NLED14WXGAG S	LED LCD LPL 14" WXGA Glare LP140WH2- TLL1 LF 200nit 16ms 500:1 (Power saving)	LK.14008.006
60003316 AUO	NLED14WXGAG S	LED LCD AUO 14" WXGA Glare B140XW02 V1 LF 200nit 8ms 500:1	LK.14005.007
60003316 AUO	NLED14WXGAG S	LED LCD AUO 14" WXGA Glare B140XW03 V0 LF 200nit 8ms 500:1 (Power saving)	LK.14005.011
60001993 NANYA	SO2GBIII13	Memory NANYA SO-DIMM DDRIII 1333 2GB NT2GC64B8HC0NS-CG LF 128*8 0.065um	KN.2GB03.01 7
60002045 HYNIX	SO1GBIII10	Memory HYNIX SO-DIMM DDRIII 1066 1GB HMT112S6BFR6C-G7 N0 LF 64*16 0.055um	KN.1GB0G.02 5
60002045 HYNIX	SO2GBIII10	Memory HYNIX SO-DIMM DDRIII 1066 2GB HMT125S6BFR8C-G7 N0 LF 128*8 0.055um	KN.2GB0G.01 4
60002045 HYNIX	SO2GBIII13	Memory HYNIX SO-DIMM DDRIII 1333 2GB HMT125S6TFR8C-H9 LF 128*8 0.055um	KN.2GB0G.01 6
60002045 HYNIX	SO4GBIII13	Memory HYNIX SO-DIMM DDRIII 1333 4GB HMT351S6AFR8C-H9 LF 256*8 0.055um	KN.4GB0G.00 3
60002215 SAMSUNG	SO1GBIII10	Memory SAMSUNG SO-DIMM DDRIII 1066 1GB M471B2873EH1-CF8 LF 64*16 0.055um	KN.1GB0B.02 8
60002215 SAMSUNG	SO1GBIII13	Memory SAMSUNG SO-DIMM DDRIII 1333 1GB M471B2873FHS-CH9 LF 128*8 46nm	KN.1GB0B.03 5
60002215 SAMSUNG	SO2GBIII10	Memory SAMSUNG SO-DIMM DDRIII 1066 2GB M471B5673EH1-CF8 LF 128*8 0.055um	KN.2GB0B.01 2
60002215 SAMSUNG	SO2GBIII13	Memory SAMSUNG SO-DIMM DDRIII 1333 2GB M471B5673FH0-CH9 LF 128*8 46nm	KN.2GB0B.02 3
60002215 SAMSUNG	SO4GBIII13	Memory SAMSUNG SO-DIMM DDRIII 1333 4GB M471B5273CH0-CH9 LF 256*8 46nm	KN.4GB0B.01 0
60004668 ELPIDA	SO1GBIII10	Memory ELPIDA SO-DIMM DDRIII 1066 1GB EBJ10UE8BDS0-AE-F LF 128*8 0.065um	KN.1GB09.01 2
60004668 ELPIDA	SO1GBIII13	Memory ELPIDA SO-DIMM DDRIII 1333 1GB EBJ10UE8BDS0-DJ-F LF 128*8 0.065um	KN.1GB09.01 5
60004668 ELPIDA	SO2GBIII10	Memory ELPIDA SO-DIMM DDRIII 1066 2GB EBJ21UE8BDS0-AE-F LF 128*8 0.065um	KN.2GB09.00 6
60004668 ELPIDA	SO2GBIII13	Memory ELPIDA SO-DIMM DDRIII 1333 2GB EBJ21UE8BDS0-DJ-F LF 128*8 0.065um	KN.2GB09.00 7
60004668 ELPIDA	SO4GBIII10	Memory NONE SO-DIMM DDRIII 1066 4GB dummy P/N LF	KN.4GB00.00 1
60004668 ELPIDA	SO4GBIII13	Memory ELPIDA SO-DIMM DDRIII 1333 4GB EBJ41UF8BAS0-DJ-F LF 256*8 0.055um	KN.4GB09.00 1

Vendor	Type	Description	Part No.
60024207 KINGSTON	SO1GBIII13	Memory KINGSTON SO-DIMM DDRIII 1333 1GB ACR128X64D3S1333C9 LF 128*8 0.065um	KN.1GB07.00 4
60024207 KINGSTON	SO2GBIII13	Memory KINGSTON SO-DIMM DDRIII 1333 2GB ACR256X64D3S1333C9 LF 128*8 0.065um	KN.2GB07.00 4
Modem			
10001023 LITE-ON	External USB Lite+LSI modem	External USB Lite+LSI modem	LC.MOD00.00 1
NB Chipset			
22554573 AMD	AMDRS880M	AMD RS880M w/ HDCP EEPROM	KI.22600.050
ODD			
60001535 PANASONI C	NSM8XS9.5	ODD PANASONIC Super-Multi DRIVE 9.5mm Tray DL 8X UJ892 LF W/O bezel SATA GBAS2.0, (HF + Windows7)	KU.00807.068
60001922 TOSHIBA DIGI	NSM8XS9.5	ODD TOSHIBA Super-Multi DRIVE 9.5mm Tray DL 8X TS-U633F LF W/O bezel SATA (HF + Windows 7)	KU.00801.034
610105 HLDS	NSM8XS9.5	ODD HLDS Super-Multi DRIVE 9.5mm Tray DL 8X GU10N LF W/O bezel SATA (HF + Windows 7)	KU.0080D.04 9
SB Chipset			
22554573 AMD	AMDSB820M	AMD SB820M	KI.22800.016
Side Port			
10000981 MISC	128MB-DDR3 (64*16*1)	Side Port 128MB-DDR3 (64*16*1)	LZ.24100.001
22554573 AMD	VR1GbIII8	VRAM ATI Graphic DDRIII 800 1Gb 23BY2387MB-12 LF+HF	VR.1GB0T.00 2
60002045 HYNIX	VR1GbIII8	VRAM HYNIX Graphic DDRIII 800 1Gb H5TQ1G63BFR-12C LF	VR.1GB0G.00 4
60002215 SAMSUNG	VR1GbIII8	VRAM SAMSUNG Graphic DDRIII 800 1Gb K4W1G1646E-HC12 LF	VR.1GB0B.00 6
Software			
10000981 MISC	McAfee	Antivirus application McAfee	SR.23900.001
VGA Chip			
22554573 AMD	PARK_XT	AMD PARK_XT 40nm 29mm*29mm M2 package	KI.23200.162
22554573 AMD	UMA	UMA (AMD)	KI.23200.154
VRAM			
10000981 MISC	512M-DDR3 (64*16*4)	512M-DDR3 64*16*4	KI.23300.019
60002045 HYNIX	VR1GbIII8	VRAM HYNIX Graphic DDRIII 800 1Gb H5TQ1G63BFR-12C LF	VR.1GB0G.00 4
60002045 HYNIX	VR2GbIII8	VRAM HYNIX Graphic DDRIII 800 2Gb H5TQ2G63BFR-12C LF+HF	VR.2GB0G.00 1

Vendor	Type	Description	Part No.
60002215 SAMSUNG	VR1GbIII8	VRAM SAMSUNG Graphic DDRIII 800 1Gb K4W1G1646E-HC12 LF	VR.1GB0B.00 6
60002215 SAMSUNG	VR2GbIII8	VRAM SAMSUNG Graphic DDRIII 800 2Gb K4W2G1646B-HC12 LF+HF	VR.2GB0B.00 1
WiFi Antenna			
10000105 WNC	PIFA	PIFA	LZ.23500.006
Wireless LAN			
23707801 FOXCONN TW	3rd WiFi 2x2 BGN	Foxconn Wireless LAN Atheros HB93 2x2 BGN (HM)	NI.23600.062
23707801 FOXCONN TW	3rd WiFi 2x2 BGN	Foxconn Wireless LAN Broadcomm 43225 2x2 BGN (HM) T77H103.00	NI.23600.066
23707801 FOXCONN TW	3rd WiFi 2x2 BGN	Foxconn Wireless LAN Atheros HB97 2x2 BGN (HM)	NI.23600.072
23707801 FOXCONN TW	3rd WiFi BG	Foxconn Wirelss LAN Atheros HB95BG (HM) T77H121.10	NI.23600.077

Online Support Information

This section describes online technical support services available to help you repair your Acer Systems.

If you are a distributor, dealer, ASP or TPM, please refer your technical queries to your local Acer branch office. Acer Branch Offices and Regional Business Units may access our website. However some information sources will require a user i.d. and password. These can be obtained directly from Acer CSD Taiwan.

Acer's Website offers you convenient and valuable support resources whenever you need them.

In the Technical Information section you can download information on all of Acer's Notebook, Desktop and Server models including:

- Service guides for all models
- Bios updates
- Software utilities
- Spare parts lists
- TABs (Technical Announcement Bulletin)

For these purposes, we have included an Acrobat File to facilitate the problem-free downloading of our technical material.

Also contained on this website are:

- Detailed information on Acer's International Traveler's Warranty (ITW)
- Returned material authorization procedures
- An overview of all the support services we offer, accompanied by a list of telephone, fax and email contacts for all your technical queries.

We are always looking for ways to optimize and improve our services, so if you have any suggestions or comments, please do not hesitate to communicate these to us.

A

AFLASH Utility 36
Antennas 81

B

Battery Pack 48
BIOS
 ROM type 18
 vendor 18
 Version 18
BIOS Utility 29–36
 Advanced 32
 Boot 34
 Exit 35
 Navigating 29
 Onboard Device Configuration 33
 Power 34
 Save and Exit 35
 Security 32
 System Security 35
Board Layout
 Top View 125
brightness
 hotkeys 15

C

Camera Module 77
Common Problems 108
computer
 on indicator 11

D

DIMM Module 53
Display 6
display
 hotkeys 15

E

EasyTouch Failure 118
External Module Disassembly
 Flowchart 47

F

Features 1
Flash Utility 36
FPC Cable 79
FRU (Field Replaceable Unit) List 129

H

Hard Disk Drive Module 56
HDTV Switch Failure 119
Hibernation mode
 hotkey 15
Hot Keys 13

I

Indicators 11
Intermittent Problems 120
Internal Microphone Failure 113
Internal Speaker Failure 112

J

Jumper and Connector Locations 125

K

Keyboard Failure 111

L

LCD Bezel 76
LCD Failure 111
LCD Module Disassembly
 Flowchart 75
LCD Panel 78
lower cover 50

M

Main Unit Disassembly
 Flowchart 57
Mainboard 70
media access
 on indicator 11
Memory Check 108
Model Definition 146

N

No Display Issue 109

O

ODD Failure 115

Online Support Information 165

optical drive module 51

P

Panel 7

Bottom 10

PC Card 11

Power On Failure 108

R

RTC Battery 74

S

SD Card 49

System

Block Diagram 6

T

Test Compatible Components 157

Thermal Module 71

Thermal Unit Failure 118

TouchPad Failure 112

Troubleshooting

Built-in KB Failure 111

EasyTouch Buttons 118

HDTV Switch 119

Internal Microphone 113

Internal Speakers 112

LCD Failure 111

No Display 109

ODD 115

Other Failures 119

Power On 108

Thermal Unit 118

TouchPad 112

WLAN 118

U

Undetermined Problems 120

USB Board 65

utility

BIOS 29–36

W

Windows 2000 Environment Test 158

Wireless Function Failure 118

WLAN Board 54

Free Manuals Download Website

<http://myh66.com>

<http://usermanuals.us>

<http://www.somanuals.com>

<http://www.4manuals.cc>

<http://www.manual-lib.com>

<http://www.404manual.com>

<http://www.luxmanual.com>

<http://aubethermostatmanual.com>

Golf course search by state

<http://golfingnear.com>

Email search by domain

<http://emailbydomain.com>

Auto manuals search

<http://auto.somanuals.com>

TV manuals search

<http://tv.somanuals.com>