

# RLM G5i Performer



Owner's manual

R9010320

R5976815/02  
02/06/2006

**BARCO**

Visibly yours

**Barco nv Events**

Noordlaan 5, B-8520 Kurne

Phone: +32 56.36.89.70

Fax: +32 56.36.88.24

E-mail: [sales.events@barco.com](mailto:sales.events@barco.com)

Visit us at the web: [www.barco.com](http://www.barco.com)

Printed in Belgium

---

# 1. PACKAGING AND DIMENSIONS

## Overview

- Box content
- Projector Packaging
- Dimensions

## 1.1 Box content

---



### CEE7

European power plug to connect the power cord to the wall outlet.

---



### ANSI 73.11

American power plug to connect the power cord to the wall outlet.

---

## Content

- 1 RLM G5i Performer projector (weight  $\pm$  30 kg or 67 lbs)
- 1 remote control unit RCU + 2 batteries.
- 2 power cables with outlet plug type CEE7 and ANSI 73.11.
- 1 owners manual
- 1 safety manual

## 1.2 Projector Packaging

---

### Way of Packaging

The projector is packed in a carton box. To provide protection during transportation, the projector is surrounded with foam. The package is secured with banding and fastening clips.

### To unpack

1. Is your projector packed with a fastening clips?  
If yes, release the fastening clips (image 1-1)  
If no, go to step 3
2. Remove the banding. Handle as shown in the drawing and continue with step 4.
3. Cut the binding ribbons.
4. Take the projector out of its shipping carton and place it on a table. (image 1-2)

# 1. Packaging and Dimensions

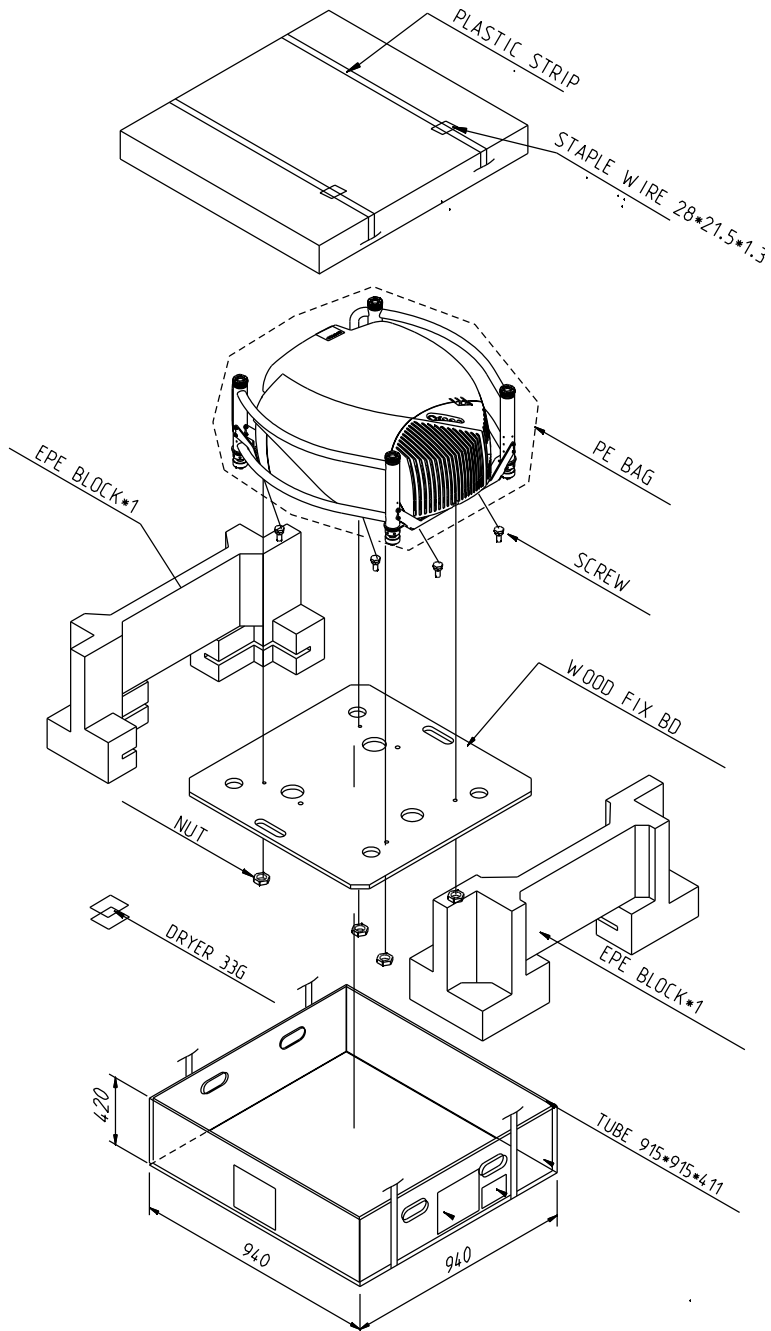
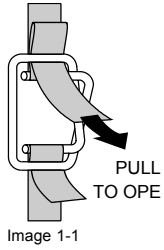

Image 1-2  
Projector packaging



Save the original shipping carton and packing material, they will be necessary if you ever have to ship your projector. For maximum protection, repack your projector as it was originally packed at the factory.

### 1.3 Dimensions

#### Side view

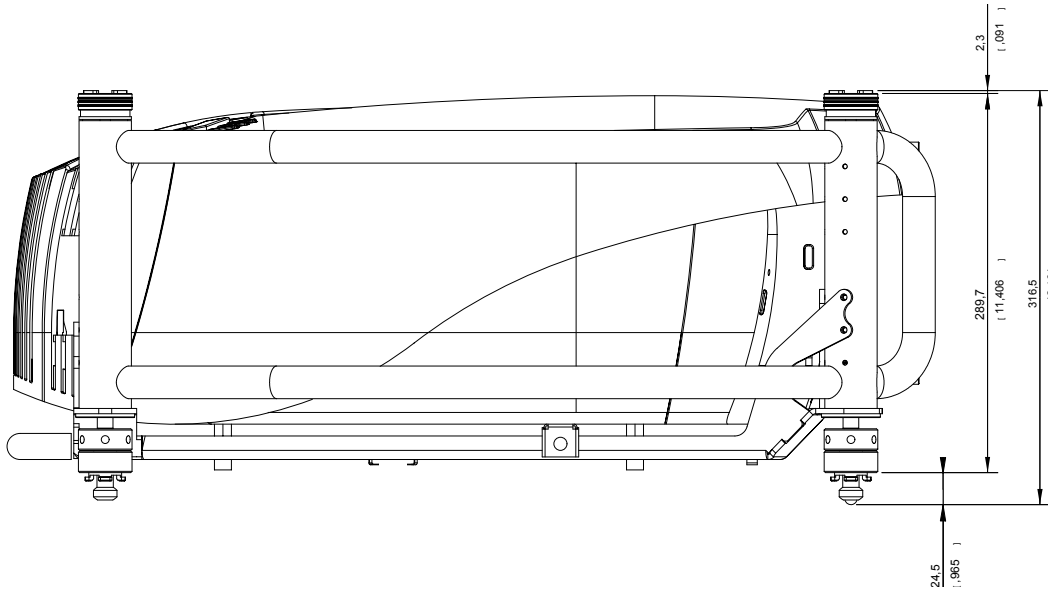

Image 1-3  
Side view

#### Front view

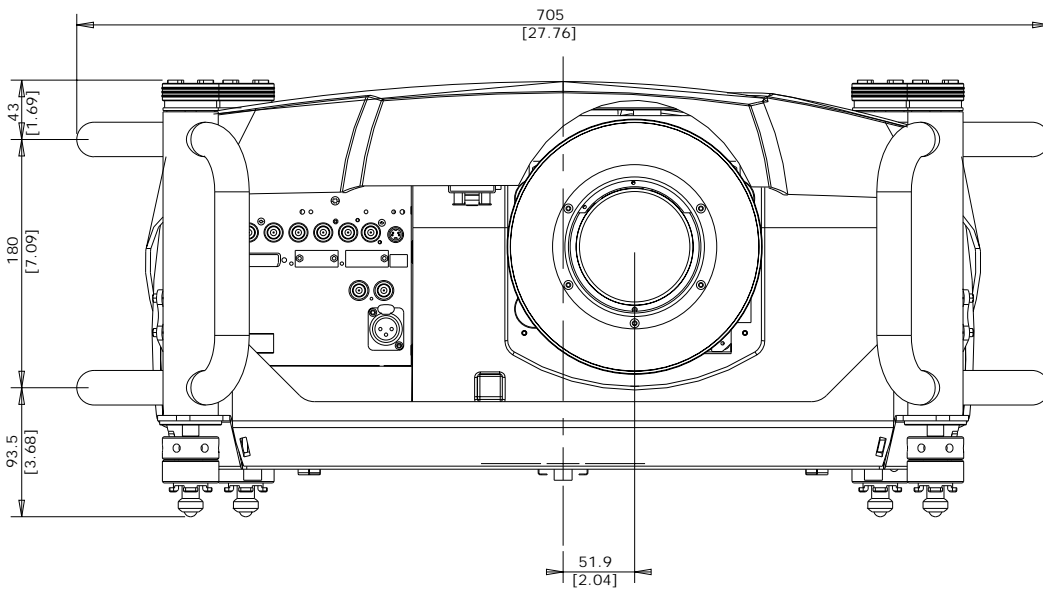

Image 1-4  
Front view

1. Packaging and Dimensions

Bottom view

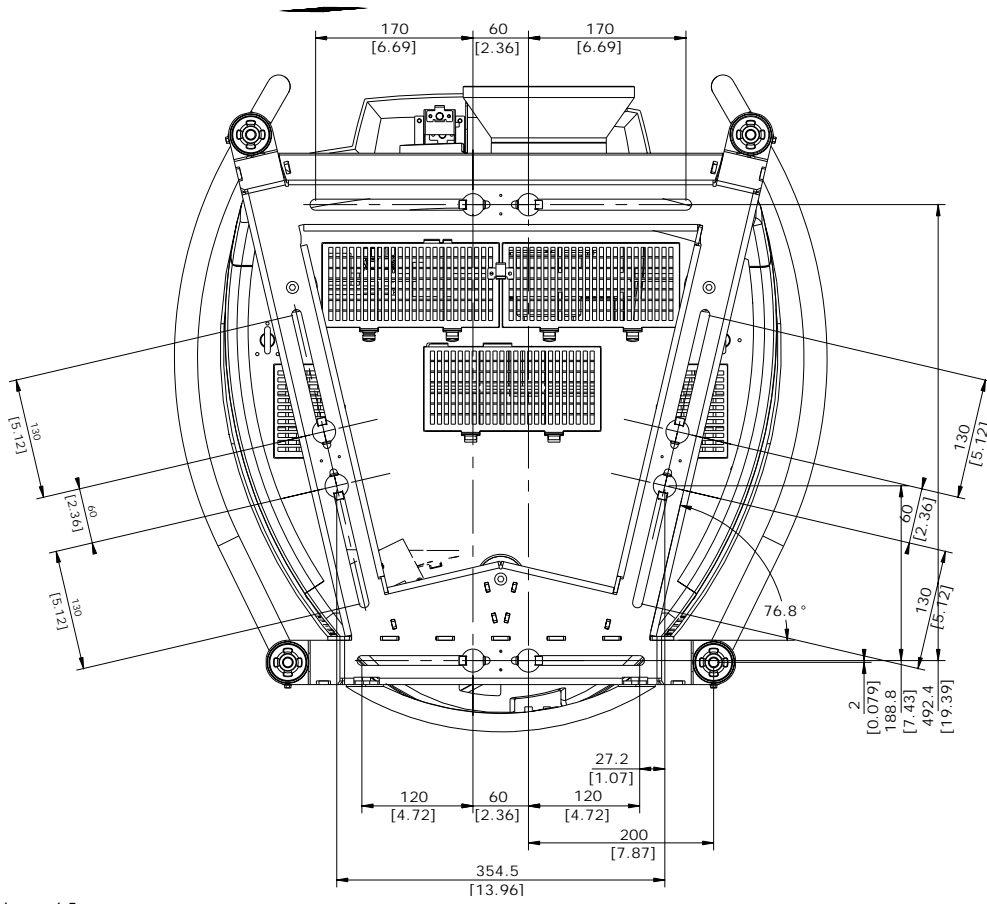

Image 1-5  
Bottom view

Top view

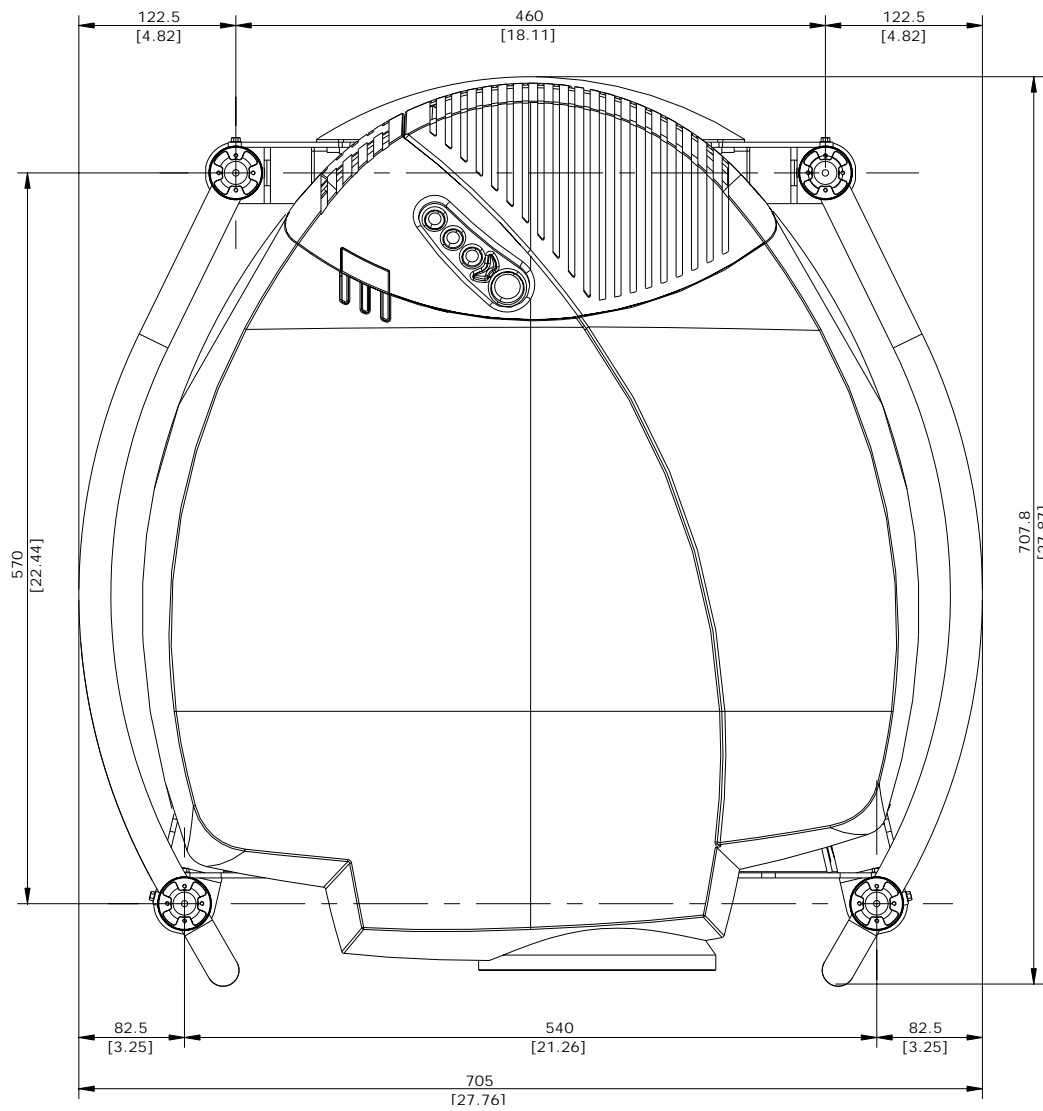

Image 1-6  
Top view





---

## 2. INSTALLATION GUIDELINES

### Overview

- Safety Warnings
- General
- Projector Configuration
- Safety Area around projector
- Lenses
- Battery Insertion in the Remote Control
- Stacking projectors
- Rigging points and accessories



**WARNING:** Before installing the projector, read first the safety instructions in the safety manual delivered with the projector and also the safety pages in this manual.

---

### 2.1 Safety Warnings

---

#### Mercury Vapor Warnings

Keep the following warnings in mind when using the projector. The lamp used in the projector contains mercury. In case of a lamp rupture, explosion there will be a mercury vapor emission. In order to minimize the potential risk of inhaling mercury vapors:

- Ensure the projector is installed only in ventilated rooms.
- Replace the lamp module before the end of its operational life.
- Promptly ventilate the room after a lamp rupture, explosion has occurred, evacuate the room (particularly in case of a pregnant woman).
- Seek medical attention if unusual health conditions occur after a lamp rupture, explosion, such as headache, fatigue, shortness of breath, chest-tightening coughing or nausea.

### 2.2 General

---



**WARNING:** Before installing the projector, read first the safety instructions.

---

#### Ambient Temperature Conditions.

Careful consideration of things such as image size, ambient light level, projector placement and type of screen to use are critical to the optimum use of the projection system.

Max. ambient temperature : 35°C or 95 °F

Min. ambient temperature : 10 °C or 50 °F

The projector will not operate if ambient air temperature falls outside this range (10°C- 35°C or 50°F-95°F).

Storage temperature: -35°C to +65°C (-31°F to 149°F)

#### Humidity Conditions

Storage: 0 to 98 % RH Non-condensing

Operation: 0 to 95 % RH Non-condensing



**CAUTION:** Harmful Environmental Contamination Precaution

---

### Environment

Do not install the projection system in a site near heat sources such as radiators or air ducts, or in a place subject to direct sunlight, excessive dust or humidity. Be aware that room heat rises to the ceiling; check that temperature near the installation site is not excessive.

### Environment condition check

A projector must always be mounted in a manner which ensures the free flow of clean air into the projectors ventilation inlets. For installations in environments where the projector is subject to airborne contaminants such as that produced by smoke machines or similar (these deposit a thin layer of greasy residue upon the projectors internal optics and imaging electronic surfaces, degrading performance), then it is highly advisable and desirable to have this contamination removed prior to it reaching the projectors clean air supply. Devices or structures to extract or shield contaminated air well away from the projector are a prerequisite, if this is not a feasible solution then measures to relocate the projector to a clean air environment should be considered.

Only ever use the manufacturer's recommended cleaning kit which has been specifically designed for cleaning optical parts, never use industrial strength cleaners on the projector's optics as these will degrade optical coatings and damage sensitive optoelectronics components. Failure to take suitable precautions to protect the projector from the effects of persistent and prolonged air contaminants will culminate in extensive and irreversible ingrained optical damage. At this stage cleaning of the internal optical units will be non-effective and impracticable. Damage of this nature is under no circumstances covered under the manufacturer's warranty and may deem the warranty null and void. In such a case the client shall be held solely responsible for all costs incurred during any repair. It is the clients responsibility to ensure at all times that the projector is protected from the harmful effects of hostile airborne particles in the environment of the projector. The manufacturer reserves the right to refuse repair if a projector has been subject to wantful neglect, abandon or improper use.

### Special Care for Laser Beams

Special care should be used when DLP projectors are used in the same room as performant laser equipment. Direct or indirect hitting of a laser beam on to the lens can severely damage the Digital MicroMirror Devices™ in which case there is a loss of warranty

### Which screen type ?

There are two major categories of screens used for projection equipment. Those used for front projected images and those for rear projection applications.

Screens are rated by how much light they reflect (or transmit in the case of rear projection systems) given a determined amount of light projected toward them. The 'GAIN' of a screen is the term used. Front and rear screens are both rated in terms of gain. The gain of screens range from a white matte screen with a gain of 1 (x1) to a brushed aluminized screen with a gain of 10 (x10) or more. The choice between higher and lower gain screens is largely a matter of personal preference and another consideration called the Viewing angle. In considering the type of screen to choose, determine where the viewers will be located and go for the highest gain screen possible. A high gain screen will provide a brighter picture but reduce the viewing angle. For more information about screens, contact your local screen supplier.

### What image size? How big should the image be?

The projector is designed for projecting an image size : min 1.00m (3.3ft) to max 15 m (49.2ft) (depending on the ambient light conditions), with an aspect ratio of 4 to 3.

## 2.3 Projector Configuration

---

### Which configuration can be used?

The projector can be installed to project images in four different configurations:

- Front/table
- Rear/table
- Front/ceiling
- Rear/ceiling

### Positioning the projector

The projector should be installed perpendicular with the screen on a distance PD and water leveled in both directions. The mounting positions in the following images are shown for a nominal lens position.

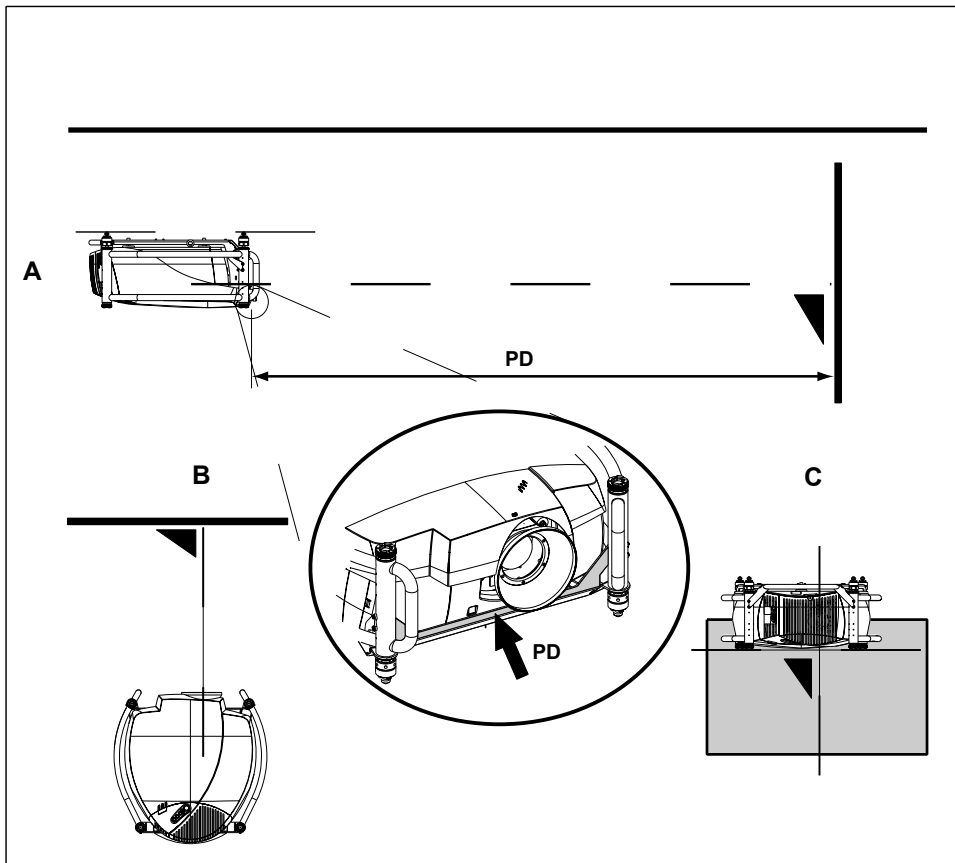

Image 2-1  
Front-Ceiling configuration

- A Side view
- B Top view
- C Back view
- PD Distance projector - screen

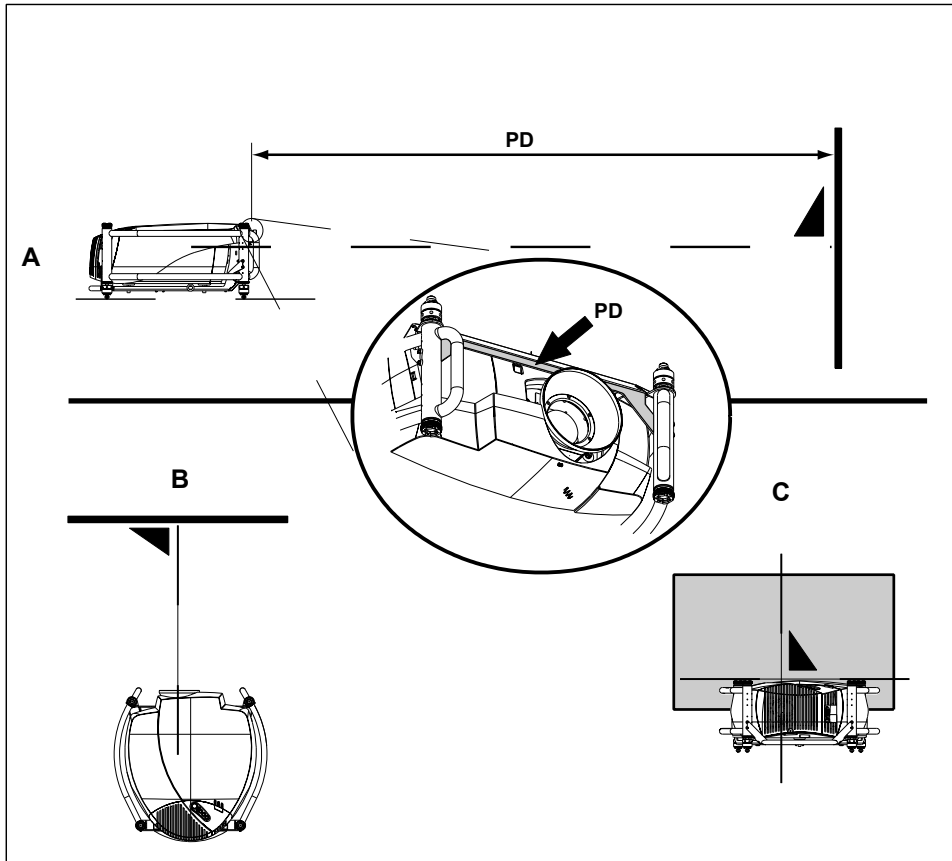

Image 2-2  
Front-Table configuration

- A Side view
- B Top view
- C Back view
- PD Distance projector - screen

## 2.4 Safety Area around projector

### Safety area

Make sure the projector is located so that the air inlets and outlets for the cooling system are not obstructed.

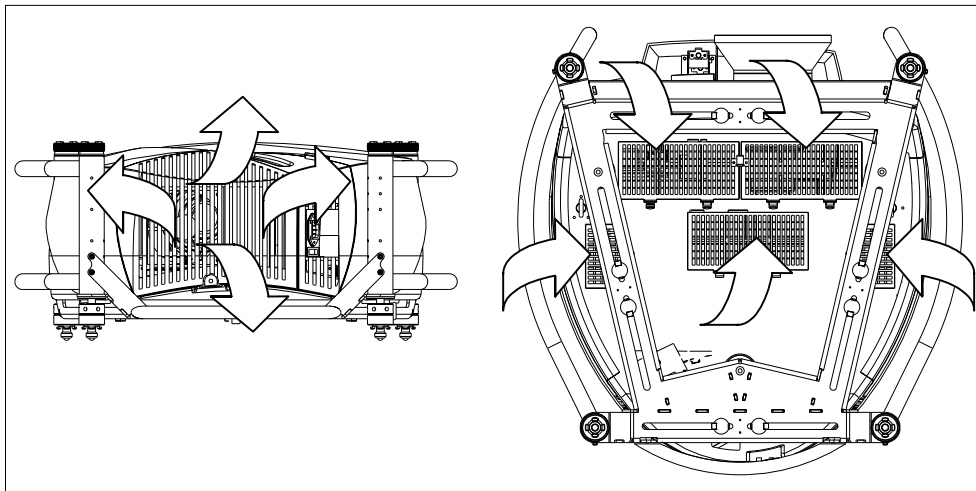

Image 2-3  
Air flow, safety area

## 2.5 Lenses

### Overview

- Lenses
- Lens formulas
- Lens installation
- Cleaning the lens

### 2.5.1 Lenses

#### Available lenses

Lenses	Order number
RLD(0.8)	R9832640
RLD(1.5-1.8)	R9832642
RLD(1.8-2.25)	R9832643
RLD(2.25-3.0)	R9832644
RLD(3.0-4.5)	R9832645
RLD(4.5-7.0)	R9832646



TLD lenses can be used on the projector together with the optional Lens Adapter kit TLD/RLM (order number : R9832650).

### 2.5.2 Lens formulas

#### Formulas

		Metric Formulas (meter)	Inch formulas (inch)
RLD(0.8)		$PD = 0.82 \times SW + 0.03$	$PD = 0.82 \times SW + 1.18$
RLD(1.5-1.8)	Wide	$PD = 1.4847 \times SW + 0.17$	$PD = 1.4847 \times SW + 6.693$
	Tele	$PD = 1.8331 \times SW - 0.14$	$PD = 1.8331 \times SW - 5.512$
RLD(1.8-2.25) (default lens)	Wide	$PD = 1.8054 \times SW - 0.05$	$PD = 1.8054 \times SW - 1.969$
	Tele	$PD = 2.2725 \times SW - 0.06$	$PD = 2.2725 \times SW - 2.362$
RLD(2.25-3.0)	Wide	$PD = 2.27 \times SW - 0.08$	$PD = 2.27 \times SW - 3.15$
	Tele	$PD = 3.07 \times SW - 0.17$	$PD = 3.07 \times SW - 6.69$
RLD(3.0-4.5)	Wide	$PD = 2.88 \times SW + 0.06$	$PD = 2.88 \times SW + 2.36$
	Tele	$PD = 4.45 \times SW + 0.06$	$PD = 4.45 \times SW + 2.36$
RLD(4.5-7.0)	Wide	$PD = 4.3061 \times SW + 0.23$	$PD = 4.3061 \times SW + 9.055$
	Tele	$PD = 6.9359 \times SW + 0.09$	$PD = 6.9359 \times SW + 3.543$

### 2.5.3 Lens installation



The default lens is standard mounted on the projector when it arrives on your location.

### How to replace with another lens?

Follow the next procedure:

1. Move the handle (A) of the lens anchor system to the left and take out the lens.
2. Take the new lens assembly out of its packing material and remove the lens caps on both sides.
3. Push the lens, motors at the top, in the lens block gap horizontally, lining up the motor connector on the lens with the connector on the lens block (B). (image 2-4)  
**Caution:** *On a table mounted projector, hold the projector when pushing the lens into the lens block to avoid sliding off from the table.*
4. Move the handle (A) of the lens anchor system to the right (front view, table mount) to lock the lens.

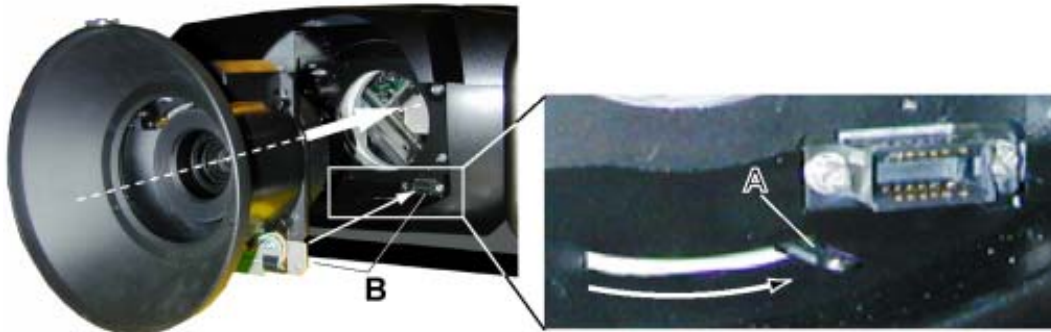

Image 2-4

### 2.5.4 Cleaning the lens



To minimize the possibility of damage to optical coatings, or scratches to lens surfaces, we have developed recommendations for clean. **FIRST**, we recommend you try to remove any material from the lens by blowing it off with clean, dry deionized air. **DO NOT** use any liquid to clean the lenses.

---

#### Necessary tools

Toraysee™ cloth (delivered together with the lens kit). Order number : R379058.

#### How to clean the lens ?

Proceed as follow :

1. Always wipe lenses with a CLEAN Toraysee™ cloth.
2. Always wipe lenses in a single direction.  
**Warning:** *Do not wipe back and forwards across the lens surface as this tends to grind dirt into the coating.*
3. Do not leave cleaning cloth in either an open room or lab coat pocket, as doing so can contaminate the cloth.
4. If smears occur when cleaning lenses, replace the cloth. Smears are the first indication of a dirty cloth.



**CAUTION:** Do not use fabric softener when washing the cleaning cloth or softener sheets when drying the cloth.

Do not use liquid cleaners on the cloth as doing so will contaminate the cloth.

---



Other lenses can also be cleaned safely with this Toraysee™ cloth.

---

## 2.6 Battery Insertion in the Remote Control

---

### Where to find the batteries

The batteries are not placed in the remote control to avoid remote control operation in its package, resulting in a shorter battery life time.

### How to install the batteries

1. Push the cover tab (A) with the fingernail a little backwards and pull upwards the cover top (B). (image 2-5)
2. Slide the cover forwards to remove. (image 2-6)
3. Push the battery body towards the spring and lift it up to remove. (image 2-7)
4. Insert two AA size batteries, making sure the polarities match the + and – marks inside the battery compartment (image 2-7).
5. Insert the lower tab of the battery cover in the gap at the bottom of the remote control, and press the cover until it clicks in place (image 2-6).



Image 2-5  
Battery cover unlock



Image 2-6  
Battery cover removal



Image 2-7  
Battery removal

## 2.7 Stacking projectors

### What is possible?

Up to 2 projectors can be stacked on each other without using extra tools or accessories.

### How to stack?

Handle as follow:

1. Put the second projector on the first one so that base plate of the second projector matches with the rigging socket of the first projector. (image 2-8)
2. Turn the rigging sockets of the second projector counter clockwise until they are free to move up and down. (image 2-9)
3. Secure the projectors on each other by bringing the free part of the second projector into the socket of the first projector and turn a quarter clockwise while pushing downwards until it clicks in.
4. For ceiling mounted configurations, mount a security cable between the lowest projector and the upper projector. (image 2-10)  
**Warning:** Be sure the safe working load of the used security cables and connectors are enough to support one projector. Refer to the supplier of the security cable for safety details.

## 2. Installation Guidelines

---

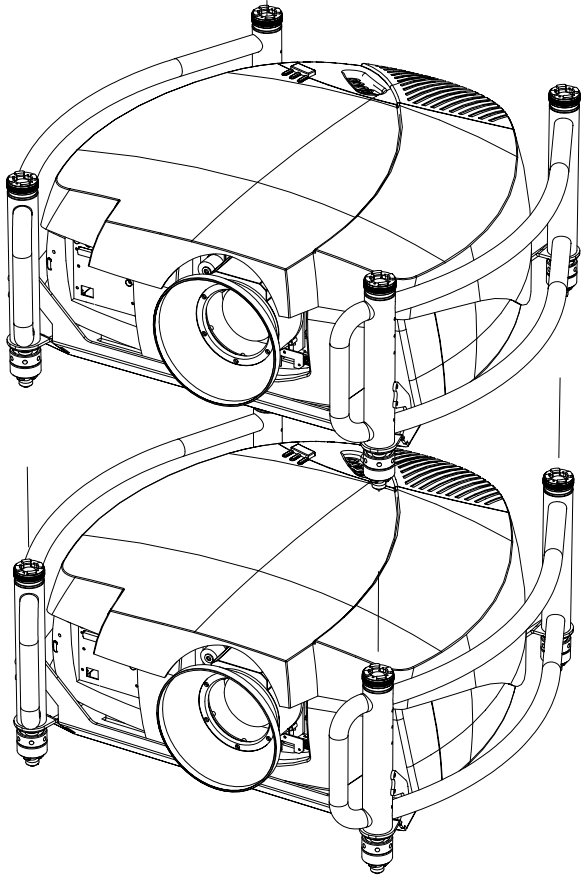

Image 2-8  
Stacking two projectors

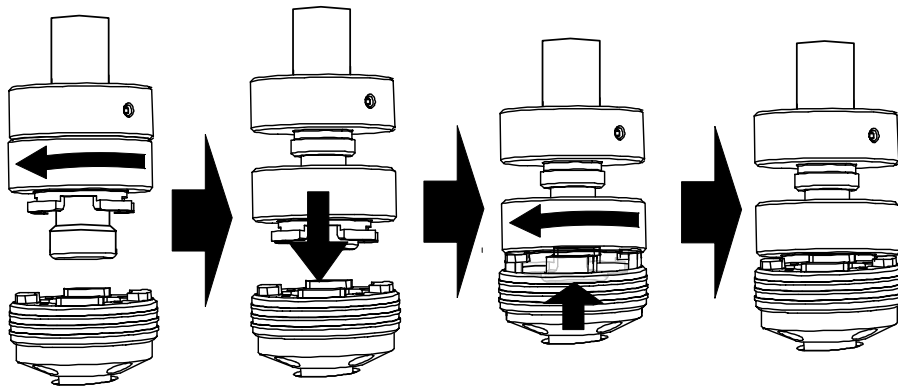

Image 2-9  
Closing the rigging sockets

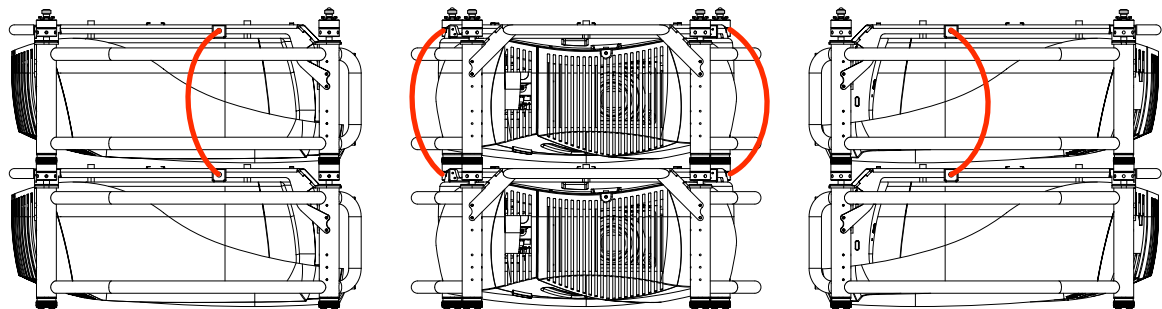

Image 2-10  
Mounting the security chain



## 2.8 Rigging points and accessories

---

### 2.8.1 Overview

#### Clamps

Slots are made in the carry handle frame for easy inserting the overlockers and for easy adjusting the clamps position so that this position matches with the rigging points.

Consult a professional structural engineer prior to suspending the ceiling mount from a structure not intended for that use. Always ensure the working load limit of the structure supporting the projector.



**WARNING: When mounting the projector to the ceiling or to a rigging system, always mount security chains.**

---

#### Complete documentation

For a complete documentation consult manual R5976746.

### 2.8.2 Mounting the clamps

#### Necessary tools

Wrench 17 mm

#### Steps to be taken

1. Insert the mushroom head square neck bolt into the mounting hole (1). (image 2-11)
2. Slide the bolt into the groove until the exact position is reached (2).
3. Slide a washer on the bolt (3).
4. Secure with a first nut (4).
5. Turn a second nut on the bolt (5).
6. Turn the movable connecting-piece almost fully onto the bolt. Stops with a small distance between the clamp assembly and the second nut so that the movable connecting-piece is still turnable (5).
7. Turn now the connecting-piece into the direction of the lens and secure this position by turning up the second nut. (image 2-12)
8. Turn the clamp on the movable connecting-piece.

## 2. Installation Guidelines

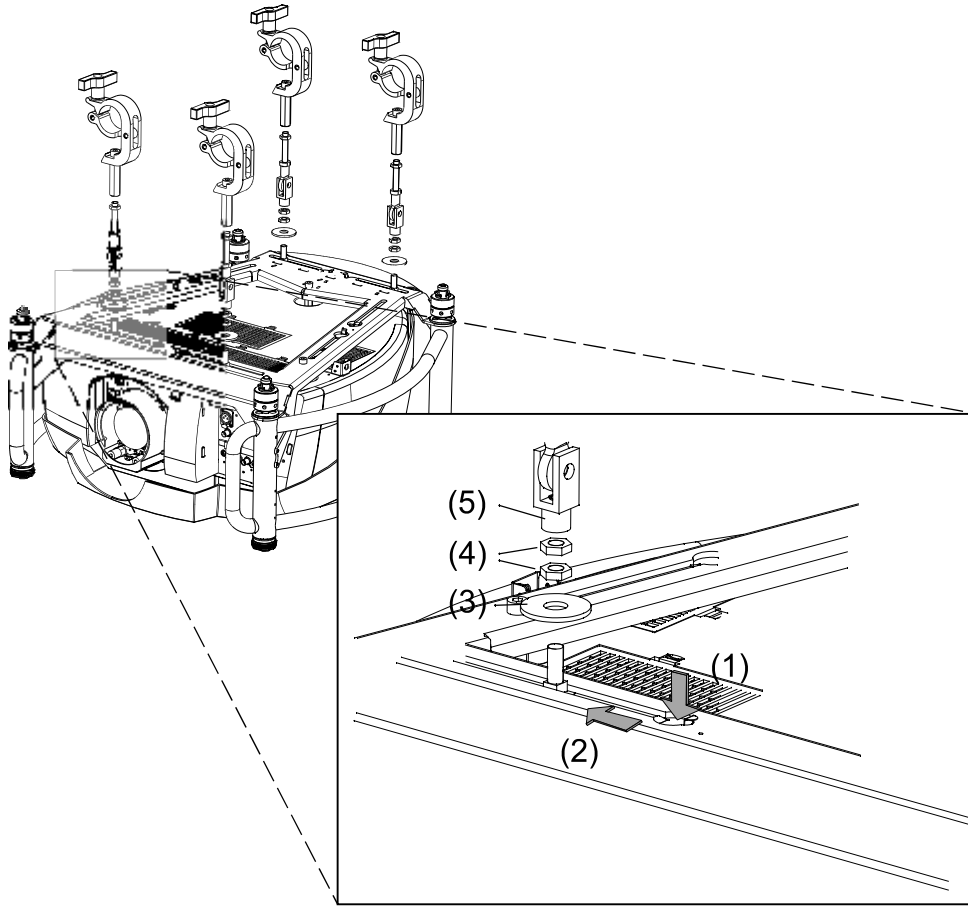

Image 2-11  
Mounting the clamps fixation

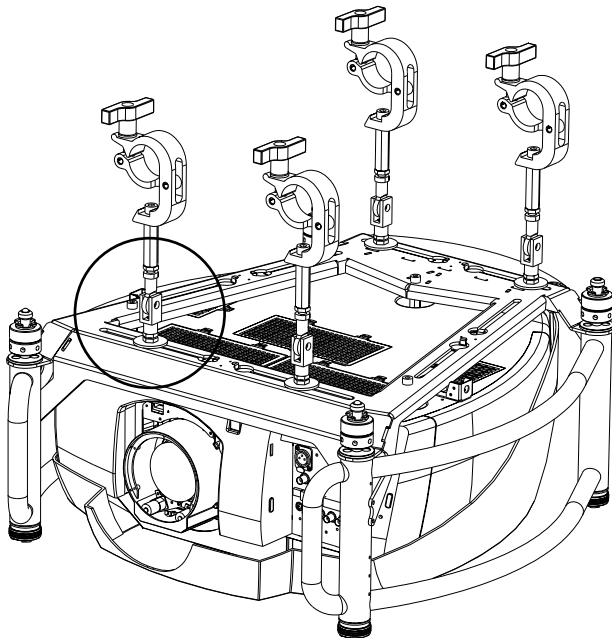

Image 2-12  
Mounting the rigging clamp

## 3. CONNECTIONS

### Overview

- Power connection
- Input Source Connections
- 5-Cable input
- Composite Video Input
- S-Video input
- Digital Visual Interface (DVI) input
- Computer input (RGB analog)
- Serial Digital Interface
- Communication connection
- Extended configuration

### 3.1 Power connection

#### AC power (mains) cord connection

Use the supplied power cord to connect your projector to the wall outlet.

Plug the female power connector into the male connector at the back of the projector. Fixate the power plug with the power cord clamp.



The power input is auto-ranging from 90 to 240 VAC.



Image 3-1  
Power connection

- 1 Power input
- 2 Power cord clamp
- 3 ON/OFF switch

#### Fuses

For continued protection against fire hazard :

- refer replacement to qualified service personnel
- ask to replace with the same type of fuse.

## 3.2 Input Source Connections

---

### Overview

- Input section
- Input facilities

### 3.2.1 Input section

#### Input Layers

The input section is divided in layers, each of them regrouping several inputs, this architecture allows the input section to be upgraded at any time with an optional analog or digital layer.

1. Layer 1: analog layer containing analog data and video inputs.
2. Layer 2: a hybrid layer containing 2 digital and 1 analog input.
3. Layer 3 : SDI and interconnection.
4. Layer 4 : is interconnection layer, with XLR connection and an optional Ethernet connection.

### 3.2.2 Input facilities

#### overview

- 5-cable input
  - component video (PR/Y/PB)
  - RGBS
- composite video
- S-Video
- Digital Visual Input (DVI)
- Computer (analog RGB)
- Serial Digital Input with loop through connection

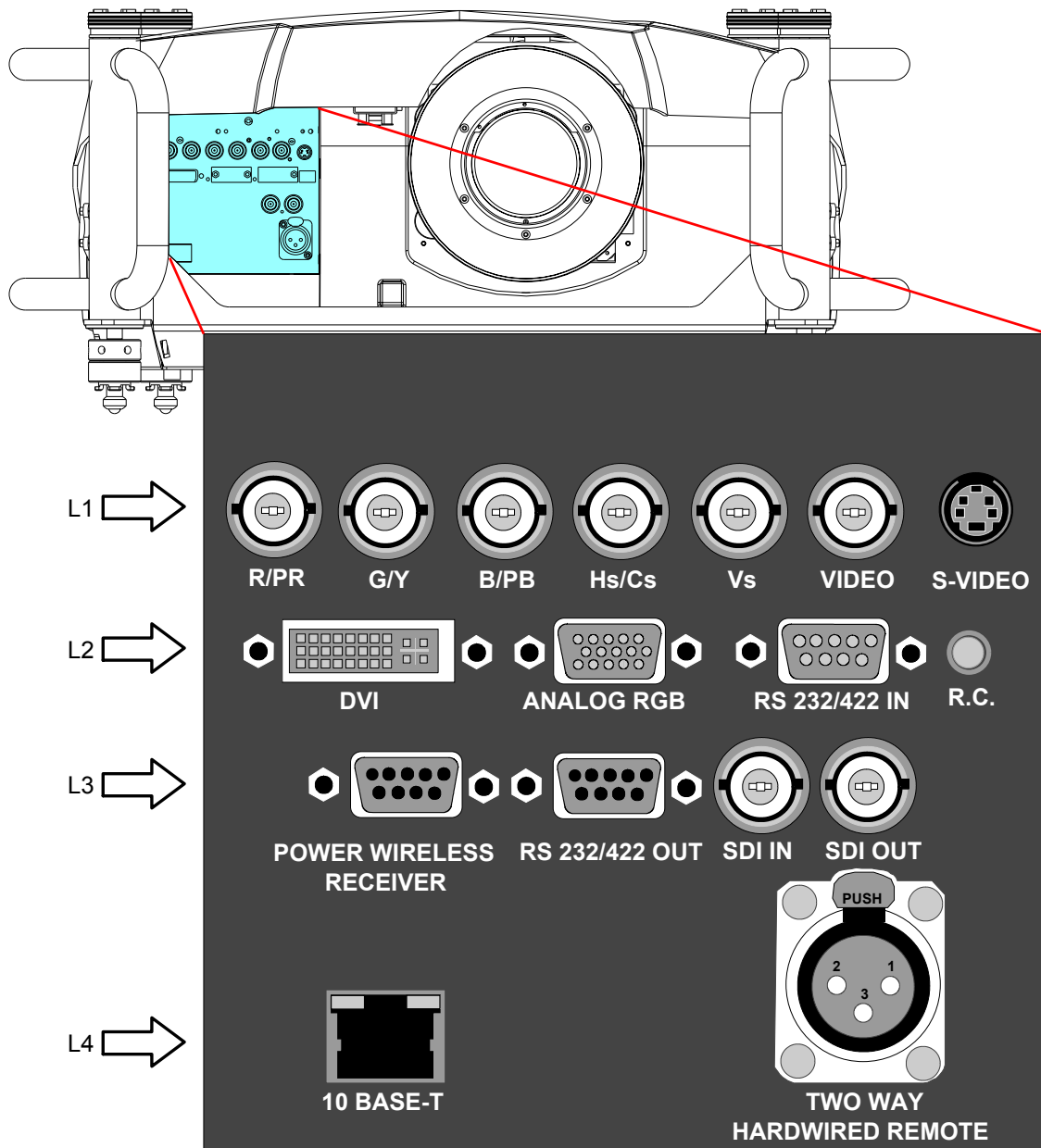

Image 3-2  
Input facilities

- L1 Layer 1 = RGBHV + Composite Video + S-Video
- L2 Layer 2 = DVI + Computer + RS232IN + RC (wired remote control)
- L3 Layer 3 = SDI in and out + RS232OUT + Power wireless receiver
- L4 Layer 4 = Two way hardwired remote + Ethernet

### 3.3 5-Cable input

#### Input specifications

The 5-cable input section is made of 5 BNC input terminals.

0.7 Vpp ± 3dB

75 Ω terminated

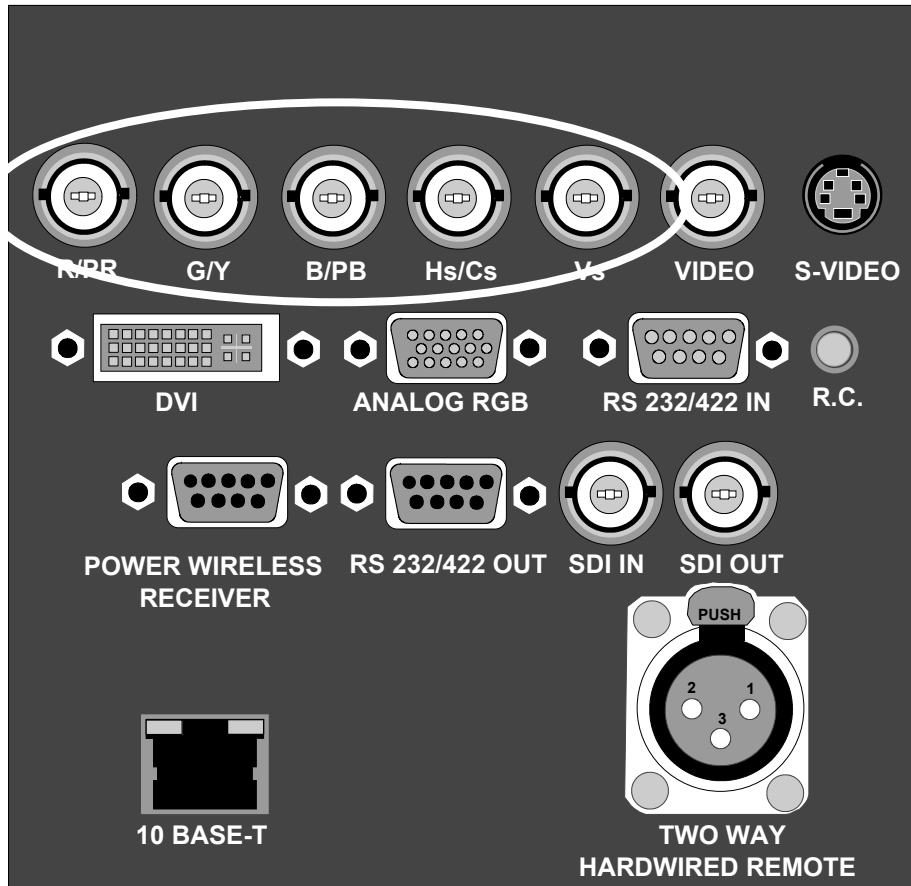

Image 3-3  
5-cable input



**Component Video**

In Component Video the term component describes a number (3) of elements that are needed to make up the video picture, these components are R-Y/Y/B-Y. A composite video signal on the other hand contains all the information needed for the color picture in a single channel of information

**Which signals can be connected ?**

Signals/Input BNC	R	G	B	H	V
RGBHV	R	G	B	H	V
RG <sub>s</sub> B <sup>1</sup>	R	G <sub>s</sub>	B	-	-
RGBS <sup>1</sup>	R	G	B	S	-
Component	PR	Y	PB	-	-



Beside the standard RGB, component and sync signals, the extended mode of the 5 Cable input makes processing of additional signals possible.

**How to select a source on the 5 cable input ?**

1. Press 1 on the RCU

**Note:** Another way for selecting this input is via **Source** on the local keypad or via the Menu

1. data or video



#### Component Video signals (PR/Y/PB)

Some interfaces use progressive output signals with a double line frequency of 32 kHz. The video decoder used for the video signals is not appropriate for these signals since it can only handle 15 kHz signals. This signal has therefore to be internally redirected, this is done in the *Source selection* menu by selecting *Data on BNC's* instead of *Component video* and by selecting *Pr/Y/Pb* in the advanced settings of the *Image file* menu.

## 3.4 Composite Video Input

### Input specifications

The Composite video input section is made of 1 BNC input terminal. Connect Composite video signals from a VCR, OFF air signal decoder, etc..

1.0 Vpp ± 3dB

75 Ω terminated

No loop through

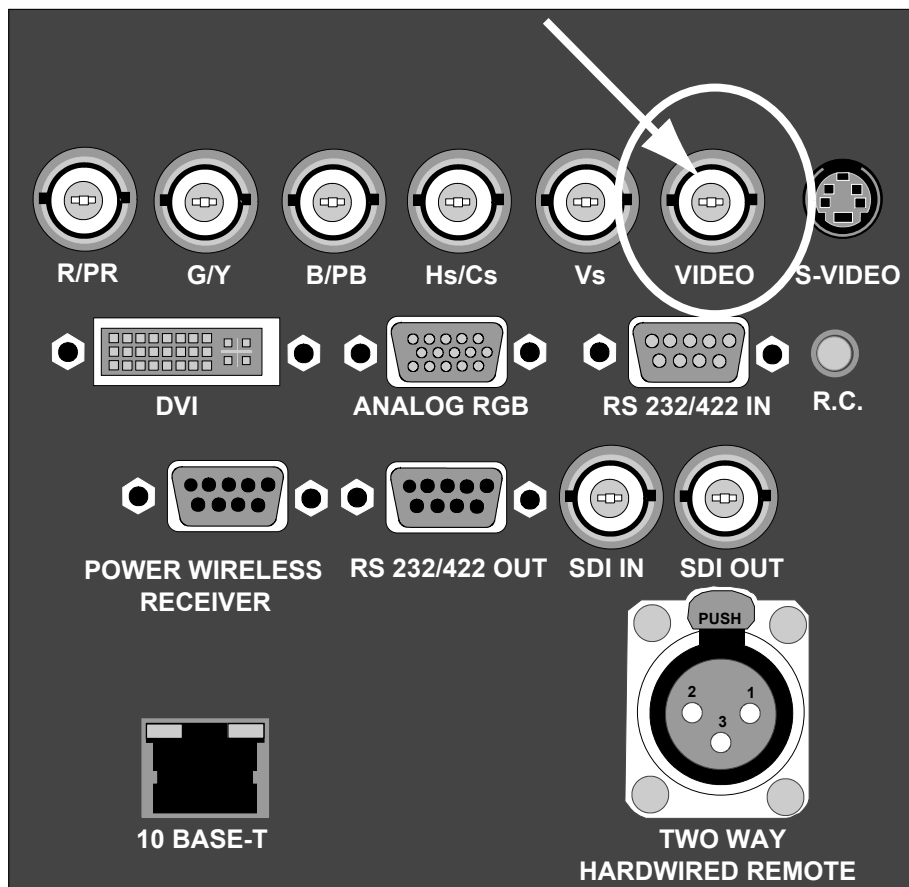

Image 3-4  
Composite Video indication

### How to select a Composite Video Input ?

1. Press **3** on the RCU

**Note:** Another way for selecting this input is via **Source** on the local keypad or via the Menu.



The projector allows the input of more composite video signals (up to 7 composite video signals) when using the 5 cable input in extended configuration. Press 3 to browse through the possible video sources.

### 3.5 S-Video input

#### Input specification

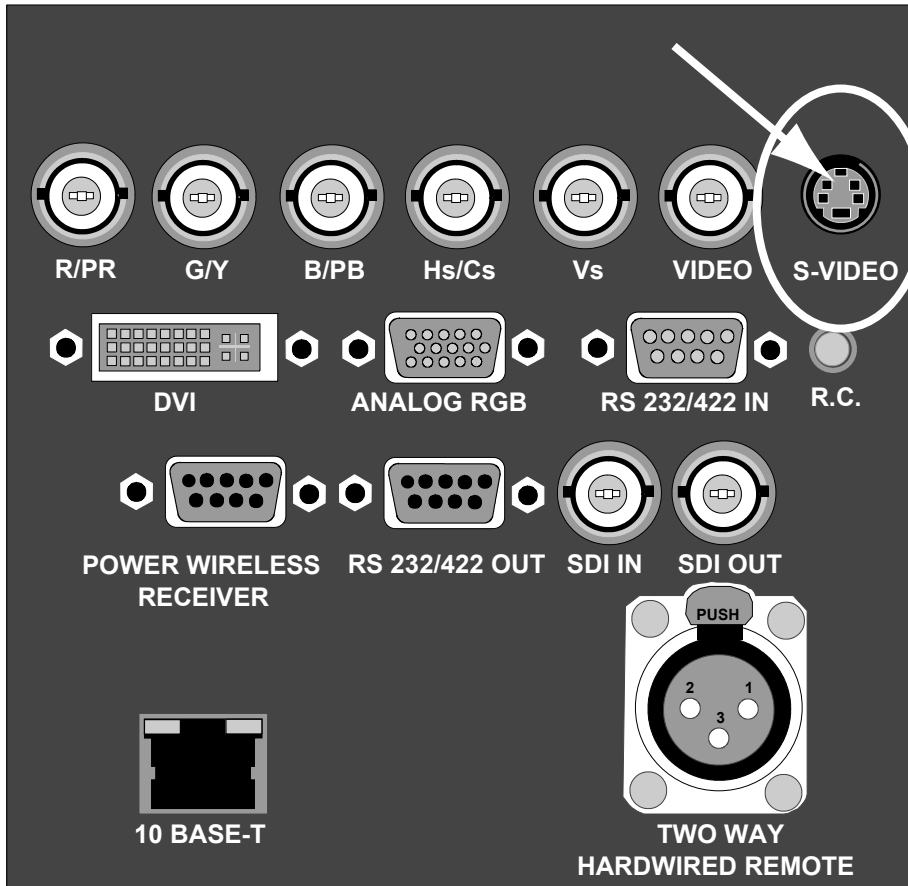

Image 3-5  
S-Video indication

#### Pin configuration 4 pin connector

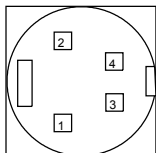

Image 3-6

##### For S-Video

- pin 1 : earth (ground) luminance
- pin 2 : earth (ground) chrominance
- pin 3 : luminance signal (Y) 1Vpp ±3dB
- pin 4 : chrominance signal (C) 300mVpp

##### For Video

- pin 1 : earth (ground) video Y
- pin 2 : earth (ground) video C
- pin 3 : video Y signal
- pin 4 : video C signal



##### Chrominance

The color component of a video signal that includes information about tint and saturation.



##### Luminance

The component of a video signal that includes information about its brightness.



---

### Which signal can be connected ?

Standard S-Video (S-VHS) with separate Y (luma) and C (chroma) signals.



In extended mode also Composite video can be connected to the S-Video plug.

---

### How to select the S-Video input ?

1. Press **4** on the RCU

**Note:** Another way for selecting this input is via **Source** on the local keypad or via the Menu.



The projector allows the input of more S-Video signals (up to 3 S-Video signals) via the S-Video extended configuration.

---

## 3.6 Digital Visual Interface (DVI) input

---



### DVI

Digital Visual Interface is a display interface developed in response to the proliferation of digital flat panel displays.

The digital video connectivity standard that was developed by DDWG (Digital Display Work Group). This connection standard offers two different connectors: one with 24 pins that handles digital video signals only, and one with 29 pins that handles both digital and analog video. This standard uses TMDS (Transition Minimized Differential Signal) from Silicon Image and DDC (Display Data Channel) from VESA (Video Electronics Standards Association).

DVI can be single or dual link.

---

### Input specifications

Single link DVI

Differential input voltage: 200 mV - 800 mV

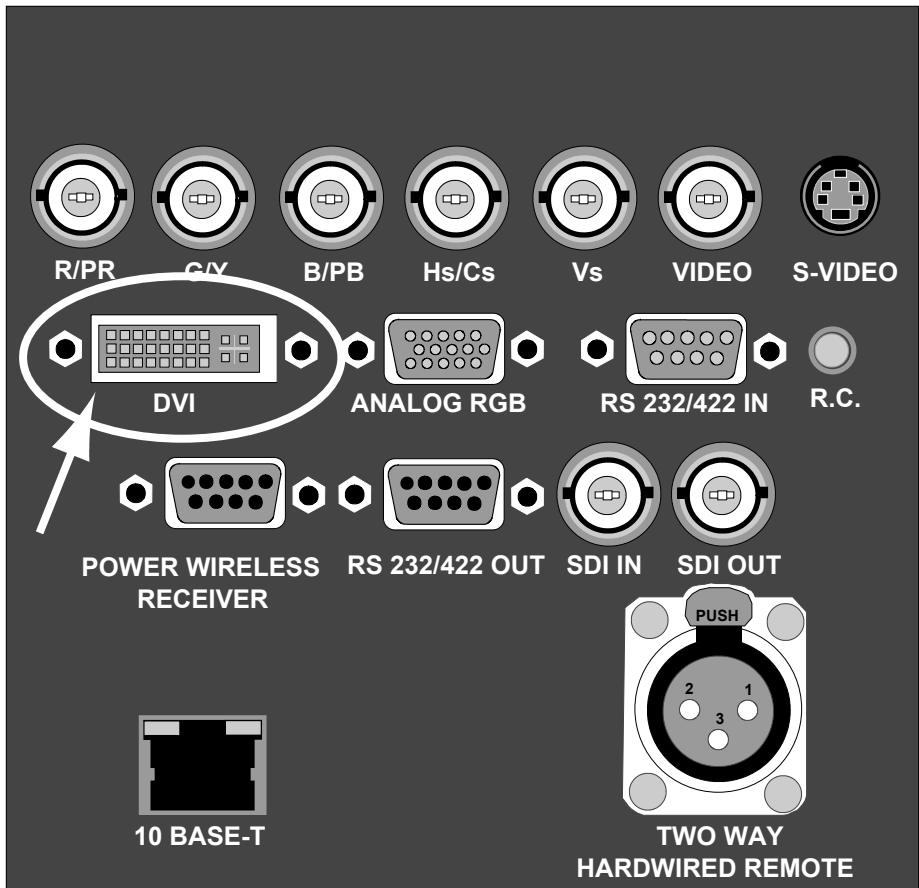

Image 3-7  
DVI indication. DVI-I type connector analog link (4 pins at the right side of the connector) not supported.

**Pin assignment for the DVI connector.**

Pin 1	TMDS DATA2-	Pin 13	TMDS DATA3+
Pin 2	TMDS DATA2+	Pin 14	+5 Power
Pin 3	TMDS DATA2/4 Shield	Pin 15	Ground (for +5V)
Pin 4	TMDS DATA4-	Pin 16	Hot Plug Detect
Pin 5	TMDS DATA4+	Pin 17	TMDS DATA0-
Pin 6	DDC Clock	Pin 18	TMDS DATA0+
Pin 7	DDC Data	Pin 19	TMDS DATA0/5 Shield
Pin 8	Not connected	Pin 20	TMDS DATA5-
Pin 9	TMDS DATA1-	Pin 21	TMDS DATA5+
Pin 10	TMDS DATA1+	Pin 22	TMDS Clock Shield
Pin 11	TMDS DATA1/3 Shield	Pin 23	TMDS Clock+
Pin 12	TMDS DATA3-	Pin 24	TMDS Clock-

**How to select the DVI Input ?**

1. Press **5** on the RCU

**Note:** Another way for selecting this input is via **Source** on the local keypad or via the Menu.

### 3.7 Computer input (RGB analog)

#### Input specification

TTL sync input :  $U_{\min} = 2.0 \text{ V}$

RGB input =  $0.7 \text{ V}_{\text{pp}} \pm 3\text{dB}$

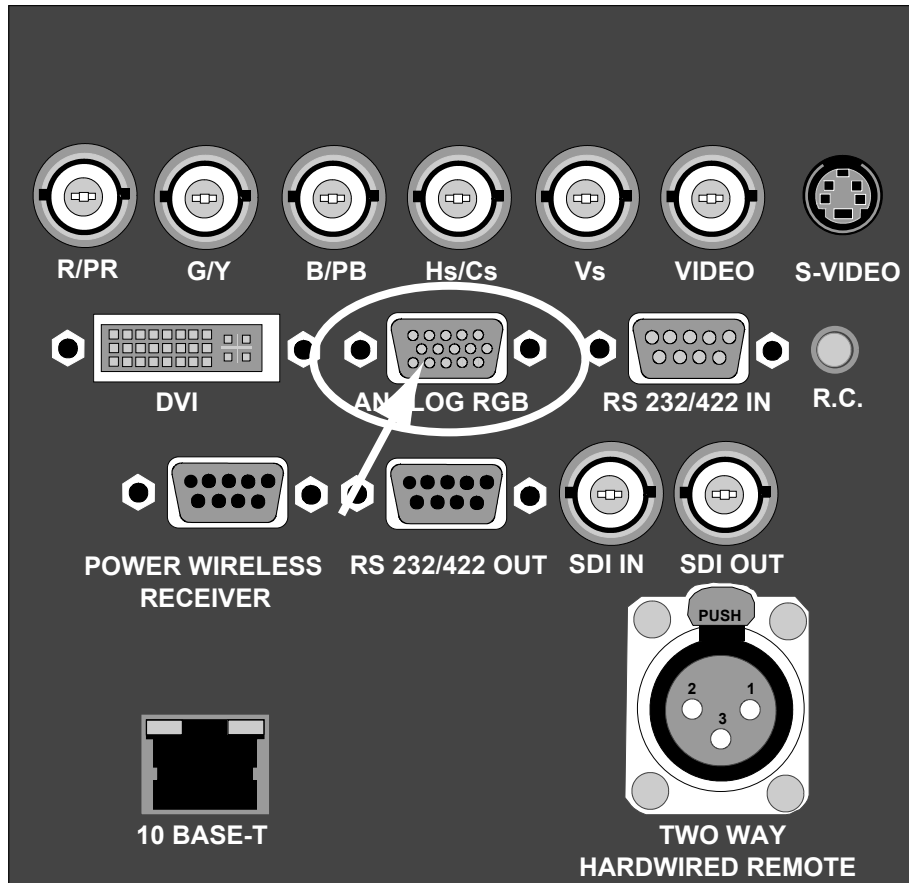

Image 3-8  
Analog RGB input

#### What can be connected ?

- RGBHV
- $\text{RG}_{\text{s}}\text{B}$



Composite sync only possible on Green

#### How to select a computer input ?

1. Press 2 on the RCU

**Note:** Another way for selecting this input is via **Source** on the local keypad or via the Menu.

### 3.8 Serial Digital Interface



SDI

Serial Digital Interface

### 3. Connections

#### Input specifications

SDI input : BNC

SDI output : BNC (= loop through)

typical : 0.8 Vpp

75Ω terminated

output impedance: 75Ω

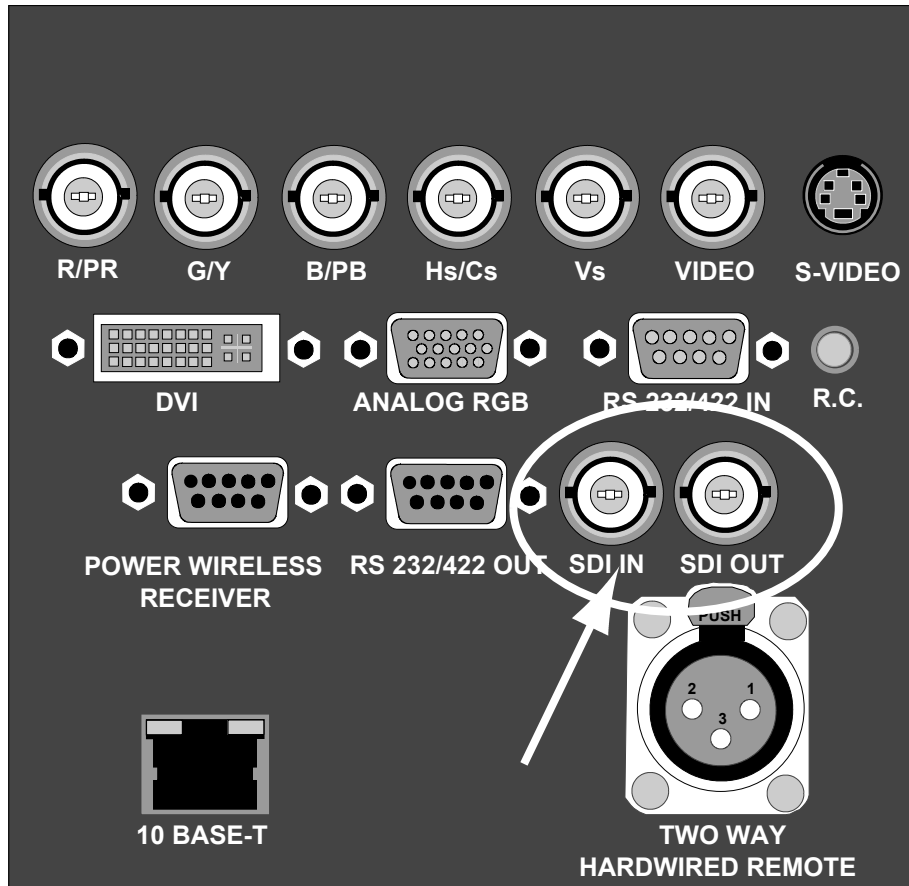

Image 3-9  
SDI in - out

#### How to select the SDI input

1. Press 7 on the RCU

**Note:** Another way for selecting this input is via **Source** on the local keypad or via the Menu.

## 3.9 Communication connection

### Overview

- RS232 IN connection
- Wireless receiver

#### 3.9.1 RS232 IN connection

##### What can be connected to the RS232/422 IN connection ?

The RS232 IN connection allows the projector to communicate with a computer e.g. IBM PC or Apple Macintosh.

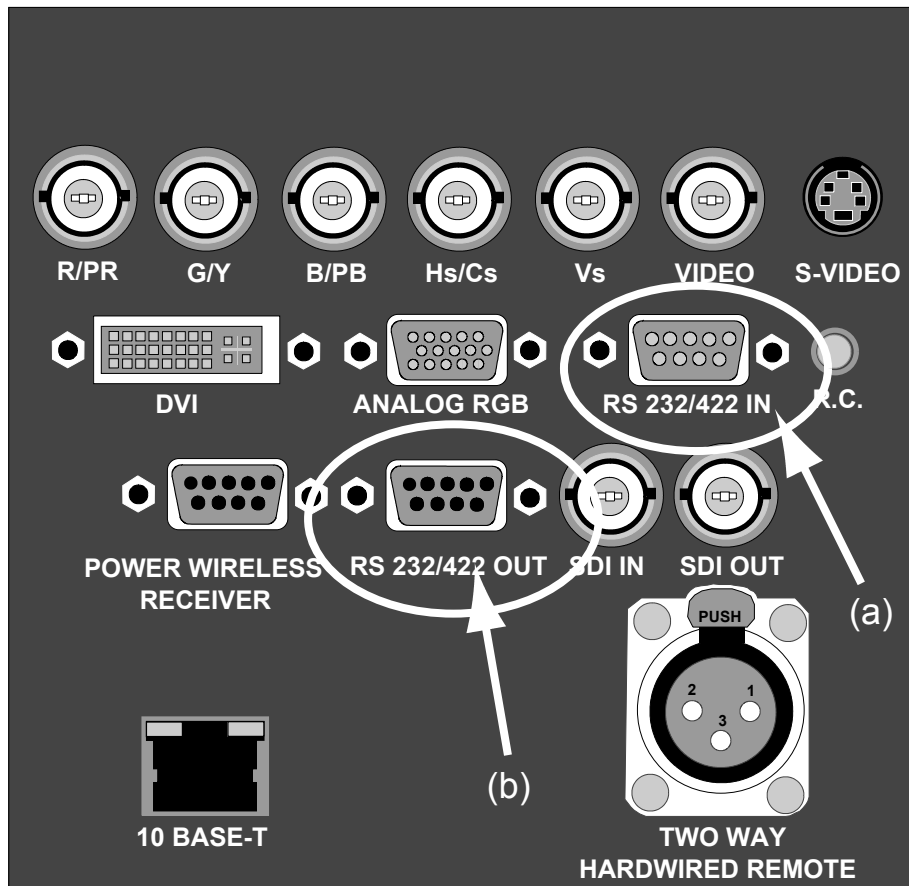

Image 3-10  
RS232/422 communication

- a RS232/422 IN
- b RS232/422 OUT

### Applications of the RS232/422 connection

Remote control:

- easy adjustment of projector via IBM PC (or compatible) or MAC connection.
- address range from 0 to 255.
- allow storage of multiple projector configurations and set ups.
- wide range of control possibilities.

Data communication: sending data to the projector or copying the data from the projector to the computer.

### What can be connected to the RS232/422 OUT connection ?

The output is a loop through output for RS232/422 signal and can be connected to the RS232/422 IN of the next projector.



To set up the baud rate of the projector, see chapter Installation menu, RS baudrate.

### 3.9.2 Wireless receiver

#### What can be connected ?

The optional wireless receiver for the optional rugged remote control can be connected to the **Power wireless receiver** output and to the **RS232/422 IN**. With these tools, it is possible to control the projector from a distance without using cables.

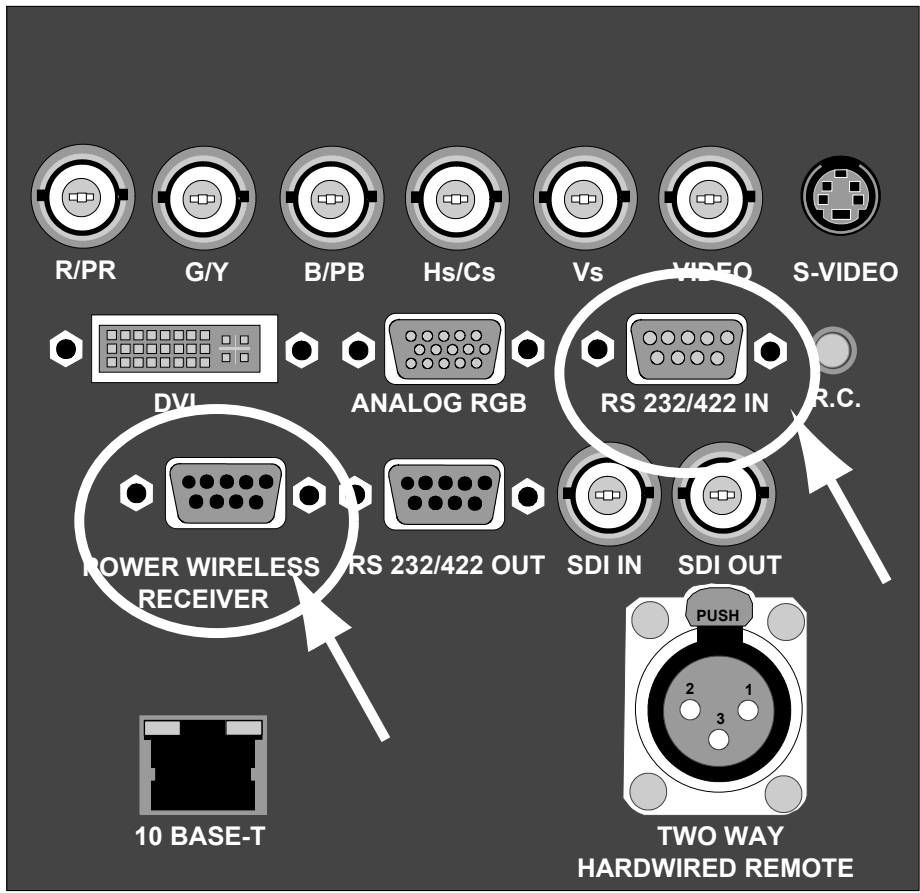

Image 3-11  
Wireless receiver connection

### 3.10 Extended configuration

#### Overview

- Introduction
- 5-cable extended configuration
- S-Video extended configuration
- Summarizing

#### 3.10.1 Introduction

##### What can be done ?

The extended configuration allows to connect multiple equal source types to the inputs and allow switching between this wide range of input signals.

#### 3.10.2 5-cable extended configuration

##### What can be done ?

Beside the standard RGB, composite & sync signals, the extended capabilities of the 5-cable inputs make treatment of additional signals possible:

- a composite video signal may be connected to 4 of the 5 BNC's (beside the standard video BNC input)
- a S-Video signal can be connected

		Inputs					
		R	G	B	H	V	VIDEO
Signals	RGBHV	R	G	B	H	V	-
	RG <sub>S</sub> B	R	G <sub>S</sub>	B	-	-	-
	RGBS	R	G	B	S	-	-
	Component	PR	Y	PB	-	-	-
	S-Video	-	-	-	-	C	Y
	S-Video	C	-	Y	-	-	-
	Composite	VIDEO	-	-	-	-	-
	Composite	-	VIDEO	-	-	-	-
	Composite	-	-	VIDEO	-	-	-
	Composite	-	-	-	-	VIDEO	-
	Composite	-	-	-	-	-	VIDEO

Table 3-4  
Extended configuration of the 5-cable input: the first column gives the possible signals, and the first row the 5 cable input connectors (+ the standard Video BNC).

### How to set up the 5-cable extended configuration ?

1. Connect the video or S-video source to the desired BNC connector  
**Note:** In some cases an adapter cable is required (image 3-12, image 3-13, image 3-14)

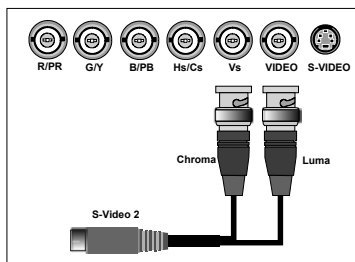

Image 3-12  
Connecting an S-Video signal on the Vs & Video BNC

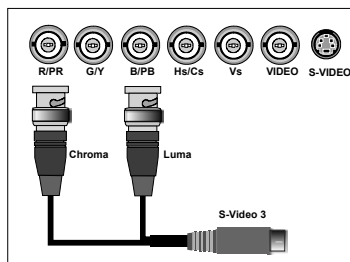

Image 3-13  
Connecting an S-Video signal on the R&B BNC

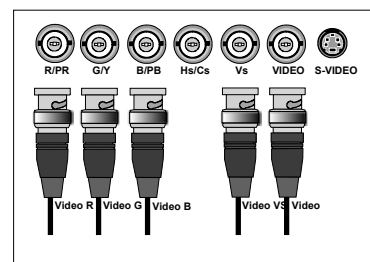

Image 3-14  
Connecting composite Video signals on the 5-cable input



**Multiple video signals can not be visualized simultaneously since there is only one decoder.**

### 3.10.3 S-Video extended configuration

#### What can be done ?

Beside the standard luminance (Y) and chrominance (C) signals, the advanced capabilities of the S-Video input make treatment of additional signals possible:

- 2 composite video signal may be connected.

		Inputs	
		Y	C
Signals	S-Video	Y	C
	Composite Video	Video	-
	Composite Video	-	Video

Table 3-5  
Extended configuration of the S-Video input: the first column gives the possible signals, and the first row the S-Video inputs pins.

#### How to set up the S-Video extended configuration ?

1. Connect the video sources to the desired connector (image 3-15)

**Note:** An adapter cable is required

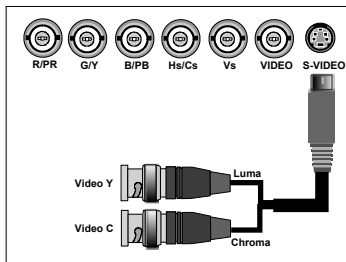

Image 3-15  
Connecting 2 composite Video signals to the S-Video connector



**Multiple video signals can not be visualized simultaneously since there is only one decoder.**

---

#### 3.10.4 Summarizing

##### Composite video signals

A composite video signal can be entered via 7 different inputs, which gives you 7 different video signals (optional video input not included).

1. Video R : via 1st BNC
2. Video G : via 2nd BNC
3. Video B : via 3rd BNC
4. Video VS : via 5th BNC
5. Video : via the standard composite video BNC input
6. Video Y : via S-Video input
7. Video C : via S-Video input

Key **3** on the RCU allows to browse through the active video inputs, each hit moves to the next active video input. The first hit on key 3 selects the last selected video input.

##### S-Video signals

An S-Video source can be connected in 3 different ways, through 3 different inputs.

1. S-Video 1: via the standard S-Video input
2. S-Video 2 : via the 5<sup>th</sup> BNC and the standard Composite Video input
3. S-Video 3 : via the 1st and the 3rd BNC

Key **4** on the RCU allows to browse through the active S-Video inputs, each hit moves to the next active video input. The first hit on key 4 selects the last selected video input.



## 4. GETTING STARTED

### Overview

- Terminology overview
- Switching on
- Lamp runtime
- Switching to standby
- Switching off
- Temperature error DMD
- Using the RCU
- Projector address
- Controlling the projector
- Quick lens adjustment
- Digital Zoom
- Quick Picture in Picture selection

### 4.1 Terminology overview

---

#### Overview

The following table gives an overview of the different functionalities of the keys.

#### 4. Getting Started

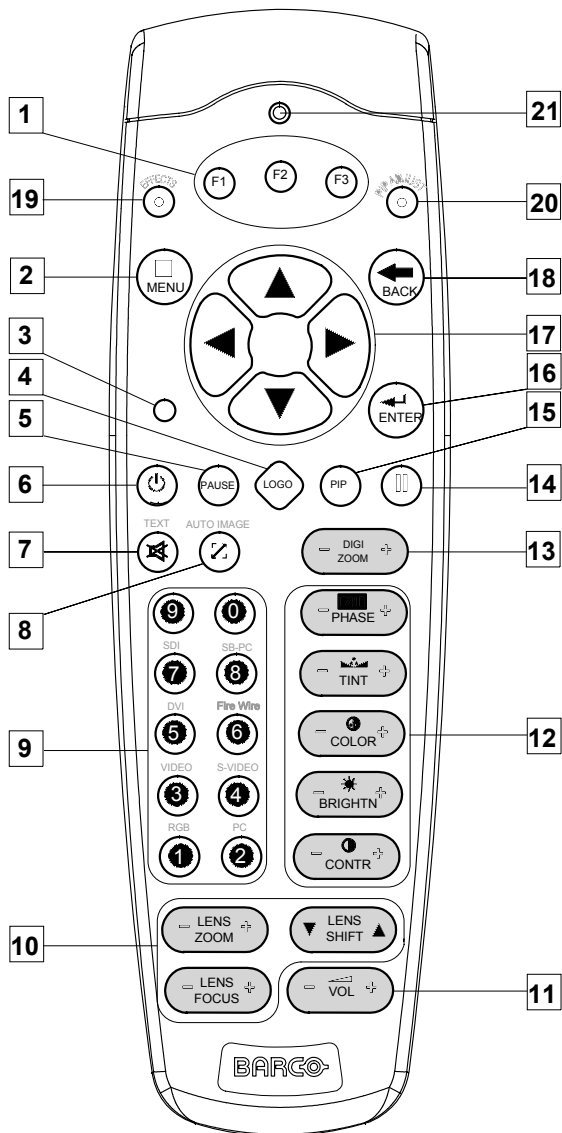

Image 4-1

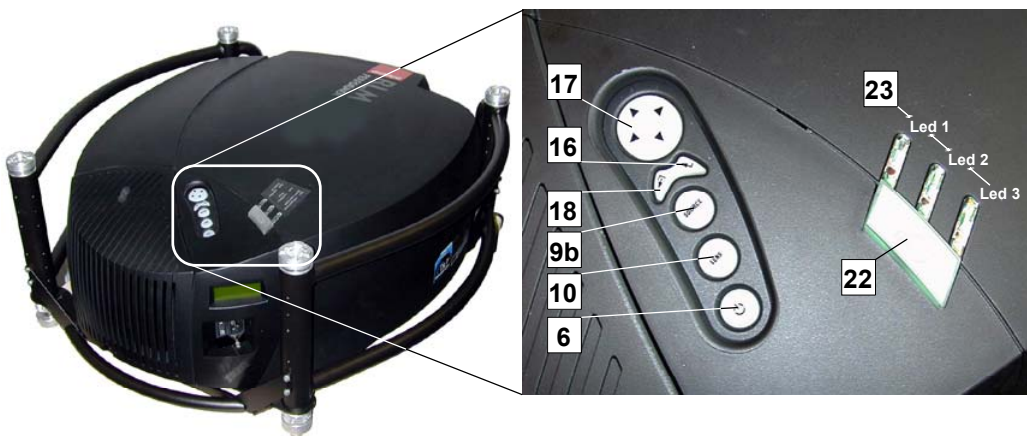

Image 4-2

No.	Key name	Description
1	Function keys	user programmable keys with functions for direct access.
2	MENU	Menu key, to enter or exit the Tool bar menu.
3	Address key	(recessed key), to enter the address of the projector (between 0 and 9). Press the recessed address key with a pencil, followed by pressing one digit button between 0 and 9.
4	LOGO key	allows to recall the stored Logo (not in PiP mode)
5	PAUSE	to stop projection for a short time, press 'PAUSE'. The image disappears but full power is retained for immediate restarting.
6	STBY	standby button, to start projector when the power switch is switched on and to switch off the projector without switching off the power switch. <b>Attention : Switching to Standby. When the projector is running and you want to go to standby, press the standby key for 2 seconds.</b>
7	TEXT	to des-activate or activate the on screen dialog boxes and menus.
8	AUTOIMAGE	Auto image, to center the image on the active DMD surface.
9	Digit buttons	direct input selection.
9b	SOURCE button	this button allows to switch through the active (scanned) inputs
10	Lens control	use these buttons to obtain the desired ZOOM, SHIFT, FOCUS.
11	VOL	Used as lens shift left - right.
12	Picture controls	use these buttons to obtain the desired picture analog level.
13	DIGI ZOOM	allows a digital Zoom of a part of the image
14	FREEZE	press to freeze the projected image.
15	PIP	allows to activate the PICTURE IN PICTURE mode
16	ENTER	to confirm an adjustment or selection in the MENU. On the local keypad and the RCU, the ENTER button additionally accesses the PIP window re-size function
17	Cursor keys	Cursor Keys on RCU or on the local keypad : to make menu selections or to access the menu bar.
18	BACK	to leave the selected menu or item (go upwards to previous menu).
19	EFFECTS	not yet implemented
20	PIP ADJUST	allows to select a PiP window and change its configuration on screen
21	RC operating indication	lights up when a button on the remote control is pressed. (This is a visual indicator to check the operation of the remote control)
22	IR receiver	IR receiver

	Green	Red
Led 1	IR acknowledgement	Standby
Led 2		Hardware error
Led 3	Cool down sequence: flickers 60 seconds after switching to standby	rescue program (software error)

## 4.2 Switching on

---

### How to switch on.

1. Press the power switch to switch on the projector.
  - When '0' is pushed in, the projector is switched off.
  - When '1' is pushed in, the projector is switched on

The projector starts in standby mode, LED1 is red.

### Starting image projection.

1. Press **Standby** key once on the local keypad or on the remote control.

**Note:** It may take about 60 seconds before image projection, i.e. no projection until the completion of several operations (software initialization,...).

**Note:** If the Security mode is enabled, a text box will be displayed for PIN code entry, see Security setting in the Installation menu

**Note:** If Identification screen is on, the Identification screen will be displayed during start up.



**CAUTION:** Pushing the standby key too long, might cause the projector to shut down right after an image is displayed.

---

## 4.3 Lamp runtime

---



x

To generalize for the different projector types, x refers here to the maximum run time of the lamp. The maximum run time is given in the specifications.

---

### Lamp runtime indication while running

Independently of the lamp mode, when the total runtime of an active lamp (lamp 1 for example) is (x -30) hours or more, a warning message will be displayed.

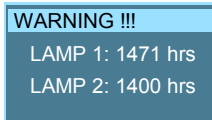

Image 4-3  
warning message

This warning message will be repeated at the next start up. Press **BACK** or **MENU** to remove the message.

The total lifetime of the lamp (single lamp) for a safe operation is x hours max., do not use it longer. Always replace with a same type of lamp. Call a Barco authorized service technician for lamp replacement.

Lamp management when the lamp runtime is reached in the different lamp modes is indicated in the next image.

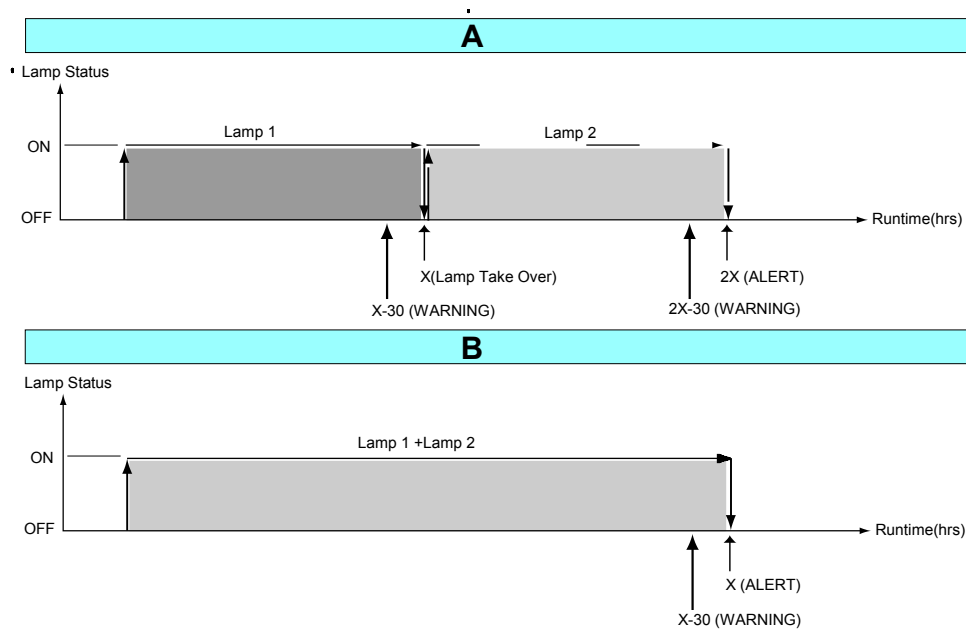

Image 4-4  
Lamp runtime management

- A Single lamp mode
- B Dual lamp mode
- x Maximum lamp runtime

In single mode, a lamp switch will be executed as far as the second lamp has not reached its maximum runtime.



**WARNING:** Using a lamp for more than x hours is dangerous as the lamp could explode.

The lamp runtime reset as well as the lamp replacement can only be done by a Barco authorized technician.

## 4.4 Switching to standby

### How to switch to standby?

1. Press **Standby** to switch the projector to standby.



**Switching to Standby.** When the projector is running and you want to go to standby, press the standby key for 2 seconds until the message 'Saving data, please wait' is displayed. Do not press any longer on the standby key otherwise the projector will restart.

## 4.5 Switching off

### How to switch off the projector?

1. Press first **Standby**.
2. Let cool down the projector until the fans stop blowing, at least 15 min.
3. Switch off the projector with the power switch.

## 4.6 Temperature error DMD

### Overview

When the temperature of one of the DMD is too low or too high the projector will be switched automatically to standby. Before switching to standby, the following message appears for 3 seconds on the screen : 'DMD out of operating temperature range. Automatic shutdown is activated.'

## 4. Getting Started

Ambient temperature range within the operating temperature range of the DMD is situated : +10°C and +40°C.

### 4.7 Using the RCU

#### Pointing to a reflective screen

1. Point the front of the RCU to the reflective screen surface. (image 4-5)

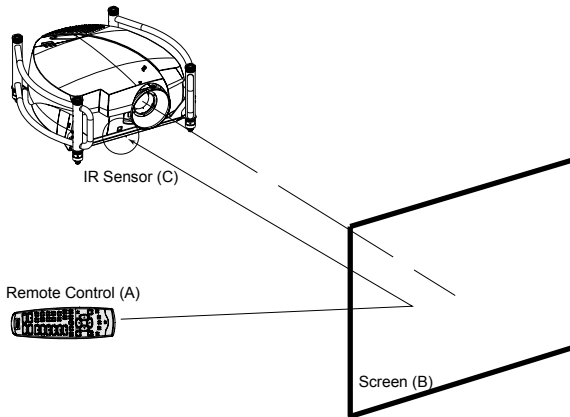

Image 4-5  
Pointing RCU to the screen

- A Remote control
- B Screen
- C IR sensor



**When using the remote control, make sure you are within the effective operating distance.**

**The operating distance may be up to 15 m (50ft).**



**The remote control unit will not function properly if strong light strikes the sensor window or if there are obstacles between the remote control and the IR sensor.**

#### Hardwired Remote input

1. Plug one end of the remote cable in the connector on the bottom of the RCU. (image 4-6)
2. Plug the other end in the connector in the front panel of the projector labelled RC.  
Specifications of the RC input
  - $U_{in} = 9V$
  - $I_{max} = 80\text{ mA}$
  - Internal IR receivers can be disabled:
    - mono jack : on plug in of the jack
    - stereo jack : on plug in or using an external switch bringing the right channel (B) to ground level. (image 4-7)

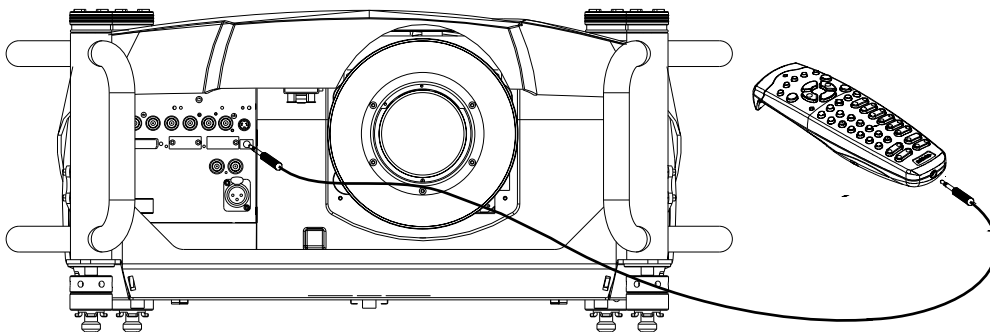

Image 4-6  
Hardwired remote control

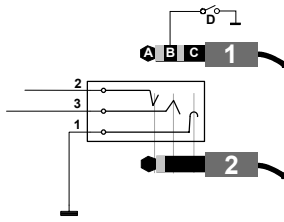

Image 4-7  
Stereo jack pin configuration

- A tip: Left channel
- B ring: right channel
- C sleeve: common (GND)
- D external switch
- 1 Stereo jack
- 2 Mono jack



The Remote connection uses a standard two wire cable terminated on each end with a 3.5 mm male (mono/stereo) phone jack.

This cable is not delivered but is available in most electronic or audio shops.

### Directly to one of the IR sensors

- When using the wireless remote control, make sure you are within the effective operating distance (30m, 100ft in a straight line). The remote control unit will no function properly if strong light strikes the sensor window or if there are obstacles between the remote control unit and the projector IR sensor. (image 4-8)

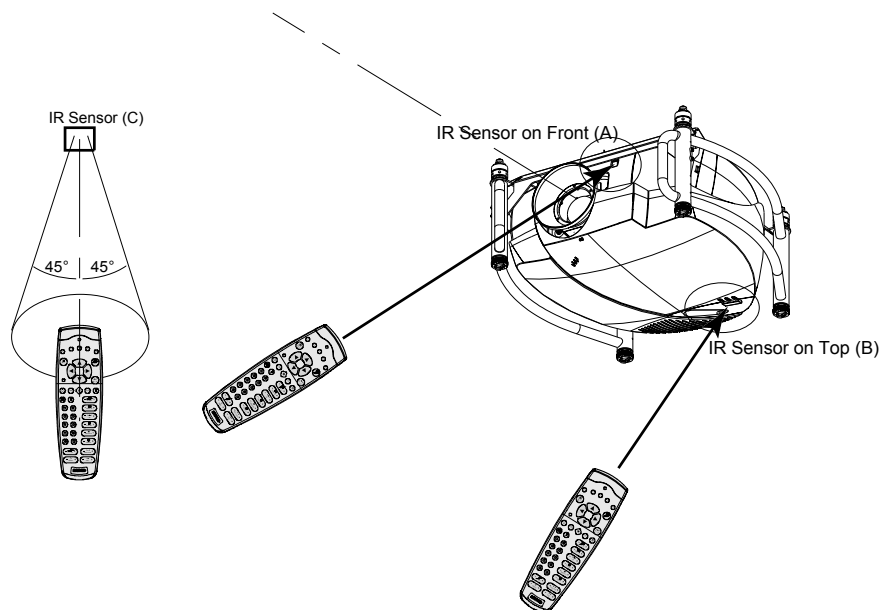

Image 4-8  
Remote control to IR sensor

- A IR sensor on front
- B IR sensor on top
- C IR sensor

### Optional two way hard-wired remote to XLR input

- Plug one end of the twisted pair cable with XLR connector in the two way remote. (image 4-9)
- Plug the other end in the XLR connector on the projector.

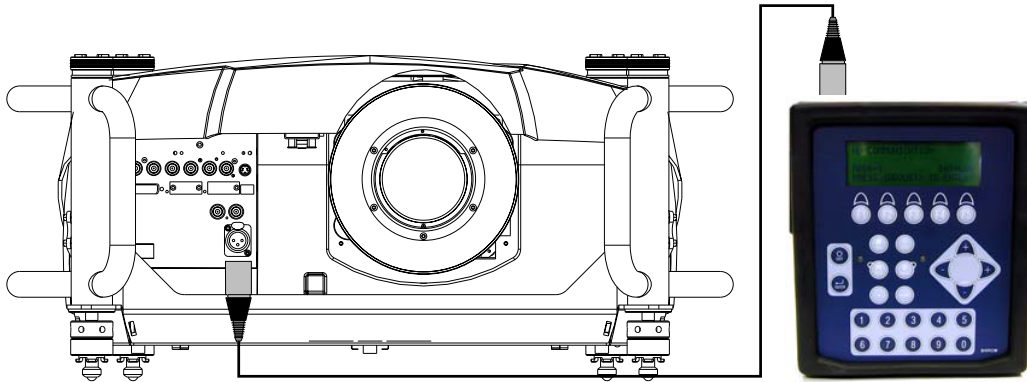

Image 4-9  
Two way hard-wired remote

## 4.8 Projector address

### Overview

- Address setting
- Displaying and Programming addresses into the RCU

### 4.8.1 Address setting



#### Projector address

Address installed in the projector to be individually controlled.



#### Common address

Default address. Projector will always execute the command coming from a RCU programmed with that common address.

### Why a projector address ?

As more than one projector can be installed in a room, the separate projector should be separately addressable with an RCU or computer. Therefore each projector has its own address.

### Set up an individual Projector Address.

The set up of a projector address can be done via the software.

### Projector controlling.

Every projector requires an individual address between 0 and 255 which can be set in the *Installation* menu.

When the address is set, the projector can be controlled by :

- RCU for addresses between 0 and 9.
- computer, e.g. IBM PC (or compatible), Apple MAC, etc. for addresses between 0 and 255.

A projector will respond to a RCU set to the common address '0' regardless of what address is set in the projector itself (common address of projector should also be "0").

The RCU is default programmed with address 0 , 'common address'.



**If it is necessary to control a specific projector, then enter the projector address into the RCU (only when that address is between 0 and 9). The projector with the corresponding address will listen to that specific RCU.**



**Some projectors may operate in domestic environments where other equipments may listen to the common address "0" , therefore the common address can also be set to "1".**



## 4.8.2 Displaying and Programming addresses into the RCU

### Displaying the Projector Address on the Screen.

1. Press the **Address** key (recessed key on the RCU) with a pencil.

The projector's address will be displayed in a 'Text box'



To continue using the RCU with that specific address, it is necessary to enter the same address with the digit buttons (address between 0 and 9) within 5 seconds after pushing the address key. For example : if the Address key displays projector address 003, then press "3" digit button on the RCU to set the RCU's address to match the projector's address. Do not press 0-0-3 . This will address the remote control to '0' and control all projectors in the room. If the address is not entered within 5 seconds, the RCU returns to its default address (zero address) and controls then all projectors in the room.

**Address 0 (or 1) should always allow communication with the projector since it is a common address.**

### Displaying the Projector Address in Standby

1. Press the **Address** key (recessed key on the RCU) with a pencil.

All the LED's on top of the projector go out.

The LED3 starts blinking green. The number of blinking stands for the number of hundreds. After that LED2 starts blinking for the number of tens. Finally LED3 starts blinking for the number of units. If the blinking is done, the original status of the LEDs restored.

## 4.9 Controlling the projector

### Input Selection

Key in the corresponding slot number with the digit keys on the RCU. The selected source will be displayed.

### Input Selection with alternative custom file (slot extension)

It is possible to select the same input but with another settings (another custom file will be loaded).

How to do it :

1. Press first **0** on the RCU. The Slot extension menu will be displayed.
2. Enter the two digits. First digit is custom file sequence and the second digit is the input. E.g. 33, the third custom file will be loaded for source 3. If it does not exist, it will be created.  
The same input can be loaded with 9 different input sources. E.g. for source 3, the input can be from 13 over 23 to 93.



Image 4-10

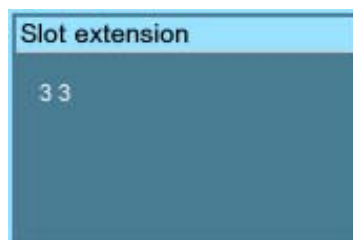

Image 4-11

### Picture Controls

When an image control is pressed, a text box with a bar scale, icon and function name of the control, e.g. 'brightness...' appears on the screen (only if *Textbox* in the *Display Setup* menu is ON). The length of the bar scale and the value of the numeric indication indicate the current memorized setting for this source. The bar scale changes as the arrows on the RCU are pressed or the + or - buttons on the local keypad.

The picture settings are saved in the image file.

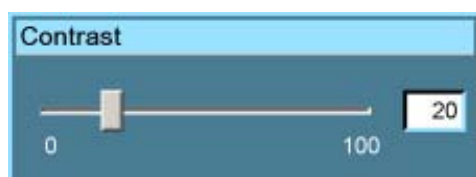

Image 4-12

## 4. Getting Started

---

Brightness	Use the + button for a higher brightness. Use the - button for a lower brightness.
Contrast	Use the + button for a higher contrast. Use the - button for lower contrast.
Color	Use the + button for richer colors. Use the - button for lighter colors.
Tint (Hue)	Tint is only active for Video and S-Video when using the NTSC 4.43 or NTSC 3.58 system. Use the + button Use the - button.
Sharpness	Use the + button for a sharper picture. Use the - button for a softer picture.
Phase	Use the + or - button to adjust the phase.
Gamma	Use the + button for a higher gamma Use the - button for a lower gamma
Freeze	Press <b>Freeze</b> to freeze the displayed image.

### The Pause Key

When the Pause key is pressed, the image projection is stopped, the mechanical shutter is closed.

To restart the image projection:

- Press **PAUSE** key

## 4.10 Quick lens adjustment

---

### Overview

- Lens Adjustment via Control Buttons on Projector
- Lens Adjustment via Menu Bar
- Direct Lens Adjustment (RCU)

### 4.10.1 Lens Adjustment via Control Buttons on Projector

#### How to enter the adjustment menu.

1. Press the control button  (C).

The lens adjustment menu appears on the screen, requesting for ZOOM/FOCUS alignment.

2. Press button  (B) to toggle between ZOOM/FOCUS and Vert. Hor. SHIFT menu.

**Note:** For the alignment, a lens adjustment test pattern can be activated: toggle control button  (C) to activate or deactivate the lens adjustment test pattern.

3. Press the corresponding arrows (A1) or (A2) on the adjust button, as indicated in front of the menu items, for alignment.
4. Press control button  (D) to leave the lens adjustment menu. (image 4-13)

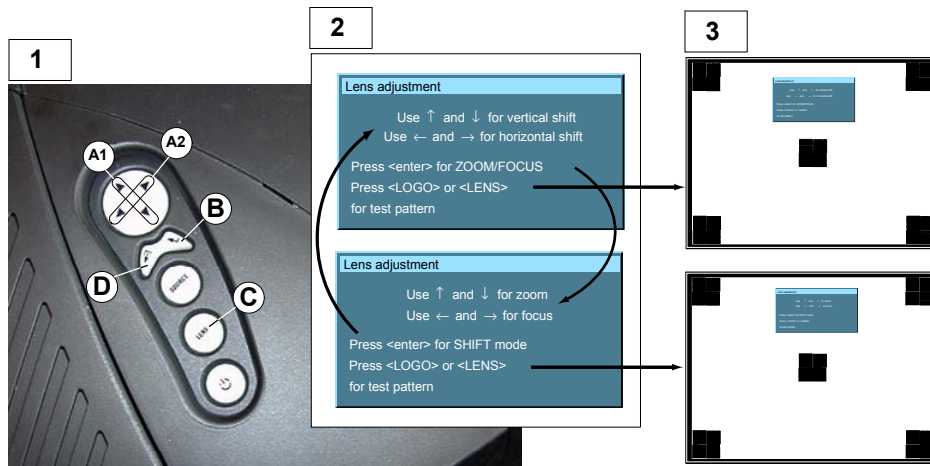

Image 4-13  
Lens Adjustment

- 1 Button panel on projector
- 2 Menu Zoom/Focus and Vertical & Horizontal shift
- 3 Same menus inserted in lens adjustment test pattern

#### 4.10.2 Lens Adjustment via Menu Bar

##### How to enter the adjustment menu.

1. Press the **MENU** button (A) on the Remote Control.  
The menu bar (1) appears on top of the image. (image 4-14)
2. Press → (A1) on adjust button to select menu item *Installation*.  
A text box appears with the first item *Lens adjustment* selected (reversed text)
3. Press **ENTER** button (B) to activate the lens adjustment menu (2).  
The lens adjustment menu appears on the screen, requesting for ZOOM/FOCUS alignment.
4. Press **ENTER** button (B) to toggle between ZOOM/FOCUS and Vert. Hor. SHIFT menu (2).  
**Note:** For the alignment, a lens adjustment test pattern can be activated: toggle button (C) to activate or deactivate the lens adjustment test pattern (3).
5. Press the corresponding arrows (A1) or (A2) on the adjust button, as indicated in front of the menu items, for alignment.
6. Press control button (D) to leave the lens adjustment menu.

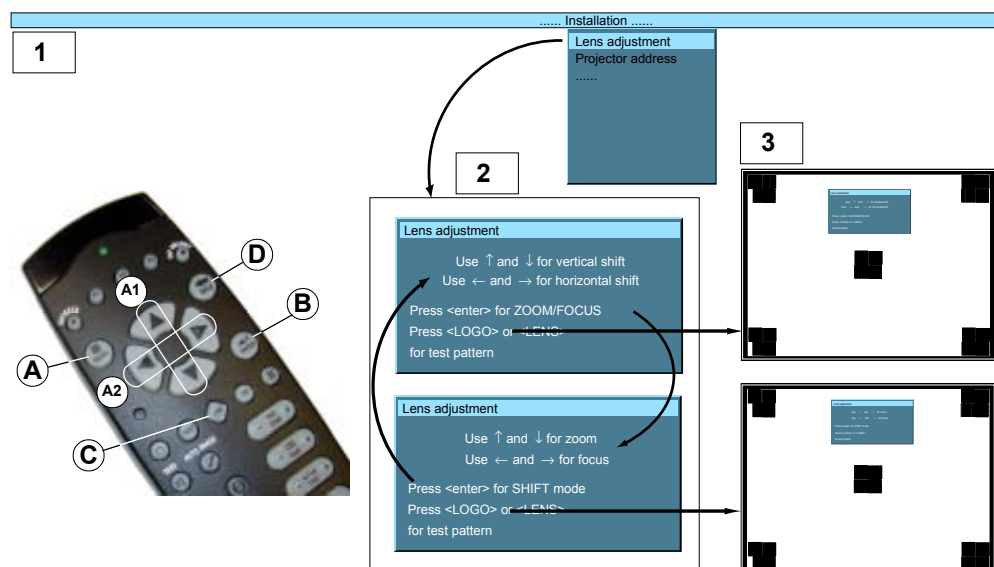

Image 4-14  
Lens adjustment via menu

### 4.10.3 Direct Lens Adjustment (RCU)

#### Lens adjustment button on the Remote Control

On the Remote Control three buttons with double action are provided, allowing direct alignment for lens ZOOM, FOCUS and VERTICAL SHIFT. For Horizontal Shift, some projectors use the **VOL** button.

1. Press **LENS ZOOM** button [-] or [+] (A) for correct image size on the screen.
2. Press **LENS FOCUS** button [-] or [+] (C) for an overall focus of the image.
3. Press **LENS SHIFT** button ↑ or ↓ (B) for correct vertical position of the image on the screen. (image 4-15)
4. Press **VOL** button [-] or [+] (D) for correct horizontal position of the image on the screen.

[-] button = left shift

[+] button = right shift

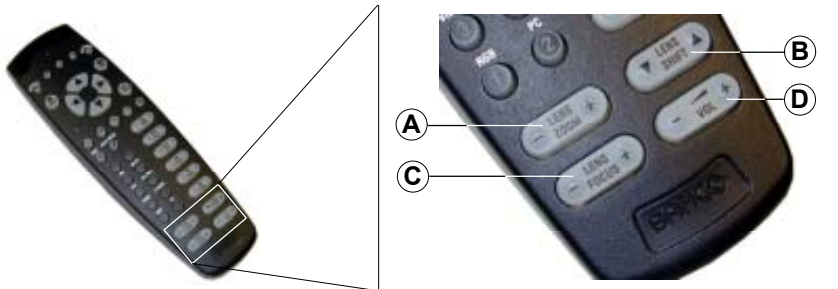

Image 4-15  
Lens adjustment with RCU

## 4.11 Digital Zoom

---

### What can be done ?

The Digital Zoom key on the RCU allows to zoom in or out on one particular part of the image.



**Digital zoom cannot be performed on a logo.**

### How to zoom ?

1. Press ← or → on the **Digital Zoom** key on the remote control to zoom the center of the image.
2. Use the ↑, ↓, → or ← to pan the image. (image 4-16)
3. Press **ENTER** to confirm.

**Note:** While in the digital zoom function, use **BACK** to return.

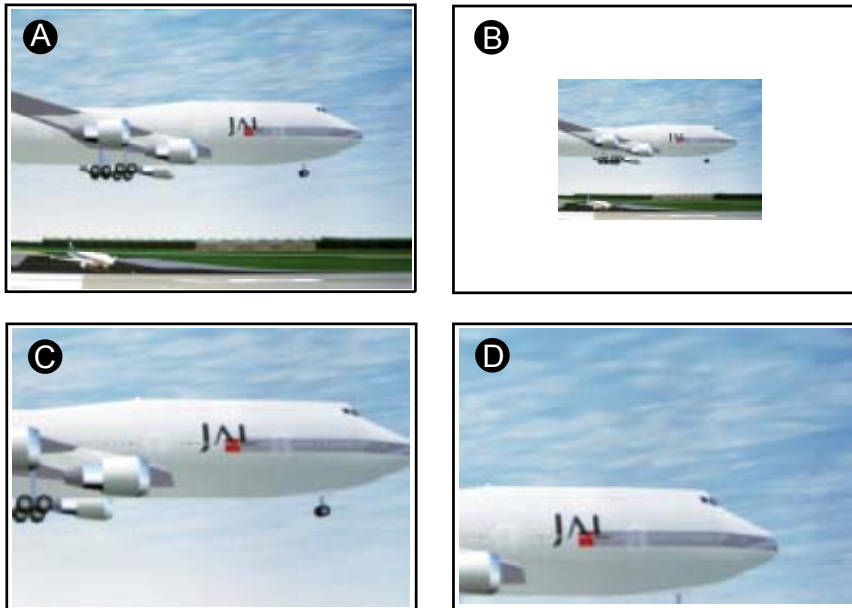

Image 4-16  
Digital zoom

- A Normal image
- B Digital zoom out
- C Digital zoom in
- D Panning of the zoomed image



To return to the normal image, press **MENU**, go to *Tools*, select *PiP select* and check *Full screen*.

## 4.12 Quick Picture in Picture selection

### Quick selection

1. Press **PiP** key on the RCU immediately followed by the corresponding layout number (between 1 and 9).

E.g. : to the third layout, press **PiP + 3**.

The number of the layout which has to be entered is the same as the number between the brackets in the menubar → *Tools* → *PiP select*.



To go back to full screen, enter the source number of the source which must be displayed full screen.



## 5. GETTING USED WITH THE MENU STRUCTURE

### Overview

- How to start up the menus
- Using the menu
- Using the Dialog boxes
- Using the menus via the built-in LCD panel

### 5.1 How to start up the menus

#### PC like menu structure

The RLM G5i Performer has a built in "PC like" menu bar which allows easy access to different parameters for setting up the projector.

#### How to activate

1. Press **MENU** on the RCU.

The menu bar will be displayed on the screen.



Menu items which are greyed out are not accessible for the current displayed source.

### 5.2 Using the menu

#### Menu Layout

The existence of a submenu is indicated by a white arrow, e.g. *Settings* has a submenu.

E.g. *Brightness* is an item of the *Image* menu and has no submenu.

Three suspension points indicate that the menu item hides a dialog box or a text box.

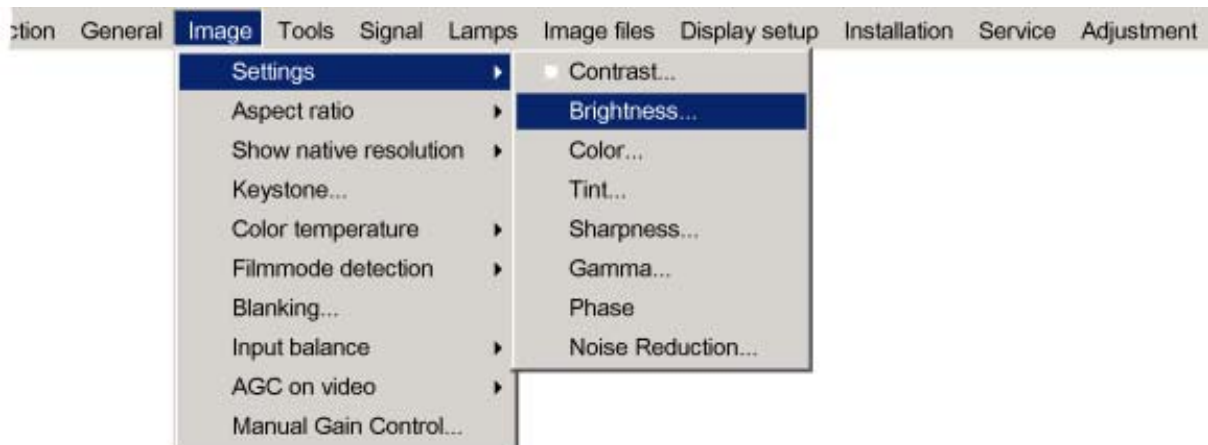

Image 5-1



The menus inserted in this manual are always full menus: all the items are visible.



Greyed out menus or items are not available for the current selected source or current software version.

### How to pull down a menu ?

1. Use ↓ to pull down a menu.

### How to pull down a submenu ?

1. Use → to pull down a submenu.

### How to exit the submenu ?

1. Press **BACK** to exit a submenu.



Press **MENU** to exit the menu

---

## 5.3 Using the Dialog boxes

---

### How to use the dialog boxes ?

Some parameters are modified by means of a dialog box, where selections can be made and/or values can be entered.

The values can be entered in several ways:

### Entering numeric values using the numeric keys on the remote control

1. Press **ENTER** to activate the input field. (image 5-2)
2. Key in the desired value.



Image 5-2

### Entering numeric values using the arrow keys on the remote control

1. Press **ENTER** to activate the input field.
2. Press ← or → to select the digit to be changed. (image 5-3)
3. Press ↓ or ↑ to increase or decrease the value.



Image 5-3

### Entering numeric values using the arrow keys on the local keypad

1. Press **ENTER** to activate the input field.
2. Press ← or → to select the digit to be changed.
3. Press ↓ or ↑ to increase or decrease the value.



To confirm the changes always press **ENTER**.

Use ↓ or ↑ to browse between the different fields.

---





In some cases an alphanumeric value (file name, ...) has to be entered. Use ↑ or ↓ to scroll through the character values once the input field is activated.

Following characters can be browsed in this particular order:

Decimal scroll list: 0123456789

Signed decimal scroll list: 0123456789-

ASCII scroll list: ABCDEFGHIJKLMNOPQRSTUVWXYZ0123456789+\*/&@#.;:abcdefghijklmnopqrstuvwxy

---

## 5.4 Using the menus via the built-in LCD panel

---

### How to use the menu on the LCD panel?

1. Press **ENTER** on the local key path or **MENU** on the RCU to start up the menu structure.
2. Use the ← or → to scroll through the main menus (equals the menu bar of the on screen menus).
3. Use the ↓ or ↑ to scroll through the sub menus.

When the items are listed with 3 points or an arrow, the dialog box content of that item will be displayed on the display when **ENTER** is pressed. The ↓ or ↑ can be used to scroll through the content.

4. To go to a sub menu of a sub menu, press first the right arrow key and then the up or down arrow keys to display the items on the third line of the display.

When the items are listed with 3 points or an arrow, the dialog box content of that item will be displayed on the display when **ENTER** is pressed. The ↓ or ↑ can be used to scroll through the content.



To return one step, press **EXIT**. To jump out of the menu structure, press **MENU** on the RCU.

---



---

## 6. SOURCE SELECTION

### Overview

- Source Selection overview
- The use of icons
- Source selection
- Selecting a data source on the 5-cable input
- Composite Video
- S-Video selection
- The Video Selector

---

### 6.1 Source Selection overview

#### Source selection overview

- Data on BNC's
- Component Video
- RG(s)B Video
- PC
- Composite Video
  - Video
  - Video VS
  - Video R
  - Video G
  - Video B
  - Video Y
  - Video C
- S-Video
  - S-Video 1
  - S-Video 2
  - S-Video 3
- DVI
- SDI
- Logo
- Video selector...

---

### 6.2 The use of icons

#### Overview

A white bullet in front of a menu item (source) indicates that this source is an active source. When picture in picture is used, up to 4 white bullet can be found on the menu drop down.

The digit icon in front of an item, indicates the shortcut key on the RCU.

---

### 6.3 Source selection

#### Selecting a source

The Source selection menu allows to select one of the different sources. Another method to select an input source is via the remote control using the numeric keys or by using the local keypad.

#### How to select a source ?

1. Press **MENU** to activate the menu bar.
2. Press ↓ to pull down the Source Selection menu.

## 6. Source Selection

- Use **↑** or **↓** to select one of the different sources (Press **→** to pull down if the item has a submenu).
- Press **ENTER** to confirm your choice.

On the screen appears now the selected source with at the same time for a few seconds a text box with source information. (image 6-1)

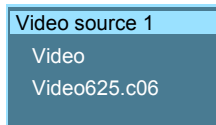

Image 6-1  
Source indication

### 6.4 Selecting a data source on the 5-cable input

#### What can be connected to the 5-cable input

The following source can be connected to the 5-cable input in normal mode:

- Data on BNC's
- Component Video
- RG(s)B

The position of the icon "1" will always indicate which BNC configuration is selected.

#### How to set the correct source

- Press **MENU** to activate the menu bar.
- Press **↓** to pull down the Source Selection menu.
- Use **↑** or **↓** to select one of the 3 possible sources. (image 6-2)

When to select :

DATA on BNC's	When a data signal is connected to the BNC's
Component Video	When a video signal of the type (PR/Y/PB) is connected on the BNC's
RG(s)B Video	When RGB video signal with Sync on green or sync on H is connected on the BNC's. This signal is routed to the video circuit and is projected in a Video Window.



Image 6-2



When selecting "1" with the remote control, the predefined source type will be displayed.

## 6.5 Composite Video

### Possible connections

In normal mode, one video source can be connected to the video input.

In extended mode, up to 7 different video sources can be connected to the normal video input, or to the extended 5-cable input or to the S-Video.



When the extended mode is not switched on, the on screen menu will have another layout with less selection possibilities.

### How to select one of 7 different composite video inputs when in extended mode

1. Press **MENU** to activate the menu bar.
2. Press **↓** to pull down the Source Selection menu.
3. Use **↑** or **↓** to select *Composite video*.
4. Press **→** to pull down the submenu.
5. Use **↑** or **↓** to select one of the different video inputs. (image 6-3)
6. Press **ENTER** to confirm your choice.

A white bullet will indicate the selected composite video source. This source will be displayed on the screen.

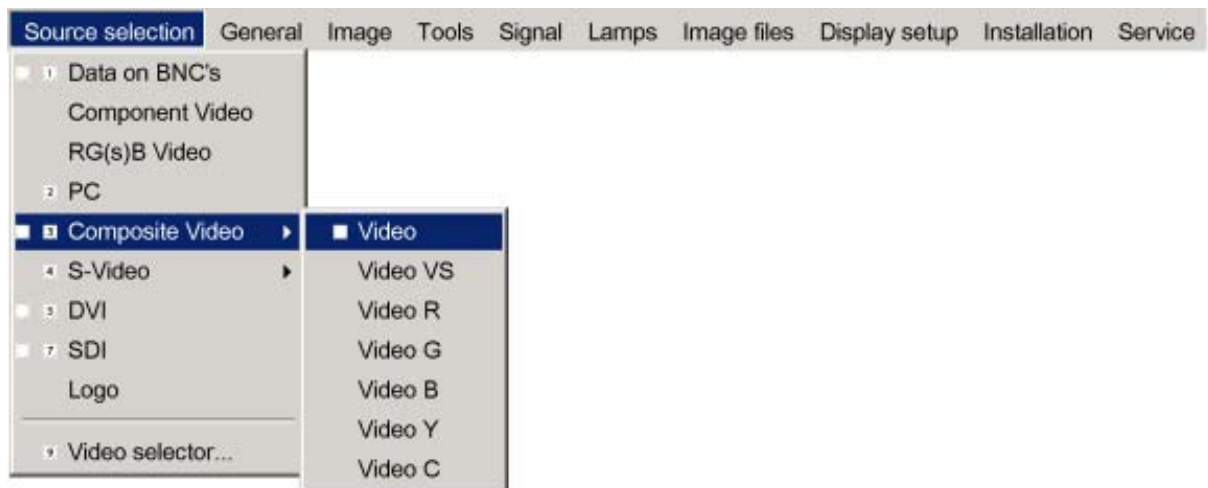

Image 6-3



The composite video sources can also be selected using the video selector or via the dedicated key 3 on the RCU. Key 3 allows to browse through the active video inputs when the extended mode is checked in Video Selector..



Multiple video signals cannot be visualized simultaneously since there is only one decoder.

## 6.6 S-Video selection



When the extended mode is not switched on, the on screen menu will have another layout with less selection possibilities.

### How to select one of the 3 S-Video inputs ?

1. Press **MENU** to activate the menu bar.

## 6. Source Selection

2. Press ↓ to pull down the Source Selection menu.
3. Use ↑ or ↓ to select *S-Video*.
4. Press → to pull down the submenu.
5. Use ↑ or ↓ to select one of the different S-Video inputs. (image 6-4)
6. Press **ENTER** to confirm your choice.

A white bullet indicates the selected S-Video source. This source will be displayed on the screen.

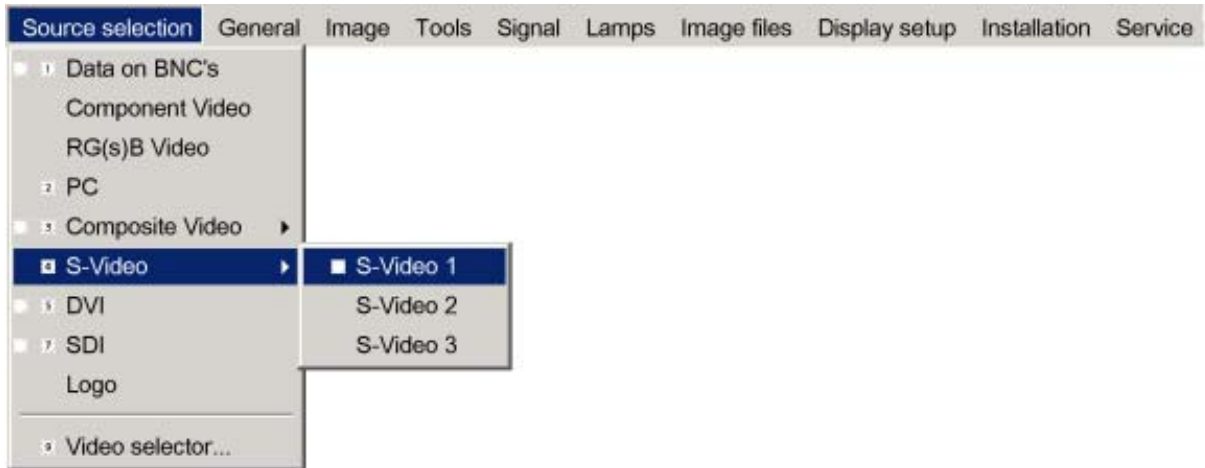

Image 6-4



The S-Video sources can also be selected using the video selector or via the dedicated key 4 on the RCU. Key 4 allows to browse through the active S-Video inputs when the extended mode is checked in Video Selector.

## 6.7 The Video Selector



### Video Selector

The Video Selector is a graphical interface which allows an overview of the different video inputs (Composite Video and S-Video) and whether they are active (signal connected) or not as well as the selection of these different signals.

### Video selector modes

The video selector has two modes:

- standard mode : the video selectable video inputs are the standard composite video & S-Video input
- extended mode : several BNC connections are added and can be selected as video inputs or S-Video inputs.

### How to switch the mode

1. Press **MENU** to activate the menu bar.
2. Press ↓ to pull down the Source Selection menu.
3. Use ↑ or ↓ to select *Video selector...* . (image 6-5)
4. Use the arrow keys to select the Extended check box.
5. Press **ENTER** to disable or enable the extended mode.

A message will be displayed and followed by a graphical user interface.

Check *Extended* to switch to extended mode.

Uncheck *Extended* to switch to standard mode.



Image 6-5

### How to select an input on the Video Selector

1. Use ← or → to browse through the different inputs.
2. Press **ENTER** to select.  
Use **MENU** or **BACK** to exit the Video Selector.

### Graphical interface

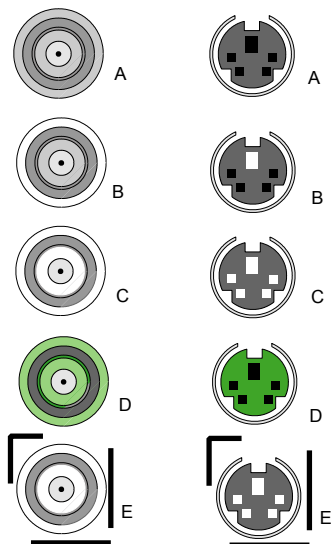

Image 6-6

A BNC or S-Video connector on the video selector can be in one of following conditions:

- A: connector disabled
- B: connector enabled but inactive (no video signal present on connector)
- C: connector enabled & active (video signal present on connector)
- D: connector enabled active & selected
- E: connector enabled & active & focused (browser positioned on connector)



A source can also be selected via the dedicated key 9 on the RCU. Key 9 allows to browse through the active inputs.





## 7. GENERAL MENU

### Overview

- General Menu overview
- Pause
- Freeze
- Standby Timer
- Identification

### 7.1 General Menu overview

#### General Menu structure

- Pause
- Freeze
- Standby timer...
- Identification

### 7.2 Pause

#### Interrupting the image projection

With the Pause function, the image projection can be stopped, the projector remains with full power for immediate restart. The projection is interrupted by means of a mechanical shutter cutting the light beam.

#### How to interrupt the image projection ?

1. Press **MENU** to activate the menu bar.
2. Press → to select *General*.
3. Press ↓ to pull down the General menu.
4. Use ↑ or ↓ to select *Pause*. (image 7-1)
5. Press **ENTER** to activate the Pause function.

A brief sound indicates that the shutter has been activated.

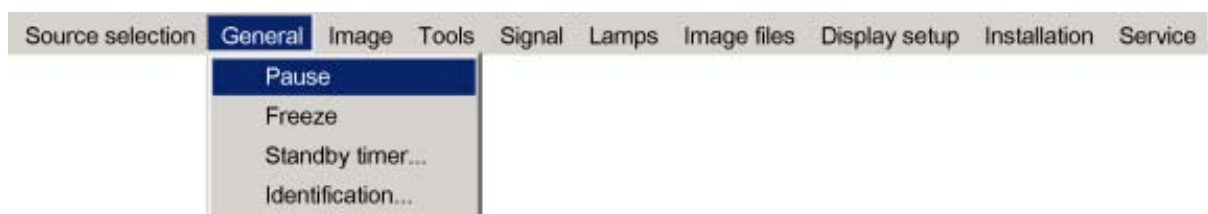

Image 7-1



The image projection can also be interrupted using the **PAUSE** key on the RCU.  
To restart the image : press **PAUSE**.

### 7.3 Freeze

#### Freezing the image

With the Freeze function, the image can be frozen. To restart the image, reuse the Freeze function or press the **FREEZE** button on the remote control.

### How to freeze the image ?

1. Press **MENU** to activate the menu bar.
2. Press → to select *General*.
3. Press ↓ to pull down the General menu.
4. Use ↑ or ↓ to select *Freeze*. (image 7-2)
5. Press **ENTER** to activate the Freeze function.

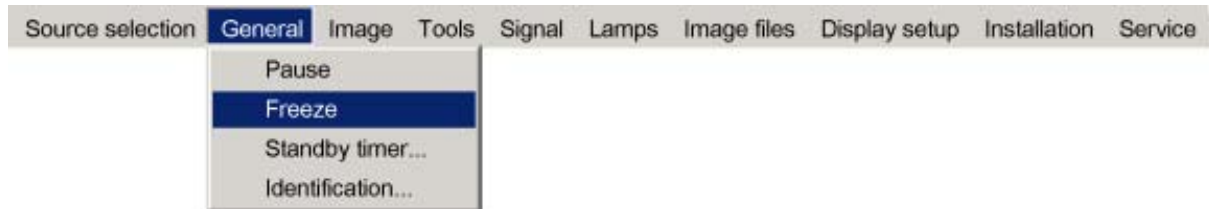

Image 7-2



The image can also be frozen using the **FREEZE** key on the RCU.

---

## 7.4 Standby Timer

---

### Purpose of the Standby Timer

If there is no signal, and the standby timer is enabled, a dialog box is displayed and the projector will shut down after a determined time.

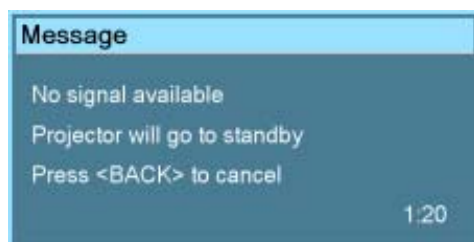

Image 7-3

The countdown time can be set in a dialog box in a range from 180 to 3600 seconds (default value = 300). The Timer can also be disabled.

### How to enable the standby timer ?

1. Press **MENU** to activate the menu bar.
2. Press → to select *General*.
3. Press ↓ to pull down the General menu.
4. Use ↑ or ↓ to select *Standby Timer*. (image 7-4)
5. Press **ENTER** to activate the function.  
On the screen appears a dialog box. (image 7-5)
6. Use ↑ or ↓ to select *Enabled* .  
A box surrounds the selected item.
7. Press **ENTER** to activate.
8. Use ↑ or ↓ to browse to the input field.
9. Use ← or → , the numeric keys on the remote or the keypad to change the countdown setting.
10. Press **MENU** or **BACK** to exit or to go back to the previous menu.

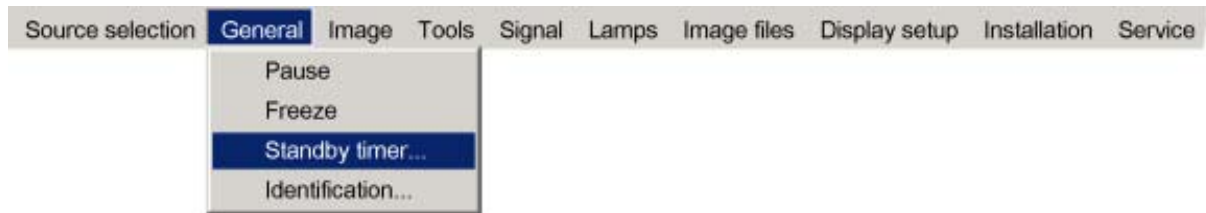

Image 7-4



Image 7-5

## 7.5 Identification

### The projector's identification screen

The identification screen displays the projector's main characteristics

These are:

- Projector type
- Projector address
- Software version controller unit
- RS232 Baudrate
- Serial number of projector

### How to display the identification screen ?

1. Press **MENU** to activate the menu bar.
2. Press → to select *General*.
3. Press ↓ to pull down the General menu.
4. Use ↑ or ↓ to select *Identification*. (image 7-6)
5. Press **ENTER** to activate the function.

The Identification screen will be displayed. (image 7-7)

6. Press **MENU** or **BACK** to exit or to go back to the previous menu

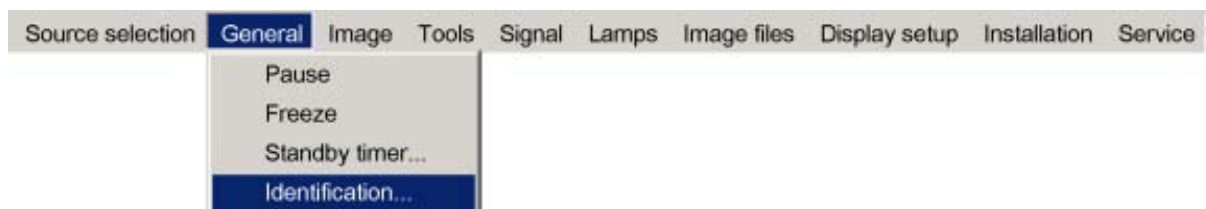

Image 7-6

Identification	
Type	RLM G5i
Address	2
Software	01.02
RS232 baudrate	115200
Serial number	6001758

Image 7-7

## 8. IMAGE MENU

### Overview

- Image menu overview
- Settings
- Aspect ratio
- Show native resolution
- Keystone correction
- Color Temperature
- Filmmode detection
- Blanking
- Input Balance
- AGC on Video
- Manual Gain Control

## 8.1 Image menu overview

---

### Overview

- Settings
  - Contrast
  - Brightness
  - Color
  - Tint
  - Sharpness
  - Gamma
  - Phase
  - Noise Reduction
- Aspect ratio
  - Auto
  - [4:3]
  - [16:9]
  - [5:4]
  - [2.35]
  - [2.88]
  - [1.78]
  - Custom
- Show native resolution
  - On
  - Off
- Keystone...
- Color temperature
  - Projector white
  - Computer
  - Video
  - Film
  - Broadcast
  - Custom Preset...
  - Custom...
- Film mode detection
  - On
  - Off
- Blanking
- Input Balance
  - Black..
  - White...
  - Preset
- AGC on Video
  - On
  - Off
- Manual Gain Control...

## 8.2 Settings

### Overview

- Contrast
- Brightness
- Color
- Tint (hue)
- Sharpness
- Gamma
- Phase
- Noise reduction

### What can be done?

Correct image settings are important for a good image reproduction.

The image settings are made through a dialog box with a scroll bar. Minimal, maximal and the actual values are indicated. These settings can also be done directly via the RCU's dedicated buttons, except for the sharpness.

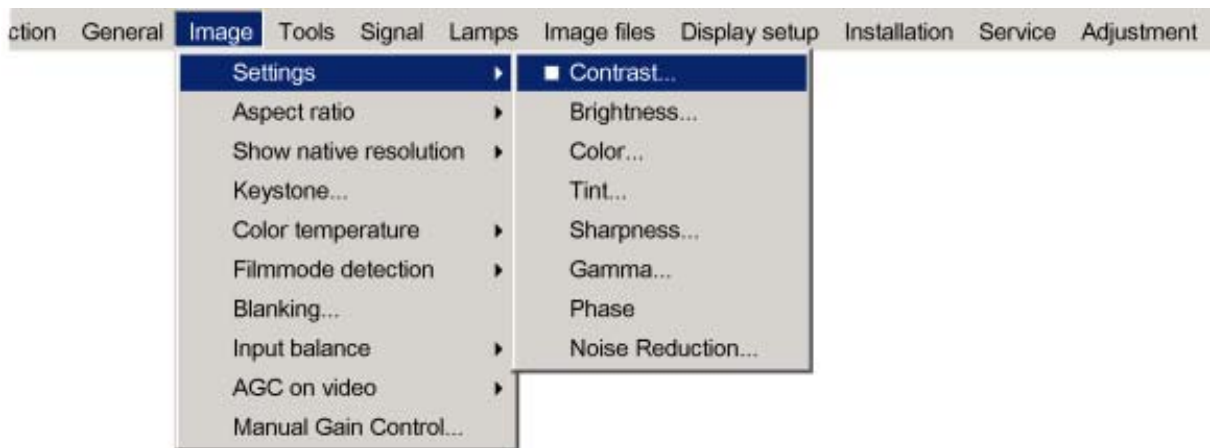

Image 8-1

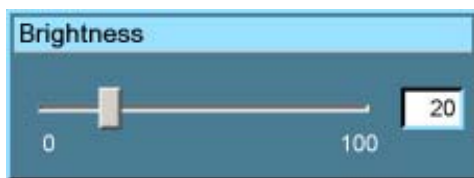

Image 8-2

### 8.2.1 Contrast

#### About Contrast

The contrast function is used to adjust the contrast between the light and dark areas of the displayed image.

#### How to change the contrast

1. Press **MENU** to activate the menu bar. (image 8-3)
2. Press → to select the *Image* item.
3. Press ↓ to pull down the *Image* menu.
4. Use ↑ or ↓ to select *settings*.
5. Press → to pull down the menu.
6. Use ↑ or ↓ to select *Contrast*.
7. Press **ENTER**.  
A slider box appears.
8. Use ← or → to change the contrast.

## 8. Image Menu

The higher the value, the higher the contrast.

Or,  
click in the input box and enter the desired value with the numeric keys.

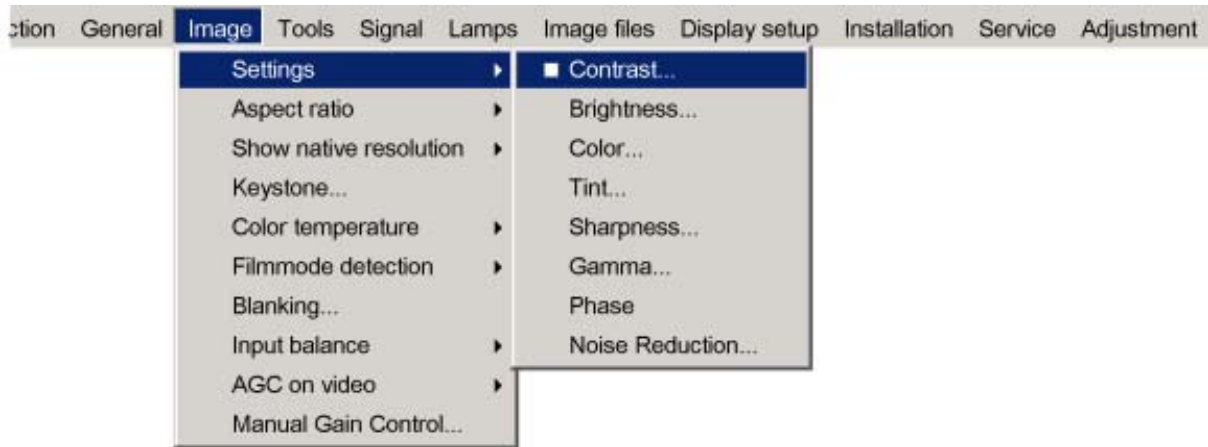

Image 8-3

### 8.2.2 Brightness

#### About Brightness

The Brightness function is used to adjust the overall light output.

#### How to change the Brightness ?

1. Press **MENU** to activate the menu bar. (image 8-4)
2. Press **→** to select the *Image* item.
3. Press **↓** to pull down the *Image* menu.
4. Use **↑** or **↓** to select *settings*.
5. Press **→** to pull down the menu.
6. Use **↓** or **↑** to select *Brightness*.
7. Press **ENTER**

A slider box appears.

8. Use **←** or **→** to change the brightness.

The higher the value, the higher the brightness.

Or,  
click in the input box and enter the desired value with the numeric keys.

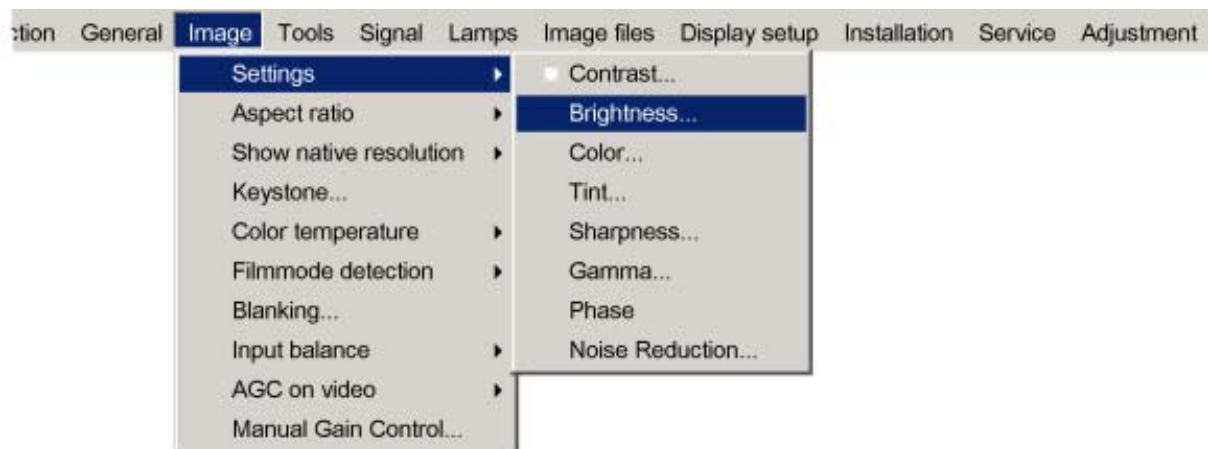

Image 8-4



### 8.2.3 Color

#### About Color setting

The color function is used to adjust color saturation levels.

#### How to change the Color ?

1. Press **MENU** to activate the menu bar. (image 8-5)
2. Press → to select the *Image* item.
3. Press ↓ to pull down the *Image* menu.
4. Use ↑ or ↓ to select *settings*.
5. Press → to pull down the menu.
6. Use ↓ or ↑ to select *Color*.
7. Press **ENTER** .

A slider box appears.

8. Use ← or → to change the color.

The higher the value, the higher the color.

Or,

click in the input box and enter the desired value with the numeric keys.

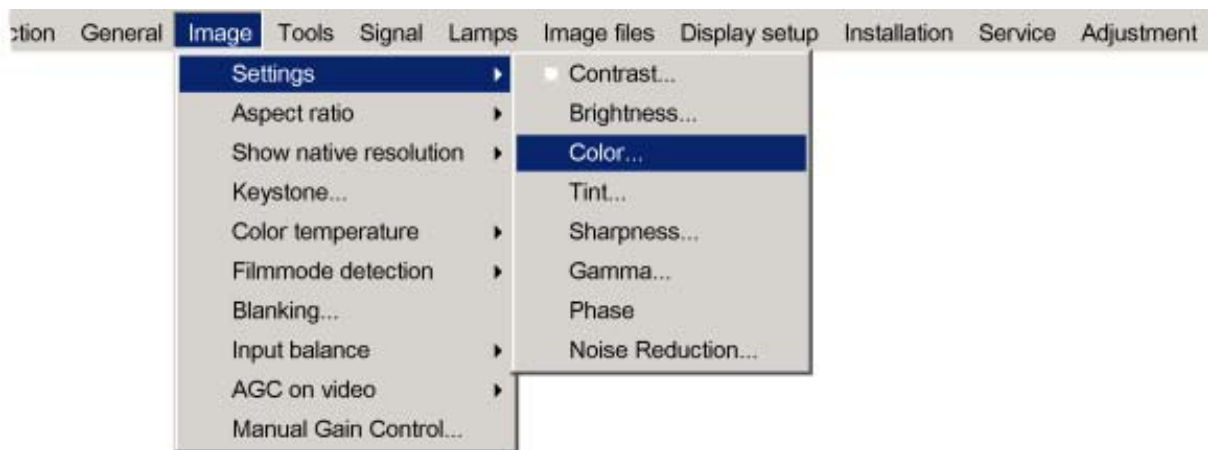

Image 8-5

### 8.2.4 Tint (hue)

#### About Tint

The Tint function is used to adjust color hue to obtain true color reproduction and is only active for Video and S-Video when the NTSC color system is used. For PAL and SECAM sources, Tint is not accessible.

#### How to change the Tint ?

1. Press **MENU** to activate the menu bar. (image 8-6)
2. Press → to select the *Image* item.
3. Press ↓ to pull down the *Image* menu.
4. Use ↑ or ↓ to select *settings*.
5. Press → to pull down the menu.
6. Use ↓ or ↑ to select *Tint*.
7. Press **ENTER** .

A slider box appears.

8. Use ← or → to change the tint.

The higher the value, the higher the tint.

Or,

click in the input box and enter the desired value with the numeric keys.

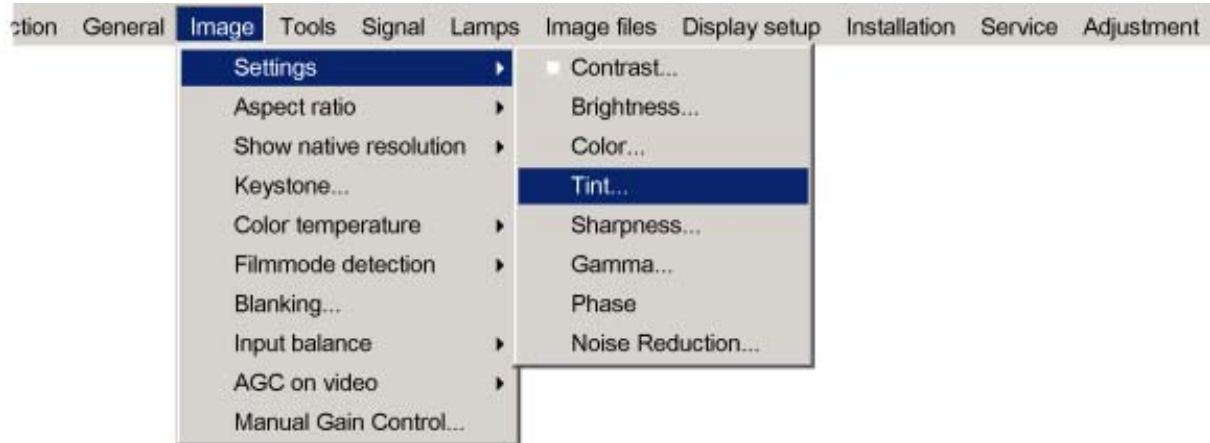

Image 8-6

### 8.2.5 Sharpness

#### About Sharpness

The sharpness function is used to adjust the image sharpness of video signals.

#### How to change the sharpness ?

1. Press **MENU** to activate the menu bar. (image 8-7)
2. Press → to select the *Image* item.
3. Press ↓ to pull down the *Image* menu.
4. Use ↑ or ↓ to select *settings*.
5. Press → to pull down the menu.
6. Use ↓ or ↑ to select *Sharpness*.
7. Press **ENTER**.

A slider box appears.

8. Use ← or → to change the sharpness.

The higher the value, the higher the sharpness.

Or,

click in the input box and enter the desired value with the numeric keys.

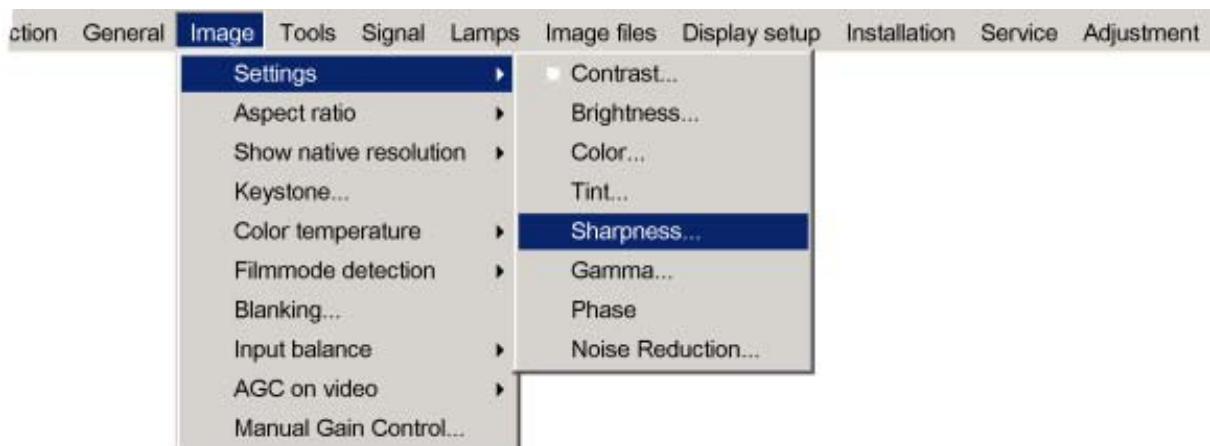

Image 8-7

### 8.2.6 Gamma

#### About Gamma

Gamma is an image quality enhancement function that offers a richer image by brightening the already darker portions of the image without altering the brightness of the brighter portions (contrast feeling enhanced).

### How to change the Gamma

1. Press **MENU** to activate the menu bar. (image 8-8)
  2. Press **→** to select the *Image* item.
  3. Press **↓** to pull down the *Image* menu.
  4. Use **↑** or **↓** to select *settings*.
  5. Press **→** to pull down the menu.
  6. Use **↓** or **↑** to select *Gamma*.
  7. Press **ENTER** .  
A slider box appears.
  8. Use **←** or **→** to change the gamma value.  
Or,  
click in the input box and enter the desired value with the numeric keys.
- Note:** Default value of gamma : 2.2

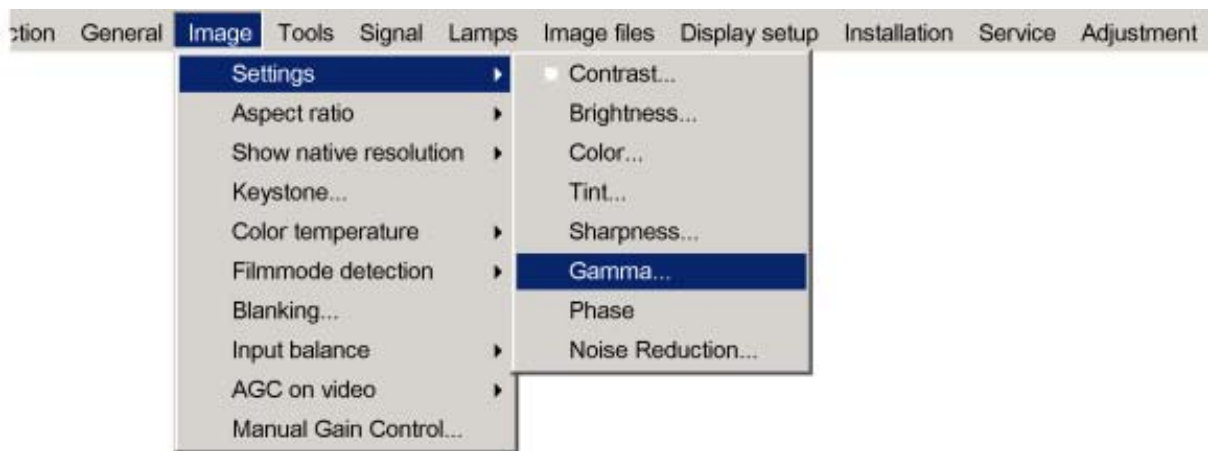
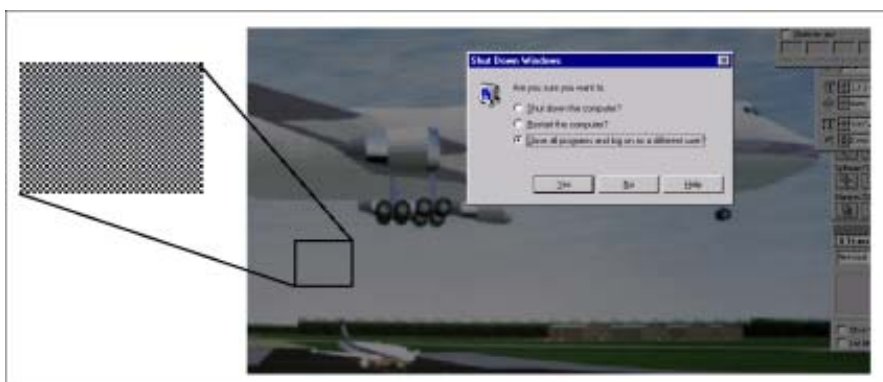

Image 8-8

## 8.2.7 Phase

### About Phase adjustment

When displaying computer patterns or graphics (RGB or YUV signals) which are very detailed (tilting, vertical stripes, etc. ), jitter in picture (mis-sampling) may occur, causing horizontal stripes in portions of the screen. When this jitter occurs, adjust 'Phase' for optimum image.

Image 8-9  
Jittering on image

### How to change the Phase ?

1. Press **MENU** to activate the menu bar. (image 8-10)
2. Press **→** to select the *Image* item.
3. Press **↓** to pull down the *Image* menu.
4. Use **↑** or **↓** to select *settings*.
5. Press **→** to pull down the menu.

## 8. Image Menu

---

6. Use ↓ or ↑ to select *Phase*.

7. Press **ENTER** .

A slider box appears.

8. Use ← or → to change the Phase and refine the jitter.

Or,

click in the input box and enter the desired value with the numeric keys.

**Note:** *Don't mix up with wrong number of total pixels. If the jitter doesn't disappear with the phase adjustment, check the total number of pixels. (Best image = pixel on pixel off pattern. For example: shut down screen of a PC)*

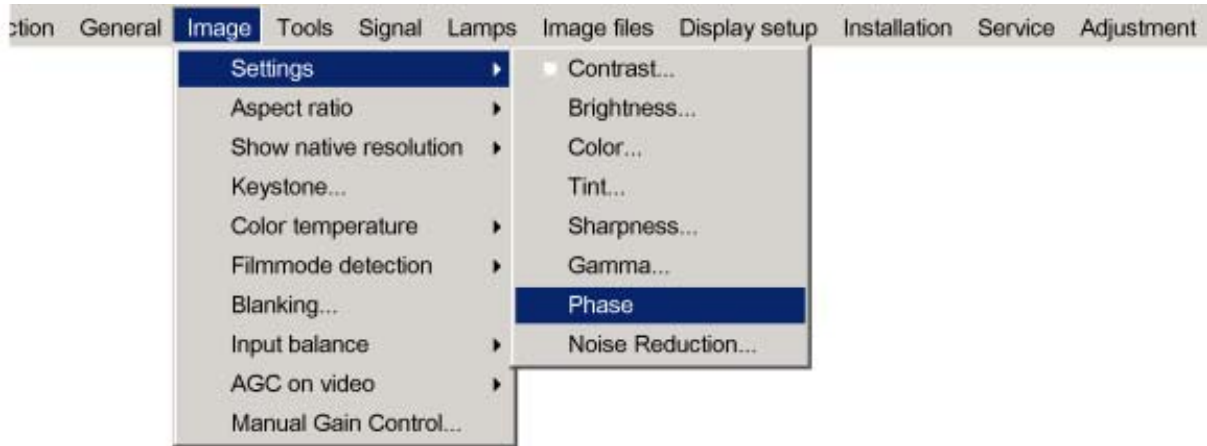

Image 8-10

### 8.2.8 Noise reduction

#### About Noise reduction

Reduces noise and pixel jitter in all video sources.

#### How to change the Noise reduction ?

1. Press **MENU** to activate the menu bar. (image 8-11)

2. Press → to select the *Image* item.

3. Press ↓ to pull down the *Image* menu.

4. Use ↑ or ↓ to select *settings*.

5. Press → to pull down the menu.

6. Use ↓ or ↑ to select *Noise reduction*.

7. Press **ENTER** .

A slider box appears

8. Use ← or → to change the noise level.

The higher the value, the higher the noise reduction.

Or,

click in the input box and enter the desired value with the numeric keys.

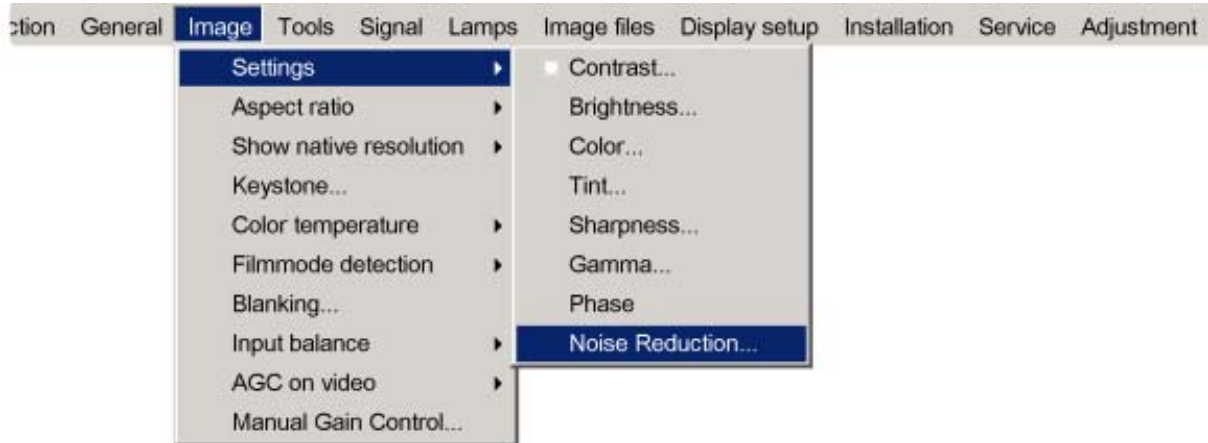

Image 8-11

### 8.3 Aspect ratio



Aspect ratio is greyed out when the *Full Screen Representation* function in *Display Setup* is switched ON or when the *Show Native Resolution* function in *Image* is switched ON.

#### What can be done ?

The aspect ratio setting forces the projector to project an image using a defined aspect ratio

Aspect ratio	Description
Auto	Calculates an aspect ratio based on the information stored in the images files.
4:3	Standard television format
16:9	Wide screen television format / anamorphic format
5:4	Workstation format
2.35	Cine Scope 35 mm
2.88	
1.78	Wide screen television format / anamorphic format
Custom	Custom aspect ratio can be set up



Selecting Auto in case of a Video source may shrink the image horizontally or vertically

Some examples:

Type of input signal is indicated above each image row. The image row shows how the image will be projected in the different aspect ratio settings. The arrow indicates the correct setting for the mentioned source.

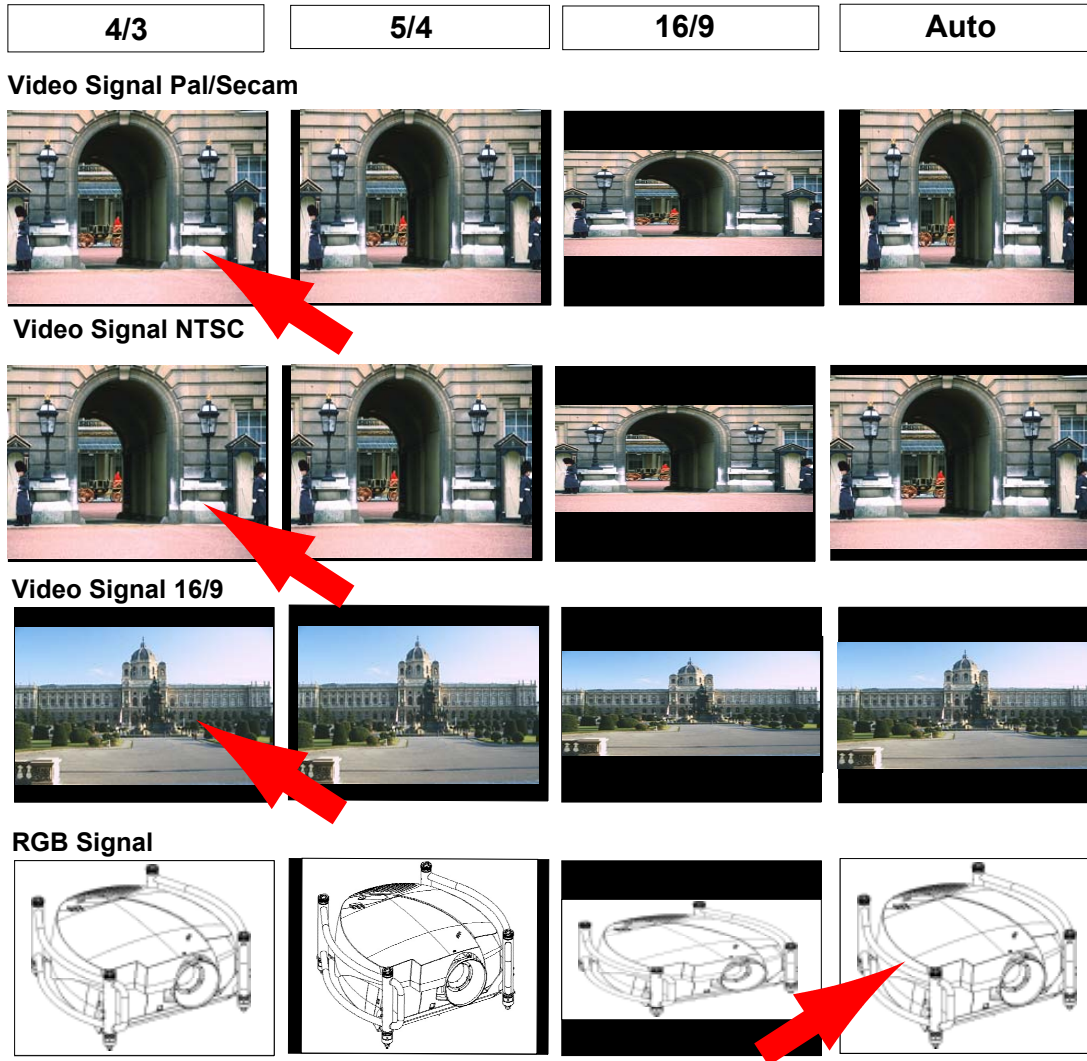

Image 8-12  
Some examples for aspect ratio

### How to change the Aspect ratio ?

1. Press **MENU** to activate the menu bar. (image 8-13)
2. Press **→** to select *Image*.
3. Press **↓** to pull down the *Image* menu.
4. Use **↑** or **↓** to select *Aspect ratio*.
5. Press **ENTER** to confirm.

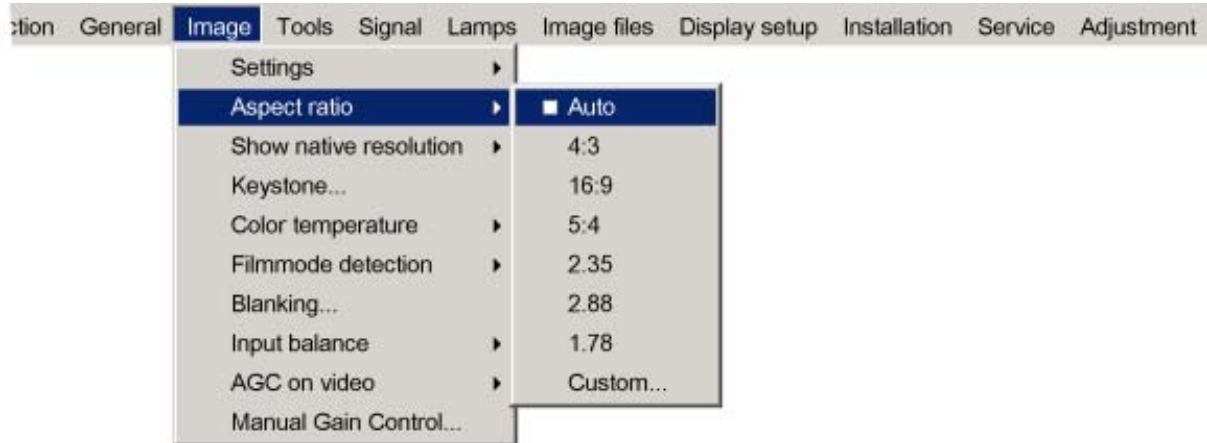

Image 8-13

### How to set up a custom Aspect ratio ?

1. Press **MENU** to activate the menu bar. (image 8-14)
2. Press → to select *Image*.
3. Press ↓ to pull down the *Image* menu.
4. Use ↑ or ↓ to select *Aspect ratio*.
5. Press ↓ to select *custom...*
6. Press **ENTER** to confirm.

The Custom aspect ratio dialog box will be displayed. (image 8-15)

7. Use ← or → to select *Horizontal* or *Vertical*.
8. Use ↑ or ↓ to adjust until the desired aspect ratio is obtained.  
Or,  
press **ENTER** and enter the desired value with the digit keys.

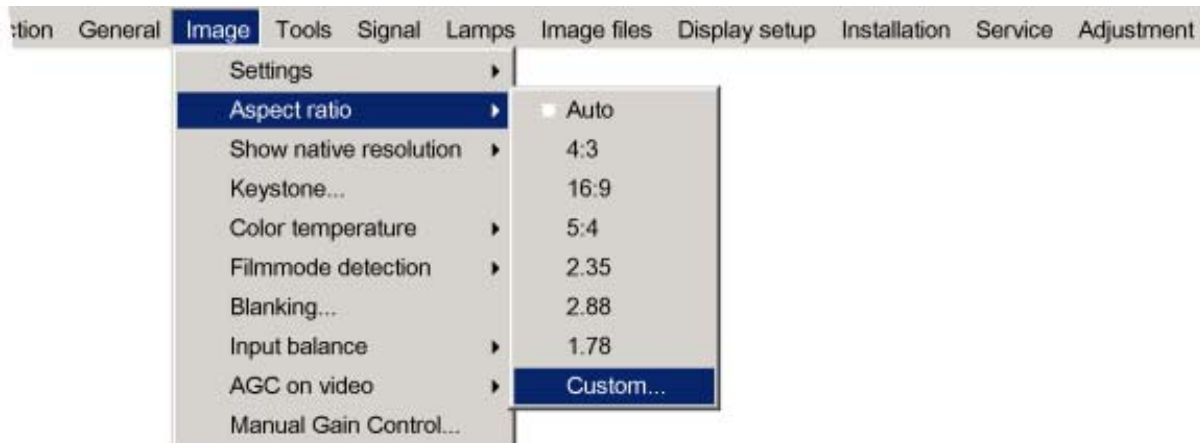

Image 8-14

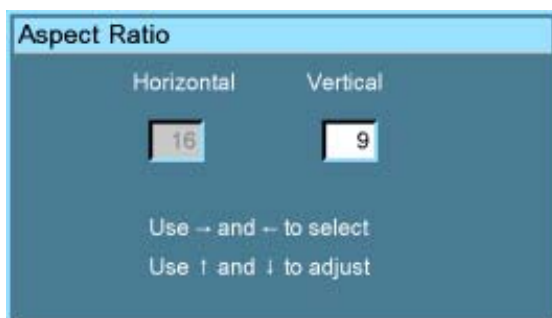

Image 8-15

## 8.4 Show native resolution



**Show native resolution** overrides the *Full Screen Representation* function in *Display Setup*.



**Show native resolution** is greyed out for video signals.



**DMD**  
Digital Micromirror Device

### What can be done

The aim here is to always show the resolution of the source independently of the resolution of the DMD panels.

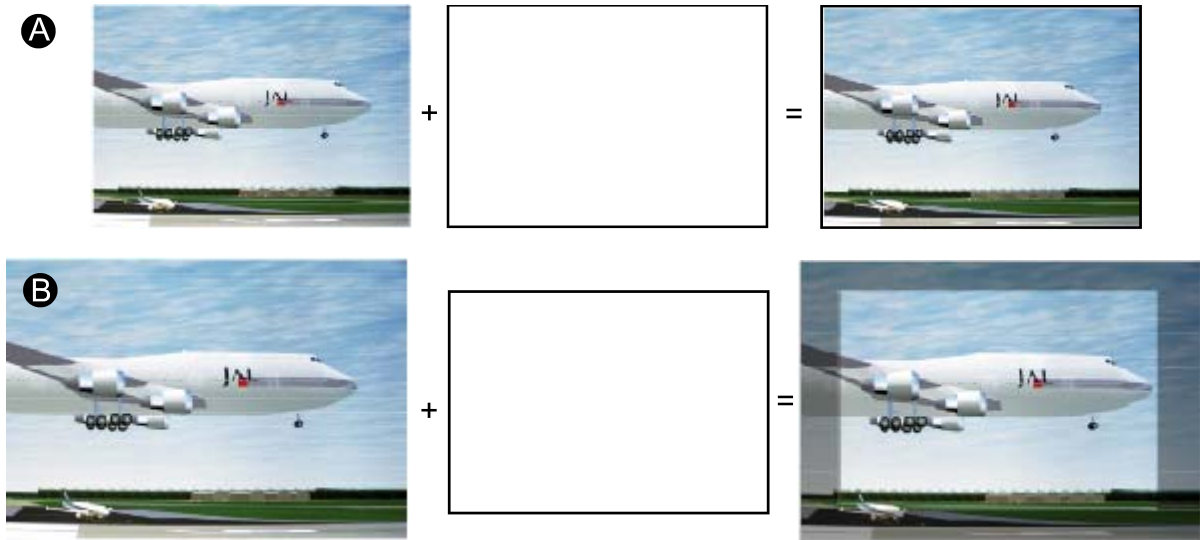

Image 8-16

When the *show native resolution* function is in the ON position, the projector handles the source as follows:

Source			Projected image		
Name	Ratio	Resolution	Ratio	Resolution	
XGA	4:3	1024x768	4:3	1024x768	normal image projected
SXGA	5:4	1280x1024	5:4	1280x1024	part of the image displayed, image scroll possible
SXGA+	4:3	1400x1050	4:3	1400x1050	part of the image displayed, image scroll possible
UXGA	4:3	1600x1200	4:3	1600x1200	part of the image displayed, image scroll possible

### How to enable the “Show native resolution” function?

1. Press **MENU** to activate the menu bar.
2. Press → to select the *Image* item.
3. Press ↓ to pull down the *Image* menu.
4. Use ↑ or ↓ to select *Show native resolution*. (image 8-17)
5. Press → to pull down the menu.



6. Use ↓ or ↑ to select *On*.
7. Press **ENTER** .  
A white bullet shows the selection.

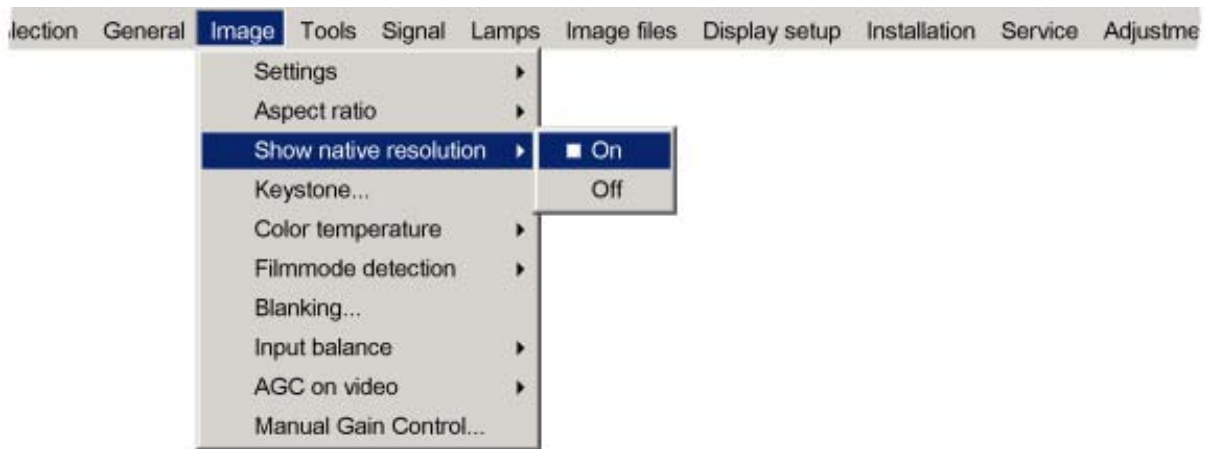

Image 8-17



When *Show Native Resolution* is in the **ON** position, scrolling of the image is possible with the arrow keys on the remote control.

## 8.5 Keystone correction

### What can be done ?

The Keystone adjustment is used to align the image, this can be necessary when projecting under a non standard angle

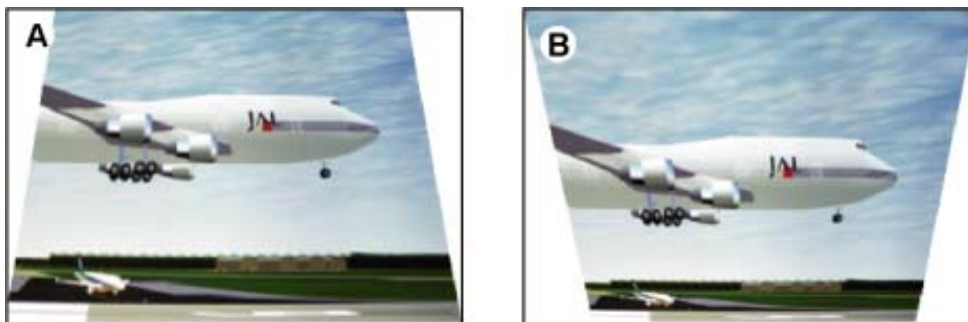

Image 8-18  
Keystone adjustment

- A Top adjustment of the keystone  
B Bottom adjustment of the keystone

### How to perform a Keystone correction ?

1. Press **MENU** to activate the menu bar.
2. Press → to select *Image*.
3. Press ↓ to pull down the *Image* menu.
4. Use ↑ or ↓ to select *Keystone*. (image 8-19)
5. Press **ENTER** to confirm.  
A slider box is displayed . (image 8-20)
6. Use ← or → to adjust the keystone.  
Or,  
enter the desired value with the numeric keys.  
The top and bottom adjustments affect the image differently.

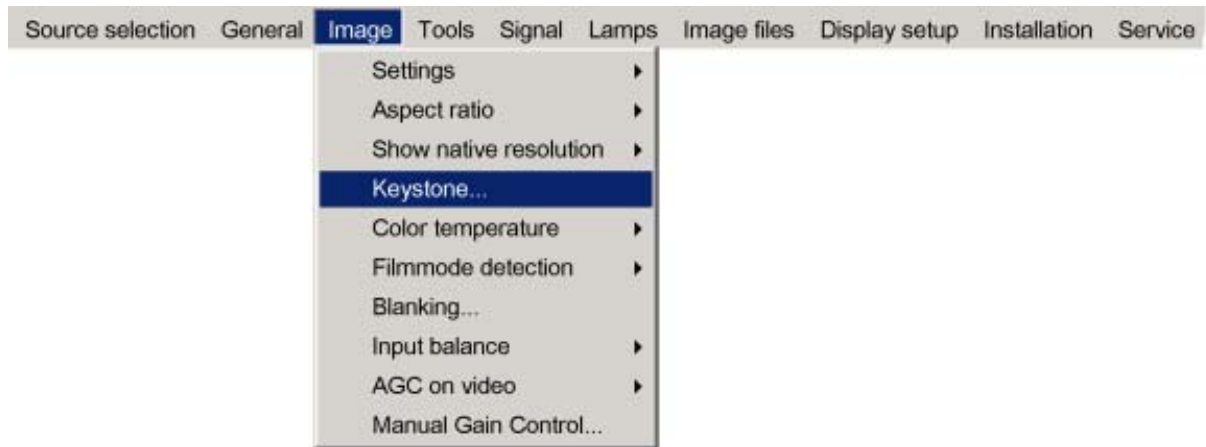

Image 8-19

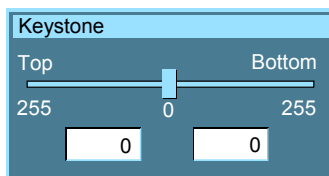

Image 8-20

## 8.6 Color Temperature

---

### What can be done ?

The color temperature can be selected according to the type of source:

There are 6 different preset color temperatures:

- Projector white
- computer : 9300 K
- Video : 6500 K
- Film : 5400 K
- Broadcast : 3200 K
- Custom Preset value

The first 5 calibrated presets can be selected and will provide optimum color tracking, the projector allows however the setting of a personal preset color temperature, this is done in *Custom Preset*. Next to that Custom Preset a Custom value, which is only valid for that moment, can be set in Custom.



**Projector white will provide maximum projector light output.**

### Difference between Custom Preset and Custom

A *Custom Preset* color temperature is any color temperature set by the user and saved for later use. This value can be recalled in the same way as a calibrated value.

*Custom* is used when the user wants to use a variation on a calibrated color temperature. This custom setting remains available until another preset is selected which will overwrite the current custom values.

### How to select a preset color temperature ?

1. Press **MENU** to activate the menu bar.
2. Press → to select the *Image* item. (image 8-21)
3. Press ↓ to pull down the *Image* menu.
4. Use ↑ or ↓ to select *Color temperature*.

5. Press → to pull down the menu.
6. Use ↓ or ↑ to select the desired preset color temperature.
7. Press **ENTER** to confirm.

The color temperature of the image is adapted and a white bullet shows the active setting in the menu bar.

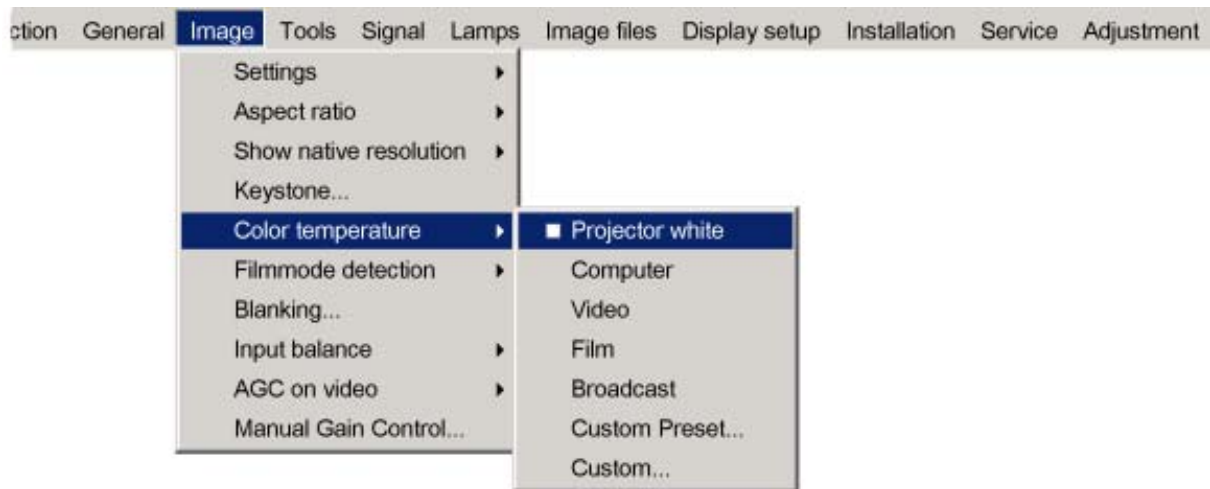

Image 8-21

### How to store a customer created color temperature on Custom Preset?

1. Press **MENU** to activate the menu bar.
2. Press → to select the *Image* item. (image 8-22)
3. Press ↓ to pull down the *Image* menu.
4. Use ↑ or ↓ to select *Color temperature*.
5. Press → to pull down the menu.
6. Use ↓ or ↑ to select *Custom Preset*.
7. Press **ENTER** to confirm.

A slider box for the x-coordinate is displayed as well as a wizard text box in the lower part of the screen. (image 8-23)

Adjust first x and then y. Use **Color** button to toggle between x and y. (image 8-24)

The color temperature value will be stored for later use.

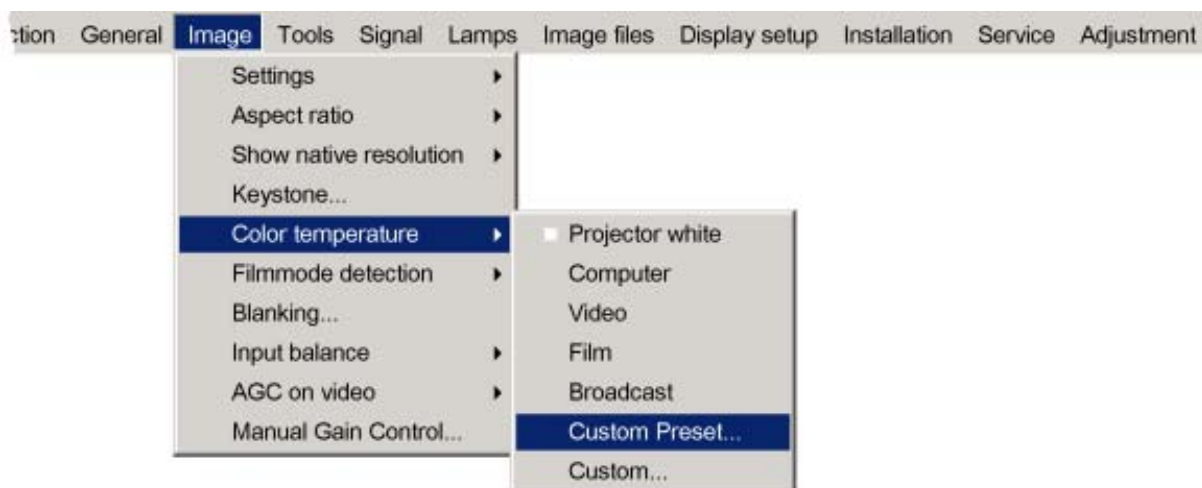

Image 8-22

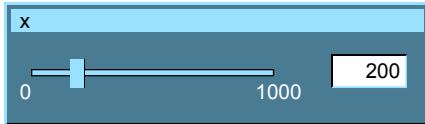

Image 8-23



Image 8-24



the x and y coordinate changes between 0.00 and 1.00. For practical reasons, the values on the slider box are multiplied by 1000.

### How to start up the custom color temperature ?

1. Press **MENU** to activate the menu bar.
2. Press **→** to select the *Image* item. (image 8-25)
3. Press **↓** to pull down the *Image* menu.
4. Use **↑** or **↓** to select *Color temperature*.
5. Press **→** to pull down the menu.
6. Use **↓** or **↑** to select *custom*.
7. Press **ENTER** to confirm.

A slider box for the x-coordinate is displayed as well as a wizard text box in the lower part of the screen. (image 8-26)

Adjust first x and then y. Use **Color** button to toggle between x and y. (image 8-27)

Once another preset is selected, the current value is lost.

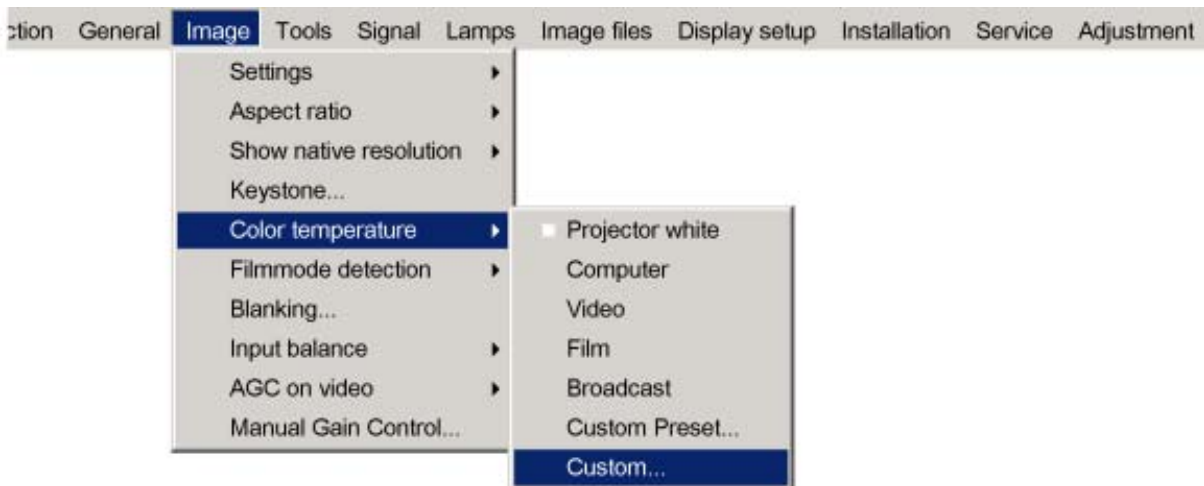

Image 8-25

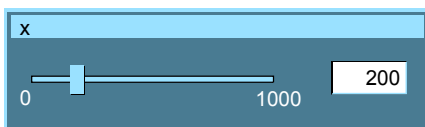

Image 8-26



Image 8-27



the x and y coordinate changes between 0.00 and 1.00. For practical reasons, the values on the slider box are multiplied by 1000.

## 8.7 Filmmode detection

### What can be done ?

Some sources like common DVD material are derived from cinema 24 Hz sources (2/2 or 3/2 pull down method).

The filmmode detection insures that these converted signals are shown without artefacts.



**This function may cause undesired effects on standard sources, therefore it can be disabled (OFF) at any time**



### 2:2 pull-down

The process of transferring 24-frames/sec film format into video by repeating each frame (used for PAL DVD's) as two video fields. ( AD )



### 3:2 pull-down

Method used to map the 24 fps of film onto the 30 fps (60 fields) or 25 fps (50 fields), so that one film frame occupies three video fields, the next two, etc. It means the two fields of every other video frame come from different film frames making operations such as rotoscoping impossible, and requiring care in editing. Some sophisticated equipment can unravel the 3:2 sequence to allow frame-by-frame treatment and subsequently re-compose 3:2. The 3:2 sequence repeats every five video frames and four film frames, the latter identified as A-D. Only film frame A is fully on a video frame and so exists at one time code only, making it the editable point of the video sequence.



### Artefacts

Undesirable elements or defects in a video picture. These may occur naturally in the video process and must be eliminated in order to achieve a high-quality picture. Most common in analog are cross color and cross luminance. Most common in digital are macroblocks, which resemble pixelation of the video image.

### Enabling/disabling the filmmode detection

1. Press **MENU** to activate the menu bar.
2. Press **→** to select the *Image* item. (image 8-28)
3. Press **↓** to pull down the *Image* menu.
4. Use **↑** or **↓** to select *Filmmode detection*.
5. Press **→** to pull down the menu.
6. Use **↓** or **↑** to enable or disable the Filmmode detection.
7. Press **ENTER**.

A white bullet shows the active setting.

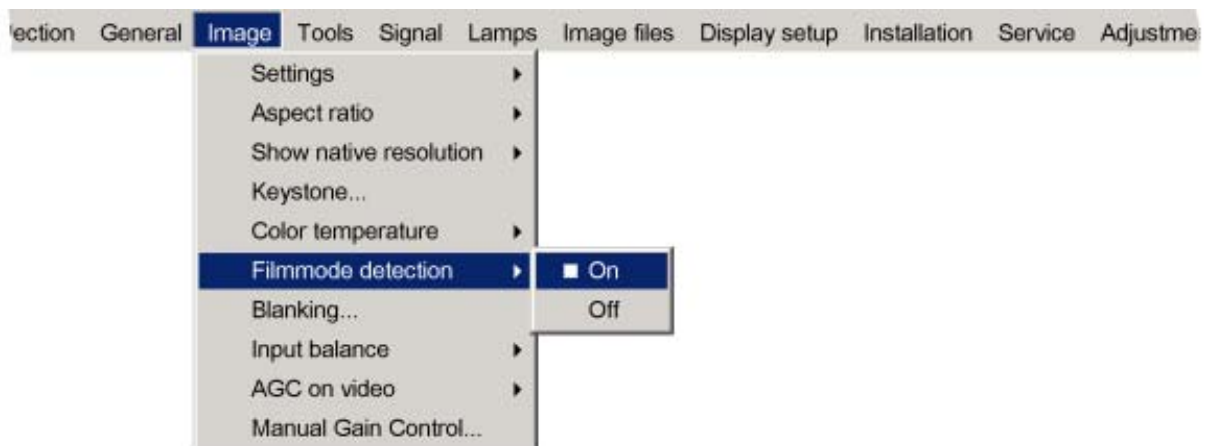

Image 8-28

## 8.8 Blanking

### What can be done ?

Blanking adjustments affect only the edges of the projected image and are used to frame the projected image on the screen and to hide or black out unwanted information (or noise). A '0' indicates no blanking.

### Which blanking adjustments are available ?

- top blanking
- bottom blanking
- right blanking
- left blanking

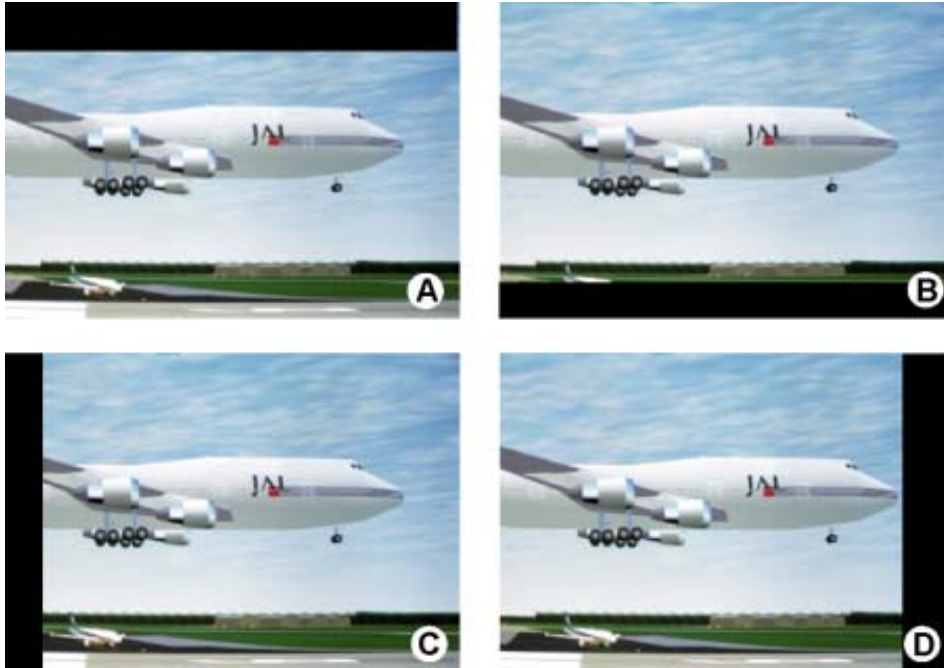

Image 8-29  
Blanking

- A Top blanking
- B Bottom blanking
- C Left blanking
- D Right blanking

### Adjusting the blanking

1. Press **MENU** to activate the menu bar.
2. Press **→** to select the *Image* item. (image 8-30)
3. Press **↓** to pull down the *Image* menu.
4. Use **↑** or **↓** to select *Blanking*.
5. Press **ENTER** to confirm.

The Blanking pop-up menu appears. (image 8-31)

6. Use **←** or **→** to select *Enabled* or *Disabled*.

Enabled      Blanking adjustment is possible

Disabled     Blanking adjustment is not possible

7. Use the  $\uparrow$  or  $\downarrow$  keys to select *Top*, *Bottom*, *Left* or *Right* blanking and change the value with  $\leftarrow$  or  $\rightarrow$  until the desired blanking is obtained.  
Or,  
use the  $\uparrow$  or  $\downarrow$  keys to select *Top*, *Bottom*, *Left* or *Right* blanking and press **ENTER** to change the value indication to a input field and enter a new value with the keyboard. Press **ENTER** to accept this value. (image 8-32)

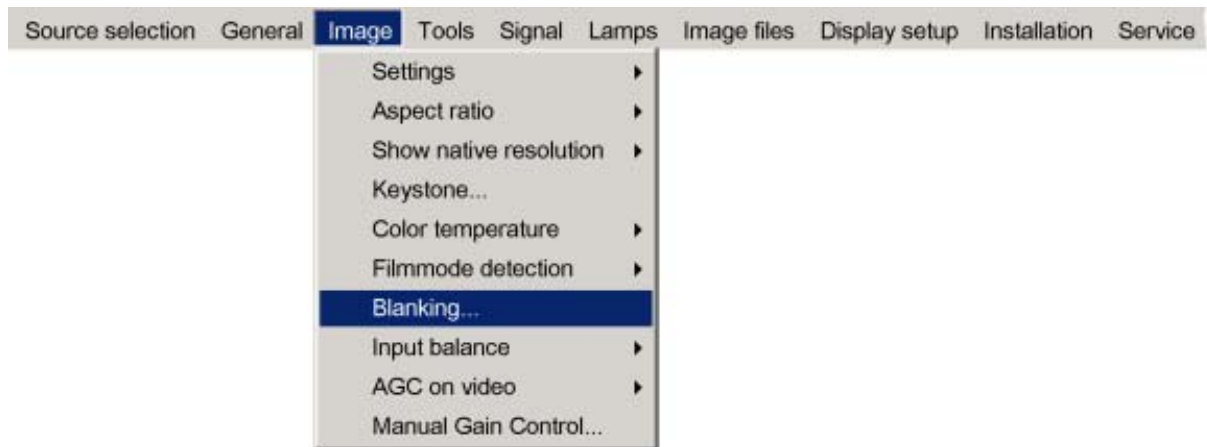

Image 8-30

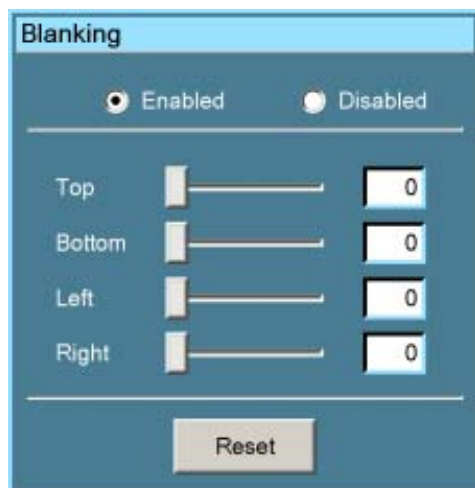

Image 8-31

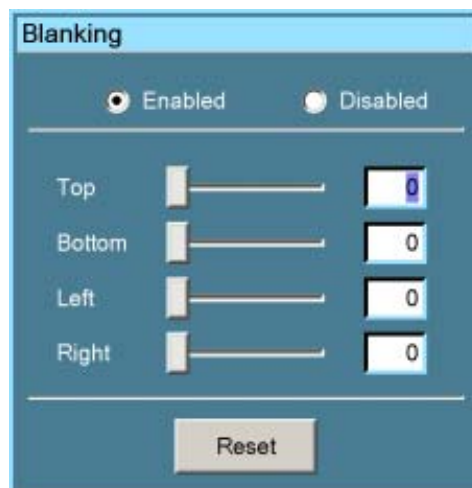

Image 8-32

## 8.9 Input Balance

### Overview

- Introduction to Input Balance
- Adjusting the input balance
- Input balance for YPrPb signals

### 8.9.1 Introduction to Input Balance

#### Introduction: Unbalanced color signals

When transporting signals, there is always a risk of deterioration of the information contained in the signals.

## 8. Image Menu

In case of information contained in the amplitude of the signals which is the case of data color signals (R, G, B), image 8-33, we are quite sure that the amplitude of these color signals is subject to alterations.

An example of alteration may be a DC component added to the signal, in the form of a DC offset repositioning the black level, since this **black level** (“**brightness**”) will become crucial later on (clamping circuit) it will result in “black not being black”.

Another value that is subject to alteration is the amplitude of the signal, resulting in an altered “Gain” of the signal (“**white level**” or **contrast**).

The alterations of the three color signals will happen independently i.e. the colors will end to be unbalanced, image 8-34

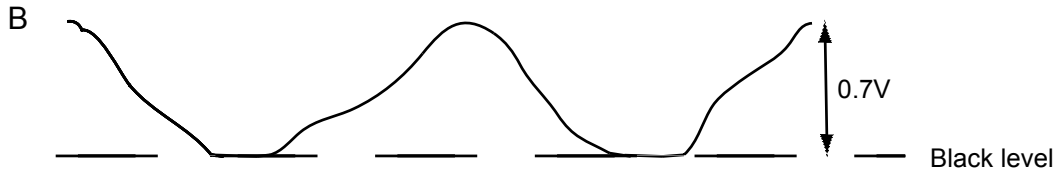

Image 8-33

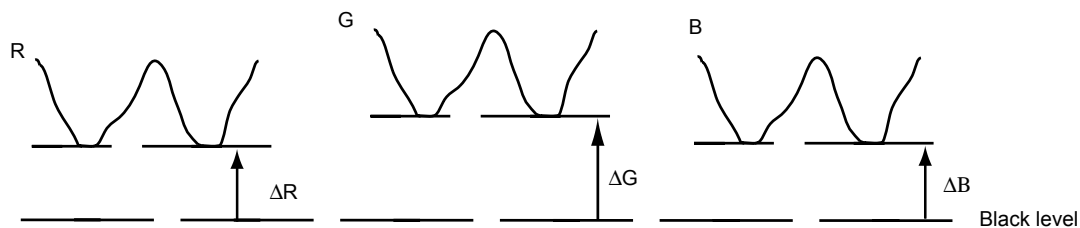

Image 8-34



One can conclude here that a good color tracking can only be met by using three previously (input) balanced color signals

### Analog Digital Conversion

The analog color signals must pass through an Analog/Digital conversion circuit prior to any digital processing in the PMP.

A typical ADC transforms the analog value into an 8 bit coded digital signal.

The graphic shows that when converting a signal containing a DC offset component the range of the converter is not optimally used.

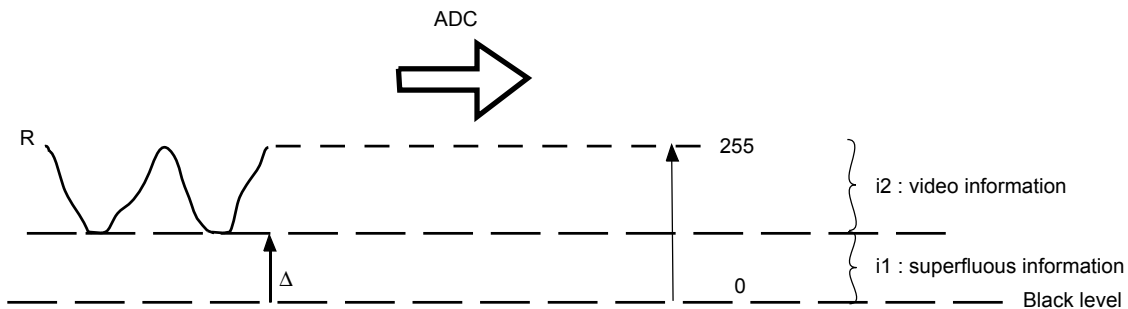

Image 8-35



One can conclude here that a good data conversion can only be met by using three previously (input) balanced color signals

### The objective of input balancing

The objective in input balancing is to “set” the same black level and the same white level for the three colors of a particular input source.





**Black level setting : brightness**

**White level setting : contrast**

The same absolute black and white level for the three colors allow the same reference for Brightness and contrast control of the picture !

These two references also set the range in which the ADC will work for that particular source (this explains also why each input balance setting is linked to a particular source and thus saved in the image file).

## 8.9.2 Adjusting the input balance

### How can it be done ?

To balance the three color signals of a particular source there are conditions; in fact we must know the black and the white level of the source i.e. :

1. The source in question must be able to generate a white signal, ideally a 100% white (background) full screen pattern
2. The source in question must be able to generate a black signal, ideally a 100% black (background) full screen pattern

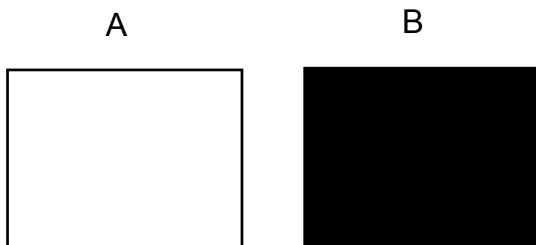

Image 8-36

White balance : In the projector, we will set the contrast for each color until we get a 100% light output picture when projecting a 100% white image (image A)

Black balance : In the projector, we will set the brightness for each color until we get a 0% light output picture when projecting a 100% black image (image B).



**The changeover from min to max is indicated by the apparition of bright spots also called “digital noise”**



**An alternative to a full screen White/black pattern is the standard gray scale pattern, the white bar will be used for white balance and the black bar for black balance.**

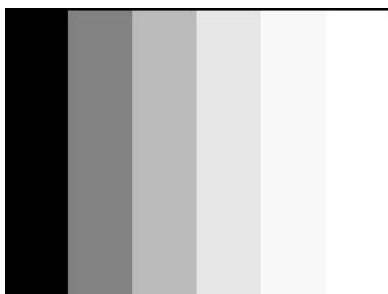

Image 8-37

### Black balance

1. Press **MENU** to activate the menu bar.
2. Press → to select the *Image* item.
3. Press ↓ to pull down the *Image* menu.
4. Use ↑ or ↓ to select *Input balance*.
5. Press → to pull down the menu.
6. Use ↓ or ↑ to select *Black balance*. (image 8-38)
7. Adjust the red black level on a minimal value (image 8-39, image 8-40)
8. Adjust the blue black level on a minimal value  
**Note:** *This minimal value is not necessary, provided that the 2 other colors are not influencing too much the color to be adjusted, in fact the aim is to minimize the effect of the two other colors since there is a risk of reaching too soon the 50% transition due to the contribution of these two other colors signals.*
9. Adjust the Green black level until bright spots appear on the screen.
10. Adjust the Blue black level until bright spots appear on the screen.
11. Adjust the Red black level until bright spots appear on the screen.

The projected image should now be noisy full black

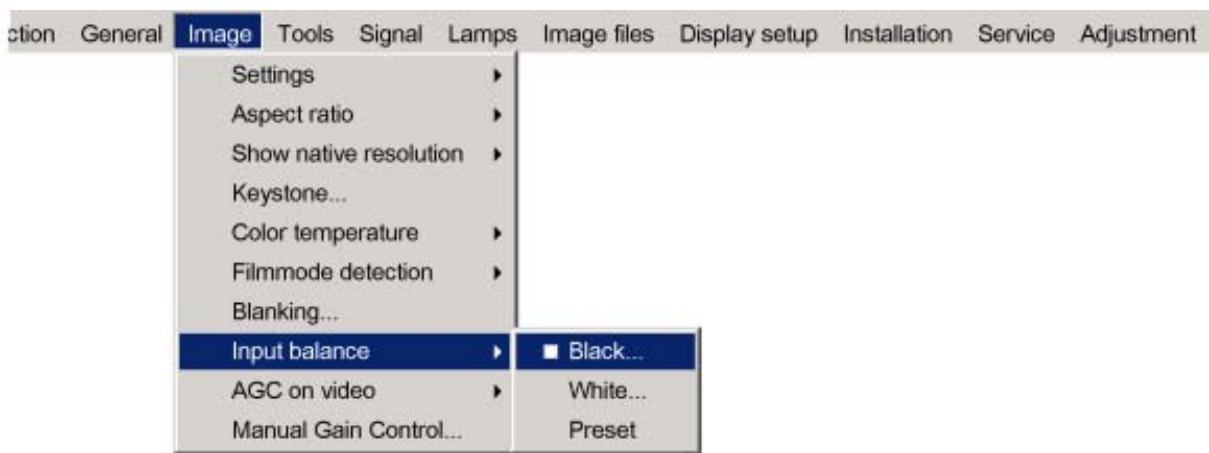

Image 8-38

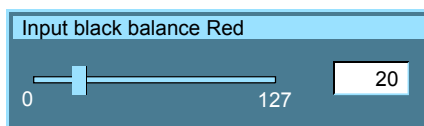

Image 8-39



Image 8-40



If one uses a gray scale pattern, the bright spots should appear in the black bar.

---

### Performing White input balance

1. Connect the source you want to project.
2. Select a white pattern (or gray scale as alternative).
3. Press **MENU** to activate the menu bar.
4. Press → to select the *Image* item.
5. Press ↓ to pull down the *Image* menu.

6. Use ↑ or ↓ to select *Input balance*.
  7. Press → to pull down the menu.
  8. Use ↓ or ↑ to select *White balance*. (image 8-41)
  9. Adjust the Red white level (gain) on a minimal value. (image 8-42)
  10. Adjust the blue white level (gain) on a minimal value
 

**Note:** *This minimal value is not necessary, provided that the 2 other colors are not influencing too much the color to be adjusted, in fact the aim is to minimize the effect of the two other colors since there is a risk of reaching too soon the transition (bright spots) due to the contribution of these two other colors signals.*
  11. Adjust the Green white level (gain) until bright spots appear on the screen
  12. Adjust the Blue white level (gain) until bright spots appear on the screen
  13. Adjust the Red white level (gain) until bright spots appear on the screen
- The projected image should now be noisy neutral grey.

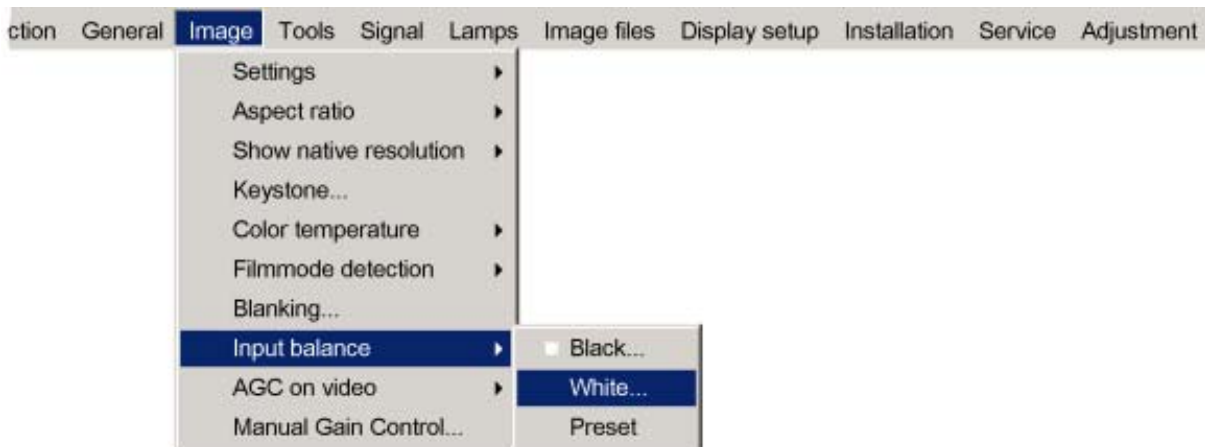

Image 8-41

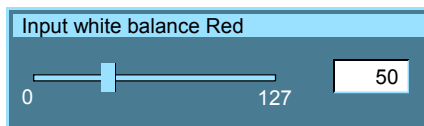

Image 8-42



If one uses a gray scale pattern, the bright spots should appear in the white bar.



Selecting *Preset* restores the factory input balance setting

### 8.9.3 Input balance for YPrPb signals

#### Remark on the input balance of a component video source



Before starting the Input Balance procedure, generate a signal with dominant white parts.

## 8. Image Menu

---

Input balance is also available for a component video source under following conditions:

- A component video signal is present on the BNC's.
- "Data on BNC's" is selected in the *Source selection menu*.
- Pr/Y/Pb is selected in the Advanced menu of the corresponding image file.

The procedure is the same as for a data source except:

- The white balance happens only on Green.  
Adjust until bright spots appear in the image.

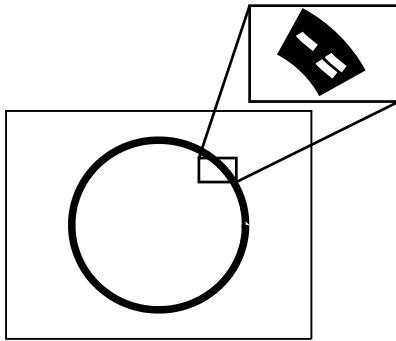

Image 8-43

- The black balance happens on the three colors.  
The PR and PB connector have to be removed from the input.  
Adjust until noise appears in the image.

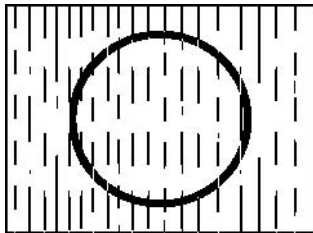

Image 8-44

### 8.10 AGC on Video

---



#### AGC

Automatic Gain Control: allows an automatic amplitude (gain) control of the incoming video signal

---



**AGC is only for Video signals.**

---

#### Enabling/disabling the AGC

1. Press **MENU** to activate the menu bar.
2. Press **→** to select the *Image* item.
3. Press **↓** to pull down the *Image* menu.
4. Use **↑** or **↓** to select *AGC on Video*.

5. Press → to pull down the menu.
6. Use ↓ or ↑ to enable or disable the AGC.
7. Press **ENTER** to confirm. (image 8-45)  
A white bullet shows the active setting.

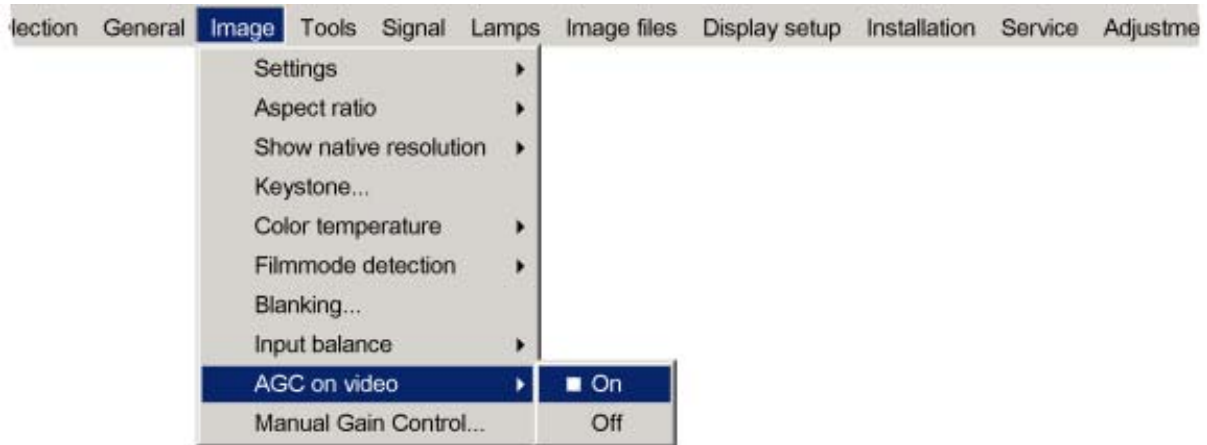

Image 8-45



The AGC can be disturbing in case of Macrovision encoded signals, therefore the AGC can be disabled (OFF) at any time

## 8.11 Manual Gain Control

### What can be done ?

When *AGC on Video* is disabled, the gain of the incoming video signal can be set manually. The manual gain control must be done on an external pattern with white areas (grey scale bar pattern).

### How to set the Manual Gain Control ?

1. Press **MENU** to activate the menu bar.
2. Press → to select the *Image* item.
3. Press ↓ to pull down the *Image* menu.
4. Use ↑ or ↓ to select *Manual Gain Control*. (image 8-46)
5. Press **ENTER** to confirm.  
A scroll bar is displayed. (image 8-47)
6. Use ← or → to adjust the gain so that uniform white parts in the image are obtained.  
Or,  
use the numeric keys to enter the desired value.

## 8. Image Menu

---

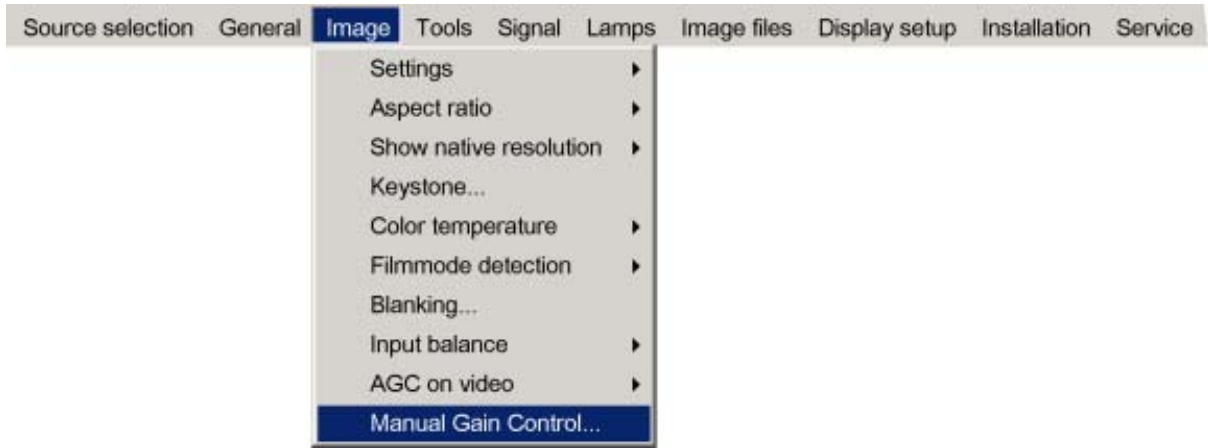

Image 8-46



Image 8-47

## 9. TOOLS MENU

### Overview

- Overview of the Tools menu
- Introduction to PiP
- PiP select
- PiP add window
- PiP remove window
- PiP layout
- PiP Adjust

### 9.1 Overview of the Tools menu

#### Overview

- PiP select
  - Full-screen
  - 2by2 raster
  - PiP layout 1
  - PiP layout 2
  - PiP layout 3
- PiP add window...
- PiP remove window...
- PiP layout
  - Save
  - Save as
  - Rename
  - Delete
- PiP adjust

### 9.2 Introduction to PiP



#### PiP

PiP stands for "Picture in Picture" and allows to display multiple windows containing each of them an image. The windows may be of the video or data type.

#### What are the different possibilities within the PiP mode ?

The input section of the RLM G5i Performer projector allows a multitude of combinations of different input signals which may be projected in the 4 windows of the PiP screen.

The PiP mode allows independent settings for each window:

- Image settings : contrast, brightness, tint, color, ...
- Vertical and horizontal shift of each window all over the screen
- Re-sizing of the window
- Digital Zoom

### The different PiP configurations

- Full screen<sup>2</sup>

The full screen is used to display one of the selected sources.  
Browse through the sources with the **PiP Adjust** button on the remote control.

- 2-by-2 raster<sup>2</sup>

The screen is divided into 4 subscreens containing 1 Video, 2 Data sources and 1 SDI source.

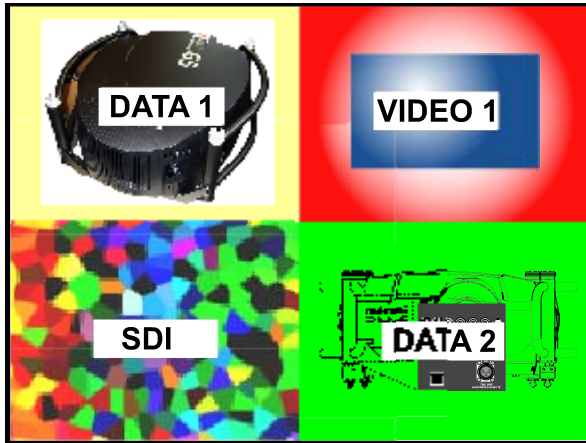

Image 9-1

- PiP layout 1 to 3<sup>3</sup>

These are factory layouts, they can be edited and saved.

- Personal layouts

Beside the 2 fixed layouts and the 3 factory layouts, you can create 5 additional (personal) layouts.

---

<sup>2</sup> fixed layout  
<sup>3</sup> factory layouts



### PiP dedicated buttons

- **PiP Adjust** : this button allows to focus on one particular window, this window is shown with a white frame surrounding the selected window.  
A source identification box is displayed in the right lower corner.

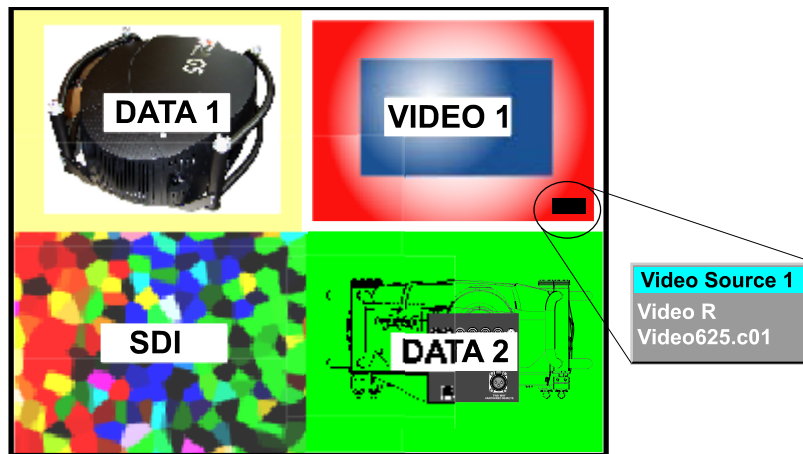

Image 9-2

Press **PiP Adjust** button to move the frame to the next window. This can also be done via *PiP Adjust* in the Tools menu.

- **PiP**: this button allows to browse through the different configurations, it has the same function as *PiP select* in the Tools menu.



Since there is only one decoder, when in 2-by-2 configuration, and only video 1 is displayed, this source will be duplicated at the same position as SDI.

## 9.3 PiP select

### What is possible ?

With PiP select it is possible to switch from one layout to another.



The PiP configuration can also be selected via the dedicated PiP key on the RCU.

### How to change the PiP configuration ?

1. Press **MENU** to activate the menu bar.
2. Press → to select the *Tools* item.
3. Press ↓ to pull down the *Tools* menu.
4. Use ↑ or ↓ to select *PiP select*.
5. Press → to pull down the menu.
6. Use ↑ or ↓ to select the desired configuration. (image 9-3)
7. Press **ENTER**.

A white bullet shows the active layout.

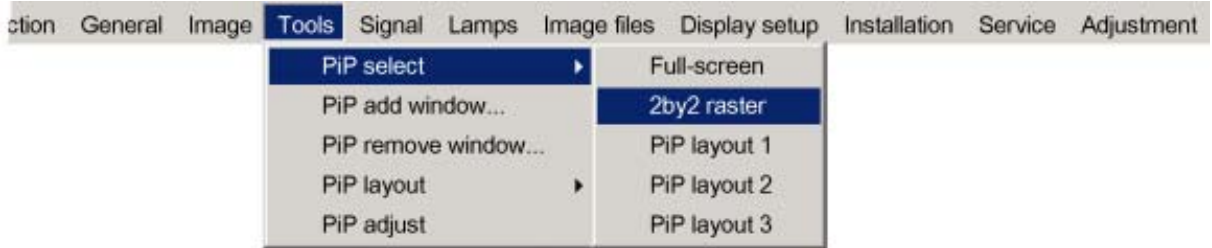

Image 9-3

## 9.4 PiP add window

### What can be done ?

It is possible to add a window to the existing windows (maximum 4), therefore a source must be selected.

Sources which are already used are not selectable. If for instance the PiP layout contains a component video then component video will be not selectable.

Once added, the window may be changed in several ways to meet particular needs:

- repositioning
- re-sizing
- changing the order

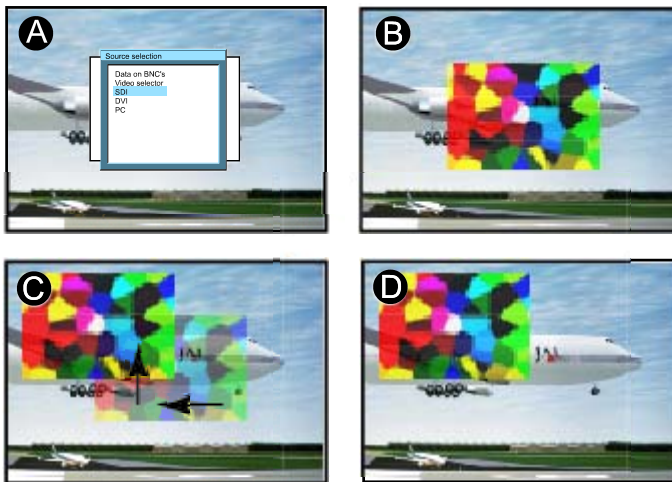

Image 9-4  
Add PiP Window

- A Select source for window
- B Window added
- C Move window
- D Z-ordering possible

### How to add a window ?

1. Press **MENU** to activate the menu bar.
2. Press → to select the *Tools* item.
3. Press ↓ to pull down the *Tools* menu.
4. Use ↑ or ↓ to select *PiP add window*. (image 9-5)
5. Press **ENTER**.

The source selection menu is displayed. (image 9-6)

In the lower part of the screen appears a 4 steps wizard.

6. Select the source you want to display in the window with the ↑ and ↓. (image 9-7)
7. Resize the new window with the 4 arrow keys. (image 9-8)
8. Position the window on the screen with the 4 arrow keys. (image 9-9)

9. Change the viewing order of the displayed images (z-order) with the ↑ and ↓ . (image 9-10)

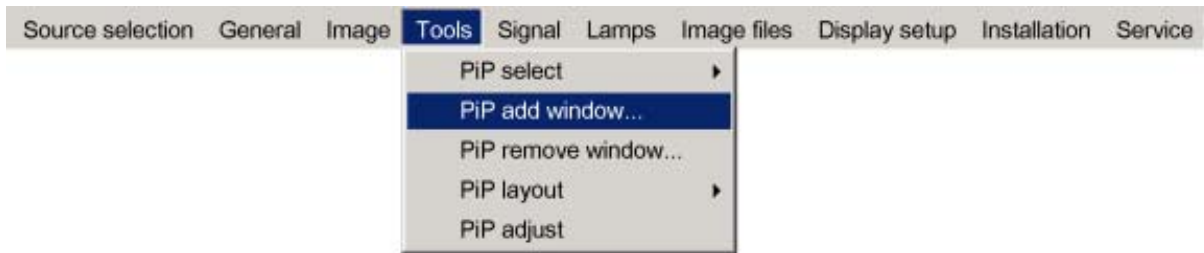

Image 9-5

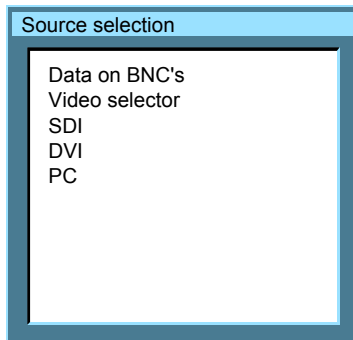

Image 9-6

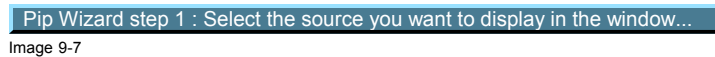

Image 9-7



Image 9-8



Image 9-9



Image 9-10

## 9.5 PiP remove window

### How to remove a window ?

1. Press **MENU** to activate the menu bar.
2. Press → to select the *Tools* item.
3. Press ↓ to Pull down the *Tools* menu.
4. Use ↑ or ↓ to select *PiP remove window*. (image 9-11)
5. Press **ENTER** .

In the lower part of the screen appears a wizard. (image 9-12)

The selected window appears surrounded with a white frame.

6. Press **PIP ADJUST** to move the frame along the different windows until the desired window is selected.
7. Press **ENTER** to remove that window.

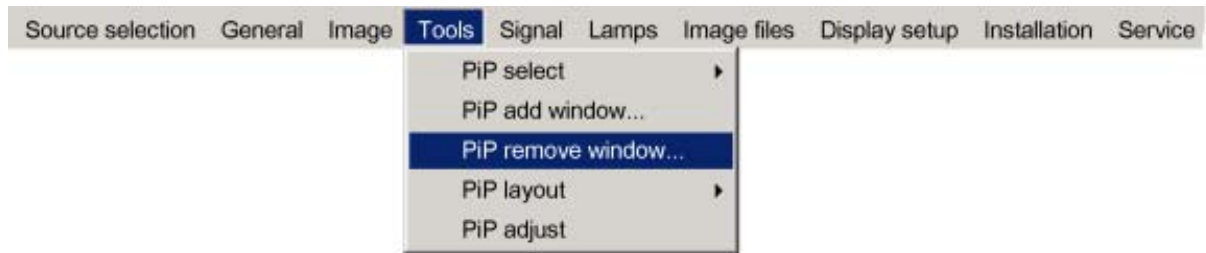

Image 9-11

Select window with <PiP ADJUST> → Press <ENTER> to remove

Image 9-12

## 9.6 PiP layout

---

### Overview

- PiP Save
- PiP rename layout
- PiP delete layout

### 9.6.1 PiP Save

#### What can be done ?

The active layout can be saved or "saved as".

When a new layout is saved it is added to the *PiP select* menu.



A fixed layout can be edited (re-sizing, re-positioning,...) but it can not be saved under its original name.

#### How to save a layout ?

1. Press **MENU** to activate the menu bar.
2. Press → to select the *Tools* item. (image 9-13)
3. Press ↓ to pull down the *Tools* menu.
4. Use ↑ or ↓ to select *PiP layout*.
5. Press → to pull down the menu.
6. Use ↑ or ↓ to select *PiP save* or *save as*.
7. Press **ENTER**.

If *save as* has been selected, a dialog box is displayed. (image 9-14)

Press **ENTER** to select the input field.

Use ← or → to enter the name and exit with **BACK** or **MENU**. (numeric values can be added with the remote control)

If *save* has been selected, a message box is displayed. (image 9-15)

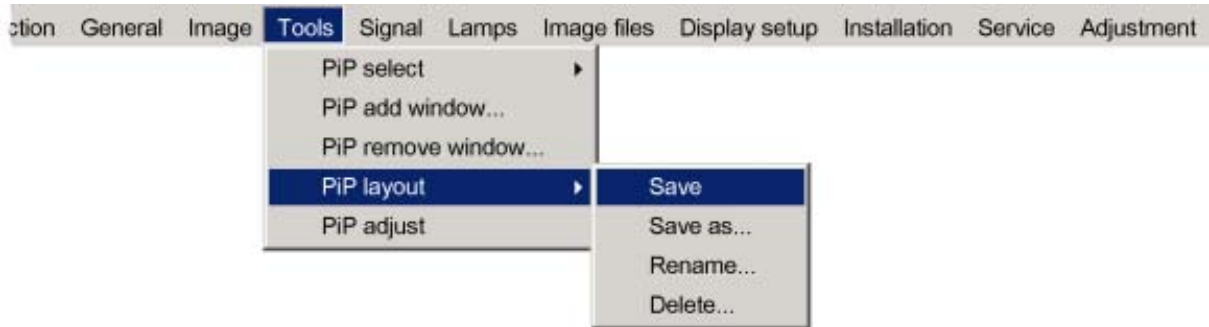

Image 9-13

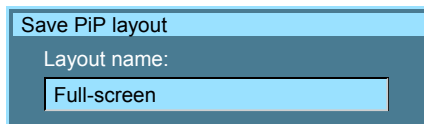

Image 9-14

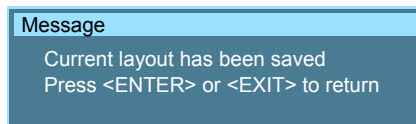

Image 9-15

### 9.6.2 PiP rename layout

#### What can be done ?

The non fixed layouts (factory and personal layouts) can be renamed .

The maximal length of the name is 12 characters.



**A fixed layout can not be renamed**

#### How to rename a layout ?

1. Press **MENU** to activate the menu bar.
2. Press → to select the *Tools* item. (image 9-16)
3. Press ↓ to pull down the *Tools* menu.
4. Use ↑ or ↓ to select *PiP layout*.
5. Press → to pull down the menu.
6. Use ↑ or ↓ to select *Rename*.
7. Press **ENTER**.  
A dialog box is displayed. (image 9-17)
8. Use ↑ or ↓ to select the layout to be renamed.
9. Press **ENTER** to select.  
A dialog box is displayed. (image 9-18)  
Press **ENTER** to activate the input box.  
Use ← or → to enter the name and exit with **BACK** or **MENU** (numeric values can be entered with the remote control).

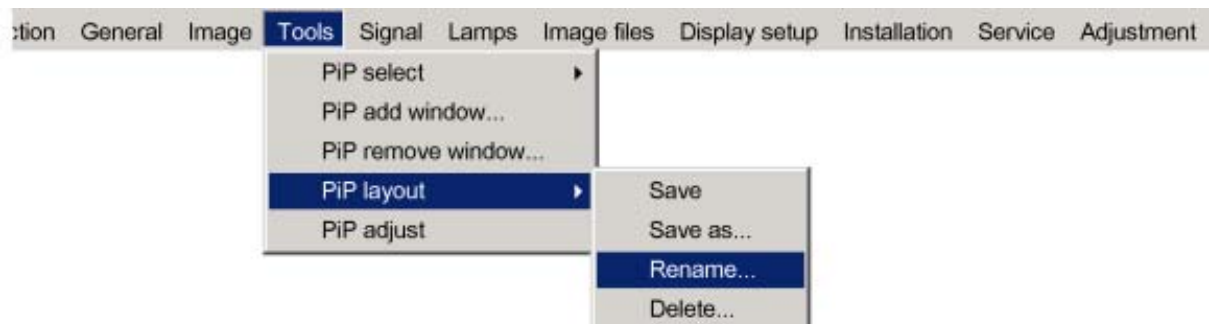

Image 9-16

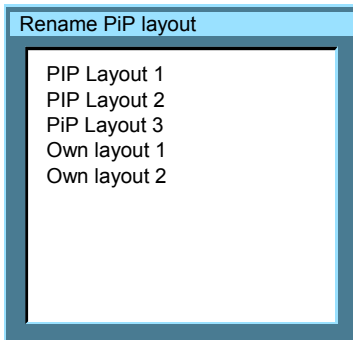

Image 9-17

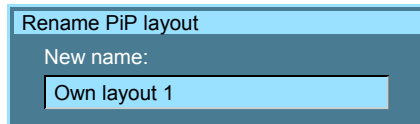

Image 9-18

### 9.6.3 PiP delete layout

#### What can be done ?

The non fixed layouts (factory and personal layouts) can be deleted.



**The fixed layouts and the active layout can not be deleted**

---

#### How to delete a layout ?

1. Press **MENU** to activate the menu bar.
2. Press → to select the *Tools* item.
3. Press ↓ to pull down the *Tools* menu .
4. Use ↑ or ↓ to select *PiP layout*.
5. Press → to pull down the menu.
6. Use ↑ or ↓ to select *Delete*.
7. Press **ENTER**.

A dialog box is displayed. (image 9-19)

8. Use ↑ or ↓ to select the layout to be deleted.
9. Press **ENTER** to confirm.

The layout is deleted and disappears from the dialog box.

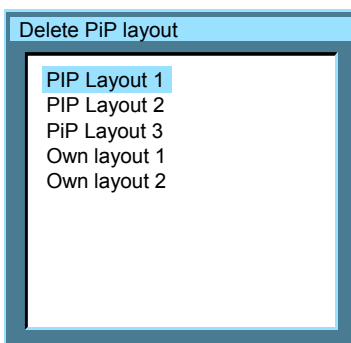

Image 9-19

## 9.7 PiP Adjust

---

#### What can be done ?

PiP adjust allows to browse through the windows in the active layout, a white frame indicates the window which has the focus.

This way, independent settings (picture settings, ...) are possible for each window.



This can also be done by using the dedicated PiP Adjust key on the RCU

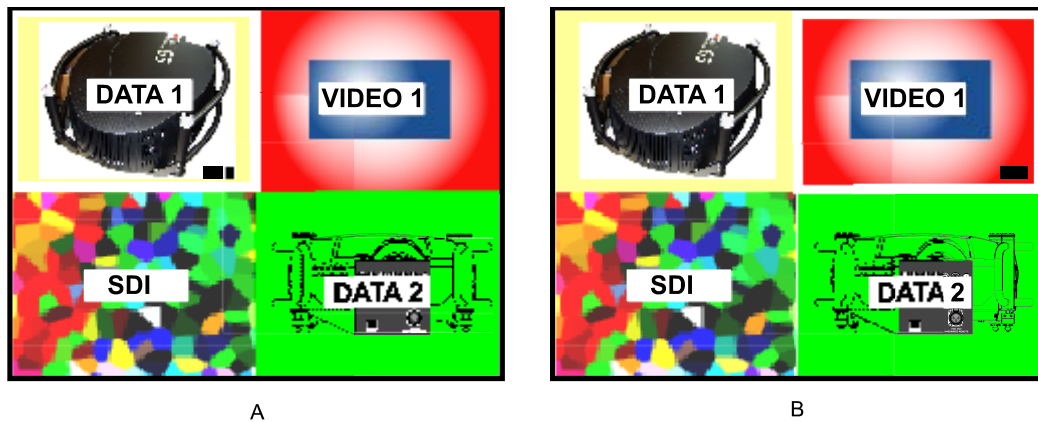

Image 9-20  
PiP adjust in case of 2-by-2 layout

- A Data1 window has the focus, new settings will only affect Data1 window  
 B Video1 window has the focus, new settings will only affect Video1 window

### PiP adjust

1. Press **MENU** to activate the menu bar.
2. Press **→** to select the *Tools* item. (image 9-21)
3. Press **↓** to pull down the *Tools* menu.
4. Use **↑** or **↓** to select *PiP Adjust*.
5. Press **ENTER**.  
The menu disappears.
6. Press **ENTER** to move the focus to the next window (clockwise rotation).  
If you press **BACK** or if you wait 5 seconds the menu is displayed again.

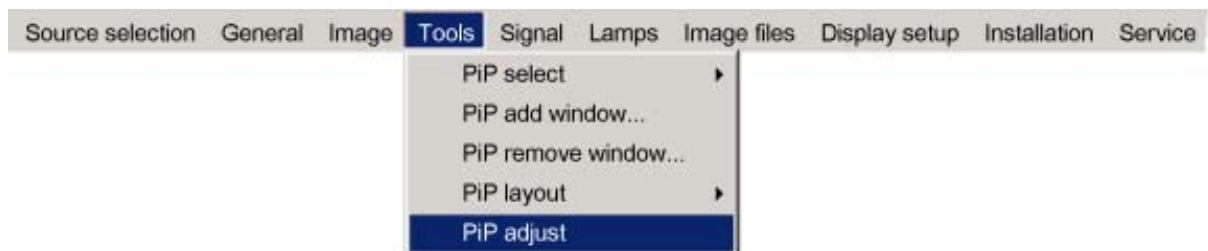

Image 9-21

### How to adjust a window in the layout ?

1. Use the PiP Adjust key or function in the menu to choose the window to be adjusted.
2. Press **ENTER**.  
All actions can be taken on the focused window.





---

## 10. SIGNAL MENU

### Overview

- Overview of the Signal menu
- Switching mode
- Output Frame rate
- Background

---

### 10.1 Overview of the Signal menu

#### Overview

- Switching mode
  - Seamless
  - Box in
  - Box out
  - Shift in left
  - Shift in right
  - Shift in top
  - Shift in bottom
  - Vertical curtain open
  - Vertical curtain close
  - Horizontal curtain open
  - Horizontal curtain close
  - Fade in out
  - Random
- Output frame rate
  - Synchronous
  - 50 Hz
  - 60 HZ
- Background
  - Blue
  - Black

---

### 10.2 Switching mode

#### Switching from one source to another

To minimize undesired effects when switching from one source to another, one can use the Seamless switching mode. Beside *Seamless switching* there is a wide choice of several effects which render the source switching transitions more enjoyable.

#### How to select a switching mode ?

1. Press **MENU** to activate the Tool bar.
2. Press → to select the *Signal* item. (image 10-1)
3. Press ↓ to pull down the *Signal* menu.
4. Use ↑ or ↓ to select *Switching mode*.
5. Press → to pull down the menu.
6. Use ↑ or ↓ to select the desired switching mode.
7. Press **ENTER**.

A white bullet shows the active effect.

The next source switching will be done using the selected effect.

## 10. Signal menu

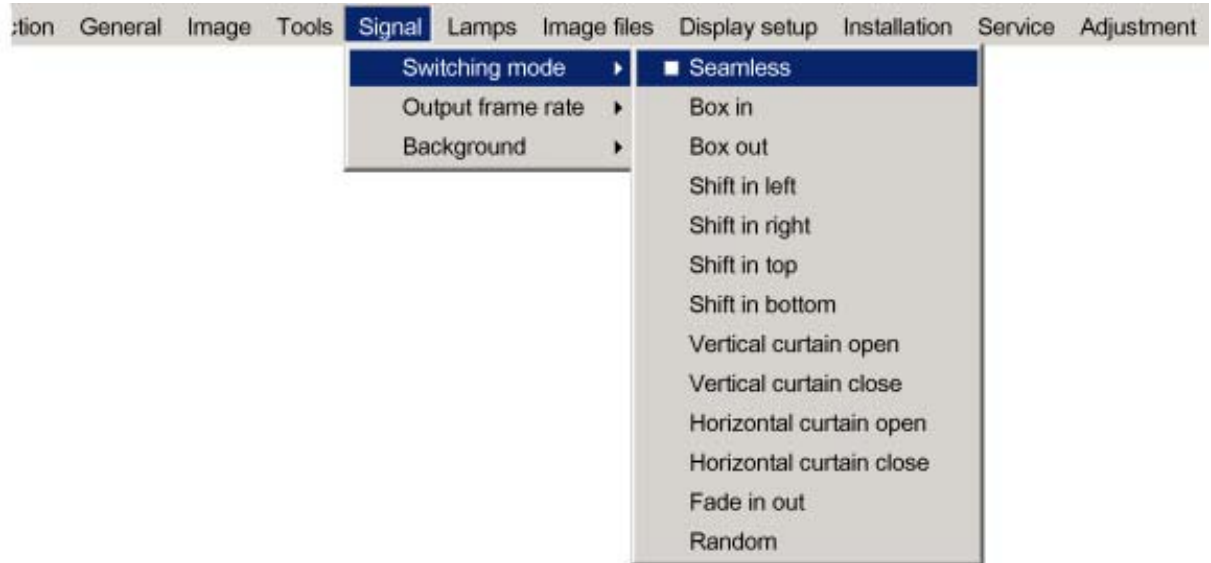

Image 10-1



The *Random* mode will select a new switching mode at each source switching i.e. there will never be 2 successive source switchings with the same effect.

The *Seamless* switching mode is not used in the *Random* mode.

### Note on Fade in/out

In some cases, depending on the sources to be switched, the fade in/out effect is impossible or may not occur.

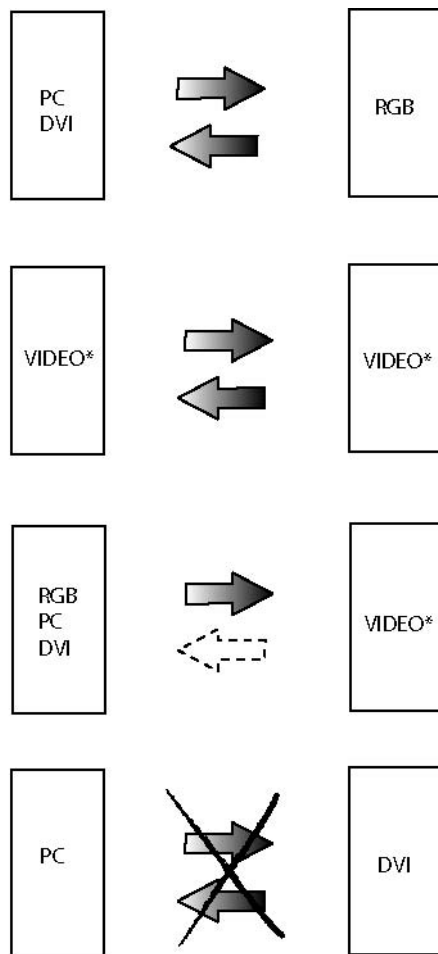

Image 10-2

\* Video may be Composite video/ S-Video / SDI

- dark arrow : fade in/out effect possible
- dotted arrow : undetermined case, fade in/out effect may take place or not
- striked out arrow : fade effect impossible



**The switching effects are only possible in the full screen mode**

### 10.3 Output Frame rate

#### What can be done ?

To avoid transition effects when switching from a source with a frame rate of 50 Hz to a source with frame rate of 60 Hz or vice versa, set the output frame rate to one typical frequency. The default value for this setting is synchronous, that means that the output frame rate follows the input source. When the source is 50 Hz, the output will be 50 Hz, when the source is 60 Hz, the output will be 60 Hz, but transition effects can occur. When set to e.g. 50 Hz, all sources will be displayed with an output frame rate of 50 Hz. 60 Hz sources will miss some frames.

#### How to change ?

1. Press **MENU** to activate the Tool bar.
2. Press **→** to select the *Signal* item. (image 10-3)
3. Press **↓** to pull down the *Signal* menu.

## 10. Signal menu

---

4. Use ↑ or ↓ to select *Output frame rate*.
5. Press → to pull down the menu.
6. Use ↑ or ↓ to select the desired frame rate.  
The following choices are possible:
  - synchronous : the output follows the input frame rate.
  - 50 Hz : output is always displayed with a frame rate of 50 Hz
  - 60 Hz : output is always displayed with a frame rate of 60 Hz
7. Press **ENTER**.

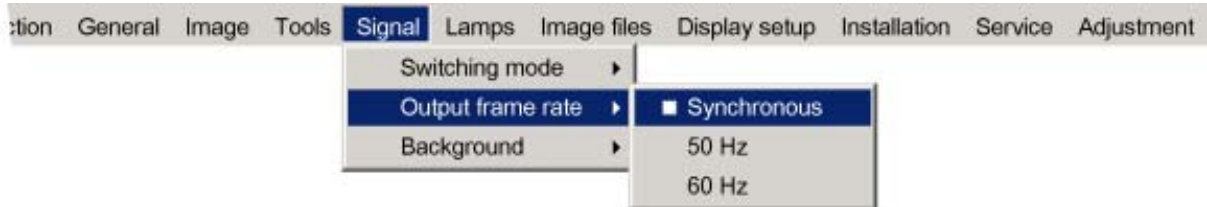

Image 10-3

## 10.4 Background

---

### Purpose

If there is no signal connected to the projector, the background will be a black or a blue screen depending on the *background* settings.

### How to change the background ?

1. Press **MENU** to activate the Tool bar.
2. Press → to select the *Signal* item. (image 10-4)
3. Press ↓ to pull down the *Signal* menu.
4. Use ↑ or ↓ to select *Background*.
5. Press → to pull down the menu.
6. Use ↑ or ↓ to select the desired background.
7. Press **ENTER**.

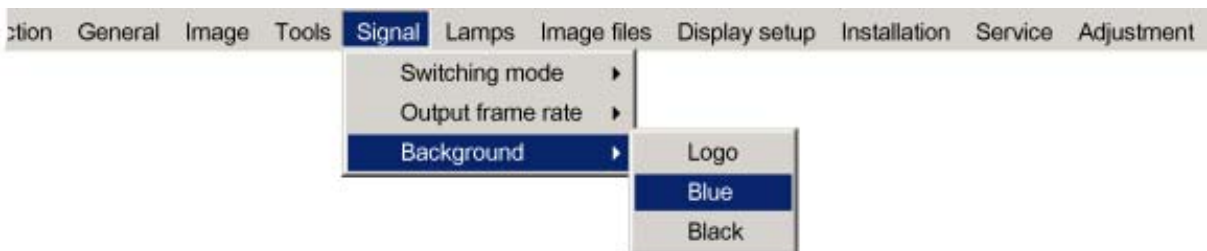

Image 10-4



**When there is no signal connected, the projector will also start its standby timer countdown (if enabled) and shuts down after the predetermined time.**

---

# 11. LAMPS MENU

## Overview

- Overview of the Lamps menu
- Runtimes
- Mode
- Economic ON/OFF
- Runtime warning

## 11.1 Overview of the Lamps menu

### Overview

- Runtimes...
- Mode
  - Single...
  - Dual...
- Economic
- Runtime warning

## 11.2 Runtimes

### How to display the lamp runtimes ?

1. Press **MENU** to activate the menu bar.
2. Press → to select the *Lamp* item. (image 11-1)
3. Press ↓ to pull down the *Lamps* menu.
4. Use ↑ or ↓ to select *Runtimes*.
5. Press **ENTER**.

A text box is displayed. (image 11-2)

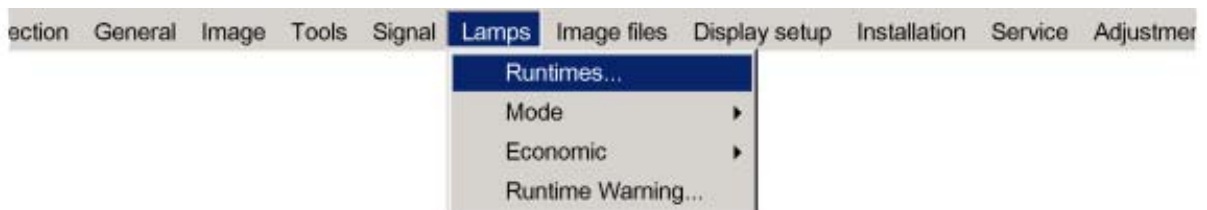

Image 11-1

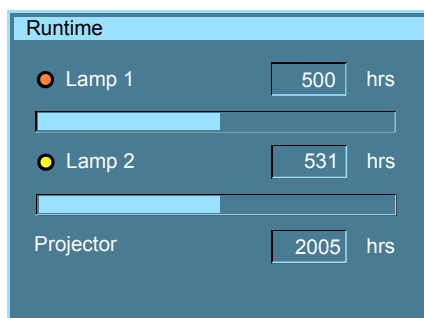

Image 11-2  
Runtime text box: yellow indicator means the lamp is working

### 11.3 Mode

#### Single lamp mode

The projector will always switch to the lamp with the shortest runtime when the difference between the runtimes of lamp 1 and lamp 2 reaches **100 hours**, switching from one lamp to another happens only at switching on of the projector and not during operation.

When the lamp fails or reaches its maximum runtime the projector switches automatically to the other lamp without interrupting the projection. The failure is logged and the lamp will never be initialized in the future.

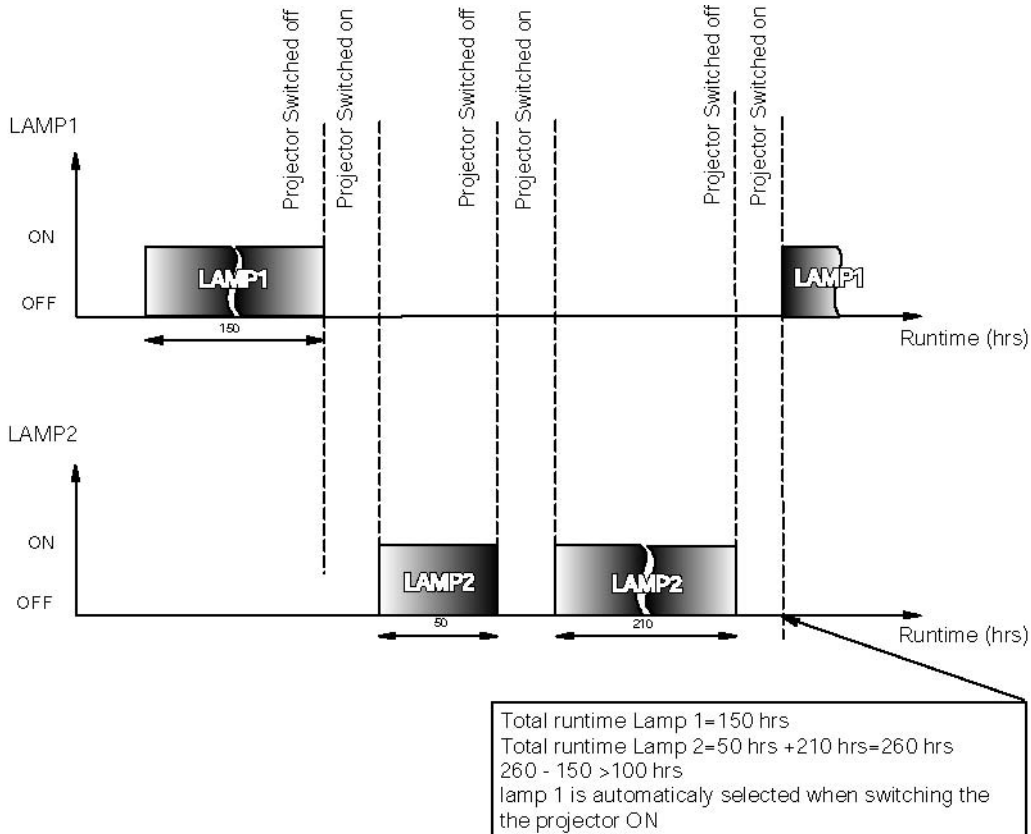

Image 11-3  
Single mode operation: switching principle

#### Dual lamp mode

Both lamps are working.

When one lamp fails, the projector continues the projection using the remaining lamp.

#### How to select the lamp mode ?

1. Press **MENU** to activate the menu bar.
2. Press **→** to select the *Lamps* item. (image 11-4)
3. Press **↓** to pull down the *Lamps* menu.
4. Use **↑** or **↓** to select *Mode*.
5. Press **→** to pull down the menu.
6. Use **↑** or **↓** to select the desired mode.

- Single      Only one lamp is ignited.
- Dual        Both lamps are ignited.

7. Press **ENTER** to confirm.

A bullet shows the active mode.



Image 11-4



When switching from the dual mode to the single mode the lamp with the longest runtime is switched off. If the runtimes are equal (if the projector has always been operated in dual mode) then lamp 1 is switched out.



When switching to single mode, returning to the dual mode will not be possible in the first 60 seconds, *Dual* in the menu is greyed out and LED3 is flickering, thereby preventing hot restrike which may damage the lamp.

## 11.4 Economic ON/OFF

### What can be done?

The lamp power can be reduced to save the lamp.

### How to switch to an economic mode ?

1. Press **MENU** to activate the menu bar.
2. Press → to select the *Lamps* item. (image 11-5)
3. Press ↓ to pull down the *Lamps* menu.
4. Use ↑ or ↓ to select *Economic*.
5. Press → to select the *On or Off* item.

On      Economic mode is switched on

Off      Economic mode is switched off

6. Press **ENTER** to confirm.

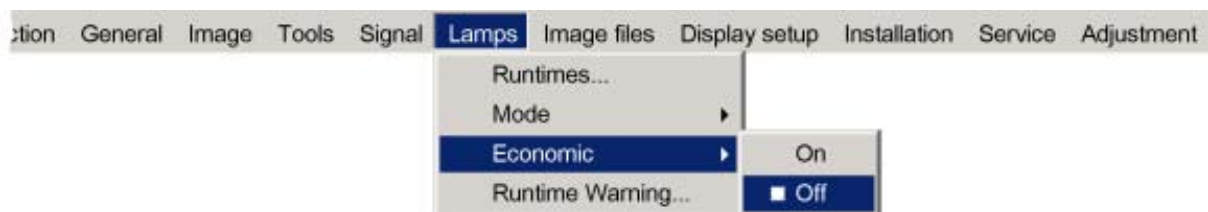

Image 11-5

## 11.5 Runtime warning

### What can be done ?

When the lamp has reached a certain predetermined runtime, a warning message will be displayed on the screen. The lamp runtime warning can be set in a range from 30 to 200 hours. The runtime warning is displayed by default at 30 hours before end of lamp lifetime.

### How to set the lamp runtime warning?

1. Press **MENU** to activate the menu bar.
2. Press → to select the *Lamp* item. (image 11-6)
3. Press ↓ to pull down the *Lamps* menu.

## 11. Lamps Menu

---

4. Use ↑ or ↓ to select *Runtime warning*.
5. Press **ENTER** to confirm.  
A dialog box is displayed. (image 11-7)
6. Press **ENTER** to activate the input field.
7. Use ← or → to change the runtime warning setting.  
Or,  
enter the desired value with the digit keys on the remote control.
8. Press **Back** to return.



Image 11-6

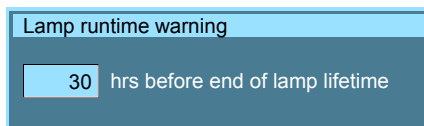

Image 11-7



**WARNING: Lamp replacement should be done by a Barco authorized technician.**

---



## 12. IMAGE FILES MENU

### Overview

- Overview of the Image Files Menu
- Introduction to image files
- Load file
- File selection
- Auto Image
- Edit file
- Rename file
- Copy
- Delete
- Automatic load
- Zoom-Focus

### 12.1 Overview of the Image Files Menu

#### Overview

- Load
- File selection
  - Fit
  - All
- Auto Image
- Edit...
- Rename...
- Copy...
- Delete...
- Zoom/Focus
  - Universal
  - Unique

### 12.2 Introduction to image files

#### Introduction

An image file contains the main characteristics of a source (number of active lines,...). The projector's memory contains a list of files corresponding to the most common sources, these are the standard files (file extension= \*.s). When a new source corresponds to one of these files, a custom file (file extension=\*.C) is created and saved for future use.

The maximum number of custom files that can be created is 99, the four last files are systematically overwritten.

When there is a little difference, the file can also be loaded and then edited until the source specs are reached.



**The Autolmage function creates automatically the best suited image file (custom file) for a new source. Autolmage is used when:**

- a new source is detected : Autolmage creates a new custom file which can always be edited if necessary.
- the Autolmage button on the RCU is pressed

**Autolmage works only in full screen mode**



**If the Autolmage function does not succeed in finding a file and no file is loaded (load list is empty), which means that the source is not displayed, then use the copy function,**

### Possible file manipulations

The possible file manipulations are :

- Load : installation of a file for a new source
- Edit : editing a loaded file to match the source specifications
- Rename : renaming a file
- Copy : copying a file to a new file
- Delete : deleting an existing file

## 12.3 Load file

### How to load a file ?

1. Press **MENU** to activate the menu bar.
2. Press → to select the *Image files* item. (image 12-1)
3. Press ↓ to pull down the *Image files* menu.
4. Use ↑ or ↓ to select *Load*.
5. Press **ENTER**.  
A dialog box is displayed. (image 12-2)
6. Use ↑ or ↓ to select the desired file.  
**Tip:** For more info about the available image files and the specifications, see Chapter Standard Image Files.
7. Press **ENTER** to confirm.

The file will be loaded and the image is adapted accordingly.

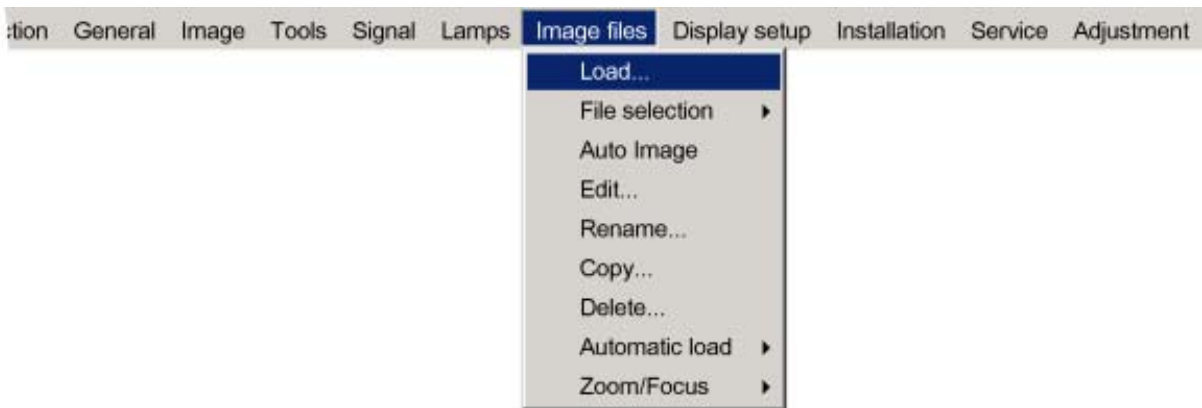

Image 12-1

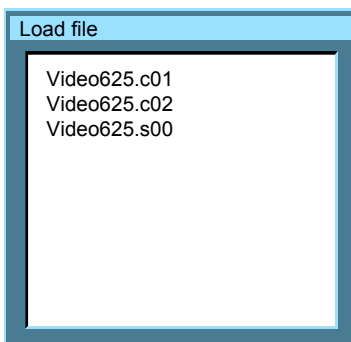

Image 12-2  
load file dialogbox in case of a video source



In PiP mode, the files which may be loaded will be of the data type if the active window is a data window, or they will be of the video type if the active window is a video window.

### What to do if the image is not perfect ?

If the displayed image is not correct after AutoImage or after selecting the best fitting file, go to the Edit menu, select the active file and change the settings.

## 12.4 File selection

### How to set the filter ?

1. Press **MENU** to activate the menu bar.
2. Press → to select the *Image files* item. (image 12-3)
3. Press ↓ to pull down the *Image files* menu.
4. Use ↑ or ↓ to select *File selection*.
5. Press → to pull down the selection.
6. Use ↑ or ↓ to select the desired filter.

All    all files that can be loaded will be displayed.

Fit    only the best fitting files will be displayed.

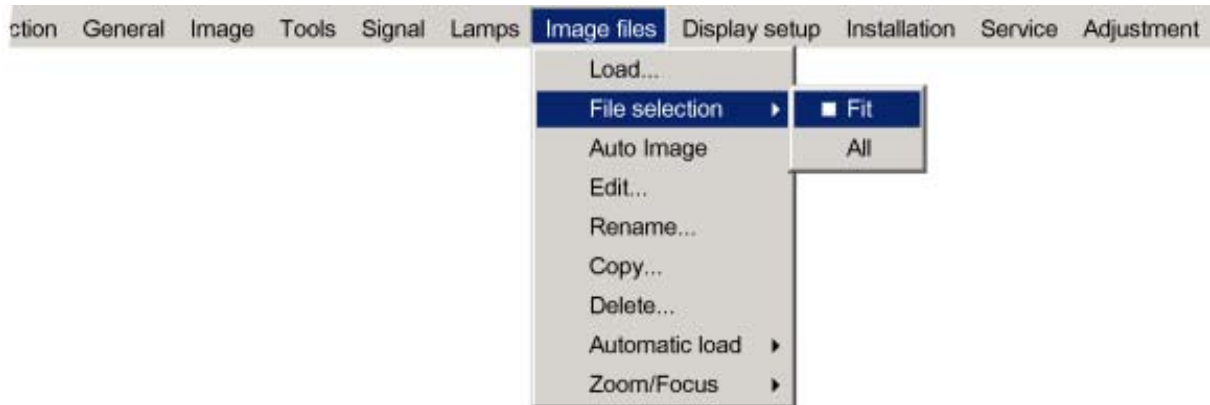

Image 12-3

## 12.5 Auto Image

### What can be done ?

Auto Image creates the best suited image file for the connected source.



**Auto Image works only for data images.**

### How to launch Auto Image?

1. Press **MENU** to activate the Toolbar (image 12-4)
2. Press → to select the *Image files* item
3. Press ↓ to pull down the *Image files* menu
4. Use ↑ or ↓ to select *Auto Image*
5. Press **ENTER**  
A textbox showing a progress bar is displayed.  
*Tip: Press the **Cancel** button to cancel the operation.*

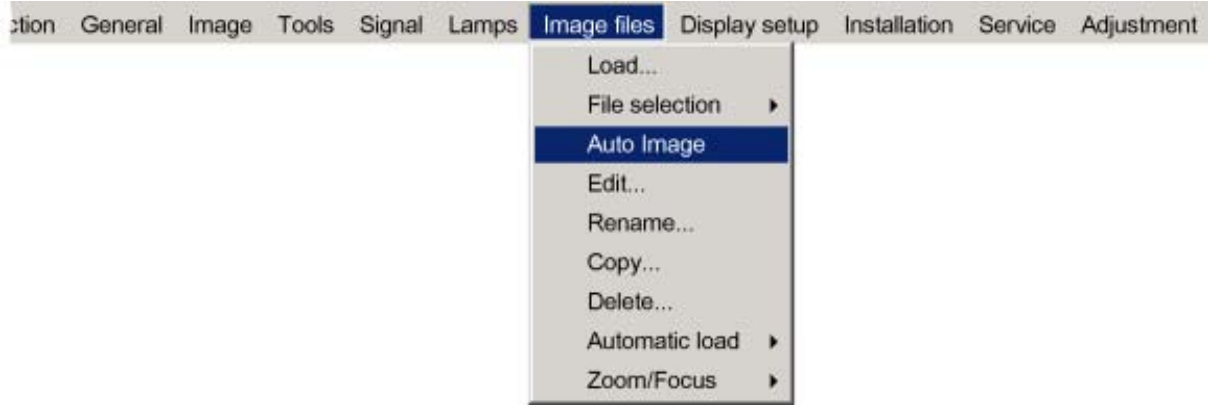

Image 12-4



The Auto Image setup in the *Display setup* menu affect only Auto Image if it is launched via the RCU key or at automatic file creation.

Launching Autolmage via the menu involves complete checking of all parameters.



Auto Image can also be launched via the RCU with the dedicated Autolmage key.

## 12.6 Edit file

### Overview

- Editing a file
- Correct file parameters
- Advanced video settings
- Advanced Data settings

### 12.6.1 Editing a file

#### What can be done with the Edit file menu ?

The Edit file menu makes it possible to adapt the settings of the file according to the real settings of the connected source. Consult the source specifications before entering the data.

#### How to edit a file ?

1. Press **MENU** to activate the menu bar.
2. Press → to select the *Image files* item. (image 12-5)
3. Press ↓ to pull down the *Image files* menu.
4. Use ↑ or ↓ to select *Edit*.
5. Press **ENTER**.  
A dialog box is displayed. (image 12-6)
6. Use ↑ or ↓ to select the desired file.  
**Note:** *If in PIP mode the cursor is placed by default on the active file which has the focus.*
7. Press **ENTER** to confirm.  
A dialog box is displayed with the selected source settings. (image 12-7)
8. Use ← or → to edit and change the values.  
**Note:** *greyed out fields can not be updated (total pixels).*
9. Press **ENTER** to confirm.

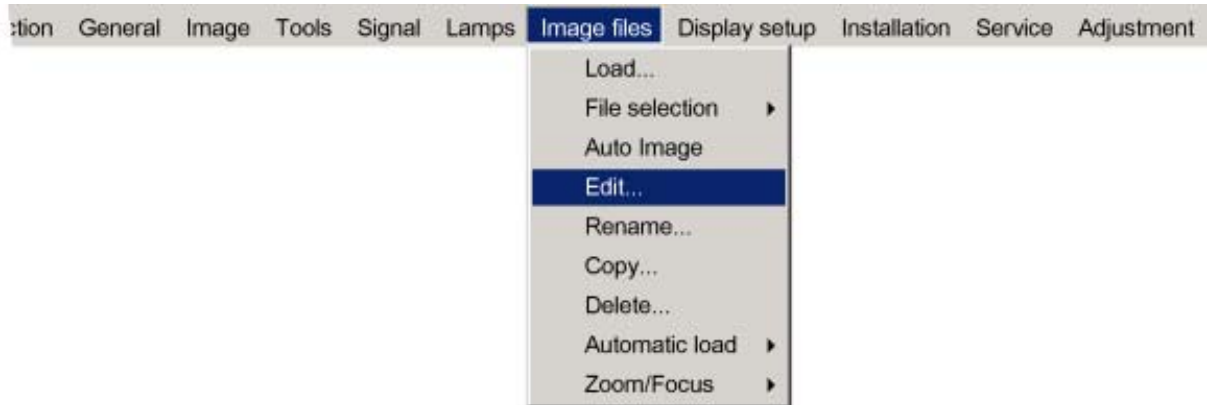

Image 12-5

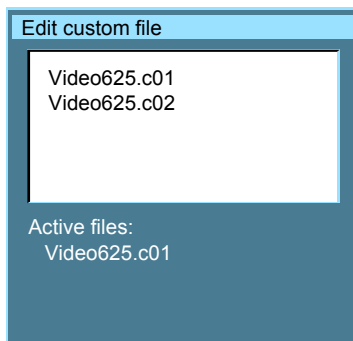

Image 12-6

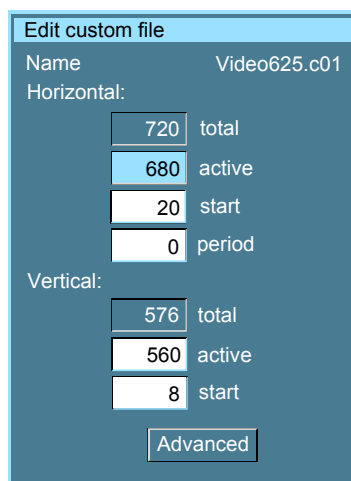

Image 12-7



It is recommended to use the default values.

## 12.6.2 Correct file parameters

### What is already available during start up ?

During the installation of a file with LOAD, the horizontal period, the total number of vertical lines and the interlaced mode are automatically measured and filled in. These values will be available when starting up the EDIT procedure of an active file.

### Adjustable items

- Active horizontal pixels : determine the width of the window on the screen. This value is normally given in the source specifications. If not, adjust until full image is displayed (no missing pixels).
- Horizontal start in pixels : number of pixels between the beginning of the input signal and the start of the video information in the signal.
- Horizontal period in ns : when active file, the correct value will be filled out.
- Active vertical lines : number of horizontal lines determining the height of the projected image. this value is normally given in the specification of the source. If not, adjust until full image height is displayed (no missing lines).
- Vertical start in lines : number of lines between the start of the input signal and start of the image on the screen.

## 12.6.3 Advanced video settings

### Overview

When a video source is selected, the **advanced** button enables the advanced settings for that video source.

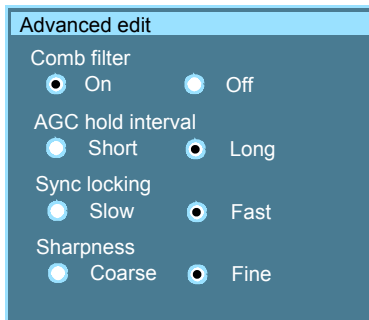

Image 12-8

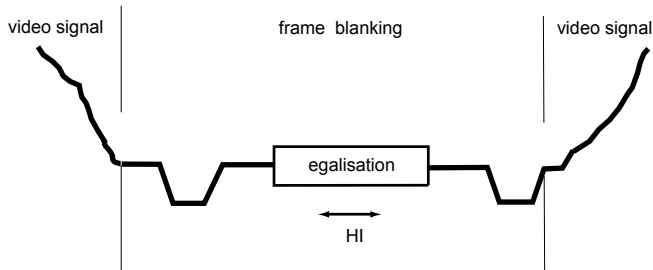

Image 12-9  
HI AGC Hold interval

The **Comb filter** is by default enabled.

The **AGC hold interval** is the time interval in which the AGC is inhibited (AGC hold = no update in video amplitude measurement), the advanced parameter allows to choose a short or long hold interval.

A long AGC hold interval eliminates Macrovision® disturbances since the AGC is hold during a long interval, thus reducing the probability to encounter a Macrovision® pulse.

The **sync locking setting** is recommended for poor video signals (ex: poor TV signals).

**Sharpness** adjustment can be chosen to be coarse or fine.



It is recommended to use the default values.

### 12.6.4 Advanced Data settings

#### Overview

When a data source is selected, the **advanced** button enables the advanced settings for a data source.

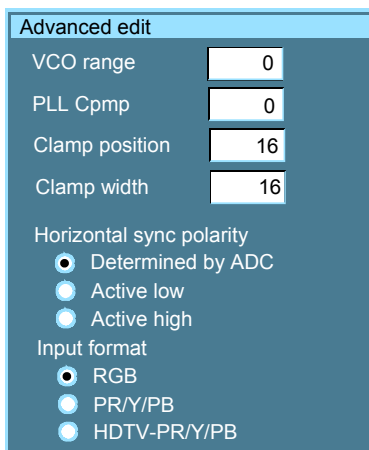

Image 12-10

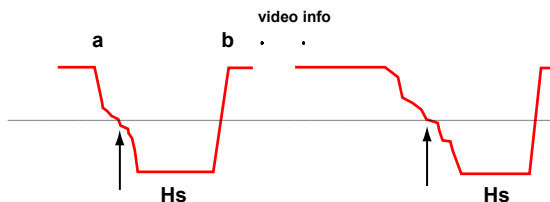

Image 12-11  
Hs horizontal sync pulse  
a active low  
b active high

The **VCO range** setting determines the frequency range of the VCO (Voltage Controlled Oscillator).

The **Cmpm** (Charge pump current) sets the low pass filter current.

Both VCO range & Cmpm are set by the image file, changing these settings is only indicated in for special purposes.

The **horizontal sync polarity** setting can be useful in case of a bad shaped edge, one can choose between the leading (active low) or trailing (active high) edge.

The input format settings are used to "tell more" about the signals connected on the BNC's, it completes the information in the source selection menu.

- RGB is selected by default and means that an RGB signal is connected to the BNC's
- PR/Y/PB must be selected whenever:

- a progressive signal (32 kHz frequency video signal ) is connected to the BNC's (select the source with *Data on BNC's* in the Source selection menu).
- one wants (in PIP mode) to visualize the component video signal in a Data window hereby adding a video image in the PiP layout.

-HDTV-PR/Y/PB for high definition component video signals.



It is recommended to use the default values.

## 12.7 Rename file

### How to rename a file ?

1. Press **MENU** to activate the menu bar.
2. Press **→** to select the *Image files* item. (image 12-12)
3. Press **↓** to pull down the *Image files* menu.
4. Use **↑** or **↓** to select *Rename*.
5. Press **ENTER**  
A dialog box is displayed. (image 12-13)
6. Use **↑** or **↓** to select the desired file.
7. Press **ENTER**  
A text box is displayed. (image 12-14)
8. Press **ENTER** to activate the input field.  
Use **←** or **→** to select the characters. Use the **↓** or **↑** to change the value.
9. Press **ENTER** to confirm the changes.

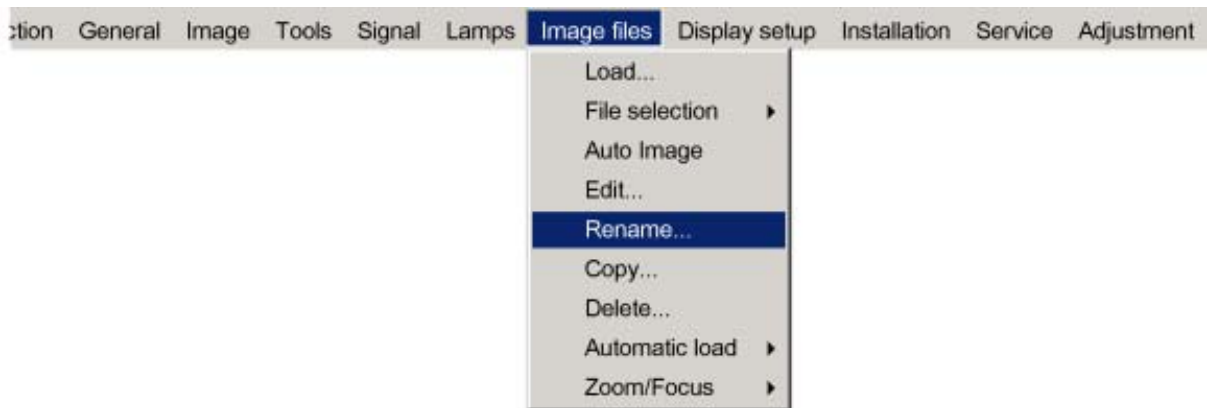

Image 12-12

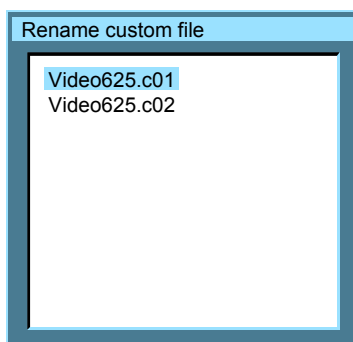

Image 12-13

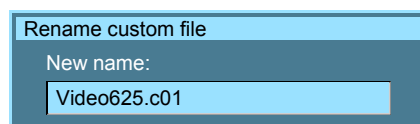

Image 12-14

## 12.8 Copy

### How to copy a file ?

1. Press **MENU** to activate the menu bar.
2. Press **→** to select the *Image files* item. (image 12-15)
3. Press **↓** to pull down the *Image files* menu.
4. Use **↑** or **↓** to select *copy*.
5. Press **ENTER** to confirm.  
A dialog box is displayed. (image 12-16)
6. Use **↑** or **↓** to select the desired file.
7. Press **ENTER** to confirm.  
A text box is displayed. (image 12-17)
8. Press **ENTER** to activate the input field.  
Use **←** or **→** to select the characters. Use the **↓** or **↑** to change the value.
9. Press **ENTER** to confirm.

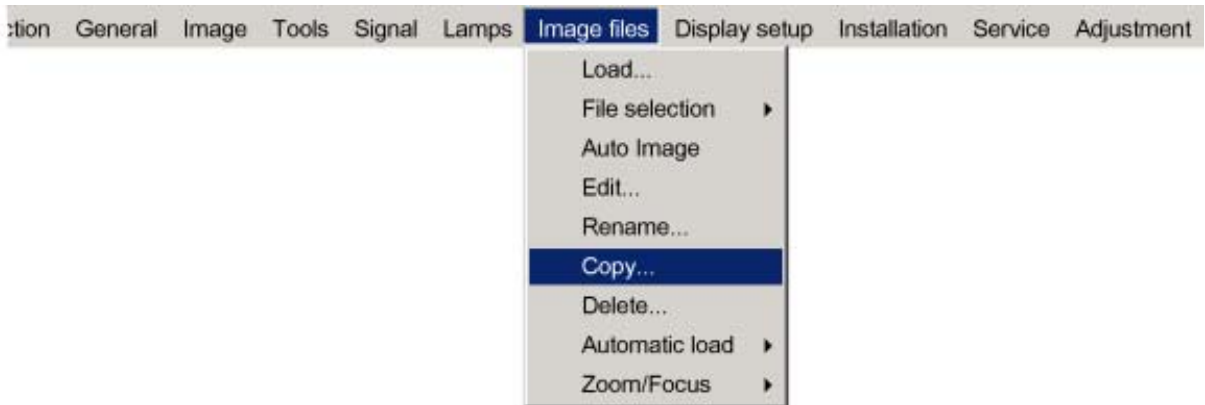

Image 12-15

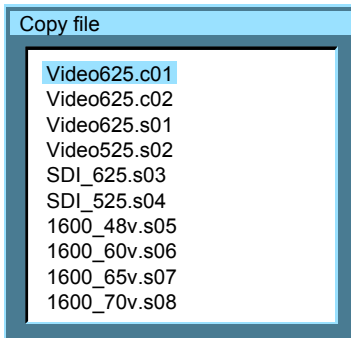

Image 12-16

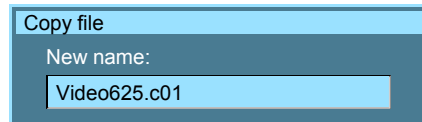

Image 12-17



If the AutoImage function does not succeed in finding a file and no file is loaded (load list is empty), which means that the source is not displayed, then use the *copy* function: Copy a standard file (.sxx) which is not too different of the source to display, then edit this file to get the best image.

## 12.9 Delete



The active file cannot be deleted.



**How to delete a file ?**

1. Press **MENU** to activate the menu bar.
2. Press → to select the *Image files* item. (image 12-18)
3. Press ↓ to pull down the *Image files* menu.
4. Use ↑ or ↓ to select *delete*.
5. Press **ENTER** to confirm.  
A dialog box is displayed. (image 12-19)
6. Use ↑ or ↓ to select the desired file.
7. Press **ENTER** to confirm.

The selected file is deleted and is removed from the list.



Image 12-18

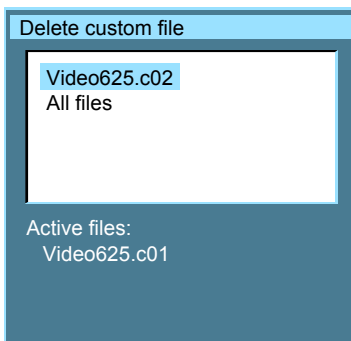

Image 12-19

**12.10 Automatic load****What can be done ?**

When automatic load is 'off', the projector will not load another file when the source is interrupted or when the image is suddenly changed to another file format. The new image will be displayed with the same settings as the previous source.

When automatic load is 'on', the projector will follow the new source settings.

**How to set up ?**

1. Press **MENU** to activate the menu bar.
2. Press → to select the *Image files* item. (image 12-20)
3. Press ↓ to pull down the *Image files* menu.
4. Use ↑ or ↓ to select *Automatic load*.
5. Press → to display the choices.
6. Use ↑ or ↓ to select desired choice.

## 12. Image Files Menu

- On            The projector will switch the file when the source settings change.
- Off            The projector stays on its active file even when the settings of the source change.

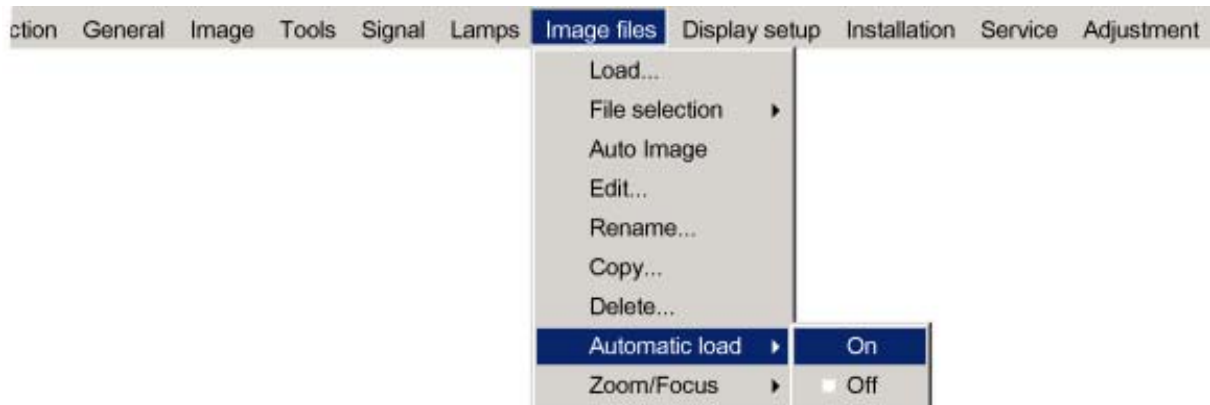

Image 12-20

### 12.11 Zoom-Focus



The Zoom-Focus setting is only valid when the projector is equipped with TLD lenses.

#### What can be done ?

When TLD lenses are used, it is possible to store the zoom and focus setting for each file separately.

#### How to set ?

1. Press **MENU** to activate the menu bar.
2. Press → to select the *Image files* item. (image 12-21)
3. Press ↓ to pull down the *Image files* menu.
4. Use ↑ or ↓ to select *Zoom/Focus*.
5. Press → to display the choices.
6. Use ↑ or ↓ to select desired choice.

Universal    The same zoom/focus setting will be used for all files.

Unique        The zoom/focus settings will be stored file per file.

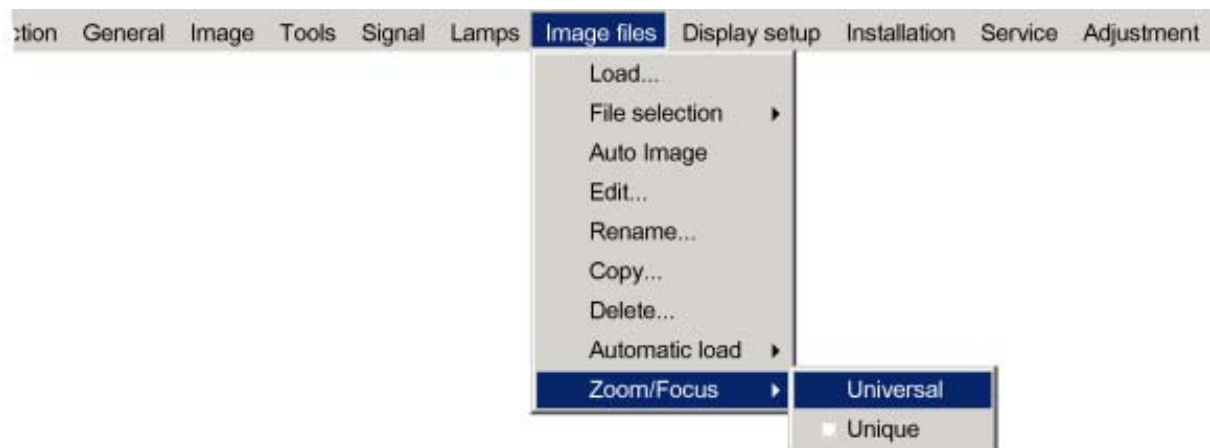

Image 12-21

# 13. DISPLAY SETUP

## Overview

- Startup screen
- TextBox
- Take screenshot
- Menu bar position
- Status bar position
- Sliderbox position
- Auto Image Setup
- Scenergix

## 13.1 Startup screen

### What can be done ?

When the startup screen is enabled, the identification screen is displayed for a few seconds at startup.

This startup screen can be disabled.

### How to enable/disable the Startup screen?

1. Press **MENU** to activate the menu bar.
2. Press → to select the *Display setup* item. (image 13-1)
3. Press ↓ to pull down the *Display setup* menu.
4. Use ↑ or ↓ to select *Startup screen*.
5. Press → to pull down the menu.
6. Use ↓ or ↑ to select *On* or *Off*.

On Start up screen will be displayed.

Off No start up screen will be displayed during start up.

7. Press **ENTER** to confirm.



Image 13-1

## 13.2 TextBox

### What can be done ?

All menus, dialog boxes and text boxes can be disabled by putting the text box function in the off position.

### How to enable/disable the Textbox ?

1. Press **MENU** to activate the menu bar.
2. Press → to select the *Display setup* item. (image 13-2)

## 13. Display Setup

3. Press ↓ to pull down the *Display setup* menu.
4. Use ↑ or ↓ to select *Textbox*.
5. Press → to pull down the menu.
6. Use ↓ or ↑ to enable/disable the textbox.
7. Press **ENTER**.

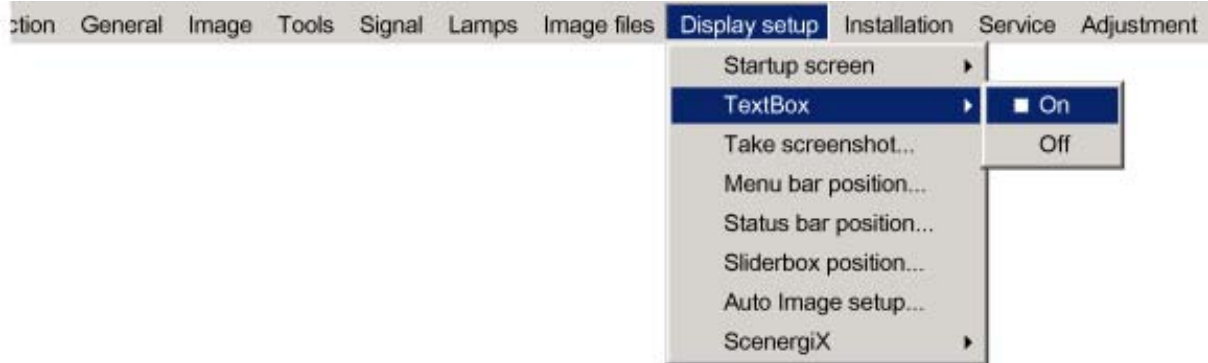

Image 13-2



To enable the menus and dialog boxes again, press the **TEXT** button on the RCU.

## 13.3 Take screenshot

### What can be done ?

A screen-shot can be taken from the active projected image. This screen-shot is then saved in a 4 MB RAM and can be used as background (logo).

Each new screenshot erases the previous one, therefore a warning message is displayed asking the user to confirm.

### How to take a screenshot ?

1. Press **MENU** to activate the menu bar.
2. Press → to select the *Display setup* item. (image 13-3)
3. Press ↓ to pull down the *Display setup* menu.
4. Use ↑ or ↓ to select *Take screenshot*.
5. Press **ENTER**.  
A dialog box is displayed. (image 13-4)
6. Press **yes** to confirm.  
A text box shows the evolution of the operation. (image 13-5, image 13-6)

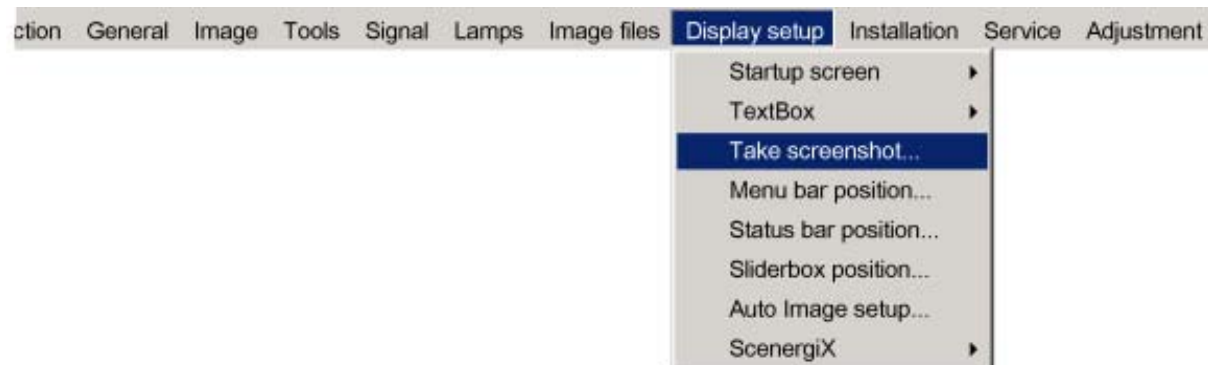

Image 13-3

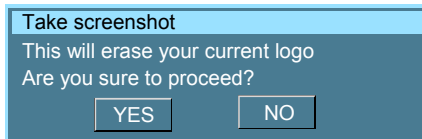

Image 13-4  
Override message

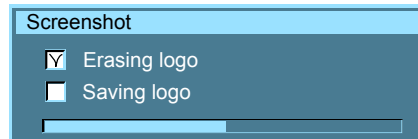

Image 13-5

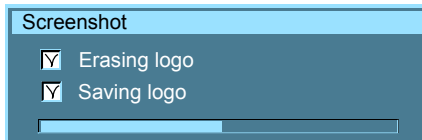

Image 13-6

## 13.4 Menu bar position

### What can be done ?

The menu bar can be centered vertically. The range is from the top of the screen to the middle of the screen.

This is useful in applications where the top image content is not displayed (e.g. due to blanking).

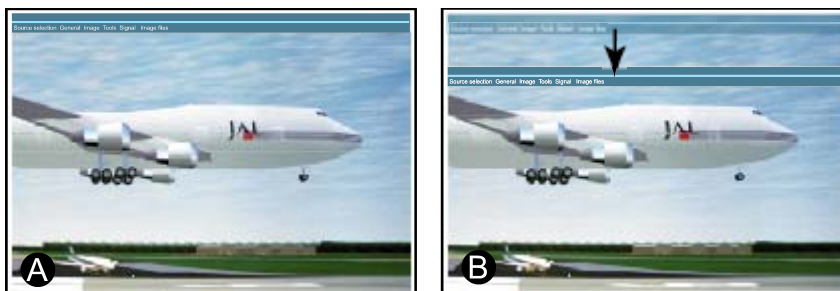

Image 13-7  
Menu bar move

- A Normal position
- B New position

### How to center the menu ?

1. Press **MENU** to activate the menu bar.
2. Press **→** to select the *Display setup* item. (image 13-8)
3. Press **↓** to pull down the *Display setup* menu.
4. Use **↑** or **↓** to select *Menu bar position menu*.
5. Press **ENTER**.
6. Use **↑** or **↓** to position the menu bar.



Image 13-8

## 13.5 Status bar position

### What can be done ?

The status bar (wizard menu) can be centered vertically. The range is from the bottom of the screen to the middle of the screen.

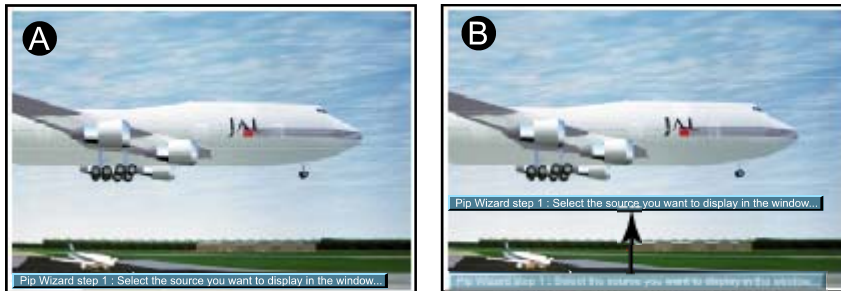

Image 13-9  
Status bar position

This is useful in applications where the bottom image content is not displayed (e.g. due to blanking).

### How to center the menu ?

1. Press **MENU** to activate the menu bar.
2. Press → to select the *Display setup* item. (image 13-10)
3. Press ↓ to pull down the *Display setup* menu.
4. Use ↑ or ↓ to select *Status bar position*.
5. Press **ENTER**.
6. Use ↑ or ↓ to position the status bar



Image 13-10

## 13.6 Sliderbox position

### What can be done ?

The sliderbox can be displayed anywhere on the screen. The exact location can be set in sliderbox menu due to the coarse and fine adjustment.

### How to reposition the sliderbox?

1. Press **MENU** to activate the menu bar.
2. Press → to select the *Display setup* item. (image 13-11)
3. Press ↓ to pull down the *Display setup* menu.
4. Use ↑ or ↓ to select *Sliderbox position*.
5. Press **ENTER** to confirm.

A sliderbox is displayed. Use the 4 arrow keys to move the box to the desired position.

The X and Y coordinate will change simultaneously while moving the box. (image 13-12)

6. Quit with **BACK**.

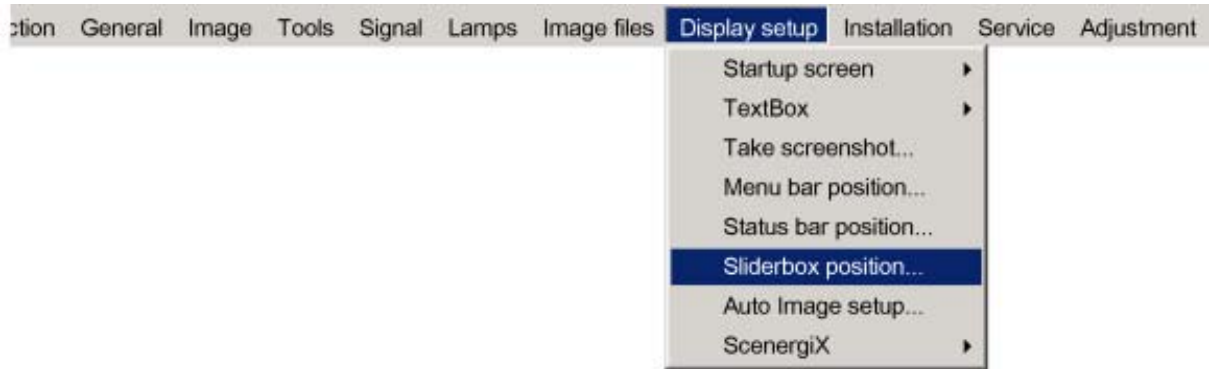

Image 13-11

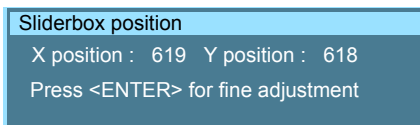

Image 13-12



There is a coarse and a fine adjustment of the position, use ENTER (when sliderbox is displayed) to switch between the two.

## 13.7 Auto Image Setup

### What can be done ?

Auto image allows to detect automatically the characteristics of the source and uses this information to adapt the image to the DLP panels.

Auto image can adapt the image based on following data :

- Start pixel and start line
- Contrast/brightness levels



Auto image works only for data signals.

### How to set up Auto Image?

1. Press **MENU** to activate the menu bar.
2. Press → to select the *Display setup* item. (image 13-13)
3. Press ↓ to pull down the *Display setup* menu.
4. Use ↑ or ↓ to select *Auto Image setup*.
5. Press **ENTER** to confirm.  
A dialog box is displayed. (image 13-14)
6. Use the arrow keys to select the desired item and press **ENTER** to enable or disable that item.

During file load

When checked and when a new file is loaded for the first time due to a switch from one source to another source, the selected auto image setup will be executed.

When the new loaded file was already once used, then the auto image detection will not be done.

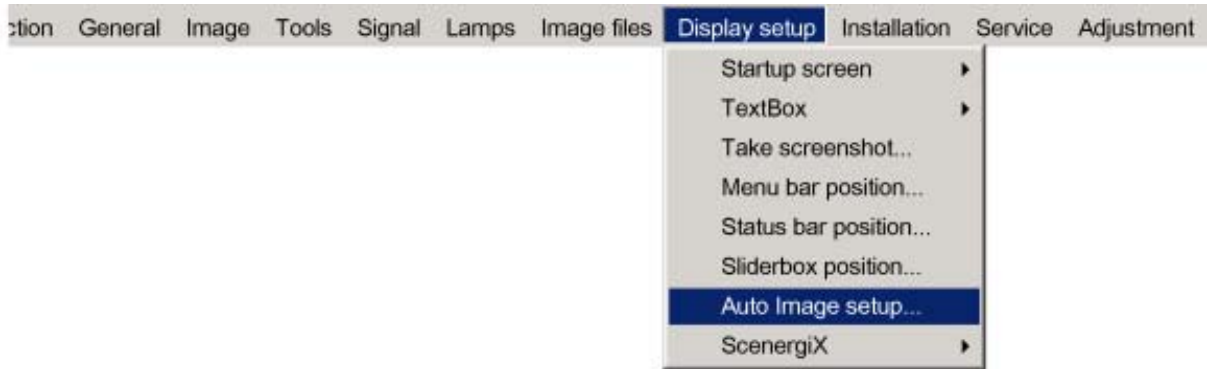

Image 13-13



Image 13-14

### How to perform Auto Image ?

1. press **Auto Image** on the RCU

A text box showing a progress bar is displayed. (image 13-15)



Image 13-15



**During the AUTO IMAGE measuring process the data source disappears temporarily.**

## 13.8 ScenergiX

### Overview

- Introduction
- Preparations
- ScenergiX overlap zone (horizontal scenergiX)
- ScenergiX overlap zone (vertical scenergiX)
- ScenergiX border adjustment
- Black level of the images



### 13.8.1 Introduction

#### Why ScenergiX ?

When working in a multichannel setup the RLM G5i Performer and its Soft Edge possibilities enable an image blending that gives the appearance of a single view, thus achieving realistic immersion for the majority of wide screen applications.

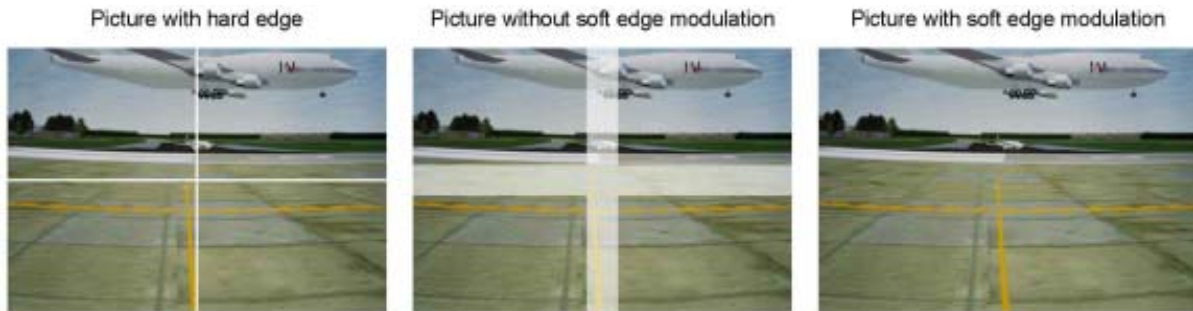

Image 13-16  
Why Soft Edge?

#### What is the Basic Principal of ScenergiX ?

The principle of edge blending is archived by linear modulation of the light output in the overlap zone so that the light output in that zone equals the light output of the rest of the image.

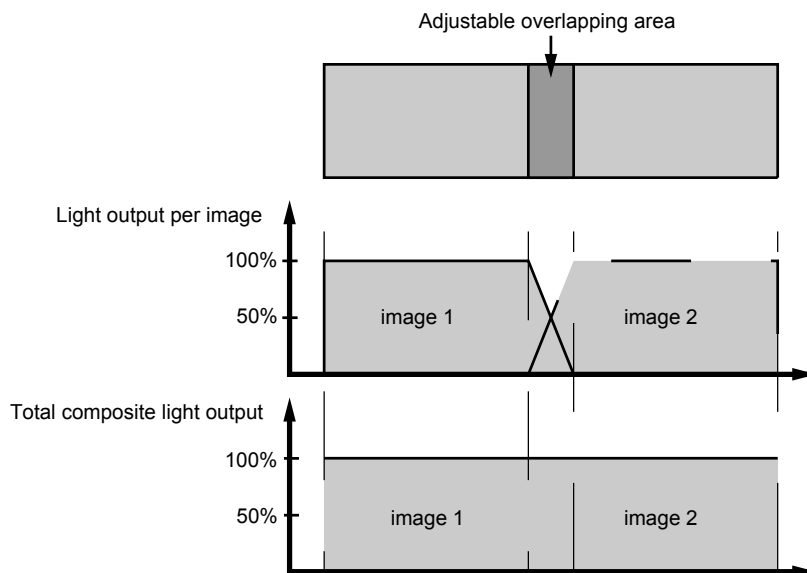

Image 13-17  
ScenergiX Basic Principle

### 13.8.2 Preparations

#### ScenergiX Preparations

To ensure proper ScenergiX adjustment, be sure that the following adjustments are done perfectly on all projectors:

- Convergence (Electronic Convergence).
- Geometry
- Color Matching (Color Temperature, Input Balance, Gamma)

### 13.8.3 ScenergiX overlap zone (horizontal scenergiX)

#### Definitions

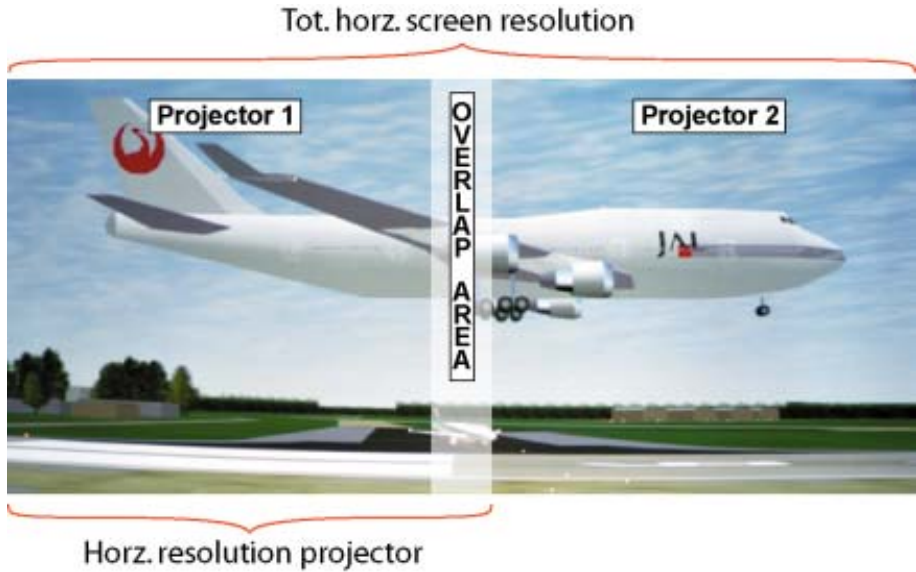

Image 13-18  
ScenergiX set up

Overlap : number of pixels that overlap

Horizontal resolution of 1 projector : 1024 for Graphics versions, 1280 for Reality versions, 1400 for SXGA projectors.

Total horizontal screen resolution : [(horizontal resolution of 1 projector) x 2] minus overlap.

Horizontal Resolution source : number of active pixels of the source.

#### Adjustment of Active pixels (Pact) of the first projector

1. Go to File → Edit menu of first projector.
2. Enter value for horizontal active (= Pact) as follows :  
$$\text{Pact} = [(\text{Horz. resolution of 1 projector}) / (\text{Total horz. screen resolution})] \times (\text{horz. resolution source})$$
3. Horizontal start (= Pstart) remains the same.

#### Adjustment of Active pixels (Pact) of second projector

1. Go to File → Edit menu of second projector.
2. Enter value for horizontal active (= Pact) as follows :  
$$\text{Pact} = [(\text{Horz. resolution of 1 projector}) / (\text{Total horz. screen resolution})] \times (\text{horz. resolution source})$$
3. Horizontal start (= Pstart) = original start + [(Horz. resolution source) minus (newly calculated Pact)]

#### Example

Horizontal resolution source : 1600 pixels

horizontal resolution projector 1 & 2 : 1024 pixels

Overlap : 100 pixels

Total horizontal screen size in pixels : 1948 pixels

$$\text{Pact projector 1} = [(1024 / 1948)] \times 1600 = 841 \text{ pixels}$$

$$\text{Pact projector 2} = [(1024 / 1948)] \times 1600 = 841 \text{ pixels}$$

$$\text{Pstart projector 2} = \text{Pstart projector 1} + (1600 - 841)$$

### 13.8.4 ScenergiX overlap zone (vertical scenergiX)

#### Definitions

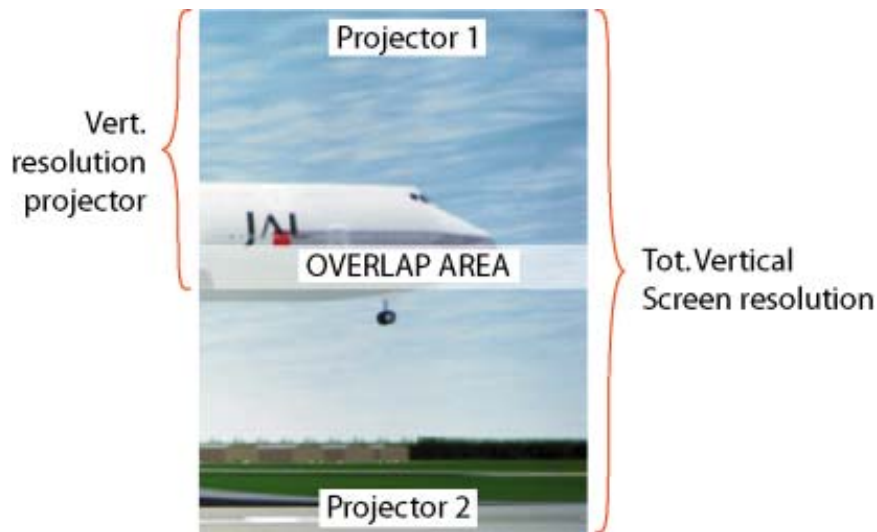

Image 13-19  
ScenergiX overlap zone vertical

Overlap : number of pixels that overlap

Vertical resolution of 1 projector : 768 for Graphics versions, 1024 for Reality versions, 1050 for SXGA projectors.

Total vertical screen resolution : [(Vertical resolution of 1 projector) x 2] minus (overlap)

Vertical Resolution source : number of active lines of the source

#### Adjustment of Active lines (Lact) of the first projector

1. Go to File → Edit menu of first projector.
2. Enter value for vertical act (= Lact) as follows :  

$$\text{Lact} = [(\text{vert.. resolution of 1 projector}) / (\text{Total Vert. screen resolution})] \times (\text{Verti. resolution source})$$
3. Vertical start (= Lstart) remains the same.

#### Adjustment of Active lines (Lact) of second projector

1. Go to File → Edit menu of second projector.
2. Enter value for vertical act (= Lact) as follows :  

$$\text{Lact} = [(\text{Vert.. resolution of 1 projector}) / (\text{Total vert. screen resolution})] \times (\text{vert. resolution source})$$
3. Vertical start (= Lstart) = original start + [(Vert. resolution source) minus (newly calculated Lact)]

#### Example

Vertical resolution source : 1200 lines

Vertical resolution projector 1 & 2: 768 lines

Overlap : 50 lines

Total vertical screen size : 1486 lines

Lact projector 1 =  $(768 / 1486) \times 1200 = 620$  lines

Lact projector 2 =  $(768 / 1486) \times 1200 = 620$  lines

Lstart projector 2 = Lstart projector 1 +  $(1200 - 620)$

### 13.8.5 ScenergiX border adjustment

#### What can be done with the ScenergiX border menu?

Within this menu the width of the blending zone is set up.

#### How to select a border?

1. Press **MENU** to activate the menu bar.
2. Press → to select the *Display setup* item. (image 13-20)

### 13. Display Setup

3. Press ↓ to pull down the *Display setup* menu.
4. Use ↑ or ↓ to select *ScenergiX*.
5. Press → to select the *ScenergiX* item.
6. Use ↑ or ↓ to select *Border*.
7. Press **ENTER** to select.

A dialog box will be displayed. The actual scenergiX border will be displayed.

8. Use ↑ or ↓ to select the desired adjustment.

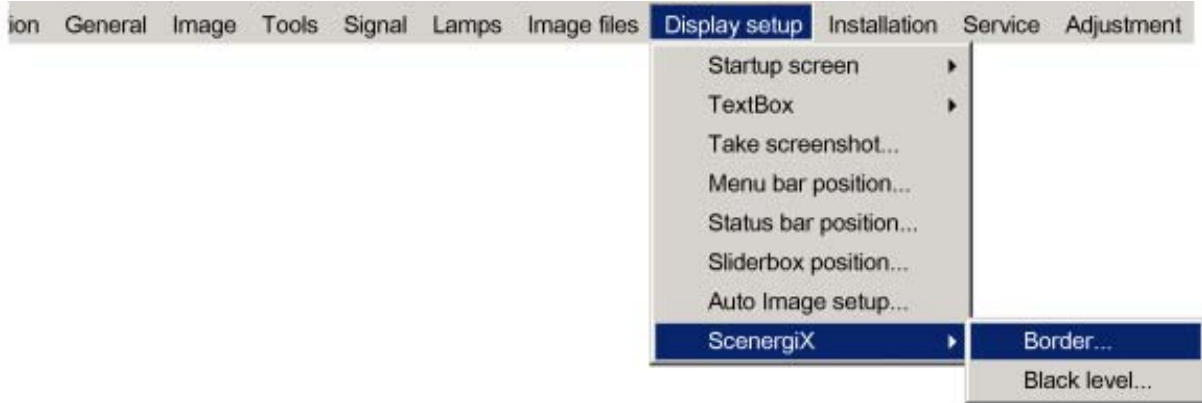

Image 13-20

#### Adjusting with the arrow keys.

1. When on an adjustment, use the → or ← key to move the border line to the desired position.

The border line will move in the desired direction and the light output in the overlap area will be adapted to. (image 13-21)

Set first the width of the first projector and repeat for the second one. (image 13-22, image 13-23)

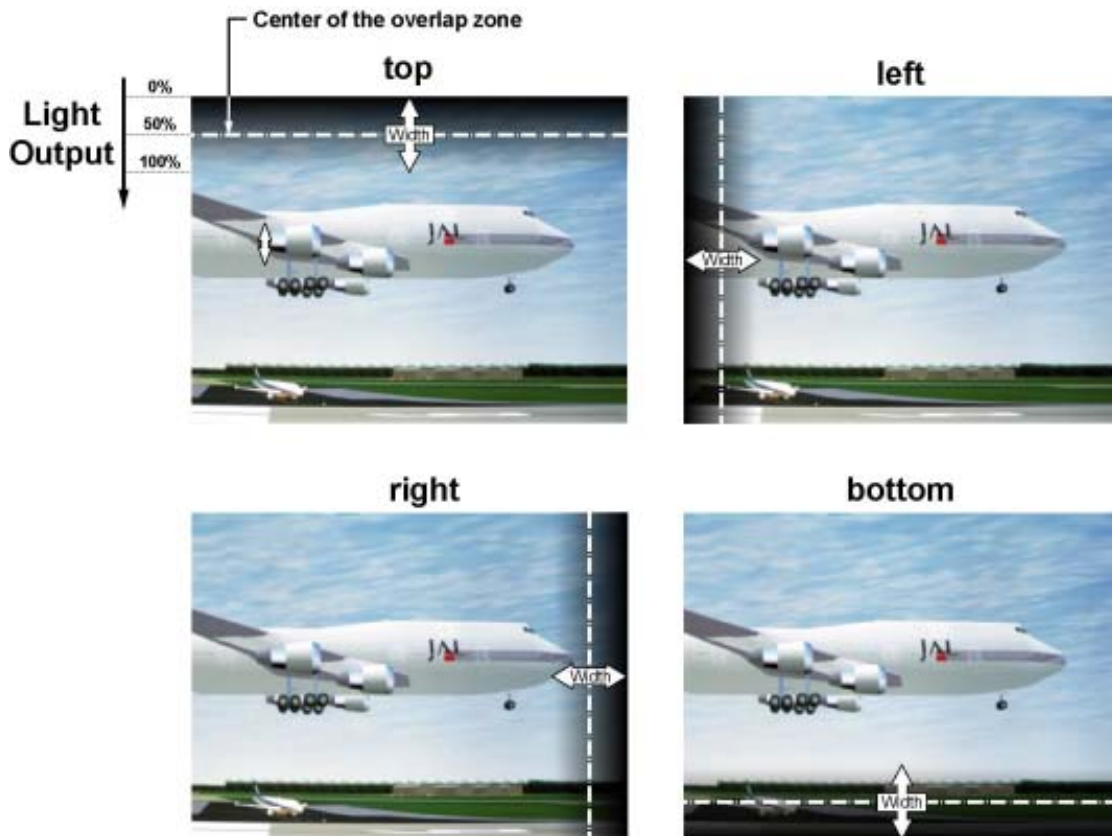

Image 13-21  
Width selections

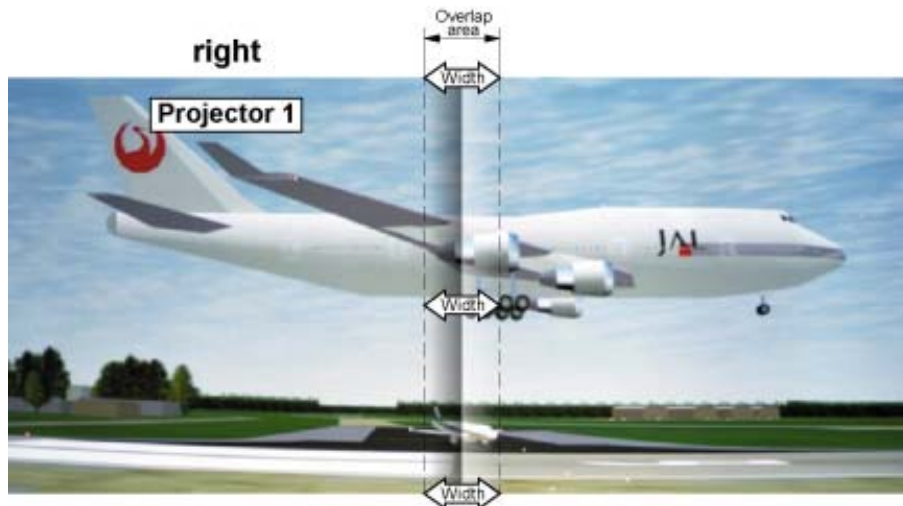

Image 13-22  
Width set up for projector 1

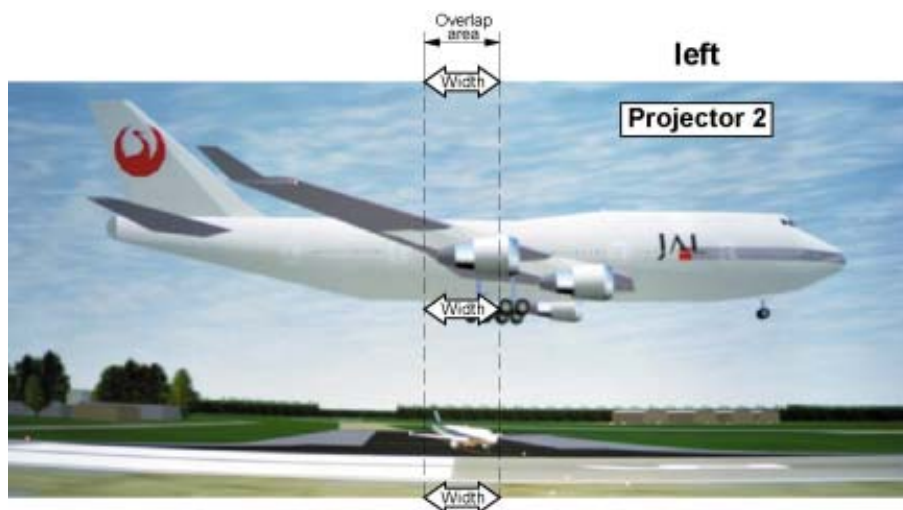

Image 13-23  
Width set up for projector 2

### Adjusting by entering the exact values.

1. When on an adjustable item, the input box background will be colored. Press **ENTER**.  
The value will change to a 3 digit value and the first digit is selected.
2. Enter a value with the digit keys on the remote control.  
The cursor jumps automatically to the next digit.
3. Press **ENTER** to activate the new value.



Use reset to return to the default settings.

### 13.8.6 Black level of the images

#### Why

For dark images, the overlap zone will be brighter than the rest of the images. Therefore we can rise the black level of the remaining image (excluding the overlap zone)

#### How to adjust

1. Press **MENU** to activate the menu bar.

### 13. Display Setup

2. Press → to select the *Display setup* item. (image 13-24)
3. Press ↓ to pull down the *Display setup* menu.
4. Use ↑ or ↓ to select *ScenergiX*.
5. Press → to select the *ScenergiX* item.
6. Use ↑ or ↓ to select *Black level*.
7. Press **ENTER** to select.

A dialog box will be displayed on a black level background.

Adjust the black level of area A until the black level of area A, B and C are equal (area C should be adjusted on the second projector). (image 13-25)

Use the up or down arrow key to select the adjustment (All, Red, Green or Blue)

Use the left or right arrow key to select the adjustment direction and speed.

Press **ENTER** to increment or decrement the value. Stay pressing on **ENTER** until the desired value is reached.

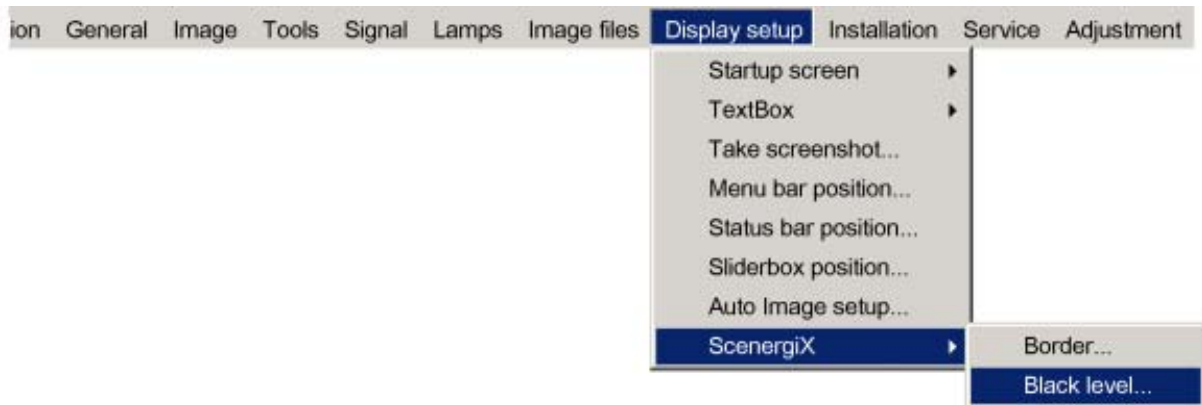

Image 13-24

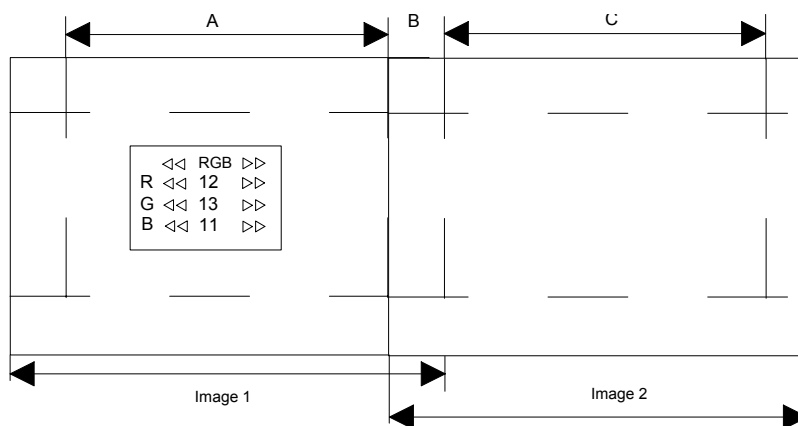

Image 13-25  
Black level adjustment

# 14. INSTALLATION MENU

## Overview

- Lens adjustments
- Projector address
- Orientation
- Language
- Quick access keys
- RS232 baudrate
- Automatic startup
- Security

## 14.1 Lens adjustments

### What can be done ?

Motorized lenses can be adjusted in the installation menu or via the dedicated keys on the remote (see chapter “Getting Started”, “Quick lens adjustment”).

The following parameters can be adjusted:

- Zoom
- Focus
- Shift (also for non motorized lenses)

### How to Zoom/focus or shift ?

1. Press **MENU** to activate the menu bar.
2. Press → to select the *Installation*. (image 14-1)
3. Press ↓ to pull down the *Installation* menu.
4. Use ↑ or ↓ to select *Lens adjustment*.
5. Press **ENTER** to start zoom/focus adjustment.

A text box appears on the screen. (image 14-2)

↑ or ↓	Lens zoom
← or →	Lens focus
<b>ENTER</b>	to switch the cursor key between zoom/focus and vertical/horizontal shift.
<b>Logo</b>	to switch the image between active source or test pattern

6. Press **ENTER** to switch to the shift mode.

See image 14-3.

← or →	Horizontal shift
↑ or ↓	Vertical shift
<b>ENTER</b>	to switch the cursor key between vertical/horizontal shift and zoom/focus
<b>Logo</b>	to switch the image between active source or test pattern



Image 14-1

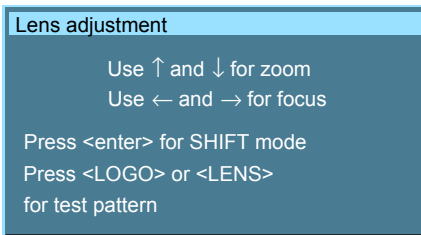

Image 14-2

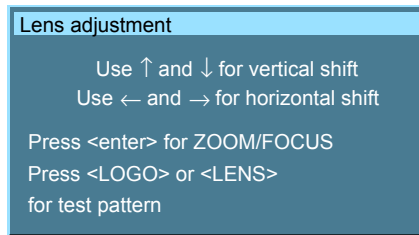

Image 14-3

## 14.2 Projector address

### What can be done ?

In some cases the projector address must be changed, for example if an unique RCU is used to control 2 or more projectors in a room.

The projector address setting on the projector must match the setting on the RCU.

### What can be changed ?

Within the 'Change Projector Address' menu, the following items can be changed

- Projector address: address defined by the user. Can be set between 0 and 255 when controlled via RS232 and between 0 and 9 when controlled via the RCU
- Common address : address may be 0 or 1

### How to change the projector's address ?

1. Press **MENU** to activate the menu bar.
2. Press → to select the *Installation*. (image 14-4)
3. Press ↓ to pull down the *Installation* menu.
4. Use ↑ or ↓ to select *Projector address*.
5. Press **ENTER** to confirm .  
A dialog box appears on the screen. Projector address is selected. (image 14-5)
6. Press **ENTER** to go to the edit mode.  
The most right digit will be selected. Use the left arrow key to jump to the other digits. (image 14-6)
7. Enter an address between 0 and 255 with the digit keys on the RCU and press **ENTER** to activate.



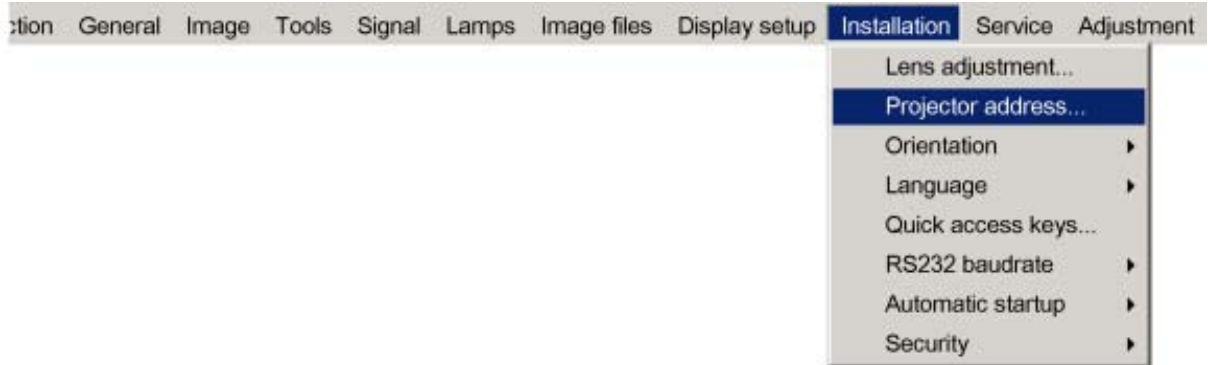

Image 14-4



Image 14-5



Image 14-6

### How to change the common address ?

1. Press **MENU** to activate the menu bar.
2. Press → to select the *Installation*. (image 14-7)
3. Press ↓ to pull down the *Installation* menu
4. Use ↑ or ↓ to select *Projector address*
5. Press **ENTER**

A dialog box appears on the screen. Use the ↑ to scroll to Common RC5 address. (image 14-8)

6. Press **ENTER** to go to the edit mode.  
The digit will be selected. (image 14-9)
7. Enter the common address, 0 or 1.

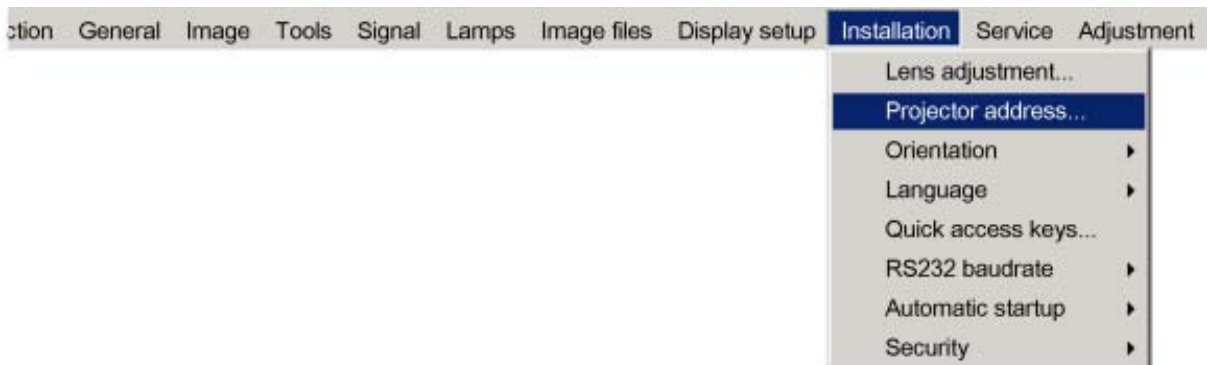

Image 14-7



Image 14-8



Image 14-9

### 14.3 Orientation

#### Projector orientations

Depending on how the projector is oriented, the projector's internal settings have to be adapted. See also Chapter "Installation", "Orientation".

#### How to change the orientation ?

1. Press **MENU** to activate the menu bar.
2. Press → to select the *Installation* item. (image 14-10)
3. Press ↓ to pull down the *Installation* menu.
4. Use ↑ or ↓ to select *Orientation*.
5. Press → to pull down the menu.
6. Use ↓ or ↑ to select the desired orientation.
7. Press **ENTER** to confirm.

The projection is adapted and a white bullet shows the active configuration.

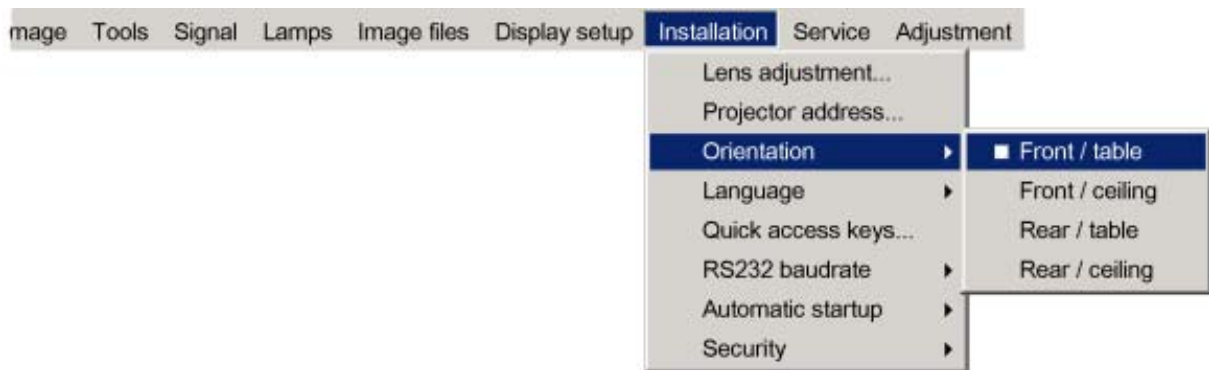

Image 14-10

### 14.4 Language

#### List of languages

The list of selectable languages depends on the software of the projector.

Standard available languages:

- English
- French
- German
- Spanish

#### How to change the Language ?

1. Press **MENU** to activate the menu bar.
2. Press → to select the *Installation* item. (image 14-11)
3. Press ↓ to pull down the *Installation* menu.
4. Use ↑ or ↓ to select *Language*.
5. Press → to pull down the menu.
6. Use ↓ or ↑ to select the desired language.
7. Press **ENTER** to confirm.

The language is adapted and a white bullet shows the active configuration.

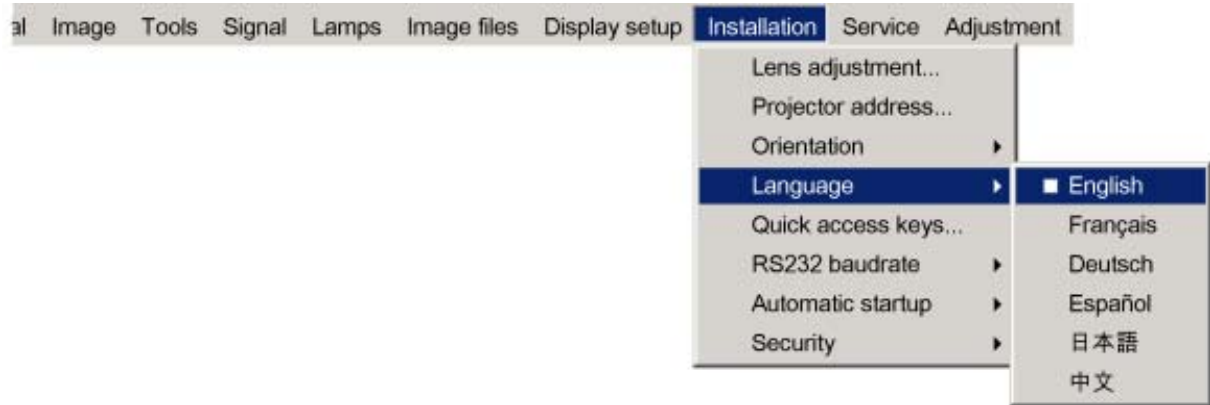

Image 14-11

## 14.5 Quick access keys

### What can be done ?

The 3 function keys on top of the RCU (F1, F2 and F3) can be associated with a particular item in one of the menus.

Each function which is not password protected can be associated to a function key.

### How to get an overview of the quick access keys ?

1. Press **MENU** to activate the menu bar.
2. Press → to select the *Installation*. (image 14-12)
3. Press ↓ to pull down the *Installation* menu.
4. Use ↑ or ↓ to select *Quick access keys*.
5. Press **ENTER**.

The quick access keys overview text box appears on the screen. (image 14-13)

Default factory pre-programmed functions are : color, brightness and contrast.

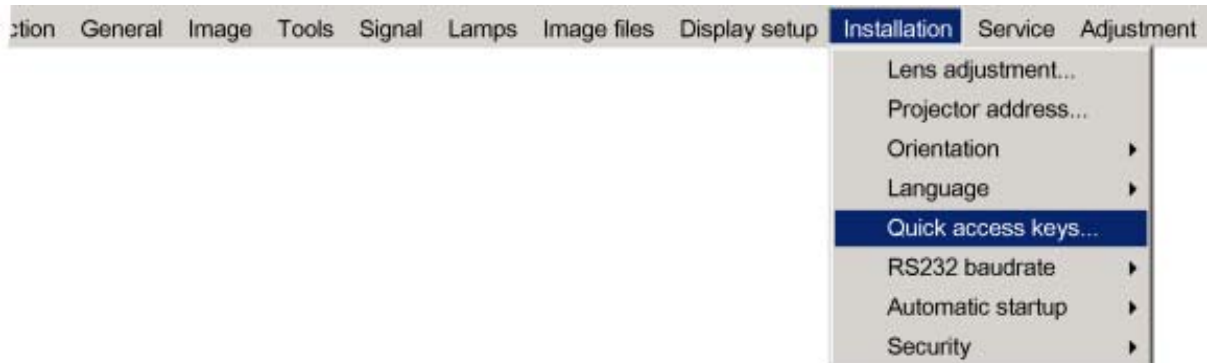

Image 14-12



Image 14-13

### How to program the quick access keys ?

1. Scroll through the menu bar to the desired menu item.
2. Push the desired function key for 3 seconds.

The menu item is stored behind the quick access key. The message *Quick Access key stored* will be displayed.

## 14.6 RS232 baudrate

### How to change the baudrate?

1. Press **MENU** to activate the menu bar.
2. Press → to select the *Installation* item. (image 14-14)
3. Press ↓ to pull down the *Installation* menu.
4. Use ↑ or ↓ to select *RS232 baudrate*
5. Press → to pull down the menu.
6. Use ↓ or ↑ to select the desired baudrate.
7. Press **ENTER** to confirm.

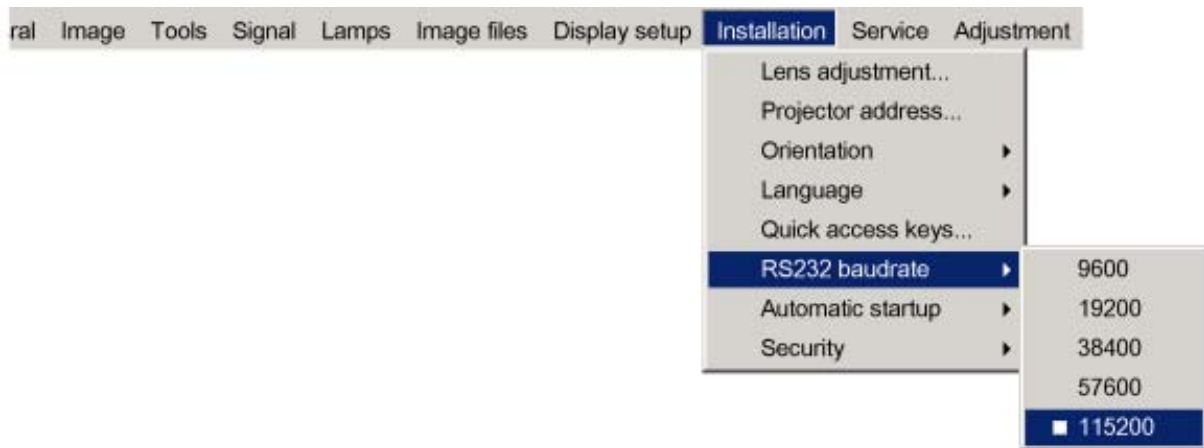

Image 14-14

## 14.7 Automatic startup

### What can be done ?

The automatic startup allows immediate restart of the projector after a power failure (breakdown), i.e. without passing through the standby state.

The projector restarts at power resume and recovers the previous settings (previous source,...).

This function can be disabled if undesired or inadequate for safety reasons, etc.



**CAUTION: If the Automatic startup function is enabled one must be aware of the fact that it involves safety precautions**

**Make sure that the projector (or the operators!) will not be affected by altered environmental conditions when restarting at power resume.**

### How to enable/disable the Automatic startup?

1. Press **MENU** to activate the menu bar.
2. Press → to select the *Installation* item. (image 14-15)
3. Press ↓ to pull down the *Installation* menu.
4. Use ↑ or ↓ to select *Automatic startup* .
5. Press → to pull down the menu.
6. Use ↓ or ↑ to enable/disable the automatic startup.

- On Automatic startup enabled
- Off Automatic startup disabled

7. Press **ENTER** to confirm.



Image 14-15

## 14.8 Security

### What can be done ?

A security function is implemented in the projector that allows a protection against theft.

A PIN code allows the user to lock the projector in case of wrong code entry.

The PIN code must be entered at each start up (Power ON), entering three times a wrong number triggers a wait cycle of 15 minutes, the second 3 wrong codes a wait cycle of 30 minutes, 1 hour, ...

The security mode can be enabled or disabled.

### How to activate the security mode ?

1. Press **MENU** to activate the menu bar.
2. Press → to select the *installation* item. (image 14-16)
3. Press ↓ to pull down the menu.
4. Use ↑ or ↓ to select *Security*.
5. Press → to open the menu.
6. Use ↑ or ↓ to select *ON*.

- On Security function enabled
  - Start up screen will contain the name of the owner of the projector.
  - PIN code will be necessary every time the projector lost power.
- Off Security function disabled

7. Press **ENTER**.

A dialog box is displayed. (image 14-17)

8. Use the arrow keys to select **YES** and press **ENTER** to confirm.

A dialog box is displayed. (image 14-18)

The following things must be entered:

- Your name
- Company name
- Address or location

For more info about how to enter characters with the remote control, see "Using the Dialog boxes", page 46.

9. Press **ACCEPT**.

## 14. Installation menu

A dialog box is displayed.

Enter the PIN code, and confirm the newly entered PIN code. (image 14-19)

An informative text box is then displayed. Press **ENTER** or **BACK** to escape. (image 14-20)

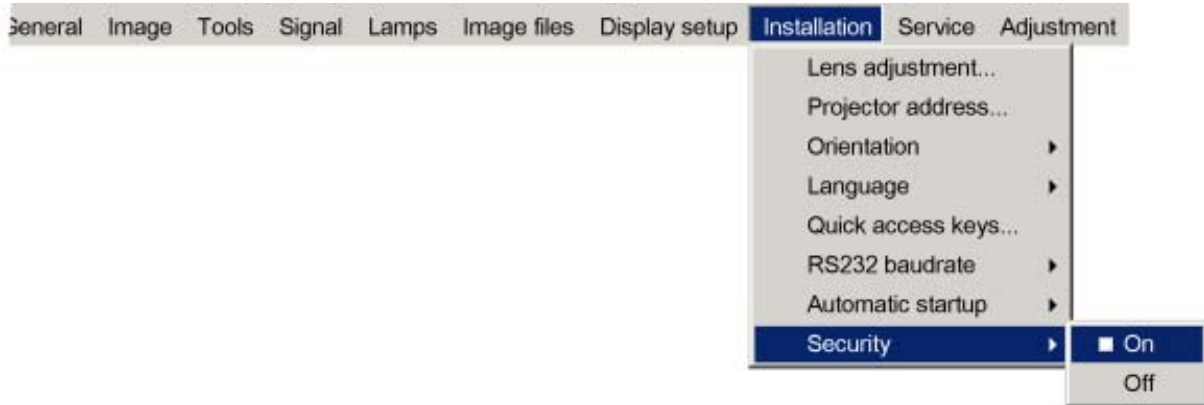

Image 14-16

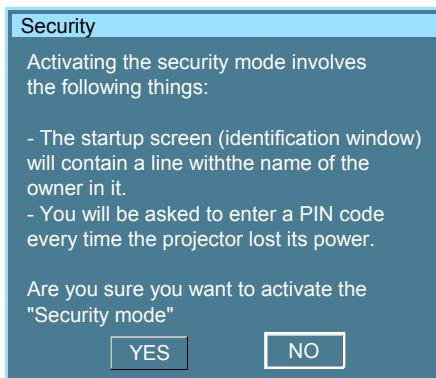

Image 14-17

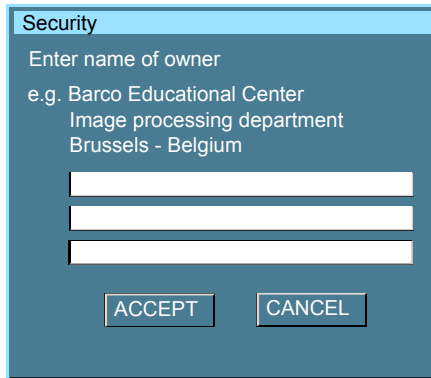

Image 14-18

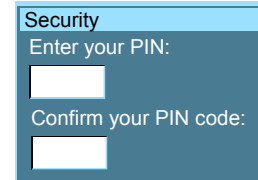

Image 14-19

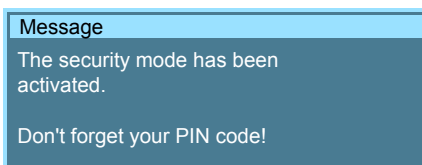

Image 14-20

### How to disable the security mode ?

1. Press **MENU** to activate the menu bar.
2. Press → to select the *installation* item. (image 14-21)
3. Press ↓ to pull down the menu.
4. Use ↑ or ↓ to select *Security*.
5. Press → to open the menu.
6. Use ↑ or ↓ to select *OFF*
7. Press **ENTER** to confirm

An Enter PIN code dialog box will be displayed.

8. Enter your PIN code.

When the PIN code is correct the security mode will be switched off.

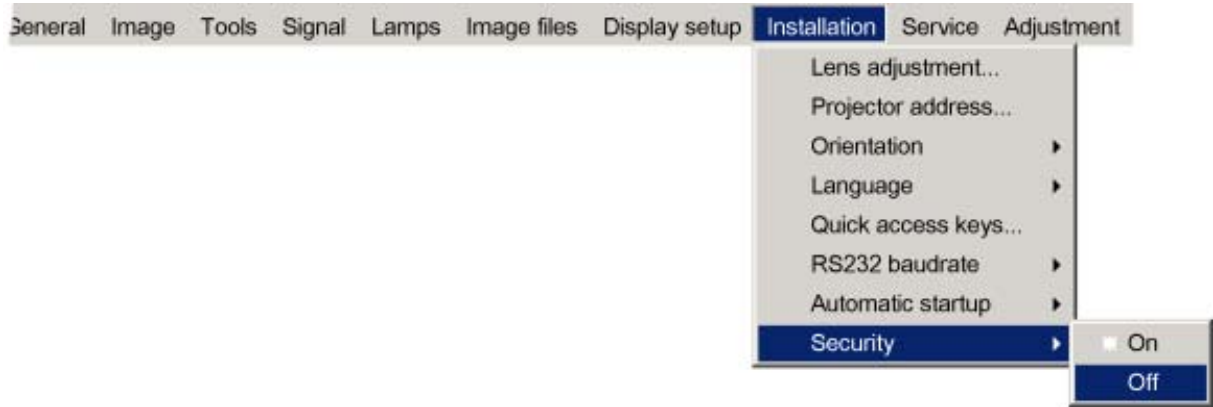

Image 14-21





# 15. SERVICE

## Overview

- Version Table
- Lamps and Power supply
- Board Identification
- Diagnostics
- Formatter firmware
- Formatter reset

## 15.1 Version Table

### What is possible ?

To get an overview of the different software and firmware version inside the projector.

### How to get the version table

1. Press **MENU** to activate the menu bar. (image 15-1)
2. Press **→** to select the *Service* item.
3. Press **↓** to pull down the menu.
4. Use **↑** or **↓** to select *Version table...*
5. Press **ENTER**.

An options dialog box opens. (image 15-2)



Image 15-1

The image shows a dialog box titled 'Version table' with a list of items and their corresponding version numbers. The 'Standard Cpu Config Backup' row is highlighted in blue.

Version table	
Default Program	01.02
Default Program Backup	01.02
BootCode	01.02
Standard Cpu Config	02.02
Standard Cpu Config Backup	02.02
PMP Config1	01.02
PMP Config2	00.00
Backplane Config	01.02
Character map	01.02

Image 15-2

## 15.2 Lamps and Power supply

### What is possible ?

To get an overview of the firmware version of the  $\mu$ C and the measured temperatures.

**How to get the lamps and power supply overview ?**

1. Press **MENU** to activate the menu bar. (image 15-3)
2. Press → to select the *Service* item.
3. Press ↓ to pull down the menu.
4. Use ↑ or ↓ to select *Lamps and Power supply...*
5. Press **ENTER**.

An list dialog box opens. (image 15-4)



Image 15-3

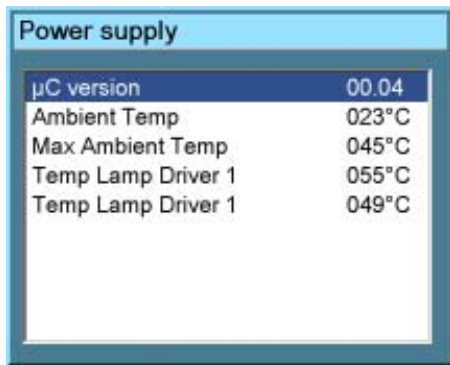

Image 15-4

**15.3 Board Identification**

**What is possible ?**

To get an overview of the board article numbers inside the projector.

**How to get an overview ?**

1. Press **MENU** to activate the menu bar. (image 15-5)
2. Press → to select the *Service* item.
3. Press ↓ to pull down the menu.
4. Use ↑ or ↓ to select *Board Identification...*
5. Press **ENTER**.

An list dialog box opens. (image 15-6)



Image 15-5

Board identification	
PMP (Pixel Map Processor)	R764284
Backplane	R7634371
Input Layer 1	R763990
Input Layer 2	R764091
Input Layer 3	R763456
Power box	B401034

Image 15-6

## 15.4 Diagnostics

### Overview

- I<sup>2</sup>C Diagnostics
- Lamps and power supply

### 15.4.1 I<sup>2</sup>C Diagnostics

#### What can be done ?

The I<sup>2</sup>C bus allows the diagnostic of different hardware components

#### How to display the diagnostics menu ?

1. Press **MENU** to activate the menu bar.
2. Press → to select the *Service* item. (image 15-7)
3. Press ↓ to pull down the *Service* menu.
4. Use ↑ or ↓ to select *Diagnostics*.
5. Press → to pull down the menu.
6. Use ↑ or ↓ to select *I<sup>2</sup>C*.
7. Press **ENTER** to select I<sup>2</sup>C.

A text box is displayed. (image 15-8)

Items with a green icon are OK. Items with a red icon have a problem.

8. Use the ↑ or ↓ keys to scroll inside the list.



Image 15-7

I2C Diagnostics	
Device	Slave address
<input checked="" type="checkbox"/> Lamp driver	0x78
<input checked="" type="checkbox"/> Lamp Eeprom	0xA0
<input checked="" type="checkbox"/> Power Supply	0x30
<input checked="" type="checkbox"/> I2C Multiplexer	0xE0
<input checked="" type="checkbox"/> Red Formatter	0x34
<input checked="" type="checkbox"/> Green Formatter	0x36
<input checked="" type="checkbox"/> Blue Formatter	0x38
<input checked="" type="checkbox"/> Motor driver	0x1A

Image 15-8

### 15.4.2 Lamps and power supply

#### What can be done ?

This menu item gives an overview of the lamp and power supply errors.

#### How to display the overview menu ?

1. Press **MENU** to activate the menu bar.
2. Press → to select the *Service* item. (image 15-9)
3. Press ↓ to pull down the *Service* menu.
4. Use ↑ or ↓ to select *Diagnostics*.
5. Press → to pull down the menu.
6. Use ↑ or ↓ to select *Lamps and power supply*.
7. Press **ENTER** to select *Lamps and power supply*.

A text box with errors is displayed. (image 15-10)

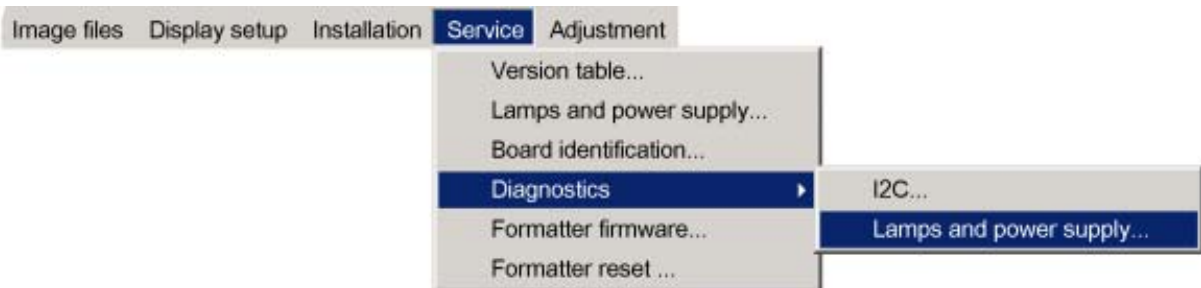

Image 15-9

Lamps and power supply	
Projector runtime	Description
64	: lamp 2 error
65	: lamp 1 error
703	: Ambient temperature error
1144	: lamp 2 error

Image 15-10

## 15.5 Formatter firmware

### How to display ?

1. Press **MENU** to activate the menu bar. (image 15-11)
2. Press **→** to select the *Service* item.
3. Press **↓** to pull down the menu.
4. Use **↑** or **↓** to select *Formatter firmware....*
5. Press **ENTER**.

An options dialog box opens. (image 15-12)



Image 15-11

Formatter firmware	
Red Configuration	00.01
Build	4
Red Main Application	01.21
Build	52
Red Sequence	00.08
Build	19
Green Configuration	00.01
Build	4
Green Main Application	01.21

Image 15-12

## 15.6 Formatter reset

### What can be done ?

During start up it is possible that one or more colors do not start up correctly.

To solve this problem, the formatters will be restarted. During this process, the image will disappear for a few seconds.

### How to display ?

1. Press **MENU** to activate the menu bar. (image 15-13)
2. Press → to select the *Service* item.
3. Press ↓ to pull down the menu.
4. Use ↑ or ↓ to select *Formatter reset...*
5. Press **ENTER**.

An confirmation dialog box opens. (image 15-14)



Image 15-13

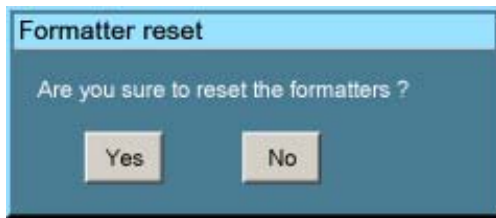

Image 15-14

## 16. ADJUSTMENT MENU (CHECK UP)

### Overview

- Internal patterns
- Convergence
- More..



All items in the adjustment menu are given for check up. No adjustments are possible.

### 16.1 Internal patterns

#### How to select ?

1. Press **MENU** to activate the menu bar.
2. Press **→** to select the *Adjustment* item. (image 16-1)
3. Press **↓** to pull down the *Adjustment* menu.
4. Use **↑** or **↓** to select *Internal patterns*.
5. Press **→** to pull down the menu.
6. Use **↑** or **↓** to select the desired test pattern.  
The following test patterns are available:
  - Purity
  - Outline
  - Hatch
  - Color bars
  - Checkerboard
  - Full white
  - HGBWS
  - Character set
7. Press **ENTER** to select.

The selected test pattern will be displayed.

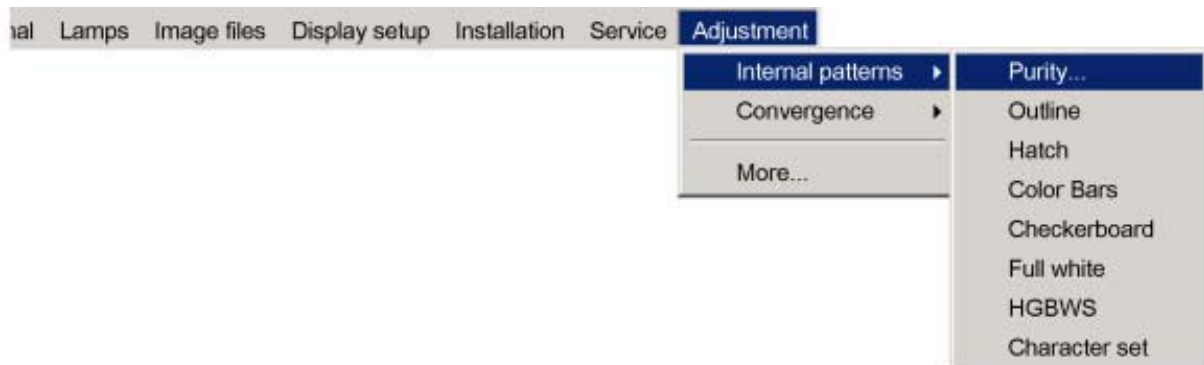

Image 16-1

#### When character set is selected

A character set is built up with several pages:

1. Press **ENTER** for the next set (page).
2. Press **BACK** for previous set (page).
3. Press **MENU** to return to menu structure.

---

## 16.2 Convergence

---



Only for check up of the convergence, no adjustment is possible in the field. When a convergence problem occurred, contact a Barco service center.

---

### How to select ?

1. Press **MENU** to activate the menu bar.
2. Press → to select the *Adjustment* item. (image 16-2)
3. Press ↓ to pull down the *Adjustment* menu.
4. Use ↑ or ↓ to select *Convergence*.
5. Press → to pull down the menu.
6. Use ↑ or ↓ to select the desired convergence test pattern.
7. Press **ENTER** to select.

The selected test pattern will be displayed.



Image 16-2

---

## 16.3 More..

---

### Access

The items covered by More are only accessible for service technicians with a special key code.



# A. STANDARD IMAGE FILES

## A.1 Table overview

### Table overview

The following standard image files are pre-programmed in the projector.

Name <sup>4</sup>	Fvert Hz <sup>5</sup>	FHor kHz <sup>6</sup>	Fpix MHz <sup>7</sup>	Ptot <sup>8</sup>	Pact <sup>9</sup>	Ltot <sup>10</sup>	Lact <sup>11</sup>
Video625	25,00	15,625	11,25	720	680	625	560
Video525	29,97	15,734	11,33	720	680	525	472
SDI_625	25,00	15,625	13,50	864	720	625	572
SDI_525	29,97	15,734	13,50	858	720	525	482
640x350@85	85,079	37,860	31,500	832	640	445	350
640x400@85	85,079	37,860	31,500	832	640	445	400
640x480@60	59,940	31,668	25,175	800	640	525	480
640x480@72	72,888	30,288	19,687	832	640	520	480
640x480@75	74,999	37,500	31,500	840	640	500	480
640x480@85	85,009	43,270	36,000	832	640	509	480
720x400@85	85,040	37,928	35,500	936	720	446	400
800x600@56	56,251	35,157	36,001	1024	800	625	600
800x600@60	60,317	37,879	40,000	1056	800	628	600
800x600@72	72,188	48,077	50,000	1040	800	666	600
800x600@75	75,001	46,876	49,501	1056	800	625	600
800x600@85	85,062	53,674	56,250	1048	800	631	600
1024x768@43 <sup>12</sup>	90,00	36,831	46,554	1264	1024	409	384
1024x768@60	60,004	48,363	65,000	1344	1024	806	768
1024x768@70	70,068	56,475	74,999	1328	1024	806	768
1024x768@75	75,030	60,024	78,751	1312	1024	800	768
1024x768@85	84,996	68,677	94,499	1376	1024	808	768
1152x864@75	74,999	67,499	107,999	1600	1152	900	864
1280x768@60	59,870	47,776	79,499	1664	1280	798	768
1280x768@75	74,992	60,288	102,249	1696	1280	805	768
1280x768@85	84,838	68,634	117,502	1712	1280	809	768

4. Name: name of file, contains the settings.  
5. Fvert Hz: vertical frame frequency of the source  
6. FHor kHz: horizontal frequency of the source  
7. Fpix MHz: pixel frequency  
8. Ptot : total pixels on one horizontal line.  
9. Pact: active pixels on one horizontal line.  
10. Ltot: total lines in one field  
11. Lact: active lines in one field.  
12. Interlaced

A. Standard Image Files

Name <sup>4</sup>	Fvert Hz <sup>5</sup>	FHor kHz <sup>6</sup>	Fpix MHz <sup>7</sup>	Ptot <sup>8</sup>	Pact <sup>9</sup>	Ltot <sup>10</sup>	Lact <sup>11</sup>
1280x768RB@60	59,994	47,396	68,250	1440	1280	790	768
1280x960@85	85,005	85,940	128,505	1728	1280	1011	960
1280x1024@60	60,018	63,980	107,997	1688	1280	1066	1024
1280x1024@75	75,023	79,974	134,997	1688	1280	1066	1024
1280x1024@85	85,027	91,149	157,506	1728	1280	1072	1024
1360x768@60	59,898	47,619	85,333	1792	1360	795	768
1400x1050@60	59,979	65,317	121,751	1864	1400	1089	1050
1400x1050@75	74,866	82,277	155,998	1896	1400	1099	1050
1400x1050@85	84,958	93,879	179,497	1912	1400	1105	1050
1400x1050RB@60	59,946	64,742	100,997	1560	1400	1080	1050
1600x1200@60	60,001	75,002	162,004	2160	1600	1250	1200
1600x1200@85	84,998	106,247	229,494	2160	1600	1250	1200
1920x1200RB@60	59,952	74,041	154,006	2080	1920	1235	1200
hd-1280x720@60p	60,001	45,000	74,251	1650	1280	750	720
hd-1920x1035@30i	60,000	33,720	74,184	2200	1920	562	517
hd-1920x1080@24p	24,000	27,000	74,250	2750	1920	1125	1080
hd-1920x1080@24s <sup>12</sup>	48,001	27,000	74,250	2750	1920	562	540
hd-1920x1080@25i <sup>12</sup>	50,044	28,125	74,249	2640	1920	562	540
hd-1920x1080@25p	25,000	28,125	74,249	2640	1920	1125	1080
hd-1920x1080@30i	60,000	33,720	74,184	2200	1920	562	540
hd-1920x1080@30p	30,000	33,750	74,249	2200	1920	1125	1080
HDSDI50i	49,99	28,14	61,918	2200	1920	563	540
HDSDI25p	24,999	28,124	74,249	2640	1920	1125	1080
HDSDI24p	24,00	27,000	74,25	2750	1920	1125	1080
HDSDI24s	48,005	27,027	74,324	2750	1920	563	540
HDSDI60i	60,019	33,790	74,339	2200	1920	563	540
HDSDI30p	30,00	33,750	74,249	2200	1920	1125	1080
HDSDI60p	60,00	45,00	75,250	1650	1280	750	720
NTSC <sup>12</sup>	59,88	15,748	13,512	858	675	263	240
PAL <sup>12</sup>	49,92	15,625	13,50	864	675	313	286
ProPAL	50,480	39,550	27,251	864	686	625	570
ProNTSC	59,99	31,496	27,024	858	720	525	480

Table A-1

## B. MAINTENANCE OF THE PROJECTOR

### B.1 Air Filters

#### About maintaining the air filters

It is recommended that you replace the air filters (located at the bottom of the projector) when you replace the lamp - or sooner, in dusty or dirty environment. In the latter case, **check monthly** if replacement is required.

A clogged filter reduces the air flow, and can lead to overheating and failure of the projector.

#### Location of the air filters

The air filters, in total 5 filters, are located into the bottom of the projector.



The 2 exterior filters (4 & 5) are obstructed by the mounted stacking frame. To be able to remove these filters, loosen a few turn the frame screw (A) nearest the rear side of the projector.

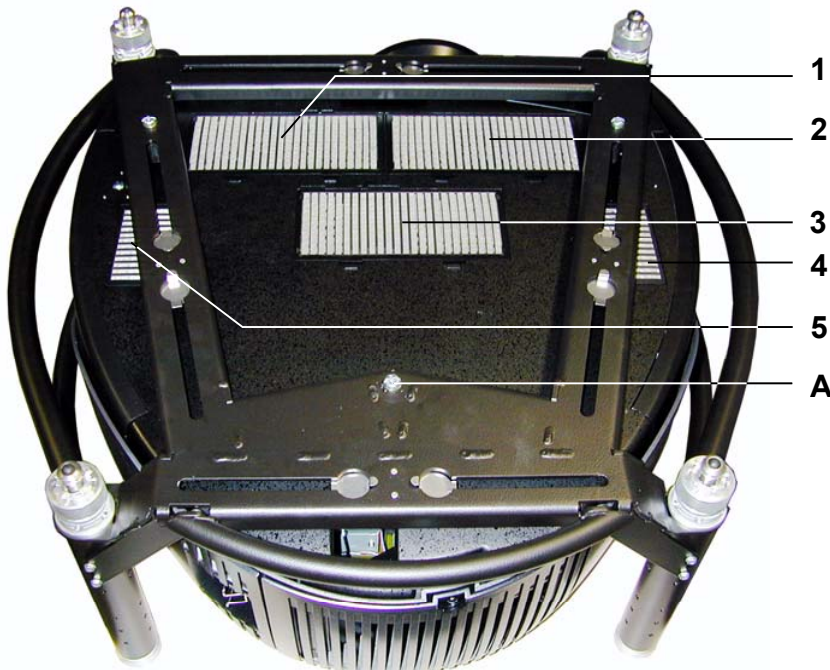

Image B-1  
Location of air filters

#### Replacement of the air filters

1. Press the lip (A) of the filter lock (2 for filters 1 to 3 and 1 for filter 4 & 5) to release and next,
2. Lift up front (B) of air filter and move forwards (C) to remove. (image B-2, image B-3)

**Tip:** For the filters 4 & 5, when the lock is released, move the filter a little to the inside of the projector until the filter center clips are free, and next remove the filter to the outside.

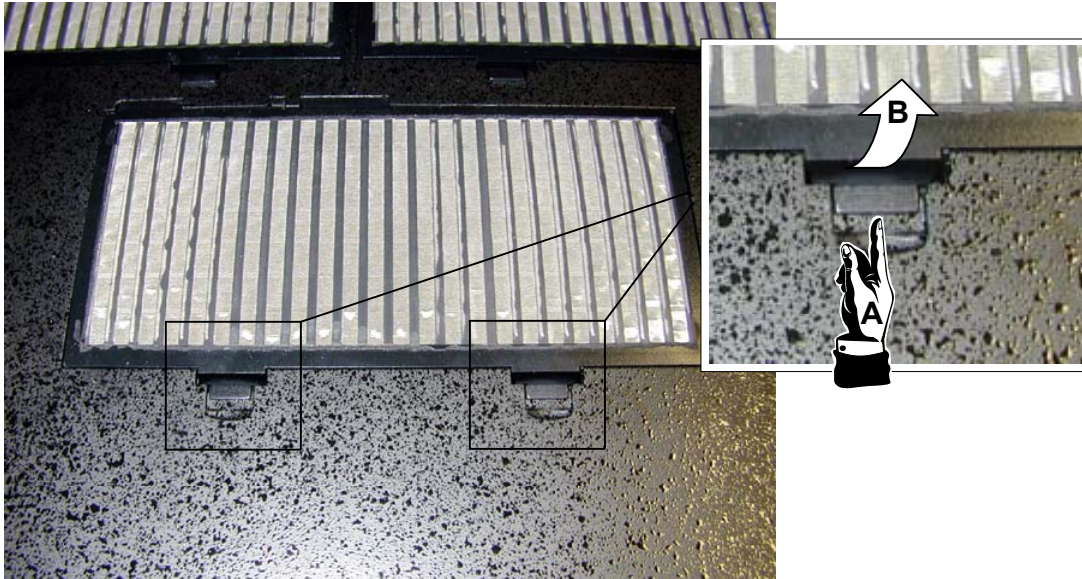

Image B-2

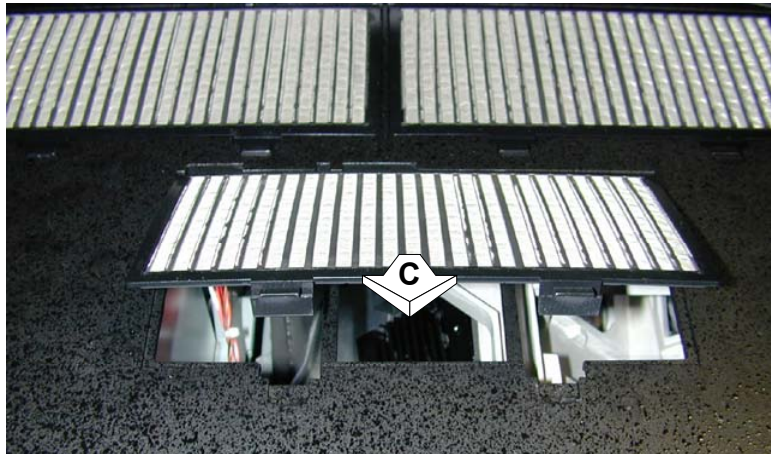

Image B-3

**Available kit**

All the 5 air filters are assembled to 1 kit, order number **R401045K**

## C. SPECIFICATIONS

### C.1 Specifications RLM G5i Performer

#### Overview

<b>Light Output</b>	4500 ANSI Lumen
<b>Resolution</b>	1024 x 768 (native)
<b>Contrast ratio</b>	1000 : 1 (full field)
<b>High contrast mode</b>	Available with special lenses
<b>Brightness uniformity</b>	> 90%
<b>Lamp</b>	2 x 250 W mercury max. lifetime: 1500 hrs typ. lifetime: 1000 hrs min. lifetime: 750 hrs
<b>Noise level (@ 20°C - 68°F)</b>	42 dBa
<b>Noise level (@ 40°C - 104°F)</b>	46,5 dBa
<b>Ambient temperature</b>	Max 40°C (104°F)
<b>Power consumption</b>	700 W
<b>Mains Voltage</b>	92-240 V
<b>Weight</b>	Projector: 25 kg (56 lbs) Frame: 5 kg (11 lbs)
<b>Dimensions (WxLxH)</b>	705 x 707,8 x 316,5 mm
<b>Light shutter</b>	Standard
<b>Sealed DLP™ core</b>	Standard
<b>ScenergiX</b>	Standard horizontal and vertical electronic edge blending
<b>Seamless Switching</b>	Standard (wipes, fades, ...)
<b>Picture-in-picture</b>	Up to 4 sources simultaneously (2 data, 1 video and 1 SDI)
<b>Digital zoom</b>	Standard
<b>Lens encoders</b>	On zoom and focus (with TLD lenses)
<b>Linked Constant Light Output</b>	not available
<b>Input source compatibility</b>	1600 x 1200 (max. input)
<b>Fixed Inputs</b>	<ul style="list-style-type: none"> <li>• 1x configurable 5 cable (BNC)</li> <li>• 1x composite Video (BNC)</li> <li>• 1x S-Video (4-pin DIN)</li> <li>• 1x analogue RGB (D15 Connector)</li> <li>• 1x SDI ( + loop through)</li> <li>• 1x DVI (Digital Visual Interface)</li> </ul>
<b>Modular inputs</b>	not available

C. Specifications

<b>Control</b>	<ul style="list-style-type: none"> <li>• 1 x RS-232 / 422 IN</li> <li>• 1 x XLR female (2 way)</li> <li>• build-in RF remote transceiver (optional)</li> </ul>
<b>Shift Range</b>	<p><b>Lens Shift Range</b> RLD 0.8 up-down: 25&lt;&gt;25  left-right: 20&lt;&gt;20 Other RLD up-down: 100&lt;&gt;10  left-right: 75&lt;&gt;75 TLD (HB) 0.8 up-down: 60&lt;&gt;35  left-right: 50&lt;&gt; 50 Other TLD (HB) up-down: 120&lt;&gt;25  left-right: 75&lt;&gt;75</p>
<b>Throw Ratio</b>	<p><b>Lens Throw ratio</b> RLD 0.8 0.8 RLD 1.5 - 1.8 1.5 - 1.8 RLD 1.8 - 2.25 1.8 - 2.25 RLD 2.25 - 3.0 2.25 - 3.0 RLD 3.0 - 4.5 3.0 - 4.5 RLD 4.5 - 7.0 4.5 - 7.0 TLD (HB) 0.8 1.0 TLD (HB) 1.6 - 2.0 2.0 - 2.5 TLD (HB) 2.0 - 2.8 2.5 - 3.5 TLD (HB) 2.8 - 5.0 3.5 - 6.3 TLD (HB) 5.0 - 8.0 6.3 - 10.0</p>
<b>Order Information</b>	Projector Body R9010320 Spare Dual Lamp R9852940

## Free Manuals Download Website

<http://myh66.com>

<http://usermanuals.us>

<http://www.somanuals.com>

<http://www.4manuals.cc>

<http://www.manual-lib.com>

<http://www.404manual.com>

<http://www.luxmanual.com>

<http://aubethermostatmanual.com>

Golf course search by state

<http://golfingnear.com>

Email search by domain

<http://emailbydomain.com>

Auto manuals search

<http://auto.somanuals.com>

TV manuals search

<http://tv.somanuals.com>