

MatrixPRO™

8x8 DVI Router



User's Guide

- Manual # 26-0503000-00
- Revision A



8x8 DVI Router • User's Guide

Copyright

© Barco, Inc. May 26, 2006

All rights reserved. No part of this document may be copied, reproduced or translated. It shall not otherwise be recorded, transmitted or stored in a retrieval system without the prior written consent of Barco.

Notice

Barco provides this manual "as is" without warranty of any kind, either expressed or implied, including but not limited to the implied warranties or merchantability and fitness for a particular purpose. Barco may make improvements and/or changes to the product(s) and/or the program(s) described in this publication at any time without notice.

This publication could contain technical inaccuracies or typographical errors. Changes are periodically made to the information in this publication; these changes are incorporated in new editions of this publication.

Federal Communications Commission (FCC) Statement

This equipment has been tested and found to comply with the limits for a class A digital device, pursuant to Part 15 of the FCC rules. These limits are designed to provide reasonable protection against harmful interference when the equipment is operated in a commercial environment. This equipment generates, uses, and can radiate radio frequency energy and, if not installed and used in accordance with the instruction manual, may cause harmful interference to radio communications. Operation of this equipment in a residential area may cause harmful interference, in which case the user will be responsible for correcting any interference.

Guarantee and Compensation

Barco provides a guarantee relating to perfect manufacturing as part of the legally stipulated terms of guarantee. On receipt, the purchaser must immediately inspect all delivered goods for damage incurred during transport, as well as for material and manufacturing faults Barco must be informed immediately in writing of any complaints.

The period of guarantee begins on the date of transfer of risks, in the case of special systems and software on the date of commissioning, at latest 30 days after the transfer of risks. In the event of justified notice of compliant, Barco can repair the fault or provide a replacement at its own discretion within an appropriate period. If this measure proves to be impossible or unsuccessful, the purchaser can demand a reduction in the purchase price or cancellation of the contract. All other claims, in particular those relating to compensation for direct or indirect damage, and also damage attributed to the operation of software as well as to other services provided by Barco, being a component of the system or independent service, will be deemed invalid provided the damage is not proven to be attributed to the absence of properties guaranteed in writing or due to the intent or gross negligence or part of Barco.

If the purchaser or a third party carries out modifications or repairs on goods delivered by Barco, or if the goods are handled incorrectly, in particular if the systems are commissioned operated incorrectly or if, after the transfer of risks, the goods are subject to influences not agreed upon in the contract, all guarantee claims of the purchaser will be rendered invalid. Not included in the guarantee coverage are system failures which are attributed to programs or special electronic circuitry provided by the purchaser, e.g. interfaces. Normal wear as well as normal maintenance are not subject to the guarantee provided by Barco either.

The environmental conditions as well as the servicing and maintenance regulations specified in this manual must be complied with by the customer.

Trademarks

Brand and product names mentioned in this manual may be trademarks, registered trademarks or copyrights of their respective holders. All brand and product names mentioned in this manual serve as comments or examples and are not to be understood as advertising for the products or their manufactures.

Company Address



Barco Media and Entertainment
11101 Trade Center Drive
Rancho Cordova, California 95670
USA

- Phone: (916) 859-2500
- Fax: (916) 859-2515
- Websites:
 - ~ www.folsom.com
 - ~ www.events.barco.com

Barco N.V.
Noordlaan 5
8520 Kuurne
BELGIUM

- Phone: +32 56.36.82.11
- Fax: +32 56.35.16.51
- Website: www.barco.com

Operators Safety Summary

The general safety information in this summary is for operating personnel.

Do Not Remove Covers or Panels

There are no user-serviceable parts within the unit. Removal of the top cover will expose dangerous voltages. To avoid personal injury, do not remove the top cover. Do not operate the unit without the cover installed.

Power Source

This product is intended to operate from a power source that will not apply more than 230 volts rms between the supply conductors or between both supply conductor and ground. A protective ground connection by way of grounding conductor in the power cord is essential for safe operation.

Grounding the Product

This product is grounded through the grounding conductor of the power cord. To avoid electrical shock, plug the power cord into a properly wired receptacle before connecting to the product input or output terminals. A protective-ground connection by way of the grounding conductor in the power cord is essential for safe operation.

Use the Proper Power Cord

Use only the power cord and connector specified for your product. Use only a power cord that is in good condition. Refer cord and connector changes to qualified service personnel.

Do Not Operate in Explosive Atmospheres

To avoid explosion, do not operate this product in an explosive atmosphere.

Terms In This Manual and Equipment Marking



WARNING

Highlights an operating procedure, practice, condition, statement, etc., which, if not strictly observed, could result in injury to or death of personnel.

Note

Highlights an essential operating procedure, condition or statement.



CAUTION

The exclamation point within an equilateral triangle is intended to alert the user to the presence of important operating and maintenance (servicing) instructions in the literature accompanying the appliance.



AVERTISSEMENT!

Le point d'exclamation dans un triangle équilatéral signale à alerter l'utilisateur qu'il y a des instructions d'opération et d'entretien très importantes dans la littérature qui accompagne l'appareil.



VORSICHT

Ein Ausrufungszeichen innerhalb eines gleichwinkligen Dreiecks dient dazu, den Benutzer auf wichtige Bedienungs- und Wartungsanweisungen in der dem Gerät beiliegenden Literatur aufmerksam zu machen.

Change History

The table below lists the changes to the MatrixPRO 8x8 DVI Router User's Guide.

Table 0-1. Change History

Rev	Date	ECO #	Description	Approved By
A	5/26/06	1640	MatrixPRO 8x8 DVI Router User's Guide	M. Lettau

Table of Contents

Chapter 1	Introduction	11
	In This Chapter	11
	Chapter Structure	12
	How to Use This Guide	13
	Navigating	13
	Table of Contents and Index	13
	General Operations	13
	Conventions	13
	About the MatrixPRO 8x8 DVI Router	14
	Features	14
	Connectivity Diagram	15
	Application Questions	15
Chapter 2	Hardware Orientation	17
	In This Chapter	17
	MatrixPRO 8x8 DVI Router Front Panel	18
	Display Section	20
	MatrixPRO 8x8 DVI Router Rear Panel	21
Chapter 3	Installation	23
	In This Chapter	23
	Safety Precautions	24
	Unpacking and Inspection	24
	Site Preparation	24
	Rack-Mount Installation	25
	Power Installation	26
	Power Cord/Line Voltage Selection	26
	Signal Installation	27
Chapter 4	Operation	29
	In This Chapter	29
	Control Overview	30
	Power-Up Initialization	30
	Menu Tree	31
	Menu System Overview	32
	Quick Function Reference	34
	Using the Main Menu	35
	Setup Menu	36
	System Menu	36
	Factory Reset Menu	39

Table of Contents

Tech Support Menu	39
Status Menu	40
EDID Resolution Menu	41
Cable Equalization Menu	42
Test Pattern Menu	43
Using the Test Pattern.	44
Using the Raster Box	45
Vertical Switching Menu	45
Save Configuration Menu	46
Recall Configuration Menu	47
MatrixPRO Operating Procedures	48
Performing a Take	48
Performing a Multi-Take	49
Clearing a Route	49
Checking Router Status.	49
Routing a Test Pattern.	50
Using RGB Mute	50
Working with Groups	51
Unlocking the Control Panel	52

Chapter 5 GUI Installation and Operation 53

In This Chapter	53
Control GUI Installation	54
Running the GUI	57
Connection Troubleshooting	58
GUI Overview	59
Using the Menu Bar	60
File Menu	60
Serial Port Menu	61
About Menu	62
Using the Video Switching Tab.	63
GUI Switching Operations	65
Performing a Take	66
Performing a Multi-Take	66
Clearing a Route	67
Using RGB Mute	67
Saving Presets.	68
Recalling Presets.	69
Using the Labeling Tab.	70
Using the Grouping Tab	71
Using the Sequencing Tab	73
Using the Setup Tab.	75
Using the "About" Tab	76

Chapter 6 Upgrading Software. 77

In This Chapter	77
Software Upgrade Overview.	78
Hardware Requirements.	78
Software Requirements	78
Downloading Software	79

Via FTP Site 79
 Via Web Site 79
 Serial Upgrade Method 80
 Ethernet Upgrade Method 82
 Troubleshooting Ethernet Communication 83

Appendix A Specifications 85

In This Appendix 85
 Input Specifications 86
 Output Specifications 86
 Physical and Electrical Specifications 87
 Communications Specifications 87
 Agency Specifications 87
 Pinouts 88
 DVI Connector 88
 88
 Ethernet Connector 89
 Serial Connector 90

Appendix B Remote Control Protocol 91

In This Appendix 91
 Default Serial Parameters 92
 Default IP Address 92
 RS-232 Mode 93
 MatrixPRO Remote Commands 94
 MatrixPRO 8x8 DVI Router Serial Command List 95
 CLEAR 95
 DHCP 95
 FPLOCK en 95
 GCLEAR grp 95
 GADD grp out in 95
 GDEL grp out in 96
 IP 96
 IPINFO 96
 LOADR 96
 MPRC 96
 OSTAT 96
 NSTAT 97
 PRST num 97
 PSTAT 97
 RESET 97
 REV 97
 RGBMUTE 98
 RPRST num 98
 RTEMP out in 98
 SPARAMS 98
 TAKE en 98
 TPAT 99
 WHOAREYOU 99

Table of Contents

	HELP.....	99
	?	99
Appendix C	Contact Information	101
	In This Appendix.....	101
	Warranty	101
	Return Material Authorization (RMA)	101
	Contact Information	102
Index	103

1. Introduction

The logo for MatrixPRO, featuring the word "MatrixPRO" in a bold, italicized, purple font with a blue underline. The "TM" trademark symbol is positioned to the right of the word.

In This Chapter

This chapter is designed to introduce you to the MatrixPRO™ 8x8 DVI Router. Areas to be covered are:

- [Chapter Structure](#)
- [How to Use This Guide](#)
- [Conventions](#)
- [About the MatrixPRO 8x8 DVI Router](#)
- [Features](#)
- [Connectivity Diagram](#)

1. Introduction

Chapter Structure

Chapter Structure

The following chapters provide instructions for all aspects of MatrixPRO 8x8 DVI Router operations:

- Chapter 1, "[Introduction](#)" provides a system overview, a list of features, and a system connectivity diagram.
- Chapter 2, "[Hardware Orientation](#)" on page 17 provides detailed diagrams of the system's front and rear panels.
- Chapter 3, "[Installation](#)" on page 23 provides comprehensive system installation instructions.
- Chapter 4, "[Operation](#)" on page 29 provides basic system operating instructions.
- Chapter 5, "[GUI Installation and Operation](#)" on page 53 describes the system's interactive Graphical User Interface application.
- Chapter 6, "[Upgrading Software](#)" on page 77 outlines procedures for upgrading system software components.
- Appendix A, "[Specifications](#)" on page 85 lists the MatrixPRO 8x8 DVI Router's specifications.
- Appendix B, "[Remote Control Protocol](#)" on page 91 provides detailed information regarding external remote control protocol.
- Appendix C, "[Contact Information](#)" on page 101 lists important Barco contact, RMA, warranty and technical support details.

How to Use This Guide

Following are important tips for streamlining your use of this User's Guide in its electronic "PDF" form.

Navigating

Use Acrobat Reader's "bookmarks" to navigate to the desired location. All chapter files have the same bookmark structure for instant navigation to any section. Please note:



- Extensive hyperlinks are provided within the chapters.
- Use Acrobat's "**Go to Previous View**" and "**Return to Next View**" buttons to trace your complete navigational path.
- Use the "**Previous Page**" and "**Next Page**" buttons to go to the previous or next page within a file.
- Use Acrobat's extensive search capabilities, such as the "**Find**" tool and "**Search Index**" tool to perform comprehensive searches as required.

Table of Contents and Index

Use the **Table of Contents** bookmarks to navigate a desired topic. Click any item to instantly jump to that section of the guide. You can also use the **Index** to jump to specific topics within a chapter. Each page number in the **Index** is a hyperlink.

General Operations

To ensure trouble-free operation, please follow all procedures as listed below:

- For installation instructions, refer to Chapter 3, "[Installation](#)" on page 23.
- For operating instructions, refer to Chapter 4, "[Operation](#)" on page 29 and Chapter 5, "[GUI Installation and Operation](#)" on page 53.

Should you have any questions regarding the installation or operation of the MatrixPRO 8x8 DVI Router, please consult with the factory. Refer to Appendix C, "[Contact Information](#)" on page 101 for contact information.

Conventions

The following conventions are used throughout this guide:

- The symbol ■ denotes an operations procedure.
- The symbol ▲ denotes an example.
- Entries written in bold-face capital letters denote physical buttons or chassis connectors.

▲ Press **SEL** to ...

1. Introduction

About the MatrixPRO 8x8 DVI Router

About the MatrixPRO 8x8 DVI Router

The MatrixPRO 8x8 DVI Router is a DVI crosspoint switch supporting resolutions ranging from VGA (640x480) to UXGA (1600x1200x60) — including all HDTV resolutions. Any input can be routed to any combination of the 8 outputs. The unit is housed in a 2RU chassis and is configured as an 8x8 router.

There are three ways that you can control the router:

- Via front panel buttons and the integral menu display.
- Via the interactive Control GUI, which is accessed through the rear panel's Ethernet connector.
- Via the Encore Controller.

Note that user interface and system firmware upgrades can be installed in the field via the system's rear panel Ethernet and RS-232 connections.

Features

The MatrixPRO 8x8 DVI Router includes the following features:

- Front panel or GUI control.
- One-to-one and one-to-many routing.
- Input grouping, enabling you to create sub-groups of inputs and outputs.
- Integrated test pattern generator.
- For the selected output, "RGB Mute" feature blanks the output video while leaving sync signals running to the monitor.
- Input EDID (Extended Display Identification Data) control on a per-channel basis.
- Input cable equalization control on a per-channel basis.
- Menu-based setup and function selection.
- Save and recall setups.
- Reclocking TMDS (Transition Minimized Differential Signaling) functionality ensures clean output signals.
- Supports resolutions from VGA (640x480) to UXGA (1600x1200x60), including all HD resolutions (e.g., such as 1920x1080).
- Supports input cable lengths up to 20 meters, using high quality DVI cables.

Note

Signal quality cannot be guaranteed for cable lengths of 20 meters if lower quality DVI cables are used, or if cable extenders are used.

- Vertical interval switching mode, with selectable input channel lock source.
- Local or external control via Ethernet or RS-232.
- Optional remote switching panels via Ethernet communications.

Connectivity Diagram

The figure below provides a sample connectivity diagram:

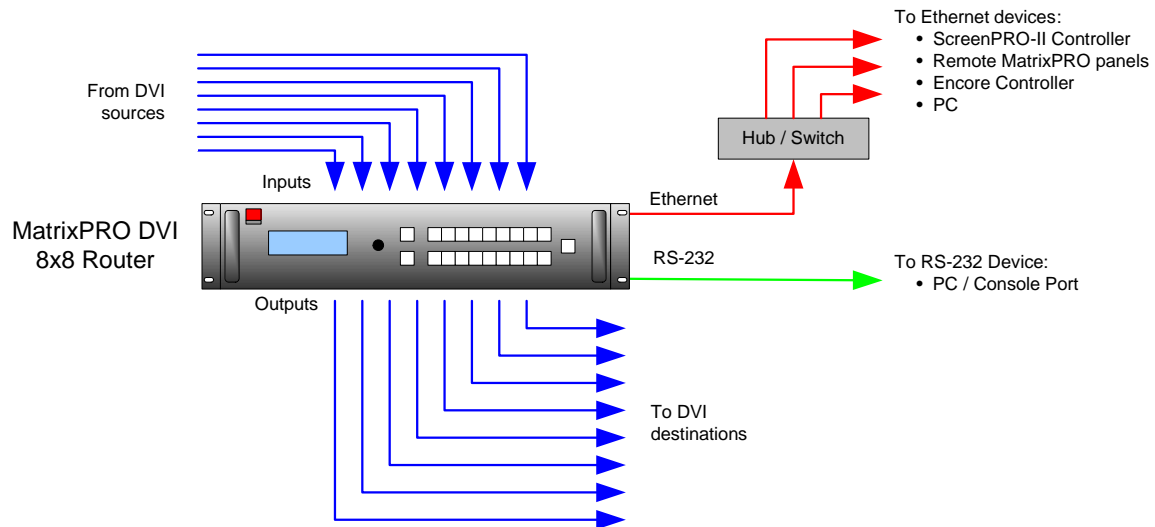

Figure 1-1. MatrixPRO 8x8 DVI Router System Diagram (sample)

Note

The MatrixPRO product line does not scan convert any of the input formats — it only routes signals. Therefore, it is important to match input formats to the output device(s).

Application Questions

At Barco, we take pride in offering unique solutions to demanding technical problems. If you have application questions, require further information or would like to discuss your application requirements in more detail, please call (916) 859-2500. Our Customer Support Engineers will be happy to supply you with the support you need. Refer to Appendix C, "[Contact Information](#)" on page 101 for details.

1. Introduction

Connectivity Diagram

2. Hardware Orientation

MatrixPRO™

In This Chapter

This chapter provides detailed diagrams of the system's front and rear panels. The following topics are discussed:

- [MatrixPRO 8x8 DVI Router Front Panel](#)
- [MatrixPRO 8x8 DVI Router Rear Panel](#)

2. Hardware Orientation

MatrixPRO 8x8 DVI Router Front Panel

MatrixPRO 8x8 DVI Router Front Panel

The figure below illustrates the MatrixPRO 8x8 DVI Router front panel:

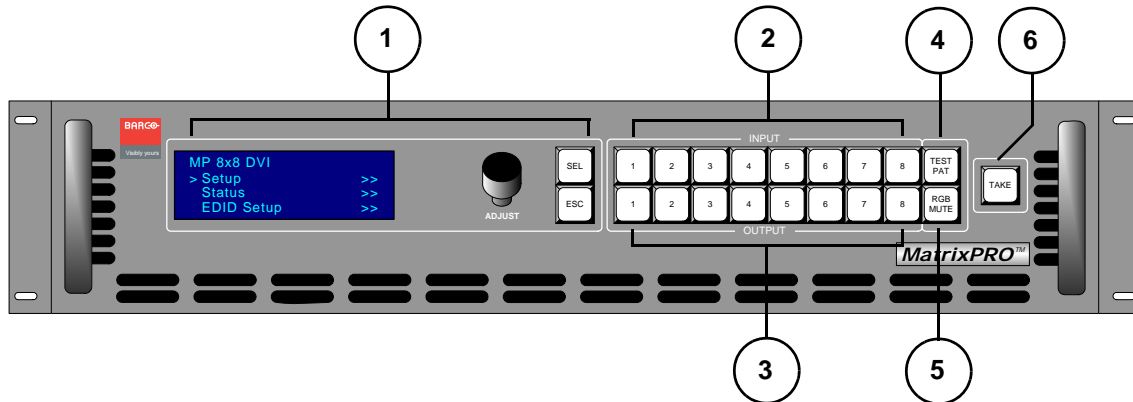

Figure 2-1. MatrixPRO 8x8 DVI Router Front Panel

1) Display Section	4) TEST PAT Button
2) Input Selection Section	5) RGB MUTE Button
3) Output Selection Section	6) TAKE Button

Following are descriptions of each front panel control feature:

1) Display Section

The **Display Section** includes the display, the **ADJUST** knob and two “menu navigation” buttons. Refer to the [“Display Section”](#) heading on page 20 for complete details.

2) Input Selection Section

On the top row at the right-side of the front panel, eight input (crosspoint) selection buttons are provided on the top row. Routing is performed as follows:

~ Select an output, select an input, press **TAKE**.

In Chapter 4, refer to the [“Performing a Take”](#) section on page 48 for details.

3) Output Selection Section

On the bottom row at the right-side of the front panel, eight output (crosspoint) selection buttons are provided on the bottom row. In Chapter 4, refer to the [“Performing a Take”](#) section on page 48 for details.

4) TEST PAT Button

The **TEST PAT** button functions as a ninth input, enabling you to route a selected test pattern to one or more outputs. When pressed, the button lights and the system pends the test pattern route. Test patterns are pre-selected using the **Test Pattern Menu**. Patterns include H ramp, V ramp, 100% color bars, 75% color bars, grids, burst, grey field, white field, black field, and grey steps. In Chapter 4, refer to the [“Routing a Test Pattern”](#) section on page 50 for details.

2. Hardware Orientation

MatrixPRO 8x8 DVI Router Front Panel

5) RGB MUTE Button

The **RGB MUTE** button enables you to blank the selected output video while leaving sync signals running to the monitor. Select the desired output, press **RGB MUTE** and press **TAKE** to complete the route. In Chapter 4, refer to the "[Using RGB Mute](#)" section on page 50 for details.

6) TAKE Button

Once input and output selections have been made, press the **TAKE** button to complete a route. In Chapter 4, refer to the "[Performing a Take](#)" section on page 48 for details.

2. Hardware Orientation

MatrixPRO 8x8 DVI Router Front Panel

Display Section

The figure below illustrates the **Display Section**:

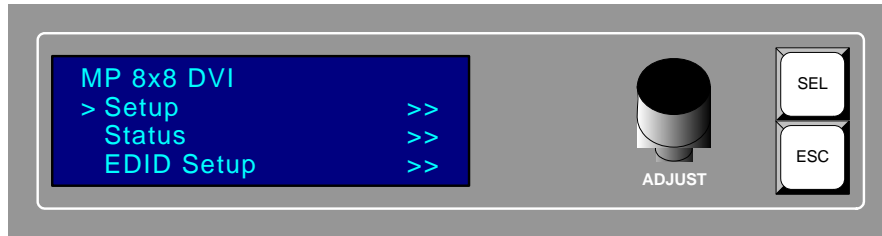

Figure 2-2. Display Section

Descriptions of each button and control are provided below:

- The **Menu Display** is a 4 line x 20 character Vacuum Fluorescent Display (VFD) that shows all 8x8 DVI Router menus and sub-menus. Brightness is adjustable.



Figure 2-3. Sample Menu Display (Setup Menu)

Please note:

- ~ The top line names the current menu, in all capital letters.
- ~ The navigation cursor (>) in the left-hand column indicates the current line on which action can be taken.
- ~ The double arrow (>>) indicates that a sub-menu is available.

In Chapter 4, refer to the "[Menu Tree](#)" section on page 31 for complete menu structure details.

- **ADJUST** — use the **Adjust Knob** to scroll through all system menus.
 - ~ Turn the knob counter-clockwise (**CCW**) to scroll down.
 - ~ Turn the knob clockwise (**CW**) to scroll up.
- **SEL** — press to enter a sub-menu, change a parameter, accept a parameter, or answer "**Yes**" to certain menu queries.
- **ESC** — press to exit a menu without making changes, cancel an operation, or answer "**No**" to certain menu queries. Each press takes you back up the menu tree by one level.

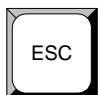
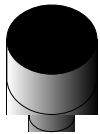

MatrixPRO 8x8 DVI Router Rear Panel

The figure below illustrates the MatrixPRO 8x8 DVI Router rear panel:

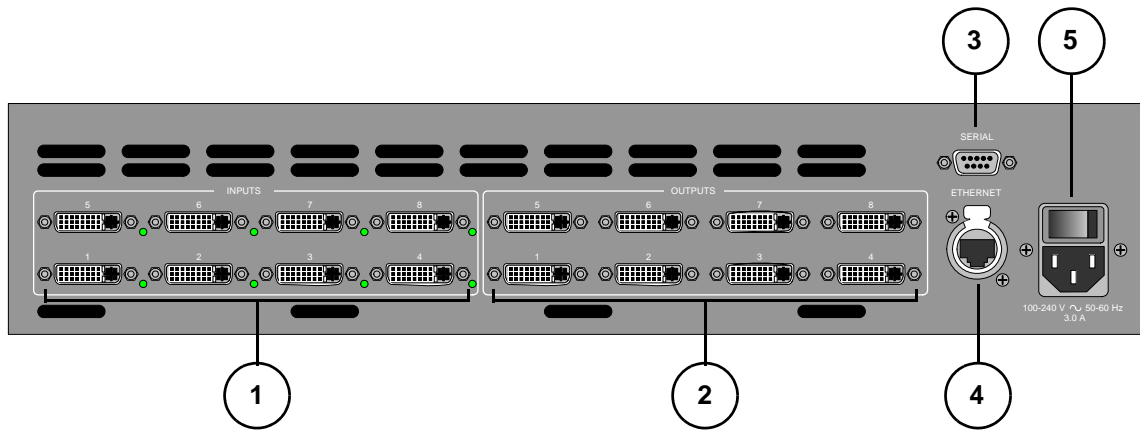

Figure 2-1. MatrixPRO 8x8 DVI Router Rear Panel

1) DVI Input Connectors	4) Ethernet Port
2) DVI Output Connectors	5) AC Connector
3) Serial Port	

Following are descriptions of each rear panel connector:

1) DVI Input Connectors

Eight DVI input connectors are provided. Each connector has an associated LED that lights green to indicate the presence of a valid video signal.

- ~ In Appendix A, refer to the "[Input Specifications](#)" section on page 86 for input video details.
- ~ In Appendix A, refer to the "[DVI Connector](#)" section on page 88 for pinout specifications.

2) DVI Output Connectors

Eight DVI output connectors are provided.

- ~ In Appendix A, refer to the "[Output Specifications](#)" section on page 86 for output video details.
- ~ In Appendix A, refer to the "[DVI Connector](#)" section on page 88 for pinout specifications.

3) Serial Port

One 9-pin D connector is provided for RS-232 serial communications with the MatrixPRO 8x8 DVI Router chassis and for downloading code in the field. In Appendix A, refer to the "[Serial Connector](#)" section on page 90 for pinouts.

4) Ethernet Port

One RJ-45 connector is provided for 10/100BaseT **Ethernet** communications with the MatrixPRO 8x8 DVI Router chassis. When (optionally) connecting the router to an Encore or remote control panel, a standard Ethernet hub or switch on an isolated network is recommended.

2. Hardware Orientation

MatrixPRO 8x8 DVI Router Rear Panel

The Ethernet connector is compatible with:

- ~ Standard RJ-45 Ethernet cables
- ~ Neutrik EtherCon[®] series cables

In Appendix A, refer to the "[Ethernet Connector](#)" section on page 89 for pinouts.

5) AC Connector

One **AC Connector** is provided to connect the MatrixPRO 8x8 DVI Router to your facility's AC power source. The integral switch turns the chassis on and off.

3. Installation

The logo for MatrixPRO, featuring the word "MatrixPRO" in a bold, purple, sans-serif font with a trademark symbol (TM) to the right. A blue horizontal line is positioned below the text.

In This Chapter

This chapter provides detailed instructions for installing the MatrixPRO 8x8 DVI Router hardware. The following topics are discussed:

- [Safety Precautions](#)
- [Unpacking and Inspection](#)
- [Site Preparation](#)
- [Rack-Mount Installation](#)
- [Power Installation](#)
- [Signal Installation](#)

3. Installation

Safety Precautions

Safety Precautions

For all MatrixPRO 8x8 DVI Router installation procedures, observe the following important safety and handling rules to avoid damage to yourself and the equipment:

- To protect users from electric shock, ensure that the power supplies for each unit connect to earth via the ground wire provided in the AC power Cord.
- The AC Socket-outlet should be installed near the equipment and be easily accessible.

Unpacking and Inspection

Before opening the box, inspect it for damage. If you find any damage, notify the shipping carrier immediately for all claims adjustments. As you open the box, compare its contents against the packing slip. If you find any shortages, contact your Barco sales representative.

Once you have removed all the components from their packaging and checked that all the listed components are present, visually inspect each unit to ensure there was no damage during shipping. If there is damage, notify the shipping carrier immediately for all claims adjustments.

Site Preparation

The environment in which you install your MatrixPRO 8x8 DVI Router(s) should be clean, properly lit, free from static, and have adequate power, ventilation, and space for all components.

Rack-Mount Installation

MatrixPRO 8x8 DVI Routers are designed to be rack mounted. Please note the following important points:

- When rack mounting the unit, remember that maximum ambient operating temperature for the unit is 40 degrees C.
- Leave sufficient front and rear space to make sure that the airflow through the fan and vent holes is not restricted.
- When installing equipment into a rack, distribute the units evenly to prevent hazardous conditions that may be created by uneven weight distribution.
- Connect the unit only to a properly rated supply circuit.
- Reliable Grounding (Earthing) of Rack-Mounted Equipment should be maintained.
- Rack mount the unit from the front rack ears using four rack screws (not supplied). Rack threads may be metric or otherwise — depending upon the rack type.
- Install the *lower* of the two mounting holes first.

3. Installation

Power Installation

Power Installation

- Use the following steps to install power to the MatrixPRO 8x8 DVI Router:
 1. Connect an AC power cord to the AC Power Connector on the rear of the MatrixPRO 8x8 DVI Router, and then to an AC outlet.
 2. Connect AC Power cords (or AC adapters) to all peripheral equipment, such as Ethernet Hubs and Encore Controllers. Please note:
 - ~ Connect each unit only to a properly rated supply circuit.
 - ~ Reliable grounding (earthing) of rack-mounted equipment should be maintained.

Power Cord/Line Voltage Selection

The MatrixPRO 8x8 DVI Router performs line voltage selection automatically. No user controls are required for line voltage selection. The AC power cords must be accessible so that the cords can be removed during field servicing.



Warning

When the MatrixPRO 8x8 DVI Router is used in the 230-volt mode, a UL listed line cord rated for 250 volts at 15 amps must be used. This cord will be fitted with a tandem prong-type plug.



Figure 3-1. Tandem Prong-type Plug

Avertissement

La choix de la ligne de voltage se réalise automatiquement par le MatrixPRO 8x8 DVI Router Transformateur Graphique. On n'a pas besoin du controller usager pour la choix de la ligne de voltage.

Warnung

Das MatrixPRO 8x8 DVI Router gerät mu beim Anschlu an 240V ~ mit einer vom VDE auf 250V/10A geprüften Netzleitung mit einem Schukostecker ausgestattet sein.

Signal Installation

The figure below illustrates a sample MatrixPRO 8x8 DVI Router system diagram. Use this figure for reference during the signal installation process.

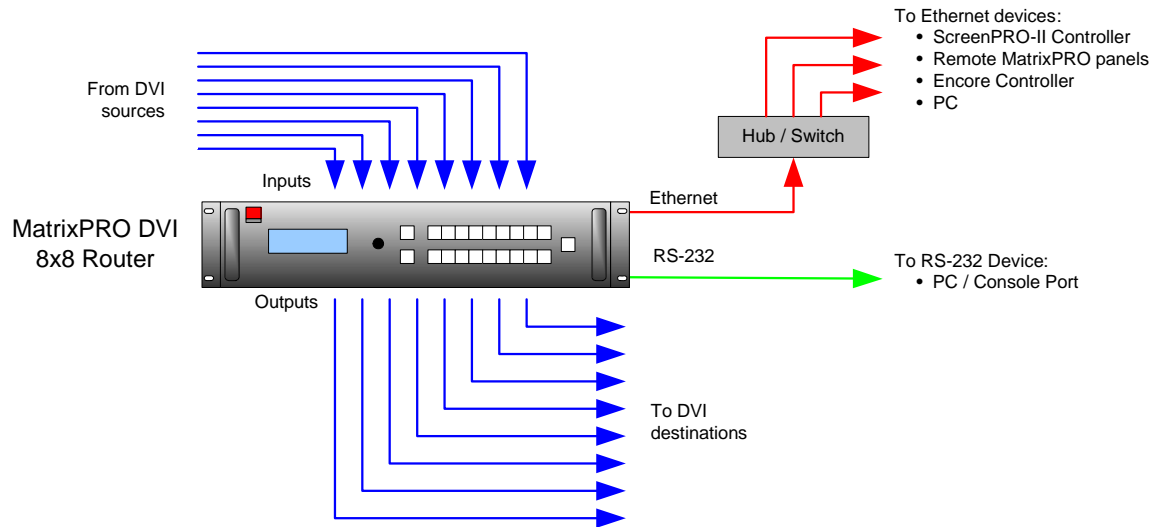

Figure 3-2. MatrixPRO 8x8 DVI Router System Diagram (sample)

- Use the following steps to install signals to/from the MatrixPRO 8x8 DVI Router:
 1. Connect outputs from your available DVI sources to DVI inputs 1 through 8 on the MatrixPRO router.
 2. Connect MatrixPRO router outputs 1 through 8 to DVI inputs on your selected destination devices.
 3. (Optional) For Ethernet connections, a totally “local” network is recommended, without IP connections to the outside world.
 - a. Using an Ethernet cable, connect the MatrixPRO’s Ethernet port to an Ethernet Hub or Switch.
 - b. Connect Ethernet Hub or Switch to the desired peripheral Ethernet devices, such as remote MatrixPRO panels or an Encore Controller.
 4. (Optional) Connect the MatrixPRO’s RS-232 port to an external RS-232 device, such as a PC.

Please continue with Chapter 4, [“Operation”](#) on page 29.

3. Installation

Signal Installation

4. Operation

*MatrixPRO*TM

In This Chapter

This chapter provides detailed operating instructions for the MatrixPRO 8x8 DVI Router. The following topics are discussed:

- [Control Overview](#)
- [Power-Up Initialization](#)
- [Menu Tree](#)
- [Menu System Overview](#)
- [Quick Function Reference](#)
- [Using the Main Menu](#)
- [MatrixPRO Operating Procedures](#)

4. Operation

Control Overview

Control Overview

There are several ways to control the MatrixPRO 8x8 DVI Router:

- The front panel is available for status and control using the display, the **ADJUST** knob and the two “navigation” buttons (**SEL** and **ESC**). These controls enable you to configure the system, to save and recall presets and to view system status. Channel routing is performed using the front panel “**Input**” and “**Output**” buttons.
- A second means of control is via the MatrixPRO 8x8 DVI Router control software. The GUI interfaces with the router via RS-232 or Ethernet.
- Barco manufactures an optional Remote Control Switch Panel for controlling the router remotely via Ethernet. Refer to the “**Remote Control Panel User’s Guide**” for details.
- The unit can be controlled remotely by Barco controllers (such as Encore) or by third-party controllers.

Power-Up Initialization

After plugging in the MatrixPRO 8x8 DVI Router, locate the power switch on the back of the chassis, and turn the power ON. After a brief interval, the following actions occur:

- All LEDs on the front panel light briefly.
- The display shows the **Main Menu**.
- The last state of the panel at the time of power-down (as stored in non-volatile memory) is recalled to the system.
- Output 1 lights.

Menu Tree

The figure below illustrates the MatrixPRO 8x8 DVI Router **Menu Tree**. Use this diagram for reference throughout this chapter.

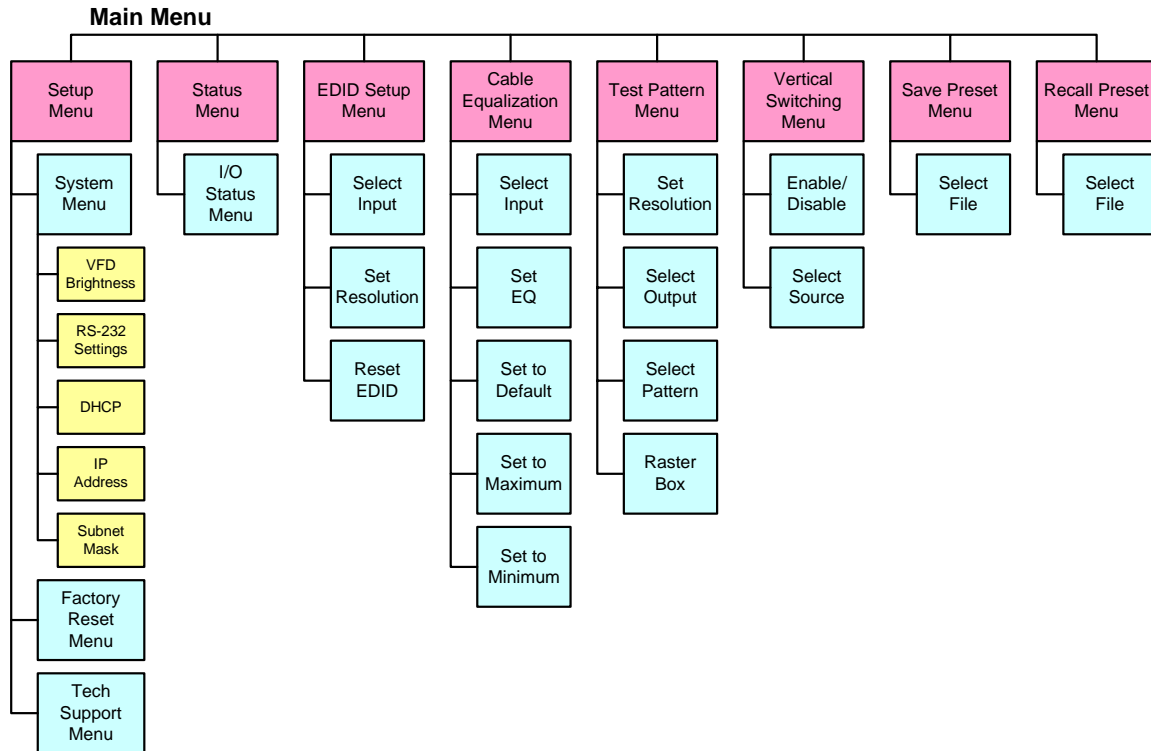

Figure 4-1. MatrixPRO 8x8 DVI Router Menu Tree

4. Operation

Menu System Overview

Menu System Overview

This section lists the rules and conventions for using the MatrixPRO 8x8 DVI Router's menu system. The figure below illustrates a sample menu:



Figure 4-2. Test Pattern Menu (sample)

Please note the following important rules and conventions:

- The top line names the current menu, in all capital letters.
- Subsequent lines typically display two fields:
 - ~ For a listed **function**, the left-hand field names the function and the right-hand field is the function's current parameter or value.

Note

A function listed in brackets (e.g., **[N81]**) is factory preset and cannot be adjusted.

- ~ For a listed **sub-menu**, the left-hand field names the sub-menu that you can access, and the right-hand field displays the double arrow (>>), indicating that a sub-menu is available.
- The "navigation" **cursor** (>) in the left-hand column indicates the current line on which action can be taken. This arrow "scrolls" as you rotate the knob.
- Scrolling:
 - ~ Turn the **ADJUST** knob counter-clockwise (**CCW**) to scroll down.
 - ~ Turn the **ADJUST** knob clockwise (**CW**) to scroll up.
- To enter a sub-menu, scroll to the desired line and press **SEL**.

Note

Throughout this chapter, the term "**select**" is used as an abbreviation for "scroll to a selected menu line and press the **SEL** button."

▲ Select the **Raster Box** field to ...

- To change a parameter, scroll to the desired line and press **SEL**. The cursor changes to the "edit" cursor (#). Use the **ADJUST** knob to modify the parameter.
- To accept a parameter or value, press **SEL**. The edit cursor changes back to the navigation cursor.
- In the "edit" mode, to exit (or cancel) without changing the original parameter, press **ESC**.
- To navigate back up the menu structure, press **ESC**. Each press takes you back up the menu tree by one level.

- The **SEL** button is also used to answer “**Yes**” to certain menu queries. The **ESC** button is also used to answer “**No**” to certain menu queries.

Note

The display itself is four lines high, and the **ADJUST** knob is used to scroll through the various menu lines. Throughout this chapter, *entire* menus will be shown for clarity — rather than a series of four-line sections.

4. Operation

Quick Function Reference

Quick Function Reference

Use the following table to quickly access the proper menu for a specific function.

Table 4-1. MatrixPRO Quick Function Reference Table

How to:	Use the Following:	Page
Add input or output to a group	Working with Groups	page 51
Adjust RS-232 baud rate	RS-232 Settings Menu	page 37
Adjust VFD (Display) brightness	VFD Brightness	page 36
Blank a route	Clearing a Route	page 49
Change IP address	IP Address	page 37
Check router status	Checking Router Status	page 49
Choose vertical switching source	Vertical Switching Menu	page 45
Clear a route	Clearing a Route	page 49
Create a group	Working with Groups	page 51
Display system input/output status	Status Menu	page 40
Display Tech Support phone number	Tech Support Menu	page 39
Enable or disable DHCP	DHCP	page 37
Enable or disable the raster box	Using the Raster Box	page 45
Enable or disable vertical switching	Vertical Switching Menu	page 45
Mute an output (RGB Mute)	Using RGB Mute	page 50
Perform a multi-take	Performing a Multi-Take	page 49
Perform a take	Performing a Take	page 48
Pre-select a test pattern	Using the Test Pattern	page 44
Program EDID resolution	EDID Resolution Menu	page 41
Recall a router input/output configuration file	Recall Configuration Menu	page 47
Remove input or output from a group	Working with Groups	page 51
Reset system to factory defaults	Factory Reset Menu	page 39
Route a test pattern	Routing a Test Pattern	page 50
Save a router input/output configuration file	Save Configuration Menu	page 46
Set cable equalization	Cable Equalization Menu	page 42
Set test pattern resolution	Using the Test Pattern	page 44
Unlock the control panel	Unlocking the Control Panel	page 52
Use the menu system	Menu System Overview	page 32

Using the Main Menu

The figure below illustrates the **Main Menu**:



Figure 4-3. MatrixPRO Main Menu

The **Main Menu** provides access to all MatrixPRO menus and sub-menus:

- Select **Setup** to access the **Setup Menu**, which enables you to adjust system parameters, perform a factory reset or obtain the Tech Support number. Refer to the "[Setup Menu](#)" section on page 36 for details.
- Select **Status** to display the **Status Menu**, which enables you to check all current system routes. Refer to the "[Status Menu](#)" section on page 40 for details.
- Select **EDID Setup** to display the **EDID Resolution Menu**, which enables you to program the router's input EDID resolution. Refer to the "[EDID Resolution Menu](#)" section on page 41 for details.
- Select **Cable Equal** to display the **Cable Equalization Menu**, which enables you to adjust input cable equalization. Refer to the "[Cable Equalization Menu](#)" section on page 42 for details.
- Select **Test Pattern** to display the **Test Pattern Menu**, which enables you to select a test pattern and enable/disable the raster box. Refer to the "[Test Pattern Menu](#)" section on page 43 for details.
- Select **Vertical Switch** to display the **Vertical Switching Menu**, which allows you to enable or disable vertical interval switching, and select an input lock source. Refer to the "[Vertical Switching Menu](#)" section on page 45 for details.
- Select **Save Preset** to display the **Save Configuration Menu**, which enables you to save the current router configuration to one of eight files. Refer to the "[Save Configuration Menu](#)" section on page 46 for details.
- Select **Recall Preset** to display the **Recall Configuration Menu**, which enables you to recall a saved router configuration from one of eight files. Refer to the "[Recall Configuration Menu](#)" section on page 47 for details.

4. Operation

Using the Main Menu

Setup Menu

From the **Main Menu**, select **Setup** to display the **Setup Menu**:



Figure 4-4. MatrixPRO Setup Menu

The **Setup Menu** enables you to adjust system parameters, perform a factory reset or obtain the Tech Support number. Following are descriptions of each menu function:

- [System Menu](#)
- [Factory Reset Menu](#)
- [Tech Support Menu](#)

System Menu

From the **Setup Menu**, select **System** to display the **System Menu**.

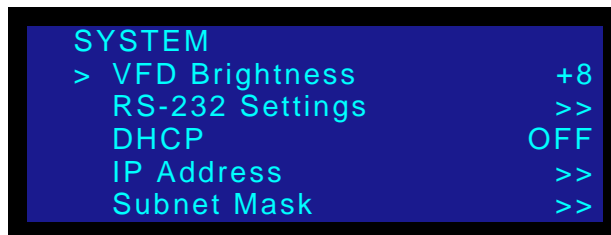

Figure 4-5. MatrixPRO System Menu

Each menu is explained in detail below:

- [VFD Brightness](#)
- [RS-232 Settings Menu](#)
- [DHCP](#)
- [IP Address](#)
- [Subnet](#)

VFD Brightness

On the **System Menu**, the **VFD Brightness** function allows you to adjust the vacuum fluorescent display (VFD) brightness.

- To change VFD brightness:
 1. On the **System Menu**, scroll to the **VFD Brightness** line and press **SEL**.
 2. Rotate the knob to select the desired brightness. Values range from **0** to **15**.
 3. Press **SEL** to accept the new setting.

RS-232 Settings Menu

From the **System Menu**, select **RS-232 Settings** to display the **RS-232 Settings Menu**. This menu enables you to adjust the settings of the rear panel's **Serial Port**.



Figure 4-6. MatrixPRO RS-232 Settings Menu

Please note:

- Baud rate choices are: 2400, 4800, 9600, 19200, 38400, 57600, and 115200.
 - Parameters are fixed at **N81** (one start bit, eight data bits, one stop bit and no parity bit), and cannot be adjusted.
- To change the RS-232 port's baud rate:
1. On the **RS-232 Settings Menu**, press **SEL**.
 2. Rotate the knob to select the desired baud rate.
 3. Press **SEL** to accept the new value.

DHCP

On the **System Menu**, the **DHCP** function allows you to enable or disable DHCP.

- When enabled, the router's IP address and subnet mask are set by your network's DHCP server, and cannot be changed locally. Use this setting when connected to an external controller, such as Encore.
 - When disabled, the system's static IP address and subnet mask are active, and can be changed locally.
- To change the DHCP setting:
1. On the **System Menu**, scroll to the **DHCP** line and press **SEL**.
 2. Rotate the knob to select the desired setting (on or off).
 3. Press **SEL** to accept the new setting.

IP Address

From the **System Menu**, select **IP Address** to display the **IP Address Menu**.



Figure 4-7. MatrixPRO IP Address Menu

When this menu item is selected (and DHCP is off), the cursor (^) is positioned under the right-most digit in the address.

4. Operation

Using the Main Menu

Please note:

- The default IP address is **192.168.000.243**.
 - If DHCP is on, the IP address appears between brackets, and cannot be adjusted.
- To adjust the IP address:
1. Ensure that DHCP is off.
 2. On the **IP Address Menu**, rotate the knob to change the value of the digit to which the cursor is pointing.
 3. Press **SEL** to update the number and advance the cursor one place to the left.
 4. Repeat steps **1** and **2** as required. Note that repeatedly pressing **SEL** advances through the digits, skipping the decimal-point field delimiter.
 5. To accept the new IP address, press **ESC** at any time to exit the menu. The new IP address will take effect at this point.

Subnet

From the **System Menu**, select **Subnet Mask** to display the **Subnet Menu**.



Figure 4-8. MatrixPRO Subnet Menu

When this menu item is selected (and DHCP is off), the cursor (^) is positioned under the right-most digit in the address.

Please note:

- The default Subnet Mask is **255.255.255.000**.
 - If DHCP is on, the Subnet Mask appears between brackets, and cannot be adjusted.
- To adjust the Subnet Mask:
1. Ensure that DHCP is off.
 2. On the **Subnet Menu**, rotate the knob to change the value of the digit to which the cursor is pointing.
 3. Press **SEL** to update the number and advance the cursor one place to the left.
 4. Repeat steps **1** and **2** as required. Note that repeatedly pressing **SEL** advances through the digits, skipping the decimal-point field delimiter.
 5. To accept the new Subnet Mask, press **ESC** at any time to exit the menu. The new Subnet Mask will take effect at this point.

Factory Reset Menu

From the **Setup Menu**, select **Factory Reset** to display the **Factory Reset Menu**.

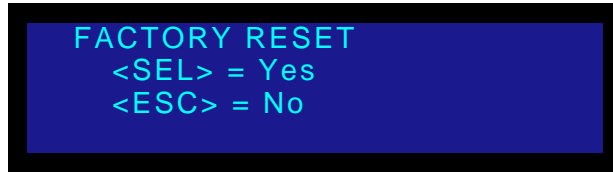

Figure 4-9. MatrixPRO Factory Reset Menu

When you perform a factory reset, the following actions occur:

- All output channels are blanked, and all routes are cancelled.
- The serial communications baud rate returns to 115200.
- Vertical interval switching is set to “**Disabled**.”
- The IP address is set to the default value of **192.168.000.243**.
- The Subnet Mask is reset to the default value of **255.255.255.000**.
- DHCP is set to **Off**.
- EDID resolution is reprogrammed to the default value of **1400x1050 @59.94**.
- All “preset” configuration files are cleared.
- The test pattern is reset to the default **H Ramp** type, and the default output resolution of **1400x1050 @59.94**.

■ To perform a factory reset:

1. From the **Setup Menu**, select **Factory Reset**.
2. On the **Factory Reset Menu**, select the desired function:
 - ~ Press **SEL** to perform a factory reset. A confirmation message is shown, and the system is rebooted.
 - ~ Press **ESC** to return safely to the previous menu.

Tech Support Menu

From the **Setup Menu**, select **Tech Support** to display the **Tech Support Menu**:



Figure 4-10. MatrixPRO Tech Support Menu

The **Tech Support Menu** shows the installed version of software, as well as the phone number for factory support. In Appendix C, refer to the “[Contact Information](#)” section on page 102 for additional information.

4. Operation

Using the Main Menu

Status Menu

From the **Main Menu**, select **Status** to display the **Status Menu**:

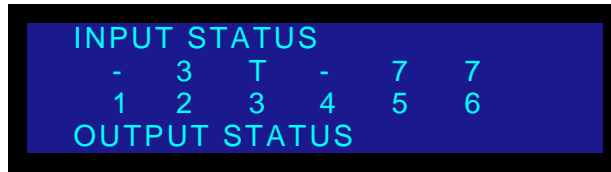

Figure 4-11. MatrixPRO Status Menu (sample)

This menu shows all current input-to-output assignments (or “routes”). Any input can be routed to any combination of the 8 outputs. Please note:

- When you first display the **Status Menu**, the lowest 6 of the 8 input/output assignments are shown.
- Use the **ADJUST** knob to scroll through the input/output display.
 - ~ Turn the knob clockwise (CW) to scroll the display down the list of assignments.
 - ~ Turn the knob counter-clockwise (CCW) to scroll the display up the list of assignments.
- The display updates in real time whenever a new route is performed (when the **TAKE** button is pressed).
- On the menu:
 - ~ Numbers on the lower **OUTPUT STATUS** line are fixed, and do not change. These numbers represent the 8 output channels.
 - ~ Numbers on the upper **INPUT STATUS** line show the input that is routed to the output listed directly below.
 - ~ The label “**T**” indicates that a **Test Pattern** is routed to the selected output.
 - ~ The label “**B**” indicates that **RGB Mute** is enabled for the selected output.
 - ~ The label “**-**” indicates that the selected output is blanked. This output is inactive.

EDID Resolution Menu

From the **Main Menu**, select **EDID Setup** to display the **EDID Resolution Menu**:



Figure 4-12. MatrixPRO EDID Resolution Menu (sample)

The **EDID Resolution Menu** enables you to set MatrixPRO's preferred EDID resolution, either for all 8 inputs simultaneously, or individually for a particular input.

Important

This menu is designed for advanced users only. Do not reprogram the EDID unless it is necessary.

EDID (Extended Display Identification Data) is a VESA standard data format that contains information about a display device and its capabilities, including the preferred (and the allowed) resolutions of the device. Please note:

- By default, MatrixPRO is programmed to accept all VESA standard EDID resolutions from VGA through UXGA.
- MatrixPRO's EDID file is stored in non-volatile memory.
- The EDID file is read by a computer's DVI graphics card when its DVI output is connected to any MatrixPRO input channel during the computer's boot-up cycle.
- MatrixPRO's EDID information can be read with the power on or off.

■ Use the following steps to program EDID:

1. From the **Main Menu**, select **EDID Setup** to display the **EDID Resolution Menu**, a sample of which is shown below.
2. Scroll to line 2 (the **"Input"** line), and press **SEL** to select either all inputs, or an individual input that you wish to program.
3. Scroll to line 3 (the **"Format"** line), which displays the current EDID resolution of the input selected on line 2. Press **SEL** to display the edit cursor (#). Please note:
 - ~ If **All** is selected and all resolutions match, the "global" resolution is shown on the line.
 - ~ If **All** is selected and all resolutions do not match, the label **"Not All Same"** is shown.
 - ~ If an individual input is selected, its resolution is shown.
4. Rotate the **ADJUST** knob and select the preferred resolution.

Note

If you selected **All**, but all resolutions currently do not match, you will overwrite all "differing" resolutions with a new "global" resolution.

5. Press **SEL** to "accept" the new resolution, or press **ESC** to return to the current resolution without making changes. If you accept the new resolution, the message **"Programming EDID ..."** will appear.

4. Operation

Using the Main Menu

- (Optional) If desired, scroll to the “**Reset**” line and press **SEL** to reset the EDID resolution for all inputs to the default value of **1400x1050 @59.94**.
- Reboot the computer(s) in order for the new EDID information to be read, and for the new preferred resolution to become available.

Cable Equalization Menu

From the **Main Menu**, select **Cable Equal** to display the **Cable Equalization Menu**.

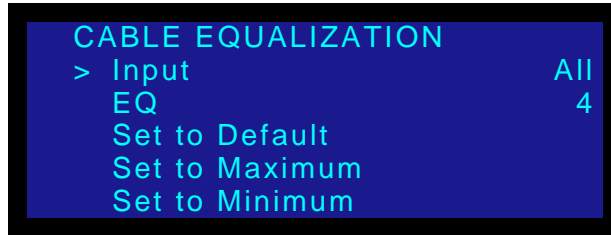

Figure 4-13. MatrixPRO Cable Equalization Menu (sample)

The **Cable Equalization Menu** enables you to adjust input cable equalization parameters either for all 8 inputs simultaneously, or individually for a particular input. Please note:

- The equalization adjustment range is from **0** (short cable equalization) to **15** (long cable equalization).
 - The default value is **4** — configured for “moderate” equalization. In general, this value should be adequate for most users, unless cables longer than 6M are used, and unless your signals are running at high pixel clock rates (e.g., UXGA).
 - Equalization is a subjective “visual” adjustment, which depends on three important factors: cable length, signal quality and cable quality.
- Use the following steps to adjust cable equalization:
- Because equalization is adjusted for all inputs simultaneously, as a recommendation, use cables that are all the same length and quality.
 - Set up a route from a source to a destination. For example:
 - Connect a PC to a selected input.
 - Connect a monitor to a selected output.
 - Perform a “take” from the input to the output.
 - In the **Output Selection Section**, select the desired output.
 - In the **Input Selection Section**, choose the desired input.
 - Press **TAKE**.
 - Ensure that the selected source is visible on the monitor.
 - From the **Main Menu**, select **Cable Equal** to display the **Cable Equalization Menu**.
 - Scroll to line **2** (the “**Input**” line), and press **SEL** to select either all inputs, or an individual input that you wish to program.
 - Scroll to line **3** (the “**EQ**” line), which displays the current equalization value of the input selected on line **2**. Press **SEL** to display the edit cursor (**#**). Please note:
 - ~ If **All** is selected and all equalization values match, the “global” value is shown on the line.

4. Operation

Using the Main Menu

- ~ If **All** is selected and all equalization values do not match, the label "**Not All Same**" is shown.
 - ~ If an individual input is selected, its equalization value is shown.
6. Rotate the **ADJUST** knob and select the desired equalization value.

Note

If you selected **All**, but all equalization values currently do not match, you will overwrite all "differing" values with a new "global" equalization value.

7. Press **SEL** to "accept" the new resolution, or press **ESC** to return to the current value without making changes. If you accept the new value, visually check the quality of the signal on the monitor.
8. As required, repeat step 5 to obtain the optimum quality signal.
9. (Optional) If required:
- ~ Scroll to the "**Set to Default**" line and press **SEL** to reset the equalization value for all inputs to the default value to **4**.
 - ~ Scroll to the "**Set to Maximum**" line and press **SEL** to set the value to **15**.
 - ~ Scroll to the "**Set to Minimum**" line and press **SEL** to set the value to **0**.

Test Pattern Menu

From the **Main Menu**, select **Test Pattern** to display the **Test Pattern Menu**.



Figure 4-14. MatrixPRO Test Pattern Menu (sample)

The **Test Pattern Menu** enables you to perform the following functions:

- Pre-select which test pattern will be displayed when the **TEST PAT** button is routed to an output. One pattern can be set for all outputs, or individual test patterns can be set on an output-by-output basis. The menu itself does not enable the route.
- Set the "global" output resolution of the test pattern.
- Enable the Raster Box for a "test pattern" route already in effect.

Menu instructions are provided in the following sections:

- [Using the Test Pattern](#)
- [Using the Raster Box](#)

4. Operation

Using the Main Menu

Using the Test Pattern

- Use the following steps to pre-select a test pattern:
 1. From the **Main Menu**, select **Test Pattern** to display the **Test Pattern Menu**.
 2. Scroll to line **2** (the “**Resolution**” line), and press **SEL** to display the edit cursor (#).
 3. Rotate the **ADJUST** knob and select the desired “global” test pattern resolution for all outputs.
 4. Press **SEL** to “accept” the new resolution, or press **ESC** to return to the current resolution without making changes.
 5. Scroll to line **3** (the “**Output**” line), and press **SEL** to select either all outputs, or an individual output for which you want to set a test pattern.
 6. Scroll to line **4** (the “**Type**” line), which displays the current test pattern for the output selected on line **3**. Press **SEL** to display the edit cursor (#). Please note:
 - ~ If **All** is selected and test patterns match, the “global” test pattern is shown on the line.
 - ~ If **All** is selected and all test patterns do not match, the label “**Not All Same**” is shown.
 - ~ If an individual output is selected, its test pattern is shown.
 7. Rotate the **ADJUST** knob and select the desired test pattern. Choices are:
 - ~ H Ramp, V Ramp
 - ~ 75% Col Bars, 100% Col Bars
 - ~ 16x16 Grid, 32x32 Grid
 - ~ Burst, 50% Gray
 - ~ Gray Steps 1, Gray Steps 2
 - ~ White, Black, Red, Green, Blue

Note

If you selected **All**, but all test patterns currently do not match, you will overwrite all “differing” patterns with a new “global” test pattern.

8. Press **SEL** to “accept” the new pattern, or press **ESC** to return to the current pattern without making changes. The pattern in *pre-selected* at this point.
9. To route the selected pattern to an output:
 - a. In the **Output Selection Section**, select the desired output.
 - b. Press **TEST PAT**.
 - c. Press **TAKE**.The selected pattern is routed to the selected output only. All other routes are unaffected.
10. To clear the test pattern from the output:
 - a. In the **Output Selection Section**, select the desired output.
 - b. Press **TEST PAT** or select an input.
 - c. Press **TAKE**.

Using the Raster Box

The Raster Box can be enabled/disabled for an output to which a pattern is currently routed, or the Raster Box can be “preset” to appear the next time a test pattern is routed to an output.

- Use the following steps to enable, disable, or preset the Raster Box.
 1. From the **Main Menu**, select **Test Pattern** to display the **Test Pattern Menu**.
 2. Scroll to the “**Raster Box**” line and press **SEL** to display the edit cursor (#).
 3. Rotate the **ADJUST** knob and select the desired state (**ON** or **OFF**).
 4. Press **SEL** to “accept” the new state, or press **ESC** to return to the current state without making changes.

At this point:

- If a test pattern is currently routed to an output and you selected **ON**, the Raster Box will appear.
- If a test pattern is currently routed to an output and you selected **OFF**, the Raster Box will clear.
- If no test patterns are routed to any outputs and you selected **ON**, the Raster Box and the test pattern will appear the next time a “test pattern” route is performed.

Vertical Switching Menu

From the **Main Menu**, select **Vertical Switch** to display the **Vertical Switching Menu**.



Figure 4-15. MatrixPRO Vertical Switching Menu (sample)

The **Vertical Switching Menu** allows you to enable or disable vertical interval switching, and select an input lock source. Please note:

- If the function is disabled, the label “[None]” appears, indicating that the switch occurs the moment **TAKE** is pressed — without waiting for the next frame.
- If the function is enabled and a source is selected, that source is used as the switching timing reference.

Note

The response of a given downstream display device to vertical interval switching depends *entirely* on the implementation of the downstream device, and its response cannot be guaranteed from MatrixPRO.

- Use the following steps to enable or disable vertical switching.
 1. From the **Main Menu**, select **Vertical Switch** to show the **Vertical Switching Menu**.
 2. Scroll to the “**Function**” line and press **SEL** to display the edit cursor (#).

4. Operation

Using the Main Menu

3. Rotate the **ADJUST** knob and select the desired state (**Enabled** or **Disabled**).
4. Press **SEL** to “accept” the new state, or press **ESC** to return to the current state without making changes.
5. To choose a timing source, ensure that the function is enabled. Scroll to the “**Source**” line and press **SEL** to display the edit cursor (#).
6. Rotate the **ADJUST** knob and select the desired source (**Ch. 1** through **Ch 8**).
7. Press **SEL** to “accept” the new source, or press **ESC** to return to the current source without making changes.

Save Configuration Menu

From the **Main Menu**, select **Save Preset** to display the **Save Configuration Menu**:



Figure 4-16. MatrixPRO Save Configuration Menu (sample)

The router’s current state (all input and output routes) can be saved to one of eight configuration files (or “presets”). For example, you can save a configuration in which all outputs are “blanked,” or a configuration in which a test pattern is routed to all outputs.

- Use the following steps to save a router configuration:
 1. From the **Main Menu**, select **Save Preset** to display the **Save Configuration Menu**.
 2. Scroll to the “**File**” line and press **SEL** to display the edit cursor (#).
 3. Rotate the **ADJUST** knob and select the desired file (**1** through **8**).
 4. Press **SEL** to save the configuration in the selected file, or press **ESC** to exit the function without saving a configuration. When you press **SEL**, the message “**Saving**” appears.

The input/output configuration is now saved, and can be recalled using the “recall” configuration procedure. Refer to the [“Recall Configuration Menu”](#) section on page 47 for details.

Recall Configuration Menu

From the **Main Menu**, select **Recall Preset** to display the **Recall Configuration Menu**:



Figure 4-17. MatrixPRO Recall Configuration Menu (sample)

A stored “preset” (configuration file) containing all input and output routes can be recalled from memory and applied instantly to the router’s current state. For example, you can recall a configuration in which all outputs are “blanked,” or a configuration in which a test pattern is routed to all outputs.

- Use the following steps to recall a router configuration:
 1. From the **Main Menu**, select **Recall Preset** to display the **Recall Configuration Menu**.
 2. Scroll to the “**File**” line and press **SEL** to display the edit cursor (#).
 3. Rotate the **ADJUST** knob and select the desired file (**1** through **8**). Note that if a file is empty, the label “**(EMPTY)**” appears.
 4. Press **SEL** to recall the configuration from the selected file, or press **ESC** to exit the function without recalling a configuration. When you press **SEL**, the message “**Recalling**” appears, and the router is instantly updated with the recalled configuration.

4. Operation

MatrixPRO Operating Procedures

The following operating procedures are covered in this section:

- [Performing a Take](#)
- [Performing a Multi-Take](#)
- [Clearing a Route](#)
- [Checking Router Status](#)
- [Routing a Test Pattern](#)
- [Using RGB Mute](#)
- [Working with Groups](#)
- [Unlocking the Control Panel](#)

Performing a Take

■ Use the following steps to perform a take:

1. In the **Output Selection Section**, select the output channel (destination) to which you want to route an input. Please note:
 - ~ If an input is already associated with that output on a **completed route**, the input button lights steady.
 - ~ If an input is already associated with that output on a **pending route**, the input button blinks.
 - ~ If there is no input associated with the output, the output is “blanked” and no input buttons will light.
2. In the **Input Selection Section**, select a new input source. The selected (pending) input button blinks.
3. Press **TAKE**. The selected input button lights steadily, and the **Status Menu** updates accordingly.
4. Repeat from step 1 to perform another take.

Please note the following important points:

- To cancel a route *before* pressing **TAKE**, press **ESC**, or press the blinking input button to “de-select” it. The previous route remains in effect.
- A “pending” route remains pending — even if you switch to a different output — until **TAKE** or **ESC** is pressed. This rule applies to channel routes, test pattern routes, and RGB Mute routes.
 - ▲ If you pend a route to output 1 (e.g., **input 5 to output 1**), then you switch to output 2, and then you switch back to output 1 — the selected route is still pending (and input 5 will still be blinking).

Performing a Multi-Take

This procedure enables you to perform multiple input-to-output routes with one “take.”

- Use the following steps to perform a multi-take:
 1. In the **Output Selection Section**, select the output channel (destination) to which you want to route an input.
 2. In the **Input Selection Section**, select a new input source. The selected (pending) input button blinks.
 3. Repeat steps 1 and 2 for as many input-to-output routes as desired.
 4. Press **TAKE**. All selected routes are performed, and the **Status Menu** updates accordingly.
 5. Repeat from step 1 to perform another multi-take.

Clearing a Route

The “clear” procedure applies similarly to channel, test pattern and RGB Mute routes.

- Use the following steps to clear (or “blank”) a route:
 1. In the **Output Selection Section**, select the output channel that you want to clear. The button lights along with its currently assigned input.
 2. In the **Input Selection Section**, press the currently assigned input button, which will begin to blink. Please note:
 - ~ For test pattern routes, press the **TEST PAT** button.
 - ~ For RGB Mute routes, press the **RGB MUTE** button.
 3. Press **TAKE**. The selected input button’s light turns off, indicating that the input has been cleared and the output channel has been blanked. Please note:
 - ~ For channel and test pattern routes, on the **Status Menu**, the label “-” appears for the selected output channel.
 - ~ For RGB Mute routes, the previously selected channel route is restored.

Note

You can perform a “multi-clear” in the same manner as you performed a multi-take.

Checking Router Status

There are several ways to check router status:

- Use the **Status Menu**. Refer to the [“Status Menu”](#) section on page 40 for details.
- In the **Output Selection Section**, select the output channel that you want to check. The button lights along with its currently assigned input. If no button lights (including the **TEST PAT** and **RGB MUTE** buttons), the output is blanked.
- Press and hold a button in the **Output Selection Section** to check if any “groups” have been configured that include the selected output.

4. Operation

Routing a Test Pattern

Operationally, the **TEST PAT** button is treated just like any other input on the router.

■ Use the following steps to route a test pattern:

1. Ensure that you have pre-selected the desired test pattern. Refer to the [“Using the Test Pattern”](#) section on page 44 for instructions.

Note

Remember that the Raster Box can also be preset. Refer to the [“Using the Raster Box”](#) section on page 45 for details.

2. In the **Output Selection Section**, select the output channel (destination) to which you want to route a test pattern.
3. Press **TEST PAT**. The button blinks.
4. Press **TAKE**. The **TEST PAT** button lights steadily, and the **Status Menu** updates accordingly with a “T.”
5. Repeat from step 1 to route another test pattern.

Please note the following important points:

- To cancel a route *before* pressing **TAKE**, press **ESC**, or press the blinking **TEST PAT** button. The previous route remains in effect.
- A test pattern route can be cleared in the same manner that a “standard” route is cleared. Refer to the [“Clearing a Route”](#) section on page 49 for details.
- With an “active” test pattern route in place, you can change the test pattern using the **Test Pattern Menu**. Refer to the [“Using the Test Pattern”](#) section on page 44 for details.

Using RGB Mute

The RGB Mute feature enables you to blank a channel’s output video while leaving the channel’s sync signals running to the monitor.

■ Use the following steps to “mute” an output:

1. In the **Output Selection Section**, select the output channel that you wish to mute. The input channel associated with the selected output lights.
2. Press **RGB MUTE**. The button blinks.
3. Press **TAKE**. The **RGB MUTE** button lights steadily, and the **Status Menu** updates accordingly with a “B.”
4. Repeat from step 1 to mute another output channel.

Please note the following important points:

- To cancel the function *before* pressing **TAKE**, press **ESC**, or press the blinking **RGB Mute** button. The previous route remains in effect.
- An RGB Mute route can be cleared in the same manner that a “standard” route is cleared. Once performed, the previously selected channel route is restored. Refer to the [“Clearing a Route”](#) section on page 49 for details.

Working with Groups

The MatrixPRO 8x8 DVI Router enables you to set up groups of input and output channels, in order to prevent certain inputs from being switched to selected outputs. Once established, routes can only be performed within the group.

The following rules apply:

- A minimum of two inputs and two outputs are required to form a group, but up to 8 can be included in a group.
- Multiple groups can be configured on the panel (e.g., 2 groups of 4 outputs each).
- Inputs and outputs can only be in one group at a time.
- When an output within a group is selected, you can only route the inputs currently assigned to that group. Inputs “outside” the group cannot be selected.
- To check the “members” of a group, press and hold a button in the **Output Selection Section**. All assigned group input and output buttons will light. If no buttons light, that output is not included in a group.

Note

Grouping inputs and outputs does not establish a route. The input source for a particular output still must be established using the standard “take” procedure.

- Use the following steps to create an input/output group:
 1. In the **Output Selection Section**, press and *hold* the first output that you want to be in the group.
 2. While holding the output, press the buttons for the other inputs and outputs that you wish to be in the group. Each button remains lit after it is pressed.
 3. Release the output button (that you pressed in step 1). The group is now configured, and routes can now only be performed within the group.
 4. Repeat from step 1 to configure additional groups. Note that pressing and holding any output button within the group lights all group member buttons.
- Use the following steps to add an input or output to an existing group:
 1. In the **Output Selection Section**, press and *hold* any output within the selected group. All group member buttons light.
 2. While holding the output, press the buttons for the other (unlit) inputs and outputs that you wish to add to the group. Each button remains lit after it is pressed.
 3. Release the output button (that you pressed in step 1). The group is now re-configured.
 4. Repeat from step 1 to add additional members to the group.
- Use the following steps to remove an input or output from an existing group:
 1. In the **Output Selection Section**, press and *hold* any output within the selected group. All group member buttons light.
 2. While holding the output, press the buttons for the (lit) inputs and outputs that you wish to remove from the group. Each button turns off after it is pressed.
 3. Release the output button (that you pressed in step 1). The group is now re-configured.
 4. Repeat from step 1 to remove additional members from the group.

4. Operation

MatrixPRO Operating Procedures

Unlocking the Control Panel

The control panel can be locked in the following ways:

- Via serial communications using the **FPLock** command. In Appendix B, refer to the "[FPLOCK en](#)" section on page 95 for details.
- From the GUI, using the **Front Panel Lockout** check box on the **Setup Tab**. In Chapter 5, refer to the "[Using the Setup Tab](#)" section on page 75 for details.

When the panel is locked, the following message appears on the display:



Figure 4-18. MatrixPRO Lockout Message

The panel can be unlocked in the following ways:

- Via serial communications using the **FPLock** command.
 - From the GUI, using the **Front Panel Lockout** check box on the **Setup Tab**.
 - From the front panel itself, using the following procedure.
- Use the following steps to unlock the control panel (from the panel itself).
1. Press **SEL + ESC + TAKE** buttons simultaneously.

After a brief pause, front panel control is restored and the **Main Menu** is displayed.

5. GUI Installation and Operation

The logo for MatrixPRO, featuring the word "MatrixPRO" in a bold, purple, sans-serif font with a trademark symbol (TM) to the right. A blue horizontal line is positioned below the text.

In This Chapter

This chapter describes the installation and operation of the MatrixPRO 8x8 DVI Router interactive Control GUI. The following topics are discussed:

- [Control GUI Installation](#)
- [Running the GUI](#)
- [GUI Overview](#)
- [Using the Menu Bar](#)
- [Using the Video Switching Tab](#)
- [Using the Labeling Tab](#)
- [Using the Grouping Tab](#)
- [Using the Sequencing Tab](#)
- [Using the Setup Tab](#)
- [Using the "About" Tab](#)

5. GUI Installation and Operation

Control GUI Installation

Control GUI Installation

The MatrixPRO 8x8 DVI Router Control GUI is an interactive Graphical User Interface application designed to assist users with MatrixPRO operation. The software is only available via download from either the Barco Folsom website or the FTP server.

Note

The MatrixPRO Control GUI software is included within the “**System Software**” download.

The following step-by-step instructions will enable you to install the MatrixPRO Control GUI in a Windows® 2000 or XP PC. Use the figures for reference during the procedure.

- Use the following steps to install the MatrixPRO control GUI:

Note

This procedure will *not* be required if you have already downloaded system software — for purposes of upgrading the MatrixPRO’s code. In this case, the GUI is automatically installed when you run the **System Software** executable.

1. Verify that your PC meets all hardware and software requirements for running the GUI. These are identical to the requirements for downloading software. In Chapter 6, refer to the “[Hardware Requirements](#)” section on page 78 and the “[Software Requirements](#)” section on page 78 for details.
2. Download the MatrixPRO software. In Chapter 6, refer to the “[Downloading Software](#)” section on page 79 for instructions.
3. With the download complete, navigate to the target folder and double-click the **EXE** to launch the installation shield.
4. Follow the prompts to install the upgrade package in the default folder. At the conclusion of the procedure, a new path will be created under **Start > Programs > Barco Folsom**.

5. GUI Installation and Operation

Control GUI Installation

5. Double-click on the **MatrixPRO_DVI_8x8_Rev ###.exe** icon to display the **Welcome Dialog**.

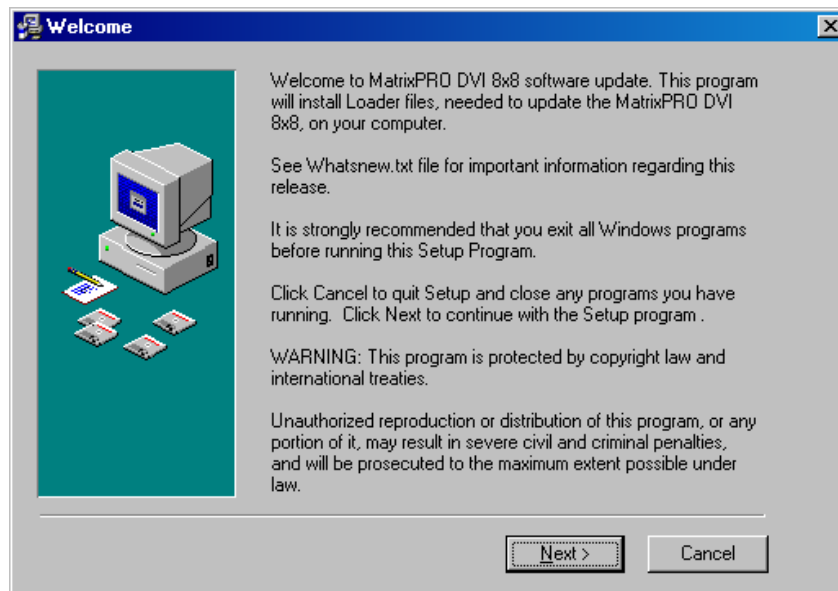

Figure 5-1. Welcome Dialog

6. Click **Next** to display the **Choose Destination Dialog**:

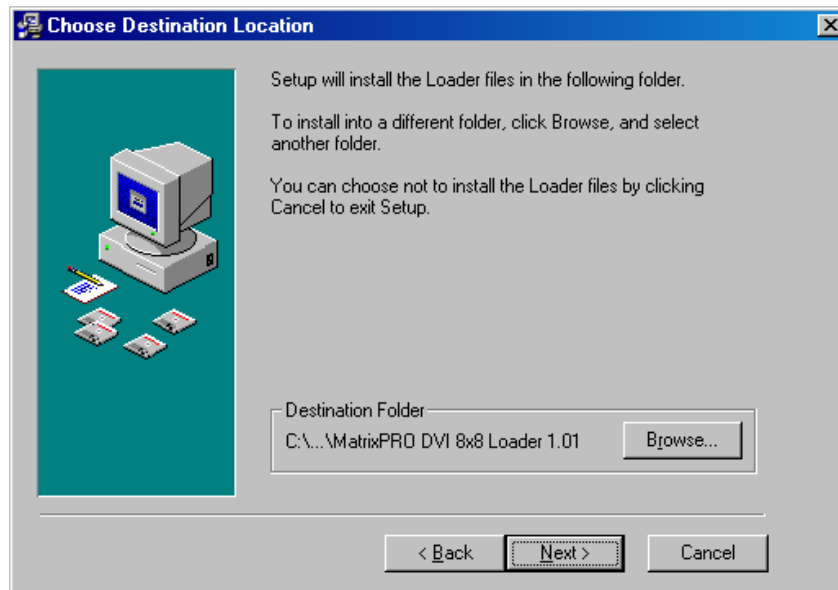

Figure 5-2. Choose Destination Dialog

If desired, click **Browse** to select a different destination folder than the default.

5. GUI Installation and Operation

Control GUI Installation

- Click **Next** to display the **Start Installation Dialog**. The setup application is now ready to install the MP Control application.

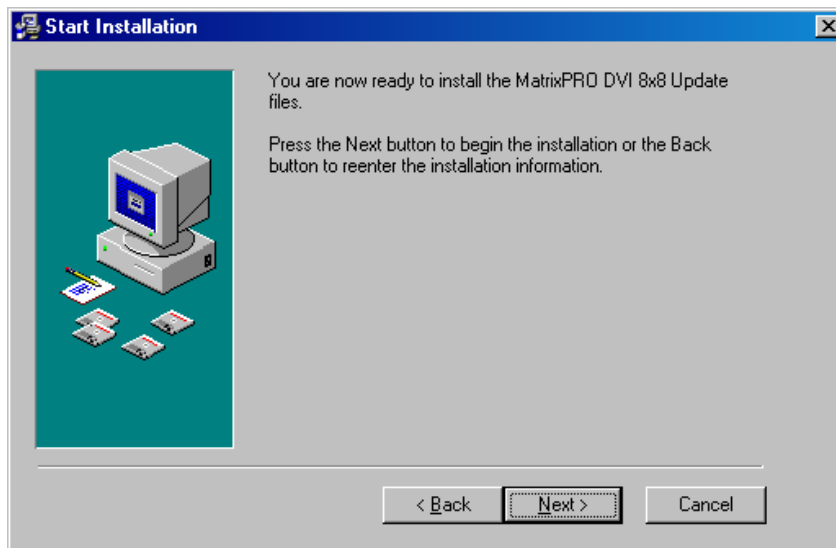

Figure 5-3. Start Installation Dialog

- Click **Next** to begin installation. After successfully installing all required files to the directory as specified, the **Installation Complete Dialog** appears:

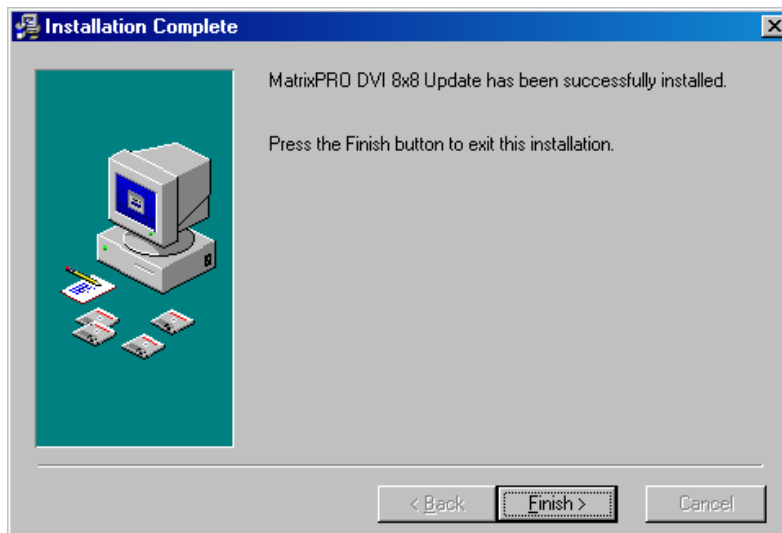

Figure 5-4. Installation Complete Dialog

- Click **Finish** to exit the installation setup procedure. Please note:
 - ~ The application can be reached from the **Start Menu**:
Start > Programs > Barco Folsom > MatrixPRO DVI 8x8 Software #.## > MatrixPRO DVI GUI
 - ~ If desired, create a shortcut to the MatrixPRO DVI GUI on your desktop, in the normal manner.

Running the GUI

- Use the following steps to run the MatrixPRO GUI:
 1. Turn on MatrixPRO and wait for a complete system boot up.
 2. Ensure that your PC (or laptop) is connected to MatrixPRO either via serial (RS-232) or via Ethernet.
 - ~ For **Serial Connection**:
 - Connect the MatrixPRO's **Serial** port to an available serial (RS-232) port on your laptop or PC.
 - Ensure that MatrixPRO's baud rate is set to 115200. In Chapter 4, refer to the "[RS-232 Settings Menu](#)" section on page 37 for instructions.
 - ~ For **Ethernet Connection**:
 - Connect MatrixPRO's Ethernet port to a Hub or Switch.
 - Connect the Ethernet Hub or Switch to your PC. Remember that a totally "local" network is recommended, without IP connections to the outside world.
 3. On your PC, run the Control GUI application by clicking **Start > Programs > Barco Folsom > MatrixPRO DVI 8x8 Software #.## > MatrixPRO DVI GUI**.

The **MP Control Dialog** appears:

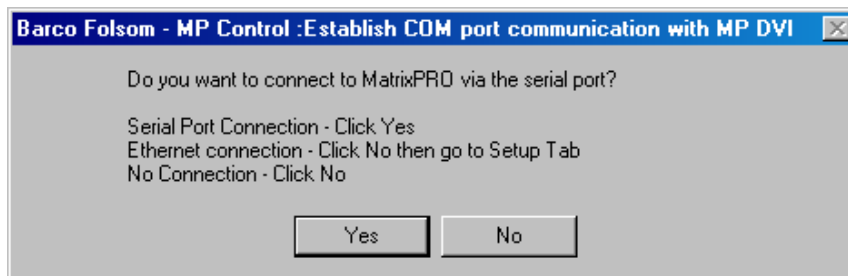

Figure 5-5. MP Control Dialog

4. Select the desired connection type:
 - ~ Click **Yes** to connect via serial communications.
 - ~ Click **No** to connect via Ethernet.

With all conditions for a proper connection met, the GUI will appear. Please continue with the "[GUI Overview](#)" section on page 59.

If you experience trouble with the connection, refer to the "[Connection Troubleshooting](#)" section on page 58 for further instructions.

Please note the following important points regarding control and connection:

- Only one Ethernet socket is available — so only one remote GUI can be accommodated at one time. However, MatrixPRO can still be controlled via RS-232 serial commands or the Front Panel while simultaneously being controlled over Ethernet (by devices such as Encore and remote control panels).
- If the unit is controlled by other sources, press **Read from MatrixPRO** on the **Video Switching Tab** as necessary to find the current status of the MatrixPRO.

5. GUI Installation and Operation

Running the GUI

- If an operation (such as a route) is not completed by using a **TAKE** command via the Front Panel or via serial commands, the GUI can fall into an unknown state and operation may become unreliable.
- To prevent any operational difficulties or conflicts, it is recommended that you activate the **Front Panel Lockout** feature on the **Setup Tab**.

Connection Troubleshooting

If you experienced difficulty connecting to the GUI (in step 4 in the "[Running the GUI](#)" section), please note the following important troubleshooting steps:

- To troubleshoot **Serial** connection problems:
 1. If you selected **Yes** in step 4, and MatrixPRO's baud rate was not set to 115200 (or the wrong PC port was connected to MatrixPRO), a series of error messages will be shown.
 2. Click **OK** to clear each message, after which the GUI will appear.
 3. Check the cable and COM port connections between your PC and MatrixPRO.
 4. On MatrixPRO, reset the baud rate to 115200. In Chapter 4, refer to the "[RS-232 Settings Menu](#)" section on page 37 for instructions.
 5. On the GUI, in the **Menu Bar**, click **Serial Port > Connect to MatrixPRO DVI** to establish communications.
- To troubleshoot **Ethernet** connection problems:
 1. If you selected **No** in step 4, and an Ethernet connection could not be found (or an IP address mismatch exists), an error message will be shown.
 2. Click **OK** to clear the message, after which the GUI will appear.
 3. Check all Ethernet connections.
 4. Make a note of MatrixPRO's IP address. In Chapter 4, refer to the "[IP Address](#)" section on page 37 for instructions.

Note

The default IP address is **192.168.000.243**.

5. On the GUI, click the **Setup Tab**.
6. In the **IP Address** field, enter MatrixPRO's IP address.
7. Click the **Change IP Address** button.
8. Click the **Ethernet** radio button to establish communications.

GUI Overview

The MatrixPRO 8x8 DVI Router Control GUI consists of a main window, a menu bar and six function tabs. Each is explained in the following sections.

Please note:

- The GUI is used by multiple Barco products. When connected to a specific hardware chassis, functions (such as input and output buttons) are dynamically enabled or disabled accordingly.
- “**Active**” controls and buttons are labeled in black letters.
- “**Inactive**” controls and buttons are grayed out.

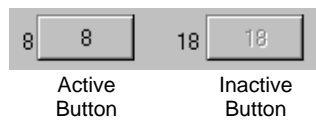

Figure 5-6. Active and Inactive Controls

- ▲ In the case of the MatrixPRO 8x8 DVI Router, input channels 9 through 20, and output channels 9 through 20 are grayed-out on screen.

5. GUI Installation and Operation

Using the Menu Bar

Using the Menu Bar

The figure below illustrates the MatrixPRO GUI's **Menu Bar**:



Figure 5-7. Menu Bar

Each menu is described in detail below:

- [File Menu](#)
- [Serial Port Menu](#)
- [About Menu](#)

File Menu

The figure below illustrates the **File Menu**:

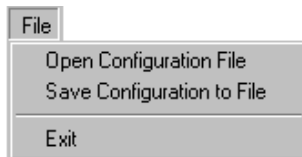

Figure 5-8. File Menu

The following functions are provided:

- Click **File > Open Configuration File** to recall a configuration file (of MatrixPRO parameters) from disk. The standard **Open Dialog** appears. Navigate to the desired folder, select the desired file and click **Open** to recall the file.
- Click **File > Save Configuration File** to save a configuration file (of MatrixPRO parameters) to disk. The standard **Save Dialog** appears. Navigate to the desired folder, enter the desired filename and click **Save** to save the file.
- Click **File > Exit** to close the GUI application. The physical panel remains active.

Serial Port Menu

The figure below illustrates the **Serial Port Menu**:



Figure 5-9. Serial Port Menu

The following functions are provided:

- Click **Serial Port > Open COM** to display the **COM Port Sub-menu**:

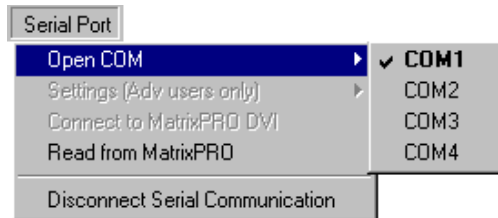

Figure 5-10. COM Port Sub-menu

If you change the physical COM port connection between your PC and MatrixPRO, use the **COM Port Sub-menu** to select the correct port.

- The **Serial Port > Settings (Adv user only)** function is grayed out, and currently not available.
- Click **Serial Port > Connect to MatrixPRO DVI** if you lose communications, or if you change parameters and want to re-establish communications.

Note

This function will be grayed out if proper communications are currently established.

- Click **Serial Port > Read from MatrixPRO** to update the GUI with the current state of the physical MatrixPRO chassis.
 - ▲ If you connected a route locally on the physical MatrixPRO panel, the **Read from MatrixPRO** function will update the GUI's **Video Switching Tab** with the new route.
- Click **Serial Port > Disconnect Serial Communication** to terminate communications between your laptop (or PC) and MatrixPRO.

5. GUI Installation and Operation

Using the Menu Bar

About Menu

On the **Menu Bar**, click **About** to display the **About Dialog**:



Figure 5-11. About Dialog

The **About Dialog** lists the system's version, the minimum required resolution, plus the company websites and support email address. Click **OK** to clear the dialog.

Using the Video Switching Tab

The **Video Switching Tab** enables you to route sources, perform multi-takes, save and recall presets, and mute output channels.

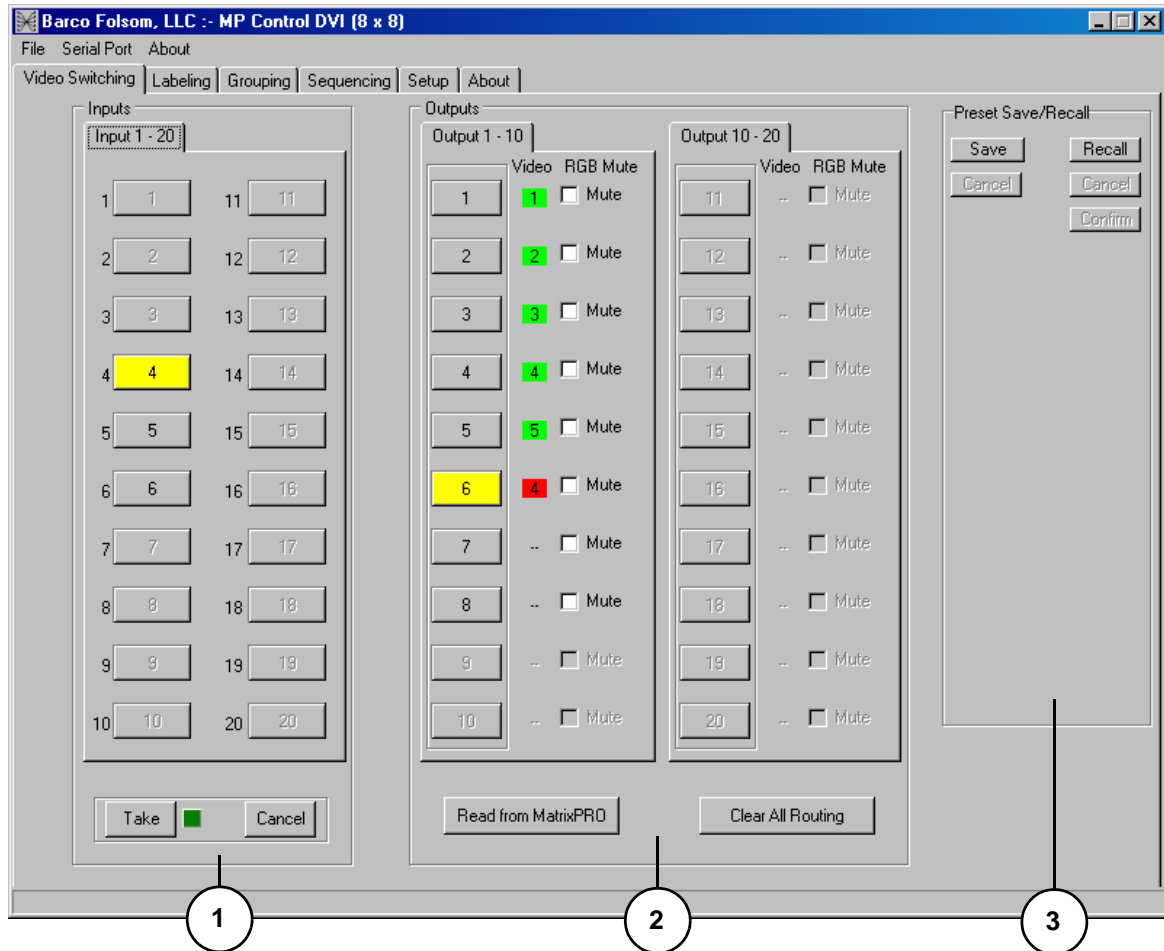

Figure 5-12. Video Switching Tab (sample)

1) Inputs Section	3) Presets Section
2) Outputs Section	

Following are descriptions of each section on the **Video Switching Tab**:

1) Inputs Section

The **Inputs Section** provides numbered buttons with black digits for all “active” input crosspoints. All other input buttons are grayed out.

Please note:

- ~ If you have configured mnemonics on the **Labeling Tab**, the selected names will appear on the appropriate input buttons.
- ~ Unselected input buttons are gray. Selected input buttons are yellow.

5. GUI Installation and Operation

Using the Video Switching Tab

The following additional controls are provided:

- ~ At the bottom of the **Inputs Section**, click **TAKE** to complete a route.
- ~ Click **Cancel** to cancel a pending route.

2) Outputs Section

The **Outputs Section** provides numbered buttons with black digits for all “active” output crosspoints. All other output buttons are grayed out. Please note:

- ~ If you have configured mnemonics on the **Labeling Tab**, the selected names will appear on the appropriate output buttons.
- ~ Unselected output buttons are gray. Selected output buttons are yellow.
- ~ If you select an output button and certain input buttons are grayed out, it may indicate that a “group” has been configured, which restricts the number of available inputs.
- ~ In the **Video** column, “color” indicates status:

A number within a bright green square indicates an active route.

- ▲ The number 7 in a bright green square adjacent to output button 1 indicates that input 7 is routed to output 1.

A number within a bright red square indicates a pending route.

- ▲ The number 4 in a bright red square adjacent to output button 8 indicates that the “input 4 to output 8” route is pending — and **TAKE** must be pressed.

- ~ In the **Video** column, “--” indicates that the adjacent output is clear, or “blanked.”
- ~ In the **RGB Mute** column, a checked box indicates that the adjacent output channel is muted.



Note

A **TAKE** is not required to perform an RGB Mute route.

The following additional controls are provided:

- ~ At the bottom of the **Inputs Section**, click **Read from MatrixPRO** to update the GUI with the current state of the physical MatrixPRO chassis. This control is identical to the function listed in the **Serial Port Menu**.
- ~ Click **Clear All Routing** to clear all input and output routes, and “blank” all outputs. Status will read “--” for all outputs. A “take” is not required.

3) Presets Section

The **Presets Section** provides buttons that enable you to save and recall the router’s current state (all input and output routes) to/from one of eight “configuration” files. Refer to the “[Saving Presets](#)” section on page 68 and the “[Recalling Presets](#)” section on page 69 for instructions.

GUI Switching Operations

Operating procedures are covered in the following sections:

- [Performing a Take](#)
- [Performing a Multi-Take](#)
- [Clearing a Route](#)
- [Using RGB Mute](#)
- [Saving Presets](#)
- [Recalling Presets](#)

5. GUI Installation and Operation

Using the Video Switching Tab

Performing a Take

- On the **Video Switching Tab**, use the following steps to perform a take:
 1. In the **Outputs Section**, click the output to which you want to route an input. The output button turns yellow.

Note

If an input is already associated with that output, the input number will appear within a bright green box in the **Video** column. If there is no input associated with the output, the output is “blanked” and the label “--” is shown.

2. In the **Inputs Section**, click the desired input source. The selected input button turns yellow, and its number appears in a bright red box in the **Video** column — adjacent to the selected output.
3. In the **Inputs Section**, click **TAKE**. The selected input number appears in a bright green box in the **Video** column — indicating an active route.

Note

When the route is completed, the **Status Menu** (if visible) and the appropriate input/output buttons on the physical MatrixPRO panel update accordingly.

4. Repeat from step 1 to perform another take.

Please note the following important points:

- To cancel a route *before* pressing **TAKE**, click the **Cancel** button in the **Inputs Section**, or click the selected input button to “de-select” it. The previous route remains in effect.
- A “pending” route remains pending — even if you click a different output — until **TAKE** or **Cancel** is pressed. The bright red square always indicates a pending route.

Performing a Multi-Take

This procedure enables you to perform multiple input-to-output routes with one “take.”

- On the **Video Switching Tab**, use the following steps to perform a multi-take:
 1. In the **Outputs Section**, click the output to which you want to route an input. The output button turns yellow.
 2. In the **Inputs Section**, click the desired input source. The selected input button turns yellow, and its number appears in a bright red box in the **Video** column — adjacent to the selected output.
 3. Repeat steps 1 and 2 for as many input-to-output routes as desired.
 4. In the **Inputs Section**, click **TAKE**. The selected input numbers appear in bright green boxes in the **Video** column — indicating active routes.
 5. Repeat from step 1 to perform another multi-take.

Clearing a Route

The “clear” procedure enables you to clear (or “blank”) a route.

- On the **Video Switching Tab**, use the following steps to clear a route:
 1. In the **Outputs Section**, click the output channel that you want to clear. The button lights yellow along with its currently assigned input.
 2. In the **Inputs Section**, click the currently assigned input button. In the video column, the label “--” appears in a red squared, indicating that a “blank” route is pending.
 3. Click **TAKE**. The selected input button turns off, indicating that the input has been cleared and the output channel has been blanked.

Note

You can perform a “multi-clear” in the same manner as you performed a multi-take.

Using RGB Mute

The RGB Mute feature enables you to blank a channel's output video while leaving the channel's sync signals running to the monitor.

- On the **Video Switching Tab**, use the following steps to “mute” an output:
 1. Verify that an active route is in place (based on a bright green square in the **Video** column) for the selected output.
 2. In the **Outputs Section**, enable the check box in the **RGB Mute** column for the output that you wish to mute. The channel is immediately muted — pressing **TAKE** is *not* required.
 3. Repeat from step 1 to mute another output channel.

Please note the following important points:

- To clear an RGB Mute route, simply disable the check box.

5. GUI Installation and Operation

Using the Video Switching Tab

Saving Presets

The router's current state (all input and output routes) can be saved to one of eight presets (or "configuration" files). For example, you can save a preset in which all outputs are "blanked," or a configuration in which input 1 is routed to all outputs.

■ On the **Video Switching Tab**, use the following steps to save a preset:

1. In the **Presets Section**, click **Save** to reveal the 8 preset buttons.



Figure 5-13. Presets Section — Save pending

2. Ensure that the router's input/output status is configured the *exactly* as you want. The status of all current routes will be saved.
3. In the **Presets Section**, click the button for the preset into which you want to save the configuration. The section will automatically hide to confirm the "save."
4. Repeat from step 1 to save another preset.

Note

You can click **Cancel** to cancel the procedure, prior to clicking a selected preset register.

Recalling Presets

A stored “preset” (configuration file) containing all input and output routes can be recalled from memory and applied instantly to the router’s current state. For example, you can recall a configuration in which all outputs are “blanked,” or a configuration in which input 4 is routed to all outputs.

- On the **Video Switching Tab**, use the following steps to recall a preset:
 1. In the **Presets Section**, click **Recall** to reveal the 8 preset buttons.



Figure 5-14. Presets Section — Save pending

Note that “empty” presets are grayed out.

2. Click the button for the preset that you want to recall. The pending preset route is immediately recalled to the panel, as indicated by the bright red squares (and associated input digits) adjacent to all output buttons.
3. Click **TAKE** or **Confirm** to complete the route.

Note

You can click **Cancel** to cancel the procedure, prior to clicking **TAKE**.

5. GUI Installation and Operation

Using the Labeling Tab

Using the Labeling Tab

The **Labeling Tab** enables you to create mnemonic labels for inputs, outputs, groups and presets. Once created, the labels appear on the buttons in the appropriate GUI sections.

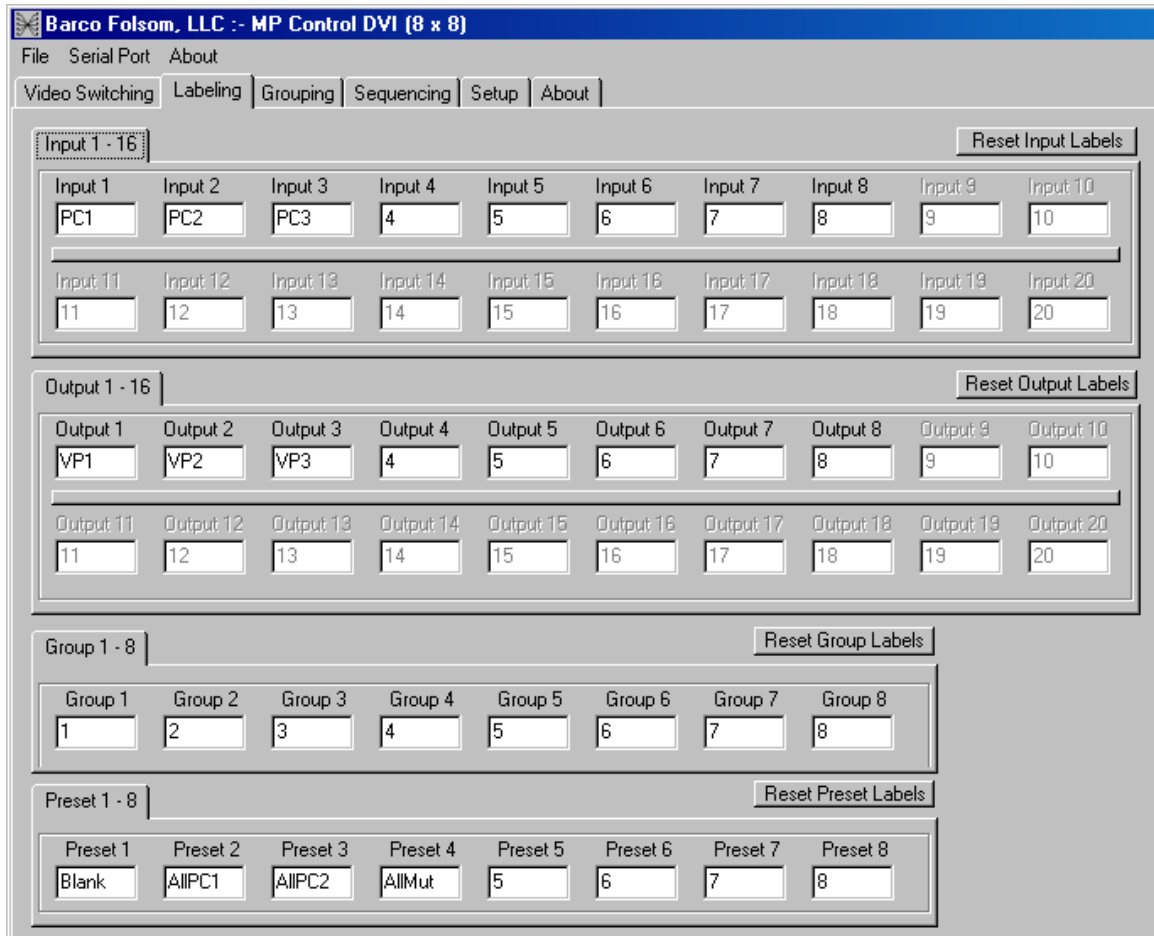

Figure 5-15. Labeling Tab (sample)

Please note:

- Labels can be up to 6 characters in length.
 - Labels can include a mix of letters and numbers.
 - Cells for which there is no associated input or output are grayed out.
- To work with labels:
1. To create a label, click in the desired cell and type. You do not have to press **Enter** for the label to take effect.
 2. To clear an individual label, click in the desired cell and re-type.
 3. To clear all labels in a particular group, click the group's associated **Reset** button.

Using the Grouping Tab

The **Grouping Tab** enables you to set up groups of input and output channels, in order to prevent certain inputs from being switched to selected outputs. Once established, routes can only be performed within the group.

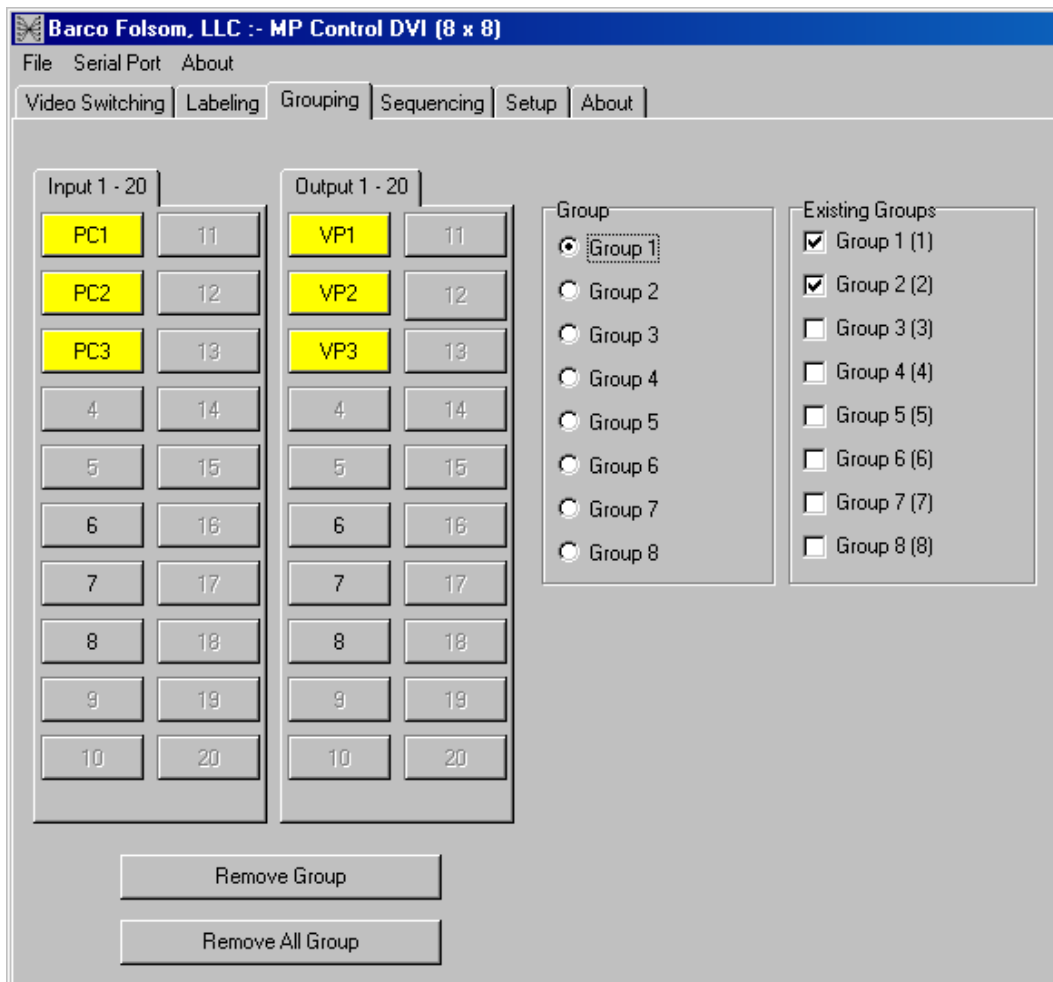

Figure 5-16. Grouping Tab (sample)

The **Grouping Tab** includes columns for inputs, outputs, group “selection” and a column that indicates existing groups. The following rules apply:

- A minimum of two inputs and two outputs are required to form a group, but up to 8 can be included in a group.
- Multiple groups can be configured on the GUI (e.g., 2 groups of 4 outputs each).
- Inputs and outputs can only be in one group at a time. Unavailable inputs and outputs are grayed out.
- When an output within a group is selected, you can only route the inputs currently assigned to that group. Inputs “outside” the group cannot be selected.

5. GUI Installation and Operation

Using the Grouping Tab

- To check the “members” of a group, click a group in the **Group** column. All assigned group input and output buttons will light in yellow. If no buttons light, that group is not configured.

Note

Grouping of inputs and outputs does not establish a route. The input source for a particular output still must be established using the standard “take” procedure on the **Video Switching Tab**.

- Use the following steps to create an input/output group:
 1. In the **Group** column, click the radio button for the group that you wish to create.
 2. In the **Output** column, click the button(s) for the output(s) that you want to be in the group. Each selected output button turns yellow.
 3. In the **Input** column, click the button(s) for the input(s) that you want to be in the group. Each selected input button turns yellow.
 4. Repeat from step 1 to configure additional groups. Note that once an input or output is included in a group, it is grayed out.
- Use the following steps to add an input or output to an existing group:
 1. In the **Group** column, click the radio button for the group that you want to modify.
 2. In the **Output** column, click the button(s) for the output(s) that you want to add to the group. Each selected button turns yellow.
 3. In the **Input** column, click the button(s) for the input(s) that you want to add to the group. Each selected button turns yellow.
 4. Repeat from step 1 to add inputs or outputs to additional groups.
- Use the following steps to remove an input or output from an existing group:
 1. In the **Group** column, click the radio button for the group that you want to modify.
 2. In the **Output** column, click the button(s) for the output(s) that you want to remove from the group. Each selected button turns off.
 3. In the **Input** column, click the button(s) for the input(s) that you want to remove from the group. Each selected button turns off.
 4. Repeat from step 1 to remove inputs or outputs from additional groups.
- Use the following steps to completely remove (clear) an existing group:
 1. In the **Group** column, click the radio button for the group that you want to remove.
 2. Click **Remove Group**.
- Use the following steps to remove all groups:
 1. Click **Remove All Group**.

Using the Sequencing Tab

The **Sequencing Tab** enables you to cycle through a sequence of presets.

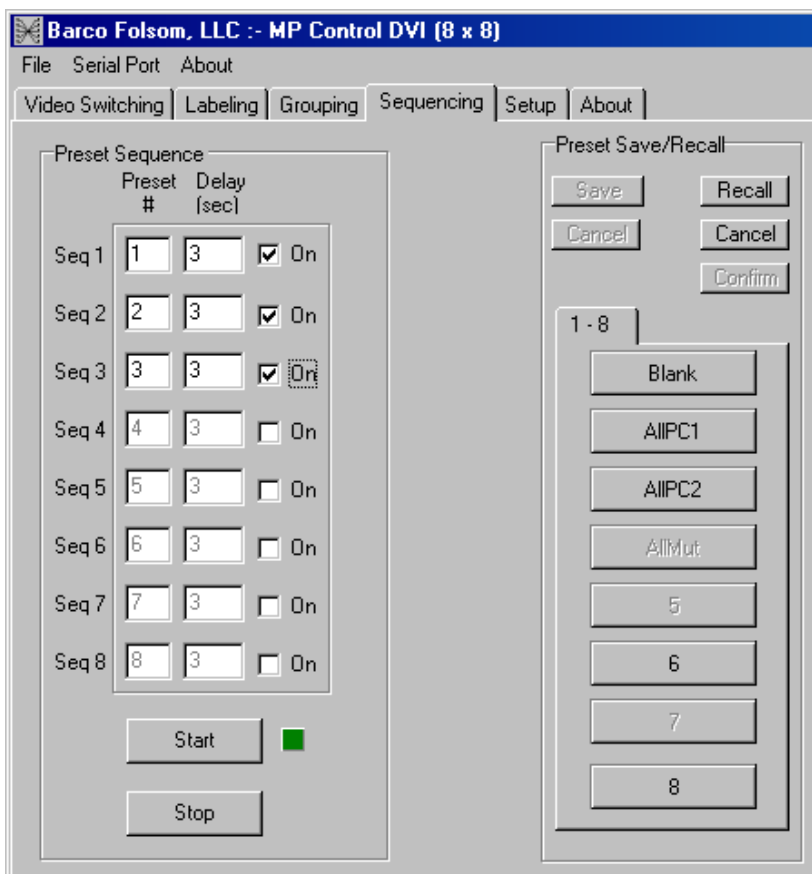

Figure 5-17. Sequencing Tab (sample)

This functionality also allows for a variable delay time (in seconds), during which time the system waits until it recalls the next preset in sequence. Delay time ranges from 3 to 9999 seconds, and the default delay is 3 seconds. Please note:

- The **Presets Section** (identical to that on the **Video Switching Tab**), is included on this tab — enabling you to check which preset registers are valid or empty. Refer to the [“Saving Presets”](#) section on page 68 and the [“Recalling Presets”](#) section on page 69 for details.
 - In the **Preset Sequence** section, enabling the “On” check box adjacent to a preset includes that preset in the sequence.
 - Sequence can be started and stopped by clicking on the **Start** and **Stop** buttons, respectively. When you start a sequence, it will always loop until **Stop** is clicked.
- Use the following steps to create a sequence:
1. Ensure that you have saved the desired presets.
 2. Enable the “On” check boxes for the presets that you wish to include in the sequence.

5. GUI Installation and Operation

Using the Sequencing Tab

3. In the Delay column, set the desired delay interval for each enabled preset — from 3 to 9999 seconds.
4. Click **Start** to begin the sequence. “Active” presets are indicated by the bright green square adjacent to the sequence number. Please note:
 - ~ The sequence loops back to the first enabled preset, when the last preset in the sequence is reached.
 - ~ As the sequence plays, you can click the **Video Switching Tab** and watch the input assignments change.
5. To stop sequence playback, click **Stop** on the **Sequencing Tab**.

Using the Setup Tab

The **Setup Tab** enables you to select the method of MatrixPRO remote control (either RS-232 or Ethernet), change the IP address if required, and reset the system.

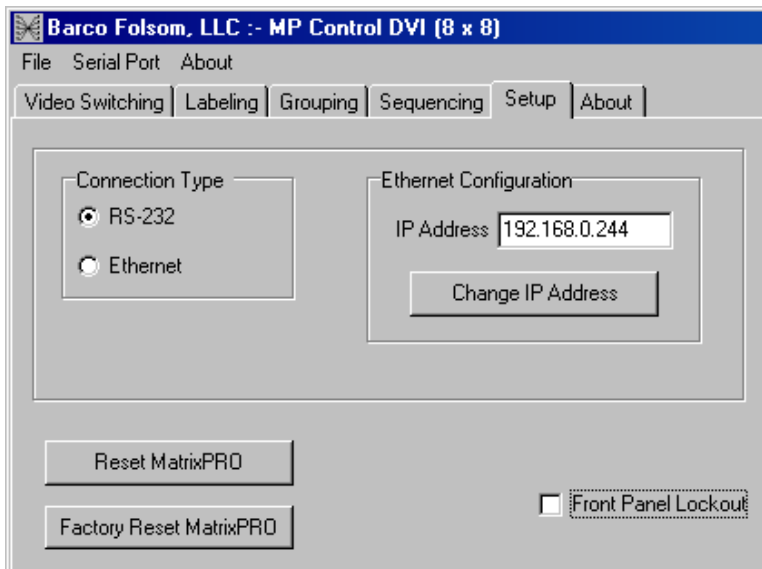

Figure 5-18. Setup Tab (sample)

Note

If a proper connection to MatrixPRO is established when you launch the GUI, no action is required on the **Setup Menu**. However, if you need to change the connection, the IP address or reset the system, use the functions below.

The following functions are provided:

- Click **RS-232** to change the connection to RS-232. The system will query the ports and attempt to connect serially. If the connection fails, refer to the [“Connection Troubleshooting”](#) section on page 58 for details.
- Click **Ethernet** to change the connection to Ethernet. The system will query the IP connection. If the connection fails, refer to the [“Connection Troubleshooting”](#) section on page 58 for details.
- If you need to change the IP address in order to match that of MatrixPRO, click in the **IP Address** field, enter the correct address, then click **Change IP Address**.

Note

The default IP address is **192.168.000.243**.

- Check the **Front Panel Lockout** check box to disable MatrixPRO's front panel. Un-check the box to re-enable front panel control.
- Click the **Reset MatrixPRO** button to perform a “soft” reset in which only the operating system is reset — but all routes and presets remain in effect.
- Click the **Factory Reset MatrixPRO** button to perform a full factory reset. All routes are cancelled and all presets are cleared.

5. GUI Installation and Operation

Using the "About" Tab

Using the "About" Tab

The **About Tab** shows the current versions of GUI software and firmware, along with serial activity indicators and the current COM port.

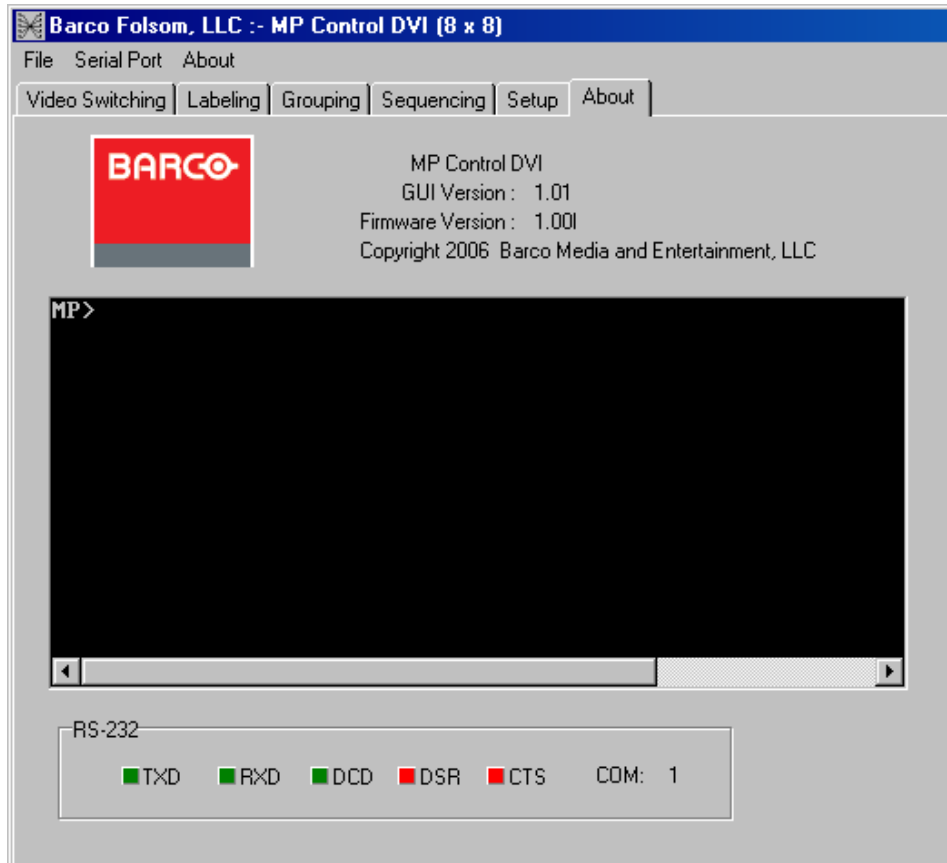

Figure 5-19. About Tab (sample)

Note that the **About Tab** also provides an RS-232 terminal window that can be used to issue commands directly to MatrixPRO.

Important

The "terminal" window function is designed for advanced MatrixPRO users only, and it is recommended that you do not use the function. If required, refer to Appendix B, "[Remote Control Protocol](#)" on page 91 for additional instructions.

6. Upgrading Software

The logo for MatrixPRO, featuring the word "MatrixPRO" in a bold, italicized, purple font with a blue underline. The "TM" trademark symbol is positioned to the right of the word.

In This Chapter

This chapter provides detailed instructions for upgrading system software. The following topics are discussed:

- [Software Upgrade Overview](#)
- [Hardware Requirements](#)
- [Software Requirements](#)
- [Downloading Software](#)
- [Serial Upgrade Method](#)
- [Ethernet Upgrade Method](#)

6. Upgrading Software

Software Upgrade Overview

Software Upgrade Overview

Firmware files for the MatrixPRO 8x8 DVI Router system are loaded into the hardware at power-up. These files are stored in the unit's onboard flash memory, which can be upgraded using a serial or Ethernet connection to a PC (or laptop).

The desired connection is made through the **Serial** or **Ethernet** port on the router's rear panel, in conjunction with the "Flash Loader" utility supplied with each upgrade. The Flash Loader enables you to update the Flash memory with the latest software revision. The utility should be run from a PC's hard drive (recommended).

Hardware Requirements

The following hardware items are required for upgrading the MatrixPRO software:

- IBM compatible computer with an available COM port or Ethernet port.

If you elect to connect serially, a serial cable conforming to EIA RS-232 specifications (e.g., standard modem cable) is required. The cable should have a DB-9 male connector on one end (for connection to the MatrixPRO's **Serial** port), and the appropriate connector on the other end for connection to your PC (typically, a DB-9).

Software Requirements

The following list outlines software requirements for upgrading MatrixPRO software:

- Ensure that your PC (or laptop) uses the Windows® 2000 or XP operating systems.
- Software files:
 - ~ Flash File Loader. (This software enables the PC to send commands to MatrixPRO.)
 - ~ MatrixPRO 8x8 DVI Router software
 - ~ What's New File

Note

All software files listed above (and more) are contained in the file that you will download.

Software files can be downloaded from either the Folsom FTP site or the Barco Folsom website, as described in the following "[Downloading Software](#)" section on page 79.

Downloading Software

Two different methods can be used to download MatrixPRO software and the Flash File Loader utility:

- [Via FTP Site](#)
- [Via Web Site](#)

Via FTP Site

Barco Folsom's FTP site address is: **ftp.folsom.com**

■ To download from the FTP site:

1. Create a target folder on your PC (e.g., MatrixPRO).
2. If you are using an FTP client, logon to our site as follows:
 - ~ **User name:** anonymous
 - ~ **Password:** your email address

▲ **Example:** johndoe@somecompany.com

If you are using a web browser to access our FTP site, point the browser to:

ftp://ftp.folsom.com

3. Once logged on, navigate to the following directory:
ftp://ftp.folsom.com/Products/Video/MatrixPRO-8x8-DVI/
4. Transfer the following file to the target folder on your PC:
MatrixPRO_DVI_8x8_Rev#.##.EXE
5. As required, please continue with the "[Serial Upgrade Method](#)" section on page 80, or the "[Ethernet Upgrade Method](#)" section on page 82.

Via Web Site

Barco Folsom's web site address is: **http://www.folsom.com**

■ To download from the web site:

1. Create a target folder on your PC (e.g., MatrixPRO).
2. On the web, navigate to <http://video.folsom.com>.
3. Click "**Downloads**" to access the **Downloads Page**.
4. Using the "**Select Video Product**" pull-down menu, click MatrixPRO 8x8 DVI.
5. In the "**Software**" section, click the **Download** button for the latest version of system software.
6. When the **File Download Dialog** appears, click **Save** to save the file to your computer.
7. When the **Save As Dialog** appears, navigate to the target folder and click **Save**.
8. As required, please continue with the "[Serial Upgrade Method](#)" section on page 80, or the "[Ethernet Upgrade Method](#)" section on page 82.

6. Upgrading Software

Serial Upgrade Method

Serial Upgrade Method

- Use the following steps to upgrade MatrixPRO software using a serial connection to your PC:
 1. With the download complete, navigate to the target folder and double-click the **EXE** to launch the installation shield.
 2. Follow the prompts to install the upgrade package in the default folder. At the conclusion of the procedure, a new path will be created under **Start > Programs > Barco Folsom**.
 3. Connect the **Serial** port on the back of MatrixPRO to the **COM 1** port on your PC. In Chapter 2, refer to the "[MatrixPRO 8x8 DVI Router Rear Panel](#)" section on page 21 for the location of the **Serial** port.
 4. Power-up MatrixPRO.
 5. On the PC, click **Start > Programs > Barco Folsom > MatrixPRO DVI 8x8 Software #.## > Flash Loader** to launch the Flash Loader utility.

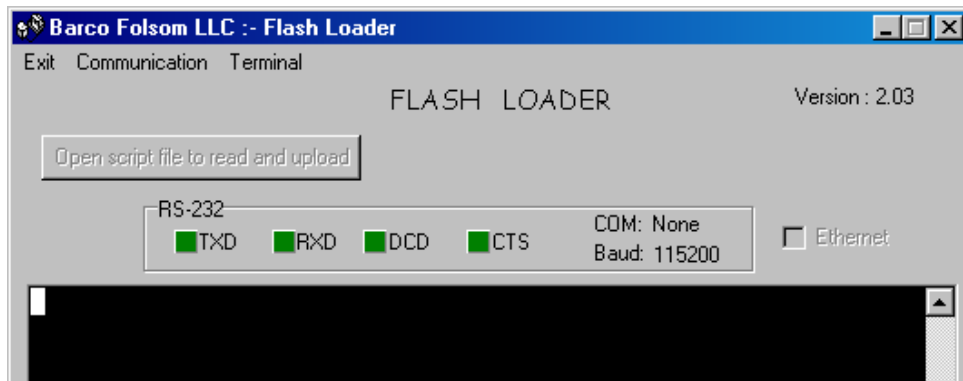

Figure 6-1. Flash Loader Utility

Note

If you have not used the **COM 1** port on your PC, an error message will be shown at the bottom of the Flash Loader.

6. Click **Communication > RS232 Config > Baud**, and select 115200.
7. Click **Communication > RS232 Config > COM Port**, and select the COM port on your PC to which MatrixPRO is connected. If no other programs are using the port, the "**Established communications**" message appears at the bottom of the Flash Loader.
8. To verify communications between the PC and MatrixPRO:
 - a. In the Flash Loader, click in the black terminal window area.
 - b. Note the condition of the status lights:
 - **DCD** and **CTS** should be red.
 - **TXD** and **RXD** should be green. They will flash if **Enter** is pressed.
 - c. Press **Enter** a few times to display the system prompt "**#**" on screen.
 - d. If the prompt does not appear, continue with step 9 (troubleshooting).

6. Upgrading Software

Serial Upgrade Method

- e. If the prompt appears, continue with step **10** (uploading files).
9. To troubleshoot the serial connection:
 - a. If the **DCD** and **CTS** status lights are green, re-check the communication settings in the loader, and verify that the COM port and Baud Rate settings are correct.
 - b. To verify MatrixPRO communication settings, using the MatrixPRO menu, select **SETUP** to display the **Setup Menu**.
 - c. From the **System Menu**, select **RS-232 Settings** to display the **RS-232 Settings Menu**.



Figure 6-2. MatrixPRO RS-232 Settings Menu

- d. Ensure that the baud rate is set to 115200. Other parameters cannot be changed.
 - e. Repeat steps **7** and **8** above, then re-check the status lights.
 - f. With communication status OK, continue with step **10**.
 10. To upload files to MatrixPRO, click "**Open script file to read and upload.**"
 11. In the dialog, select "**Complete_Load.sld**" and click **Open**. The MatrixPRO menu should immediately display the "**System in LOADER MODE**" message.
 12. It takes several minutes to load the flash memory. When complete, the Flash Loader utility displays the "**Upload Complete**" message. Click **OK** to continue.
 13. Cycle power on the MatrixPRO, and exit the Flash Loader utility.
 14. On MatrixPRO, perform a factory reset. In Chapter 4, refer to the "[Factory Reset Menu](#)" section on page 39 for instructions.
 15. On MatrixPRO, verify that the new software has been loaded correctly. In Chapter 4, refer to the "[Tech Support Menu](#)" section on page 39 for instructions.
- This completes the software upgrade procedure via serial communications.

6. Upgrading Software

Ethernet Upgrade Method

Ethernet Upgrade Method

- Use the following steps to upgrade MatrixPRO software using an Ethernet connection to your PC:

Note

The default IP address is **192.168.000.243**.

1. Ensure that your PC (or laptop) uses the Windows® 2000 or XP operating systems.
2. Connect MatrixPRO's Ethernet port to a Hub or Switch.
3. Connect the Ethernet Hub or Switch to your PC. Remember that a totally "local" network is recommended, without IP connections to the outside world.
4. Power-up MatrixPRO.
5. Make a note of MatrixPRO's IP address — if DHCP is enabled on MatrixPRO, its IP address may not be the default address. In Chapter 4, refer to the "[IP Address](#)" section on page 37 for instructions.
6. On the PC, click **Start > Programs > Barco Folsom > MatrixPRO DVI 8x8 Software #.## > Flash Loader** to launch the Flash Loader utility.

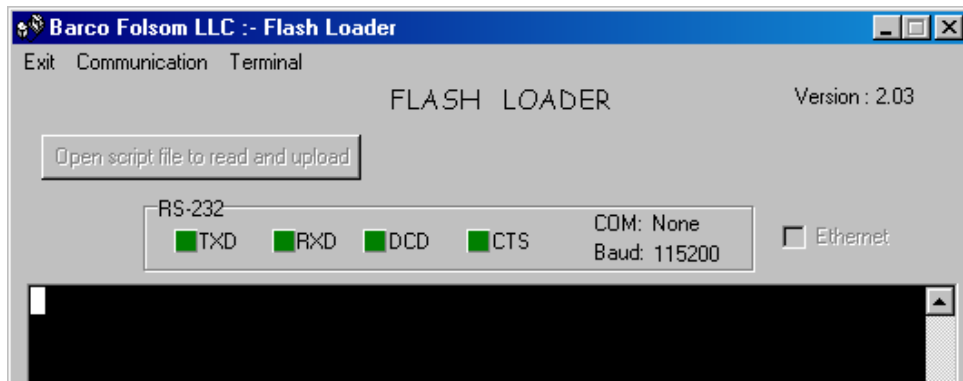

Figure 6-3. Flash Loader Utility

7. Click **Communication > Ethernet > Connect** to display the **Ethernet Connection Dialog**.

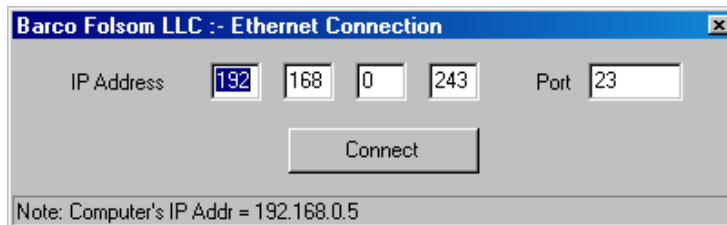

Figure 6-4. Ethernet Connection Dialog (sample)

Note

If the **Ethernet** menu pick is grayed out, set the COM port to **None**.

6. Upgrading Software

Ethernet Upgrade Method

8. In the dialog, enter MatrixPRO's IP address (as noted in step 5 above), and enter the default port number: **23**.
9. Click the **Connect** button. If the connection is successfully, the message "**Connect via Ethernet successful**" appears in the Flash Loader's **Status Bar**. If you cannot connect, refer to the "[Troubleshooting Ethernet Communication](#)" section on page 83.
10. To upload files to MatrixPRO, click "**Open script file to read and upload.**"
11. In the dialog, select "**Complete_Load.sld**" and click **Open**. The MatrixPRO menu should immediately display the "**System in LOADER MODE**" message.
12. It takes several minutes to load the flash memory. When complete, the Flash Loader utility displays the "**Upload Complete**" message. Click **OK** to continue.
13. Cycle power on the MatrixPRO, and exit the Flash Loader utility.
14. On MatrixPRO, perform a factory reset. In Chapter 4, refer to the "[Factory Reset Menu](#)" section on page 39 for instructions.
15. On MatrixPRO, verify that the new software has been loaded correctly. In Chapter 4, refer to the "[Tech Support Menu](#)" section on page 39 for instructions.

Troubleshooting Ethernet Communication

- Use the following steps to determine the IP address of MatrixPRO, and establish proper communications:

Note

The default IP address is **192.168.000.243**.

1. Turn on the MatrixPRO router and navigate to the **IP Address Menu**. In Chapter 4, refer to the "[IP Address](#)" section on page 37 for instructions.
2. Make a note of MatrixPRO's IP address — if DHCP is enabled on MatrixPRO, its IP address may not be the default value.
3. Attempt to ping the router as follows:
 - a. Connect MatrixPRO's Ethernet port to a Hub or Switch.
 - b. Connect the Ethernet Hub or Switch to your PC. A totally "local" network is recommended, without IP connections to the outside world.
 - c. Turn on the PC or laptop.
 - d. Open a command prompt window on the PC. Click **Start > Programs > Accessories > Command Prompt**.
 - e. On the command prompt line, type:

```
ping 192.168.0.243
```

... followed by **Enter**.

Note

Use the unit's actual IP address, as determined in step 2 above.

- f. If the computer is able to successfully communicate with the MatrixPRO, you will see a series of "**replies**" from the target IP address. Repeat the upgrade procedure as outlined in the "[Ethernet Upgrade Method](#)" section on page 82.

6. Upgrading Software

Ethernet Upgrade Method

- g.** If you see a “**Request timed out**” message, the PC is unable to locate and communicate with MatrixPRO. If this is the case:
- Check your network connections and settings as described above, or ...
 - Contact your network administrator, or ...
 - Contact **Technical Support**. In Appendix C, refer to the “[Contact Information](#)” section on page 102 for details.

A. Specifications

*MatrixPRO*TM

In This Appendix

This appendix provides detailed technical specifications for the MatrixPRO 8x8 DVI Router. The following topics are discussed:

- [Input Specifications](#)
- [Output Specifications](#)
- [Physical and Electrical Specifications](#)
- [Communications Specifications](#)
- [Agency Specifications](#)
- [Pinouts](#)

A. Specifications

Input Specifications

Input Specifications

The table below lists MatrixPRO 8x8 DVI Router input specifications.

Table A-1. MatrixPRO 8x8 DVI Router Input Specifications

Parameter	Detail	Specification
Video Input	Connectors	8 x DVI
	Signal Type	TMDS
	Signal Speeds	25 - 165 MHz pixel clock
	Maximum Cable Length	20m *

* Signal quality cannot be guaranteed for cable lengths of 20 meters if lower quality DVI cables are used, or if cable extenders are used.

Output Specifications

The table below lists MatrixPRO 8x8 DVI Router output specifications.

Table A-2. MatrixPRO 8x8 DVI Router Output Specifications

Parameter	Detail	Specification
Video Output	Connectors	8 x DVI
	Signal Type	TMDS
	Switching type	Vertical interval (if selected via setup Menu)

Physical and Electrical Specifications

The table below lists MatrixPRO 8x8 DVI Router physical and electrical specifications.

Table A-3. MatrixPRO 8x8 DVI Router Physical and Electrical Specifications

Parameter	Detail	Specification
Power	Connector	Standard IEC, integral on/off switch
	Power	50-60 Hz, 100-240 VAC
Mechanical	Router Chassis	H: 3.5 inches (8.89 cm)
		W: 17.00 inches (43.18 cm)
		D: 15.00 inches (38.10 cm)
Temperature		0-40 degrees C
Humidity		0-95% non-condensing
Mounting		2 RU rack mount (19 inch, using front and rear mounts)
Weight		17 lbs (7.71 kg)
Shipping Weight		22 lbs (9.97 kg)

Communications Specifications

The table below lists MatrixPRO 8x8 DVI Router communications specifications.

Table A-4. MatrixPRO 8x8 DVI Router Communications Specifications

Parameter	Detail	Specification
RS-232	Router Chassis	DB-9 Female, DCE, 115k Baud
Ethernet	Router Chassis	RJ-45, 10/100 Mbps Autosense

Agency Specifications

The table below lists MatrixPRO 8x8 DVI Router agency specifications.

Table A-5. MatrixPRO 8x8 DVI Router Agency Specifications

Parameter	Detail	Specification
EMI/EMC	Router Chassis	EN55103-1 E4, EN55103-2, FCC Part 15 Subpart B Class A
Safety	Router Chassis	EN 60950 Class 1

A. Specifications

Pinouts

Pinouts

The following topics are discussed in this section:

- [DVI Connector](#)
- [Ethernet Connector](#)
- [Serial Connector](#)

DVI Connector

The figure below illustrates the DVI connector:

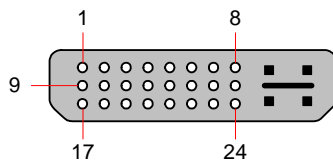

Figure A-1. DVI Connector

The table below lists DVI Connector pinouts. Please note:

- T.M.D.S = Transition Minimized Differential Signal
- DDC = Display Data Channel

Table A-6. DVI Connector Pinouts

Pin	Signal	Pin	Signal
1	T.M.D.S. Data 2-	13	T.M.D.S. Data 3+
2	T.M.D.S. Data 2+	14	+5V Power
3	T.M.D.S. Data 2/4 Shield	15	ground (for +5V)
4	T.M.D.S. Data 4-	16	Hot Plug Detect
5	T.M.D.S. Data 4+	17	T.M.D.S. Data 0-
6	DDC Clock	18	T.M.D.S. Data 0+
7	DDC Data	19	T.M.D.S. Data 0/5 Shield
8	Analog Vertical Sync	20	T.M.D.S. Data 5-
9	T.M.D.S. Data 1-	21	T.M.D.S. Data 5+
10	T.M.D.S. Data 1+	22	T.M.D.S. Clock Shield
11	T.M.D.S. Data 1/3 Shield	23	T.M.D.S. Clock +
12	T.M.D.S. Data 3-	24	T.M.D.S. Clock -

Ethernet Connector

The figure below illustrates the Ethernet connector:

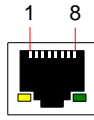

Figure A-2. Ethernet Connector

The table below lists Ethernet connector pinouts.

Table A-7. Ethernet Connector Pinouts

Pin	Signal	Wire Color
1	TX Data +	White / Orange
2	TX Data -	Orange
3	RX Data +	White / Green
4		Blue
5		White / Blue
6	RX Data -	Green
7		White / Brown
8		Brown

A. Specifications

Pinouts

Serial Connector

The figure below illustrates the Serial connector:

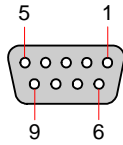

Figure A-3. Serial Connector

The table below lists Serial connector pinouts.

Table A-8. Serial Connector Pinouts

Pin	RS-232 Signal	Description
1	CD	Carrier Detect
2	RXD	Received Data
3	TXD	Transmitted Data
4	DTR	Data Terminal Ready
5	GND	Signal Ground
6	DSR	Data Set Ready
7	RTS	Request To Send
8	CTS	Clear To Send
9	RI	Unused

B. Remote Control Protocol

The logo for MatrixPRO, featuring the word "MatrixPRO" in a bold, purple, sans-serif font with a trademark symbol (TM) to the right. A blue horizontal line is positioned below the text.

In This Appendix

This appendix provides information regarding external remote control protocol. The following topics are discussed:

- [Default Serial Parameters](#)
- [Default IP Address](#)
- [RS-232 Mode](#)
- [MatrixPRO Remote Commands](#)

B. Remote Control Protocol

Default Serial Parameters

Default Serial Parameters

The following are the parameter settings for serial communication:

- **Baud Rate** = 115K baud
- **Parity** = NONE
- **Stop Bit** = 1
- **Data Bit** = 8
- **Echo** = ON
- **Flow Control** = NONE

Note

These are the default settings, but only the baud rate can be changed serially, or using the menu. In Chapter 4, refer to the "[RS-232 Settings Menu](#)" section on page 37 for instructions.

Default IP Address

The MatrixPRO default IP address is **192.168.000.243**.

Please note:

- The system returns to this value after a factory reset.
- This default address can be changed using the menu system. In Chapter 4, refer to the "[IP Address](#)" section on page 37 for instructions.

RS-232 Mode

The MatrixPRO 8x8 DVI Router will respond with a “#” prompt when the command processor is ready for a command. The command syntax is shown below

```
cmd arg1 arg2 ... argn<CR>
```

Table B-1. RS-232 Command Syntax

Command	Description
cmd	Any valid graphics board command, typically 2 to 6 alphabetic (non numeric) characters
arg	argument1, argument2, ... argument"N" are required or optional parameters depending on the command used.
<CR>	carriage return (ASCII 13) terminates the command

Please note:

- A space (ASCII 32) must be inserted between the command and any arguments that follow. A space must also be inserted between all argument parameters, except for the last argument in the chain.
- All commands in RS-232 mode must be terminated with a carriage return (ASCII 13). The carriage return will tell the command processor to begin execution of the command.
- Query commands will return the following:

```
=result
```

```
#
```

The “=” indicates that a result from a query command is following. The “result” will follow directly after the “=”. The value of the result will vary depending on the query command used. A new line will be generated and the prompt (#) will indicate the system is ready for a new command.

B. Remote Control Protocol

MatrixPRO Remote Commands

MatrixPRO Remote Commands

The table below lists MatrixPRO 8x8 DVI Router remote commands.

Table B-2. MatrixPRO 8x8 DVI Router Remote Commands

Command	Description	Page
CLEAR	Clear all matrix video routings	95
DHCP	Enable/disable DHCP mode	95
FPLOCK en	Lock/unlock the front panel from user input	95
GCLEAR grp	Clears grouping information for the specified group	95
GADD grp out in	Add an output and/or input to the selected group	95
GDEL grp out in	Remove output and/or input from the selected group.	96
IP	Set or update IP Address	96
IPINFO	Provides information regarding Ethernet	96
LOADR	Places unit into loader mode for field upgrades	96
MPRC	Remote panel communication, begin command	96
OSTAT	Show output status	96
NSTAT	Send the number of inputs and outputs	97
PRST num	Saves current front panel configuration/routing to a Preset location	97
PSTAT	Displays preset information	97
RESET	Resets the system	97
REV	MatrixPRO board revision and main software version information	97
RGBMUTE	Mutes the output channel, syncs remain	98
RPRST num	Recall an existing preset	98
RTEMP out in	Routes inputs to outputs (pend)	98
SPARAMS	Set serial settings - baud rate	98
TAKE en	Activate or cancel all pending video/audio routes.	98
TPAT	Selects test pattern	99
WHOAREYOU	Query identity of this serial/ethernet connection	99
HELP	Displays a list of available commands	99
?	Display specific command plus parameter description	99

MatrixPRO 8x8 DVI Router Serial Command List

CLEAR

- **Description:** Clears all existing and pending video routes.
 - **Parameters:** None
- ▲ CLEAR

DHCP

- **Description:** Enable/disable DHCP mode
 - **Parameters:** DHCP [mode]
- Sets DHCP mode where 0=OFF, 1=CLIENT, 2=SERVER

FPLOCK en

- **Description:** Lock/unlock the front panel from user input. Locking the front panel results in the front panel not responding to user button presses.
 - **Parameters:** en -[0|1], Disable|Enable
 - **Query:** FPLOCK? Returns the current front panel lock status if no argument is entered.
- ▲ FPLOCK 1 (Locks the front panel from the user.)

GCLEAR grp

- **Description:** Clears grouping information for the specified group.
 - **Parameters:**
- grp** Group number to clear; [1-8]
- ▲ GCLEAR 1 (Clears the grouping information in group number 1.)

GADD grp out in

- **Description:** Add an output and/or input to the selected group .

Note

The user cannot add output to more than one group index.

- **Parameters:**
- [GroupNum]** Group number to add output; [1-8]
[OutNum] Output number to add; [1-8] / 101 if no output to add
[InNum] Input number to add; [1-8] / 101 if no input to add
- ▲ **Examples:**
- GADD 1 4 2 (Add output 4 and input 2 to group 1.)
 GADD 1 101 5 (Add input 5 to group 1.)

B. Remote Control Protocol

MatrixPRO Remote Commands

GDEL grp out in

- **Description:** Remove output and/or input from the selected group.
- **Parameters:**
 - [GroupNum]** Group number to remove output; [1-8]
 - [OutNum]** Output number to remove; [1-8] / 101 if no output to remove
 - [InNum]** Input number to remove; [1-8] / 101 if no input to remove
- ▲ **Examples:**
 - GDEL 1 4 2 (Remove output 4 and input 2 from group 1.)
 - GDEL 1 101 5 (Remove input 5 from group 1.)

IP

- **Description:** Set or update IP Address
- **Parameters:** IP [address]
 - [address] - aaa.bbb.ccc.ddd, each group of number ranges from 0-255

IPINFO

- **Description:** Provides information regarding Ethernet:
 - ~ Server running, DHCP Server disabled
 - ~ **IP Address:** 192.168.0.243
 - ~ **Listen Port:** 23
 - ~ **Subnet Mask:** 255.255.255.0

LOADR

- **Description:** Places unit into loader mode for field upgrades.
- **Parameters:** None.
 - ▲ LOADR (Puts unit into loader mode.)

MPRC

- **Description:** Remote panel communication, begin command
 - ~ MPRC [Node]

OSTAT

- **Description:** Show output status
 - ▲ OSTAT
 - Returns:
 - ~ FPLock 0
 - ~ Out[1]: Video 253, PVideo 253, VRoute 1, RGBMute 0
 - ~ Out[2]: Video 253, PVideo 253, VRoute 1, RGBMute 0
 - ~ etc.

NSTAT

- **Description:** Number Ins/Outs Status
~ Send the number of inputs and outputs

PRST num

- **Description:** Saves current front panel configuration/routing to a Preset location
- **Parameters:**
out Preset number to save to; [1 - 8]
▲ **Example:** PRST 1 (Saves configuration to preset location 1.)

PSTAT

- **Description:** Displays preset information (e.g., preset valid, which input video/audio # routed, audio level, etc.).
- **Parameters:**
out Preset number; [1 - 8]

Note

This parameter is optional, if no parameter exist, all preset information (1-8) will be displayed.

▲ Examples:

PSTAT 1 (Displays preset status for preset 1)

PSTAT (Displays preset status for all presets):

- Preset[1];Out[1]:Active 1,Video 1,VRoute 1RGBMute0
- Preset[1];Out[2]:Active 1,Video 1,VRoute 1RGBMute0
- etc.

RESET

- **Description:** Resets the system
- **Parameters:** RESET [type] <confirm>
[type] specifies type of reset, F=Factory, S=Soft
[confirm] applicable only when reset type is F. Indicates whether confirmation is desired; 0=No, 1=Yes (default)
▲ RESET F (Resets system to factory defaults and resets all presets.)

REV

- **Description:** MatrixPRO board revision and main software version information
Returns:
~ PCB Rev 1.0, Assembly Rev 1.0
~ MatrixPro DVI Software Version
~ Upper Board Fab: B, Assembly: 0
~ Lower Board Fab: B Assembly: 0

B. Remote Control Protocol

MatrixPRO Remote Commands

RGBMUTE

- **Description:** Mutes the output channel, syncs remain
- **Parameters:** RGBMUTE [output] [state]
Set RGB Mute to state for specified output.

RPRST num

- **Description:** Recall an existing preset from a preset location and update current front panel configuration/routing. If no preset information has been saved to the preset location, no changes are made.
- **Parameters:**
out Preset number to recall from; [1 - 8]
▲ RPRST 1 (Recalls configuration from preset location 1.)

RTEMP out in

- **Description:** Routes inputs to outputs (pend). If the output is in a group, all the outputs in the group will be routed to the input specified. If the output is in a I/O group but the input is not in the group, the command will be ignored.
- **Parameters:**
[output] Output number; [1 - 8]
[input] Video Input number to route video; [1-8] / 101 if no input to add / 0 unroutes input
- **Query:** RTEMP? out; Returns the current video inputs routed to the specified output in the format: =in
▲ **Examples:**
RTEMP 1 3 (Route to output 1, video input 3.)
RTEMP 4 101 (Route to output 4.)

SPARAMS

- **Description:** Set serial settings
- **Parameters:**
[BaudRate] Set Baud Rate: 0=2400, 1=4800, 2=9600, 3=19200, 4=38400, 5=57600, 6=115200

TAKE en

- **Description:** Activate or cancel all pending video/audio routes.
- **Parameters:**
en Mode; [0|1], Cancel all pending|Activate all pending.

Note

Issuing parameter **0** is the equivalent of pressing **CANCEL**.
Issuing **1** is the equivalent of pressing the **TAKE** button.

- ▲ TAKE 1 (Activates all pending video routes.)

TPAT

- **Description:** Selects test pattern
- **Parameters:** TPAT [type] Set Test Pattern to specified type
 - ~ 0=H Ramp, 1=V Ramp, 2=100p Col Bars, 3=16x Grid
 - ~ 4=32x Grid, 5=Burst, 6= 75p Col Bars, 7=50p Gray
 - ~ 8=Gr Stp1, 9=Gr Stp2, 10=White, 11=Black
 - ~ 12=Red, 13=Green, 14=Blue

WHOAREYOU

- **Description:** Query identity of this serial/ethernet connection
Returns the name of the system

HELP

- **Description:** Displays a list of available commands on a terminal emulator such as ProComm or Hyperterminal.
- **Parameters:** None
 - ▲ **Example:** HELP (Returns the command list.)

?

- **Description:** Display specific command plus parameter description. Type command followed by ? for specific command parameters.

B. Remote Control Protocol

MatrixPRO Remote Commands

C. Contact Information

In This Appendix

The following topics are discussed in this Appendix:

- [Warranty](#)
 - [Return Material Authorization \(RMA\)](#)
 - [Contact Information](#)
-

Warranty

All video products are designed and tested to the highest quality standards and are backed by a full 3-year parts and labor warranty. Warranties are effective upon delivery date to customer and are non-transferable. Barco warranties are only valid to the original purchaser/owner. Warranty related repairs include parts and labor, but do not include faults resulting from user negligence, special modifications, lightning strikes, abuse (drop/crush), and/or other unusual damages.

The customer shall pay shipping charges when unit is returned for repair. Barco will cover shipping charges for return shipments to customers.

Return Material Authorization (RMA)

In the unlikely event that a product is required to return for repair, please call the following number and ask for a Sales Engineer to receive a Return Merchandise Authorization number (RMA).

- (888) 414-7226

RMA Conditions are listed below:

- Prior to returning any item, you must receive a Return Merchandise Authorization (RMA) number.
- All RMA numbers must appear on their return-shipping label.
- RMA numbers are valid for ten (10) days from issue date.
- All shipping and insurance charges on all RMAs must be prepaid by the customer

C. Contact Information

Contact Information

Contact Information

Barco Media and Entertainment

11101 Trade Center Drive
Rancho Cordova, California 95670
USA

- Phone: (916) 859-2500
- Fax: (916) 859-2515
- Websites:
 - ~ www.folsom.com
 - ~ www.events.barco.com

Sales Contact Information

- Direct: (916) 859-2505
- Toll Free: (888) 414-7226
- E-mail: folsomsales@barco.com

Barco N.V.

Noordlaan 5
8520 Kuurne
BELGIUM

- Phone: +32 56.36.82.11
- Fax: +32 56.35.16.51
- Website: www.events.barco.com

Technical Support Information

- Tech Line: (866) 374-7878 — 24 hours per day, 7 days per week
- E-mail: folsomsupport@barco.com

Index

A

About	
dialog	62
MatrixPRO	14
tab	76
AC	
connector	22
power cords	26
Acrobat usage	13
navigating and searching	13
Active controls	59
Address, company	3
ADJUST	30
knob	18, 20
using knob	32
Adjust	
cable equalization	42
system parameters	36
Agency specifications	87
Application questions	15

B

Barco	
company address	3
Events, contact information	102
Folsom website	54
sales contact information	102
technical support information	102
Warranty	101
Button	
ESC	20
RGB MUTE	19
SEL	20
TAKE	19
TEST PAT	18

C

Cable	
equal	35, 42
equalization menu	42
Change	
connection to Ethernet	75
connection to RS-232	75
DHCP setting	37
history	6
IP address	38
RS-232 baud rate	37
subnet mask	38
Chapter structure	12
Check router status	49
Choose Destination Dialog	55
CLEAR	95
Clear All Routing	64
COM Port Sub-menu	61
Command syntax, RS-232	93
Communications specifications	87
Company address	3
Configuration	
recall	47
save	46
Connect to MatrixPRO DVI	61
Connection troubleshooting	58
Connectivity, system diagram	15
Connector	
AC	22
DVI input	21
DVI output	21
DVI pinouts	88
Ethernet pinouts	89
serial pinouts	90
Connectors	
front panel	18
rear panel	21
Contact information	102
Control	
application	57
overview	30
panel, unlock	52

Index

Conventions	13
menu system	32
Convert, scan	15
Copyright	2
Crosspoint selection buttons	
input	18
output	18
Current	
GUI software revision	76
input/output assignments	40
Cursor	20
edit	32
navigation	32

D

Default	
EDID value	42
IP address	82, 92
serial parameters	92
DHCP	37, 95
Diagram	
system	27
system connectivity	15
Dialog	
about	62
choose destination	55
Ethernet connection	82
installation complete	56
start installation	56
welcome	55
Disconnect Serial Communication	61
Display	20
section	18, 20
Documentation	
conventions	13
symbols	13
Double arrow	20
Download software	79
via FTP site	79
via web site	79
DVI	
connector pinouts	88
input connectors	21
output connectors	21

E

EDID	
default value	42
programming	41
resolution menu	41
setup	35

Edit cursor	32
Electrical specifications	87
Equipment marking terms	5
ESC	20, 30
using	32
Ethernet	
connection dialog	82
connection to GUI	57
connector pinouts	89
port	21
socket	57
Exit, file	60
Extended Display Identification Data	41

F

Factory Reset	
MatrixPRO	75
menu	39
FCC statement	2
Features, MatrixPRO	14
File	
exit	60
menu	60
open configuration file	60
save configuration file	60
Firmware files	78
Flash Loader	80, 82
FPLOCK	95
Front panel	
connectors	18
display section	18
lockout check box	75
FTP	
server	54
site	79
Function, quick reference table	34

G

GADD	95
GCLEAR	95
GDEL	96
General operations	13
Grouping Tab	71
Groups	
rules	51
working with	51
Guarantee and compensation	2
GUI	
clear a route	67
connection troubleshooting	58
current software revision	76
Ethernet connection	57

- how to run57
 - installation54
 - installation and operation53
 - mute an output67
 - overview59
 - perform a multi-take66
 - perform a take66
 - recall presets69
 - save presets68
 - serial connection57
 - switching operations65
 - work with labels70
- H**
- Hardware
 - installation23
 - orientation17
 - requirements, upgrading software78
 - HELP99
 - History, change6
 - How to
 - add an input/output to existing group72
 - add input/output to group51
 - adjust cable equalization42
 - adjust IP address38
 - adjust subnet mask38
 - change DHCP setting37
 - change RS-232 baud rate37
 - change VFD brightness36
 - check router status49
 - clear a route, GUI67
 - clear all groups72
 - clear existing group72
 - clear route49
 - create a sequence73
 - create input/output group51, 72
 - enable/disable raster box45
 - enable/disable vertical switching45
 - install MatrixPRO control software54
 - install power26
 - install signals27
 - mute an output, GUI67
 - perform a multi-take49
 - perform a multi-take, GUI66
 - perform a take48
 - perform a take, GUI66
 - perform factory reset39
 - power up MatrixPRO30
 - pre-select a test pattern44
 - program EDID41
 - recall preset47
 - recall presets, GUI69
 - recall router configuration47
 - remove input/output from group51, 72
 - route a test pattern50
 - run the GUI57
 - save preset46
 - save presets, GUI68
 - save router configuration46
 - troubleshoot Ethernet connection83
 - troubleshoot Ethernet GUI connection ...58
 - troubleshoot serial GUI connection58
 - unlock control panel52
 - upgrade software via Ethernet82
 - upgrade software via serial80
 - use RGB Mute50
 - use this guide13
 - work with labels70
 - Hyperlinks13
- I**
- Inactive controls59
 - Input
 - connectors, DVI21
 - selection buttons18
 - specifications86
 - Input/Output assignments, current40
 - Inputs section, GUI63
 - Inspection24
 - Installation
 - complete dialog56
 - GUI53, 54
 - hardware23
 - power26
 - rack mount25
 - safety precautions24
 - signals27
 - site preparation24
 - unpacking and inspection24
 - Installed version of software39
 - Introduction to MatrixPRO11
 - IP96
 - address, change38
 - address, default82, 92
 - address, menu37

Index

IPINFO96

L

Labeling Tab70
LOADRMP96
Lockout message52

M

Main Menu, using35
MatrixPRO
 about14
 control application57
 control overview30
 features14
 front panel connectors18
 hardware installation23
 hardware orientation17
 introduction to11
 lockout message52
 operating procedures48
 operation29
 rear panel connectors21
 remote commands94
 remote control protocol91
 serial command list95
 specifications85
 upgrading software77
Menu
 bar, using60
 cable equalization42
 display20
 EDID resolution41
 factory reset39
 file60
 IP address37
 lockout message52
 overview32
 recall configuration47
 RS-232 settings37, 81
 rules and conventions32
 save configuration46
 serial port61
 setup36
 status40
 subnet38
 system36
 tech support39
 test pattern18, 43
 tree31
 vertical switching45
 VFD brightness36

Mnemonics64, 70
MPRC96
Multi-take, perform49

N

Navigation cursor20, 32
Neutrik EtherCon22
Notice2
NSTAT97

O

Open configuration file60
Operating procedures48
Operation
 GUI53
 MatrixPRO29
Operations
 general13
 GUI65
Operators safety summary4
Orientation, hardware17
OSTAT96
Output
 connectors, DVI21
 resolution, test pattern43
 section, GUI64
 selection buttons18
 specifications86
Overview
 control30
 GUI59
 menu system32
 software upgrade78

P

PDF file usage13
 navigating and searching13
Phone number, technical support39
Physical specifications87
Pinouts88
 DVI connector88
 Ethernet connector89
 serial connector90
Port
 Ethernet21
 serial21
Power
 cord, line voltage selection26
 installation26
 up and initialization30

- Preset
 - recall47
 - save46
- Presets section, GUI64
- Protocol, remote control91
- PRST97
- PSTAT97

- Q**

- Quick function reference34

- R**

- Rack mount installation25
- Raster Box43, 45
 - enable/disable45
- Read from MatrixPRO57, 61, 64
- Rear panel connectors21
- Recall
 - configuration menu47
 - preset35, 47
- Reference, quick function table34
- Remote
 - commands, MatrixPRO94
 - control protocol91
- Reset MatrixPRO75
- RESETMP97
- Return material authorization101
- REV97
- RGB MUTE19
- RGB Mute
 - column, GUI64
 - how to use50
- RGBMUTE98
- RMA101
- Route, clear49
- Router, check status49
- RPRST98
- RS-232
 - command syntax93
 - mode93
 - settings menu37, 81
 - terminal window76
- RTEMP98
- Run GUI57

- S**

- Safety
 - precautions24
 - summary4

- Sales contact information102
- Save
 - configuration file60
 - configuration menu46
 - preset35, 46
- Scan convert15
- Section
 - display20
 - inputs, GUI63
 - outputs, GUI64
 - presets, GUI64
- SEL20, 30
 - using32, 33
- Sequencing Tab73
- Serial
 - command list95
 - connection to GUI57
 - connector pinouts90
 - parameters92
 - port21
- Serial command
 - ?99
 - CLEAR95
 - DHCP95
 - FPLOCK95
 - GADD95
 - GCLEAR95
 - GDEL96
 - HELP99
 - IP96
 - IPINFO96
 - LOADRMP96
 - MPRC96
 - NSTAT97
 - OSTAT96
 - PRST97
 - PSTAT97
 - RESETMP97
 - REV97
 - RGBMUTE98
 - RPRST98
 - RTEMP98
 - SPARAMS98
 - TAKE98
 - TPAT99
 - WHOAREYOU99
- Serial Port
 - connect to MatrixPRO DVI61
 - disconnect serial communication61
 - menu61
 - Read from MatrixPRO61
 - settings (Adv user only)61
- Settings (Adv user only)61
- Setup35
 - menu36
 - tab75

Index

Signal installation	27
Site preparation	24
Software	
downloading	79
installed version	39
requirements, upgrading	78
upgrade overview	78
upgrading	77
SPARAMS	98
Specifications	85
agency	87
communications	87
electrical	87
input	86
output	86
physical	87
pinouts	88
Start Installation Dialog	56
Status	35
menu	40, 49
Subnet	
mask	38
menu	38
Support, technical information	102
Symbols	13
System	
diagram	27
menu	36

T

Tab	
about	76
grouping	71
labeling	70
sequencing	73
setup	75
video switching	63
Table, quick function reference	34
TAKE	
button	19
perform	48
serial command	98
Tech Support Menu	39
Technical support	
information	102
phone number	39
Terms, equipment marking	5
TEST PAT	18
Test Pattern	35
how to route	50
menu	18, 43

TPAT	99
Trademarks	3
Tree, menu	31
Troubleshoot	
Ethernet connection	83
GUI connection	58

U

Unlock control panel	52
Unpacking	24
Upgrade	
via Ethernet	82
via serial	80
Upgrading software	77
Using	
about tab	76
ESC button	32
grouping tab	71
labeling tab	70
main menu	35
menu bar	60
SEL button	32, 33
sequencing tab	73
setup tab	75
video switching tab	63

V

Vertical	
switch	35
switching menu	45
VESA standard	41
VFD Brightness Menu	36
Video	
column, GUI	64
switching tab	63
Voltage selection	26

W

Warranty	101
Web site	79
Welcome Dialog	55
WHOAREYOU	99
Working with groups	51

Free Manuals Download Website

<http://myh66.com>

<http://usermanuals.us>

<http://www.somanuals.com>

<http://www.4manuals.cc>

<http://www.manual-lib.com>

<http://www.404manual.com>

<http://www.luxmanual.com>

<http://aubethermostatmanual.com>

Golf course search by state

<http://golfingnear.com>

Email search by domain

<http://emailbydomain.com>

Auto manuals search

<http://auto.somanuals.com>

TV manuals search

<http://tv.somanuals.com>