

LED-PRO™



User's Guide

- Manual # 26-0501000-00
- Revision B



LED-PRO • User's Guide

Copyright

© Barco, Inc. May 1, 2006

All rights reserved. No part of this document may be copied, reproduced or translated. It shall not otherwise be recorded, transmitted or stored in a retrieval system without the prior written consent of Barco.

Notice

Barco provides this manual "as is" without warranty of any kind, either expressed or implied, including but not limited to the implied warranties or merchantability and fitness for a particular purpose. Barco may make improvements and/or changes to the product(s) and/or the program(s) described in this publication at any time without notice.

This publication could contain technical inaccuracies or typographical errors. Changes are periodically made to the information in this publication; these changes are incorporated in new editions of this publication.

Federal Communications Commission (FCC) Statement

This equipment has been tested and found to comply with the limits for a class A digital device, pursuant to Part 15 of the FCC rules. These limits are designed to provide reasonable protection against harmful interference when the equipment is operated in a commercial environment. This equipment generates, uses, and can radiate radio frequency energy and, if not installed and used in accordance with the instruction manual, may cause harmful interference to radio communications. Operation of this equipment in a residential area may cause harmful interference, in which case the user will be responsible for correcting any interference.

Guarantee and Compensation

Barco provides a guarantee relating to perfect manufacturing as part of the legally stipulated terms of guarantee. On receipt, the purchaser must immediately inspect all delivered goods for damage incurred during transport, as well as for material and manufacturing faults. Barco must be informed immediately in writing of any complaints.

The period of guarantee begins on the date of transfer of risks, in the case of special systems and software on the date of commissioning, at latest 30 days after the transfer of risks. In the event of justified notice of complaint, Barco can repair the fault or provide a replacement at its own discretion within an appropriate period. If this measure proves to be impossible or unsuccessful, the purchaser can demand a reduction in the purchase price or cancellation of the contract. All other claims, in particular those relating to compensation for direct or indirect damage, and also damage attributed to the operation of software as well as to other services provided by Barco, being a component of the system or independent service, will be deemed invalid provided the damage is not proven to be attributed to the absence of properties guaranteed in writing or due to the intent or gross negligence or part of Barco.

If the purchaser or a third party carries out modifications or repairs on goods delivered by Barco, or if the goods are handled incorrectly, in particular if the systems are commissioned operated incorrectly or if, after the transfer of risks, the goods are subject to influences not

agreed upon in the contract, all guarantee claims of the purchaser will be rendered invalid. Not included in the guarantee coverage are system failures which are attributed to programs or special electronic circuitry provided by the purchaser, e.g. interfaces. Normal wear as well as normal maintenance are not subject to the guarantee provided by Barco either.

The environmental conditions as well as the servicing and maintenance regulations specified in this manual must be complied with by the customer.

Trademarks

Brand and product names mentioned in this manual may be trademarks, registered trademarks or copyrights of their respective holders. All brand and product names mentioned in this manual serve as comments or examples and are not to be understood as advertising for the products or their manufactures.

Company Address



Barco Media and Entertainment
11101 Trade Center Drive
Rancho Cordova, California 95670
USA

- Phone: (916) 859-2500
- Fax: (916) 859-2515
- Websites:
 - ~ www.folsom.com
 - ~ www.events.barco.com

Barco N.V.
Noordlaan 5
8520 Kurne
BELGIUM

- Phone: +32 56.36.82.11
- Fax: +32 56.35.16.51
- Website: www.barco.com

Operators Safety Summary

The general safety information in this summary is for operating personnel.

Do Not Remove Covers or Panels

There are no user-serviceable parts within the unit. Removal of the top cover will expose dangerous voltages. To avoid personal injury, do not remove the top cover. Do not operate the unit without the cover installed.

Power Source

This product is intended to operate from a power source that will not apply more than 230 volts rms between the supply conductors or between both supply conductor and ground. A protective ground connection by way of grounding conductor in the power cord is essential for safe operation.

Grounding the Product

This product is grounded through the grounding conductor of the power cord. To avoid electrical shock, plug the power cord into a properly wired receptacle before connecting to the product input or output terminals. A protective-ground connection by way of the grounding conductor in the power cord is essential for safe operation.

Use the Proper Power Cord

Use only the power cord and connector specified for your product. Use only a power cord that is in good condition. Refer cord and connector changes to qualified service personnel.

Use the Proper Fuse

To avoid fire hazard, use only the fuse having identical type, voltage rating, and current rating characteristics. Refer fuse replacement to qualified service personnel.

Do Not Operate in Explosive Atmospheres

To avoid explosion, do not operate this product in an explosive atmosphere.

Terms In This Manual and Equipment Marking



WARNING

Highlights an operating procedure, practice, condition, statement, etc., which, if not strictly observed, could result in injury to or death of personnel.

Note

Highlights an essential operating procedure, condition or statement.



CAUTION

The exclamation point within an equilateral triangle is intended to alert the user to the presence of important operating and maintenance (servicing) instructions in the literature accompanying the appliance.



AVERTISSEMENT!

Le point d'exclamation dans un triangle équilatéral signale à alerter l'utilisateur qu'il y a des instructions d'opération et d'entretien très importantes dans la littérature qui accompagne l'appareil.



VORSICHT

Ein Ausrufungszeichen innerhalb eines gleichwinkligen Dreiecks dient dazu, den Benutzer auf wichtige Bedienungs- und Wartungsanweisungen in der dem Gerät beiliegenden Literatur aufmerksam zu machen.

Change History

The table below lists the changes to the LED-PRO User's Guide.

Table 0-1. Change History

Rev	Date	ECO #	Description	Approved By
A	8/1/05	1478	Release	Jim Wickenhiser
B	5/1/06	1620	Change summary: <ul style="list-style-type: none">• Added new features including Setup Wizard, Input Wizard, diagonal test pattern scrolling and 50/60Hz refresh rate selection.• Restructured system menus by adding LED Menu, Source Alignment Menu and Expert Mode Menu.• Revised document template. In Chapter 1, refer to the " What's New in Firmware Version 2.0 " section on page 5 for full details on all new features.	Jim Wickenhiser

Table of Contents

Chapter 1	Introduction	1
	In This Chapter	1
	Chapter Structure	2
	How to Use This Guide	3
	Navigating	3
	Table of Contents and Index	3
	Conventions	3
	About the LED-PRO	4
	Features	4
	What's New in Firmware Version 2.0	5
	Connectivity Diagram	7
	Application Questions	8
Chapter 2	Hardware Orientation	9
	In This Chapter	9
	LED-PRO Front Panel	10
	Display Section	11
	Menu Keys Section	12
	Inputs Section	13
	About the LOGO	14
	LED-PRO Rear Panel	15
Chapter 3	Installation	17
	In This Chapter	17
	Safety Precautions	18
	Unpacking and Inspection	18
	Site Preparation	18
	Cable and Adapter Information	18
	Rack-Mount Installation	19
	Power Installation	19
	Power Cord/Line Voltage Selection	20
	Signal Installation	21
	Format Connection Table	23
Chapter 4	Operation	25
	In This Chapter	25
	Control Overview	26
	Power-Up Initialization	26
	Standard Bootup	26
	Bootup in Ethernet Mode	27

Table of Contents

Bootup with a Stored LOGO	28
Quick Setup and Operations	29
Menu Tree	30
Using the Menu System	31
Quick Function Reference	33
Using the Status Menu	36
Status Menu Access	36
Status Menu Description	37
Using the Setup Menu	39
Setup Menu Tree	40
Setup Menu Description	41
Setup Wizard	42
Input Wizard	42
Source Alignment — Analog	43
Contrast	43
Brightness	44
Red Contrast	44
Red Bright	44
Grn Contrast	44
Grn Bright	44
Blue Contrast	44
Blue Bright	44
Sharpness	45
Clip to SubBlk	45
Luma Tracking	45
EDID DVI	45
Source Alignment — SDI	46
Contrast	46
Brightness	46
Hue	46
Saturation	47
Sharpness	47
Clip to SubBlk	47
Luma Tracking	47
EDID DVI	47
Source Alignment — DVI	48
Contrast	48
Brightness	48
Sharpness	48
EDID DVI	48
Presets	49
Recall	49
Save	50
Delete	50
RS232	51
Expert Mode	51
Save System State	51
Factory Reset	52
Programming EDID	53
Using the Setup Wizard	56
Using the Input Wizard	62
Using the Expert Mode Menu	66
Expert Mode Menu Tree	66
Expert Mode Menu Description	67
Input	68

Input Format	69
Sampling	69
Timing Adjust	70
Type	72
Colorspace	72
Source Alignment	72
Custom In Format	72
Aspect Ratio	76
Display Mode	76
Letterbox	76
Processing	77
Save Config	78
Reset Config	78
Recall Config.	78
Delete Config	79
Unsaved Changes	79
Output	80
Timing Adjust	81
Refresh Rate	81
LED Control	82
LED Status	82
LED Contrast	82
LED Gamma	82
LED Information	82
Lock to Source	83
Minimum Delay	83
Save Config	84
Reset Config	84
Effects	85
Trans With.	85
Trans Time	85
Logo	86
Capture Logo	86
Delete Logo.	86
Logo Present.	86
In Auto Acquire	87
Freeze	87
System	88
VFD Brightness	88
Diagnostic RS232	88
Ethernet	89
EDID DVI In Frmt	91
Lock Front Panel	91
Save System State	92
Unsaved Changes	92
Software Version	92
Factory Reset	92
Using the Test Pattern Menu	93
Test Pattern Menu Tree	93
Test Pattern Menu Description	93
Type	94
Raster Box	94
Diagonal Motion	94
Using the Pan & Zoom Menu	95
Pan & Zoom Menu Tree	95

Table of Contents

Pan & Zoom Menu Description	96
Pan H	96
Pan V	96
Zoom	97
Save Preset	97
Recall Preset	97
Reset	97
Using the LED Menu	98
LED Menu Tree	98
LED Menu Description	99
LED Control	100
LED Status	100
LED Contrast	100
LED Gamma	100
LED Information	101
LED Type	101
Tile Count	101
LED-PRO ID	101
LED Wall ID	101
Fiber Tx ID	102
Fiber Rx ID	102
LED Test Pattern	102
Source	102
Type	102
LED OSD	102
Status	103
Type	103
Boost Mode	103
Creative Mode	103
Tile Mode	103
RS232	104
Save Config	104
Reset Config	104
Using the Input Position Menu	105
Input Position Menu Tree	105
Input Position Menu Description	106
H Position	106
H Size	106
V Position	107
V Size	107
Save Config	107
Reset Config	108
Recall Config	109

Chapter 5

Upgrading Software.....111

In This Chapter	111
Software Upgrade Overview	112
Hardware Requirements	112
Software Requirements	112
Downloading Software	113
Via FTP Site	113
Via Web Site	113

Serial Upgrade Method. 114

Appendix A Specifications. 117

In This Appendix 117
 Input Specifications 118
 Output Specifications 119
 User Control Specifications 119
 Physical and Electrical Specifications 119
 Communications Specifications 120
 Agency Specifications 120
 Pinouts 121
 Analog 15-pin D Connector 121
 DVI-I Connector Pinouts 122
 Ethernet Connector 123
 Serial and Diagnostic Connector 124

Appendix B Remote Control Protocol. 125

In This Appendix 125
 Default Serial Parameters 126
 Diagnostics Port. 126
 RS-232 Port. 126
 Default IP Address 127
 RS-232 Mode 127
 LED-PRO Remote Commands. 128
 Resolution Remote Commands. 128
 Input Remote Commands 128
 Output Remote Commands 131
 Custom Format Remote Commands 132
 System and Ethernet Remote Commands 133
 Logo Remote Commands 133
 Effects Related Commands 134
 Pan/Zoom/View Remote Commands 134
 LED-PRO Serial Command Descriptions 135
 RESH 135
 RESI nn 135
 ACQ mode. 135
 DINT in mode 135
 PCOMP in mode 136
 FREEZ mode. 136
 IAR in n cn. 136
 IAUTO 137
 IBRT in nnn.n 137
 ICNT in nnn.n 137
 ICPHO in nn 137
 ICLIST 138
 ICDEL filename 138
 ICREC in filename. 138
 ICRST in 138
 ICSAV in filename 138

Table of Contents

ICSP in mode	139
ICUSE in	139
IEDGE in edge nnnn	139
IGM in n	139
IHATV nnnn	140
IHPOS nnnn	140
IHTOTAL nnnn	140
IHUE in nnn	141
ILB in mode	141
IRBRT in c nn.n	141
IRCNT in c nnn.n	142
ISAT in nnn	142
ISMP in n	142
ISYNC in mode	143
ISYNCSLICE in nnn	143
ITYPE in mode	143
IVATV nnnn	144
IVPOS nnnn	144
IVTOTAL?	144
IVREC in	144
IVSAV in	145
LCK? in	145
RTE in	145
ICLIP	145
ILUMA	145
ISHRP	145
LCKMODE mode type	145
LCKPHASE h	146
OCNT nnn	146
OCRST	146
OCSAV	146
OGM mode	147
OHATV nnnn	147
OHPOS nnnn	147
OHSYNC nnnn	147
OHTOTAL nnnn	148
OTPM type raster	148
OVATV nnnn	148
OVPOS nnnn	149
OVSYNC nnnn	149
OVTOTAL nnnn	149
EFLIST	150
EFRES nn	150
EFRESH	150
EFINT mode	150
EFHTOTAL nnnn	150
EFHATV nnnn	151
EFHFP nn	151
EFHSYNC nn	151
EFHRATE?	151
EFVTOTAL nnnn	152
EFVATV nnnn	152

EFVFP nn 152
 EFVSYNC nn 152
 EFVRATE nnn.n 153
 EFSAV 153
 EFDEL 153
 DMSG mode 153
 ENETM 153
 EDHCP 154
 EECHO mode 154
 EIP xxx.xxx.xxx.xxx yyy.yyy.yyy.yyy zzz.zzz.zzz.zzz 154
 EMAC? 154
 SBAUD n 155
 SYSAV 155
 HELP [op] 155
 LOADR 155
 RESET 155
 WALLSTANDBY 155
 MINMODE 156
 MINSTAT 156
 LOCKOUT 156
 LOGOD 156
 LOGOL 156
 LOGOS 156
 LOGOI 156
 TRN type n 156
 PANH nnn.n 157
 PANV nnn.n 157
 VIEW? nn 157
 VIEWD nn 158
 VIEWR nn 158
 VIEWS nn 158
 VIEWI? in 158
 VIEWIR 158
 VIEWIS in 158
 ZOOM nnn.n 159

Appendix C Contact Information 161

In This Appendix 161
 Warranty 161
 Return Material Authorization (RMA) 161
 Contact Information 162

Index 163

Table of Contents

1. Introduction

In This Chapter

This chapter is designed to introduce you to the LED-PRO™ User's Guide. Areas to be covered are:

- [Chapter Structure](#)
- [How to Use This Guide](#)
- [Conventions](#)
- [About the LED-PRO](#)
- [Features](#)
- [What's New in Firmware Version 2.0](#)
- [Connectivity Diagram](#)
- [Application Questions](#)

Chapter Structure

The following chapters provide instructions for all aspects of LED-PRO operations:

- Chapter 1, "[Introduction](#)" provides a system overview, a list of features, and a system connectivity diagram.
- Chapter 2, "[Hardware Orientation](#)" on page 9 provides detailed diagrams of the system's front and rear panels.
- Chapter 3, "[Installation](#)" on page 17 provides comprehensive system installation instructions.
- Chapter 4, "[Operation](#)" on page 25 provides menu tress, plus comprehensive system operating instructions.
- Chapter 5, "[Upgrading Software](#)" on page 111 outlines procedures for upgrading system software components.
- Appendix A, "[Specifications](#)" on page 117 lists the LED-PRO's specifications.
- Appendix B, "[Remote Control Protocol](#)" on page 125 provides detailed information regarding external remote control protocol.
- Appendix C, "[Contact Information](#)" on page 161 lists important Barco contact, RMA, warranty and technical support details.

How to Use This Guide

Following are important tips for streamlining your use of this User's Guide in its electronic "PDF" form.

Navigating

Use Acrobat Reader's "bookmarks" to navigate to the desired location. All chapter files have the same bookmark structure for instant navigation to any section. Please note:



- Extensive hyperlinks are provided within the chapters.
- Use Acrobat's "**Go to Previous View**" and "**Return to Next View**" buttons to trace your complete navigational path.
- Use the "**Previous Page**" and "**Next Page**" buttons to go to the previous or next page within a file.
- Use Acrobat's extensive search capabilities, such as the "**Find**" tool and "**Search Index**" tool to perform comprehensive searches as required.

Table of Contents and Index

Use the **Table of Contents** bookmarks to navigate a desired topic. Click any item to instantly jump to that section of the guide. You can also use the **Index** to jump to specific topics within a chapter. Each page number in the **Index** is a hyperlink.

Conventions

The following conventions are used throughout this guide:

- The symbol ■ denotes an operations procedure.
- The symbol ▲ denotes an example.
- Entries written in bold-face capital letters denote physical buttons or chassis connectors.
- ▲ Press **TEST PAT** to ...
- The term "**select**" is used as an abbreviation for "scroll to a selected menu line and press the **SEL** button."
- A sequence of menu steps is represented by the menu names, separated by arrows (>).

▲ **SETUP > Expert Mode > System**

... indicates the following sequence:

- a. Press **SETUP** to display the **Setup Menu**.
- b. Scroll to the **Expert Mode** line and press **SEL** to display the **Expert Mode Menu**.
- c. Scroll to the **System** line and press **SEL** to display the **System Menu**.

1. Introduction

About the LED-PRO

About the LED-PRO

The LED-PRO is a powerful all-in-one signal processor that accepts a wide range of video input signals, and processes them to drive Barco LED displays. The LED-PRO allows you to scale visual sources and mix them in multiple ways while still maintaining superb picture quality.

LED-PRO is the ideal solution for converting RGB, HDTV, component, S-video, composite (NTSC, PAL and SECAM), SDI, DVI, and HDSDI for use with Barco LED walls.

LED-PRO has an advanced feature set that includes universal inputs, aspect ratio conversion, memory presets, test patterns, source lock, picture adjustments, motion adaptive de-interlacing, and 3:2 and 2:2 pulldown detection. Refer to the [“Features”](#) section on page 4 for full details.

Please note:

- To ensure trouble-free operation, please follow all procedures in the **Installation** and **Operation** sections of this manual. Refer to Chapter 3, [“Installation”](#) on page 17 and Chapter 4, [“Operation”](#) on page 25 for details.
- Should you have any questions regarding the installation or operation of the LED-PRO system, please consult with the factory. Refer to Appendix C, [“Contact Information”](#) on page 161 for information.

Features

The LED-PRO utilizes the proprietary Athena scaler, for high performance image processing. The following features are provided:

- Three universal inputs accept:
 - ~ RGBHV/RGBS/RGsB computer video
 - ~ Component video (STD or HDTV)
 - ~ S-Video
 - ~ Composite video with loop-through
- SD SDI/HD SDI input.
- DVI-I connectors support both universal analog and DVI input with loop-through.
- DVI output connector for Barco LED Display interface.
- Input video detection and auto-acquisition. LED-PRO will auto detect and match input video to stored formats or user configurations.
- Aspect ratio conversion and adjustments.
- Freeze, pan and zoom.
- 10-Bit processing, plus motion adaptive and field-to-frame de-interlacing modes.
- 3:2 pulldown detection for NTSC, 2:2 film detection for PAL video sources
- Decodes NTSC, PAL, and SECAM.
- Ethernet connector for remote control.
- Vertical lock (lock to source) eliminates image tears and other artifacts in scaled motion video by eliminating frame rate conversion.

- 60 independent input configuration memory presets.
- Low video delay (3 input fields max., 20 lines min.)
- Logo image capture and recall.
- Dissolve to/from stored logo.

What's New in Firmware Version 2.0

This section lists the new features that have been implemented since the last revision of the LED-PRO User's Guide. Reference links are provided for additional details.

- **Setup Wizard**

The Setup Wizard allows users to set up and configure a basic LED display without the need of the Director Toolset. The Wizard automatically guides the user through the entire setup process, including:

- ~ Wall detection (tile resolution)
- ~ Addressing and positioning tiles
- ~ Aligning LED-PRO's output resolution to match the wall
- ~ Wall contrast and gamma adjustment

Please note the following important points:

- ~ The Wizard can only be used with standard LED Tiles. MiPIX, MiSPHERE and creative OLite displays require the Director Toolset.
- ~ The Director Toolset is still required for wall color calibration, tile firmware updates, and for creating and applying custom gamma curves.

In Chapter 4, refer to the "[Using the Setup Wizard](#)" section on page 56 for details.

- **Input Wizard**

The Input Wizard allows users to easily setup and configure input sources. It automatically detects and re-scales the selected input source to match the physical size of the LED display. In Chapter 4, refer to the "[Using the Input Wizard](#)" section on page 62 for details.

- **Input Source Alignment**

This new menu enables you to adjust the input sources as well as the typical LED related adjustments, such as **Clip to Sub-black** and **Luma Tracking**. In Chapter 4, refer to the "[Source Alignment — Analog](#)" section on page 43 for details. Additional sections are provided for SDI and DVI sources.

- **Expert Mode**

This mode gives experienced LED-PRO users the ability to perform more in-depth alignments. In Chapter 4, refer to the "[Using the Expert Mode Menu](#)" section on page 66 for details.

- **50/60 Hz**

This new function enables you to select either a 50Hz (PAL) or 60Hz (NTSC/PC) refresh rate. The selection can be made in both the Expert mode and while using the Wizard. The tile timings will also be adapted automatically when using the Wizard. In Chapter 4, refer to the "[Using the Setup Wizard](#)" section on page 56 for details.

1. Introduction

Features

- **Test Pattern — Diagonal Scrolling Mode**

This new feature enables users to enable “diagonal scrolling” of any selected test pattern. In Chapter 4, refer to the [“Using the Test Pattern Menu”](#) section on page 93 for details.

- **LED Menu**

This improved menu provides access to many LED-related features:

- ~ LED Status (ON/OFF)
- ~ LED contrast and gamma
- ~ LED information (type, size)
- ~ LED internal test patterns (turn on/off, select primary colors)
- ~ LED OSD (full OSD access)
- ~ Boost and Creative modes (OLite only)
- ~ Tile mode (virtual — real mode selection)

In Chapter 4, refer to the [“Using the LED Menu”](#) section on page 98 for details.

- **Director Toolset Patch**

Important

Please note the following important points regarding the Director Toolset:

- ~ Customers using LED-PRO with the Director Toolset version **1.04** do not require any software patches.
- ~ Customers that downloaded Director Toolset version **1.03** *must* download a new patch (version **1.03.01**) to ensure proper LED-PRO operation. The patch is located on the Barco website, at the following location:

Link: [Director Toolset Patch](#)

Scroll down to the LED-PRO section and follow the directions to install the patch.

Connectivity Diagram

The figure below provides a sample connectivity diagram:

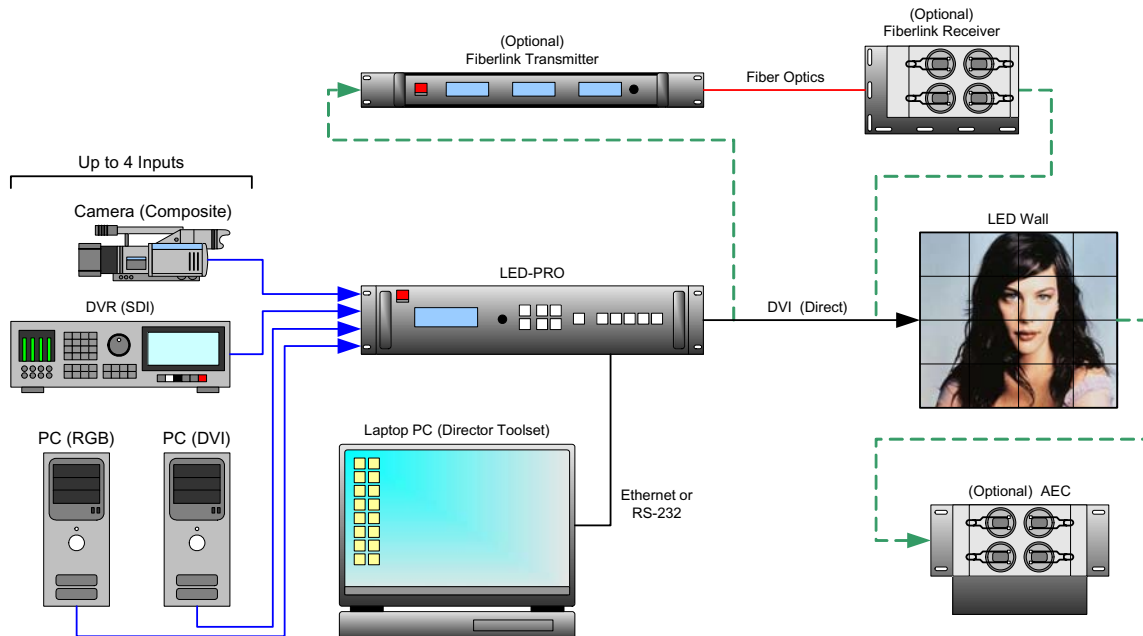

Figure 1-1. LED-PRO System Diagram (sample)

Please note the following points regarding the diagram:

- The maximum of four inputs are shown, one each in RGB, DVI, Composite and HD-SDI formats.
- Two different paths from LED-PRO to the LED wall are shown:
 - ~ Via DVI, direct between the LED-PRO and the wall.
 - ~ Via DVI and fiber optics, via the optional Barco Fiberlink Transmitter and Receiver.
 - ~ An optional Barco AEC (Ambient Environment Controller) is shown.
 - ~ The (customer supplied) laptop PC is required for LED wall calibration, via Director Toolset.

Note

Contact your Barco sales representative for information on Fiberlink and AEC systems. These products are not discussed in this user's guide.

1. Introduction

Application Questions

Application Questions

At Barco, we take pride in offering unique solutions to demanding technical problems. If you have application questions, require further information or would like to discuss your application requirements in more detail, please call (916) 859-2500. Our Customer Support Engineers will be happy to supply you with the support you need. Refer to Appendix C, "[Contact Information](#)" on page 161 for details.

2. Hardware Orientation

In This Chapter

This chapter provides detailed diagrams of the system's front and rear panels. The following topics are discussed:

- [LED-PRO Front Panel](#)
- [LED-PRO Rear Panel](#)

2. Hardware Orientation

LED-PRO Front Panel

LED-PRO Front Panel

The figure below illustrates the LED-PRO front panel:

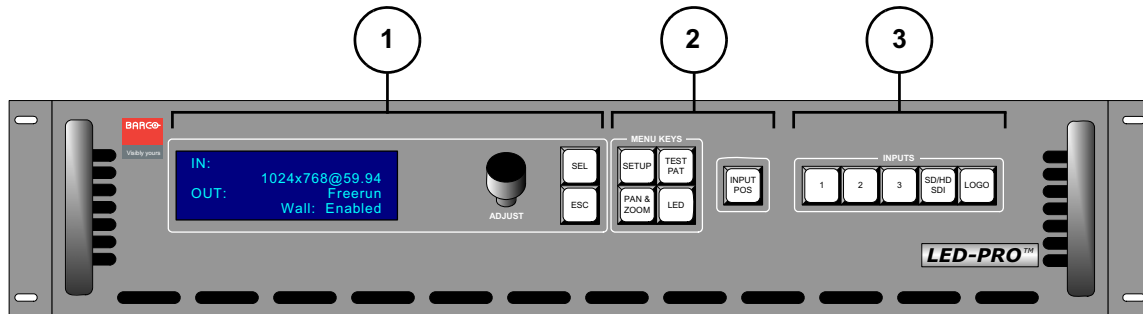

Figure 2-1. LED-PRO Front Panel

1) Display Section	3) Inputs Section
2) Menu Keys Section	

Following are descriptions of each front panel section:

1) Display Section

The **Display Section** includes the display, the **ADJUST** knob and two “menu navigation” buttons. Refer to the “[Display Section](#)” heading on page 11 for complete details.

2) Menu Keys Section

The **Menu Keys Section** includes five buttons that take you directly to the top level of various system menus. Refer to the “[Menu Keys Section](#)” heading on page 12 for details.

3) Inputs Section

The **Inputs Section** includes four buttons for selecting various system inputs, plus the **LOGO** button that enables you to access a stored image. Refer to the “[Inputs Section](#)” heading on page 13 for details.

Display Section

The figure below illustrates the **Display Section**:

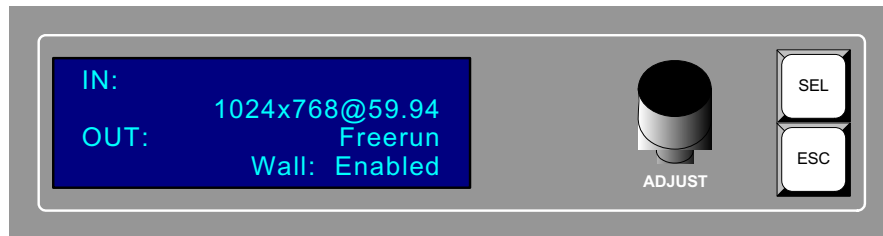

Figure 2-2. Display Section

Descriptions of each button and control are provided below:

- The **Menu Display** is a 4 line x 20 character Vacuum Fluorescent Display (VFD) that shows all LED-PRO menus and sub-menus. Brightness is adjustable.

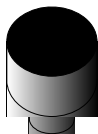

Figure 2-3. Sample Menu Display (Setup Menu)

Please note:

- ~ The top line names the current menu, in all capital letters.
- ~ The navigation cursor (>) in the left-hand column indicates the current line on which action can be taken.
- ~ The double arrow (>>) indicates that a sub-menu is available.

In Chapter 4, refer to the "[Menu Tree](#)" section on page 30 for complete menu structure details.



- **ADJUST** — use the **Adjust Knob** to scroll through all system menus.
 - ~ Turn the knob counter-clockwise (**CCW**) to scroll down.
 - ~ Turn the knob clockwise (**CW**) to scroll up.
- **SEL** — press to enter a sub-menu, to change a parameter, to accept a parameter, or to answer "**Yes**" to certain menu queries.
- **ESC** — press to exit a menu without making changes, to cancel an operation, or to answer "**No**" to certain menu queries. Each press takes you back up the menu tree by one level.

2. Hardware Orientation

LED-PRO Front Panel

Menu Keys Section

The figure below illustrates the **Menu Keys Section**:

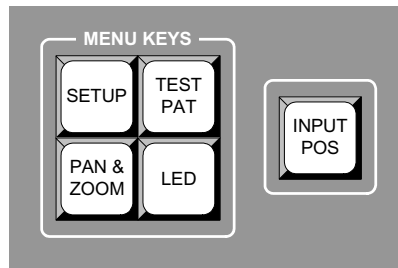

Figure 2-4. Menu Keys Section

Descriptions of each button and control are provided below:



- **SETUP** — press to access the top level of the **Setup Menu**, which enables you to perform complete system setup procedures. The button lights to indicated that the menu is active. Toggle the button off to access the **Status Menu**. In Chapter 4, refer to the [“Using the Setup Menu”](#) section on page 39 for menu details.



- **TEST PAT** — press to access the top level of the **Test Pattern Menu**, which enables you to select system test patterns and the raster box. The button lights to indicated that the menu is active, or that a test pattern is enabled. Toggle the button off to access the **Status Menu**. In Chapter 4, refer to the [“Using the Test Pattern Menu”](#) section on page 93 for menu details.



- **PAN & ZOOM** — press to access the top level of the **Pan & Zoom Menu**, which enables you to pan and zoom the selected source. The button lights to indicated that the menu is active. Toggle the button off to access the **Status Menu**. In Chapter 4, refer to the [“Using the Pan & Zoom Menu”](#) section on page 95 for menu details.



- **LED** — press to access the top level of the **LED Menu**, which enables you to perform various LED-specific functions. The button lights to indicated that the menu is active. Toggle the button off to access the **Status Menu**. In Chapter 4, refer to the [“Using the LED Menu”](#) section on page 98 for menu details.



- **INPUT POS** — press to access the top level of the **Input Position Menu**, which enables you to perform “simple” input setup functions within the LED wall window, such as H and V size and position. (For more comprehensive input setups, use the **Setup Menu**.) The button lights to indicated that the menu is active. Toggle the button off to access the **Status Menu**. In Chapter 4, refer to the [“Using the Input Position Menu”](#) section on page 105 for menu details.

Please note:

- If you are within a particular menu, but you have not made any changes, pressing one of the five buttons in the **Menu Keys Section** takes you directly to the selected menu.
- If you have made a change within a particular menu and you press one of the five buttons in the **Menu Keys Section**, you will be prompted to save your changes.

Inputs Section

The figure below illustrates the **Inputs Section**:

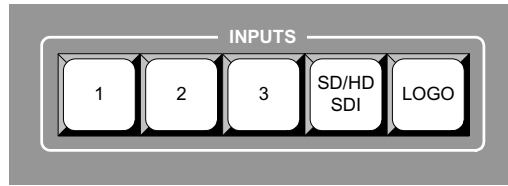

Figure 2-5. Inputs Section

Descriptions of each button and control are provided below:



- **1** — selects universal input 1 (the rear panel **DVI** connector) as the LED wall's source. When pressed, the input is routed to the output using the transition type specified in the **Effects Menu**.



- **2** — selects universal input 2 (the rear panel **HD-15** connector) as the LED wall's source. When pressed, the input is routed to the output using the transition type specified in the **Effects Menu**.



- **3** — selects universal input 3 (the rear panel **BNC** connectors) as the LED wall's source. When pressed, the input is routed to the output using the transition type specified in the **Effects Menu**.



- **SD/HD SDI** — selects the SD/HD input (the rear panel **SDI Input BNC** connector) as the LED wall's source. When pressed, the input is routed to the output using the transition type specified in the **Effects Menu**.



- **LOGO** — selects the LOGO (as stored in flash memory) as the LED wall's source. When pressed, the LOGO is routed to the output using the transition type specified in the **Effects Menu**. Refer to the "[About the LOGO](#)" section on page 14 for additional details.

2. Hardware Orientation

LED-PRO Front Panel

About the LOGO



The **LOGO** button can be thought of as an additional input video source which can be selected and transitioned in the normal manner. The button allows you to capture a still frame from any input (**1**, **2**, **3** or **SD/HD**), and store that image in flash memory. When selected, the **LOGO** button lights and the output displays either a stored image (typically a company logo) or black.

■ To capture a LOGO (control panel method):

1. Press and hold the desired input button
2. Press **LOGO**.

The system temporarily freezes the output, captures a frame from the selected input, and stores the frame in non-volatile memory. A "progress bar" and related messages will be shown on the display during the capture process.

■ To capture a LOGO (menu method):

1. Manually freeze the desired image (**SETUP > Expert Mode > Freeze > On**).
2. Manually capture the logo (**SETUP > Expert Mode > Logo > Capture Logo**).

Please note the following important points regarding the LOGO:

- The LOGO can be de-selected by pressing one of the other four input sources.
- When LOGO is selected, the **PAN & ZOOM** button is not operational.
- When no logo is stored internally, the output displays black, and the **Status Menu** indicates "**Internal Black**" as the format.
- When the LOGO is selected and there is a logo stored, the **Status Menu** indicates "**LOGO**" as the input format.
- If a LOGO is stored in flash memory, the image remains through a power cycle.
- The LOGO can be overwritten by capturing a new image.
- If you perform a factory reset, the LOGO is cleared from flash memory.
- You can delete the LOGO manually from flash memory using the **Logo Menu**. In Chapter 4, refer to the "[Logo](#)" section on page 86 for menu details.

LED-PRO Rear Panel

The figure below illustrates the LED-PRO rear panel:

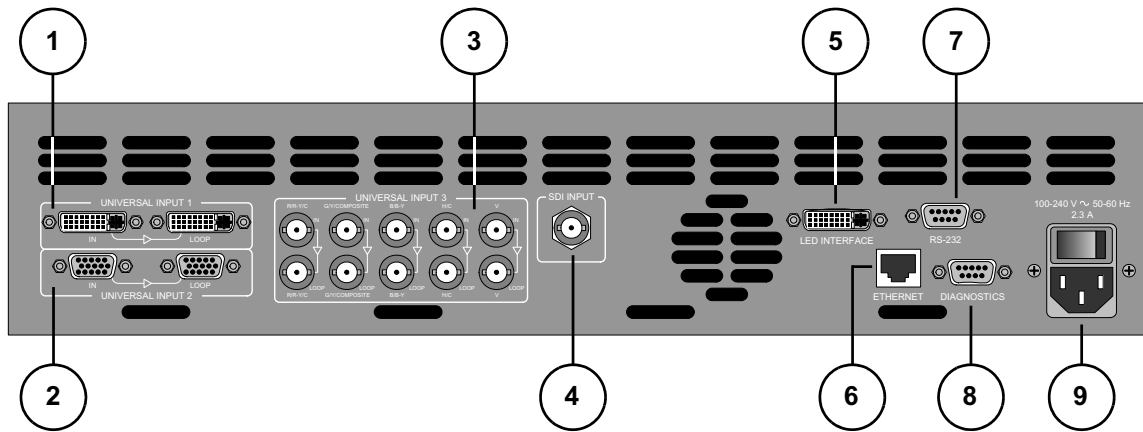

Figure 2-1. LED-PRO Rear Panel

1) Universal Input 1	6) Ethernet Port
2) Universal Input 2	7) RS-232 Port
3) Universal Input 3	8) Diagnostics Port
4) SDI Input	9) AC Connector
5) LED Interface	

Following are descriptions of each rear panel connector:

1) Universal Input 1

Two DVI-I connectors are provided for **Universal Input 1** — one for the input and the other for a buffered loop-through. The input corresponds to **Button 1** in the front panel's **Inputs Section**.

This input accepts DVI signals, and via a DVI-I to HD-15 adaptor, also accepts RGB, YUV, S-Video (Y/C), or composite (NTSC, PAL or SECAM) signals.

- ~ In Appendix A, refer to the "[Input Specifications](#)" section on page 118 for input video details.
- ~ In Appendix A, refer to the "[DVI-I Connector Pinouts](#)" section on page 122 for pinout specifications.

2) Universal Input 2

Two HD-15 connectors are provided for **Universal Input 2** — one for the input and the other for a buffered loop-through. The input corresponds to **Button 2** in the front panel's **Inputs Section**.

This input accepts RGB, YUV, S-Video (Y/C), or composite (NTSC, PAL or SECAM) signals.

- ~ In Appendix A, refer to the "[Input Specifications](#)" section on page 118 for input video details.
- ~ In Appendix A, refer to the "[Analog 15-pin D Connector](#)" section on page 121 for pinout specifications.

2. Hardware Orientation

LED-PRO Rear Panel

3) Universal Input 3

Five BNC connectors are provided for **Universal Input 3** — each with a buffered loop-through. The input corresponds to **Button 3** in the **Inputs Section**, and accepts RGB, YUV, S-Video (Y/C), or composite (NTSC, PAL or SECAM) signals.

~ In Appendix A, refer to the “[Input Specifications](#)” section on page 118 for input video details.

4) SDI Input

One BNC connector is provided for the **SDI Input**. The input corresponds to the **SD/HD SDI** button in the **Inputs Section**, and accepts SD-SDI or HD-SDI signals.

~ In Appendix A, refer to the “[Input Specifications](#)” section on page 118 for input video details.

5) LED Interface

One DVI-I connector is provided for the system's output to an LED wall. The output is digital only.

~ In Appendix A, refer to the “[Output Specifications](#)” section on page 119 for output video details.

~ In Appendix A, refer to the “[DVI-I Connector Pinouts](#)” section on page 122 for pinout specifications.

6) Ethernet Port

One RJ-45 connector is provided for 10/100BaseT **Ethernet** communications with LED-PRO.

~ The port is typically used for diagnostics, or command-line operations via Telnet.

~ Telnet is via port 10001.

▲ telnet 192.168.1.100 10001

In Appendix A, refer to the “[Ethernet Connector](#)” section on page 123 for pinouts.

7) RS-232 Port

One 9-pin D connector is provided for RS-232 serial communications with LED-PRO. The port is typically used for communications with Barco's **Director Toolset** Graphical User Interface (GUI).

In Appendix A, refer to the “[Serial and Diagnostic Connector](#)” section on page 124 for pinouts.

8) Diagnostics Port

One 9-pin D connector is provided for RS-232 serial communications with LED-PRO. Similar to the Ethernet port, this port is typically used for diagnostics, uploading code or command-line operations via **HyperTerminal** or the **Flash Loader**.

In Chapter 4, refer to the “[Diagnostic RS232](#)” section on page 88 for port setup operations. In Appendix A, refer to the “[Serial and Diagnostic Connector](#)” section on page 124 for pinouts.

9) AC Connector

One **AC Connector** is provided for connecting LED-PRO to your facility's AC power source. The integral switch turns the chassis on and off.

3. Installation

In This Chapter

This chapter provides detailed instructions for installing the LED-PRO hardware. The following topics are discussed:

- [Safety Precautions](#)
- [Unpacking and Inspection](#)
- [Site Preparation](#)
- [Cable and Adapter Information](#)
- [Rack-Mount Installation](#)
- [Power Installation](#)
- [Signal Installation](#)
- [Format Connection Table](#)

3. Installation

Safety Precautions

Safety Precautions

For all LED-PRO installation procedures, observe the following important safety and handling rules to avoid damage to yourself and the equipment:

- To protect users from electric shock, ensure that the power supplies for each unit connect to earth via the ground wire provided in the AC power Cord.
 - The AC Socket-outlet should be installed near the equipment and be easily accessible.
-

Unpacking and Inspection

Before opening the LED-PRO box, inspect it for damage. If you find any damage, notify the shipping carrier immediately for all claims adjustments. As you open the box, compare its contents against the packing slip. If you find any shortages, contact your Barco sales representative.

Once you have removed all the components from their packaging and checked that all the listed components are present, visually inspect each unit to ensure there was no damage during shipping. If there is damage, notify the shipping carrier immediately for all claims adjustments.

Site Preparation

The environment in which you install your LED-PRO(s) should be clean, properly lit, free from static, and have adequate power, ventilation, and space for all components.

Cable and Adapter Information

The table below provides information regarding supplied cables and adapters:

Table 3-1. LED-PRO System Cables and Adapters

Cable / Adapter	Description	Quantity
VGA to DVI Adapter	DVI to HD-15 adapter for analog inputs	1
RS-232 Cable	15 meter, connects customer supplied laptop to LED-PRO	1
DVI to DVI Cable	5 meter, connects LED-PRO output to LED wall (DVI input)	1
DVI to MDR26 Cable	5 meter, standard, connects LED-PRO output to LED wall (MDR input)	1
DVI to MDR26 Cable	5 meter, waterproof, connects LED-PRO output to LED wall (MDR input)	1
AC Power Cord	7 foot, 10A	1

Rack-Mount Installation

LED-PRO units are designed to be rack mounted and are supplied with front rack-mount hardware. Please note the following important points:

- Rear rack-mount brackets are available as a kit, and are recommended for use when units are mounted in transit cases.
- When rack mounting the unit, remember that the maximum ambient operating temperature for the unit is 40 degrees C.
- Leave sufficient front and rear space to make sure that the airflow through the fan and vent holes is not restricted.
- When installing equipment into a rack, distribute the units evenly to prevent hazardous conditions that may be created by uneven weight distribution.
- Connect the unit only to a properly rated supply circuit.
- Reliable grounding (earthing) of rack-mounted equipment should be maintained.
- Rack mount the unit from the front rack ears using four rack screws (not supplied). Rack threads may be metric or otherwise — depending upon the rack type.
- Install the *lower* of the two mounting holes first.

Power Installation

- Use the following steps to install power to the LED-PRO:
 1. Connect an AC power cord to the AC Power Connector on the rear of the LED-PRO, and then to an AC outlet.
 2. Connect AC Power cords (or AC adapters) to all peripheral equipment, such as video sources and PCs. Please note:
 - ~ Connect each unit only to a properly rated supply circuit.
 - ~ Reliable grounding of rack-mounted equipment should be maintained.
 3. Ensure that your LED wall is properly assembled, and that all power cords are distributed and connected to all tiles — in the proper sequence. Refer to your specific LED tile's "**User's Guide**" for details.

3. Installation

Power Installation

Power Cord/Line Voltage Selection

LED-PRO is rated to operate with the following supplies:

- Input Power: 100-240 VAC, 47-63 Hz
- Power Consumption: 150 watts maximum

LED-PRO performs line voltage selection automatically, and no user controls are required. The AC power cords must be accessible so that they can be removed during field servicing.



Warning

When the LED-PRO is used in the 230-volt mode, a UL listed line cord rated for 250 volts at 15 amps must be used and must conform to IEC-227 and IEC-245 standards. This cord will be fitted with a tandem prong-type plug.

The rear panel ON/OFF switch does not disconnect the unit from input AC power. To facilitate disconnection of AC power, the power cord must be connected to an accessible outlet near the unit.

Building Branch Circuit Protection: For 115 V use 20 A, for 230 V use 8 A.



Figure 3-1. Tandem Prong-type Plug

Avertissement

La choix de la ligne de voltage se réalise automatiquement par le LED-PRO Transformateur Graphique. On n'a pas besoin du controller usager pour la choix de la ligne de voltage.

Warnung

Das LED-PRO gerät mu beim Anschlu an 240V ~ mit einer vom VDE auf 250V/10A geprüften Netzleitung mit einem Schukostecker ausgestattet sein.

Signal Installation

The figure below illustrates a sample LED-PRO system diagram. Use this figure for reference during the signal installation process.

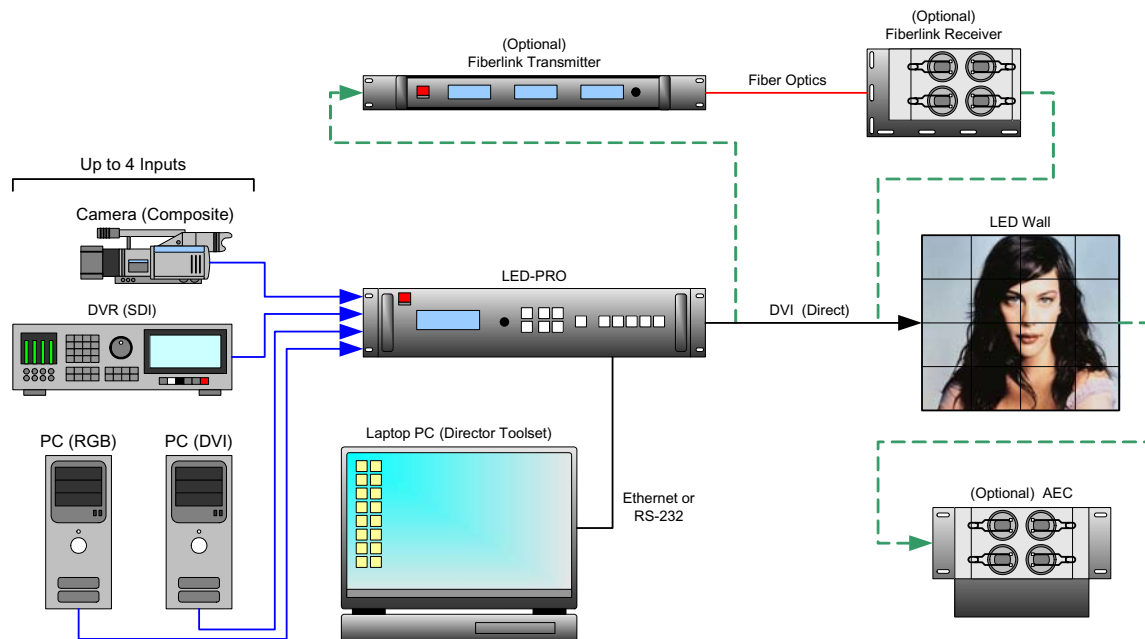

Figure 3-2. LED-PRO System Diagram (sample)

■ Use the following steps to install signals to/from the LED-PRO:

1. Connect outputs from your selected source devices to LED-PRO's inputs. A maximum of four devices can be connected.
 - ~ In Chapter 2, refer to the "[LED-PRO Rear Panel](#)" section on page 15 for details on all rear panel universal input connectors.
 - ~ Refer to the "[Format Connection Table](#)" section on page 23 for connection details using a customer supplied breakout cable.

Note

All inputs except the **SDI Input** can be looped.

2. Connect a laptop PC to LED-PRO via either RS-232 or Ethernet.
 - ~ Ensure that the Director Toolset is properly installed on the laptop PC.
 - ~ Director Toolset is required for LED wall calibration, but it is not required for initial setup. LED-PRO's "Setup Wizard" is used for this purpose.

3. Installation

Signal Installation

- ~ If you are using RS-232 communications, connect the laptop to LED-PRO's **RS-232 Port**.

Note

A 15 meter RS-232 cable is provided, which will assist you in viewing the LED wall while simultaneously using your laptop for calibration purposes.

- ~ If you are using Ethernet communications, a totally "local" network is recommended, without IP connections to the outside world:
 - Use a crossover Ethernet cable for a direct connection, or
 - Use a standard Ethernet cables in conjunction with an Ethernet hub or switch.
- 3. Ensure that your LED wall is properly assembled, and that all data cables are connected to all tiles — in the proper sequence. Refer to your specific LED tile's "**User's Guide**" for details.
- 4. Connect LED-PRO's **LED Interface** output to the data input of your LED wall. Please note:
 - ~ Use the proper cable, depending upon your LED wall's input connector (e.g., DVI or MDR). Refer to the "[Cable and Adapter Information](#)" on page 18 for details on all connection cables.
 - ~ **(Option)** If you are using a fiber optic link:
 - Ensure that power is properly connected to all Fiberlink units.
 - Connect LED-PRO's **LED Interface** output to the input of the Fiberlink Transmitter.
 - Connect a fiber optic cable from the output of the Fiberlink Transmitter to the input of the Fiberlink Receiver.
 - Connect the output of the Fiberlink Receiver to the data input of your LED wall.
- 5. **(Option)** If you are using the Barco AEC:
 - ~ Ensure that power is properly connected to the AEC.
 - ~ Connect the data output of your LED wall to the input of the AEC.

Please continue with system setup, menu orientation and operations, as outlined in Chapter 4, "[Operation](#)" on page 25.

Format Connection Table

Use the following table to connect various source formats to LED-PRO, using the system's universal input connectors in conjunction with a customer supplied VGA to 5 x BNC breakout cable. Please note:

- **RGB format** — typical devices: Computers
- **S-Video (Y/C) format** — typical devices: S-Video DVD or VCR
- **YUV or YP_bP_r (Betacam) format** — typical devices: DVD player, Betacam deck
- **Composite format** — typical devices: NTSC/PAL DVD or VCR

Using a customer supplied VGA to 5 x BNC breakout cable, multiple input combinations are possible. Cells with checks denote the connections required for the indicated format.

Note

For RGB with H and V sync, use the VGA connector directly.

Table 3-2. Analog Input Combinations using Breakout Cable

Breakout Cable Wire Color	Composite Video	S-Video (Y/C)	YUV (YP _b P _r)	RGB Sync on Green	RGB Comp Sync	RGB Separate H V
R		✓ (Chrom)	✓ (P _r)	✓	✓	✓
G	✓	✓ (Lum)	✓ (Lum)	✓	✓	✓
B			✓ (P _b)	✓	✓	✓
H Sync					✓	✓
V Sync						✓

Please contact **Barco Technical Support** for information on obtaining breakout cables. In Appendix C, refer to the "[Contact Information](#)" section on page 162 for details.

3. Installation

Format Connection Table

4. Operation

In This Chapter

This chapter provides comprehensive menu descriptions and detailed operating instructions for the LED-PRO. The following topics are discussed:

- [Control Overview](#)
- [Power-Up Initialization](#)
- [Quick Setup and Operations](#)
- [Menu Tree](#)
- [Using the Menu System](#)
- [Quick Function Reference](#)
- [Using the Status Menu](#)
- [Using the Setup Menu](#)
- [Using the Setup Wizard](#)
- [Using the Input Wizard](#)
- [Using the Expert Mode Menu](#)
- [Using the Test Pattern Menu](#)
- [Using the Pan & Zoom Menu](#)
- [Using the LED Menu](#)
- [Using the Input Position Menu](#)

4. Operation

Control Overview

Control Overview

There are several ways to control the LED-PRO:

- The front panel is available for status and control using the display, the **ADJUST** knob and the two menu “navigation” buttons (**SEL** and **ESC**). In conjunction with other dedicated buttons, these controls enable you to configure the system, to adjust all system parameters, and to utilize the “wizards.”
- The unit can be controlled remotely via RS-232 or Ethernet interface. In Appendix B, refer to the “[LED-PRO Remote Commands](#)” section on page 128 for remote control command details.
- The **Director Toolset** is a software application that is used to detect the LED-PRO and provide it with information concerning the LED tiles. Operations of the Director Toolset are not covered in this guide. Please refer to the “**Director Toolset User’s Guide**” for more information.

Power-Up Initialization

After connecting power to the LED-PRO, locate the power switch on the back of the chassis, and turn the power ON. The **LED** button lights, and the display shows a series of initialization screens. The screens vary depending upon the last state of the system:

- [Standard Bootup](#)
- [Bootup in Ethernet Mode](#)
- [Bootup with a Stored LOGO](#)

Standard Bootup

While the main board is initializing, the following screens are shown on the display

- **Initialization Screen 1** displays the “Program Loading” message.

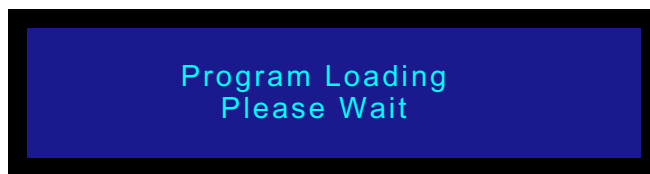

Figure 4-1. Initialization Screen 1

- **Initialization Screen 2** displays the “Transferring” message.

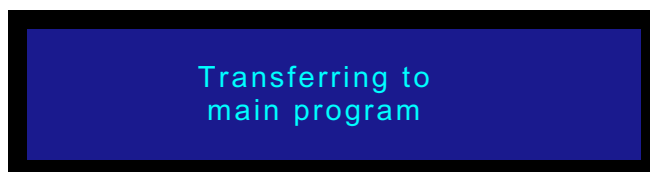

Figure 4-2. Initialization Screen 2

- **Initialization Screen 3** displays the software version that is currently being loaded. Note that the software version changes as upgrades are released.



Figure 4-3. Initialization Screen 3

At the conclusion of the boot-up procedure, the **Input 1** button will light and the **Status Menu** is shown:



Figure 4-4. Status Menu (sample)

Note

By default, LED-PRO boots up with **Input 1** selected from a “factory reset” operation. However, if you perform the “**Save System State**” procedure with a different input selected, the system will acquire and select that input.

Refer to the “[Using the Status Menu](#)” section on page 36 for complete details.

Bootup in Ethernet Mode

If Ethernet mode was enabled (on the **Ethernet Menu**) and saved during your last session, it will be restored during initialization.

- If DHCP was enabled, LED-PRO will attempt to contact the DHCP server for an IP address. During this process, the following message is shown:

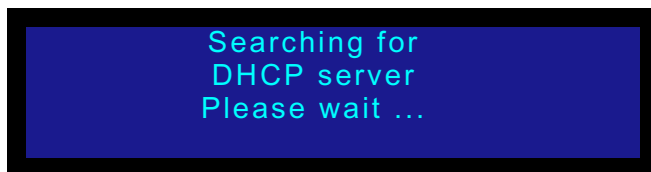

Figure 4-5. Initialization Screen — Connect to DHCP Server

Note

It takes approximately 40 seconds for the system to connect to the DHCP server.

- If DHCP is off and a static IP address was saved (e.g., any address other than **000.000.000.000**), LED-PRO sets the Ethernet port with the selected address.

4. Operation

Power-Up Initialization

During this process, the following message is shown:

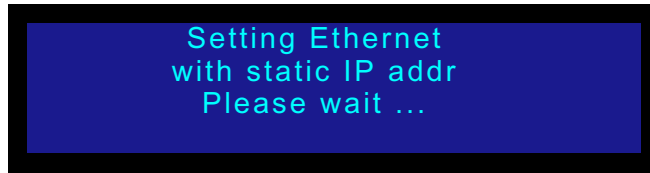

Figure 4-6. Initialization Screen — Set IP Address

Note

It takes approximately 40 seconds for the system to set the IP address.

At the conclusion of the boot-up procedure, the **Input 1** button will light and the **Status Menu** is shown.

Note

By default, LED-PRO boots up with **Input 1** selected from a “factory reset” operation. However, if you perform the “**Save System State**” procedure with a different input selected, the system will acquire and select that input.

Bootup with a Stored LOGO

During your last session, if a LOGO was stored in non-volatile memory, it will be loaded into memory during initialization. During the loading process, the following message is shown along with a progress bar (on the third line):

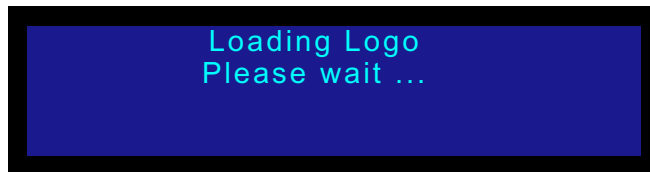

Figure 4-7. Initialization Screen — Load Logo

At the conclusion of the procedure, the **Input 1** button light and the **Status Menu** is shown.

Note

By default, LED-PRO boots up with **Input 1** selected from a “factory reset” operation. However, if you perform the “**Save System State**” procedure with a different input selected, the system will acquire and select that input.

Quick Setup and Operations

For the optimum speed in system setup and operations, use the following steps.

1. Run the **Setup Wizard**. Refer to the "[Using the Setup Wizard](#)" section on page 56 for instructions.
2. Run the **Input Wizard**. Refer to the "[Using the Input Wizard](#)" section on page 62 for instructions.
3. Select your inputs and roll your video.

Please note:

- For advanced system operations and specific "tweaks," start with the "[Quick Function Reference](#)" section on page 33, and select the function that you wish to perform.
- For a complete overview of all system operating procedures, start with the "[Menu Tree](#)" section on page 30 and review the entire chapter.

4. Operation

Menu Tree

Menu Tree

The figure below illustrates a simplified view of the LED-PRO **Menu Tree**. Use this diagram for reference throughout this chapter. Please note:

- In the diagram, only “top level” menus are shown.
- The symbol >> denotes additional sub-menus.
- In the sections describing each individual tree, expanded menus are provided.

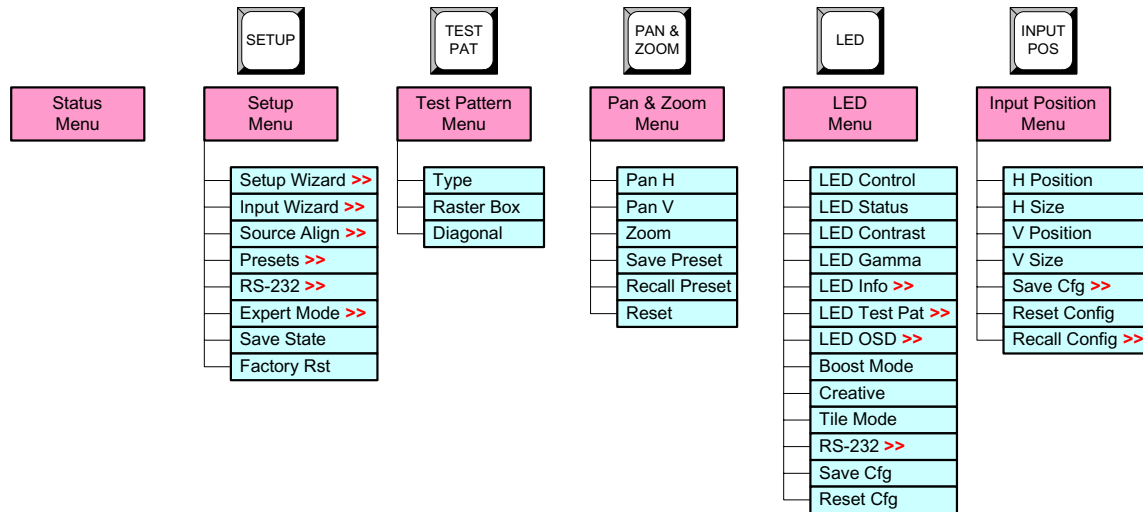

Figure 4-8. LED-PRO Menu Tree

Each menu is explained in the following sections:

- [Using the Menu System](#)
- [Using the Status Menu](#)
- [Using the Setup Menu](#)
- [Using the Test Pattern Menu](#)
- [Using the Pan & Zoom Menu](#)
- [Using the LED Menu](#)
- [Using the Input Position Menu](#)

Using the Menu System

This section lists the rules and conventions for using LED-PRO's menu system. The figure below illustrates a sample menu:



Figure 4-9. Test Pattern Menu (sample)

Please note the following important rules and conventions:

- Pressing any of the buttons in the **Menu Keys Section** takes you directly to the top level of the selected menu.
- The top line names the current menu, in all capital letters.
- Subsequent lines typically display two fields:
 - ~ For a listed **function**, the left-hand field names the function and the right-hand field is the function's current parameter or value.
 - ~ For a listed **sub-menu**, the left-hand field names the sub-menu that you can access, and the right-hand field displays the double arrow (>>), indicating that a sub-menu is available.
- The "navigation" **cursor (>)** in the left-hand column indicates the current line on which action can be taken. This arrow "scrolls" as you rotate the knob.
- Scrolling:
 - ~ Turn the **ADJUST** knob counter-clockwise (**CCW**) to scroll down.
 - ~ Turn the **ADJUST** knob clockwise (**CW**) to scroll up.
- To enter a sub-menu, scroll to the desired line and press **SEL**.

Note

Throughout this chapter, the term "**select**" is used as an abbreviation for "scroll to a selected menu line and press the **SEL** button."

▲ Select the **Raster Box** field to ...

- To change a parameter, scroll to the desired line and press **SEL**. The cursor changes to the "edit" cursor (#). Use the **ADJUST** knob to modify the parameter.
- To accept a parameter or value, press **SEL**. The edit cursor changes back to the navigation cursor.

Note

You must press **SEL** to activate an LED wall function. Processor functions *generally* update as you adjust them.

- In the "edit" mode, to exit (or cancel) without changing the original parameter, press **ESC**.

4. Operation

Using the Menu System

- To navigate back up the menu structure, press **ESC**. Each press takes you back up the menu tree by one level.
- The **SEL** button is also used to answer “**Yes**” to certain menu queries. The **ESC** button is also used to answer “**No**” to certain menu queries.

Note

The display itself is four lines high, and the **ADJUST** knob is used to scroll through the various menu lines. Throughout this chapter, *entire* menus will be shown for clarity — rather than a series of four-line sections.

Quick Function Reference

Use the following table to quickly access the proper menu for a specific function. Both hyperlinks and page numbers are provided.

Table 4-1. LED-PRO Quick Function Reference Table

How to:	Use the Following:	Page
Adjust 1:1 timing	1:1 Timing Adjust Menu	70
Adjust diagonal motion	Diagonal Motion	94
Adjust display brightness	VFD Brightness	88
Adjust input position (abbreviated procedure)	Using the Input Position Menu	105
Adjust LED wall contrast	LED Contrast	82
Adjust LED wall gamma curve	LED Gamma	82
Adjust output refresh rate	Refresh Rate	81
Adjust output timing parameters	Timing Adjust	81
Adjust oversample timing	OverSample Timing Adjust Menu	71
Align or adjust a DVI source	Source Alignment — DVI	48
Align or adjust an analog source	Source Alignment — Analog	43
Align or adjust an SDI source	Source Alignment — SDI	46
Capture a LOGO	Capture Logo	86
Change LED wall status from Standby to Enabled	LED Status	82
Change the input format	Input Format	69
Change the sampling mode	Sampling	69
Change the transition time (rate)	Trans Time	85
Change the transition type	Trans With	85
Delete a “global” preset (or “View”)	Delete	50
Delete a custom input format	Custom In Format	72
Delete a LOGO	Delete Logo	86
Delete an input configuration	Delete Config	79
Display software version	Software Version	92
Enable or disable a test pattern	Type	94
Enable or disable an LED test pattern	LED Test Pattern	102
Enable or disable auto-acquire	In Auto Acquire	87
Enable or disable freeze mode	Freeze	87
Enable or disable letterbox	Letterbox	76

4. Operation

Quick Function Reference

Table 4-1. LED-PRO Quick Function Reference Table (Continued)

How to:	Use the Following:	Page
Enable or disable the LED boost mode	Boost Mode	103
Enable or disable the LED creative mode	Creative Mode	103
Enable or disable the LED OSD (on screen display)	LED OSD	102
Enable or disable the LED tile mode	Tile Mode	103
Enable or disable the raster box	Raster Box	94
Get information (status) about the current input and output	Using the Status Menu	36
Get information on LED wall and fiber communications	LED Information	82
Lock or unlock the front panel	Lock Front Panel	91
Pan (tilt) image vertically	Pan V	96
Pan image horizontally	Pan H	96
Program EDID	Programming EDID	53
Recall a "global" preset (or "View")	Recall	49
Recall a "local" preset from memory	Recall Preset	97
Recall an input configuration	Recall Config	78
Reset "local" preset settings to default values	Reset	97
Reset an input configuration	Reset Config	78
Reset output configuration	Reset Config	84
Reset to factory default	Factory Reset	51
Run the Input Wizard	Using the Input Wizard	62
Run the Setup Wizard	Using the Setup Wizard	56
Save "local" preset	Save Preset	97
Save a "global" preset (or "View")	Save	50
Save a custom input format	Custom In Format	72
Save all system, input and output settings	Save System State	51
Save an input configuration	Save Config	107
Save output configuration	Save Config	84
Select (configure) a custom input format	Custom In Format	72
Select an input signal type	Type	72
Select colorspace	Colorspace	72
Select sync, de-interlace, pulldown comp and sync slice	Processing	77
Set "lock to source" parameters	Lock to Source	83
Set Diagnostic Port RS-232 parameters	Diagnostic RS232	88
Set Ethernet parameters (mode, DHCP, IP address)	Ethernet	89

4. Operation

Quick Function Reference

Table 4-1. LED-PRO Quick Function Reference Table (Continued)

How to:	Use the Following:	Page
Set LED wall control to local or remote	LED Control	82
Set minimum delay	Minimum Delay	83
Set the display mode to crop or scale	Display Mode	76
Set the input's aspect ratio	Aspect Ratio	76
Set the RS-232 baud rate	RS232	51
Verify if LOGO is present in memory	Logo Present	86
Zoom the image in and out	Zoom	97

4. Operation

Using the Status Menu

Using the Status Menu

The figure below illustrates a sample **Status Menu**:



Figure 4-10. Status Menu (sample)

The **Status Menu** is a “standalone” menu without any sub-menus. In addition, the “cursor” does not appear.

- [Status Menu Access](#)
- [Status Menu Description](#)

Status Menu Access

To access the **Status Menu**:

- Automatic access after system boot-up.
- Press **ESC** once for each level that you are down within a menu tree.
 - ▲ On the **LED Menu**, the cursor is on **LED Information**. Press **ESC** once to access the **Status Menu**. From within the **LED Information Menu**, press **ESC** twice to access the **Status Menu**.
- Toggle a selected menu button off — from *any level* down the menu tree.
 - ▲ You are several levels down the **Setup Menu**. Press **SETUP** to access the **Status Menu** directly.

Status Menu Description

The **Status Menu** provides information about the currently selected system input (as determined by the input buttons) and the selected output. If the input is changed, the fields change accordingly. Other pertinent changes that you make within the menu system are shown, once you return to the **Status Menu**.

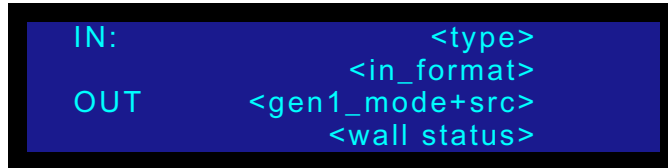

Figure 4-11. Status Menu Fields

Following are descriptions of each variable field:

- **<type>**

Specifies the type of input signal being processed. Choices include NTSC/PAL/SECAM, SDI, HD-SDI, RGB, YPbPr, or DVI.

- **<in_format>**

Indicates the current input video format in the following form:

Hact x Vact @ Vr Hz

▲ 1280x1024@60

Please note:

- ~ If a “saved” user input configuration is used for the current input (as saved with the **Save Config** or **Save System State** functions), the field shows the name of the user input configuration — *instead of the format*. In this case, to view the format’s parameters, use the **Input Menu (SETUP > Expert Mode > Input)**.
- ~ If the format itself is displayed, the input has not been saved.
- ~ If the currently selected input does not have a valid input signal, the message “**Invalid Signal**” is shown.

- **<gen1_mode+src>**

Indicates the current “Lock to Source” mode and type (if locked), as set on the **Lock to Source Menu (SETUP > Expert Mode > Output > Lock to Source)**. Refer to the “[Lock to Source](#)” section on page 83 for details.

Choices include:

- ~ **Freerun** — Not locked, freerun timing
- ~ **HV Lock, Input** — horizontal and vertical lock to input video
- ~ **V Lock, Input** — vertical lock to input video

If the unit is set for a particular “Lock to Source” mode and type, but that source is missing (or lock can not be achieved), the unit periodically attempts to lock. While

4. Operation

Using the Status Menu

lock has not been reestablished, the display changes to "**Lost Input**," and the source field remains unchanged.

Important

When **Lock to Source** is enabled, LED-PRO does not allow you to switch input channels. You can only switch to/from the current input and the Black/Logo channel.

- **<wall status>**

Indicates the status of the Barco LED wall that is currently connected to LED-PRO. Choices include:

- ~ **No Wall detected**— no Barco LED wall is connected to LED-PRO
- ~ **Wall: Enabled** — Barco LED wall detected and enabled
- ~ **Wall: Standby** — Barco LED wall detected and in standby mode

If no wall is detected, ensure that the Barco LED Wall is properly connected to the LED-PRO connector labeled "**LED Interface**."

Using the Setup Menu

The following topics are discussed in this section:

- [Setup Menu Tree](#)
- [Setup Menu Description](#)
- [Programming EDID](#)
- [Using the Setup Wizard](#)
- [Using the Input Wizard](#)
- [Using the Expert Mode Menu](#)

4. Operation

Using the Setup Menu

Setup Menu Tree

Press **SET UP** to access the **Setup Menu**. The figure below illustrates a simplified menu tree. The symbol **>>** denotes additional sub-menus. The menu trees for the **Setup Wizard**, **Input Wizard** and **Expert Mode** are provided in their respective sections.

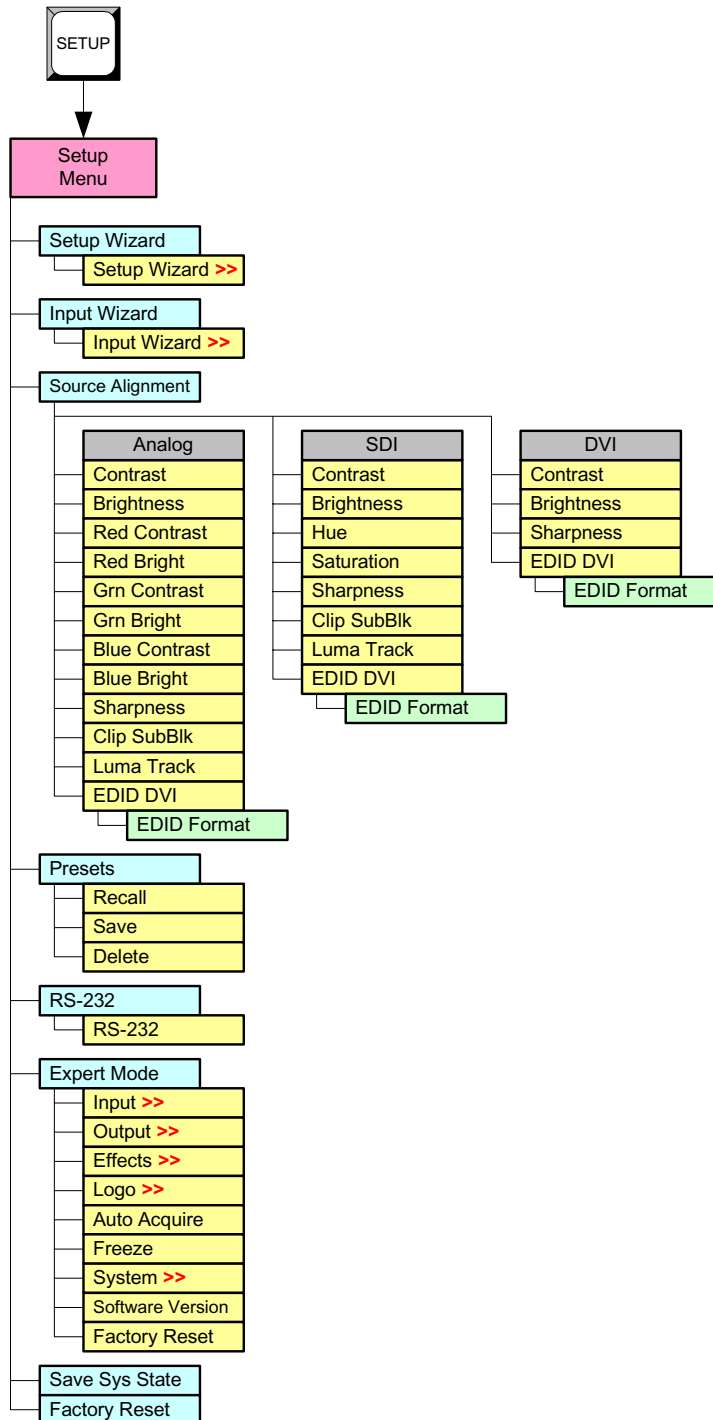

Figure 4-12. Setup Menu Tree

Setup Menu Description

The **Setup Menu** enables you to set up all LED-PRO input, output and system parameters. If desired, all setup information can be stored in non-volatile memory (using the “**Save System State**” function). Once saved, all settings will be automatically recalled each time the unit is turned on.

The figure below illustrates the **Setup Menu**:



Figure 4-13. Setup Menu

Following are descriptions of each menu function:

- [Setup Wizard](#)
- [Input Wizard](#)
- [Source Alignment — Analog](#)
- [Source Alignment — SDI](#)
- [Source Alignment — DVI](#)
- [Presets](#)
- [RS232](#)
- [Expert Mode](#)
- [Save System State](#)
- [Factory Reset](#)

Note

The **Source Alignment Menu** *changes* depending upon the format of the selected source — analog, SDI or DVI.

4. Operation

Using the Setup Menu

Setup Wizard

From the **Setup Menu**, select **Setup Wizard** to display the **Setup Wizard Start Menu** which enables you to quickly and conveniently configure an LED wall along with the system's output.

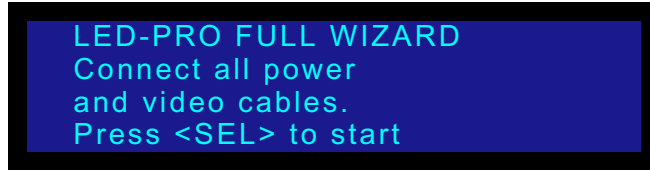

Figure 4-14. Setup Wizard Start Menu

Refer to the "[Using the Setup Wizard](#)" section on page 56 for full instructions.

Input Wizard

From the **Setup Menu**, select **Input Wizard** to display the **Input Wizard Start Menu**, which enables you to quickly and conveniently set up all inputs and position them on the LED wall. This wizard also enables you to set the wall's contrast and gamma.

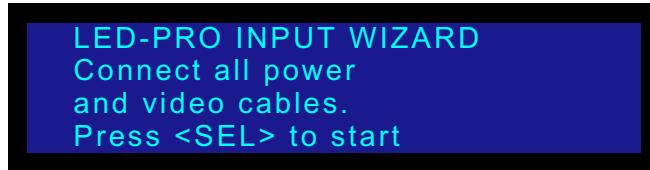

Figure 4-15. Input Wizard Start Menu

Refer to the "[Using the Input Wizard](#)" section on page 62 for full instructions.

Source Alignment – Analog

From the **Setup Menu** (for an analog input source), select **Source Alignment** to display the **Analog Source Alignment Menu**. This menu enables you to adjust all aspects of the source's "visible" parameters.



Figure 4-16. Analog Source Alignment Menu (sample)

Following are descriptions of each **Analog Source Alignment Menu** function:

- [Contrast](#)
- [Brightness](#)
- [Red Contrast](#)
- [Red Bright](#)
- [Grn Contrast](#)
- [Grn Bright](#)
- [Blue Contrast](#)
- [Blue Bright](#)
- [Sharpness](#)
- [Clip to SubBlk](#)
- [Luma Tracking](#)
- [EDID DVI](#)

Contrast

From the **Analog Source Alignment Menu**, select **Contrast** to adjust the overall contrast of the selected analog input.

- The adjustment range is 75.0% to 125.0%.
- 100% is the default setting.

4. Operation

Using the Setup Menu

Brightness

From the **Analog Source Alignment Menu**, select **Brightness** to adjust the overall brightness of the selected analog input.

- The adjustment range is 75.0% to 125.0%.
- 100% is the default setting.

Red Contrast

From the **Analog Source Alignment Menu**, select **Red Contrast** to adjust the contrast of the selected input's red channel.

- The adjustment range is -25.0% to +25.0%.
- 0.0% is the default setting.

Red Bright

From the **Analog Source Alignment Menu**, select **Red Bright** to adjust the brightness of the selected input's red channel.

- The adjustment range is -25.0% to +25.0%.
- 0.0% is the default setting.

Grn Contrast

From the **Analog Source Alignment Menu**, select **Grn Contrast** to adjust the contrast of the selected input's green channel.

- The adjustment range is -25.0% to +25.0%.
- 0.0% is the default setting.

Grn Bright

From the **Analog Source Alignment Menu**, select **Grn Bright** to adjust the brightness of the selected input's green channel.

- The adjustment range is -25.0% to +25.0%.
- 0.0% is the default setting.

Blue Contrast

From the **Analog Source Alignment Menu**, select **Blue Contrast** to adjust the contrast of the selected input's blue channel.

- The adjustment range is -25.0% to +25.0%.
- 0.0% is the default setting.

Blue Bright

From the **Analog Source Alignment Menu**, select **Blue Bright** to adjust the brightness of the selected input's blue channel.

- The adjustment range is -25.0% to +25.0%.
- 0.0% is the default setting.

Sharpness

From the **Analog Source Alignment Menu**, select **Sharpness** to adjust the sharpness of the selected input. This selection sets the scaler's sharpening (or softening) value.

- The sharpening range extends from -10 (softest) to +10 (sharpest).
- 0 is the default setting (which sets the scaler to its optimum sharpness).

Clip to SubBlk

From the **Analog Source Alignment Menu**, select **Clip to SubBlk** to eliminate low level noise in black regions of the image.

- The adjustment range is 0 to -15.
- 0 is the default setting.

Luma Tracking

From the **Analog Source Alignment Menu**, select **Luma Tracking** to prevent green haze from appearing in regions of low light.

- The adjustment range is 0 to -15.
- 0 is the default setting.

EDID DVI

From the **Analog Source Alignment Menu**, select **EDID DVI** to display the **EDID DVI In Format Menu**, which enables you to update LED-PRO's preferred EDID resolution. Refer to the "[Programming EDID](#)" section on page 53 for instructions.

4. Operation

Using the Setup Menu

Source Alignment – SDI

From the **Setup Menu** (for an SD-SDI or HD-SDI input source), select **Source Alignment** to display the **SDI Source Alignment Menu**. This menu enables you to adjust all aspects of the source's "visible" parameters.



Figure 4-17. SDI Source Alignment Menu (sample)

Following are descriptions of each **SDI Source Alignment Menu** function:

- [Contrast](#)
- [Brightness](#)
- [Hue](#)
- [Saturation](#)
- [Sharpness](#)
- [Clip to SubBlk](#)
- [Luma Tracking](#)
- [EDID DVI](#)

Contrast

From the **SDI Source Alignment Menu**, select **Contrast** to adjust the overall contrast of the selected SDI input.

- The adjustment range is 75.0% to 125.0%.
- 100% is the default setting.

Brightness

From the **SDI Source Alignment Menu**, select **Brightness** to adjust the overall brightness of the selected SDI input.

- The adjustment range is 75.0% to 125.0%.
- 100% is the default setting.

Hue

From the **SDI Source Alignment Menu**, select **Hue** to adjust the hue of the selected input. Note that **Hue** is not applicable for YPbPr inputs.

- The adjustment range (in degrees) is -180 to +180.
- 0 is the default setting.

Saturation

From the **SDI Source Alignment Menu**, select **Saturation** to adjust the saturation of the selected input.

- The adjustment range is -75 to +125.
- 100 is the default setting.

Sharpness

From the **SDI Source Alignment Menu**, select **Sharpness** to adjust the sharpness of the selected input. This selection sets the scaler's sharpening (or softening) value.

- The sharpening range extends from -10 (softest) to +10 (sharpest).
- 0 is the default setting (which sets the scaler to its optimum sharpness).

Clip to SubBlk

From the **SDI Source Alignment Menu**, select **Clip to SubBlk** to eliminate low level noise in black regions of the image.

- The adjustment range is 0 to -15.
- 0 is the default setting.

Luma Tracking

From the **SDI Source Alignment Menu**, select **Luma Tracking** to prevent green haze from appearing in regions of low light.

- The adjustment range is 0 to -15.
- 0 is the default setting.

EDID DVI

From the **SDI Source Alignment Menu**, select **EDID DVI** to display the **EDID DVI In Format Menu**, which enables you to update LED-PRO's preferred EDID resolution. Refer to the "[Programming EDID](#)" section on page 53 for instructions.

4. Operation

Using the Setup Menu

Source Alignment – DVI

From the **Setup Menu** (for a DVI input source), select **Source Alignment** to display the **DVI Source Alignment Menu**. This menu enables you to adjust all aspects of the source's "visible" parameters.



Figure 4-18. DVI Source Alignment Menu (sample)

Following are descriptions of each **DVI Source Alignment Menu** function:

- [Contrast](#)
- [Brightness](#)
- [Sharpness](#)
- [EDID DVI](#)

Contrast

From the **DVI Source Alignment Menu**, select **Contrast** to adjust the overall contrast of the selected DVI input.

- The adjustment range is 75.0% to 125.0%.
- 100% is the default setting.

Brightness

From the **DVI Source Alignment Menu**, select **Brightness** to adjust the overall brightness of the selected SDI input.

- The adjustment range is 75.0% to 125.0%.
- 100% is the default setting.

Sharpness

From the **DVI Source Alignment Menu**, select **Sharpness** to adjust the sharpness of the selected input. This selection sets the scaler's sharpening (or softening) value.

- The sharpening range extends from -10 (softest) to +10 (sharpest).
- 0 is the default setting (which sets the scaler to its optimum sharpness).

EDID DVI

From the **DVI Source Alignment Menu**, select **EDID DVI** to display the **EDID DVI In Format Menu**, which enables you to update LED-PRO's preferred EDID resolution. Refer to the "[Programming EDID](#)" section on page 53 for instructions.

Presets

From the **Setup Menu**, select **Presets** to display the **Global Preset Menu**, which enables you to store, recall or delete up to 16 Presets (or "Views"). Each Preset is essentially a "global" combination of pan and zoom settings which can be applied to *any input*. Whereas the Presets in the **Pan & Zoom Menu** are input specific, "global" Presets in the **Setup Menu** are independent of any specific input.

- ▲ You can define a global Preset that maps the entire input image to the upper left quarter of the output image.

Please note:

- A global Preset is defined by first creating the desired image settings in the **Pan & Zoom Menu**.
- Once created, the settings may be saved (and named) in the **Global Preset Menu** under the **Setup Menu** heading. (Presets cannot be named in the **Pan & Zoom Menu**.)
- A stored global Preset can be recalled and applied to the currently selected input.

The figure below illustrates the **Global Preset Menu**:



Figure 4-19. Global Preset Menu

Following are descriptions of each menu function:

- [Recall](#)
- [Save](#)
- [Delete](#)

Recall

From the **Global Preset Menu**, select **Recall** to display the **Recall Preset Menu**, which enables you to choose a stored Preset and assign it to the currently selected input.



Figure 4-20. Recall Preset Menu

- To recall a global preset:
 1. On the **Preset** line, press **SEL**. The navigation cursor (>) changes to the edit cursor (#).
 2. Choose a Preset by turning the knob, and "accept" it by pressing **SEL**. Note that 15 Presets are listed, along with the "Default" preset which contains default pan (0%) and zoom (100%) settings.

4. Operation

Using the Setup Menu

3. Scroll to the **Recall** line and press **SEL**. The global Preset is recalled and applied to the selected input.

Save

From the **Global Preset Menu**, select **Save** to display the **Save Preset Menu**, which enables you to save the current pan and zoom settings using one of 15 predefined names (**Preset 1** through **Preset 15**).



Figure 4-21. Save Preset Menu

- To save a global preset:
 1. On the **Preset** line, press **SEL**.
 2. Choose the desired Preset file by turning the knob, and “accept” it by pressing **SEL**. All 15 global Presets are listed.
 3. Scroll to the **Save** line and press **SEL**.
 - ~ If the Preset file is empty, the message “**Preset Saved**” appears to confirm the procedure.
 - ~ If the file is already in use, a confirmation menu appears:
 - Press **SEL** to overwrite the Preset.
 - Press **ESC** to return to the **Save Preset Menu**, enabling you to change the filename.

Delete

From the **Global Preset Menu**, select **Delete** to display the **Delete Preset Menu**, which enables you to delete the contents of a selected Preset.



Figure 4-22. Delete Preset Menu

- To delete a global preset:
 1. On the **Preset** line, press **SEL**.
 2. Choose the desired file by turning the knob, and “accept” it by pressing **SEL**.
 3. Scroll to the **Delete** line and press **SEL** to display a confirmation menu.
 - ~ Press **SEL** to delete the Preset.
 - ~ Press **ESC** to return to the **Delete Preset Menu**, enabling you to select a different file to delete.

RS232

From the **Setup Menu**, select **RS232** to display the **RS232 Menu**, which enables you to set the baud rate for the rear panel **RS-232** connector.



Figure 4-23. RS232 Menu (sample)

■ To set the RS-232 connector's baud rate:

1. On the **Baud** line, press **SEL**. The navigation cursor (>) changes to the edit cursor (#).
2. Choose the desired baud rate with the knob, and “accept” it by pressing **SEL**. Choices include 19200, 38400, 57600 and 115200. Note that the selected Baud rate is not updated until the **SEL** button is pressed.

Note

Most operations will be performed at 19200.

Note

If LED-PRO is placed in **Remote** mode and Director Toolset is connected, the Director Toolset may update the **RS232 Menu** with a different setting, such as 115200.

Expert Mode

From the **Setup Menu**, select **Expert Mode** to display the **Expert Mode Menu**, which provides extensive “advanced” system setup functions. Refer to the [“Using the Expert Mode Menu”](#) section on page 66 for full instructions.

Save System State

From the **Setup Menu**, select **Save System State** to perform the following functions:

- Save all input, output and system settings in non-volatile memory — so they can be restored at power up.

Note

When the **Status Menu** is next selected, the message “**Last Saved** [1, 2, 3 or 4]” appears on line 2, depending upon which input is selected.

- Save a specific input so that it will be acquired and selected at power up. By default, input 1 is selected at bootup and after a factory reset.

Note

If you do not perform the “**Save System State**” function, some system information may not be restored upon the next system power up.

4. Operation

Using the Setup Menu

- To save the system state:
 1. Select the input button (in the front panel **Inputs Section**) that you want to be acquired and selected at power-up.
 2. Press **SETUP** to display the **Setup Menu**.
 3. Select the **Save System State** line and press **SEL**. The “**Saving System State**” message appears, confirming the process.

Note

This procedure is identical to the **Save System State** procedure located in the **System Menu (SETUP > Expert Mode > System)**.

Factory Reset

From the **Setup Menu**, select **Factory Reset** to display the **Factory Reset Menu**, which enables you to reset LED-PRO to its "factory default" condition.



Figure 4-24. Factory Reset Menu

Note that this procedure deletes all saved user information, input configurations, output configuration, custom formats, presets and the LOGO (if stored in flash memory).

- To perform a factory reset:
 1. Select the **Factory Reset** line and press **SEL**.
 - ~ Press **SEL** to perform a factory reset. A confirmation menu is shown, and the system is rebooted.
 - ~ Press **ESC** to return safely to the previous menu.

Note

This procedure is identical to the **Factory Reset** procedure located in the **Expert Mode Menu (SETUP > Expert Mode)**.

Programming EDID

The **EDID DVI Input Format Menu** enables you to update LED-PRO's preferred EDID resolution. The menu can be accessed from several points within the menu tree, but all programming procedures are identical.

Important

This menu is designed for advanced users only. Do not reprogram the EDID unless it is necessary.

EDID (Extended Display Identification Data) is a VESA standard data format that contains information about a display device and its capabilities, including the preferred (and the allowed) resolutions of the device.

Please note:

- LED-PRO's EDID file is stored in non-volatile memory.
- The EDID file is read by a computer's DVI graphic card when its DVI output is connected to LED-PRO's channel 1 DVI-I input connector during boot-up.
- LED-PRO must be powered on first for the EDID information to be read.

■ Use the following steps to program EDID:

1. Ensure that there are *no cables* connected to LED-PRO's DVI-I input and loop through connectors.

Important

If a DVI input is connected to LED-PRO, it will interfere with the programming operation, and cause it to fail. If a Flat Panel monitor is connected on the loop through, it's own EDID information will also be changed.

2. From the **Source Alignment Menu**, select **EDID DVI** to display the **EDID DVI In Format Menu**, a sample of which is shown below. Line 2 (the "**Format**" line) displays LED-PRO's current EDID resolution:



Figure 4-25. EDID DVI In Format Menu (sample)

3. Scroll to the **Format** line and press **SEL**.
4. Rotate the **ADJUST** knob and select the preferred resolution. Press **SEL** to "accept" the selection.

4. Operation

Using the Setup Menu

5. Scroll to the **Program EDID** line and press **SEL**. The following warning message is shown:



Figure 4-26. EDID Warning Message

- ~ Press **SEL** to proceed with the non-volatile memory programming.
- ~ Press **ESC** key to cancel the operation.

As an additional precaution, LED-PRO verifies that no cables are connected to the DVI-I input and loop through connectors. If a DVI source or display device is detected, the following message appears:



Figure 4-27. EDID DVI Input Detection Error Message

- ~ Disconnect all cables from the DVI input connectors, then press **ESC** to continue with programming.

Once the system detects that no DVI source or display is connected, LED-PRO proceeds with programming. The following message is shown:

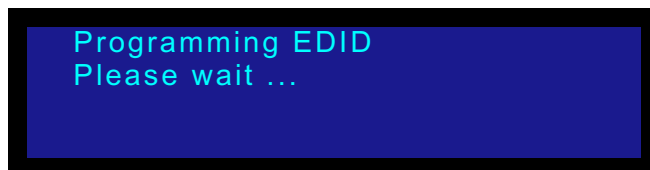

Figure 4-28. EDID Programming Message

- ~ If programming is successful, please continue with step **6**.
- ~ If programming fails, the following message is shown:

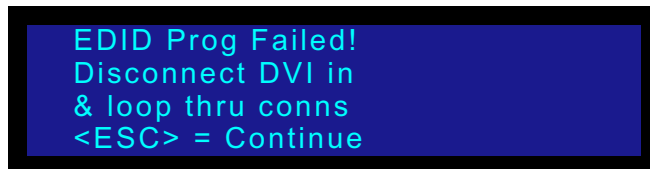

Figure 4-29. EDID Programming Failed Message

4. Operation

Using the Setup Menu

If this error message persists and there is no DVI source or display device connected to LED-PRO, please contact Barco customer service. In Appendix C, refer to the "[Contact Information](#)" section on page 162 for details.

6. If programming is successful, the following message is shown:

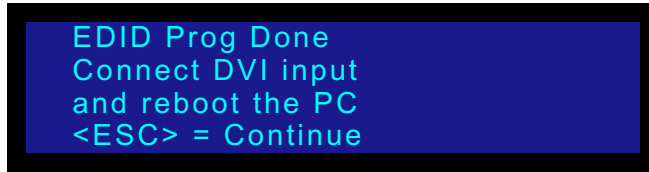

Figure 4-30. EDID Programming Successful Message

Press **ESC** to return to the **EDID DVI In Format Menu**.

7. Reconnect the DVI cable from your computer to LED-PRO.
8. Reboot the computer in order for the new EDID information to be read, and for the new preferred resolution to become available.

4. Operation

Using the Setup Wizard

Using the Setup Wizard

The **Setup Wizard** allows users to quickly set up and align a basic LED display — without the need of the Director Toolset. The Wizard automatically guides the user through the entire setup process, including:

- Wall detection (type and size)
- Addressing and positioning tiles
- Aligning LED-PRO's output resolution to match the wall
- Wall contrast and gamma adjustment

Please note the following important points:

- The Wizard can only be used with standard LED Tiles. MiPIX, MiSPHERE and creative OLite displays require the Director Toolset.
- The Director Toolset is still required for wall color calibration, tile firmware updates, and for creating and applying custom gamma curves.

■ Use the following steps to run the **Setup Wizard**:

1. Please note the following important Setup Wizard prerequisites:

- ~ Ensure that your LED wall is properly connected to LED-PRO, and that power is enabled to all devices.
- ~ Ensure that you know how your LED wall is cabled (e.g., horizontally or vertically), as shown below:

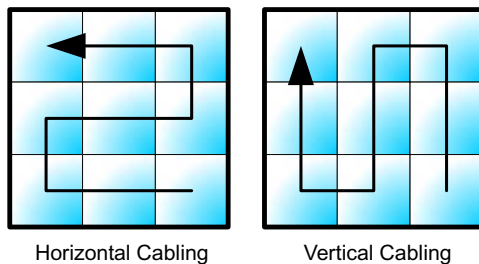

Figure 4-31. LED Tile Cabling Examples

- ~ Ensure that you know where your “first” LED tile is located, as viewed from the front of the wall (e.g., the bottom left). This is the tile to which LED-PRO (or Fiberlink) is connected.

2. From the **Setup Menu**, select **Setup Wizard** to display the **Setup Wizard Start Menu**.

4. Operation

Using the Setup Wizard

3. Press **SEL** to launch the wizard and display the **Setup Wizard Start Message**.

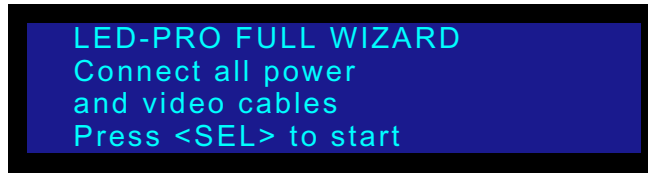

Figure 4-32. Setup Wizard Start Message

Note

An error message will be shown if the LED wall is not connected.

4. Press **SEL** to continue. During this interval, LED-PRO will detect the tiles, query the tiles and count the number of tiles. The larger the LED wall, the longer the interval.
 - ~ If no errors are detected, at the conclusion of this “detection” interval, the **Wall Information Menu** is displayed as shown below.
 - ~ If errors were detected, please continue with step 5 below.

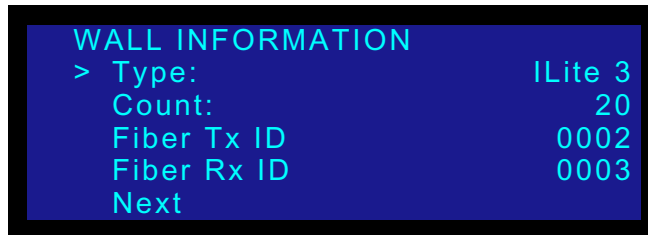

Figure 4-33. Wizard - Wall Information Menu (sample)

Following are descriptions of each menu field:

- ~ **Type** — displays the type of LED tile detected.
- ~ **Count** — displays the number of LED tiles detected.
- ~ **Fiber Tx ID** — displays the address of the Fiberlink transmitter, if used.
- ~ **Fiber Rx ID** — displays the address of the Fiberlink receiver, if used.

If no errors were detected during the “detection” interval, continue with step 6.

5. If errors were found during the “detection” interval, the **Wall Information Menu** will not be shown. Instead, one of four possible messages will be shown:
 - ~ If no tiles were detected, you will be asked to “**Check cabling and power.**” When complete, press **SEL** to continue.
 - ~ If the **Fiberlink Transmitter** is detected but the **Receiver** is not, you will be asked to “**Check cabling and power.**” During this interval, a white test pattern will appear. Press **SEL** to continue, and then verify that wall is powered up.
 - ~ If both the **Fiberlink Transmitter** and **Receiver** are detected, but no tiles are detected, you will be asked to “**Check cabling and power.**” During this interval, a white test pattern will appear. Press **SEL** to continue, and then verify that wall is powered up.

4. Operation

Using the Setup Wizard

- ~ If the system detects “creative” LED tiles, such as MiSPHERE and MiPIX, the message “**Tile type not supported**” will appear. Because these tile types are not supported by the Wizard, please use Director Toolset for setup.

Note

If any of the errors listed above are detected more than once, the system will request that you contact **Technical Support**.

6. From the **Wall Information Menu**, select **Next** to display the **Set Wall Dimensions Menu**, which allows you to set the number of horizontal and vertical tiles in the wall:

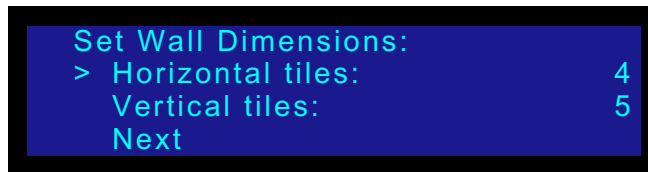

Figure 4-34. Set Wall Dimensions Menu (sample)

7. Enter the number of horizontal and vertical tiles, and press **NEXT**.
 - ~ If the LED tile count is correct, the **Wall Data Connection Menu** will be shown. Please continue with step 8.
 - ~ If the LED tile count (as entered) is incorrect, the **Tile Count Mismatch Menu** is shown.

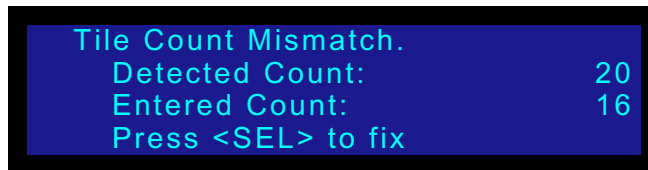

Figure 4-35. Tile Count Mismatch Menu (sample)

Press **SEL** to return to the **Set Wall Dimensions Menu**, and enter the correct number of horizontal and vertical tiles. Please note:

- If you enter fewer tiles than are actually detected, the system “loops” back to the **Set Wall Dimensions Menu**.
- If you enter more tiles than are actually detected (and you do this three times), a test pattern will appear to enable you to visually check the wall for errors. At this point, check all power and data cabling, and press **SEL** to continue with a repeat of the “detection” process.

- From the **Set Wall Dimensions Menu**, the **Wall Data Connection Menu** appears.

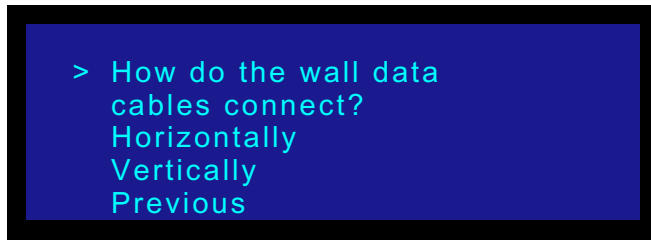

Figure 4-36. Wall Data Connection Menu

- ~ Select **Horizontally** if cables are connected horizontally.
 - ~ Select **Vertically** if cables are connected vertically.
 - ~ Select **Previous** to return to the previous menu in the wizard.
- After selecting the correct data cable connection, the **Tile Connection Menu** appears.

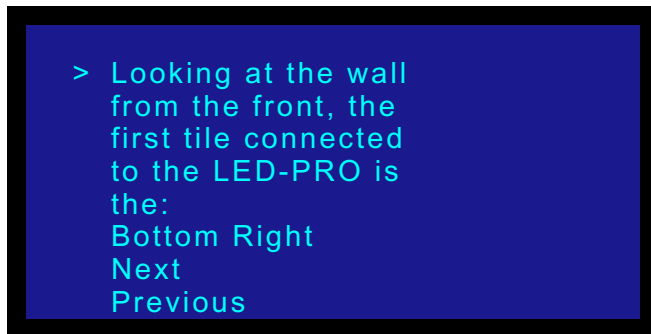

Figure 4-37. Tile Connection Menu (sample)

Highlight the correct connection point, and press **SEL**. Please note:

- ~ In a standard tile array, choices are **Bottom Right**, **Bottom Left**, **Top Right**, and **Top Left**.
 - ~ In a horizontal tile array that is one tile in height, choices are **Left** or **Right**.
 - ~ If a vertical tile array that is one tile wide, choices are **Top** or **Bottom**.
- Select **Next** to display the **Rolling Grid Test Menu**. During this interval, the system configures the wall, and displays a test pattern with diagonal motion.

4. Operation

Using the Setup Wizard

The figure below illustrates the **Rolling Grid Test Menu**.

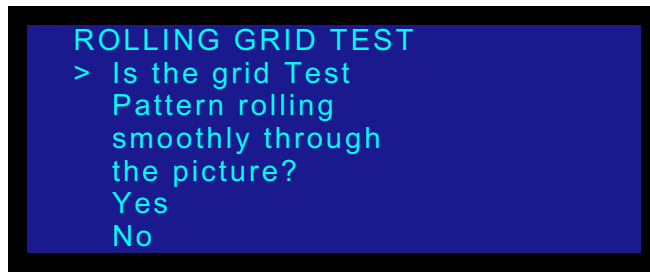

Figure 4-38. Rolling Grid Test Menu

Note

The raster box may flash on and off, on the left and top edges of the image. This is normal.

- ~ Select **Yes** if the grid test pattern rolls smoothly through the picture. Please continue with step **11**.
- ~ Select **No** if the grid does not roll smoothly through the picture. In this case, the system asks you to check data cabling.
 - Press **SEL** to return to the **Wall Data Connection Menu**.
 - Re-enter the proper horizontal or vertical cabling, and press **SEL** to continue again with the **Tile Connection Menu** and **Rolling Grid Test Menu**.

11. From the **Rolling Grid Test Menu**, the **Position Output Menu** appears.

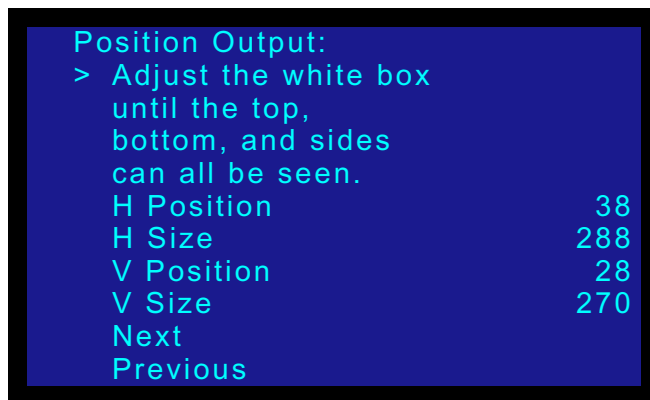

Figure 4-39. Position Output Menu (sample)

If required:

- ~ Select **H Position** and adjust the raster box for a perfect outline.
- ~ Select **H Size** and adjust the raster box for a perfect outline.
- ~ Select **V Position** and adjust the raster box for a perfect outline.
- ~ Select **V Size** and adjust the raster box for a perfect outline.

Note

Typically, there should not be a need to adjust the sizes.

12. Select **Next** to display the **Input Type Menu**:

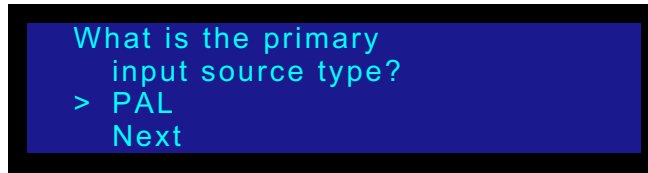

Figure 4-40. Input Type Menu (sample)

- ~ Select **PAL** if your primary inputs are PAL.
- ~ Select **NTSC/PC** if your primary inputs are NTSC or a PC.

This completes the Setup Wizard procedure.

13. Select **Next** to save the new output configuration. The system displays the **Input Wizard Query**.

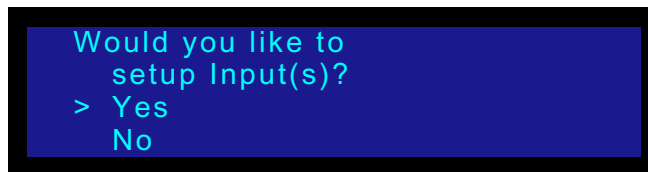

Figure 4-41. Input Wizard Query

- ~ Select **Yes** to launch the **Input Wizard**. Refer to the [“Using the Input Wizard”](#) section on page 62 for details.
- ~ Select **No** to exit and display the **Status Menu**.

Please note the following important points regarding special “automatic” Wizard settings:

- **OLite LED Tiles**

If you are using **OLite** tiles, the Setup Wizard has automatically set the “Creative Mode” (on the **LED Menu**) to **Normal**.

- ~ To perform a complete “creative” setup instead, use the **Director Toolset**, and then enable the creative mode on the **LED Menu**.
- ~ Refer to the [“Creative Mode”](#) section on page 103 for additional details.

- **SLite and DLite LED Tiles**

If you are using **SLite** and **DLite** tiles, the Setup Wizard has automatically set the “Tile Mode” (on the **LED Menu**) to **Virtual**.

- ~ If you want to enable the “Real” mode instead:
 - Select the **Tile Mode** function on the **LED Menu**, and select **Real**.
 - Use the **Expert Mode** to set up **H** and **V** sizes on the output.
- ~ Refer to the [“Tile Mode”](#) section on page 103 for additional details.

4. Operation

Using the Input Wizard

Using the Input Wizard

The **Input Wizard** allows users to easily setup and align input sources. It automatically detects and re-scales the selected input source to match the physical size of the LED display.

- Use the following steps to run the **Input Wizard**:
 1. Please note the following important Input Wizard prerequisites:
 - ~ Ensure that your inputs are properly connected to LED-PRO.
 - ~ Ensure that you have run the Setup Wizard, to properly configure your LED wall.
 2. From the **Setup Menu** (or from the last step in the **Setup Wizard**), select **Input Wizard** to display the **Input Wizard Start Menu**.
 3. Press **SEL** to launch the wizard and display the **Input Wizard Start Message**.

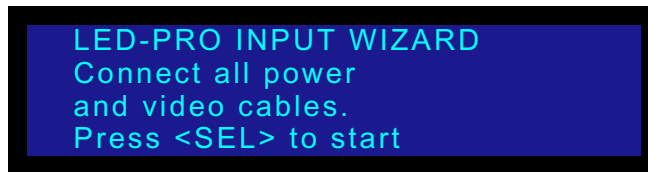

Figure 4-42. Input Wizard Start Message

Note

An error message will be shown if the LED wall is not connected.

4. Press **SEL** to display the **Select Input Menu**. Note that the **Raster Box** appears on the LED wall.



Figure 4-43. Select Input Menu (sample)

On the menu, there are two ways to select the input that you want to adjust:

- ~ Press the desired input button in the **Inputs Section** of the front panel.
- ~ Select the **Input** line, and use the **ADJUST** knob to select the desired input.

If selected input is invalid, the **"No Input Detected"** message is shown. In this case, select another input, or check the cable connections on the input that caused the error.

4. Operation

Using the Input Wizard

5. After selecting the desired input, select **Next** to display the **Position & Size Menu**.



Figure 4-44. Position and Size Menu (sample)

Tip

On the selected input source, use a full screen output signal such as a test pattern or a “freeze frame.” In this mode, you want to see all edges of the image clearly, with video other than black.

- ~ Select **H Position** and adjust the input to fill the raster box precisely.
 - ~ Select **H Size** and adjust the input to fill the raster box precisely.
 - ~ Select **V Position** and adjust the input to fill the raster box precisely.
 - ~ Select **V Size** and adjust the input to fill the raster box precisely.
6. Select **Next** to display the **Wall Contrast Menu**, which enables you to set the LED wall contrast — *for all inputs*.

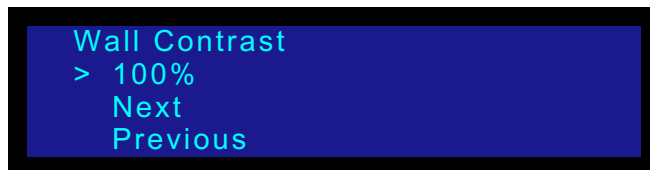

Figure 4-45. Wall Contrast Menu (sample)

- ~ Select the **Value** line, and adjust for the desired wall contrast — from **0** to **100**. Press **SEL** to enable.
7. Select **Next** to display the **Wall Location Menu**, which enables you to set the LED wall's gamma — *for all inputs*.



Figure 4-46. Wall Location Menu (sample)

- ~ Select the gamma curve line, and choose the desired mode: **Inside**, **Outside**, or **Custom**.

4. Operation

Using the Input Wizard

Please note the following important points regarding the gamma curve:

- ~ If you previously selected (and stored) a custom gamma curve with the **Director Toolset**, LED-PRO will query the tiles and recognize the curve as "custom."
 - ~ If you have used the "**Expert Mode**" to set up a gamma curve, four values are available: **Indoor 1**, **Indoor 2**, **Outdoor 1** and **Outdoor 2**.
 - The Expert Mode's **Indoor 2** setting is recognized by the Wizard as the **Inside** mode.
 - The Expert Mode's **Outdoor 2** setting is recognized by the Wizard as the **Outside** mode.
 - **Indoor 1** and **Outdoor 1** settings are recognized by the Wizard as the **Custom** mode.
8. Select **Next** to display the **Save Config As Menu**, which enables you to save the input configuration for the *selected input only*.



Figure 4-47. Save Config As Menu (sample)

- To save an input configuration:
 - a. Scroll to the **filename** field (e.g., **File1**) and press **SEL**. The navigation cursor (>) changes to the edit cursor (#), allowing you to edit the first character.
 - b. Choose a character by turning the knob, and "accept" it by pressing **SEL**. This action also selects the next character for editing.
 - c. Repeat step **b** for all desired characters.
 - d. When data entry is complete, press **SEL** again. The filename will be truncated up to the current character position.
 - e. To save the input configuration under the selected filename, scroll to the **Save Config** line and press **SEL**.
 - If the selected filename has never been used, the message "**Config Saved**" appears.
 - If the selected filename is already in use, the **Overwrite File Menu** appears.

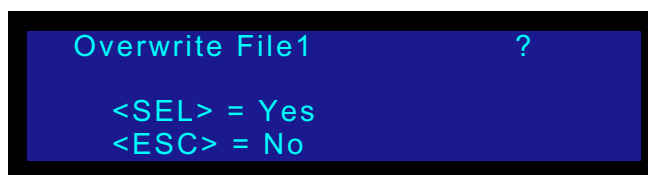

Figure 4-48. Overwrite File Menu (sample)

- Press **SEL** to overwrite the file, or ...
- Press **ESC** to return to the **Save Config As Menu**, enabling you to change the filename.

4. Operation

Using the Input Wizard

9. When the **Setup Another Input Query** is shown:
 - ~ Select **Yes** to return to the **Select Input Menu**. Repeat steps 4 through 8 for each additional input.
 - ~ Select **No** to exit the wizard, and return to the **Status Menu**. After you exit, the system performs an automatic "**Save System State**" procedure to save all inputs, outputs and system configurations.

4. Operation

Using the Expert Mode Menu

Using the Expert Mode Menu

The following topics are discussed in this section:

- [Expert Mode Menu Tree](#)
- [Expert Mode Menu Description](#)

Expert Mode Menu Tree

From the **Setup Menu**, select **Expert Mode** to display the **Expert Mode Menu**. The figure below illustrates the complete **Expert Mode Menu Tree**.

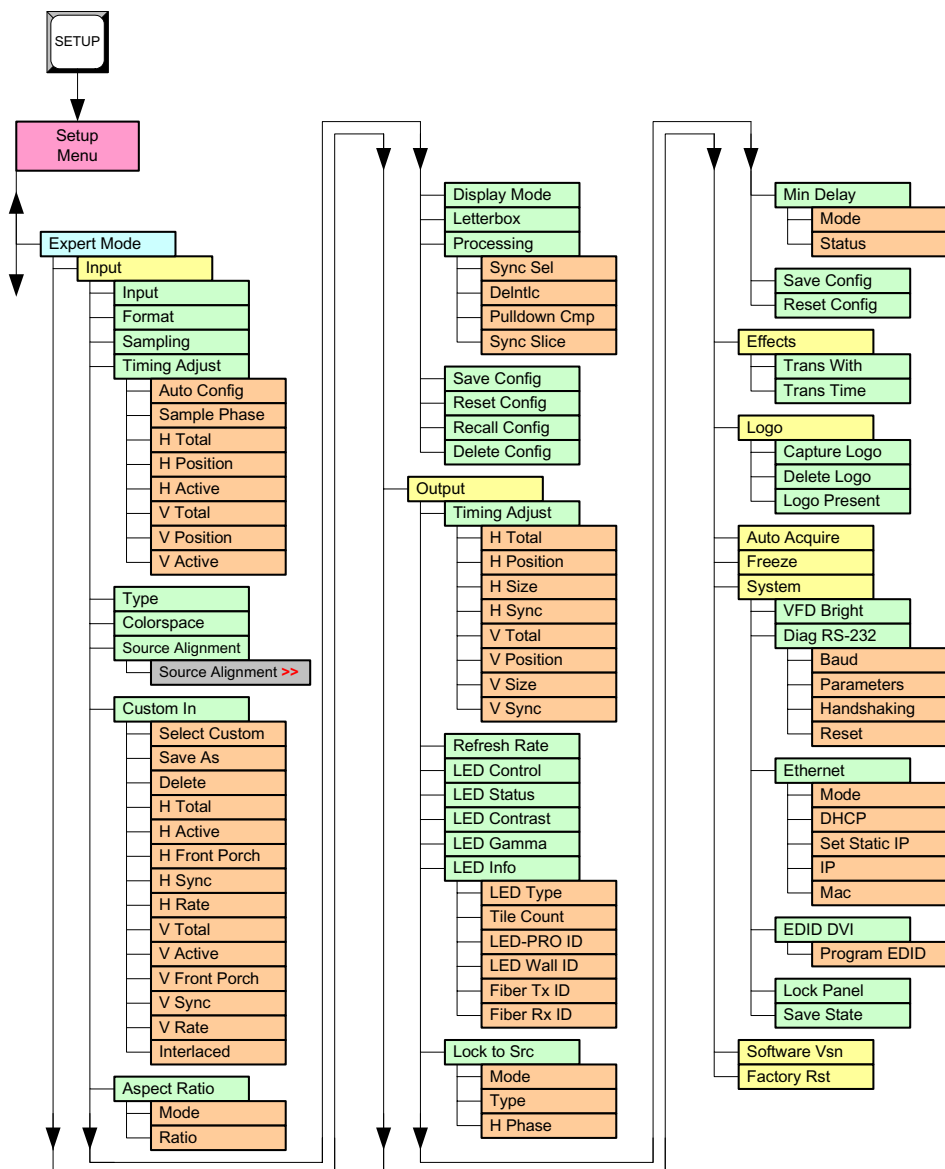

Figure 4-49. Expert Mode Menu Tree

Expert Mode Menu Description

The **Expert Mode Menu** provides extensive “advanced” system setup functions. A sample menu is shown below.



Figure 4-50. Expert Mode Menu (sample)

Following are descriptions of each menu function:

- [Input](#)
- [Output](#)
- [Effects](#)
- [Logo](#)
- [In Auto Acquire](#)
- [Freeze](#)
- [System](#)
- [Software Version](#)
- [Factory Reset](#)

4. Operation

Using the Expert Mode Menu

Input

From the **Expert Mode Menu**, select **Input** to display the **Input Setup Menu** for the selected source. A sample menu is shown below.

Note

The **Input Setup Menu** changes dynamically as you switch input sources. The top menu line always reflects the selected input number and format.

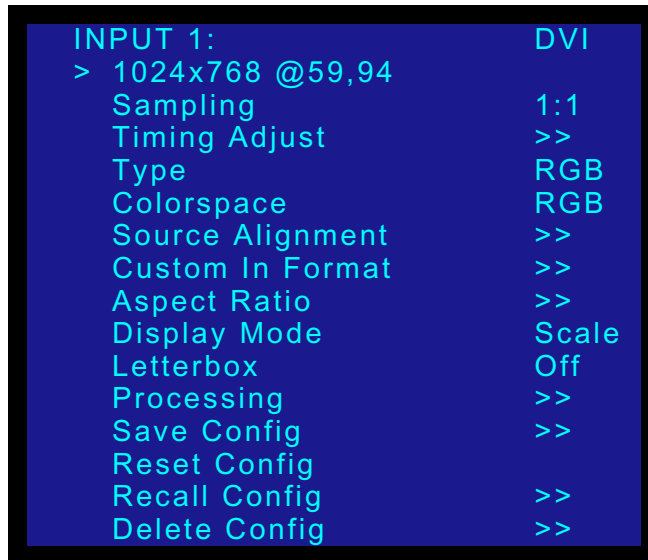

Figure 4-51. Input Setup Menu (sample)

Following are descriptions of each menu function:

- [Input Format](#)
- [Sampling](#)
- [Timing Adjust](#)
- [Type](#)
- [Colorspace](#)
- [Source Alignment](#)
- [Custom In Format](#)
- [Aspect Ratio](#)
- [Display Mode](#)
- [Letterbox](#)
- [Processing](#)
- [Save Config](#)
- [Reset Config](#)
- [Recall Config](#)
- [Delete Config](#)
- [Unsaved Changes](#)

Input Format

On the **Input Setup Menu**, the top **Input Format** line indicates the current input video format in the following form:

Hact x Vact @ Vr Hz

▲ 1024x768 @75 Hz

Please note:

- If the currently selected input does not have a valid input signal, the message **"Invalid Signal"** is shown.
 - When **"In Auto Acquire"** is enabled, the input video format will be detected in the following search order:
 - ~ Last used configuration for the selected input channel
 - ~ Any saved input configuration
 - ~ Any custom library formats created by the user
 - ~ Standard library formats
 - ~ "Best guess" format, to the closest format in library
 - If the video format is a "best guess," it will be displayed within asterisks.
▲ *1024x768 @60.11*
 - If the video format is recalled from a saved input configuration, a **"c"** is displayed as the right most character.
▲ 1024x768 @59.94 c
 - When **"In Auto Acquire"** is off, LED-PRO attempts to lock to the input video format selected by the user. If the currently selected format does not match the input signal for the selected channel, the display remains black and the menu indicates **"Invalid Signal."**
- To change the input video format:
1. Select the input that you wish to change.
 2. On the **Input Setup Menu**, select the top **Input Format** line. The navigation cursor (>) changes to the edit cursor (#).
 3. Use the knob to select the desired format. Press **SEL** to accept.
 4. Repeat from step 1 for additional inputs, as required.

Note

If **"In Auto Acquire"** is enabled, LED-PRO may change a manually selected format back to a format that it automatically detects.

Sampling

In order to scale an image, it must first be digitized. This is the process of changing the analog graphics signals (e.g., Red, Green, and Blue) into pixels that are stored in LED-PRO's image memory. Two modes are available:

- The **"oversample"** mode produces more samples than are present in the original input image. The oversampled image is then scaled to the final output resolution.
- The **"1:1 Sampling"** mode produces a superior image by sampling the analog video signal at exactly the same rate as the original source. This method allows the image to be re-constructed with reduced digitizing artifacts.

4. Operation

Using the Expert Mode Menu

Please note:

- The 1:1 mode requires very accurate settings, as even a small sampling error can cause noise on the output image.
- Both the sample clock frequency and phase must be correct to obtain a properly sampled image.
- LED-PRO incorporates automatic adjustments in the 1:1 sampling mode.

■ To change the sampling mode:

1. On the **Input Setup Menu**, select **Sampling**.
2. Choose either **OverSample** or **1:1**, and press **SEL** to accept.

Please note:

- 1:1 is the default setting.
- The OverSample option is only available for **RGB** and **YPbPr** analog inputs. All other input types have defined sample clocks that are inherently 1:1. If the input is set to one of the other types, the value for this selection will be “n/a.”

Timing Adjust

From the **Input Setup Menu**, select **Timing Adjust** to display either the **1:1 Timing Adjust Menu** or the **OverSample Timing Adjust Menu** — depending on your selected sampling mode. Each menu allows for exact positioning of the input signal's active area.

- [1:1 Timing Adjust Menu](#)
- [OverSample Timing Adjust Menu](#)

■ 1:1 Timing Adjust Menu

When 1:1 sampling is selected, the **1:1 Timing Adjust Menu** is shown:

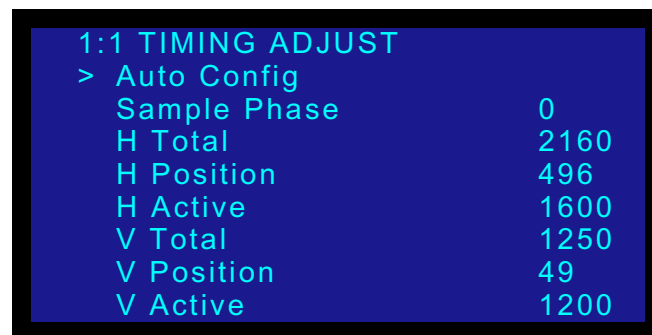

Figure 4-52. 1:1 Timing Adjust Menu (sample)

Following are descriptions of each menu function, which are only available when **1:1 Sampling** is selected, and the input is analog **RGB** or **YPbPr**.

- **Auto Config** — causes the system to run the “**1:1 active area acquisition**” procedure.

Note

For the **Auto Config** procedure to function correctly, the input source for the selected channel must have 50% gray or brighter pixels around all four edges of the active area.

4. Operation

Using the Expert Mode Menu

- **Sample Phase** — enables you to fine-tune the image by adjusting the sample clock phase. Please note:
 - ~ The adjustment range is -16 to 15.
 - ~ Zero is the default setting.
 - ~ The value is initially filled in by the Auto Config command, or set to the default.
- **H Total** — enables you to adjust (in pixels) the total pixel count per line.

Note

H Total cannot be adjusted if the input type is DVI or SDI.

- **H Position** — adjusts (in pixels) the offset of the start of active area from H sync.
- **H Active** — adjusts (in pixels) the size of the active area.
- **V Total** — adjusts (in lines) the total line count per frame.
- **V Position** — adjusts (in lines) the offset of the start of active area from V sync.
- **V Active** — adjusts (in lines) the size of the active area.

Tip

When adjusting input timing, turn on the **Output Raster Box**, and adjust the input image to align with all four edges of the raster box.

■ OverSample Timing Adjust Menu

When **OverSample** is selected, the **Oversample Timing Adjust Menu** is shown:



Figure 4-53. OverSample Timing Adjust Menu (sample)

Following are descriptions of each menu function, which are only available when **OverSample** is selected.

- **Right Edge** — adjusts (in pixels) the right edge location, relative to the start of H Sync.
- **Left Edge** — adjusts (in pixels) the left edge location, relative to the start of H Sync.
- **Top Edge** — adjusts (in lines) the top edge, relative to the start of V Sync.
- **Bottom Edge** — adjusts (in lines) the bottom edge, relative to the start of V Sync.

Tip

When adjusting input timing, turn on the **Output Raster Box**, and adjust the input image to align with all four edges of the raster box.

4. Operation

Using the Expert Mode Menu

Type

From the **Input Setup Menu**, select **Type** to choose among the possible signal types available at the current input channel. Please note:

- Values are: RGB, YPbPr, NTSC/PAL/SECAM, SDI, and DVI.
- When “**In Auto Acquire**” is enabled, the “type” selections will be limited depending on the signal present on the currently selected input.
 - ▲ If input 1 is connected to a DVI source, DVI will be the only choice — which cannot be changed. Similarly, SDI will be the only choice whenever the SDI input is selected.
- When “**In Auto Acquire**” is off, the “type” selections are expanded to allow you to manually select the Video type.

Colorspace

From the **Input Setup Menu**, select **Colorspace** to choose among the possible component video standards for YPbPr. Please note:

- Values are: RGB, SMPTE, BETA and M-II.
- For all other video types, color space is set to RGB and cannot be changed.
- The default selection for YPbPr is SMPTE. You may change this setting to BETA or M-II to allow the LED-PRO to correctly sample the Y, Pb and Pr components across their full dynamic range.

Source Alignment

From the **Input Setup Menu**, select **Source Alignment** to display one of three **Source Alignment menus** — depending upon the format of the selected source — analog, SDI or DVI. These procedures are identical to those located on the **Setup Menu**.

- For analog input sources, refer to the “[Source Alignment — Analog](#)” section on page 43 for instructions.
- For SDI input sources, refer to the “[Source Alignment — SDI](#)” section on page 46 for instructions.
- For DVI input sources, refer to the “[Source Alignment — DVI](#)” section on page 48 for instructions.

Custom In Format

From the **Input Setup Menu**, select **Custom In Format** to display the **Custom Input Formats Menu**, which enables you to define and save a new input video format — or to edit and save a previously-defined format. Please note:

- Saved formats are stored in a user library, which is searched (after the standard system library is searched) during the auto-acquisition process.
- All saved formats are available as input formats on any input channel.
- A maximum of 32 custom formats may be stored.

The figure below illustrates the **Custom Input Formats Menu**:

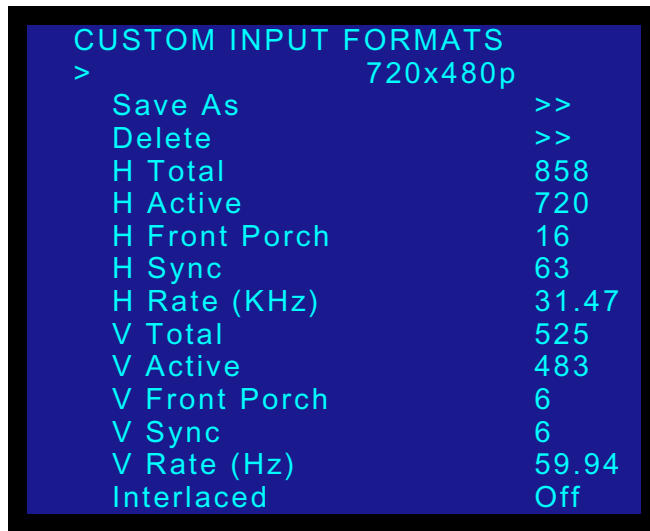

Figure 4-54. Custom Input Formats Menu (sample)

Following are descriptions of each menu function:

- **Custom Format** — enables you to select a custom format. The choices consist of the formats within the standard formats library (excluding TV standard formats) plus any previously-defined formats. The initial value is 720x480p.
- **Save As** — enables you to save custom parameters in non-volatile memory — to an existing or new name. If the “**Save As**” function is not selected, the information will *not* be restored upon the next system power up.
 - To save a custom format:
 - a. From the Custom Input Formats Menu, select **Save As** to display the **Save Custom Format As** menu.



Figure 4-55. Save Custom Format As Menu (sample)

- b. Scroll to the **format name** field (e.g., **Format1**) and press **SEL**. The navigation cursor (>) changes to the edit cursor (#), allowing you to edit the first character.
- c. Choose a character by turning the knob, and “accept” it by pressing **SEL**. This action also selects the next character for editing.
- d. Repeat step **c** for all desired characters.
- e. When data entry is complete, press **SEL** again.
- f. To save the format under the selected name, scroll to the **Save** line and press **SEL**.

4. Operation

Using the Expert Mode Menu

- If the selected filename has never been used, the message "**Format Saved**" appears.
- If the selected filename is already in use, the **Overwrite Custom Format Menu** appears.

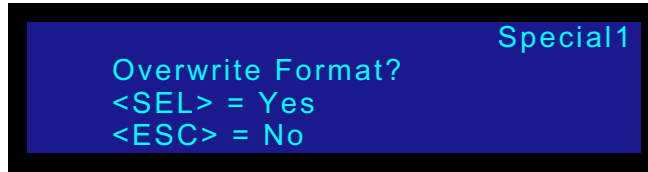

Figure 4-56. Overwrite Custom Format Menu (sample)

- Press **SEL** to overwrite the file.
- Press **ESC** to return to the **Save Format As Menu**, enabling you to change the filename.

Please note:

- ~ If the format library is full, the "**Library Full**" message will be shown. In this case, it is recommended that you press **ESC**, scroll through the names already in the library, and replace one of them.
- ~ If you attempt to save a new format with a reserved name (one that is already used in the standard library), the "**Reserved Name**" message will be shown. In this case, it is recommended that you press **ESC**, and re-edit the name.
- **Delete** — enables you to delete any saved user formats from the library.
 - To delete a custom format:
 - a. From the **Custom Input Formats Menu**, select **Delete** to display the **Delete Format Menu**.



Figure 4-57. Delete Format Menu (sample)

- b. Scroll to the **format name** field and press **SEL**. The navigation cursor (>) changes to the edit cursor (#).
- c. Choose a format by turning the knob, and "accept" it by pressing **SEL**.
- d. To delete the format, scroll to the **Delete** line and press **SEL**.
- e. When the "confirmation" screen appears,
 - Press **SEL** to delete the file.
 - Press **ESC** to return to the **Delete Format Menu**, enabling you select a different file, or cancel the procedure (via **ESC**).

Please note:

- ~ If the selected format is the current output format in use, or the output format currently saved in the output configuration, the "**Output Format In Use**" message will be shown. Press **ESC** to continue.

4. Operation

Using the Expert Mode Menu

~ If the selected format is the current **input format** in use, or the **input format** currently saved in an input configuration, the “**Input Format In Use**” message will be shown. Press **ESC** to continue.

- **H Total** — enables you to adjust (in pixels) the total pixel count per line.

Note

For this function and the following **H** and **V** functions, the possible range for any one is determined in part by the values of the others. Changing one value will not change any other values, but it will limit the range available for other values.

$$\text{Total} = \text{Front Porch} + \text{Sync Width} + \text{Back Porch} + \text{Active}$$

- **H Active** — adjusts (in pixels) the size of the active area.
- **H Front Porch** — adjusts (in pixels) the width of the horizontal front porch.
- **H Sync** — adjusts (in pixels) the width of the sync pulse.
- **H Rate (KHz)** — indicates the horizontal rate in KHz, as computed from the other parameters.
- **V Total** — adjusts (in lines) the total line count per frame.
- **V Active** — adjusts (in lines) the size of the active area.
- **V Front Porch** — adjusts (in lines) the number of lines that comprise the vertical front porch.
- **V Sync** — adjusts (in lines) the number of lines that comprise the vertical sync pulse.
- **V Rate (Hz)** — sets the vertical sync rate of the format in Hz.
- **Interlaced** — allows you enable or disable interlacing. When enabled, the **V Total** value will be forced to an odd number.

Please note the following important point regarding custom formats:

- If you change any parameter within the **Custom Input Formats Menu**, but you do not save the format (using the **Save As** function), the “**Save Custom Format**” message will be shown when you attempt to exit the menu:

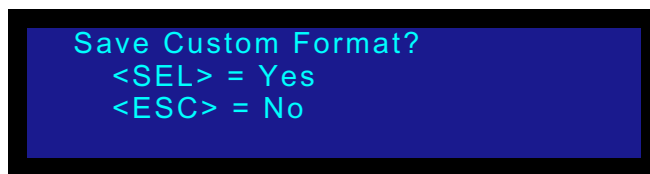

Figure 4-58. Save Custom Format Message

- ~ Press **SEL** to save the changes. The **Save Format As Menu** will be shown.
- ~ Press **ESC** to continue operations without saving changes.

4. Operation

Using the Expert Mode Menu

Aspect Ratio

From the **Input Setup Menu**, select **Aspect Ratio** to display the **Input Aspect Ratio Menu**. This menu enables you to set the input source's aspect ratio to a predefined or custom ratio. LED-PRO selects and displays the source's aspect ratio according to the input format detected.

- ▲ Computer video at 1280x1024@60Hz defaults to 5:4.
- ▲ NTSC video default to 4:3.
- ▲ HDTV1080i video defaults to 16:9.

The figure below illustrates the **Input Aspect Ratio Menu**:



Figure 4-59. Input Aspect Ratio Menu

Following are descriptions of each menu function:

- **Mode** — enables you to select an aspect ratio. Choices are 1:1, 3:2, 4:3, 5:4, 16:9 and Custom.
- **Ratio** — this function is only selectable when **Custom** is selected as the mode. The ratio is a decimal number ranging from **0.750** to **3.000**. The default value depends on the last predefined ratio selected, prior to selecting **Custom**.

Display Mode

From the **Input Setup Menu**, select **Display Mode** to select one of two display modes:

- **Crop** — select this option to map the input (or a portion of the input) to the output with no scaling (1:1). For proper results, the **Input Horizontal and Vertical Actives** (size) must match the **Output Actives**. Then, using the **Vertical and Horizontal Position**, locate the desired portion of the video to be displayed
- **Scale** — select this option to map an entire input video into the LED display. Typically, this means that image will be down-scaled:
 - ▲ 1600x1200 input video mapped into an 800x600 LED display.

Note that **Input Position** adjustments may still be required.

Letterbox

From the **Input Setup Menu**, select **Letterbox** to enable or disable the letterbox function:

- **Off** — the image fills the entire output raster.
- **On** — the top and bottom edges of the raster are cropped to a **16:9** ratio. This feature is especially useful with widescreen DVDs, enabling you to process them without seeing the black bars at the top and bottom of the image.

Processing

From the **Input Setup Menu**, select **Processing** to display the **Processing Menu** which enables you to adjust a variety of image processing parameters.



Figure 4-60. Processing Menu (sample)

Following are descriptions of each menu function:

- **Sync Sel** — this function applies to analog RGB inputs only. The digital input sources have embedded syncs, and the composite, S-video, and YPbPr inputs always will take the sync from the Y (or composite) channel. For these inputs, the value field will indicate n/a.
 - ~ Choices are: **Auto**, **H/V**, **CSync** and **SOG**.
 - ~ In **Auto** mode, the system will find sync in any of the three possible sources. If one of the sources is explicitly chosen, the system uses only that input as a sync source, unless it finds there is no sync input present — in which case it acts as if **Auto** mode is enabled.
- **DeIntlc** — in order to process an interlaced source, LED-PRO must first de-interlace the image. De-interlacing is the process by which interlaced video is converted to progressive format. Please note:
 - ~ **Interlaced video** — even lines are scanned during one field and odd lines are scanned during the next field.
 - ~ **Progressive video** — lines in the frame are sequentially scanned.

LED-PRO utilizes an advanced **Motion Adaptive De-interlacing (MAD)** techniques to de-interlace most video sources up to HDTV (1920 x 1080i) rates. When the MAD de-interlacing mode is selected, maximum video processing delay is 2 input fields (or 3 fields, if the output is not frame-locked to the input).

An alternate mode, Field to Frame (**Fld->Frm**), avoids motion artifacts by converting individual input fields to progressive output frames. While vertical resolution will be reduced in this mode, a significant reduction in video processing delay is achieved.
- **Pulldown Comp** — this function allows you to enable or disable **3:2 Pulldown Detection**. The function should be enabled to process video derived from film source material. Please note:
 - ~ The function only applies to standard video inputs (composite, component, and s-video).
 - ~ The default mode is off.
- **Sync Slice (mV)** — this function enables you to select the sync comparator threshold for RGsB (RGB with Sync on Green) or YPbPr analog component video sources. Please note:
 - ~ The value ranges from 20mV to 280mV, adjustable in steps of 10mV.
 - ~ The default value is 160mV.

4. Operation

Using the Expert Mode Menu

- ~ When LED-PRO detects Macrovision copy protection on the incoming YPbPr NTSC/PAL video, the value is automatically repositioned to 60mV to account for the reduced amplitude sync pulse.

Note

The default **Sync Slice** level has been optimized for virtually all sources that will be encountered and should rarely, if ever, require adjustment. However, the ability to adjust the level is provided to improve sync detection and synchronization in cases of extremely noisy RGB or YPbPr video signals.

Save Config

From the **Input Setup Menu**, select **Save Config** to display the **Save Config As Menu**, which allows you to save and name up to 60 input configurations.

Note

The **Save Config** function (in the **Input Setup Menu**) is *identical* to that found in the **Input Position Menu**. Refer to the "[Save Config](#)" section on page 107 for instructions.

Reset Config

From the **Input Setup Menu**, select **Reset Config** to remove all user-entered configuration settings from the *current input*.

Note

The **Reset Config** function (in the **Input Setup Menu**) is *identical* to that found in the **Input Position Menu**. Refer to the "[Reset Config](#)" section on page 108 for instructions.

Recall Config

From the **Input Setup Menu**, select **Recall Config** to display the **Recall Config Menu**, which enables you to recall input configurations that were previously saved for the currently selected input format and type.

Note

The **Recall Config** function (in the **Input Setup Menu**) is *identical* to that found in the **Input Position Menu**. Refer to the "[Recall Config](#)" section on page 109 for instructions.

Delete Config

From the **Input Setup Menu**, select **Delete Config** to display the **Delete Config Menu**, which enables you to delete any input configurations that were previously saved.



Figure 4-61. Delete Config Menu (sample)

- To delete an input configuration:
 1. Scroll to the **filename** field (e.g., **File1**) and press **SEL**. The navigation cursor (>) changes to the edit cursor (#), allowing you to browse the file list.
 2. Choose a file by turning the knob, and “accept” it by pressing **SEL**.
 3. Scroll to the **Delete Config** line and press **SEL** to display the **Delete Confirmation Menu**.
 - ~ Press **SEL** to delete the configuration.
 - ~ Press **ESC** to return to the **Delete Config Menu**, enabling you to select a different file, or return safely to the **Input Setup Menu** (via **ESC**).

Note

If the deleted input configuration is currently used by any input channel, the system restores the format parameters to the default library values for those channels.

Unsaved Changes

If you change any parameter within the **Input Setup Menu**, but you do not save the input configuration (using the **Save Config** function), the “**Save Input Configuration**” message will be shown when you attempt to exit the menu:

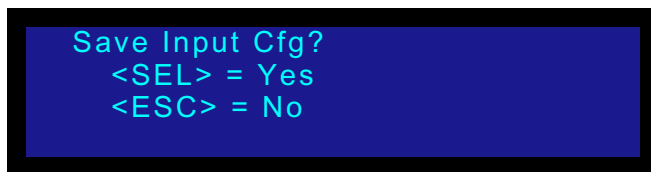

Figure 4-62. Save Input Configuration Message

- ~ Press **SEL** to save the changes. The **Save Configuration As Menu** will be shown. Refer to the “[Save Config](#)” section on page 107 for instructions.
- ~ Press **ESC** to continue operations without saving changes.

4. Operation

Using the Expert Mode Menu

Output

From the **Expert Mode Menu**, select **Output** to display the **LED Output Menu** which enables you to configure the LED-PRO output.

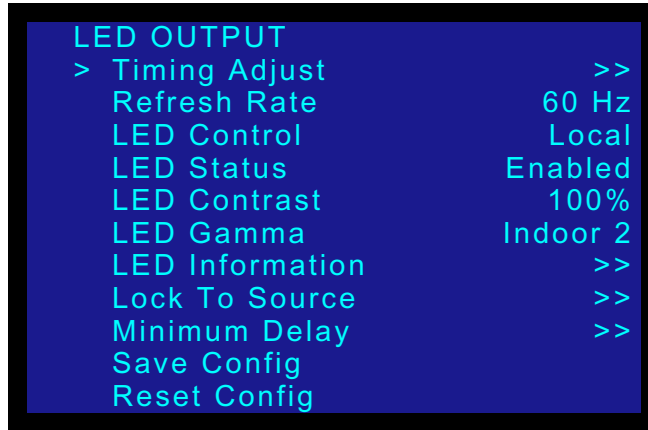

Figure 4-63. LED Output Menu

Following are descriptions of each menu function:

- [Timing Adjust](#)
- [Refresh Rate](#)
- [LED Control](#)
- [LED Status](#)
- [LED Contrast](#)
- [LED Gamma](#)
- [LED Information](#)
- [Lock to Source](#)
- [Minimum Delay](#)
- [Save Config](#)
- [Reset Config](#)

Timing Adjust

From the **LED Output Menu**, select **Timing Adjust** to display the **Output Timing Adjust Menu**, which enables you to make adjustments to the currently selected output format's timing parameters. A sample menu is shown below.



TIMING ADJUST	
> H Total	840
H Position	38
H Size	800
H Sync	10
V Total	636
V Position	28
V Size	600
V Sync	10

Figure 4-64. Output Timing Adjust Menu (sample)

Following are descriptions of each menu function:

- **H Total** — adjusts (in pixels) the total pixel count per line — for the selected output.
- **H Position** — adjusts (in pixels) the offset of the start of active area from H sync.
- **H Size** — adjusts (in pixels) the size of the active area.
- **H Sync** — adjusts (in pixels) the H sync width.
- **V Total** — adjusts (in lines) the total line count per frame.
- **V Position** — adjusts (in lines) the offset of the start of active area from V sync.
- **V Size** — adjusts (in lines) the size of the active area.
- **V Sync** — adjusts (in lines) the V sync width.

Note

When the output format is NTSC or PAL, H Total and V Total cannot be changed.

Refresh Rate

From the **LED Output Menu**, scroll to the **Refresh Rate** function and press **SEL** to adjust the output's refresh rate. If the LED tile type is known, this function also sets the refresh rate for the wall.

- Values are 60 Hz or 50 Hz.

Important

The 60 Hz setting is actually 59.94 Hz. This setting is intended for use with NTSC and PC inputs.

4. Operation

Using the Expert Mode Menu

LED Control

From the **LED Output Menu**, select **LED Control** to choose whether the Barco LED wall is controlled by LED-PRO or by an external application such as **Director Toolset**.

- When set to **Remote**, the Director Toolset GUI has full control of the RS-232 port and can communicate with LED-PRO and the LED Wall.
- When set to **Local**, LED-PRO is communicating with the LED wall, and any commands from the GUI are ignored.

Note

In local mode, LED-PRO is capable of setting up and configuring an LED wall. However, custom gamma values and wall calibration must be performed with Director Toolset.

LED Status

From the **LED Output Menu**, select **LED Status** to change the connected Barco LED Wall (and/or Fiberlink) from “Standby” to “Enabled” mode.

- Selecting **Standby** powers down the LED wall.
- Selecting **Enabled** powers up the LED wall.

Note

When **Standby** mode is enabled, the connected Barco LED wall will be non-responsive — and changes (or updates) cannot be performed.

LED Contrast

From the **LED Output Menu**, select **LED Contrast** to adjust the overall contrast of the LED wall. Please note:

- The selected value is not updated until **SEL** is pressed.
- This command is only applicable when **LED Control** is set to **Local**.

LED Gamma

From the **LED Output Menu**, select **LED Gamma** to specify the Gamma curve associated with the current output. There are several types of gamma curves selectable: **Indoor1**, **Indoor2**, **Outdoor1**, **Outdoor2** and **Custom** (if present). Please note:

- The selected Gamma is not updated until **SEL** is pressed.
- This command is only applicable when **LED Control** is set to **Local**.

LED Information

From the **LED Output Menu**, select **LED Information** to display the **LED Information Menu** which displays data about the LED wall and fiber communications (if utilized).

Note

The **LED Information Menu** (in the **LED Output Menu**) is *identical* to that found in the **LED Menu**. Refer to the “[LED Information](#)” section on page 101 for instructions.

Lock to Source

From the **LED Output Menu**, select **Lock to Source** to display the **Lock To Source Menu**, which enables you to set “lock to source” parameters:



Figure 4-65. Lock to Source Menu

In order to eliminate video processing delay associated with frame rate conversion, it is recommended that you lock the LED-PRO to the input source frame rate, using this function. Following are descriptions of each menu function:

- **Mode** — enables or disables the **Lock to Source** mode.

Important

When **Lock to Source** is enabled, LED-PRO does not allow you to switch input channels. You can only switch to/from the current input channel and the Black/Logo channel.

- **Type** — selects the **Lock to Source** type. The choices depend on the selected mode. If the mode is disabled, the type is **n/a**. The available types are:
 - ~ **V Lock** — vertical lock only. This mode is always available for all input and output resolutions.
 - ~ **HV Lock** — both horizontal and vertical lock. This mode is available only if the input and output V Totals are the same.
- **H Phase** — allows the output H timing to be adjusted relative to the **Lock to Source** mode. Please note:
 - ~ This selection is **n/a** when the type is set to **V lock**.
 - ~ The range is +/- one-half the **H Total**.

Minimum Delay

From the **LED Output Menu**, select **Minimum Delay** to display the **Minimum Delay Menu**, which enables you to minimize delay through the system if desired.



Figure 4-66. Minimum Delay Menu (sample)

Please note the following important points:

- **Disable** the “minimum delay” mode when LED-PRO is performing scaling and deinterlacing — in order to convert a video format.

4. Operation

Using the Expert Mode Menu

- **Enable** the “minimum delay” mode when an another image processor (such as an Encore or ScreenPRO-II) is used to process the video and create multiple windows. The external processor then feeds LED-PRO in a progressive 800x600 format. In this case, LED-PRO does not need to scale the image, and operates in a “minimum delay” mode so as not to introduce additional delay into the system.

For the “minimum delay” function to work properly:

- **V Lock** or **HV Lock** must be enabled on the **Lock to Source Menu**.
- **V Size** on your input must match **V Size** on the output.

Note

If either of the two prerequisites are not met, an error message will be shown.

On the **Mode** line, enable or disable Minimum Delay.

- When **Off**, status is **n/a**, and the delay through the system is no greater that 1.5 frames.
- When **On**, delay through the system is a maximum 20 lines, and status reads “**Active.**”

Save Config

From the **LED Output Menu**, select **Save Config** to save all current output configuration settings in non-volatile memory. The message “**Saving Configuration**” is shown. Note that there is only *one* output configuration file.

Once saved, the output values are retained across power cycles. If you do not save the parameters, the information will not be restored upon the next system power up.

Please note the following important point regarding the **LED Output Menu**:

- If you change any parameter in the **LED Output Menu**, but you do not save the changes (using the **Save Config** function), the “**Save Output Configuration**” message will be shown when you attempt to exit the menu:

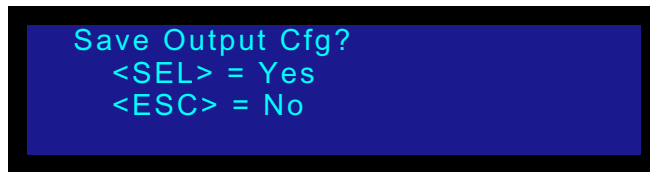

Figure 4-67. Save Output Configuration Message

- ~ Press **SEL** to save the changes.
- ~ Press **ESC** to continue operations without saving changes.

Reset Config

From the **LED Output Menu**, select **Reset Config** to remove all user-entered configuration settings, and restore the default values for the current output format. The message “**Resetting Configuration**” is shown.

Note that this command also clears the saved configuration (if any), so that the system will not restore the unwanted configuration at power up.

Effects

From the **Expert Mode Menu**, select **Effects** to display the **Effects Menu** which enables you to select the transition effect that is used when switching between input channels.



Figure 4-68. Effects Menu (sample)

Following are descriptions of each menu function:

- [Trans With](#)
- [Trans Time](#)

Trans With

Scroll to the **Trans With** function and press **SEL** to change the desired transition type. Use the knob to select, and press **SEL** to accept. Choices are:

- **Img Cut** — the currently selected channel freezes, the new channel's video is acquired and cut to the output.
- **Blk Fade** — the currently selected channel fades to black, then the new channel's video transitions in. The transition rate is determined by the **Trans Time** value.
- **Logo** — this mode is only selectable if there is stored LOGO image in non-volatile memory. The currently selected channel dissolves to the stored LOGO, then the new channel's video dissolves in. The rate is determined by the **Trans Time**.

Trans Time

Scroll to the **Trans Time** function and press **SEL** to change the transition time (or rate), from **1.0** to **5.0** seconds. Use the knob to change the rate, then press **SEL** to accept.

Note

Transition times function best when the auto-acquire mode is turned off. When auto-acquire is enable, transition times will be greater — due to the additional time required to analyze the input video timing. Refer to the "[In Auto Acquire](#)" section on page 87 for details.

4. Operation

Using the Expert Mode Menu

Logo

From the **Expert Mode Menu**, select **Effects** to display the **Logo Menu**, which enables you to save and delete a LOGO. LED-PRO stores one logo in non-volatile memory.



Figure 4-69. Logo Menu

Following are descriptions of each menu function:

- [Capture Logo](#)
- [Delete Logo](#)
- [Logo Present](#)

Capture Logo

Scroll to the **Capture Logo** function and press **SEL** to save the current “active” image as the LOGO.

Tip

Use the **Freeze** function to capture a frame of video, then use the **Capture Logo** function to save it. Refer to the [“Freeze”](#) section on page 87 for details.

Note that you can also capture a LOGO by pressing and hold the desired input button, then pressing the **LOGO** button. In Chapter 2, refer to the [“About the LOGO”](#) section on page 14 for more information.

Delete Logo

Scroll to the **Delete Logo** function and press **SEL** to delete the current LOGO from memory. The front panel **LOGO** button will then display **Internal Black** when pressed.

Logo Present

The **Logo Present** line indicates current LOGO status:

- **Yes** — an image is present in Logo memory.
- **No** — a logo is not present in memory. Internal black will be displayed.

Note

The **Capture Logo** and **Delete Logo** functions are not available (n/a) if the **LOGO** button is currently selected.

In Auto Acquire

From the **Expert Mode Menu**, scroll to the **In Auto Acquire** function to enable or disable the automatic input acquisition (auto-acquire) function. Press **SEL**, use the knob to select the desired mode, then press **SEL** to accept.

- **On** — in this (default) mode, the system always performs a full sync acquisition on the input signal in the following conditions:
 - ~ Any time the input channel is selected.
 - ~ Any time the input type is changed.
 - ~ Any time the input signal changes sync rates.
- **Off** — in this mode, the system uses the last known configuration for each input channel, to the greatest extent possible. Please note:
 - ~ At some point, the input signal may be too far away from the saved configuration, in which case a good input lock may not be possible.
 - ~ If the input signal is too different from the saved configuration to be usable, then the **<in_format>** field in the **Status Display** will read **"Invalid Signal."**

Please note the following important points regarding the **In Auto Acquire** mode:

- It is recommended that the **In Auto Acquire** mode remain **on** for most users. In this mode, LED-PRO automatically detects and acquires the input video type and resolution in most cases — and limits menu selections as applicable to the detected type.
- Advanced users that already know a source's video timing parameters may choose to turn **In Auto Acquire** off — and select the timing manually.
- The **In Auto Acquire** mode should be turned off when using transitions, especially when you have already configured and saved the unit's input setup.
 - ~ Turning auto-acquire **off** provides the fastest transition times for switching between inputs.
 - ~ When auto-acquire is **on**, transition times will be greater due to the additional time required to analyze the input video timing.

Refer to the "[Trans With](#)" section on page 85 for details about transitions.

Freeze

From the **Expert Mode Menu**, scroll to the **Freeze** function to enable or disable the freeze mode. Press **SEL**, use the knob to select the desired mode, then press **SEL** to accept. The mode is not updated until **SEL** is pressed.

- **Off** — in this (default) mode, the image is not frozen
- **On** — select to freeze the input source.
 - ~ When enabled, the **PAN & ZOOM** and **INPUT POS** buttons are not operational.
 - ~ When enabled, the **Input Setup** and **View** menus are inaccessible, because since these adjustments cannot be applied to a frozen image.

Note

If another input is selected, the **Freeze** mode is automatically turned off.

4. Operation

Using the Expert Mode Menu

System

From the **Expert Mode Menu**, select **System** to display the **System Menu**, which enables you to adjust a variety of system parameters, such as the display brightness, Ethernet and Diagnostic RS-232 settings, and panel lock.



Figure 4-70. System Menu (sample)

Following are descriptions of each menu function:

- [VFD Brightness](#)
- [Diagnostic RS232](#)
- [Ethernet](#)
- [EDID DVI In Frmt](#)
- [Lock Front Panel](#)
- [Save System State](#)
- [Unsaved Changes](#)

VFD Brightness

On the **System Menu**, scroll to the **VFD Brightness** function and press **SEL** to adjust the intensity of the front panel vacuum fluorescent display (VFD). The adjustment range is -7 (dimmiest) to 8 (brightest). The factory default setting is 2.

Tip

Whenever possible, use a low intensity setting to avoid "burn-in" of the display.

Diagnostic RS232

On the **System Menu**, select the **Diagnostic RS232** function to display the **Diagnostic RS232 Menu**, which enables you to set **Diagnostic Port** parameters.



Figure 4-71. Diagnostic RS232 Menu (sample)

4. Operation

Using the Expert Mode Menu

Following are descriptions of all menu functions:

- **Baud** — selects the baud rate. Values are: 1200, 2400, 9600, 19200, 38400.
- **Parameters** — select from the following values: N81, E71, O71, E72, O72.
- **Handshaking** — select from the following values: Off or On (CTS/RTS).
- **Reset** — enables you to restore the RS-232 settings to defaults: 38400, N81, Handshake On.

Please note the following important points regarding diagnostic communications:

- After connecting your PC's **COM** port to LED-PRO's **Diagnostic Port**, you may open a serial terminal session (using HyperTerminal, Procomm, etc.), and configure the PC to match LED-PRO's serial port settings as configured in the **Diagnostic RS-232 Menu**.
- At this point, the LED-PRO command prompt (#) will be displayed at the terminal.
- Type "**Help**" to see a list of remote commands supported. In Appendix B, refer to the "[LED-PRO Remote Commands](#)" section on page 128 for a complete list of commands and descriptions.

Ethernet

On the **System Menu**, select the **Ethernet** function to display the **Ethernet Menu**, which enables you to set **Ethernet** parameters.



```
ETHERNET
> Mode                               Off
  DHCP                               Off
  Set Static IP                       >>
  IP      192.168.000.200
  M      00:20:4A:84:9A:EE
```

Figure 4-72. Ethernet Menu (sample)

Following are descriptions of all menu functions:

- **Mode** — enables or disables Ethernet communications by turning the LED-PRO's Ethernet port on or off.
- **DHCP** — turns DHCP on or off.
 - ~ When **on**, LED-PRO queries the DHCP server for a valid IP address. If the LED-PRO finds a DHCP server and receives an IP address, the IP address is shown. If a server is not found, the unit does not get an IP address allotted to it.
 - ~ When **off**, you can manually enter a static IP address (with valid subnet mask and gateway) for Ethernet communication to properly function. Consult with your network administrator for a valid IP address, subnet mask and gateway.

Note

It takes several seconds for the unit to query the Ethernet port and obtain the IP address. During this time the **SEL** button will remain lit.

4. Operation

Using the Expert Mode Menu

- **Set Static IP** — select the **Set Static IP** function to display the **SET IP Menu**. This menu enables you to manually set a subnet mask, gateway, and static IP address when a DHCP server is not available. The menu is only accessible when DHCP is **Off**.

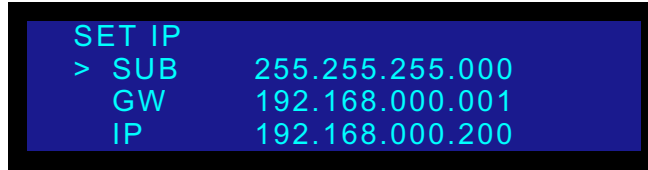

Figure 4-73. Set IP Menu (sample)

Important

Before using this menu, consult with your network administrator to make sure that the assigned IP address is valid, and that the Subnet mask and Gateway are set appropriately. Ensure that you set the subnet mask and gateway *prior to* setting the IP address.

- To set a subnet mask, gateway and IP address:
 - a. Scroll to the **Sub** line, and press **SEL** to begin editing the subnet mask. The first “quad” is highlighted.
 - b. Rotate the knob to select the desired value — from **000** to **255**.
 - c. Press **SEL** to accept, and advance the edit cursor to the next quad.
 - d. Repeat for all remaining quads. When complete, the navigation cursor is restored.

Note

If desired, press **ESC** at any point before pressing **SEL** to cancel all edits and leave the address value unchanged.

- e. Scroll to the **GW** line, and press **SEL** to begin editing the gateway.
- f. Repeat steps **b** through **d** for all remaining quads.
- g. Scroll to the **IP** line, and press **SEL** to begin editing the IP address.
- h. Repeat steps **b** through **d** for all remaining quads.
- i. When complete, press **ESC** to return to the **Ethernet Menu**, and verify that the IP address is correct. At this point, all new static IP values are active.

Please note the following important points:

- ~ Only after setting the IP address will LED-PRO attempt to set the Ethernet port.
- ~ An IP address of **000.000.000.000** indicates that you are not interested in Ethernet communication, and to ignore the Ethernet port.
- ~ It takes several seconds for the unit to communicate with the Ethernet port and set the IP address. During this time, the **SEL** key remains lit.

4. Operation

Using the Expert Mode Menu

- To communicate with LED-PRO via Ethernet:
 - a. Ensure that all Ethernet setup is complete
 - b. On a Microsoft® Windows® PC, open a command prompt window and type the following and press **ENTER**:

```
> telnet xxx.xxx.xxx.xxx 10001
```

... where xxx.xxx.xxx.xxx is the IP address as set, 10001 is the port.
 - c. Once Ethernet communications have been established, the **Telnet** window functions in a similar manner to a serial COM port communication session. If required, consult with your network administrator to ensure that LED-PRO can communicate with the PC.
- **IP** — indicates the current IP address. If an IP address has not been established, if no DHCP server has been found, or if the network cable is not connected, the IP address reads "000.000.000.000."
- **M** — indicates the **MAC** (hardware) address of the Ethernet port.

EDID DVI In Frmt

On the **System Menu**, select the **EDID In Frmat** function to display the **EDID In Format Menu**, which enables you to update LED-PRO's preferred EDID resolution. Refer to the "[Programming EDID](#)" section on page 53 for instructions.

Note

This procedure is identical to the **EDID DVI** procedure located in the **Source Alignment Menu (SETUP > Source Alignment > EDID DVI)**.

Lock Front Panel

On the **System Menu**, scroll to the **Lock Front Panel** function and press **SEL** to lock all front panel controls. This function is designed to prevent tampering with the panel while LED-PRO is under remote control. The **Front Panel Lockout Menu** appears, which alerts the user and display's the system ID:

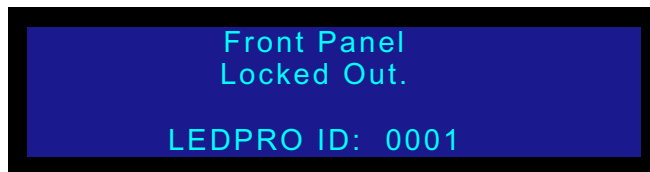

Figure 4-74. Front Panel Lockout Menu (sample)

Note

The system ID is preset at the factory to 1, and can only be changed with the **Director Toolset**. If you use Director Toolset to change the ID, and then perform a factory reset on LED-PRO or run the Setup Wizard, the ID returns to 1.

- To unlock the panel from the front panel:
 1. Press and hold the **SEL** and **ESC** buttons simultaneously, for 3 seconds. When the panel unlocks, the system returns to the **Status Menu**.

4. Operation

Using the Expert Mode Menu

- To unlock the panel via the command line interface:

1. Use the **LOCKOUT** command. In Appendix B, refer to the "[LOCKOUT](#)" section on page 156 for details.

Save System State

On the **System Menu**, scroll to the **Save System State** function and press **SEL** to save all system parameters in non-volatile memory. The message "**Saving System State**" is shown. If you do not save changes, information will not be restored at the next power up.

Note

This function is identical to the **Save System State** function located in the **Setup Menu**.

Unsaved Changes

If you change any parameter within the **System Menu**, but you do not save the changes (using the **Save System State** function), the "**Save System Configuration**" message will be shown when you attempt to exit the menu:

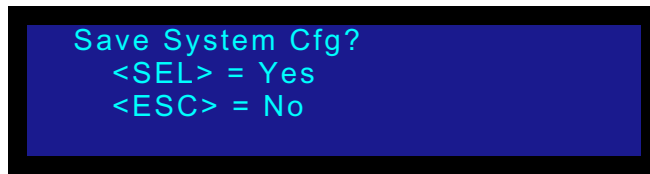

Figure 4-75. Save System Configuration Message

- ~ Press **SEL** to save the changes.
- ~ Press **ESC** to continue operations without saving changes.

Software Version

From the **Expert Mode Menu**, select **Software Version** to display the **Software Version Menu**, which displays the system's installed version of code.



Figure 4-76. Software Version Menu

Factory Reset

From the **Expert Mode Menu**, select **Factory Reset** to display the **Factory Reset Menu**, which enables you to reset LED-PRO to its "factory default" condition. Refer to the "[Factory Reset](#)" section on page 52 for instructions.

Note

This function is identical to the **Factory Reset** function located in the **Setup Menu**.

Using the Test Pattern Menu

The following topics are discussed in this section

- [Test Pattern Menu Tree](#)
- [Test Pattern Menu Description](#)

Test Pattern Menu Tree

Press **TEST PAT** to access the **Test Pattern Menu**. The figure below illustrates the complete menu tree — there are no sub-menus.

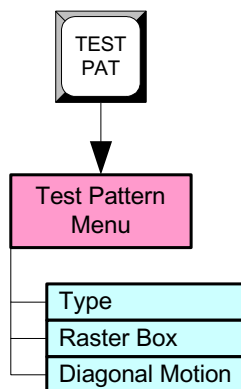

Figure 4-77. Test Pattern Menu Tree

Test Pattern Menu Description

The **Test Pattern Menu** allows you to control test patterns, the raster box and diagonal motion. A sample menu is shown below.

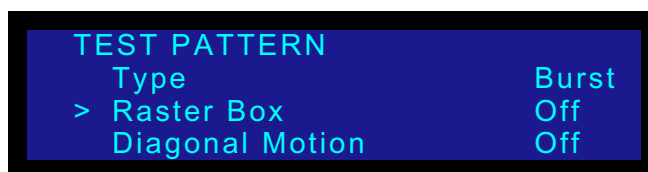

Figure 4-78. Test Pattern Menu (sample)

Following are descriptions of each menu function:

- [Type](#)
- [Raster Box](#)
- [Diagonal Motion](#)

4. Operation

Using the Test Pattern Menu

Type

On the **Test Pattern Menu**, select the **Type** field to enable or disable a test pattern. Choices are:

- Off
- H Ramp
- V Ramp
- 100% Col Bars
- 75% Col bars
- 16x16 Grid
- 32x32 Grid
- Burst
- 50% Gray
- Gray Steps 1
- Gray Steps 2
- White
- Black

Note

Once you enable a test pattern and exit the **Test Pattern Menu**, the **TEST PAT** button remains lit to indicate that a pattern is active. In this mode, regardless of the selected input, only the test pattern will be visible.

Raster Box

On the **Test Pattern Menu**, select the **Raster Box** field to enable or disable the system's raster box. The raster box is a one-pixel border that is placed around the active output area. With the box enabled, you can precisely align the input video to fill the selected output raster video. The border is shown as a dashed line intentionally, allowing you to view the input video behind it and easily align the input video.

Note

The raster box can be enabled or disabled, independent of the test pattern.

Diagonal Motion

On the **Test Pattern Menu**, select the **Diagonal Motion** field to enable or disable diagonal motion. When enabled, the selected test pattern (or raster box) moves from the bottom right to the upper left, allowing you to check that video is live to the LED wall — and not simply frozen.

Using the Pan & Zoom Menu

The following topics are discussed in this section

- [Pan & Zoom Menu Tree](#)
- [Pan & Zoom Menu Description](#)

Pan & Zoom Menu Tree

Press **PAN & ZOOM** to access the **Pan & Zoom Menu**. The figure below illustrates the complete menu tree — there are no sub-menus.

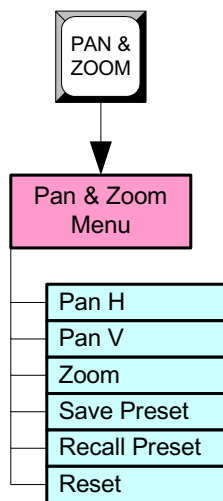

Figure 4-79. Pan & Zoom Menu Tree

4. Operation

Using the Pan & Zoom Menu

Pan & Zoom Menu Description

The **Pan & Zoom Menu** allows you to pan, tilt and zoom a selected input, and save the results in a local “Preset” — an internal file held in non-volatile memory for the specific input only. For example, you can define a preset that maps the entire input image to the upper left quarter of the output image. Please note:

- Independent pan and zoom values are maintained for each input.
- While the menu is active, you can change inputs by selecting buttons in the front panel’s **Inputs Section**. After the system transitions to the new input, all Pan and Zoom values on the menu update.
- This is the only location within the menu tree where inputs can be panned and zoomed.

A sample menu is shown below.



Figure 4-80. Pan & Zoom Menu (sample)

Following are descriptions of each menu function:

- [Pan H](#)
- [Pan V](#)
- [Zoom](#)
- [Save Preset](#)
- [Recall Preset](#)
- [Reset](#)

Pan H

On the **Pan & Zoom** menu, select **Pan H** to pan the selected input horizontally.

- Values range from -100.0% to +100.0%.
- 0% means that the center of the input image coincides with the center of the output image.
- An positive value moves the image to the right.
- The screen updates when **SEL** is pressed.

Pan V

On the **Pan & Zoom** menu, select **Pan V** to pan (tilt) the selected input vertically.

- Values range from -100.0% to +100.0%.

4. Operation

Using the Pan & Zoom Menu

- 0% means that the center of the input image coincides with the center of the output image.
- A positive value moves the image downward.
- The screen updates when **SEL** is pressed.

Zoom

On the **Pan & Zoom** menu, select **Zoom** to zoom the selected input in and out.

- The default value is 100%.
- Values range from 7.1% to 1024.0%.
- Values above 100% increase image size (zoom in). Values below 100% decrease size (zoom out).

Save Preset

On the **Pan & Zoom** menu, select **Save Preset** to save the selected input's current pan and zoom settings in memory. A brief message is shown on the display, indicating that the preset is being saved. Note that the saved preset will be restored on power up for the corresponding input. The function saves a "local" preset, that is specific to the selected input.

Recall Preset

On the **Pan & Zoom** menu, select **Recall Preset** to restore the saved pan and zoom "local" preset from memory, and apply its settings to the selected input. A brief message is shown on the display, indicating that the preset is being recalled.

Reset

On the **Pan & Zoom** menu, select **Reset** to restore pan and zoom settings to their default values for the selected input. **Pan H** and **Pan V** values will be reset to **0**; the **Zoom** value will be reset to **100**.

4. Operation

Using the LED Menu

Using the LED Menu

The following topics are discussed in this section

- [LED Menu Tree](#)
- [LED Menu Description](#)

LED Menu Tree

Press **LED** to access the **LED Menu**. The figure below illustrates the complete menu tree — including sub-menus.

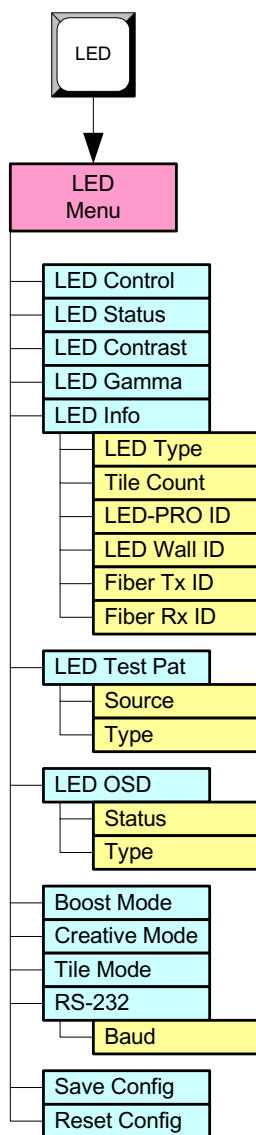

Figure 4-81. LED Menu Tree

LED Menu Description

The **LED Menu** allows you to adjust variety of parameters for the LED wall itself. Many LED parameters are identical to those found in the **Output Setup Menu** within the **Expert Mode Menu** — and placed here for your convenience.

A sample menu is shown below.



Figure 4-82. LED Menu (sample)

Following are descriptions of each menu function:

- [LED Control](#)
- [LED Status](#)
- [LED Contrast](#)
- [LED Gamma](#)
- [LED Information](#)
- [LED Test Pattern](#)
- [LED OSD](#)
- [Boost Mode](#)
- [Creative Mode](#)
- [Tile Mode](#)
- [RS232](#)
- [Save Config](#)
- [Reset Config](#)

4. Operation

Using the LED Menu

LED Control

From the **LED Menu**, select **LED Control** to choose whether the Barco LED wall is controlled by LED-PRO or by an external application such as **Director Toolset**.

- When set to **Remote**, the Director Toolset GUI has full control of the serial port and can communicate with LED-PRO and the LED Wall.
- When set to **Local**, LED-PRO is communicating with the LED wall, and any commands from the GUI are ignored.

Note

LED-PRO, in local mode, is capable of setting up and configuring an LED wall. However, custom gamma values and wall calibration must be performed using Director Toolset.

LED Status

From the **LED Menu**, select **LED Status** to change the connected Barco LED Wall (and/or Fiberlink) from “Standby” to “Enabled” mode.

- Selecting **Standby** powers down the LED wall.
- Selecting **Enabled** powers up the LED wall.

Note

When **Standby** mode is enabled, the connected Barco LED wall will be non-responsive — and changes (or updates) cannot be performed.

LED Contrast

From the **LED Menu**, select **LED Contrast** to adjust the overall contrast of the LED wall. Please note:

- The selected value is not updated until **SEL** is pressed.
- This command is only applicable when **LED Control** is set to **Local**.

LED Gamma

From the **LED Menu**, select **LED Gamma** to specify the Gamma curve associated with the current output. There are several types of gamma curves selectable: **Indoor1**, **Indoor2**, **Outdoor1**, **Outdoor2** and **Custom** (if present). Please note:

- The selected Gamma is not updated until **SEL** is pressed.
- This command is only applicable when **LED Control** is set to **Local**.

LED Information

From the **LED Menu**, select **LED Information** to display the **LED Information Menu**, which displays data about the LED wall and fiber communications (if utilized). All menu items are “read only,” and can not be adjusted.

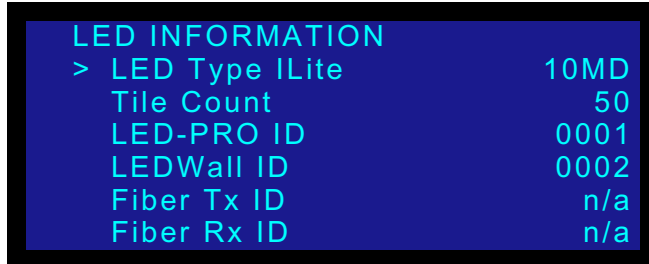

LED INFORMATION	
> LED Type I Lite	10MD
Tile Count	50
LED-PRO ID	0001
LED Wall ID	0002
Fiber Tx ID	n/a
Fiber Rx ID	n/a

Figure 4-83. LED Information Menu (sample)

Following are descriptions of each menu function.

- [LED Type](#)
- [Tile Count](#)
- [LED-PRO ID](#)
- [LED Wall ID](#)
- [Fiber Tx ID](#)
- [Fiber Rx ID](#)

LED Type

The **LED Type** field lists the type of Barco LED wall with which LED-PRO is currently communicating. There are several types of LED walls available, and the product list is updated regularly as new products become available.

Tile Count

The **Tile Count** field lists the number of tiles detected.

LED-PRO ID

The **LED-PRO ID** field lists the ID number of the LED-PRO, as assigned by the Director Toolset. This value is almost always set to 1.

Note

The system ID is preset at the factory to 1, and can only be changed with the **Director Toolset**. If you use Director Toolset to change the ID, and then perform a factory reset on LED-PRO or run the Setup Wizard, the ID returns to 1.

LED Wall ID

The **LED Wall ID** field lists the ID number of the first Barco LED tile, as assigned by the Director Toolset.

4. Operation

Using the LED Menu

Fiber Tx ID

The **Fiber Tx** field lists the ID of the **Fiberlink Transmitter**.

Fiber Rx ID

The **Fiber Rx** field lists the ID of the **Fiberlink Receiver**.

LED Test Pattern

From the **LED Menu**, select **LED Test Pattern** to display the **Wall Test Pattern Menu**. This menu allows you to control test patterns that are programmed into the LED tiles themselves.



Figure 4-84. Wall Test Pattern Menu (sample)

Following are descriptions of each menu function.

- [Source](#)
- [Type](#)

Source

The **Source** field enables you to set the LED test pattern mode. If status is **n/a**, ensure that **LED Control** is set to **Local**:

- **Internal** — test patterns are controlled from within the tiles.
- **External** — LED-PRO controls the tiles.

Type

The **Type** field controls the type of LED test pattern, such as “Cycle” and individual full screen colors.

LED OSD

From the **LED Menu**, select **LED OSD** to display the **Wall OSD Menu**, which enables you to control various on-screen LED displays. Note that the available displays vary between Barco LED tiles.



Figure 4-85. Wall OSD Menu (sample)

Following are descriptions of each menu function.

- [Status](#)
- [Type](#)

Status

The **Status** field enables or disables the LED on-screen display.

Type

The **Type** field enables you to select various types of on-screen displays, such as mode, tile number, temperature, etc.

Boost Mode

On the **LED Menu**, the **Boost Mode** field allows you to enable or disable the boost mode. When enabled, the upper end of the contrast range is boosted for a brighter LED display (normally 5000 NIT, but 7000 NIT in boost mode). Please note:

- This mode is specific to OLite 510 tiles, and is not supported by other Barco tiles. Future tiles may support this mode.
- In this mode, running the tiles brighter accelerates the “dimming” of the overall LED capacity over time. Refer to the specific tile documentation for details.

Creative Mode

On the **LED Menu**, the **Creative Mode** field enables certain tiles (such as the OLite 510) to switch between normal and creative modes.

- **Normal** mode is essentially LED operation within a standard rental structure.
- **Creative** mode describes non-standard setups, such as those created with Director Toolset. Refer to the “**Director Toolset User’s Guide**” for additional details on creative mode.

Tile Mode

On the **LED Menu**, the **Tile Mode** field enables you to select between two tile modes.

- In **Real** mode, each pixel output from LED-PRO is mapped directly to each LED tile pixel.
- In **Virtual** tile mode, the LED tile’s resolution is essentially doubled. Each pixel output from LED-PRO is mapped to four virtual 3xLED pixels within each 5xLED pixel grouping.

4. Operation

Using the LED Menu

RS232

From the **LED Menu**, select **RS232** to display the **RS232 Menu**, which enables you to set the RS-232 baud rate for the **Serial** port — not the **Diagnostic** port. The **Serial** port is used for communications with the Director Toolset.



Figure 4-86. RS232 Menu (sample)

- Select the **Baud** field to set the Serial port's baud rate.

Save Config

On the **LED Menu**, select **Save Config** to save all current output configuration settings in non-volatile memory.

Note

This function is identical to the **Save Config** function located in the **Output Setup Menu (SETUP > Expert Mode > Output)**. Refer to the "[Save Config](#)" section on page 84 for instructions.

Reset Config

On the **LED Menu**, select **Reset Config** to remove all user-entered configuration settings, and restore the default values for the current output format.

Note

This function is identical to the **Reset Config** function located in the **Output Setup Menu (SETUP > Expert Mode > Output)**. Refer to the "[Reset Config](#)" section on page 84 for instructions.

Using the Input Position Menu

The following topics are discussed in this section

- [Input Position Menu Tree](#)
- [Input Position Menu Description](#)

Input Position Menu Tree

Press **INPUT POS** to access the **Input Position Menu**. The figure below illustrates the complete menu tree — including sub-menus.

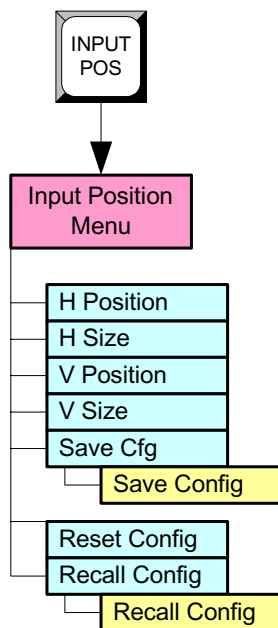

Figure 4-87. Input Position Menu Tree

4. Operation

Using the Input Position Menu

Input Position Menu Description

The **Input Position Menu** allows you to perform an abbreviated set of input setup functions, for operator convenience. For a complete set of input setup functions, use the **Input Setup Menu** in the **Expert Mode (SETUP > Expert Mode > Input)**. Refer to the [“Input”](#) section on page 68 for details.

Please note:

- The menu enables you to set up all inputs, simply by pressing the desired button in the front panel’s **Inputs Section**.
- Unlike the **Input Setup Menu**, the **Input Position Menu** *does not* display the selected input on the top line. Use the physical button itself as the identifier.

A sample menu is shown below.



Figure 4-88. Input Position Menu (sample)

Following are descriptions of each menu function:

- [H Position](#)
- [H Size](#)
- [V Position](#)
- [V Size](#)
- [Save Config](#)
- [Reset Config](#)
- [Recall Config](#)

Note

As a recommendation, turn on the **Output Raster Box** when making active area adjustments. The input should be aligned with all four edges of the raster box. Refer to the [“Raster Box”](#) section on page 94 for details.

H Position

On the **Input Position Menu**, select **H Position** to adjust (in pixels) the start of the input video's active area from H sync.

H Size

On the **Input Position Menu**, select **H Size** to adjust (in pixels) the size of the active area.

V Position

On the **Input Position Menu**, select **V Position** to adjust (in lines) the start of the input video's active area from V sync.

V Size

On the **Input Position Menu**, select **V Size** to adjust (in lines) the size of the active area.

Save Config

From the **Input Position Menu**, select **Save Config** to display the **Save Config As Menu**, which allows you to save and name up to 64 input configurations.



Figure 4-89. Save Config As Menu (sample)

Note

This function is the same as the **Save Config** function located in the **Input Setup Menu (SETUP > Expert Mode > Input)**. It is also located here for operator convenience.

Please note the following important points regarding input configurations:

- When you save input configuration parameters, they are stored in non-volatile memory for each input source. If you do not save the parameters, the information will not be restored upon the next system power up sequence.
 - A filename may include up to 19 characters.
- To save an input configuration:
1. Scroll to the **filename** field (e.g., **File1**) and press **SEL**. The navigation cursor (>) changes to the edit cursor (#), allowing you to edit the first character.
 2. Choose a character by turning the knob, and “accept” it by pressing **SEL**. This action also selects the next character for editing.
 3. Repeat step 2 for all desired characters.
 4. When data entry is complete, press **SEL** again. The filename will be truncated up to the current character position.

4. Operation

Using the Input Position Menu

5. To save the input configuration under the selected filename, scroll to the **Save Config** line and press **SEL**.
 - ~ If the selected filename has never been used, the message "**Config Saved**" appears.
 - ~ If the filename is already in use, the **Overwrite File Menu** appears.

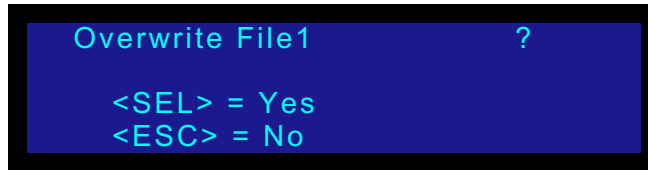

Figure 4-90. Overwrite File Menu (sample)

- Press **SEL** to overwrite the file.
- Press **ESC** to return to the **Save Config As Menu**, enabling you to change the filename.
- ~ If all 64 input configurations have been used, the "**Library Full**" message appears. Press **ESC**, and then navigate to the **Delete Config Menu**, which enables you to clear space for new configurations to be stored. Refer to the "[Delete Config](#)" section on page 79 for details.

Important

If you change a parameter on the **Input Position Menu**, but you do not save the configuration (using the **Save Config** function), the system *does not* prompt you to save. As an important recommendation, always save your changes prior to exiting the menu.

Reset Config

From the **Input Position Menu**, select **Reset Config** to remove all user-entered configuration settings from the *current input*. This action causes the system to restore the parameters from the system's internal "format library" for the current input format. If the current format was derived as a *best guess* during the "auto-acquire" process (as shown with asterisks), then those best guess values are restored.

Note

The **Reset Config** function can be performed prior to a "save" if desired.

Note

This function is the same as the **Reset Config** function located in the **Input Setup Menu (SETUP > Expert Mode > Input)**. It is also located here for operator convenience.

Recall Config

From the **Input Position Menu**, select **Recall Config** to display the **Recall Config Menu**, which enables you to recall input configurations that were previously saved for the currently selected input format and type.



Figure 4-91. Recall Config Menu (sample)

Note

This function is the same as the **Recall Config** function located in the **Input Setup Menu (SETUP > Expert Mode > Input)**. It is also located here for operator convenience.

- To recall an input configuration:
 1. Scroll to the **filename** field (e.g., **File1**) and press **SEL**. The navigation cursor (>) changes to the edit cursor (#), allowing you to browse the file list.
 2. Choose a file by turning the knob, and “accept” it by pressing **SEL**.
 3. Scroll to the **Recall Config** line and press **SEL** to recall the file.

4. Operation

Using the Input Position Menu

5. Upgrading Software

In This Chapter

This chapter provides detailed instructions for upgrading LED-PRO system software. The following topics are discussed:

- [Software Upgrade Overview](#)
- [Hardware Requirements](#)
- [Software Requirements](#)
- [Downloading Software](#)
- [Serial Upgrade Method](#)

5. Upgrading Software

Software Upgrade Overview

Software Upgrade Overview

Firmware files for the LED-PRO system are loaded into the hardware at power-up. These files are stored in the unit's onboard flash memory, which can be upgraded using a serial connection to a PC (or laptop).

The PC connection is made through the **Diagnostics** port on LED-PRO's rear panel, in conjunction with the "Flash Loader" utility supplied with each upgrade. The Flash Loader enables you to update the Flash memory with the latest software revision. The utility should be run from a PC's hard drive (recommended).

Hardware Requirements

The following hardware items are required for upgrading LED-PRO software:

- IBM compatible computer with an available COM port.
- Serial cable conforming to EIA RS-232 specifications (e.g., standard modem cable). The cable should have a DB-9 male connector on one end (for connection to LED-PRO's **Diagnostic** port), and the appropriate connector on the other end for connection to your PC (typically, a DB-9).

Note

One 15 meter RS-232 cable is provided with LED-PRO, with DB-9 connectors at each end. Use this cable if compatible with your PC's **COM** port.

Software Requirements

The following list outlines software requirements for upgrading LED-PRO software:

- Ensure that your PC (or laptop) uses the Windows® 2000 or XP operating systems.
- Software files:
 - ~ Flash File Loader. (This software enables the PC to send serial commands to LED-PRO.)
 - ~ LED-PRO software
 - ~ What's New File

Note

All software files listed above (and more) are contained in the file that you will download.

Software files can be downloaded from either the Folsom FTP site or the Barco Folsom website, as described in the following ["Downloading Software"](#) section.

Downloading Software

Two different methods can be used to download LED-PRO software and the Flash File Loader utility:

- [Via FTP Site](#)
- [Via Web Site](#)

Via FTP Site

Barco Folsom's FTP site address is: **ftp.folsom.com**

■ To download from the FTP site:

1. Create a target folder on your PC (e.g., LED-PRO).
2. If you are using an FTP client, logon to our site as follows:
 - ~ **User name:** anonymous
 - ~ **Password:** your email address

▲ **Example:** johndoe@somecompany.com

If you are using a web browser to access our FTP site, point the browser to:

ftp://ftp.folsom.com

3. Once logged on, navigate to the following directory:
ftp://ftp.folsom.com/Products/Video/LEDPro/
4. Transfer the following file to the target folder on your PC:
LED-PRO_Rev#.#.exe
5. Please continue with the "[Serial Upgrade Method](#)" section on page 114.

Via Web Site

Barco Folsom's web site address is: **http://www.folsom.com**

■ To download from the web site:

1. Create a target folder on your PC (e.g., LED-PRO).
2. On the web, navigate to <http://video.folsom.com>.
3. Click "**Downloads**" to access the **Downloads Page**.
4. Using the "**Select Video Product**" pull-down menu, click LED-PRO.
5. In the "**Software**" section, click the **Download** button for the latest version of system software.
6. When the **File Download Dialog** appears, click **Save** to save the file to your computer.
7. When the **Save As Dialog** appears, navigate to the target folder and click **Save**.
8. Please continue with the "[Serial Upgrade Method](#)" section on page 114.

5. Upgrading Software

Serial Upgrade Method

Serial Upgrade Method

- Use the following steps to upgrade LED-PRO software using a serial connection to your PC:
 1. With the download complete, navigate to the target folder and double-click the **EXE** to launch the installation shield.
 2. Follow the prompts to install the upgrade package in the default folder. At the conclusion of the procedure, a new path will be created under **Start > Programs > Barco Folsom**, and shortcuts will be added.

Note

Do not move or copy any files out of the target folder.

3. Connect the **Diagnostic** port on the back of the LED-PRO to the **COM 1** port on your PC. In Chapter 2, refer to the "[LED-PRO Rear Panel](#)" section on page 15 for the location of the **Diagnostic** port.
4. Power-up the LED-PRO.
5. On the PC, click **Start > Programs > Barco Folsom > LED-PRO Rev #.## > LED-PRO Flash File Loader Rev #.##** to launch the Flash Loader utility, as shown below.

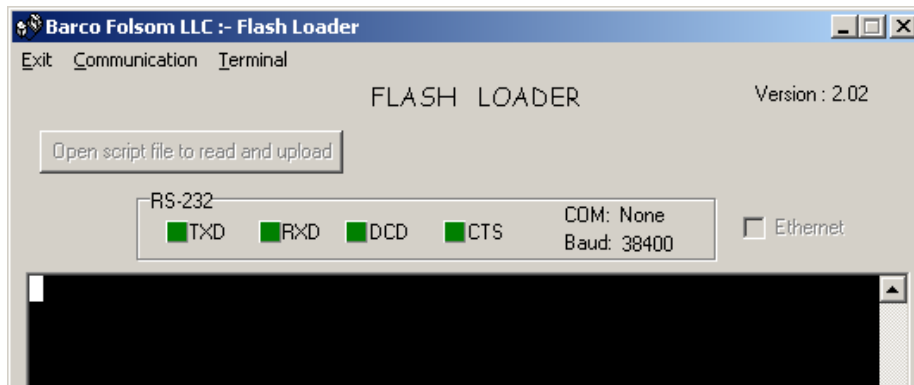

Figure 5-1. Flash Loader Utility

Note

If you have not used the **COM 1** port on your PC, an error message will be shown at the bottom of the Flash Loader.

6. Click **Communication > RS232 Config > Baud**, and select 38400.
7. Click **Communication > RS232 Config > COM Port**, and select the COM port on your PC to which the LED-PRO is connected. If no other programs are using the port, the "**Established communications**" message appears at the bottom of the Flash Loader.
8. To verify communications between the PC and LED-PRO:
 - a. In the loader program, click in the black terminal window area.
 - b. Note the condition of the status lights:
 - **DCD** and **CTS** should be red.

5. Upgrading Software

Serial Upgrade Method

- **TXD** and **RXD** should be green. They will flash if **Enter** is pressed.

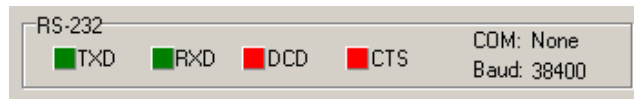

Figure 5-2. Flash Loader Status Lights, Normal Condition

- Press **Enter** a few times to display the system prompt "#" on screen.
 - If the prompt does not appear, continue with step 9 (troubleshooting).
 - If the prompt appears, continue with step 10 (uploading files).
9. To troubleshoot the serial connection:
- If the **DCD** and **CTS** status lights are green, re-check the communication settings in the loader, and verify that the COM port and Baud Rate settings are correct.
 - To verify LED-PRO communication settings, on the front panel of the LED-PRO unit, press **SETUP** to display the **Setup Menu**.
 - On the **Setup Menu**, navigate to the **Diagnostic RS232 Menu** by selecting **Expert Mode > System > Diagnostic RS232**.

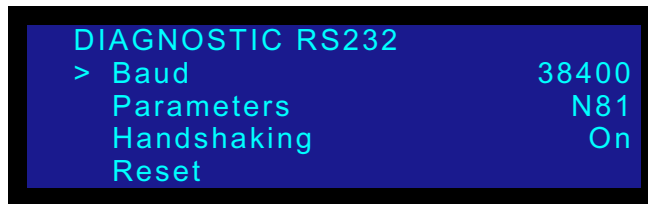

Figure 5-3. Diagnostic RS232 Menu (sample)

- On the menu, ensure that the following settings are selected:
 - **Baud Rate** = 38400
 - **Parameters** = N81
 - **Handshaking** = On
 - Repeat steps 7 and 8 above, then re-check the status lights.
 - With communication status OK, continue with step 10.
10. To upload files to LED-PRO, click "**Open script file to read and upload.**"
11. In the dialog, select "**Upload_All.sld**" and click **Open**. The LED-PRO unit should immediately display the "**System in LOADER MODE**" message.
12. It takes several minutes to load the flash memory. When complete, the Flash Loader utility displays the "**Upload Complete**" message. Click **OK** to continue.
13. Cycle power on the LED-PRO unit, and exit the Flash Loader utility.

5. Upgrading Software

Serial Upgrade Method

14. On LED-PRO, perform a factory reset. Press **SETUP**, select **Factory Reset**, and then confirm. In Chapter 4, refer to the "[Factory Reset](#)" section on page 52 for additional details.

Warning

Use caution when performing this step, as all saved files will be erased.

15. On LED-PRO, verify that the new software has been loaded correctly. Press **SETUP**, then navigate to the **Software Version Menu** by selecting **Expert Mode > Software Version**.



Figure 5-4. Software Version Menu

This completes the software upgrade procedure.

A. Specifications

In This Appendix

This appendix provides detailed technical specifications for the LED-PRO. The following topics are discussed:

- [Input Specifications](#)
- [Output Specifications](#)
- [User Control Specifications](#)
- [Physical and Electrical Specifications](#)
- [Communications Specifications](#)
- [Agency Specifications](#)
- [Pinouts](#)

A. Specifications

Input Specifications

Input Specifications

The table below lists LED-PRO input specifications.

Table A-1. LED-PRO Input Specifications

Parameter	Detail	Specification
Video Input	Universal Inputs	(3) high bandwidth video channels support: <ul style="list-style-type: none"> • RGBHV • RGBS • RGsB computer video • Component video (STD or HDTV) • S-video • Composite video
	Input 1	(1) DVI-I connector, with buffered loop-through. Supports both universal analog and DVI *
	Input 2	(1) 15-pin HD connectors, with buffered loop-through *
	Input 3	(5) BNC connectors, each with buffered loop-through *
	Serial Digital Video Input	(1) BNC connector, SDI/HDSDI
	Input Resolution Range	Resolutions: <ul style="list-style-type: none"> • VGA (640x480) • SVGA (800x600) • XGA (1024x768) • SXGA (1280x1204) • UXGA (1600x1200) HDTV: <ul style="list-style-type: none"> • 480p • 720p • 1080p • 1080i
	Standard Resolution Video Input	NTSC, PAL or SECAM
	Horizontal Frequency	15 kHz to 120 kHz
	Vertical Frequency	20 Hz to 120 Hz
	Input Termination	75 Ohm
	Input Sync	Sync-on-Video, Separate C or H/V
	Genlock Input	V lock / HV lock. System genlocks to selected input

* All buffered loop-through connectors, 75 Ohm output impedance

Output Specifications

The table below lists LED-PRO output specifications.

Table A-2. LED-PRO Output Specifications

Parameter	Detail	Specification
Video Output	Digital Video Output	Proprietary Barco LED wall interface via DVI-I connector
	Output Resolution	SVGA (800x600), 480,000 total pixels @ 32Mhz pixel clock

User Control Specifications

The table below lists LED-PRO user control specifications.

Table A-3. LED-PRO User Control Specifications

Parameter	Detail	Specification
User Control	Local control	User-friendly front panel interface, dedicated menus and buttons
	Setup	Local (manual or via Setup Wizard), or via Director Toolset
	Calibration	Via Director Toolset
	Remote control	Computer or third party control via RS-232 or Ethernet

Physical and Electrical Specifications

The table below lists LED-PRO physical and electrical specifications.

Table A-4. LED-PRO Physical and Electrical Specifications

Parameter	Detail	Specification
Power	Connector	Standard IEC, integral on/off switch
	Power	47-63 Hz, 100-240 VAC
Mechanical	Chassis	H: 3.50 inches (8.89 cm)
		W: 17.00 inches (43.18 cm)
		W: 19.00 inches (48.26 cm) with rackmount wings
		D: 15.00 inches (38.10 cm)
Temperature		0-40 degrees C
Humidity		0-95% non-condensing

A. Specifications

Communications Specifications

Table A-4. LED-PRO Physical and Electrical Specifications (Continued)

Parameter	Detail	Specification
Mounting		2 RU rack mount
Weight		17.5 lbs (7.93 kg)
Shipping Weight		20 lbs (9.07 kg)

Communications Specifications

The table below lists LED-PRO communications specifications.

Table A-5. LED-PRO Communications Specifications

Parameter	Detail	Specification
Communications	RS-232	DB-9 Female, DCE, 115k Baud *
	Ethernet	RJ-45, 10/100 Mbps Autosense

* 115k Baud recommended for LED tile firmware upload only.

* 19.2k Baud recommended for normal operation, such as Director Toolset.

Agency Specifications

The table below lists LED-PRO agency specifications.

Table A-6. LED-PRO Agency Specifications

Parameter	Detail	Specification
Agency Specifications	EMI/EMC	EN55103-1 E4, EN55103-2, FCC Part 15 Subpart B Class A
	Safety	EN 60950 Class 1

Pinouts

The following topics are discussed in this section:

- [Analog 15-pin D Connector](#)
- [DVI-I Connector Pinouts](#)
- [Ethernet Connector](#)
- [Serial and Diagnostic Connector](#)

Analog 15-pin D Connector

The figure below illustrates the analog 15-pin D connector:

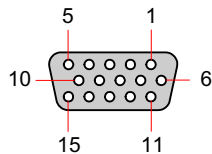

Figure A-1. Analog 15-pin D Connector, chassis view

The table below lists Analog 15-pin D connector pinouts.

Table A-7. Analog 15-pin D Connector Pinouts

Pin	Signal	Pin	Signal
1	Red	9	
2	Green	10	GND
3	Blue	11	
4		12	
5		13	H Sync or C Sync
6	Red return	14	V Sync
7	Green return	15	
8	Blue return		

A. Specifications

Pinouts

DVI-I Connector Pinouts

The figure below illustrates the DVI-I connector:

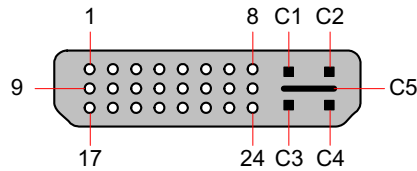

Figure A-2. DVI-I Connector

The table below lists DVI-I Connector pinouts. Please note:

- T.M.D.S = Transition Minimized Differential Signal
- DDC = Display Data Channel

Table A-8. DVI-I Connector Pinouts

Pin	Signal	Pin	Signal
1	T.M.D.S. Data 2-	13	T.M.D.S. Data 3+
2	T.M.D.S. Data 2+	14	+5V Power
3	T.M.D.S. Data 2/4 Shield	15	ground (for +5V)
4	T.M.D.S. Data 4-	16	Hot Plug Detect
5	T.M.D.S. Data 4+	17	T.M.D.S. Data 0-
6	DDC Clock	18	T.M.D.S. Data 0+
7	DDC Data	19	T.M.D.S. Data 0/5 Shield
8	Analog Vertical Sync	20	T.M.D.S. Data 5-
9	T.M.D.S. Data 1-	21	T.M.D.S. Data 5+
10	T.M.D.S. Data 1+	22	T.M.D.S. Clock Shield
11	T.M.D.S. Data 1/3 Shield	23	T.M.D.S. Clock +
12	T.M.D.S. Data 3-	24	T.M.D.S. Clock -
MicroCross Pins			
C1	Analog Red Video	C4	Analog Horizontal Sync
C2	Analog Green Video	C5	Analog Common Ground Return
C3	Analog Blue Video		

Ethernet Connector

The figure below illustrates the Ethernet connector:

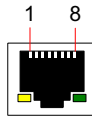

Figure A-3. Ethernet Connector

The table below lists Ethernet connector pinouts.

Table A-9. Ethernet Connector Pinouts

Pin	Signal	Wire Color
1	TX Data +	White / Orange
2	TX Data -	Orange
3	RX Data +	White / Green
4		Blue
5		White / Blue
6	RX Data -	Green
7		White / Brown
8		Brown

A. Specifications

Pinouts

Serial and Diagnostic Connector

The figure below illustrates the Serial and Diagnostic connector:

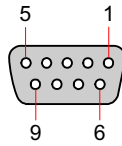

Figure A-4. Serial and Diagnostic Connector

The table below lists Serial and Diagnostic connector pinouts.

Table A-10. Serial and Diagnostic Connector Pinouts

Pin	RS-232 Signal	Description
1	CD	Carrier Detect
2	RXD	Received Data
3	TXD	Transmitted Data
4	DTR	Data Terminal Ready
5	GND	Signal Ground
6	DSR	Data Set Ready
7	RTS	Request To Send
8	CTS	Clear To Send
9	RI	Unused

B. Remote Control Protocol

In This Appendix

This appendix provides information regarding external remote control protocol. The following topics are discussed:

- [Default Serial Parameters](#)
- [Default IP Address](#)
- [RS-232 Mode](#)
- [LED-PRO Remote Commands](#)

B. Remote Control Protocol

Default Serial Parameters

Default Serial Parameters

Default serial communications parameters are provided for the following two ports:

- [Diagnostics Port](#)
- [RS-232 Port](#)

Please note:

- The system returns to these values after a factory reset.
- These settings can be changed using the menu system.
 - ~ In Chapter 4, refer to the "[Diagnostic RS232](#)" section on page 88 for instructions on changing Diagnostic Port settings.
 - ~ In Chapter 4, refer to the "[RS232](#)" section on page 51 for instructions on changing the RS-232 port settings.

Diagnostics Port

Following are the default serial communications settings for the Diagnostics port, which is used for diagnostics, software upgrades and serial commands (e.g., via HyperTerminal).

- **Baud Rate** = 38.4K baud
- **Parity** = NONE
- **Stop Bit** = 1
- **Data Bit** = 8
- **Echo** = ON
- **Flow Control** = NONE

RS-232 Port

Following are the default serial communications settings for the RS-232 port, which is used to communicate with the Director Toolset.

- **Baud Rate** = 19.2K baud
- **Parity** = NONE
- **Stop Bit** = 1
- **Data Bit** = 8
- **Echo** = ON
- **Flow Control** = NONE

Default IP Address

The LED-PRO default IP address is **192.168.000.200**.

Please note:

- The system returns to this value after a factory reset.
- This default address can be changed using the menu system. In Chapter 4, refer to the [“Ethernet”](#) section on page 89 for instructions.

RS-232 Mode

The LED-PRO will respond with a “#” prompt when the command processor is ready for a command. The command syntax is shown below

```
cmd arg1 arg2 ... argn<CR>
```

Table B-1. RS-232 Command Syntax

Command	Description
cmd	Any valid graphics board command, typically 2 to 6 alphabetic (non numeric) characters
arg	argument1, argument2, ... argument"N" are required or optional parameters depending on the command used.
<CR>	carriage return (ASCII 13) terminates the command

Please note:

- A space (ASCII 32) must be inserted between the command and any arguments that follow. A space must also be inserted between all argument parameters, except for the last argument in the chain.
- All commands in RS-232 mode must be terminated with a carriage return (ASCII 13). The carriage return will tell the command processor to begin execution of the command.
- Query commands will return the following:

```
=result
#
```

The “=” indicates that a result from a query command is following. The “result” will follow directly after the “=”. The value of the result will vary depending on the query command used. A new line will be generated and the prompt (#) will indicate the system is ready for a new command.

B. Remote Control Protocol

LED-PRO Remote Commands

LED-PRO Remote Commands

The tables below list LED-PRO remote commands. Click the hyperlink for detailed descriptions and examples, or go directly to the page as listed. All remote commands are sorted by category.

- [Resolution Remote Commands](#)
- [Input Remote Commands](#)
- [Output Remote Commands](#)
- [Custom Format Remote Commands](#)
- [System and Ethernet Remote Commands](#)
- [Logo Remote Commands](#)
- [Effects Related Commands](#)
- [LED-PRO Serial Command Descriptions](#)

Resolution Remote Commands

The table below lists LED-PRO resolution remote commands.

Table B-2. LED-PRO Resolution Remote Commands

Command	Description	Page
RESH	Query list of available Resolutions	135
RESI nn	Set current Input Resolution	135
RESI? in	Query Input Resolution	135

Input Remote Commands

The table below lists LED-PRO input remote commands.

Table B-3. LED-PRO Input Remote Commands

Command	Description	Page
ACQ mode	Disable/Enable Auto acquisition mode	135
ACQ?	Query Auto acquisition mode	135
DINT in mode	Sets De-interlacer mode	135
DINT? in	Query De-interlacer mode	135
PCOMP in mode	Set Pulldown Compensation mode	136
PCOMP? in	Query Pulldown Compensation mode	136
FREEZ mode	Enables/disables freeze	136
FREEZ?	Query freeze mode	136

B. Remote Control Protocol

LED-PRO Remote Commands

Table B-3. LED-PRO Input Remote Commands (Continued)

Command	Description	Page
IAR in n cn	Adjust Input Aspect Ratio	136
IAR? in	Query Input Aspect Ratio	136
IAUTO	Automatically Configure the Input	137
IBRT in nnn.n	Set Input Brightness	137
IBRT? in	Query Input Brightness	137
ICNT in nnn.n	Set Input Contrast	137
ICNT? in	Query Input Contrast	137
ICPHO in nn	Set Input Sample Phase	137
ICPHO? in	Query Input Sample Phase	138
ICLIST	List all saved Input Configurations	138
ICDEL filename	Delete saved Input Configuration	138
ICREC in filename	Recall saved Input Configuration	138
ICRST in	Reset Input Configuration	138
ICSAV in filename	Saves Input Configuration	138
ICSP in mode	Set Input Colorspace	139
ICSP? in	Query Input Colorspace	139
ICUSE in	Query Input Configuration Name used for a channel	139
IEDGE in edge nnnn	Adjust top/bottom/left or right edge in Oversample mode	139
IEDGE? in edge	Query Input Video edge adjustment	139
IGM in n	Sets Input Gamma	139
IGM? in	Query Input Gamma for a channel	140
IHATV nnnn	Set Input Horiz Active	140
IHATV? in	Query Input Horiz Active	140
IHPOS nnnn	Set Input Horiz Position	140
IHPOS? in	Query Input Horiz Position	140
IHTOTAL nnnn	Set Input Horiz Total	140
IHTOTAL? in	Query Input Horiz Total	141
IHUE in nnn	Adjust Input Hue	141
IHUE? in	Query Input Hue	141
ILB in mode	Set LetterBox mode	141
ILB? in	Query LetterBox mode	141
IRBRT in c nn.n	Set RGB Input Brightness	141
IRBRT? in c	Query RGB Input Brightness	142

B. Remote Control Protocol

LED-PRO Remote Commands

Table B-3. LED-PRO Input Remote Commands (Continued)

Command	Description	Page
IRCNT in c nnn.n	Set RGB Input Contrast	142
IRCNT? in c	Query RGB Input Contrast	142
ISAT in nnn	Adjust Input Saturation	142
ISAT? in	Query Input Saturation	142
ISMP in n	Adjust Input Sample mode	142
ISMP? in	Query Input Sample mode	143
ISYNC in mode	Set Input Sync	143
ISYNC? in	Query Input Sync	143
ISYNCSLICE in nnn	Set Input Sync Slice Threshold	143
ISYNCSLICE? in	Query Input Sync Slice Threshold	143
ITYPE in mode	Set Input Type	143
ITYPE? in	Query Input Type	144
IVATV nnnn	Set Input Vert Active	144
IVATV?	Query Input Vert Active	144
IVPOS nnnn	Set Input Vert Position	144
IVPOS?	Query Input Vert Position	144
IVTOTAL?	Query Input Vert Total	144
IVREC in	Input Channel View Recall	144
IVSAV in	Input Channel View Save	145
LCK? in	Query Lock status	145
RTE in	Routes Input source	145
RTE?	Query currently routed Input source	145
ICLIP	Input clip to black	145
ILUMA	Input Luma Tracking	145
ISHRP	Input sharpness	145

Output Remote Commands

The table below lists LED-PRO output remote commands.

Table B-4. LED-PRO Output Remote Commands

Command	Description	Page
LCKMODE mode type	Set Lock To Source Mode and Type	145
LCKMODE?	Query Lock To Source Mode and Type	146
LCKPHASE h	Sets Lock To Source Horizontal Phase	146
OCNT nnn	Adjust Output Contrast	146
OCNT?	Query Output Contrast	146
OCRST	Reset Output Configuration	146
OCSAV	Save Output Configuration	146
OGM mode	Set Output Gamma	147
OGM?	Query Output Gamma	147
OHATV nnnn	Set Output Horiz Active	147
OHATV?	Query Output Horiz Active	147
OHPOS nnnn	Set Output Horiz Position	147
OHPOS?	Query Output Horiz Position	147
OHSYNC nnnn	Set Output Horiz Sync	147
OHSYNC?	Query Output Horiz Sync	148
OHTOTAL nnnn	Set Output Horiz Total	148
OHTOTAL?	Query Output Horiz Total	148
OTPM type raster	Enables/disables Output test pattern and raster box	148
OTPM?	Query Output test pattern and raster box mode	148
OVATV nnnn	Set Output Vert Active	148
OVATV?	Query Output Vert Active	149
OVPOS nnnn	Set Output Vert Position	149
OVPOS?	Query Output Vert Position	149
OVSYNC nnnn	Set Output Vert Sync	149
OVSYNC?	Query Output Vert Sync	149
OVTOTAL nnnn	Set Output Vert Total	149
OVTOTAL?	Query Output Vert Total	149

B. Remote Control Protocol

LED-PRO Remote Commands

Custom Format Remote Commands

The table below lists LED-PRO custom format remote commands.

Table B-5. LED-PRO Custom Format Remote Commands

Command	Description	Page
EFLIST	List all saved custom formats	150
EFRES nn	Set base resolution for custom format settings	150
EFRES?	Query base resolution for custom format settings	150
EFRESH	Query list of available Resolutions for custom format	150
EFINT mode	Set custom format to be non-interlaced or interlaced	150
EFINT?	Query the interlace mode for the custom format	150
EFHTOTAL nnnn	Set Horiz Total for custom format	150
EFHTOTAL?	Query Horiz Total for custom format	151
EFHATV nnnn	Set Horiz Active for custom format	151
EFHATV?	Query Horiz Active for custom format	151
EFHFP nn	Set Horiz Front Porch for custom format	151
EFHFP?	Query Horiz Front Porch for custom format	151
EFHSYNC nn	Set Horiz Sync for custom format	151
EFHSYNC?	Query Horiz Sync for custom format	151
EFHRATE?	Query Horiz Rate for custom format	151
EFVTOTAL nnnn	Set Vert Total for custom format	152
EFVTOTAL?	Query Vert Total for custom format	152
EFVATV nnnn	Set Vert Active for custom format	152
EFVATV?	Query Vert Active for custom format	152
EFVFP nn	Set Vert Front Porch for custom format	152
EFVFP?	Query Vert Front Porch for custom format	152
EFVSYNC nn	Set Vert Sync for custom format	152
EFVSYNC?	Query Vert Sync for custom format	152
EFVRATE nnn.n	Query Vert Rate for custom format	153
EFVRATE?	Query Vert Rate for custom format	153
EFSAV	Save custom format	153
EFDEL	Delete saved custom format	153

System and Ethernet Remote Commands

The table below lists LED-PRO system and Ethernet remote commands.

Table B-6. LED-PRO System and Ethernet Remote Commands

Command	Description	Page
DMSG mode	Disable/Enable Debug messages	153
DMSG?	Query Debug message mode	153
ENETM	Set Ethernet Mode	153
EDHCP	Set Ethernet DHCP mode	154
EDHCP?	Query Ethernet DHCP mode	154
EECHO mode	Disable/Enable echo on Ethernet telnet window	154
EIP xxx.xxx.xxx.xxx yyy.yyy.yyy.yyy zzz.zzz.zzz.zzz	Sets Ethernet IP address, Subnet mask, default Gateway IP	154
EIP?	Query Ethernet IP address	154
EMAC?	Query Ethernet MAC address	154
SBAUD n	Adjust Serial Baud Rate	155
SBAUD?	Query Serial Baud Rate	155
SYSAV	Save System State	155
HELP [op]	Displays command list: op [A..Z]	155
LOADR	Run Loader Program	155
RESET	Factory Reset LED-PRO	155
WALLSTANDBY	Set LED Wall to standby mode	155
MINMODE	Set Minimum Delay Mode	156
MINSTAT	Query Minimum Delay Status	156
LOCKOUT	Locks or unlocks the front panel	156

Logo Remote Commands

The table below lists LED-PRO Logo remote commands.

Table B-7. LED-PRO Logo Remote Commands

Command	Description	Page
LOGOD	Delete currently saved Logo image from Flash	156
LOGOL	Load currently saved Logo from Flash to Frame store buffer	156
LOGOS	Save current output image as Logo image to Flash	156
LOGOI	Query Logo resolution	156

B. Remote Control Protocol

LED-PRO Remote Commands

Effects Related Commands

The table below lists LED-PRO effects related commands.

Table B-8. LED-PRO Effects Related Commands

Command	Description	Page
TRN type n	Selects transition type and time	156
TRN?	Query transition type and time	157

Pan/Zoom/View Remote Commands

The table below lists LED-PRO pan/zoom/view remote commands.

Table B-9. LED-PRO Pan/Zoom/View Remote Commands

Command	Description	Page
PANH nnn.n	Set Output Horizontal Pan	157
PANH?	Query Output Horizontal Pan Setting	157
PANV nnn.n	Set Output Vertical Pan	157
PANV?	Query Output Vertical Pan Setting	157
VIEW? nn	Query View settings	157
VIEWD nn	Delete View	158
VIEWR nn	Recall View	158
VIEWS nn	Save View	158
VIEWI? in	Query Input channel View settings	158
VIEWIR	Recall current Input channel View	158
VIEWIS in	Save Input channel View	158
ZOOM nnn.n	Selects zoom factor	159
ZOOM?	Query zoom factor	159

LED-PRO Serial Command Descriptions

RESH

- **Description:** Query the available resolution list for the LED-PRO.
 - **Parameters:** None
 - **Returns:** All available resolutions in the format:
`n : HxV @F (example: 20 : 1024x768 @59.94)`
- ▲ RESH (Query all available resolutions)

RESI nn

- **Description:** Set current channel's Input Resolution. If Auto Acquire is on, setting Input resolution with this command may be overridden.
 - **Parameters:** `nn` - Input Resolution (use RESH command for resolution list)
 - **Query:**
`RESI? in`
Returns the Input Resolution for the specified channel in the format
`= nn`
- ▲ RESI 1 (Set Input Resolution of currently selected input channel to resolution index 1 (NTSC(480i)))
- ▲ RESI? 1 (Queries Input Resolution for channel 1)

ACQ mode

- **Description:** Turns Auto acquisition mode off/on.
 - **Parameters:** `mode` [0 | 1] Off | On
 - **Query:**
`ACQ?`
Returns Auto acquisition mode in the format
`= mode`
- ▲ ACQ 0 (Turns auto acquisition mode off)
- ▲ ACQ? (Queries for auto acquisition mode)

DINT in mode

- **Description:** Sets De-interlacer mode. Motion de-interlacer mode is only available for Interlaced inputs
- **Parameters:**
`in` - Input chnl [1-4]
`mode` - De-interlacer mode [0-1] Motion | Fld->Frm
- **Query:**
`DINT? in`

B. Remote Control Protocol

LED-PRO Remote Commands

Returns De-interlacer mode in the format

= mode

- ▲ DINT 1 1 (Set De-interlacer mode to Fld->Frm)
- ▲ DINT? 1 (Queries De-interlacer mode for channel 1)

PCOMP in mode

- **Description:** Sets the de-interlacer's Pulldown Compensation mode.

- **Parameters:**

in - Input chnl [1-4]

mode - [0 | 1] Disable | Enable

- **Query:**

PCOMP? in

Returns the de-interlacer's Pulldown Compensation mode in the format

= mode

- ▲ PCOMP 1 0 (Disables Pulldown Compensation mode for channel 1.)
- ▲ PCOMP? 2 (Queries Pulldown Compensation mode of channel 2.)

FREEZ mode

- **Description:** Enables/disables output Freeze

- **Parameters:** **mode** - [0 | 1] Disable | Enable

- **Query:**

FREEZ?

Returns the Freeze mode in the format

= mode

- ▲ FREEZ 1 (Freezes Image)
- ▲ FREEZ? (Queries Freeze mode)

IAR in n cn

- **Description:** Adjust Input Aspect Ratio.

- **Parameters:**

in - Input chnl [1-4]

n - Input Aspect Ratio: n[0-5], 1:1 | 3:2 | 4:3 | 5:4 | 16:9 | Custom

cn - (Optional) Custom Input Aspect Ratio: (0.75 - 3.00)

Note

cn parameter is not required unless user selects Custom Input Aspect Ratio (i.e. n = 5)

- **Query:**

IAR? in

Returns the Input Aspect Ratio of specified source in the format

= n cn

- ▲ AR 1 5 2.0 (Sets aspect ratio of channel 1 to Custom and sets the custom aspect ratio to 2.0)
- ▲ AR? 1 (Queries Input aspect ratio of channel 1)

IAUTO

- **Description:** Auto Configure currently routed input. Only available if Input Sample mode is 1:1
- **Parameters:** None
 - ▲ IAUTO (Auto Configures current input source)

IBRT in nnn.n

- **Description:** Adjusts the Input Brightness value of the specified source.
- **Parameters:**
 - in - Input chnl [1-3]
 - nnn.n - Brightness value; Range 75 to 125%
- **Query:**

IBRT? in

Returns the Input Brightness value of the specified source in the format

= nnn.n

- ▲ BRT 2 110 (Adjusts input 2 Brightness to be 110%.)
- ▲ BRT? 2 (Queries Input Brightness of channel 2.)

ICNT in nnn.n

- **Description:** Adjusts the Input Contrast values of the specified source.
- **Parameters:**
 - in - Input chnl [1-3]
 - nnn.n - Contrast value; Range 75 - 125%
- **Query:**

ICNT? in

Returns the Input Contrast values of the specified source in the format

= nnn.n

- ▲ CNT 1 100 (Adjusts input 1 Contrast to be 100%.)
- ▲ CNT? 1 (Queries Input Contrast of channel 1.)

ICPHO in nn

- **Description:** Adjusts the Input Clock Phase Offset.
- **Parameters:**
 - in - Input chnl [1-3]
 - nn - Phase value; [-16..15]

B. Remote Control Protocol

LED-PRO Remote Commands

- **Query:**

ICPHO? in

Returns the Input Clock Phase Offset in the format

= nn

▲ CPHO 1 15 (Adjusts Input clock phase offset manually to 15 on input 1.)

▲ CPHO? 1 (Queries the Input clock phase offset of channel 1.)

ICLIST

- **Description:** Lists the names of all saved Input configurations.
- **Parameters:** None
- **Returns:** List the names of saved Input configurations, one name per line.
 - ▲ ICLIST (Lists all saved Input configurations.)

ICDEL filename

- **Description:** Delete saved Input configuration.
- **Parameters:** **filename** - name of configuration to be deleted (not case sensitive).
 - ▲ ICDEL file1 (Deletes Input configuration stored as FILE1.)

ICREC in filename

- **Description:** Recalls saved Input Configuration.
- **Parameters:**
 - in** - Input chnl [1-4]
 - filename** - configuration that is being recalled (not case sensitive).
 - ▲ ICREC 3 file1 (Recalls Input configuration stored as file1 for channel 3.)

ICRST in

- **Description:** Reset Input Configuration for the specified channel.
- **Parameters:** in - Input chnl [1-4]
 - ▲ ICRST 1 (Resets Input Configuration for channel 1)

ICSAV in filename

- **Description:** Saves Input configuration to non-volatile memory.
- **Parameters:**
 - filename** - name given to configuration when it is stored. This filename is translated to all upper case characters. If same input configuration name exist, it will be overwritten.
 - in** - Input chnl [1-4]
 - ▲ ICSAV 3 file1 (saves Input configuration as FILE1 for channel 3.)

ICSP in mode

- **Description:** Sets Input Colorspace for the selected input channel. SMPTE, BETA, and M-II colorspace available only if input type is YPbPr
- **Parameters:**

in - Input chnl [1-4]
mode - [0-3] RGB | SMPTE | BETA | M-II

- **Query:**

ICSP? in

Returns the Input Colorspace for the specified input channel in the format

= mode

- ▲ ICSP 1 2 (Sets YPbPr input colorspace to Beta for channel 1)
- ▲ ICSP? 2 (Queries channel 2 for Input Colorspace.)

ICUSE in

- **Description:** Query Input configuration name used for specified channel.
- **Parameters:** in - Input chnl [1-4]
- **Returns:** Name of the Input configuration used (if any)
- ▲ ICUSE 1 (Lists names of saved input configurations used by channel 1.)

IEDGE in edge nnnn

- **Description:** Set Input Edge in oversample mode. The minimum and maximum limit is dependent on the input resolution.
- **Parameters:**

in - Input chnl [1-4]
edge (L|R|T|B)
nnnn - Input edge: nnnn
 if edge=L [Input H Sync-(Input H Sync + (Input H total X 0.25))]
 if edge=R [((H Total - H Front Porch))X0.9 -(H total)]
 if edge= T [Vsync - (Vsync +128)]
 if edge= B [(V total -64) - Vtotal]

- **Query:**

IEDGE? in edge

Returns the Input Edge value in the format

= nnnn

- ▲ IEDGE 1 R 1024 (Set Input Right Edge to 1024)
- ▲ IEDGE? 1 L (Queries Input Left Edge value)

IGM in n

- **Description:** Sets Input Gamma for the selected input channel
- **Parameters:**

in - Input chnl [1-4]
n - [1.0-3.0] increment 0.1

B. Remote Control Protocol

LED-PRO Remote Commands

- **Query:**

IGM? in

Returns the Input Gamma for the specified input channel in the format

= n

▲ IGM 1 2.2 (Set Input gamma value to 2.2 for channel 1)

▲ IGM? 2 (Queries channel 2's Input gamma value.)

IHATV nnnn

- **Description:** Set Input Horizontal Active. The minimum and maximum limit is dependent on the input resolution.

- **Parameters:**

in - Input chnl [1-4]

nnnn - Input Horizontal Active: nnnn[(Actual Input H Active * 2/10, minimum of 150) - +(Actual Input H Active * 6/5, maximum of Input H Total - Input H Sync)]

- **Query:**

IHATV? in

Returns the Input Horizontal Active in the format

= nnnn

▲ IHATV 1 1024 (Set Input Horizontal Active for channel 1 to 1024)

▲ IHATV? 1 (Queries Input Horizontal Active for channel 1)

IHPOS nnnn

- **Description:** Set Input Horizontal Position. The minimum and maximum limit is dependent on the input resolution.

- **Parameters:**

in - Input chnl [1-4]

nnnn - Input Horizontal Position: nnnn[(Input H Sync) - +(H Total - H Active)]

- **Query:**

IHPOS? in

Returns the Input Horizontal Position in the format

= nnnn

▲ IHPOS 1 296 (Set Input Horizontal Position for channel 1 to 296)

▲ IHPOS? 1 (Queries Input Horizontal Position for channel 1)

IHTOTAL nnnn

- **Description:** Set Input Horizontal Total. The minimum and maximum limit is dependent on the input resolution.

- **Parameters:**

in - Input chnl [1-4]

nnnn - Input Horizontal Total: $nnnn[(\text{Actual Input H Total} * 2/5) - +(\text{Actual Input H Total} * 9/5)]$

- **Query:**

IHTOTAL? in

Returns the Input Horizontal Total in the format

= nnnn

▲ IHTOTAL 1 1344 (Set Input Horizontal Total for channel 1 to 1344)

▲ IHTOTAL? 1 (Queries Input Horizontal Total for channel 1)

IHUE in nnn

- **Description:** Adjusts Input Hue. Only applicable for non RGB source.

- **Parameters:**

in - Input chnl [1-4]

nnn - Input Hue (-180 - +180)

- **Query:**

IHUE? in

Returns the Input Hue in the format

= nnn

▲ IHUE 1 170 (Adjusts input hue of channel 1 to 170)

▲ IHUE? 1 (Queries Input Hue of channel 1)

ILB in mode

- **Description:** LetterBox Mode

- **Parameters:**

in - Input chnl [1-4]

mode - Disable/Enable letterbox mode (0 / 1)

- **Query:**

ILB? in

Returns the LetterBox Mode in the format

= mode

▲ ILB 1 1 (Enables Letterbox mode of channel 1)

▲ ILB? 1 (Queries LetterBox mode of channel 1)

IRBRT in c nnn.n

- **Description:** Adjusts the Input RGB Brightness value.

- **Parameters:**

in - Input chnl [1-3]

c - Color [R|G|B]

nnn.n - Brightness value; Range -25% to +25%

B. Remote Control Protocol

LED-PRO Remote Commands

- **Query:**

IRBRT? in c

Returns the Input RGB Brightness value of the specified source in the format

= nnn.n

▲ IRBRT 1 R 10 (Adjusts input 1 Red Brightness to be +10%.)

▲ IRBRT? 1 R (Queries input Red Brightness of channel 1.)

IRCNT in c nnn.n

- **Description:** Adjusts the Input RGB Contrast values.

- **Parameters:**

in - Input chnl [1-3]

c - Color [R|G|B]

nnn.n - Contrast value; Range -25% to +25%

- **Query:**

IRCNT? in c

Returns the Input RGB Contrast values of the specified source in the format

= nnn.n

▲ IRCNT 1 B -15 (Adjusts input 1 Blue Contrast to be -15%.)

▲ IRCNT? 1 B (Queries input Blue Contrast of Channel 1.)

ISAT in nnn

- **Description:** Adjust Input Saturation.

- **Parameters:**

in - Input chnl [1-4]

nnn - Input Saturation (75 - 125 if input is YPbPr, 0 - 150 otherwise)

- **Query:**

ISAT? in

Returns the Input Saturation in the format

= nnn

▲ ISAT 1 100 (Adjusts Input Saturation of channel 1 to 100)

▲ ISAT? 1 (Queries Input Saturation of channel 1)

ISMP in n

- **Description:** Adjust Input Sample Mode.

- **Parameters:**

in - Input chnl (1-3)

n - Input Sample Mode: n[0-1], Oversample | 1:1

Note

Some input's sample mode can only be set to oversample, some can only be set to 1:1.

- **Query:**

ISMP? in

Returns the Input Sample Mode in the format

= n

▲ ISMP 1 0 (Adjusts Input Sample mode of channel 1 to OverSample)

▲ ISMP? 1 (Queries Input Sample Mode of channel 1)

ISYNC in mode

- **Description:** Adjusts the Input Sync selection.

- **Parameters:**

in - Input chnl [1-3]

mode - Mode [0|1|2|3], Auto|H/V|CSync|SOG

- **Query:**

ISYNC? in

Returns the Input Sync selected for the specified input channel in the format

= mode

▲ ISYNC 1 1 (Sets Scaler to expect H/V sync on input channel 1.)

▲ ISYNC? 1 (Queries Input Sync selected for channel 1)

ISYNCSLICE in nnn

- **Description:** Adjusts the Input Sync Slice Threshold selection.

- **Parameters:**

in - Input chnl [1-3]

nnn - Sync Slice Threshold [20 - 280mV (in steps of 10)]

- **Query:**

ISYNCSLICE? in

Returns the Input Sync Slice Threshold selected for the specified input channel in the format

= nnn

▲ ISYNCSLICE 1 60 (Sets Sync Slicer threshold to 60mV for channel 1.)

▲ ISYNCSLICE? 1 (Queries Input Sync Slicer threshold for channel 1)

ITYPE in mode

- **Description:** Sets the Input Type. Note: If Auto Acquire is On, setting Input type with this command may be overridden. Input Type DVI is only available on input channel 1.

- **Parameters:**

in - Input chnl [1-3]

mode - Mode [0|1|2|3], RGB | YPbPr | NTSC/PAL/SECAM | DVI (DVI available only on chnl 1)

B. Remote Control Protocol

LED-PRO Remote Commands

- **Query:**

ITYPE? in

Returns the Input Type selected for the specified input channel in the format

= mode

▲ ITYPE 1 2 (Sets Input type to YPbPr on input channel 1.)

▲ ITYPE? 1 (Queries Input type for channel 1)

IVATV nnnn

- **Description:** Set Input Vertical Active. The minimum and maximum limit is dependent on the input resolution.

- **Parameters:** nnnn - Input Vertical Active: $nnnn[(\text{Actual Input V Active} * 2/10, \text{ absolute minimum of } 150) - + (\text{Actual Input V Active} * 6/5, \text{ absolute maximum of Input V Total} - \text{Input V Sync})]$

- **Query:**

IVATV?

Returns the Input's Vertical Active value in the format

= nnnn

▲ IVATV 768 (Set Input Vertical Active to 768)

▲ IVATV? (Queries Input Vertical Active)

IVPOS nnnn

- **Description:** Set Input Vertical Position. The minimum and maximum limit is dependent on the input resolution.

- **Parameters:** nnnn - Input Vertical Position: $nnnn[(\text{Input V Sync}) - + (\text{Input V Total} - \text{Input V Active})]$

- **Query:**

IVPOS?

Returns the Input's Vertical Position value in the format

= nnnn

▲ IVPOS 35 (Set Input Vertical Position to 35)

▲ IVPOS? (Queries Input Vertical Position)

IVTOTAL?

- **Description:** Query Input Vertical Total.
- **Parameters:** None
- **Returns:** nnnn - Input Vertical Total
- ▲ IVTOTAL? (Queries Input Vertical Total)

IVREC in

- **Description:** Input Channel View (Preset) Recall
- **Parameters:** in - Input chnl [1-4]

- ▲ IVREC 1 (Recalls Input Channel View of channel 1)

IVSAV in

- **Description:** Input Channel View (Preset) Save
- **Parameters:** in - Input chnl [1-4]
 - ▲ IVSAV 1 (Saves the Input Channel View for channel 1)

LCK? in

- **Description:** Queries Lock Status for specified input channel.
- **Parameters:** in - Input chnl [1-4]
- **Returns:** n - Lock Status (0 - 3) Not Locked | Locked (Match Format) | Locked (Best Guessed) | Locked (using saved Input Configuration)
 - ▲ LCK? 1 (Queries Lock status for channel 1)

RTE in

- **Description:** Selects and routes input to be processed.
- **Parameters:** in - Input [1-5] 1,2,3, 4=SDI, 5=Black or Logo
- **Query:**

RTE?

Returns the input channel that is routed in the format

= in

- ▲ RTE 2 (Selects input 2 for processing.)
- ▲ RTE? (Queries the input channel that is routed.)

ICLIP

- **Description:** Input Clip to Black
- **Usage:** ICLIP nnn (Input Clip Level -15 - 0)

ILUMA

- **Description:** Input Luma Tracking
- **Usage:** ILUMA nnn (Input Luma Track Level -15 - 0)

ISHRP

- **Description:** Input Sharpness
- **Usage:** ISHRP n[-10 - +10]

LCKMODE mode type

- **Description:** Sets Lock To Source Mode and Type
- **Parameters:**
src [0-1], Disable | Enable

B. Remote Control Protocol

LED-PRO Remote Commands

type [1-2], V Lock | HV Lock

- **Query:**

LCKMODE?

Returns the Lock To Source Mode and Type in the format

= mode type

- ▲ LCKMODE 1 2 (Enable Lock To Source and set Type to HV Lock)
- ▲ LCKMODE? (Queries Lock To Source Mode and Type)

LCKPHASE h

- **Description:** Sets Lock To Source Horizontal Phase
- **Parameters:** h - H Phase [(-Input H Total/2) - (+Input H Total/2)]
- **Query:**

LCKPHASE?

Returns the Lock To Source Horizontal Phase in the format

= h

- ▲ LCKPHASE 150 (Set Lock To Source H Phase to 150)
- ▲ LCKPHASE? (Queries Lock To Source H Phase)

OCNT nnn

- **Description:** Adjust LED Wall Output Contrast.

Note

Command is only applicable when LED Wall Ctrl = Local.

- **Parameters:** nnn - Output Contrast (0% - 100%)
- **Query:**

OCNT?

Returns the Output Contrast in the format

= nnn

- ▲ OCNT 50 (Adjusts Output Contrast to 50%)
- ▲ OCNT? (Queries Output Contrast)

OCRST

- **Description:** Reset Output Configuration.
- **Parameters:** None
- ▲ OCRST (Reset Output Configuration)

OCSAV

- **Description:** Save Output Configuration to non-volatile memory.
- **Parameters:** None
- ▲ OCSAV (Save Output Configuration)

OGM mode

- **Description:** Set LED Wall Output Gamma.

Note

Command is only applicable when LED Wall Ctrl = Local.

- **Parameters:** mode [0-3], Indoor1 | Indoor2 | Outdoor1 | Outdoor2
- **Query:**

OGM?

Returns the Output Gamma value in the format

= mode

- ▲ OGM 1 (Set Output Gamma to Indoor1)
- ▲ OGM? (Queries Output Gamma)

OHATV nnnn

- **Description:** Set Output Horizontal Active. The minimum and maximum limit is dependent on the output resolution.
- **Parameters:** nnnn - Output Horizontal Active: nnnn[(Actual Output H Active * 2/10, with absolute minimum value of 150) - +(Actual Output H Active * 6/5, with absolute maximum of Output H Total - Output H Sync)]
- **Query:**

OHATV?

Returns the Output Horizontal Active value in the format

= nnnn

- ▲ OHATV 1024 (Set Output Horizontal Active to 1024)
- ▲ OHATV? (Queries Output Horizontal Active)

OHPOS nnnn

- **Description:** Set Output Horizontal Position. The minimum and maximum limit is dependent on the output resolution.
- **Parameters:** nnnn - Output Horizontal Position: nnnn[(Output H Sync) - +(Output H Active)]
- **Query:**

OHPOS?

Returns the Output Horizontal Position value in the format

= nnnn

- ▲ OHPOS 296 (Set Output Horizontal Position to 296)
- ▲ OHPOS? (Queries Output Horizontal Position)

OHSYNC nnnn

- **Description:** Set Output Horizontal Sync Width. The minimum limit is 4 and maximum limit is dependent on the output resolution.

B. Remote Control Protocol

LED-PRO Remote Commands

- **Parameters:** nnnn - Output Horizontal Sync Width: nnnn [4 - (Output H Total - Output H Active - Output Horizontal Front Porch -4)]

- **Query:**

OHSYNC?

Returns the Output Horizontal Sync Width value in the format

= nnnn

▲ OHSYNC 120 (Set Output Horizontal Sync Width to 120)

▲ OHSYNC? (Queries Output Horizontal Sync Width)

OHTOTAL nnnn

- **Description:** Set Output Horizontal Total. The minimum and maximum limit is dependent on the output resolution.

- **Parameters:** nnnn - Output Horizontal Total: nnnn [(Output Hsync + Output Hactive + (Output Hpos - Output Hsync)) - +(Actual Output H Total * 9/5)]

- **Query:**

OHTOTAL?

Returns the Output Horizontal Total value in the format

= nnnn

▲ OHTOTAL 1344 (Set Output Horizontal Total to 1344)

▲ OHTOTAL? (Queries Output Horizontal Total)

OTPM type raster

- **Description:** Sets Internal Test pattern mode and raster box mode.

- **Parameters:**

type - Test Pattern type: type[0..10] 0=Off, 1=H Ramp, 2=V Ramp, 3=100% Col Bars, 4=75% Col bars,5=16x16 Grid, 6=32x32 Grid, 7=Burst, 8=50% Gray, 9=Gray Steps 1, 10=Gray Steps 2

rast - Raster Box: rast[0-1] On | Off

- **Query:**

OTPM?

Returns the Test pattern mode and raster box mode in the format

= type rast

▲ OTPM 9 0 (Selects Gray Steps 1 test pattern with raster off)

▲ OTPM? (Query test pattern mode and with raster box mode)

OVATV nnnn

- **Description:** Set Output Vertical Active. The minimum and maximum limit is dependent on the output resolution.

- **Parameters:** nnnn - Output Vertical Active: nnnn[(Actual Output V Active * 2/10, with absolute minimum value of 150) - +(Actual Output V Active *6/5, with absolute maximum value of Output V Total - Output V Sync)]

- **Query:**

OVATV?

Returns the Output Vertical Active value in the format

= nnnn

- ▲ OVATV 768 (Set Output Vertical Active to 768)
- ▲ OVATV? (Queries Output Vertical Active)

OVPOS nnnn

- **Description:** Set Output Vertical Position. The minimum and maximum limit is dependent on the output resolution.
- **Parameters:** nnnn - Output Vertical Position: nnnn[(Output V Sync) - +(Output V Active)]
- **Query:**

OVPOS?

Returns the Output Vertical Position value in the format

= nnnn

- ▲ OVPOS 35 (Set Output Vertical Position to 35)
- ▲ OVPOS? (Queries Output Vertical Position)

OVSYNC nnnn

- **Description:** Set Output Vertical Sync Width. The minimum limit is 2 and maximum limit is dependent on the output resolution.
- **Parameters:** nnnn - Output Vertical Sync Width: nnnn[2-(Output V Total -Output V Active - Output Vertical Front Porch -2)]
- **Query:**

OVSYNC?

Returns the Output Vertical Sync Width value in the format

= nnnn

- ▲ OVSYNC 6 (Set Output Vertical Sync Width to 6)
- ▲ OVSYNC? (Queries Output Vertical Sync Width)

OVTOTAL nnnn

- **Description:** Set Output Vertical Active. The minimum and maximum limit is dependent on the output resolution.
- **Parameters:** nnnn - Output Vertical Total: nnnn[(Output Vsync + Output Vactive + (Output Vpos - Output Vsync)) - +(Actual Output V Total * 9/5)]
- **Query:**

OVTOTAL?

Returns the Output Vertical Total value in the format

= nnnn

- ▲ OVTOTAL 806 (Set Output Vertical Total to 806)

B. Remote Control Protocol

LED-PRO Remote Commands

- ▲ OVTOTAL? (Queries Output Vertical Total)

EFLIST

- **Description:** Lists the names of all saved custom formats.
- **Parameters:** None
- **Returns:** List the names of saved custom formats, one name per line.
 - ▲ EFLIST (Lists all saved custom formats.)

EFRES nn

- **Description:** Set base resolution for custom formats. All parameters for custom format will be loaded using the specified resolution.
- **Parameters:** nn - Resolution (use RESH command for resolution list)
- **Query:**

EFRES?

Returns the base resolution used for custom formats settings in the format

= nn

- ▲ EFRES 1 (Load custom format settings with resolution index 1 values)
- ▲ EFRES? (Query the base resolution for custom format settings)

EFRESH

- **Description:** Query the available resolution list for custom format.
- **Parameters:** None
- **Returns:** All available resolutions in the following format:

n : HxV @F (example: 18 : 1024x768 @59.94)

- ▲ EFRESH (Query all available resolutions)

EFINT mode

- **Description:** Set custom format to be non-interlaced or interlaced format.
- **Parameters:** mode - [0 | 1] Non-Interlaced | Interlaced
- **Query:**

EFINT?

Returns the interlace mode of the custom format in the format

= mode

- ▲ EFINT 1 (Set custom format to be interlaced)
- ▲ EFINT? (Query the interlace mode for the custom format)

EFHTOTAL nnnn

- **Description:** Set custom format's Horizontal Total value.
- **Parameters:** nnnn - H Total [640 - +(162000 / H Rate)]

- **Query:**

EFHTOTAL?

Returns the custom format's Horizontal Total value in the format

= nnnn

▲ EFHTOTAL 1344 (Set custom format H Total as 1344)

▲ EFHTOTAL? (Query the custom format's H Total value)

EFHATV nnnn

- **Description:** Set custom format's Horizontal Active value.

- **Parameters:** nnnn - H Active [500 - +(H Total - H Sync - H Front Porch)]

- **Query:**

EFHATV?

Returns the custom format's Horizontal Active value in the format

= nnnn

▲ EFHATV 1024 (Set custom format H Active as 1024)

▲ EFHATV? (Query the custom format's H Active value)

EFHFP nn

- **Description:** Set custom format's Horizontal Front Porch value.

- **Parameters:** nn - H Front Porch [4 - +(H Total - H Active - H Sync - 4)]

- **Query:**

EFHFP?

Returns the custom format's Horizontal Front Porch value in the format

= nn

▲ EFHFP 5 (Set custom format H Front Porch as 5)

▲ EFHFP? (Query the custom format's H Front Porch value)

EFHSYNC nn

- **Description:** Set custom format's Horizontal Sync value.

- **Parameters:** nn - H Sync [4 - +(H Total - H Active - H Front Porch - 4)]

- **Query:**

EFHSYNC?

Returns the custom format's Horizontal Sync value in the format

= nn

▲ EFHSYNC 5 (Set custom format H Sync as 5)

▲ EFHSYNC? (Query the custom format's H Sync value)

EFHRATE?

- **Description:** Query custom format's Horizontal Rate value (kHz).

B. Remote Control Protocol

LED-PRO Remote Commands

- **Parameters:** None
- **Returns:** nn.nn - H Rate
 - ▲ EFHRATE? (Query custom format's H Rate value)

EFVTOTAL nnnn

- **Description:** Set custom format's Vertical Total value.
- **Parameters:** nnnn - V Total [480 - 4096]
- **Query:**
 - EFVTOTAL?Returns the custom format's Vertical Total value in the format
 - = nnnn
 - ▲ EFVTOTAL 512 (Set custom format V Total as 512)
 - ▲ EFVTOTAL? (Query the custom format's V Total value)

EFVATV nnnn

- **Description:** Set custom format's Vertical Active value.
- **Parameters:** nnnn - V Active [400 - +(V Total - V Sync - V Front Porch)]
- **Query:**
 - EFVATV?Returns the custom format's Vertical Active value in the format
 - = nnnn
 - ▲ EFVATV 768 (Set custom format V Active as 768)
 - ▲ EFVATV? (Query the custom format's V Active value)

EFVFP nn

- **Description:** Set custom format's Vertical Front Porch value.
- **Parameters:** nn - V Front Porch [1 - +(V Total - V Active - V Sync - 1)]
- **Query:**
 - EFVFP?Returns the custom format's Vertical Front Porch value in the format
 - = nn
 - ▲ EFVFP 5 (Set custom format V Front Porch as 5)
 - ▲ EFVFP? (Query the custom format's V Front Porch value)

EFVSYNC nn

- **Description:** Set custom format's Vertical Sync value.
- **Parameters:** nn - V Sync [1 - +(V Total - V Active - V Front Porch - 1)]
- **Query:**
 - EFVSYNC?

Returns the custom format's Vertical Sync value in the format

= nn

- ▲ EFVSYNC 2 (Set custom format V Sync as 2)
- ▲ EFVSYNC? (Query the custom format's V Sync value)

EFVRATE nnn.n

- **Description:** Set custom format's Vertical Rate value.
- **Parameters:** nnn.nn - V Rate [20.00 - 120.00]
- **Query:**

EFVRATE?

Returns the custom format's Vertical Rate value in the format

= nnn.n

- ▲ EFVRATE 59.94 (Set custom format V Rate as 59.94)
- ▲ EFVRATE? (Query the custom format's V Rate value)

EFSAV

- **Description:** Saves currently defined custom format to non-volatile memory.
- **Parameters:** filename - name given to custom format when it is stored. This filename is translated to all upper case characters. If same custom format name exist, it will be overwritten.
- ▲ EFSAV format1 (saves custom format as FORMAT1.)

EFDEL

- **Description:** Deletes saved custom format. This filename is translated to all upper case characters
- **Parameters:** filename - name of custom format to be deleted (translated to upper case).
- ▲ EFDEL FORMAT1 (Deletes custom format with the name "FORMAT1".)

DMSG mode

- **Description:** Sets Debug message display mode.
- **Parameters:** mode - DMSG mode [0-1] Off | On
- **Query:**

DMSG?

Returns the Debug message display mode in the format

= mode

- ▲ DMSG 1 (Sets Debug message mode to On)
- ▲ DMSG? (Queries the DMSG mode)

ENETM

- **Description:** Set Ethernet Mode

B. Remote Control Protocol

LED-PRO Remote Commands

- **Usage:** ENETM mode [0|1] Off|On

EDHCP

- **Description:** Sets DHCP mode.
- **Parameters:** mode - DHCP mode [0-1] Off | On
- **Query:**

EDHCP?

Returns the DHCP mode in the format

= mode

- ▲ EDHCP 1 (Sets DHCP mode to On)
- ▲ EDHCP? (Queries the DHCP mode)

EECHO mode

- **Description:** Disable/Enable echo on telnet window (for Microsoft Windows XP telnet window, echo must be disabled.)
- **Parameters:** mode - Disable/Enable telnet echo (0 / 1)
 - ▲ EECHO 0 (Disable echo on telnet window)

EIP xxx.xxx.xxx.xxx yyy.yyy.yyy.yyy zzz.zzz.zzz.zzz

- **Description:** Set static IP address, subnet mask and default Gateway IP
- **Parameters:**

IP address - xxx.xxx.xxx.xxx (xxx: [0-255])

Subnet mask - yyy.yyy.yyy.yyy (yyy: [0-255])

Gateway IP - zzz.zzz.zzz.zzz (zzz: [0-255])

- **Query:**

EIP?

Returns the Ethernet IP address, Subnet mask and Gateway IP in the format

= xxx.xxx.xxx.xxx yyy.yyy.yyy.yyy
zzz.zzz.zzz.zzz

Note

If DHCP is used, Subnet mask and Gateway IP is not used by the LED-PRO.

- ▲ EIP 192.168.0.200 255.255.255.0 192.168.0.1 (Sets IP address to 192.168.0.200, subnet mask to 255.255.255.0, and default Gateway IP to 192.168.0.1)
- ▲ EIP? (Returns IP address, subnet mask and Gateway IP)

EMAC?

- **Description:** Query Ethernet MAC address for the LED-PRO. Note that each LED-PRO unit will have a different MAC address.
- **Parameters:** None

- **Returns:** MAC address. xx:xx:xx:xx:xx:xx
 - ▲ EMAC? (Queries for Ethernet MAC address)

SBAUD n

- **Description:** Adjust the Serial Baud Rate.
- **Parameters:** n - Serial baud rate: n[0-4] 1200 | 2400 | 9600 | 19200 | 38400
- **Query:**

SBAUD?

Returns the Serial Baud Rate in the format

= n

- ▲ SBAUD 0 (Adjusts Serial Baud Rate to 1200)
- ▲ SBAUD? (Queries Serial Baud Rate.)

SYSAV

- **Description:** Saves the System State into non-volatile memory
- **Parameters:** None
 - ▲ SYSAV (Saves System State.)

HELP [op]

- **Description:** Displays Command List
- **Parameters:** op[A..Z] optional command
 - ▲ Help (Displays command list)
 - ▲ Help Freez (Displays syntax/parameters for the Freeze command)

LOADR

- **Description:** Places unit into loader mode. This mode is used to perform field upgrades
- **Parameters:** None.
 - ▲ LOADR (Puts unit into loader mode.)

RESET

- **Description:** Factory resets the system and sets all settings to factory defaults.
- **Parameters:** None
 - ▲ RESET (Factory reset the LED-PRO™)

WALLSTANDBY

- **Description:** Set LED Wall to standby mode
- **Usage:** WALLSTANDBY [0|1] (0 = enable, 1 = standby)

B. Remote Control Protocol

LED-PRO Remote Commands

MINMODE

- **Description:** Set Minimum Delay Mode
- **Usage:** MINMODE mode [0|1] disable|enable

MINSTAT

- **Description:** Query Minimum Delay Status
- **Usage:** MINSTAT mode [0|1] disable|enable

LOCKOUT

- **Description:** Locks and unlocks the front panel
- **Usage:** LOCKOUT (0 = off, 1 = on)

LOGOD

- **Description:** Delete Logo image from non-volatile memory. Selecting Black/ Logo channel will now display black.
- **Parameters:** None
 - ▲ LOGOD (Delete saved Logo image.)

LOGOL

- **Description:** Load current output image from non-volatile memory as Logo image.
- **Parameters:** None
 - ▲ LOGOL (Load current output image as Logo image.)

LOGOS

- **Description:** Save current output image in non-volatile memory as Logo image.
- **Parameters:** None
 - ▲ LOGOS (Save current output image as Logo image.)

LOGOI

- **Description:** Query the stored Logo image resolution.
- **Parameters:** None
 - ▲ LOGOI (Query Logo resolution.)

TRN type n

- **Description:** Selects transition type when switching between input channels. Transition delay is only applicable if the transition type selected is Fade to black / Fade to logo. Fade to logo transition type only selectable if Logo has been stored in non-volatile memory.

- **Parameters:**
 - type** - Transition type [0-2] 0= Fade to black, 1=Freeze image and Cut, 2= Fade to logo
 - in** - Transition delay (in seconds) [1.0s - 5.0s]

- **Query:**

TRN?

Returns the current transition type and transition delay in the format

= type in

- ▲ TRN 1 2.0 (Selects fade to black transition in 2 seconds.)
- ▲ TRN? (Queries transition type and transition delay.)

PANH nnn.n

- **Description:** Set Output Horizontal Pan.
- **Parameters:** nnn.n - Horizontal Pan (-100.0% - +100.0%)
- **Query:**

PANH?

Returns the Output Horizontal Pan value in the format

= nnn.n

- ▲ PANH 50 (Set Output Horizontal Pan to 50%)
- ▲ PANH? (Queries Output Horizontal Pan)

PANV nnn.n

- **Description:** Set Output Vertical Pan.
- **Parameters:** nnn.n - Vertical Pan (-100.0% - +100.0%)
- **Query:**

PANV?

Returns the Output Vertical Pan value in the format

= nnn.n

- ▲ PANV 50 (Set Output Vertical Pan to 50%)
- ▲ PANV? (Queries Output Vertical Pan)

VIEW? nn

- **Description:** Query saved View settings (i.e. Zoom setting, Pan H setting, Pan V setting)
- **Parameters:** nn - View Index [1 - 15]
- **Returns:**

nnn.n - Zoom value [min-max] depends on scale factor

hhh.h - Horizontal Pan (-100.0% - +100.0%)

B. Remote Control Protocol

LED-PRO Remote Commands

vvv.v - Vertical Pan (-100.0% - +100.0%)

Note

A "View" is synonymous with "Preset."

VIEWD nn

- **Description:** Delete saved View (Preset)
- **Parameters:** nn - View Index [1 - 15]
- ▲ VIEWD 1 (Delete View 1.)

VIEWR nn

- **Description:** Recall View (Preset)
- **Parameters:** nn - View Index [0 - 15]. Index 0 is default view (i.e. Zoom = 100%, Pan H = 0%, Pan V = 0%)
- ▲ VIEWR 1 (Recall saved View 1.)

IEWS nn

- **Description:** Save current View (Preset) to non-volatile memory
- **Parameters:** nn - View Index [1 - 15]
- ▲ IIEWS 1 (Save current View to Index 1.)

VIEW? in

- **Description:** Query saved Input channel View (Preset) settings (i.e. Zoom setting, Pan H setting, Pan V setting)
- **Parameters:** in - Input chnl [1-4]
- **Returns:**
 - nnn.n** - Zoom value [min-max] depends on scale factor
 - hhh.h** - Horizontal Pan (-100.0% - +100.0%)
 - vvv.v** - Vertical Pan (-100.0% - +100.0%)
- ▲ VIEW? 1 (Query View settings for channel 1.)

VIEWIR

- **Description:** Recall currently routed Input channel's View (Preset)
- **Parameters:** None
- ▲ VIEWIR (Recall saved Input channel View for currently routed channel.)

VIEWIS in

- **Description:** Save current View (Preset) to non-volatile memory for selected Input channel.
- **Parameters:** in - Input chnl [1-4]
- ▲ VIEWIS 1 (Save current View for channel 1.)

ZOOM nnn.n

- **Description:** Selects zoom scale factor (applied both horizontally and vertically).
- **Parameters:** nnn.n - Zoom value [min-max] depends on scale factor
- **Query:**

ZOOM?

Returns the current zoom scale factor in the format

= nnn.n

- ▲ ZOOM 200.0 (Zoom into the image using a 200.0% scale factor)
- ▲ ZOOM? (Queries current zoom scale factor.)

B. Remote Control Protocol

LED-PRO Remote Commands

C. Contact Information

In This Appendix

The following topics are discussed in this Appendix:

- [Warranty](#)
 - [Return Material Authorization \(RMA\)](#)
 - [Contact Information](#)
-

Warranty

All video products are designed and tested to the highest quality standards and are backed by a full 3-year parts and labor warranty. Warranties are effective upon delivery date to customer and are non-transferable. Barco warranties are only valid to the original purchaser/owner. Warranty related repairs include parts and labor, but do not include faults resulting from user negligence, special modifications, lightning strikes, abuse (drop/crush), and/or other unusual damages.

The customer shall pay shipping charges when unit is returned for repair. Barco will cover shipping charges for return shipments to customers.

Return Material Authorization (RMA)

In the unlikely event that a product is required to return for repair, please call the following number and ask for a Sales Engineer to receive a Return Merchandise Authorization number (RMA).

- (888) 414-7226

RMA Conditions are listed below:

- Prior to returning any item, you must receive a Return Merchandise Authorization (RMA) number.
- All RMA numbers must appear on their return-shipping label.
- RMA numbers are valid for ten (10) days from issue date.
- All shipping and insurance charges on all RMAs must be prepaid by the customer

C. Contact Information

Contact Information

Contact Information

Barco Media and Entertainment

11101 Trade Center Drive
Rancho Cordova, California 95670
USA

- Phone: (916) 859-2500
- Fax: (916) 859-2515
- Websites:
 - ~ www.folsom.com
 - ~ www.events.barco.com

Sales Contact Information

- Direct: (916) 859-2505
- Toll Free: (888) 414-7226
- E-mail: folsomsales@barco.com

Barco N.V.

Noordlaan 5
8520 Kuurne
BELGIUM

- Phone: +32 56.36.82.11
- Fax: +32 56.35.16.51
- Website: www.barco.com

Technical Support Information

- Tech Line: (866) 374-7878 — 24 hours per day, 7 days per week
- E-mail: folsomsupport@barco.com

Index

Numerics

10/100BaseT	16
1-1 sampling	69
1-1 Timing Adjust Menu	70
50/60 Hz refresh rate	5

A

About LED-PRO	4
AC	
connector	16
power cords	20
Access, status menu	36
ACQ mode	135
Acrobat usage	3
navigating and searching	3
Adapter information	18
Address, company	iii
ADJUST	
knob	10, 11
using knob	31
AEC	7
Agency specifications	120
Alignment	
analog source	43
DVI source	48
SDI source	46
Ambient Environment Controller	7
Analog	
15-pin D connector pinouts	121
source alignment	43
source alignment menu	43
Analog source	
blue brightness	44
blue contrast	44
brightness	44
clip to subblk	45
contrast	43
EDID DVI	45
green brightness	44
green contrast	44
luma tracking	45

red brightness	44
red contrast	44
sharpness	45
Application questions	8
Aspect ratio	76
mode	76
Asterisks	69
Athena scaler	4
Auto Config	70
Auto-acquire	
off	87
on	87
Automatic input acquisition	87

B

Barco	
company address	iii
events, contact information	162
sales contact information	162
technical support information	162
warranty	161
Baud	89
rate, set	51
Best guess, auto-acquire	69
Black, internal	14
Blue	
brightness, analog source	44
contrast, analog source	44
Boost mode	103
Bootup	
Ethernet mode	27
standard	26
with stored LOGO	28
Bottom Edge	71
Brightness	
analog source	44
display	88
DVI source	48
SDI source	46

Index

C

Cable information	18
Capture logo	86
Change	
history	vi
sampling mode	70
Chapter structure	2
Clip to SubBlk	
analog source	45
SDI source	47
Colorspace	72
Commands, remote	128
Communications specifications	120
Company address	iii
Config	
delete	79
recall	78
reset	78
save	78
Connectivity, system diagram	7
Connector	
AC	16
analog 15-pin D pinouts	121
diagnostics	16
DVI-I pinouts	122
Ethernet	16
Ethernet pinouts	123
LED interface (output)	16
RS-232	16
SDI input	16
serial pinouts	124
universal input 1	15
universal input 2	15
universal input 3	16
Connectors	
front panel	10
rear panel	15
Contact information	162
Contrast	
analog source	43
DVI source	48
LED	82, 100
SDI source	46
Control	
LED	100
overview	26
Conventions	3
menu system	31
Copyright	ii
Creative mode	103
Crop	76
Current input format	37
Cursor	11
edit	31
navigation	31

Custom

format	73
format, remote commands	132
format, save as	73
in format	72
input formats menu	73

D

Default

IP address	127
serial parameters	126

Delntlc

Delay, minimum values	84
-----------------------	----

Delete

config	79
custom format	74
format menu	74
global preset	50
logo	86
preset menu	50

Description

expert mode menu	67
input position menu	106
LED menu	99
pan & zoom menu	96
serial commands	135
setup menu	41
status menu	37
test pattern menu	93

DHCP

Diagnostic	89
------------	----

Diagnostic

connector pinouts	124
port, default settings	126
port, set parameters	88
port, upgrade	112
ports	16
RS232	88
RS232 menu	88
RS232 menu, software upgrade	115

Diagonal motion

Diagram	94
---------	----

Diagram

system	21
system connectivity	7

DINT in mode

Director Toolset	135
------------------	-----

Director Toolset

communications	5, 56
patch	16
version	6

Display

brightness	6
mode	88
section	76
section	10, 11

Index

DMSG mode	153
Documentation conventions and symbols	3
Double arrow	11
Download software	113
serial upgrade	114
via FTP site	113
via web site	113
DVI input	15
DVI source	
alignment	48
alignment menu	48
brightness	48
contrast	48
EDID DVI	48
sharpness	48
DVI-I connector pinouts	122

E

EDHCP	154
EDID DVI	
analog source	45
DVI source	48
input format menu	53
SDI source	47
EDID In Frmt	91
Edit cursor	31
EECHO mode	154
EFDEL	153
Effects	85
related remote commands	134
EFHATV nnnn	151
EFHFP nn	151
EFHRATE?	151
EFHSYNC nn	151
EFHTOTAL nnnn	150
EFINT mode	150
EFLIST	150
EFRES nn	150
EFRESH	150
EFSAV	153
EFVATV nnnn	152
EFVFP nn	152
EFVRATE nnn.n	153
EFVSYNC nn	152
EFVTOTAL nnnn	152
EIP xxx.xxx.xxx.xxx yyy.yyy.yyy.yyy zzz.zzz.zzz.zzz	154
Electrical specifications	119
EMAC?	154
Enable/disable	
raster box	94
test pattern	94

Enabled, LED wall	82
ENETM	153
Equipment marking terms	v
ESC	11
using	31
Ethernet	89
bootup	27
connector	16
connector pinouts	123
menu	89
mode	89
port	16
remote commands	133
Expert Mode	5, 51
menu description	67
menu tree	66
using	66

F

Factory Reset	52, 92
menu	52
FCC statement	ii
Features	
LED-PRO	4
what's new in version 2.0	5
Fiber	
rx ID	102
tx ID	102
Fiberlink	7
Firmware files	112
Flash Loader	16, 114
Format	
custom input	72
input	69
FREEZ mode	136
Freeze	87
off	87
on	87
Front panel	
connectors	10
display section	10
inputs section	10
lock/unlock	91
menu keys section	10
FTP site	113
Function, quick reference table	33

G

Gamma, LED	82, 100
Global preset	
delete	50
menu	49

Index

overview	.49
recall	.49
save	.50
Green	
brightness, analog source	.44
contrast, analog source	.44
Guarantee and compensation	ii

H

H Active	.71, 75
H Front Porch	.75
H Phase	.83
H Position	.71, 81, 106
H Rate (KHz)	.75
H Size	.81, 106
H Sync	.75, 81
H Total	.71, 75, 81
Handshaking	.89
Hardware	
installation	.17
orientation	.9
requirements, upgrading software	.112
History, change	vi
How to	
change input video format	.69
change sampling mode	.70
communicate via Ethernet	.91
delete custom input format	.74
delete global preset	.50
delete input configuration	.79
install LED-PRO power	.19
install signals to/from LED-PRO	.21
perform factory reset	.52
power up LED-PRO	.26
program EDID	.53
recall global preset	.49
save custom input format	.73
save global preset	.50
save input configuration	.64, 107
save system state	.52
set RS-232 connector baud rate	.51
set subnet mask, gateway, static IP	.90
unlock front panel	.91
upgrade LED-PRO software	.114
use menu system	.31
use setup wizard	.56
use this guide	.3

Hue, SDI source	.46
Hyperlinks	.3
HyperTerminal	.16

I

IAR in n cn	.136
IAUTOC	.137
IBRT in nnn.n	.137
ICDEL filename	.138
ICLIP	.145
ICLIST	.138
ICNT in nnn.n	.137
ICPHO in nn	.137
ICREC in filename	.138
ICRST in	.138
ICSAV in filename	.138
ICSP in mode	.139
ICUSE in	.139
ID	
fiber rx	.102
fiber tx	.102
LED wall	.101
LED-PRO	.101
IEDGE in edge nnnn	.139
IGM in n	.139
IHATV nnnn	.140
IHPOS nnnn	.140
IHTOTAL nnnn	.140
IHUE in nnn	.141
ILB in mode	.141
ILUMA	.145
Image processing	.77
In Auto Acquire	.87
Information	
cables and adapters	.18
LED	.82, 101
Initialization	.26
Input	
aspect ratio menu	.76
format	.69
position menu	.105
position menu description	.106
position menu tree	.105
remote commands	.128
SD/HD	.13
SDI	.16
setup menu	.68
source alignment	.5
specifications	.118
Input 1	.13, 15
Input 2	.13, 15
Input 3	.13, 16
INPUT POS	.12, 105
Input Wizard	.5, 42, 62
using	.62

Index

Inputs section	10, 13
Inspection	18
Installation	
hardware	17
power	19
rack mount	19
safety precautions	18
signals	21
site preparation	18
unpacking and inspection	18
Interlaced	75
video	77
Internal black	14
Introduction to LED-PRO	1
Invalid Signal	69
IP address	91
default	127
IRBRT in c nn.n	141
IRCNT in c nnn.n	142
ISAT in nnn	142
ISHRP	145
ISMP in n	142
ISYNC in mode	143
ISYNCSLICE in nnn	143
ITYPE in mode	143
IVATV nnnn	144
IVPOS nnnn	144
IVREC in	144
IVSAV in	145
IVTOTAL?	144

L

LCK? in	145
LCKMODE mode type	145
LCKPHASE h	146
LED	12
boost mode	103
contrast	82, 100
control	82, 100
creative mode	103
gamma	82, 100
information	82, 101
information menu	82
interface	16
local	100
menu	6, 98
menu description	99
menu tree	98
OSD	102
OSD status	103
OSD type	103
output	16
output menu	80
remote	100
reset config	104

RS232	104
save config	104
source, test pattern	102
status	82, 100
status, enabled	100
status, standby	100
test pattern	102
test pattern type	102
tile count	101
tile mode	103
type	101
wall ID	101
LED-PRO	
about	4
control overview	26
features	4
front panel connectors	10
hardware installation	17
hardware orientation	9
ID	101
introduction to	1
menu tree	30
operation	25
rear panel connectors	15
remote commands	128
remote control protocol	125
serial command descriptions	135
specifications	117
system diagram	21
upgrading software	111
Left Edge	71
Letterbox	76
Line voltage selection	20
LOADR	155
Local	82
Local preset, input specific	96, 97
Lock	
front panel	91
to Source	83
to source menu	83
to source mode, status	37
LOCKOUT	156
LOGO	10, 13, 86
about the	14
bootup	28
Logo	
capture	86
delete	86
menu	86
present	86
remote commands	133
status	86

Index

LOGOD	156
LOGOI	156
LOGOL	156
LOGOS	156
Luma Tracking	
analog source	45
SDI source	47

M

MAC address	91
Menu	
1-1 timing adjust	70
analog source alignment	43
custom input format	73
delete format	74
delete preset	50
diagnostic RS232	88, 115
display	11
DVI source alignment	48
EDID DVI input format	53
Ethernet	89
expert mode	67
factory reset	52
global preset menu	49
input aspect ratio	76
input position	105
input setup	68
keys section	10, 12
LED	6, 98
LED information	82
LED output	80
lock to source	83
logo	86
output timing adjust	81
oversample timing adjust	71
overwrite custom format	74
pan & zoom	95
processing	77
recall preset	49
RS232	51
RS232, LED	104
rules and conventions	31
save preset	50
SDI source alignment	46
software version	116
system	88
tree, simplified	30
usage, rules	31
using the status	36
Menu tree	
expert mode	66
input position	105
LED	98
pan & zoom	95
setup menu	40

test pattern	93
Minimum delay	83
values	84
MINMODE	156
MINSTAT	156
MiPIX	5, 56
MiSPHERE	5, 56
Mode	83
display	76
Ethernet	89
Motion, diagonal	94

N

Navigation cursor	11, 31
Notice	ii
NTSC, PAL or SECAM	15, 16

O

OCNT nnn	146
OCRST	146
OCSAV	146
OGM mode	147
OHATV nnnn	147
OHPOS nnnn	147
OHSYNC nnnn	147
OHTOTAL nnnn	148
OLite	5, 56
HELP	155
Operation, LED-PRO	25
Operators safety summary	iv
Orientation, hardware	9
OSD	
status	103
type	103
OSD, LED	102
OTPM type raster	148
Output	80
raster box	71
remote commands	131
specifications	119
timing adjust menu	81
OVATV nnnn	148
Oversample	69
timing adjust menu	71

Index

Overview, control	26
Overwrite Custom Format Menu	74
OVPOS nnnn	149
OVSYNC nnnn	149
OVTOTAL nnnn	149

P

PAN & ZOOM	12
Pan & Zoom	
menu	95
menu description	96
menu tree	95
Pan H	96
Pan V	96
Pan/zoom/view remote commands	134
PANH nnn.n	157
PANV nnn.n	157
Parameters	89
PCOMP in mode	136
PDF file usage	3
navigating and searching	3
Physical specifications	119
Pinouts	121
analog 15-pin D connector	121
DVI-I connector	122
Ethernet connector	123
serial and diagnostci connector	124
Power	
cord, line voltage selection	20
installation	19
precautions	20
up and initialization	26
Preset	
global	49
local, input specific	96
recall local	97
recall, pan & zoom	97
reset local	97
reset, pan & zoom	97
save local	97
save, pan & zoom	97
Processing	77
menu	77

Progressive video	77
Protocol, remote control	125
Pulldown Comp	77

Q

Quick function reference	33
--------------------------	----

R

Rack mount installation	19
Raster box	94
Ratio	76
Rear panel connectors	15
Recall	
config	78, 109
global preset	49
local preset	97
preset menu	49
preset, pan & zoom	97
Red	
brightness, analog source	44
contrast, analog source	44
Reference, quick function table	33
Refresh rate	5, 81
Remote	82
commands, LED-PRO	128
control protocol	125
Remote commands	
custom format	132
effects related	134
input	128
LED-PRO	128
logo	133
output	131
pan/zoom/view	134
resolution	128
system and Etherent	133
RESET	155
Reset	
config	78, 84, 108
config, LED	104
factory	92
local preset	97
preset, pan & zoom	97
RS-232 settings	89

Index

RESH 135
RESI nn 135
Resolution remote commands 128
Return material authorization 161
RGB 15, 16
Right Edge 71
RMA 161
RS-232
 command Syntax 127
 menu 51
 menu, LED 104
 mode 127
 port 16
 port, default settings 126
RTE in 145

S

Safety
 precautions 18
 summary iv
Sales contact information 162
Sample Phase 71
Sampling 69
 1-1 69
 oversample 69
Saturation, SDI source 47
Save
 as 73
 config 78, 84, 107
 config, LED 104
 global preset 50
 local preset 97
 preset menu 50
 preset, pan & zoom 97
 system state 51, 92
SBAUD n 155
Scale 76
SD/HD input 13
SD/HD SDI 13, 16
SDI
 input 16
 source alignment menu 46
SDI source
 alignment 46
 brightness 46
 clip to subblk 47
 contrast 46
 EDID DVI 47
 hue 46
 luma tracking 47
 saturation 47
 sharpness 47
SEL 11
 using 31, 32

Serial
 connector pinouts 124
 default parameters 126
 port 16
 port baud rate, set 104
 upgrade procedure 114
Set Static IP 90
SETUP 12
Setup menu
 description 41
 tree 40
 using 39
Setup Wizard 5, 42, 56
 using 56
Sharpness
 analog source 45
 DVI source 48
 SDI source 47
Signal
 installation 21
 type 37
Site preparation 18
Software
 downloading 113
 requirements, upgrading 112
 upgrade overview 112
 upgrading 111
 version 92
 version menu 116
Source
 alignment 72
 LED test pattern 102
Source alignment 5
 analog 43
 DVI 48
 SDI 46
Specifications 117
 agency 120
 communications 120
 electrical 119
 input 118
 output 119
 physical 119
 pinouts 121
 user control 119
Standard bootup 26
Standby 82
Static IP 90
Status
 current input format 37
 LED 82, 100
 LED OSD 103
 LED wall 38
 lock to source mode 37
 signal type 37
Status menu
 access 36

Index

description	37
fields	37
using	36
Support, technical information	162
S-Video (Y/C)	15, 16
Symbols	3
Sync	
sel	77
slice (mV)	77
SYSAV	155
System	88
diagram	21
initialization	26
menu	88
output, LED wall	16
remote commands	133
save state	51, 92

T

Table, quick function reference	33
Technical support information	162
Telnet	16, 91
Terms, equipment marking	v
TEST PAT	12, 93
Test pattern	
generator, diagonal scrolling	6
LED	102
menu description	93
menu tree	93
type	94
using	93
Tile	
count, LED	101
mode, LED	103
Timing	
adjust	70, 81
output raster box	71
Top Edge	71
Trademarks	iii
Trans	
time	85
with	85
Transition	
rate	85
type	85
TRN type n	156
Type	72, 83
LED	101
LED test pattern	102
OSD display	103
test pattern	94

U

Universal	
input 1	13, 15
input 2	13, 15
input 3	13, 16
Unpacking	18
Unsaved changes	79
system menu	92
Upgrading software	111
User control specifications	119
Using	
ESC button	31
expert mode menu	66
input position menu	105
input wizard	62
LED menu	98
pan & zoom menu	95
SEL button	31, 32
setup menu	39
setup wizard	56
status menu	36
test pattern menu	93

V

V Active	71, 75
V Front Porch	75
V Position	71, 81, 107
V Rate (Hz)	75
V Size	81, 107
V Sync	75, 81
V Total	71, 75, 81
Version, software	92
VFD Brightness	88
VIEW? nn	157
VIEWD nn	158
VIEWI? in	158
VIEWIR	158
VIEWIS in	158
VIEWR nn	158
Views (presets)	49
VIEWS nn	158

W

Wall status	38
WALLSTANDBY	155
Warranty	161
Web site	113
What's new in version 2.0	5
Wizard	
input	5, 42, 62
setup	5, 42, 56

Index

Y

YUV15, 16

Z

Zoom97

ZOOM nnn.n159

Free Manuals Download Website

<http://myh66.com>

<http://usermanuals.us>

<http://www.somanuals.com>

<http://www.4manuals.cc>

<http://www.manual-lib.com>

<http://www.404manual.com>

<http://www.luxmanual.com>

<http://aubethermostatmanual.com>

Golf course search by state

<http://golfingnear.com>

Email search by domain

<http://emailbydomain.com>

Auto manuals search

<http://auto.somanuals.com>

TV manuals search

<http://tv.somanuals.com>