

ADURAN

ISU 2x64

Dual Port ISDN Service Unit

User Manual

Part Numbers

1200051L1	U-Interface Version, 110 VAC
1200051L2	S/T-Interface Version, 110 VAC
1200051L5	S/T-Interface International, 110 VAC
1200051L6	S/T-Interface International, 230 VAC

61200051L1-1D
June 1998

Trademarks:

Ascend is a registered trademark of Ascend Communications, Inc.

ISU is a trademark of ADTRAN, Incorporated.

Macintosh is a registered trademark of Apple Computer, Inc.

Teleos is a registered trademark of Teleos Communications, Inc.

Windows is a registered trademark of Microsoft corporation.

5ESS is a registered trademark of AT&T.

DMS-100 is a trademark of Northern Telecom.



901 Explorer Boulevard
P.O. Box 140000
Huntsville, AL 35814-4000
Phone: (256) 963-8000

© 1998 ADTRAN, Inc.
All rights reserved.
Printed in USA.

FCC regulations require that the following information be provided in this manual:

1. This equipment complies with Part 68 of the FCC rules. On the bottom of the equipment housing is a label that shows the FCC registration number and Ringer Equivalence Number (REN) for this equipment. If requested, provide this information to the telephone company.
2. If this equipment causes harm to the telephone network, the telephone company may temporarily discontinue service. If possible, advance notification is given, otherwise, notification is given as soon as possible. The telephone company will advise the customer of the right to file a complaint with the FCC.
3. The telephone company may make changes in its facilities, equipment, operations, or procedures that could affect the proper operation of this equipment; advance notification and the opportunity to maintain uninterrupted service is given.
4. If experiencing difficulty with this equipment, please contact ADTRAN for repair and warranty information. The telephone company may require this equipment to be disconnected from the network until the problem is corrected, or it is certain the equipment is not malfunctioning.
5. This unit contains no user serviceable parts.
6. An FCC compliant telephone cord with a modular plug is provided with this equipment. In addition, an FCC compliant cable appropriate for the dial backup option ordered is provided with this equipment. This equipment is designed to be connected to the telephone network or premises wiring using an FCC compatible modular jack, which is Part 68 compliant.
7. The following information may be required when applying to the local telephone company for leased line facilities.

Service Type	Digital Facility Interface Code	Service Order Code	Network Jacks
ISDN	02IS5	6.0F	RJ-49C

FEDERAL COMMUNICATIONS COMMISSION RADIO FREQUENCY INTERFERENCE STATEMENT

This equipment has been tested and found to comply with the limits for a Class A digital device, pursuant to Part 15 of the FCC rules. These limits are designed to provide reasonable protection against harmful interference when the equipment is operated in a commercial environment. This equipment generates, uses, and can radiate radio frequency energy and, if not installed and used in accordance with the instruction manual, may cause harmful interference to radio frequencies. Operation of this equipment in a residential area is likely to cause harmful interference in which case the user will be required to correct the interference at his own expense.

Shielded cables must be used with this unit to ensure compliance with Class A FCC limits.

WARNING

Changes or modifications to this unit not expressly approved by the party responsible for compliance could void the user's authority to operate the equipment.

CANADIAN EMISSIONS REQUIREMENTS

This digital apparatus does not exceed the Class A limits for radio noise emissions from digital apparatus as set out in the interference-causing equipment standard entitled "Digital Apparatus," ICES-003 of the Department of Communications.

Cet appareil numérique respecte les limites de bruits radioélectriques applicables aux appareils numériques de Class A prescrites dans la norme sur le matériel brouilleur: "Appareils Numériques," NMB-003 édictée par le ministre des Communications.

CANADIAN EQUIPMENT LIMITATIONS

Notice: The Canadian Industry and Science Canada label identifies certified equipment. This certification means that the equipment meets certain telecommunications network protective, operational, and safety requirements. The Department does not guarantee the equipment will operate to the user's satisfaction.

Before installing this equipment, ensure that it is permissible to be connected to the facilities of the local telecommunications company. The equipment must also be installed using an acceptable method of connection. In some cases, the company's inside wiring associated with a single-line individual service may be extended by means of a certified connector assembly (telephone extension cord). Compliance with the above conditions may not prevent degradation of service in some situations.

Repairs to certified equipment should be made by an authorized Canadian maintenance facility designated by the supplier. Any repairs or alterations made by the user to this equipment, or equipment malfunctions, may give the telecommunications company cause to request the user to disconnect the equipment.

Users should ensure for their own protection that the electrical ground connections of the power utility, telephone lines, and internal metallic water pipe system, if present, are connected together. This precaution may be particularly important in rural areas.



Users should not attempt to make such connections themselves, but should contact the appropriate electric inspection authority, or an electrician, as appropriate.

The Load Number (LN) assigned to each terminal device denotes the percentage of the total load to be connected to a telephone loop which is used by the device, to prevent overloading. The termination on a loop may consist of any combination of devices subject only to the requirement that the total of the Load Numbers of all devices does not exceed 100.

Table of Contents

Chapter 1. Understanding ISDN and the ISU 2x64	1
ISDN Overview	1
The ADTRAN ISU 2x64.....	1
ISU 2x64 Interoperability	4
ISU 2x64 Single Port Operation.....	4
Recommended Operating Protocols.....	6
Chapter 2. ISDN Service	9
ISDN Ordering Codes	9
Chapter 3. Installation	13
Network Connection	13
DTE Data Connection	14
Maintenance interface.....	15
Dial Interface Connection	16
Chapter 4. Operation	17
Menu Navigation	17
Front Panel DTE Indicators	18
VT 100 Menu Support	19
Getting Started.....	19
Status Buffer.....	20
Status Screen.....	21
Configuration Screen.....	22
Chapter 5. Testing	23
Test Options	23
Loopback DTE	24
Loopback Network	24
Loopback Protocol	24
Loopback Remote.....	25
Test Remote.....	25
Loopback Disable.....	25
NEBE/FEBE.....	26

Table of Contents

Software Version	26
Loopback Both DTEs	26
Test 2047 Both	26
Chapter 6. Configuration	27
Dial Line Operation.....	27
Setting the Switch Protocol	28
Setting the Call Type.....	31
Speech	31
Audio	31
Data 56kbps.....	31
Data 64kbps.....	31
Smart Dial Strings	32
Setting the Terminal ID	32
Setting the SPID.....	32
Setting the LDN.....	33
Setting the Busy Out Port.....	33
Enabled	34
Disabled.....	34
Setting the Dial Options	34
Front Panel	34
RS-366	34
AT Commands	36
V.25.....	39
Disabled.....	42
Setting Auto Answer	42
Disabled.....	42
Enabled	43
Dump all calls.....	43
Setting Answer Tone.....	43
No Answer tone (Default)	44
Incoming tone	44
Outgoing tone.....	44
Always tone	44
Setting Connect Timeout.....	45
Setting Call Screening.....	45
SBus Termination	46
Leased Line Service.....	47
Clock Mode: Slave/Master	47
Channel Rate	48
SBus Termination	49
DTE Options for Asynchronous and Synchronous Operation.....	50
Bit Rate.....	51
Connector Type	51
RTS Options	51
CTS Options	51
CD Options	51
DTR Options	52

DSR Options	52
Flow Control (asynchronous data format).....	52
Data Format (asynchronous).....	53
Transmit Clock (synchronous data format)	53
Autobaud	54
Setting Protocol Options	55
Clear Channel.....	56
BONDING mode 1	56
TXINIT.....	57
TXFA.....	57
TXADD01.....	57
TXDEQ.....	58
TANULL	58
TCID	58
Async. Rev.	58
V.120	58
V.110	59
DSU 57.6 ASYNC.....	59
T-Link	59
SAP.....	59
FALLBACK.....	60
Point-to-Point (PPP) Async-to-Sync.....	61
Point-to-Point Protocol (PPP)	62
Multilink PPP	62
PPP with Compression	62
Chapter 7. Dial Options	63
Front Panel Dialing Options	63
Hang up line	64
Dial number	64
Redial last #.....	64
Answer Call	64
Dial stored #.....	64
Store/Review #	64
Chapter 8. Quick Setup	65
Quick Setup Configuration.....	65
Quick Setup	66
Dial 56K sync*	66
Dial 64K sync*	67
Dial 112K sync*	67
Dial 128K sync*	68
Dial 57.6 asyn*.....	68
Dial 115.2 asyn*	69
Fallback 57.6k*.....	69
Leased 64K	70
Ldm 64K Master.....	70
Factory Setup	71

Table of Contents

Chapter 9. Security and Remote Configuration	73
Security	73
Set Password	74
Lock Keypad	74
Remote Config	74
Cfg. Rmt. Unit	75
Set Password	75
Lpbk remote 1B	75
Lpbk remote 2B	75
Chapter 10. Troubleshooting.....	77
If Self Test Fails	77
If The ISU 2x64 Does Not Read Ready.....	77
If the Wrong DTE Port Answers a Call.....	83
If you Cannot Connect Calls.....	84
Chapter 11. Specifications	
Network Interface	85
DTE Interface	85
Dialing Selections.....	85
Data Rates (Network).....	85
Data Rates (DTE).....	86
B Channel Aggregation.....	86
Rate Adaptation	86
Interoperability.....	86
Switch Compatibility.....	86
Display.....	87
Environmental.....	87
Physical.....	87
Power.....	87
Appendix A. AT Commands.....	89
Appendix B. Current Status Messages	95
Appendix C. Status Buffer Messages	99
Appendix D. S-Register List.....	109
Appendix E. Connector Pinouts	119
Appendix F. Ordering ISDN Without IOCs	125
Acronyms	135
Glossary.....	137
Index	145

List of Figures

Figure 1-1:	ISU 2x64 Rear Panel	2
Figure 1-2:	ISU 2x64 Front Panel.....	4
Figure 1-3:	ISU 2x64 Interoperability	5
Figure 3-1:	VT 100 Maintenance Help Screen	15
Figure 4-1:	Current Status Menu.....	18
Figure 4-2:	VT 100 Status Screen	21
Figure 4-3:	VT 100 Configuration Screen.....	22
Figure 5-1:	VT 100 Test Menu Screen	23
Figure 5-2:	Test Menu Tree	24
Figure 5-3:	Loopback Points	24
Figure 6-1:	Dial Line Menu Tree	27
Figure 6-2:	VT 100 Configuration Menu Screen	28
Figure 6-3:	LCD Configuration Menu Tree	29
Figure 6-4:	Dial Options, RS-366 Menu Tree.....	35
Figure 6-5:	Dial Options, V.25 bis Menu Tree.....	39
Figure 6-6:	Dial Line, Auto Answer Menu Tree	40
Figure 6-7:	Data Bits Menu Tree.....	41
Figure 6-8:	V.25 bis ASYNC Menu Tree.....	41
Figure 6-9:	Answer Tone Menu Tree.....	44
Figure 6-10:	Connect Timeout Menu Tree.....	45
Figure 6-11:	Call Screening Menu Tree	45
Figure 6-12:	SBus Termination Menu Tree	46
Figure 6-13:	Leased Line Menu Tree	47
Figure 6-14:	Limited Distance Modem Applications	48
Figure 6-15:	Leased Application with Channel Banks.....	48
Figure 6-16:	Asynchronous DTE Options Menu Tree.....	50
Figure 6-17:	Synchronous DTE Options Menu Tree	50
Figure 6-18:	Flow Control Menu Tree	53
Figure 6-19:	Data Format Menu Tree	53

List of Figures

Figure 6-20:	Transmit Clock Menu Tree.....	54
Figure 6-21:	Protocol Menu Tree	55
Figure 6-22:	Protocol BONDING, Mode 1 Menu Tree	57
Figure 6-23:	PPP Menu Tree.....	61
Figure 7-1:	VT 100 Dial Options Screen.....	63
Figure 7-2:	Dial Menu Tree	63
Figure 8-1:	Quick Setup Menu Tree	65
Figure 9-1:	Security Menu Tree	73
Figure 9-2:	Remote Config Menu Tree	74
Figure E-1:	EIA-232 Interface	119
Figure E-2:	RS-530 Interface.....	120
Figure E-3:	V.35 Interface.....	120
Figure E-4:	RS-366 Interface.....	121
Figure E-5:	RJ-45 Dial Line Connector U Interface	122

List of Tables

Table 1-A:	DTE Indicators	3
Table 1-B:	Recommended Operating Modes	7
Table 6-A:	Rate Adaptation Protocols	60
Table 10-A:	Troubleshooting Calls.....	84
Table E-A:	EIA-232 Interface	119
Table E-B:	RS-530 Interface	120
Table E-C:	V.35 Interface.....	121
Table E-D:	RS-366 Interface	122
Table E-E:	RJ-45 Dial Line Connector U Interface	122
Table E-F:	RJ-45 Dial Line Connector S/T Interface	123
Table E-G:	Maintenance Connector.....	123
Table F-A:	5ESS Features	131
Table F-B:	DMS Features	132

List of Tables

Chapter 1

Understanding ISDN and the ISU 2x64

ISDN OVERVIEW

The Integrated Services Digital Network (ISDN) is a public or private *switched digital* network. ISDN is an international standard for digital communications, allowing a full range of enhanced services supporting voice, data, and image applications through standard interfaces over a single pair of telephone wires. ISDN provides a means of integrating these services and modernizing communication networks for information movement and management efficiency.

THE ADTRAN ISU 2X64

ADTRAN's ISU™ 2x64 is a stand-alone ISDN service unit that connects data terminal equipment to the ISDN network. The ISU 2x64 is a dual-port ISDN terminal adapter available with an optional integrated NT1. The ISU 2x64 supports two applications at data rates of up to 64 kbps on each DTE interface, or one application using a data rate greater than 64 kbps (maximum 128 kbps) on a single DTE interface. Target applications for the ISU 2x64 include video conferencing, audio broadcasting, and as dual modem replacement.

The ISU 2x64 features two RS-530/EIA-232 DTE interfaces and two RS-366 dial interfaces (see Figure 1-1). An RS-530/EIA-232-to-V.35 adapter is available to support V.35 DTE interfaces. Synchronous data transfer rates from 2400 bps to 128 kbps and asynchronous rates from 1200 bps to 115.2 kbps are supported on a single DTE interface. Synchronous data transfer rates from 2400 bps to 64 kbps and asynchronous rates from 1200 bps to 57.6 kbps are supported when using two DTE interfaces. For speeds over 64 kbps using a single DTE interface, the industry standard BONDING protocol aggregates the two 64 kbps B channels for a maximum of 128 kbps.

Dialing from the ISU 2x64 is accomplished in a variety of ways:

- Dialing manually from the front panel
- Dialing automatically from stored numbers
- Dialing through two RS-366 parallel dial interfaces (as in video conferencing applications)
- Dialing over the DTE interfaces using AT command
- V.25 bis in-band dialing (used in applications such as LAN/WAN bridging)
- Dialing when DTR is asserted (some Bridge/Routers raise DTR when bandwidth on their dedicated line is exceeded)

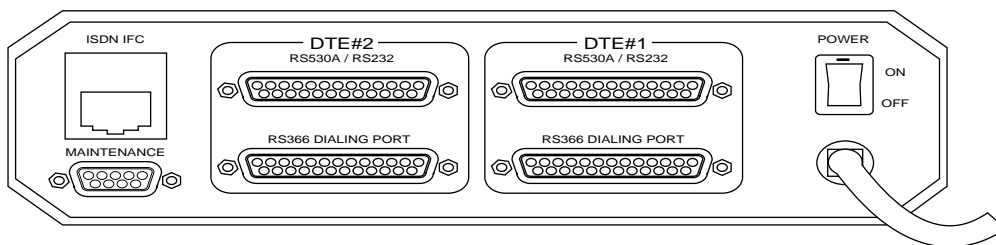

Figure 1-1
ISU 2x64 Rear Panel

The ISU 2x64 allows the user to migrate ISDN into existing network services and data communications equipment. The ISU 2x64 interoperates with ISU 128s, Switched 56 DSUs, various ISDN terminal adapters, and BONDING inverse multiplexers (for example ASCEND®, PROMPTUS, and Teleos®). For instance, in a video conferencing application, this compatibility allows the ISU 2x64 to interoperate with networks utilizing two Switched 56 DSUs.

The ISU 2x64 front panel accommodates a 2-line by 16-character LCD display. Seven LED indicators monitor data flow and display the status of key DTE interface leads (see Table 1-A and Figure 1-2). A front panel keypad supports configuration, test modes, test status, and dialing.

Table 1-A
DTE Indicators

Indicator	Definition
RS	Request to Send. Indicates the DTE is ready to transmit.
CS	Clear to Send. Indicates the ISU 2x64 is ready to transmit.
TD	Transmit Data. On when the DTE is transmitting to the ISU 2x64.
RD	Receive Data. On when the ISU 2x64 is receiving data from the far end.
CD	Carrier Detect. On when the ISU 2x64 is connected to a remote unit.
TR	Data Terminal Ready from DTE. On when DTR is active at DTE interface.
SR	Data Set Ready.

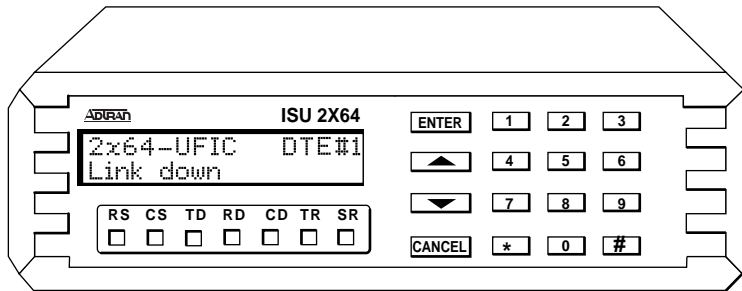

Figure 1-2
ISU 2x64 Front Panel

ISU 2X64 INTEROPERABILITY

Telephone networks are evolving from analog technologies to digital technologies such as ISDN. This transition is time-consuming and costly for the telephone companies and upgrading all locations and facilities is a lengthy process.

The ISU 2x64 bridges this transition by supporting communications with existing and future network services and equipment. The ISU 2x64 supports communications with Switched 56 Service and Switched 56 DSUs (2-wire and 4-wire) as well as various ISDN terminal adapters, ISDN terminal equipment, and BONDING-compatible Inverse Multiplexers.

Figure 1-3 illustrates the ISU 2x64 operation in various switched network services and customer premises products.

ISU 2X64 SINGLE PORT OPERATION

The ADTRAN ISU 2x64 is designed to operate over multipoint ISDN lines in North America that will require two Service Profile Identification (SPID) numbers from the telephone company when the ISDN lines are installed. These SPID numbers tell the ADTRAN ISU 2x64 which port or DTE# to route incoming and outgoing calls. See *Ordering ISDN Without IOCs* on page 125 for further details on ordering multipoint ISDN service.

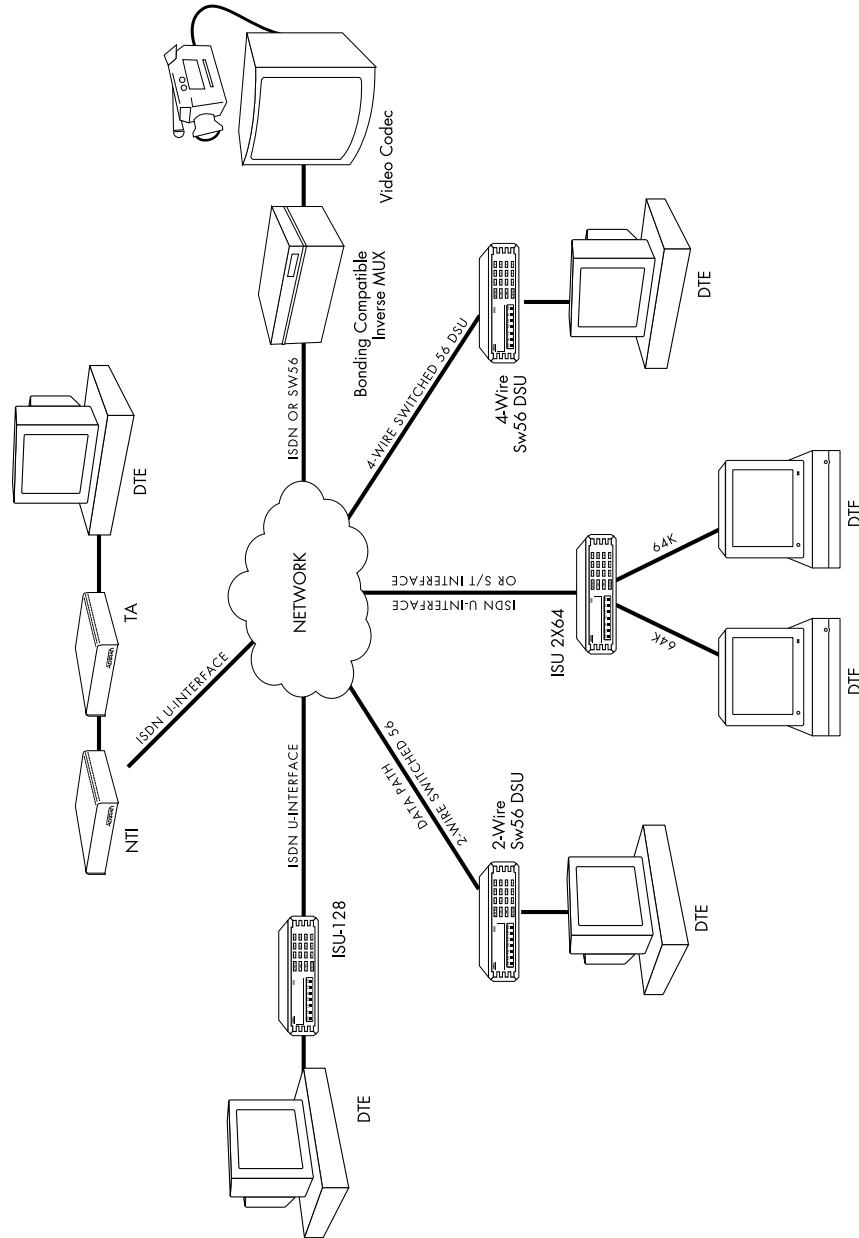

Figure 1-3
ISU 2x64 Interoperability

When the ISU 2x64 is used on an existing ISDN line that is not multipoint, with one SPID or no SPID numbers, additional considerations should be addressed. If DTE specific operation is desired, the ISDN line must be converted to multipoint operation (2 SPIDS). If not, the following applies:

1. If a single SPID is assigned, it must be entered under SPID **DTE#2**
2. When no calls are active, the first incoming call is always directed to **DTE#2**
3. **DTE#1** only accepts incoming calls when a call is active on **DTE#2**
4. Outgoing calls can be placed without restrictions from either port.

For applications involving only one SPID being used on a multipoint line, the SPID assigned must be entered under SPID **DTE#2**. For applications involving the S/T version (part number 1200.051L5 and 1200.051L6), no SPID(s) are used when the Euro ISDN or VN4 switch type is selected. The call will be routed to the appropriate port based on the directory number entered under the local directory number (LDN) prompt. See the section *Setting the Terminal ID* on page 32 for more detail on entering SPID numbers.

RECOMMENDED OPERATING PROTOCOLS

The ISU 2x64 supports a wide range of operating modes. Many combinations of circuit type, protocol, and data rate may be selected. However, only the combinations shown in Table 1-B are recommended. As noted in Table 1-B, all asynchronous rates support flow control. Flow control is required when operating at 115200 bps using V.120, PPP, MLPPP, SAP, or BONDING protocols.

Table 1-B shows that a given data rate may be achieved by more than one protocol/rate adaptation selection. The table is organized so that selections with lower throughput delay are nearer the top of the table for any given circuit type. Therefore, users should choose a protocol and rate nearer the top of the list for any given circuit type.

Table 1-B
Recommended Operating Modes

Call Type	Protocol	Sync/ Async	Rates Supported (bps)									
			56000	64000	64000							
DIAL-64K	BONDING	Sync	56000	64000								
	Clear Chan	Sync	48000	56000	64000							
	PPP	Sync	2400	4800	9600	19200	38400	56000	64000			
	V.110	Sync	2400	4800	9600	19200	38400					
	V.120	Sync	9600	19200	38400	48000						
	Tlink	Sync	2400	4800	9600	19200	56000	64000				
	SAP	Sync	38400									
	PPP async-sync	Async	1200	2400	4800	9600	19200	38400	57600	115200f		
	BONDING	Async	2400	4800	9600	19200	38400	57600				
	V.110	Async	1200	2400	4800	9600	19200	38400v				
	V.120	Async	1200	2400	4800	9600	19200	38400	57600	115200f		
	Tlink	Async	1200	2400	4800	9600	19200					
	SAP	Async	38400	57600	115200f							
	DIAL-56K	BONDING	Sync	56000								
Clear Chan		Sync	48000	56000								
PPP		Sync	2400	4800	9600	19200	38400	56000				
V.110		Sync	2400	4800	9600	19200						
V.120		Sync	9600	19200	38400	48000						
TLINK		Sync	2400	4800	9600	19200	56000					
PPP async-sync		Async	1200	2400	4800	9600	19200	38400	57600	115200f		
BONDING		Async	2400	4800	9600	19200	38400	57600				
DSU 57.6		Async	57600									
V.110		Async	1200	2400	4800	9600	19200					
V.120		Async	1200	2400	4800	9600	19200	38400	57600	115200f		
Tlink		Async	1200	2400	4800	9600	19200					
DIAL-64K*2		BONDING	Sync	128000								
		MPPP	Sync	128000								
	MPPP	Async	115200									
	BONDING	Async	115200									
DIAL-56K*2	BONDING	Sync	112000									
	MPPP	Sync	112000									
	MPPP	Async	115200									
	BONDING	Async	115200									
LEASED 64K	Clear Chan	Sync	48000	56000	64000							
	SAP	Sync	2400	4800	9600	19200	38400					
	DSU 57.6	Async	57600									
	SAP	Async	1200	2400	4800	9600	19200	38400	57600f	115200f		
LEASED 128K	Clear Chan	Sync	128000									
	SAP	Async	57600f	115200f								



1. *All asynchronous rates support flow control.*
2. *All dial-up modes support front panel, DTR, RS-366, AT command, and V.25 dialing methods.*
3. *Rates marked with *f* require flow control.*
4. *Given a choice between two protocols, pick the protocol closer to the top of the list.*
5. *Rate marked with *v* is available on Port 2 only.*

Chapter 2

ISDN Service

ISDN ORDERING CODES

ISDN is a complex service with many network options. Obtaining service from the local telephone company and long distance providers can be complicated.

In North America, the development of ISDN ordering codes (IOCs) simplifies the process of ordering ISDN service. The ISDN Solutions Group, a consortium of ISDN equipment vendors, service providers, and Bellcore, established these codes to represent predetermined line configurations for ISDN Basic Rate service for specific applications.

ADTRAN and Bellcore have registered and tested eight generic IOCs. These IOCs are supported by all major local exchange carriers as well as several independent carriers. After reviewing the following list, order ISDN lines from the local service provider. Request the appropriate IOC for your application. If the local service provider does not support IOCs, see *Ordering ISDN Without IOCs* on page 125.

Capability S (previously **Generic Data M**) ordering code is recommended for 2x64 applications. It is the most feature-rich and supports most voice and data applications. The voice capability is not necessary for ISU operation in 2x64 in data-only application, however it is useful in troubleshooting a mis-configured ISDN line. In some areas, ISDN tariffs may warrant the use of ordering codes with less features. For example, in a particular region, there may be additional monthly expense associated with having voice service on each B channel. If you have a data-only

application, then **Capability R** (previously **Generic Data I**) may be more cost-effective.

ADTRAN has registered the following ISDN ordering codes to support a variety of tariffs and applications:

Capability S (previously Generic Data M)

- 2B service
- Both B channels alternating voice and data
- Two directory numbers

Applications

- Host data center, internet access, bulletin board, and modem pooling applications
- Modem capability
- Generic data transfer, including remote access and LAN/WAN connectivity and telecommuting

Capability R (previously Generic Data I)

- 2B service
- Data only
- Two directory numbers

Applications

- Host data center, internet access, bulletin board, and modem pooling applications
- Data only applications, no modem capability
- Data transfer applications, including remote access and LAN/WAN connectivity, telecommuting

B1 (previously Generic Data B)

- 1B service
- Data only
- One directory number

Capability C (previously Generic Data C)

- 1B service
- Alternating voice and data
- One directory number

I2 (previously Generic Data I-1DN)

- 2B service
- Data only
- One directory number



*I2 is not available for services provided by a Northern Telecom switch. Two directory numbers are required for 2B operation. In this case, use **Capability R**.*

J3 (previously Generic Data J-1DN)

- 2B service
- 1B alternating voice/data, 1B data only
- One directory number



*J3 is not available for services provided by a Northern Telecom switch. Two directory numbers are required for 2B operation. In this case, use **J2**.*

J2 (previously Generic Data J)

- 2B service
- 1B alternating voice/data, 1B data only
- Two directory numbers

M5 (previously Generic Data M-1DN)

- 2B Service
- 1B alternating voice/data, 1B data only
- One directory number



M5 is not available for services provided by Northern Telecom or AT&T switches.

Chapter 3

Installation

After unpacking the unit, immediately inspect it for possible shipping damage. If damage is discovered, file a claim immediately with the shipping carrier, then contact ADTRAN Technical Support.

Each ISU 2x64 is provided with an eight-foot power cord terminated by a three-prong plug which connects to a grounded power receptacle.

ADTRAN ISU 2x64 part numbers 1200051L1, 1200051L2, and 1200051L5 require a grounded 115 VAC, 60 Hz receptacle for power.

ADTRAN ISU 2x64 part numbers 1200051L3, 1200051L4 and 1200051L6 require a 230 VAC, 50 Hz receptacle for power.

NETWORK CONNECTION

An eight-pin RJ-45 modular jack on the rear panel of the ISU 2x64 allows connection to ISDN Basic Rate service provided by the telephone company or to a leased type of service. This leased service can be dedicated 2B1Q data service or a nailed-up circuit that provides a dedicated connection between end points such as a limited distance modem or LAD circuit.

If using ISU 2x64, part number 1200051L1 or 1200051L3, connect the telephone company provided ISDN Basic Rate U-Interface to the RJ-45 connector marked ISDN IFC. An external NT1 is not needed in this configuration.

If using ISU 2x64, part number 1200051L2, 1200051L4, 1200051L5, or 1200051L6, connect an ISDN Basic Rate S/T interface to the RJ-45 connector marked ISDN IFC. The S/T interface can be provided from an S/T line card of an ISDN switch or PBX, or from an NT1 network termination unit.

If using a leased service, connect the network interface to the RJ-45 connector marked ISDN IFC.

See *Connector Pinouts* on page 119 for network connection pin assignments.

DTE DATA CONNECTION

Data terminal equipment (DTE) is connected to the ISU 2x64 by using the RS-530/EIA-232 interfaces or by using the external RS-530-to-V.35 adapters (part number 1200072L1). A maximum cable length of 50 feet is recommended for the RS-530/EIA-232 interfaces. If using the RS-530-to-V.35 adapter and connected to a full specification V.35 interface, the maximum recommended cable length is 15 feet. The pin assignments for the DTE interfaces are shown in *Connector Pinouts* on page 119. Be sure to configure the menu option for the connector type used in your application. See *DTE Options for Asynchronous and Synchronous Operation* on page 50.

The RS-530/EIA-232 interface and the RS-530-to-V.35 interface supports data rates up to 128 kbps. The DTE rate is configured from the front panel of the ISU 2x64 or by using AT commands. See *Configuration* to configure the ISU 2x64 with the appropriate data rates for your application.



To prevent possible radio frequency interference emissions, a shielded V.35 cable is required.

MAINTENANCE INTERFACE

The Maintenance interface is available at 9600 bps, 8 data bits, no parity, no flow control, asynchronous format through the Maintenance port. See *Connector Pinouts* on page 119 for the pinout of the Maintenance port. A VT 100 terminal or null modem can be connected to the Maintenance port using an EIA-232 cable. This interface can be used to set internal S-registers, dial ISDN connections, and disconnect calls. This port also allows ADTRAN Technical Support personnel to retrieve vital information from the unit if a problem is encountered during initial configuration of the ISU 2x64. Most problems can be solved without resorting to this port for assistance.

The ISU 2x64 Maintenance Help Screen can be activated by typing `!?` at either the DTE#1 or DTE#2 prompt. The screen is shown in Figure 3-1.

```
--dte#2-->!?  
.....Maintenance Port HELP.....  
  
1. Use AT commands without the 'at' prefix.  
2. Choose from the following Commands:  
   !P - Selects DTE#2 Prompt.  
   !S - Selects DTE#1 Prompt.  
   !B - Dumps Front Status Buffer  
   !L - Dumps Internal Printf Buffer  
   !U - UT100 Terminal  
   !? - Show Help.  
  
--dte#2-->_
```

Figure 3-1
VT 100 Maintenance Help Screen

DIAL INTERFACE CONNECTION

If out-of-band RS-366 dialing is required for applications such as videoconferencing or FAX machines, the dialing interfaces of the host DTE should be connected to the dial ports marked RS-366. Pin assignments for the RS-366 connector are listed in the appendix, *Connector Pinouts*.

Chapter 4

Operation

MENU NAVIGATION

Moving through the various menu selections on the ISU 2x64 is a simple task. Four function keys on the left-hand side of the keypad allow the user to enter, exit, and scroll through the various menu branches. The four function keys are defined below.



To aid the reader, function keys are represented in bold, initial caps text. Selectable menu items and messages displayed on the LCD are represented in bold type as they appear on the LCD.

Enter	Enters the selected item.
Up arrow	Scrolls up a menu tree.
Down arrow	Scrolls down a menu tree.
Cancel	Exits (back one level) from the current branch of the menu.

Press either the Up or Down arrow to scroll through the menu tree. To choose an item, press the corresponding number on the keypad. The item blinks to show it is selected. Press **Enter** to select the item. Press **Cancel** to exit back through the menu tree.

It is important to note that some features in the ISU 2x64 do not immediately take effect upon selection. This prevents unintentional reconfiguration of the ISU 2x64 during an active call. **S-BUS termination** takes effect only when the unit is powered up. To ensure the ISU is actually performing as configured, cycle the power off then back on again, especially after changing **ISDN**

switch type, SPIDs, LDNs, or Leased/dial line. Also, items such as bit rate, protocol, and call type take effect only at the beginning of a new call.

Front Panel DTE Indicators

The front panel DTE indicators (see Figure 4-1) reflect the status of each DTE port on the ISU 2x64. The indicators show the current state of the port being displayed from the **Current Status** menu. To change the DTE indicators between the two DTE ports, use the Up and Down arrow keys to bounce between the two DTE ports **Current Status** menus. Once this menu is exited, the DTE indicators reflect the status of the DTE# that was last shown. See *Table 1-A* on page 3 for a listing of the front panel DTE indicators.

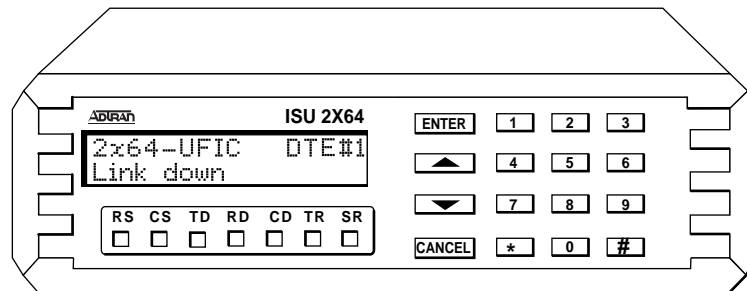

Figure 4-1
Current Status Menu

The ISU 2x64 automatically updates the Current Status menu to the DTE# that is receiving an incoming call. For example, if the **Current Status** menu shows the state of DTE#1, and a call is incoming on DTE#2, the ISU 2x64 automatically changes the display to show the **Current Status** menu for DTE#2. Change this by using the Up and Down arrow keys to select either DTE.

VT 100 Menu Support

When connected to an asynchronous VT 100 terminal or VT 100 terminal emulator, use the built-in ISU 2x64 menu system for configuration of both DTE ports. The VT 100 screens can be activated by typing **AT!V** while connected to either DTE port (in AT command mode), or by typing **!V** at the prompt while using the maintenance port. The maintenance port is an asynchronous port always set to 9600 bps, 8 data bits, one stop bit, no parity, and no flow control. By using the VT 100 screens on the maintenance port, both DTE ports can be configured from one terminal. The command **Ctrl+P** switches between DTE #1 and DTE #2.

GETTING STARTED

At power up, the ISU 2x64 runs a self test as indicated on the display. After approximately 10 seconds, **Passed** is momentarily displayed (if the ISU 2x64 does not pass the self test, see *If Self Test Fails* on page 77). This is followed by the **Current Status** mode of **DTE#1**. The **Current Status** mode **DTE#2** is shown by pressing either arrow key. This is the recommended resting place for the unit since it shows the current operational status of the unit. For instance, if the ISU 2x64 is not connected to the network, the Current Status menu displays **ISU 2x64 DTE# (1 or 2) Link down**. If the unit is connected to the network and functioning properly, it displays **ISU 2x64 DTE# (1 or 2) Ready**. A list of Current Status messages is provided in *Current Status Messages* on page 95. Pressing the **Cancel** key repeatedly returns the unit to the Current Status menu. While at the Current Status menu, pressing any key, except the **Cancel** and # keys, repeatedly changes the display to the top of the menu tree. Pressing the # key brings up the **Dial** submenu. While in a menu tree, pressing the # key causes the unit to return to the **Current Status** menu.

The menu tree allows for set up and operation of the ISU 2x64 from the front panel. The main branches of the menu tree follow:

1. **STATUS**
2. **TEST**
3. **CONFIG (Configuration)**
4. **DIAL**

Status Buffer

Selecting **1=STATUS** from the top of the menu tree displays the contents of the status buffer. The Up and Down arrow keys allow the viewing of the last fifty status messages generated during the operation of the unit. (An explanation of Status Buffer Messages can be found in *Status Buffer Messages* on page 99). Pressing the **Cancel** key returns you to the top of the menu. Pressing the **0** key will clear the entries from the status buffer.

Status Screen

To determine the current status of the unit, press **Ctrl+V** to access the Status Screen (see Figure 4-2). The Status Screen displays unit information such as the loop status, software revision, the result of the initial self test, and the status buffer messages. (An explanation of status buffer messages can be found in *Status Buffer Messages* on page 99.)

```

ISU 2X64-UIFC dte #2 Status Menu
UNIT/LOOP STATUS          STATUS BUFFER
Call Type                 = Data 64Kbps      1 = EMPTY
DTE Rate                  = 64000           2 = EMPTY
DTE Format                  = Synchronous    3 = EMPTY
Test Status                = No Test        4 = EMPTY
Self Test                 = Passed          5 = EMPTY
Software Rev               = D.01           6 = EMPTY
Checksum                   = c076 38f6     7 = EMPTY
Loop Status                = Link down      8 = EMPTY
Num Dialed                 = No Call        9 = EMPTY
RTS                        = Off           10 = EMPTY
CTS                        = On            11 = EMPTY
DCD                        = Off           12 = EMPTY
DTR                        = Off           13 = EMPTY
DSR                        = On            14 = EMPTY
                           15 = EMPTY
                           16 = EMPTY
                           17 = EMPTY
                           18 = EMPTY
                           19 = EMPTY
                           20 = EMPTY
-----
Ctl-P PORT  Ctl-V STATUS  Ctl-T TEST  Ctl-C CONFIG  Ctl-D DIAL  Ctl-X EXIT

```

Figure 4-2
VT 100 Status Screen

Configuration Screen

Once the unit is selected using the terminal interface, the display shows the Configuration Menu (see Figure 4-3). This screen shows the current configuration, line, and call status for the selected unit. See *Configuration* on page 27 for more information about configuring the ISU 2x64.

```

ISU 2X64-UIFC dte #2 Configuration Menu
1) Netw. options = Dial Line      17) CTS Options = Forced CTS
2) Switch Protocl = AT&T 5ESS    18) CD Options = Normal
3) Call type = Data 64Kbps      19) DTR Options = Ignore DTR
4) SPID DTE 2 =                20) DSR Options = DSR forced on
5) LDN DTE 2 =                 21) Transmit Clock = Normal
6) BusyOut Port = Disabled      22) Protocol = Clear Channel
7) Dial options = Front Panel   23) Quick setup
8) Auto answer = Enabled        24) Set Password
9) Answer tone = No Answer tone 25) Lpbk remote 1B
10) Connect Timeout = 30 sec (def) 26) Lpbk remote 2B
11) Call Screening = Answer any
12) SBus Termination = 100 ohm Off
13) DTE options = Synchronous
14) Bit Rate = 64000
15) Connector Type = RS-232
16) RTS Options = 1 ms delay

Select = _                      Enter SELECT      Esc NO CHANGE

Cti-P PORT  Cti-V STATUS  Cti-T TEST  Cti-C CONFIG  Cti-D DIAL  Cti-X EXIT

```

Figure 4-3
VT 100 Configuration Screen

To quickly and easily configure the ISU 2x64 for most applications, see *Quick Setup* on page 65.

Chapter 5

Testing

TEST OPTIONS

Selecting **2=TEST** from the top of the menu tree (Figure 5-2) or **Ctrl + T** from any VT 100 screen displays available local testing options; this screen is shown in Figure 5-1.

```
ISU 2X64-UIFC dte #2 Test Menu
1> Loopback DTE
2> Loopback Netw.
3> Loopback Proto
4> Loopback Remot
5> Test Remote
6> Lpbk Disable = No Rem Lpbks
7> NEBE/FEBE
8> Lpbk Both DTEs

Select =                               Enter SELECT   Esc NO CHANGE

CtI-P PORT  CtI-V STATUS  CtI-T TEST  CtI-C CONFIG  CtI-D DIAL  CtI-X EXIT
```

Figure 5-1
VT 100 Test Menu Screen

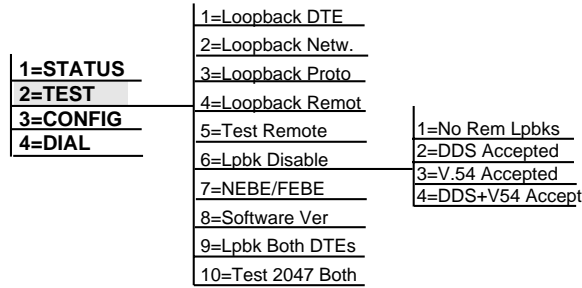

Figure 5-2
Test Menu Tree

Loopback DTE

This test causes the DTE port to loop back toward user equipment. This allows a bit error rate test (BERT) to be performed from the local end-user equipment to the ISU 2x64 to verify proper cable connection, etc. Either a BERT tester or DTE data packet test must be used for this test.

Loopback Network

This test forces the ISU 2x64 to loop back both the B1 and B2 channels toward the network. This can be used to allow a far-end user to perform a BERT all the way through the network.

Loopback Protocol

This test causes data to be looped back toward the network after passing through a selected protocol such as T-Link or BONDING. See Figure 5-3 for loopback points.

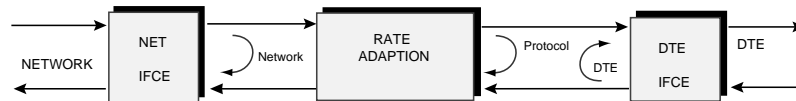

Figure 5-3
Loopback Points

Loopback Remote

This test causes the ISU 2x64 to issue a V.54 inband loopback command to a far-end unit. External test equipment must be used to generate/check test patterns. To use this feature, both units must be configured for Clear Channel operation and the far-end unit must be able to respond to V.54 loopback commands. See *Setting Protocol Options* on page 55 to configure the unit for Clear Channel operation. Press **Cancel** to end the test.

Test Remote

This test causes the ISU 2x64 to issue a V.54 inband loopback command to a far-end unit and BERT test the link using a built-in pattern generator/checker. This allows a circuit to be tested without any extra test equipment. To use this feature, both units must be configured for Clear Channel operation and the far-end unit must be able to respond to V.54 loopback commands. See the section *Setting Protocol Options* to configure the unit for Clear Channel operation. The built-in 2047 pattern generator/checker displays the number of bytes transmitted on the top line and the number of errored bytes received on the lower line of the front panel display. Pressing **0** will clear the counts. Pressing the **Cancel** key ends the test. Pressing the down arrow will loop down the remote unit, allowing a test to a loopback plug. Pressing **2** will insert errors.

Loopback Disable

The following options are available in Loopback Disable.

No Rem Lpbks: The ISU 2x64 ignores all V.54 and DDS loopback commands.

DDS Accepted: The ISU 2x64 responds to DDS latching loopback commands. This option only takes effect if the unit is in Leased Line mode.

V.54 Accepted: The ISU responds to V.54 loopback commands.

DDS+V54 Accept: The ISU 2x64 responds to both DDS latching loopback commands (Leased Line mode only) and V.54 loopback commands.



The ISU 2x64 must be optioned for Clear Channel operation for DDS and V.54 loopbacks to take effect.

NEBE/FEBE

This test reports the quality of the network connection between the T-1 and the switch by viewing the number of near-end block errors (NEBE) and far-end block errors (FEBE) occurring on the ISDN interface. An incrementing count in NEBE means the problem is in the direction of the NT-1. An incrementing count in FEBE means the problem is in the direction of the switch.

Software Version

This test determines the software version in use on the ISU 2x64.

Loopback Both DTEs

Choosing this option loops back both DTE ports simultaneously.

Test 2047 Both

Choosing this option is similar to Test Remote, except both ports are tested simultaneously.

Press **Cancel** to exit any of these options.

Chapter 6 Configuration

DIAL LINE OPERATION

This section explains how to configure the ISU 2x64 when using ISDN Basic Rate switched service. Figure 6-3 illustrates the entire menu tree.

The following are step-by-step procedures for configuring the unit for dial line operation, switch protocol, call type, terminal ID, dial options, auto answer, answer tone, connect timeout, call screening, and SBus termination.

To dial calls over the ISDN, the unit must be configured for **Dial Line**. The menu path to select Dial Line operation is shown in Figure 6-1.

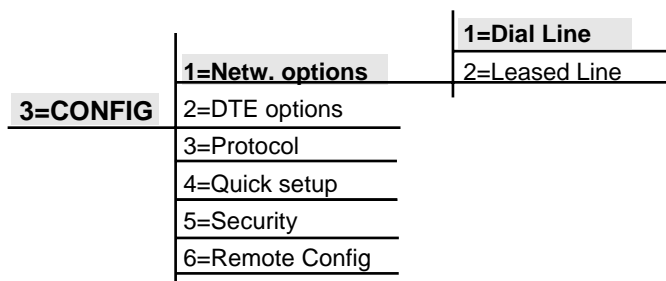

Figure 6-1
Dial Line Menu Tree

When using a VT 100 terminal, press **Ctrl + C** to access the Configuration screen, then set the **Line type** option to **Dial Line**. The screen appears as shown in Figure 6-2.

```

ISU 2X64-UIFC dte #2 Configuration Menu
1) Netw. options = Dial Line          17) CTS Options = Forced CTS
2) Switch Protocol = AT&T 5ESS       18) CD Options = Normal
3) Call type = Data 64Kbps           19) DTR Options = Ignore DTR
4) SPID DTE 2 =                      20) DSR Options = DSR forced on
5) LDN DTE 2 =                       21) Transmit Clock = Normal
6) BusyOut Port = Disabled           22) Protocol = Clear Channel
7) Dial options = Front Panel        23) Quick setup
8) Auto answer = Enabled             24) Set Password
9) Answer tone = No Answer tone     25) Lpbk remote 1B
10) Connect Timeout = 30 sec (def)   26) Lpbk remote 2B
11) Call Screening = Answer any
12) SBus Termination = 100 ohm Off
13) DTE options = Synchronous
14) Bit Rate = 64000
15) Connector Type = RS-232
16) RTS Options = 1 ms delay

Select = _                               Enter SELECT   Esc NO CHANGE

Cti-P PORT  Cti-V STATUS  Cti-T TEST  Cti-C CONFIG  Cti-D DIAL  Cti-X EXIT

```

Figure 6-2
VT 100 Configuration Menu Screen

Setting the Switch Protocol

Find out what kind of ISDN switch the local CO is using by asking the telephone administrator or telephone company representative. Configure the ISU 2x64 for either Northern Telecom DMS-100, AT&T 5ESS, or a switch conforming to the National ISDN-1 standard (usually an AT&T 5ESS, NT DMS-100, or Siemens EWSD). For switches outside of North America, use the Euro ISDN, VN4, TDX10, TDX1B, KDD, NTT, or NEC switch types.

Chapter 6. Configuration

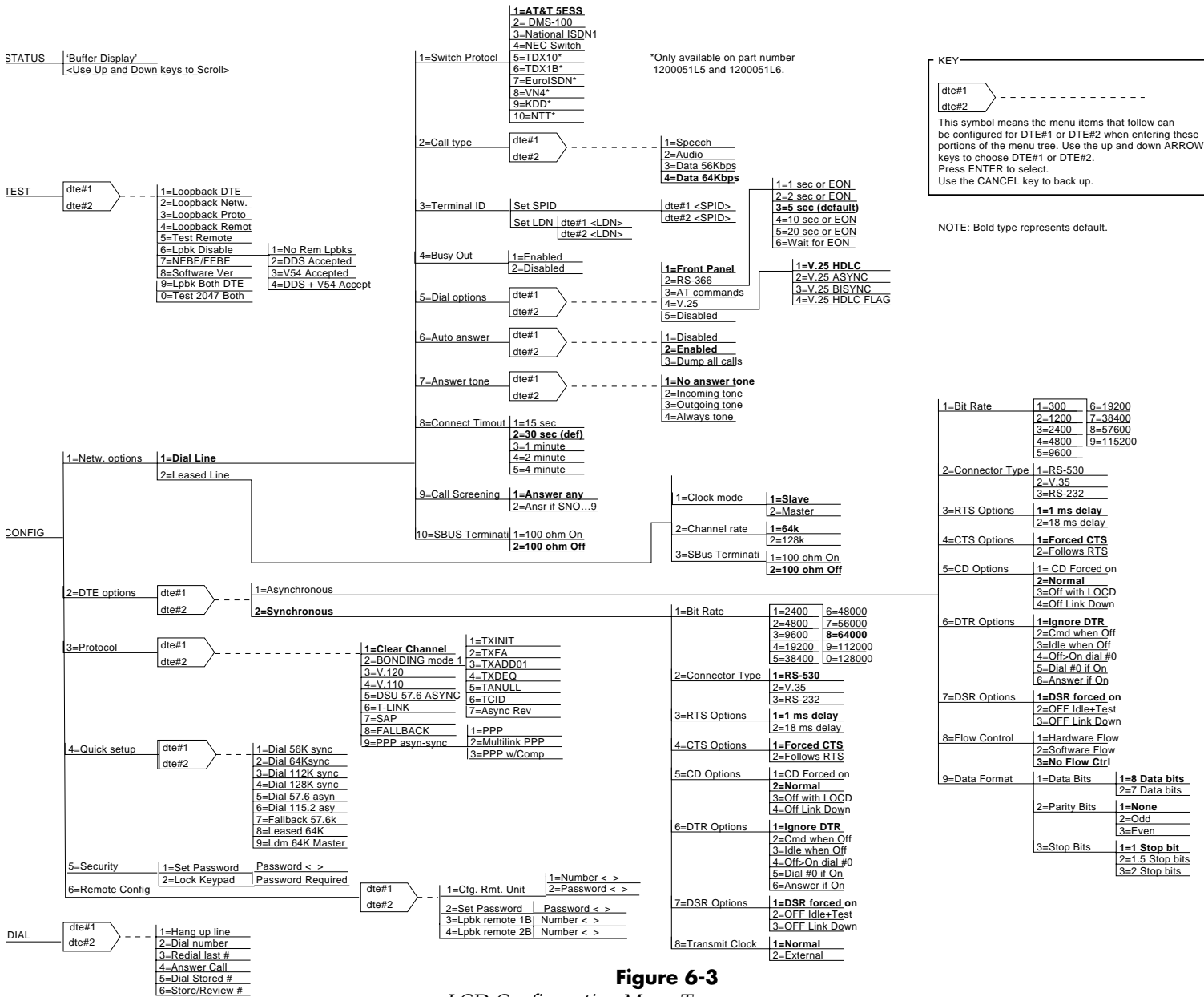

Figure 6-3
 LCD Configuration Menu Tree

Setting the Call Type

Call type is configured for both **DTE#1** and **DTE#2**. When using the front panel, select the appropriate DTE with either arrow key and press **Enter**. When using a VT 100 terminal, select the option number corresponding to the appropriate DTE and press **Return**.

The **Call type** can be configured four different ways, depending on the type of service used: **Speech**, **Audio**, **Data 56 kbps**, or **Data 64 kbps**.

Speech

Speech directs the call control software to request a Mu-law (or A-law) speech circuit as the bearer capability for outgoing calls. The **Speech** option is used with an ISDN line configured for voice service. In some areas voice service is less expensive than data service. A **Speech** call type does not guarantee an end-to-end digital connection with some local and long distance carriers.

Audio

Audio directs the call control software to request a 3.1 kHz audio circuit as the bearer capability for outgoing calls. The **Audio** option is used with an ISDN line configured for voice service. In some areas audio service is less expensive than data service. Selecting **Audio** guarantees a digital end-to-end ISDN connection.

Data 56kbps

Data 56kbps directs the call control software to request a 64 kbps data circuit that is rate-adapted to 56 kbps. **Data 56 kbps** is intended for use in circumstances where interoperability with Switched-56 service is desired.

Data 64kbps

The default **Call type** for ISDN service is **Data 64 kbps**. This directs the call control software to request an unrestricted 64 kbps circuit.

Smart Dial Strings

In some cases during a dial session it may be desired to change the call type temporarily. At the end of a dialed phone number, a #1,2,3, or 4 can be used to change the call type. A #1 changes it to speech, #2 to Audio, #3 to 56K, and #4 to 64K.

Setting the Terminal ID

Terminal identification is assigned by the local telephone company and consists of a SPID and LDN number.

Setting the SPID

In North America, the SPID is a sequence of digits used to identify ISDN terminal equipment to the ISDN switch. The SPID is assigned by the local phone company when the ISDN line is installed and usually looks similar to the phone number. Obtain the SPIDs from the telephone administrator or local telephone representative. The number of SPIDs required (0, 1, or 2) depends on how the ISDN line is configured. For instance, a point-to-point line has no SPID. Multipoint lines may have one or two SPIDs. If the line has only one SPID, then it must be entered in SPID DTE#2. It is recommended to use two SPIDs with the ISU 2x64, with a SPID assigned to each DTE port.

When entering a SPID using the front panel, use the Up and Down arrow keys to select between **SPID DTE#1** and **SPID DTE#2**. Press **Enter** to select the DTE. Use the keypad to enter the SPID. While keying/editing a SPID, the Down arrow allows backspacing through the number string to correct mistakes. The Up arrow scrolls back to the last digit entered. After entering each SPID, press **Enter**. To abort changes at any time, press **Cancel**. The changes are discarded, leaving the original number unchanged. If entering the SPID using the VT 100 terminal, select the option number corresponding to the appropriate DTE and press **Return**. Enter the number using the keyboard and press **Return** to store the number.



Disconnect the network interface from the unit before initially entering and/or altering the SPIDs or LDNs.

Setting the LDN

This option allows the entry of 0, 1, or 2 LDNs. The LDN is used when receiving BONDING calls or receiving separate calls for each DTE connection. The LDN is the seven-digit local phone number assigned to the line.

When entering an LDN using the front panel, use the Up and Down arrow keys to select between **LDN DTE#1** and **LDN DTE#2**. Press **Enter** to select the DTE. Use the keypad to enter the LDN. The Up and Down arrow keys edit the number if necessary. To store the number press **Enter**. To cancel a number, use the Down arrow to backspace through the number, then press **Enter**. After entering each LDN, press **Enter**. To abort changes at any time, press **Cancel**. The changes are discarded, leaving the original number unchanged.

When using a VT 100 terminal, select the option number corresponding to the appropriate DTE and press Return.

SPID and LDN numbers are entered in pairs and should not be crossed between the two DTE ports. Each SPID has a unique LDN. Enter a SPID-LDN pair for **DTE#1** and a separate SPID-LDN for **DTE#2**. Ensure that the SPID for **DTE#1** matches the LDN for **DTE#1**, and the SPID for **DTE#2** matches the LDN for **DTE#2**.



NOTE

Disconnect the network interface from the unit before initially entering and/or altering the SPIDs or LDNs.

Setting the Busy Out Port

The Busy Out Port is recommended for use in Hunt Group applications only. This option allows the ISU 2x64 to command the switch to no longer route calls to the 2x64. The Busy Out Port requires the ISDN line to be configured by the telephone company to support the Make Busy feature and a feature button number to be assigned for activating and deactivating busy status.

Feature buttons are buttons that are normally available on ISDN telephone sets. The ISU 2x64 simulates pressing a feature button when the Busy Out Port option is changed. When the Busy Out Port option is changed, the ISU 2x64 sends a Feature Activation message to the switch using the feature button number stored in S-register 23. If S-register 23 is not programmed with the correct button number for the Make Busy feature, the switch will not change the busy status of the ISU 2x64. The telephone company will need to tell you which feature button number was assigned to the Make Busy feature.

Enabled

To turn on the Make Busy feature, configure **Busy Out Port** for **Enabled**.

Disabled

To turn off the Make Busy feature, configure **Busy Out Port** for **Disabled**.



Multi-point lines must be used for per-port operation of the Busy Out Port feature.

Setting the Dial Options

The ISU 2x64 can be configured to dial using the Front Panel, RS-366 port, AT Commands, or V.25 bis Commands.

Front Panel

To establish and disconnect calls from the front panel keypad configure **Dial options** for **Front Panel**. See *Front Panel Dialing Options* on page 63 for more detail.

RS-366

Configuring the ISU 2x64 for RS-366 enables out-of-band dialing over the RS-366 port. To establish and disconnect calls using the

RS-366 parallel dialing port, configure the unit for RS-366 dialing. (See Figure 6-4.) This enables the RS-366 port on the rear of the unit. Whenever this dialing mode is enabled, data terminal ready (DTR) must be active before a call is placed. The call may be disconnected by dropping DTR, or from the front panel by selecting the # (pound) key to go directly to the Dial menu and selecting **1=Hang up line**, then **Enter**.

DTE RS-366 dialers can end their string of dialed numbers in two different ways. The end of number (EON) alerts the ISU 2x64 that the entire number has been sent. Another method is to simply stop sending numbers and allow the ISU 2x64 to time out, then dial the number. The ISU 2x64 supports both methods of dialed number terminations. The following options allow the dialed number termination to be fine-tuned:

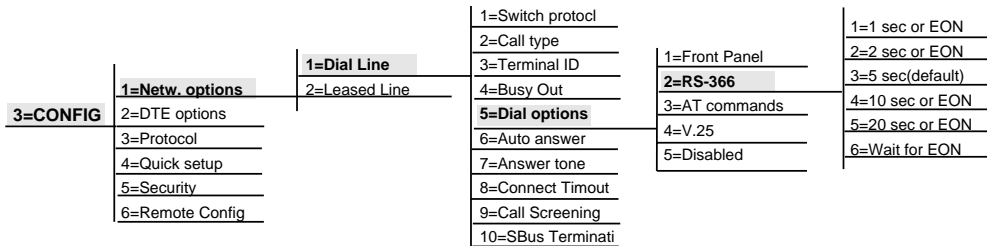

Figure 6-4
Dial Options, RS-366 Menu Tree

- 1 sec or EON:** The ISU 2x64 assumes the dial string is fully entered if more than one second elapses since the last digit was keyed, or the unit receives the EON command.
- 2 sec or EON:** The ISU 2x64 assumes the dial string is fully entered if more than two seconds elapse since the last digit was keyed, or the unit receives the EON command.
- 5 sec or EON (def):** The ISU 2x64 assumes the dial string is fully entered if more than five seconds elapse since the last digit was keyed, or the unit receives the EON command. This is the factory default setting.
- 10 sec or EON:** The ISU 2x64 assumes the dial string is fully entered if more than 10 seconds elapse since the last digit was keyed, or the unit receives the EON command.

- 20 sec or EON:** The ISU 2x64 assumes the dial string is fully entered if more than 20 seconds elapse since the last digit was keyed, or the unit receives the EON command.
- Wait for EON:** The ISU 2x64 assumes the dial string is fully entered only if the unit receives the EON command.

AT Commands

Configuring the ISU 2x64 for **AT commands** enables inband dialing over a DTE interface using asynchronous AT commands. **AT commands** can be used to set up the ISU 2x64 as well as establish and end a call. Calls can be disconnected from the front panel (as described previously) or from the far-end unit. Do not set the unit up for AT command in synchronous applications.

When AT commands are selected, the DTE port becomes dual purpose. First, while a call is not established, the port accepts AT commands. During this time, the CD signal is inactive. Second, when a call is established, the port is used for data. This data mode is indicated by the CD signal active. See the appendix *AT Commands* for a listing of the supported AT commands and their functions. In addition to the front panel, the ISU 2x64 can be configured and controlled with inband AT commands from an asynchronous DTE port just as modems are.

To exit data mode and enter command mode, the asynchronous DTE device must transmit a proper escape sequence to the ISU 2x64. A specified time delay must occur between the last data character and the first escape sequence character. This is the guard time delay, and it can be changed by writing a value to the S12 register. The default value for the guard time is one second. For a valid escape sequence to occur, the DTE must transmit the escape code character three times in succession with delay between each character being less than the guard time. The default escape sequence is +++.

Once command mode is entered, AT commands can be transmitted to the ISU 2x64 to configure most of the options, dial remote ISUs, or initiate tests to check both the ISU 2x64 and the network connections. All command lines must begin with the AT character set in either capital or lower case letters. A command line can

be terminated at any time by transmitting the **CTRL+X** (ASCII 018) after the AT attention code. The ISU 2x64 ignores this command line and issues an OK response.

The command line may contain a single command or a series of commands after the AT attention code. When a series of commands are used, the individual commands may be separated with spaces for readability.

The maximum length for a command line is 40 characters. Each command line is executed by the ISU 2x64 upon receipt of a terminating character.

The default terminating character is a carriage return (ASCII 013), but it can be changed by writing a different value to register S3. Before the terminating character is transmitted, the command line can be edited by using the backspace character (ASCII 008) to erase errors so the proper commands can be entered. Examples of using AT commands are as follows.

Using an AT Command

Type AT followed by the letter of the command and numeric value of the setting desired and then press **Enter**.

Example: AT11

Returns the software version of the unit.

Using S-Registers

The configuration of the ISU 2x64 can be changed and/or reviewed with S-registers. See the appendix *S-Register List* for a description of each S-register and its corresponding range of values.

Reading an S-Register

Type ATS followed by the number of the S-register to be read followed by a question mark and press **Enter**.

Example: ATS0?

The ISU 2x64 uses S-register strings to store strings of digits for stored phone numbers, SPIDs, etc.

Reading an S-register String

Type **ATSS** followed by the number of the string S-register to be read followed by a question mark and press **Enter**.

Example: ATSS80?

To Change an S-register

Type **ATS** followed by the number of the S-register to be changed, an equal sign, the numeric value to be assigned to the register, then press **Enter**.

Example: ATS0=2

Changing a String S-register

Type **ATSS** followed by the number of the string S-register to be changed, an equal sign, the numeric string to be assigned to the register, then press **Enter**.

Example: ATSS80=5551212

Dialing a Call by the AT Command Processor

To dial a call using the DTE terminal and AT commands; type **ATD** and the telephone number on one line and press **Enter**.

Example: ATD5551212

When the dialing process begins, the front panel reads **Dialing 5551212**. If the call is successful, **Connect** is displayed on the front panel, followed by the rate adaptation protocol in use and the bit rate. If the call is not successful, the front panel displays **Disconnect** followed by **Ready**. At this point the unit is ready for another call. The status buffer can be examined to find the reason for an unsuccessful call.

To end an active call with the AT command processor press the break in key sequence , +++ or the redefined key, then type **ATH** and press **Enter** to hang up the line.

V.25

Configuring the ISU 2x64 for **V.25 bis** (see Figure 6-5) enables inband dialing over a DTE interface using asynchronous or synchronous V.25 bis commands. **V.25 bis** can be used to establish and end a call. Disconnecting calls can also be done from the front panel (as described previously), from a VT 100 terminal, or from the far-end unit.

V.25 bis dialing is used primarily by DTE with synchronous interfaces (HDLC/SDLC or BSC/BISYNC) not supporting the AT command set, which is commonly used by asynchronous devices. The ISU 2x64 supports V.25 bis inband dialing in accordance with Fascicle V.III-V.25 bis (Malaga-Torremolinos 1984, Melbourne 1988).

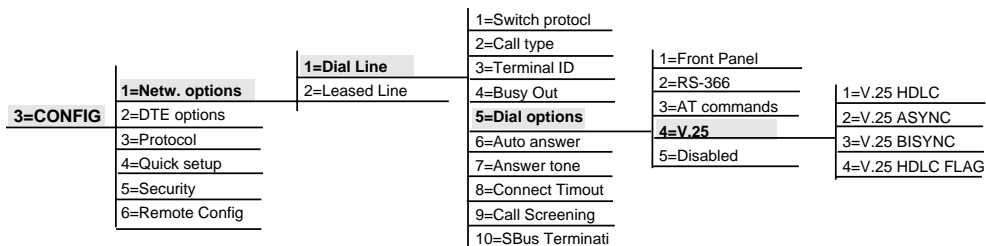

Figure 6-5
Dial Options, V.25 bis Menu Tree

Recommendation V.25 uses the following DCE/DTE control signals:

Transmitted Data	Circuit 103
Received Data	Circuit 104
Ready for Sending	Circuit 106
Data Set Ready	Circuit 107
Data Terminal Ready	Circuit 108/2
Calling Indicator	Circuit 125

The ISU supports the following V.25 bis commands to control automatic calling and answering:

- CRN Call Request (number in command)
- CRS Call Request (using stored number)
- PRN Program Stored Number
- RLN List Stored Number
- CIC Connect Incoming Call
- DIC Disconnect Incoming Call



When using stored numbers, V.25 bis accesses stored numbers 1 through 9 used by front panel dialing. See *Front Panel Dialing Options* on page 63.

The following configuration (see Figure 6-6) for **Auto answer** should be selected if V.25 bis is in control of answering incoming calls with the CIC/DIC commands, since the other settings for **Auto answer** will override V.25 control of the answer function.

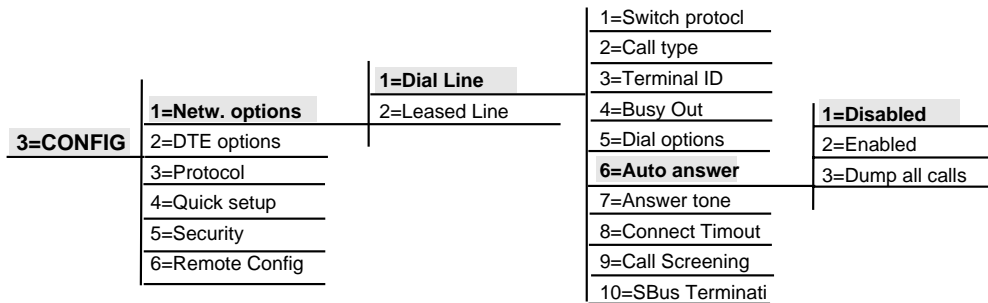

Figure 6-6

Dial Line, Auto Answer Menu Tree

V.25 ASYNC Dialing

V.25 bis specifies that the characters should be ASCII, 7 bits, even parity and one stop bit. However, for versatility the ISU 2x64 allows the data bits, parity, and stop bits as defined under **Data Format**. (See Figure 6-7.)

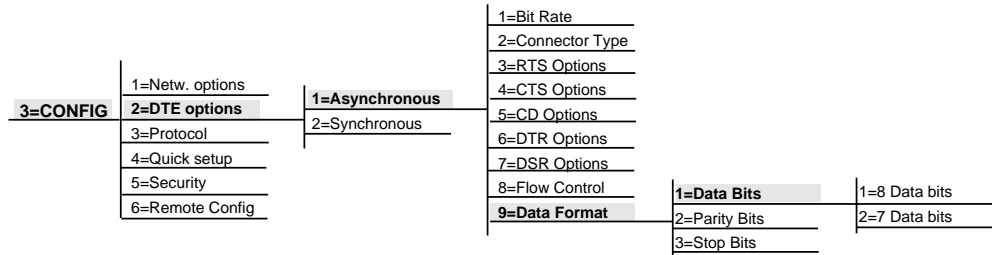

Figure 6-7
Data Bits Menu Tree

The setting in Figure 6-8 allows for V.25 bis messages in asynchronous (start/stop) data format.

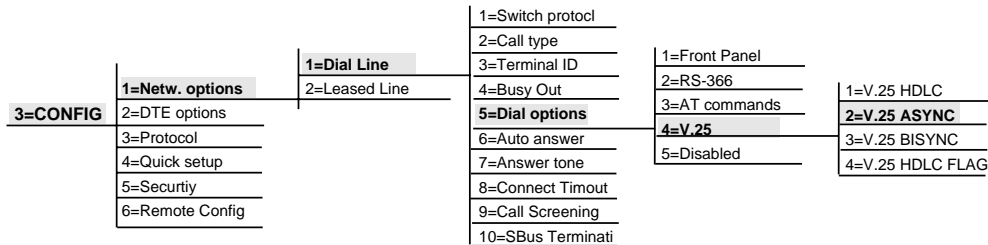

Figure 6-8
V.25 bis ASYNC Menu Tree

Although V.25 bis allows asynchronous data format, asynchronous DTE is more likely to support the AT command set than V.25 bis.

V.25 SYNC HDLC Dialing

To set the Dial Options for V.25 HDLC, choose 1=V.25 HDLC from the front panel or the VT 100 terminal (see Figure 6-8 for the menu tree). This setting provides V.25 bis messages in bit-synchronous format (for example HDLC, SDLC, X.25). The bit-synchronous format is the most commonly used by V.25 bis.

This option specifies that the characters should be 7-bit ASCII, with the 8th bit ignored (it may be either 0 or 1).

The first byte of each packet contains all ones (A = FF HEX), and the second byte of each packet (the C byte) is either 13 HEX or 03 HEX if not the final packet.

V.25 SYNC BISYNC Dialing

To set the Dial Options for V.25 BISYNC, choose 3=V.25 BISYNC from the front panel or the VT 100 terminal (see Figure 6-8 for menu tree). This setting allows for V.25 bis messages in byte synchronous format (BISYNC). V.25 bis specifies that the characters should be ASCII, 7 bits, and odd parity. This setting allows synchronous data terminal equipment which does not use HDLC to support serial inband dialing.

V.25 HDLC FLAG

To set the Dial Options for V.25 HDLC FLAG, choose 4=V.25 HDLC FLAG from the front panel or the VT 100 terminal (see Figure 6-8 for menu tree). Configuring the ISU 2x64 for HDLC FLAG V.25 bis enables in-band dialing over a DTE interface using standard synchronous HDLC V.25 bis commands with 7E HEX idle.

Disabled

This selection disables in-band dialing over the DTE interface.

Setting Auto Answer

Auto answer is configured separately for both DTE#1 and DTE#2. Using the front panel, select the appropriate DTE with either arrow key and press **Enter**. When using a VT 100 terminal, select the option number corresponding to the appropriate DTE and press **Return**.

The ISU 2x64 can be configured to automatically answer in one of three ways: Disabled, Enabled, or Dump all calls.

Disabled

When **Disabled** is selected, the ISU 2x64 will not answer the call. The AT answer command (ATA) must be issued to the ISU 2x64 for it to accept the incoming call or by selecting **Answer Call** from dial menu. The ringing call can be dumped by using the

Hang up line command or answered using the **Answer Call** command. (These commands are found under the **Dial** branch of the menu tree. See *Front Panel Dialing Options* on page 63.)

Enabled

When **Enabled** is selected, the incoming call is answered. If that call is a BONDING call and requires two B channels, the second call is answered. The port assigned to that second SPID-LDN pair is disabled during the duration of the BONDING call.

Dump all calls

When **Dump all calls** is selected, the ISU 2x64 does not accept any incoming calls. This keeps the line clear for outgoing calls.

Setting Answer Tone

Answer tone is configured separately for both DTE#1 and DTE#2. Using the front panel, select the appropriate DTE with either arrow key and press **Enter**. (See Figure 6-9.) When using a VT 100 terminal, select the option number corresponding to the appropriate DTE and press **Return**.

The **Answer tone** option enables the transmission of a modem answer tone at the start of voice and audio calls. The purpose of this tone is to disable echo suppression for echo cancellation on the circuit in order to get a clear digital circuit. This may be necessary on some long distance circuits. The specifics of the tone are 4 seconds, 2100 Hz at a -10 dB level with phase reversals every 475 μ s.

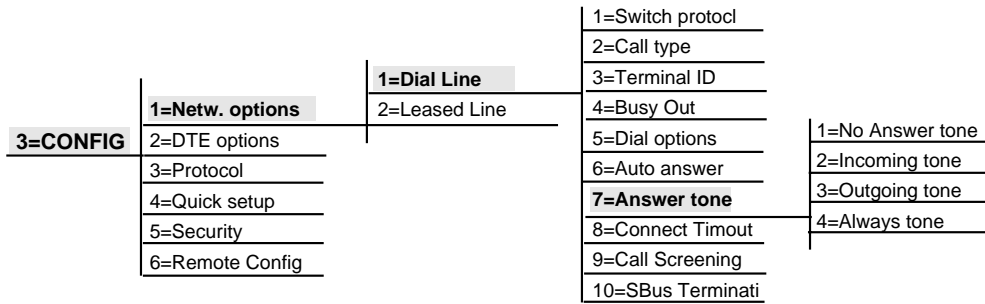

Figure 6-9
Answer Tone Menu Tree

No Answer tone (Default)

This option disables the **Answer tone** on all calls.

Incoming tone

This option enables the **Answer tone** on incoming calls.

Outgoing tone

This option enables the **Answer tone** on outgoing calls.

Always tone

This option enables the **Answer tone** on either incoming or outgoing calls.

Setting Connect Timeout

Connect Timeout sets the length of time that the ISU 2x64 waits for a far-end unit to answer an outgoing call. These choices are illustrated in Figure 6-10.

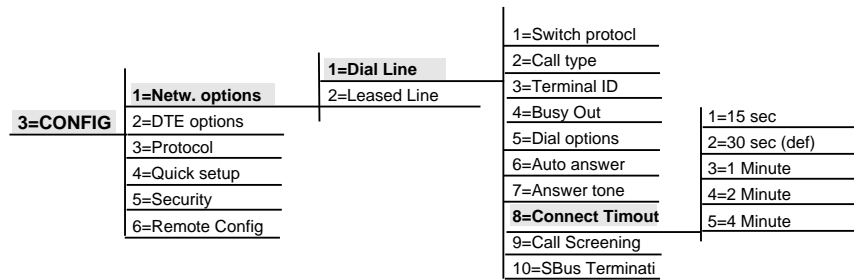

Figure 6-10
Connect Timeout Menu Tree

Setting Call Screening

Call Screening allows the ISU 2x64 to either answer all incoming calls (default) or only calls originating from phone numbers stored in the DIAL menu as stored numbers SN0 through SN9. See *Front Panel Dialing Options* on page 63 to review how to store numbers. Figure 6-11 illustrates the menu tree for setting call screening.

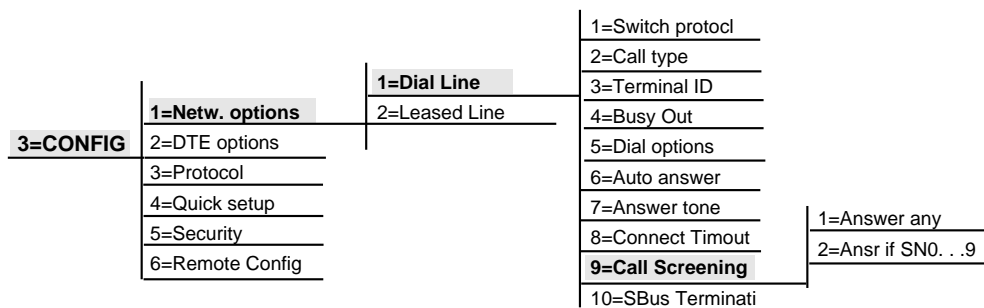

Figure 6-11
Call Screening Menu Tree

When **Call Screening** is set to **Ansr if SN0. . .9**, an incoming call is not answered if the Call ID received from the switch does not match a stored number. Depending on the switch type, the Call ID may be presented in either a seven- or ten-digit format. The ISU 2x64 displays the Call ID for all dumped calls in the **Status Buffer**. See *Status Buffer* on page 20 for more information.

Because different switches handle calls and Call ID differently, first find out if the switch uses a seven- or ten-digit Call ID format. Use the following procedure to determine if a seven- or ten-digit Call ID (phone number) should be stored.

1. Select **Ansr if SN0. . .9** under **Call Screening**.
2. Store the seven-digit number in SN0.
3. Place a call to the ISU 2x64 with the stored number to see if it answers properly.
4. If the ISU 2x64 does not answer the call, check the Call ID message in the Status Buffer. More than likely, the Call ID number will be a ten-digit number.
5. Reenter the number in SN0 as it is displayed in the Call ID message and test **Call Screening** again.

SBus Termination

Use the SBus Termination option (see Figure 6-12) to select 100 ohm termination resistors for the S/T interface on ISU 2x64 units that are equipped for the ISDN S/T interface. These units (part numbers 1200051L2, 1200051L4, 1200051L5, and 1200051L6) connect to the S/T interface of an NT1 device or the S/T line card.

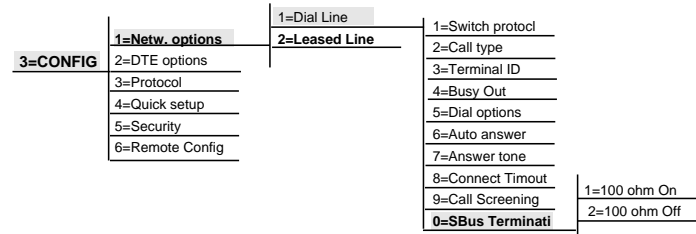

Figure 6-12
SBus Termination Menu Tree

Select **100 ohm On** to turn on the 100 ohm termination resistance across the S/T transmit and receive pairs. Select **100 ohm Off** to turn off the 100 ohm termination resistance across the S/T transmit and receive pairs.

The SBus Termination resistors are not present on ISU 2x64 units equipped with the integrated NT1 (part numbers 1200051L1 and 1200051L3). Setting the SBus Termination resistance to on or off on these units has no effect on their operation and can be ignored.

LEASED LINE SERVICE

This section explains how to configure the ISU 2x64 when using a 2B1Q leased digital service or a service providing a permanent connection between end points. The distance can be up to 18000 feet.

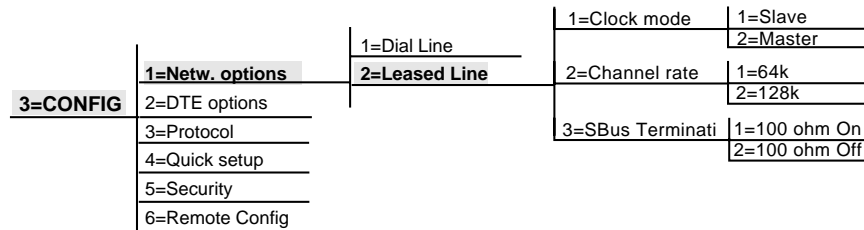

Figure 6-13
Leased Line Menu Tree

Selecting **Leased Line** configures the unit for leased line service or service providing a permanent connection between end points such as limited distance modem or LDM service.

Follow this step-by-step procedure to configure the ISU 2x64 for **Leased Line**, **Clock mode**, **Channel rate**, and **S Bus Termination**.

Clock mode: Slave/Master

By configuring the ISU 2x64 for **Master** timing, the ISU 2x64 can provide clocking for both ends of the phone line. This **Master** option is intended to be used at one end of a limited distance

modem application, where two ISU 2x64 units are directly connected without the use of channel banks (see Figure 6-14). The far-end unit should be configured for **Slave** and derives its clocking from the ISU 2x64 configured as **Master**.

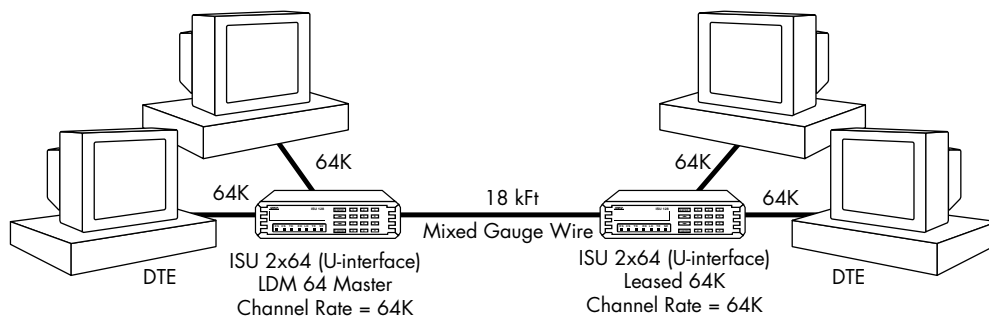

Figure 6-14
Limited Distance Modem Applications

If two ISU 2x64 units are connected through channel banks, both units should be configured for **Slave** mode (see Figure 6-15).

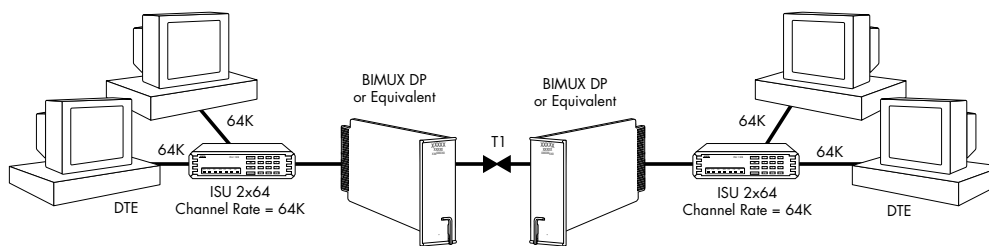

Figure 6-15
Leased Application with Channel Banks

Channel Rate

In **Leased Line** operation, the channel rate for the ISU 2x64 can be configured for 64 kbps or 128 kbps. When the channel rate is set to 64 kbps, each DTE port is assigned one of the bearer channels. For example, if two ISU 2x64 units are configured for leased line service and the channel rate is set to 64 kbps in both units, then DTE#1 of the master unit and DTE#1 of the slave unit would be

connected through one of the bearer channels and could utilize up to 64 kbps of bandwidth. Likewise, DTE#2 of the master and DTE#2 of the slave would be connected through the other bearer channel and could also utilize up to 64 kbps of bandwidth (see Figure 6-15).

When the channel rate is set for 128 kbps in both units, both bearer channels are assigned to one DTE port. This assignment is user-configured. Select a DTE rate higher than 64 kbps for the DTE port that will run the application requiring greater than 64 kbps bandwidth. Select the same DTE port for both Master and Slave 2x64 units. Set the unused DTE port's DTE rate to a rate less than 64 kbps to facilitate correct operation between the two ISU 2x64 units.

For example, if an application requiring 128 kbps was run through **DTE#1**, first configure the channel rate of the leased line to 128 kbps and set the DTE rate for **DTE#1** to 128 kbps synchronous. The DTE rate for **DTE#2** should be set at 56 kbps or lower. Enter these settings into both units. This allows an application to utilize up to 128 kbps of bandwidth between **DTE#1** on the master unit and **DTE#1** on the slave unit.

SBus Termination

SBus Termination selects 100 ohm termination resistors for the S/T interface on ISU 2x64 units that are equipped for the ISDN S/T interface. These units (part numbers 1200051L2, 1200051L4, 1200051L5, and 1200051L6) connect to the S/T interface of an NT1 type device or the S/T line card.

Select **100 ohm On** to turn on the 100 ohm termination resistance across the S/T transmit and receive pairs. Select **100 ohm Off** to turn off the 100 ohm termination resistance across the S/T transmit and receive pairs.

The SBus Termination resistors are not present on ISU 2x64 units equipped with the integrated NT1 (part numbers 1200051L1 and 1200051L3). Setting the SBus Termination resistance on these units has no effect on their operation and can be ignored.

Units with S/T interface will not work in master mode.

DTE Options for Asynchronous and Synchronous Operation

The DTE options are configured separately for both DTE#1 and DTE#2. When using the front panel, select the appropriate DTE with either arrow key and press **Enter**. (See Figure 6-16 and 6-17.) When using the VT 100 terminal select the option number corresponding to the appropriate DTE and press **Return**.



Ensure the DTE equipment is set for asynchronous operation before attempting to make an asynchronous call. Failure to do so causes the call attempt to fail.

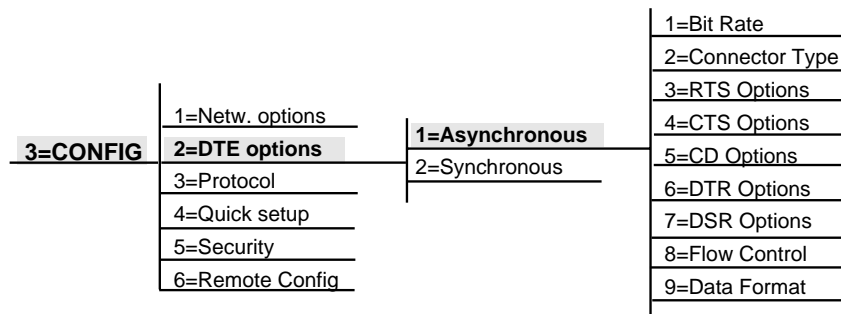

Figure 6-16
Asynchronous DTE Options Menu Tree

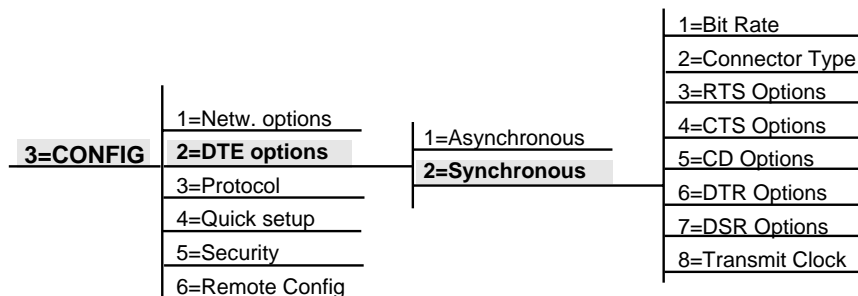

Figure 6-17
Synchronous DTE Options Menu Tree

Bit Rate

The **Bit Rate** can be set asynchronously for 300, 1200, 2400, 4800, 9600, 19200, 38400, 57600, and 115200 bps.

The **Bit Rate** can be set synchronously for 2400, 4800, 9600, 19200, 38400, 48000, 56000, 64000, 112000, and 128000 bps.

Connector Type

The ISU 2x64 can provide either an EIA-232, RS-530, or V.35 interface to a user DTE by selecting the desired connector type. The V.35 interface requires the RS-530/232-to-V.35 adapter, part number 1200072L1.

RTS Options

1 ms delay causes the **Clear to Send** signal to change state one millisecond after the DTE **Request to Send** signal changes state. The **18 ms delay** causes the **Clear to Send** signal to change state 18 milliseconds after the DTE **Request to Send** signal changes state.

CTS Options

Forced CTS causes the CTS signal on the DTE connector to be continually asserted. **Follows RTS** causes the CTS signal to follow the state of the RTS lead.

CD Options

CD Forced On causes the carrier detect (CD) signal to always be asserted. **Normal** causes the CD signal to be asserted when a call has been successfully established. **Off with LOCD** (local disconnect) causes the CD signal to be disasserted for a period of 5 seconds and then be reasserted at the termination of a call. **Off Link Down** causes the CD signal to be disasserted when the ISDN interface is not ready.

DTR Options

Ignore DTR causes the ISU 2x64 to disregard the state of the data terminal ready (DTR) pin. **Cmd when Off** forces the unit into the AT command processor mode when DTR is not asserted. To return online, DTR must be asserted, followed by the AT0 command. **Idle when Off** forces the unit to end the current call when DTR is no longer asserted. **Off>On dial #0** allows one call attempt to be automatically established when the DTR signal goes from inactive to active. While DTR is active, front panel dialing is also possible. When DTR goes inactive, any outgoing call present is disconnected. **Off>On dial #0** uses the phone number in stored number register 0 to establish the call. To store a number for automatic dialing, see the section *Front Panel Dialing Options*. **Dial #0 if On** allows calls to be automatically established when the signal is in the active state. The unit attempts to establish a call using SN0 until the call is established or DTR goes inactive. **Answer if On** only allows the unit to answer an incoming call if DTR is asserted.

DSR Options

DSR forced on causes the data set ready (DSR) signal on the DTE connector to always be asserted. **Off Idle+Test** causes the DSR to be disasserted if the ISU 2x64 is in test or there is not an active call. **Off Link Down** causes the DSR signal to be disasserted when the ISDN interface is not ready.

Flow Control (asynchronous data format)

Selecting **Hardware Flow** (see Figure 6-18) allows the ISU 2x64 received data to be presented to the DTE interface only when RTS (request to send) is asserted and allows DTE transmit data to be presented to the 2x64 when CTS is asserted. **Software Flow** control uses XON/XOFF inband to control data transferred between the DTE and the ISU 2x64. Selecting **No Flow Ctrl** disables flow control. Either Hardware or Software flow control should be used when asynchronous BONDING or DTE rates higher than the effective loop rate are used (i.e., 115.2 kbps over 112 kbps loop rate).

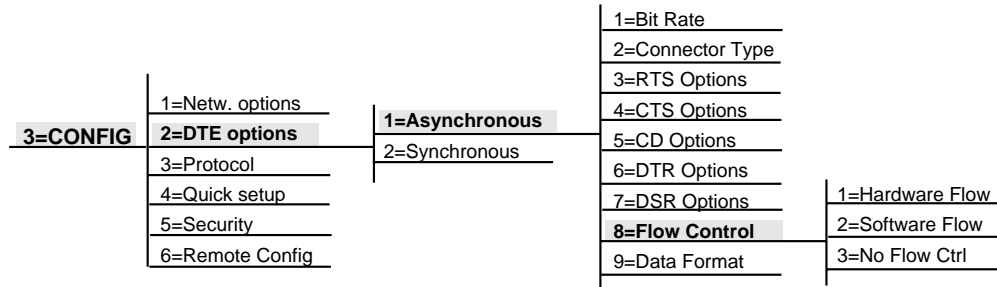

Figure 6-18
Flow Control Menu Tree

Data Format (asynchronous)

A frame consists of a start bit, 7 or 8 Data bits, 0 or 1 Parity bit, and 1 to 2 Stop bits. The settings for Data Bits, Parity Bits, and Stop Bits are available as shown in Figure 6-19.

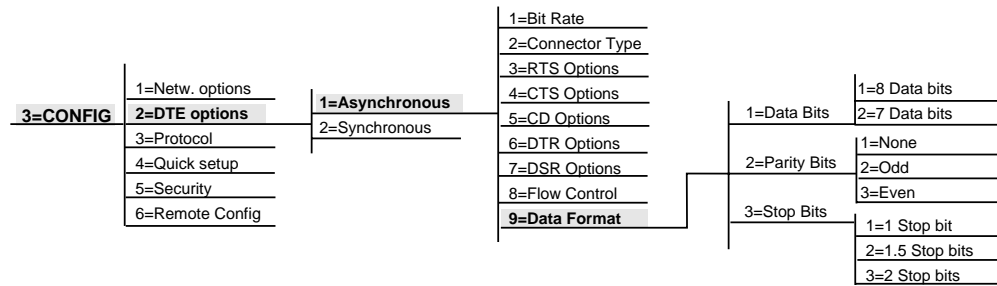

Figure 6-19
Data Format Menu Tree

Transmit Clock (synchronous data format)

Selecting the **Normal** option causes the ISU 2x64 to be the synchronous DTE interface transmit timing source. Transmit data is timed from the transmit clock provided by the ISU 2x64. With the **External** option selected, the ISU 2x64 slaves to an external transmit timing source. The external clock is provided to the ISU 2x64 by the external transmit clock signal at the DTE connector.

This signal is echoed by the ISU 2x64 to the transmit clock signal on the DTE connector. See Figure 6-20 for the menu tree.

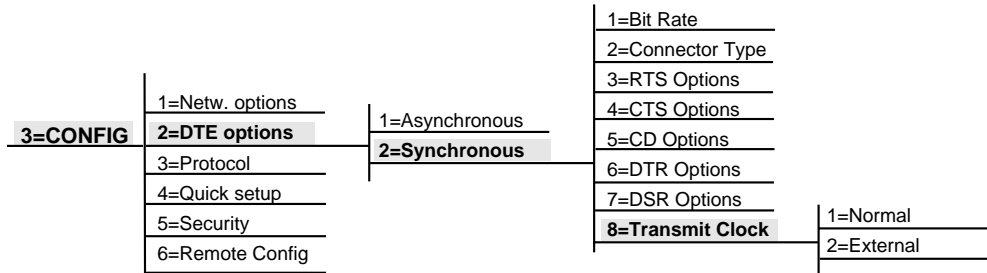

Figure 6-20
Transmit Clock Menu Tree

Autobaud

The ISU 2x64 has a DTE rate adjustment feature (autobaud) which automatically adjusts the bit rate on the DTE port connector to match that of the connected terminal. For any terminal rate from 300 bps through 115.2 kbps, type **AT** and a carriage return. The ISU 2x64 will adjust to that rate. The DTE port must be set for **AT** commands under **Dial Options** for autobaud to become activated on a port .

The autobaud feature is only allowed to be active on one DTE port at a time. If both DTE#1 and DTE#2 are set for **AT** commands (under **Dial Options**), then autobaud will be active on DTE#2 only. To make autobaud active on DTE#1, change the **Dial Options** on DTE#2 from **AT** commands to some other available dialing option.

When autobaud is not active on a DTE port, the asynchronous rate of the DTE port matches the rate programmed into the ISU 2x64 at the current time. While autobaud is running on a port, that port meets Microsoft Windows® 95 Plug-and-Play specifications. The file MDMADTN.INF is required. To obtain this file, contact ADTRAN Technical Support as shown on the inside back cover of this manual.

Setting Protocol Options

The ISU 2x64 communicates with many different types of telecommunication equipment including other ISU 2x64s, ISDN terminal adapters, Switched 56 DSUs, and BONDING-compatible inverse multiplexers. Communicating between such diverse types of equipment requires various rate adaptation protocols to support various bit rates and DTE settings. See Figure 6-21 for the menu tree. The ISU 2x64 supports the following rate adaptation protocols:

- Clear Channel (no rate adaptation protocol) (synch. only)
- BONDING mode 1 (Bandwidth on Demand Interoperability Group)
- CCITT V.120
- CCITT V.110
- DSU 57.6 ASYNC
- T-LINK (Dial DDS DSU/CSU)
- SAP (Simple ADTRAN Protocol)
- FALLBACK
- PPP async-sync

3=CONFIG	1=Netw. options	1=Clear Channel
	2=DTE options	2=BONDING mode 1
	3=Protocol	3=V.120
	4=Quick setup	4=V.110
	5=Security	5=DSU 57.6 ASYNC
	6=Remote Config	6=T-LINK
		7=SAP
		8=FALLBACK
		9=PPP async-sync

Figure 6-21
Protocol Menu Tree

See *Recommended Operating Protocols* on page 6 for more information on recommended modes of operation.

The desired protocol may be selected with AT commands at the DTE port or from the ISU 2x64 front panel. A description of protocols follows.

Clear Channel

Clear channel provides the entire bearer channel to the DTE without regard to data format or protocol. This provides a rate adaptation at or near the ISDN circuit rate. The primary usage for **Clear Channel** in dial line mode is 56 kbps and 64 kbps synchronous. It is useful when the DTE performs its own internal synchronous protocol/rate adaptation or the ISU 2x64 is calling a 4-wire Switched 56 DSU. In the leased line mode, clear channel can provide synchronous bit rates of 56 kbps, 64 kbps, 112 kbps, and 128 kbps.

BONDING mode 1

The **BONDING mode 1** protocol allows the ISU 2x64 to communicate at bit rates in excess of 64 kbps to a maximum of 128 kbps. **BONDING** provides high-speed communication between ISU 2x64s, ISDN TE/TAs, and inverse multiplexing equipment supporting the **BONDING** protocol. The protocol allows for the use of both synchronous and asynchronous bit rates. When the ISU 2x64 uses the **BONDING mode 1** protocol, it must make two separate ISDN phone calls to seize control of both ISDN bearer channels. The protocol corrects any delays existing between the two bearer channels and presents a single high-speed data channel to the DTE. For successful high-speed operation, both the near- and far-end DCE need to be configured to use **BONDING mode 1** protocol. **BONDING mode 1** protocol negotiation phase has numerous timers to allow for transmission delays due to satellite hops, international calls, etc. The timers may be adjusted if necessary by entering into **BONDING mode 1** submenu. See Figure 6-22 for the menu tree.

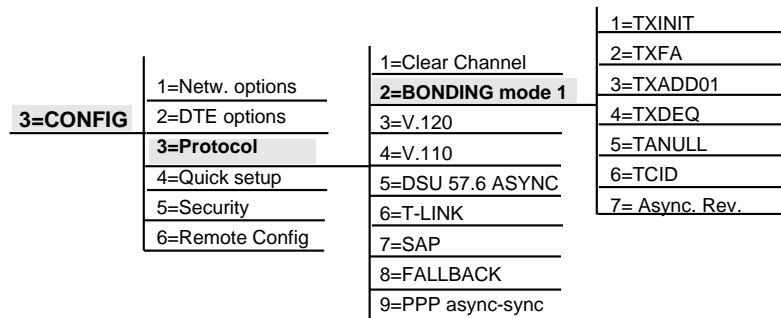
**Figure 6-22***Protocol BONDING, Mode 1 Menu Tree*

The timers are defined as follows:

TXINIT

This option specifies the length of time the originating endpoint attempts to detect BONDING negotiation pattern from the answering endpoint before determining the BONDING call has failed. In general, this timer value should be left at the factory default setting of 10 seconds. Select from values of 1, 2, 5, 10 (default), 20, 50, 100, and 200 seconds.

TXFA

This option specifies the length of time both endpoints attempt to detect the BONDING frame pattern when a call is connected before determining the BONDING call has failed. This timer value should be left at the factory default setting of 10 seconds. However, when interoperating with other manufacturers' BONDING equipment it may be necessary to lengthen this timer to match TXADD01. Values of 1, 2, 5, 10 (default), 20, 50, 100, and 200 seconds may be selected.

TXADD01

This option specifies the length of time both endpoints wait for the additional call to be connected at the end of negotiation before determining the BONDING call has failed. The factory default setting of 20 seconds is sufficient for most calls to go through, although when dialing overseas it may be necessary to lengthen this timer to allow for slower call routing. Values of 1, 2, 5, 10, 20, 50 (default), 100, and 200 seconds may be selected.

TXDEQ

This option specifies the length of time both endpoints attempt to equalize the network delay between the bearer channels before determining the BONDING call has failed. Values of 1, 2, 5, 10, 20, 50 (default), 100, and 200 seconds may be selected.

TANULL

This option specifies the length of time the answering endpoint attempts to detect the BONDING negotiation pattern from the originating endpoint before aborting to clear channel mode. In general, this timer value should be left at the factory default setting of 10 seconds. However, it may be necessary to shorten this timer if the DTE equipment connected to the ISU also has timer constraints for completing non-BONDING parameter negotiation. Values of 1, 2, 5, 10 (default), 20, 50, 100, and 200 seconds may be selected.

TCID

This option specifies the length of time both endpoints attempt to negotiate an agreeable value for bearer channels and channel capacities before determining the BONDING call has failed. Select from values of 1, 2, 5 (default), 10, 20, 50, 100, and 200 seconds.

Async. Rev.

This option specifies the negotiation revision for asynchronous BONDING. Rev. 1 specifies multi-vendor compatible negotiation. Rev. 0 specifies ADTRAN proprietary negotiation. This option has no effect on synchronous negotiation.

V.120

The V.120 protocol is a CCITT compliant rate adaptation method providing DTE service between the ISU 2x64 and other V.120 compliant devices at rates less than the 64 kpbs ISDN bearer channel rate. V.120 supports both synchronous and asynchronous DTE rates. See *Recommended Operating Protocols* on page 6 for available V.120 rates. Figure 6-21 illustrates the menu path for selecting V.120.

V.110

The V.110 protocol is a CCITT compliant rate adaptation method providing DTE service between the ISU 2x64 Dual Port ISDN Service Unit and other V.110 compliant devices. The V.110 protocol supports both synchronous and asynchronous DTE rates. See the section *Recommended Operating Modes* and Table 1-B for available V.110 rates. Figure 6-21 illustrates the menu path for selecting V.110.

DSU 57.6 ASYNC

The **DSU 57.6 ASYNC** protocol allows the ISU 2x64 to communicate asynchronously at 57.6 kbps with ADTRAN 2-and 4-wire Switched 56 DSU products. In addition, the ISU 2x64 communicates with other ISUs over dial and leased connections using this protocol. Figure 6-21 illustrates the menu path for selecting **DSU 57.6 ASYNC**.

T-Link

The **T-Link** protocol allows the ISU 2x64 to communicate with 2-wire Switched 56 DataPath DUs. The **T-Link** protocol performs two functions:

- It adapts the data rate of sub 64 kbps DTE devices to the 64 kbps bandwidth of the ISDN bearer channel.
- For asynchronous and synchronous DTE rates up to 19.2 kbps, T-Link transmits the status of the DCE-DTE EIA leads to facilitate flow control and maintenance.

In addition to 2-wire Switched 56 DataPath DUs, the ISU 2x64 communicates with any other device using the **T-Link** protocol. Figure 6-21 illustrates the menu path for selecting **T-Link**.

SAP

The Simple ADTRAN Protocol (SAP) is a rate adaptation method which provides DTE service between ISU 2x64 units at a channel rate lower than the 64 kbps ISDN bearer. Selecting this menu item causes the ISU 2x64 to use **SAP** protocol.

The primary usage for **SAP** is general purpose asynchronous rate adaptation in a dial-up or leased environment. **SAP** only operates on a 64 kbps data link. Figure 6-21 illustrates the menu path for selecting **SAP**.

FALLBACK

The **FALLBACK** asynchronous rate adaptation protocol provides the capability to automatically establish calls with other ISDN terminal adapters and Switched 56 DSUs, as well as other ISUs using a single configuration. The ISU 2x64 must be optioned as follows for **FALLBACK** operation:

1. Any asynchronous bit rate up to 115.2 kbps which is supported by the DTE.
2. Flow control must be enabled and supported by the DTE.

FALLBACK supports the following protocols based on the Call Type: BONDING mode 1, V.120, and T-Link. Figure 6-21 illustrates the menu path for selecting **FALLBACK**.

When answering calls, the ISU 2x64 uses the incoming call type to determine which rate adaptation protocols to support.

Table 6-A
Rate Adaptation Protocols

Call Type	Rate Adaption Protocols Supported	Typical Units Supported
Data 64 k	Bonding mode 1 V.120 PPP async-sync	ISUs ISDN TAs PPP compatible bridges/routers
Data 56 k	BONDING mode 1 V.120 PPP async-sync T-Link	ISUs ISDN TAs PPP compatible bridges/routers 2-wire Switched 56 DSUs

When originating calls to unknown units, the ISU begins its protocol selection based on its local Call Type. (Data 64k is used for FALLBACK when selected from the Quick Setup menu.) Upon connection at 64k Call Type, BONDING, V.120, and PPP are attempted. If connection is not made at 64k, the ISU attempts another call at 56k Call Type. If the protocol cannot be negotiated, the ISU hangs up the call.

Point-to-Point (PPP) Async-to-Sync

PPP provides a standard method for transporting multi-protocol datagrams over point-to-point links. The ADTRAN PPP async-sync protocol allows the ISU 2X64 and a PC or Macintosh® running PPP software, to communicate with a PPP-compatible bridge or router. The PPP async-sync protocol complies with Internet Engineering Task Force (IETF) RFC 1662. The menu path to select PPP is shown in Figure 6-23.

The asynchronous control character map (ACCM) option is scanned during the negotiation. When the ACCM option is seen in a configure ACK link control packet, it is adopted by the ISU 2x64. In addition, when the ACCM option is not seen in the configure-request packet from the network, the ISU 2x64 will add it to the packet.

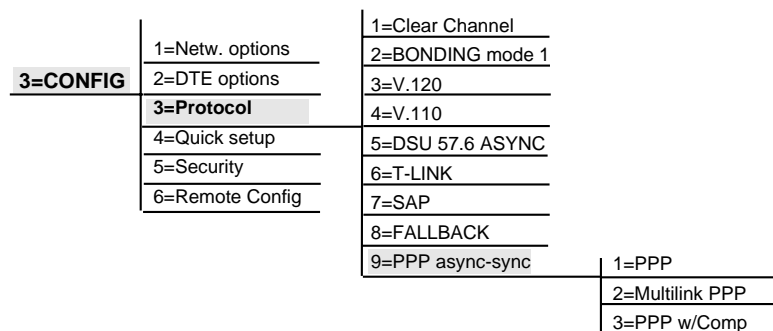

Figure 6-23
PPP Menu Tree

Point-to-Point Protocol (PPP)

The ISU 2x64 can be configured for PPP from the protocol options of the configuration menu by selecting **1=PPP** or by setting S-register S27 to a value of 0. The menu path is shown in Figure 6-23.

Multilink PPP

The ISU 2x64 can be configured for multilink PPP from the protocol options of the configuration menu by selecting **2= Multilink PPP** or by setting S-register S27 to a value of 1. (See Figure 6-23.) In this mode, the ISU 2x64 dials a second number to establish a second point-to-point link. Once the second PPP is established, multilink PPP is performed over both B-channels.

The phone number for the second call should be placed in stored number 1 (SN1). If no number is stored in SN1, the same phone number is dialed to establish the second link.

PPP with Compression

The ISU 2x64 can be configured for PPP with compression from the protocol options of the configuration menu by selecting **3=PPP w/Comp** or by setting S-register S27 to a value of 2. The menu path is shown in Figure 6-23.

Chapter 7

Dial Options

FRONT PANEL DIALING OPTIONS

Selecting **4=DIAL** or pressing the # key from the front panel displays the available dialing options (see Figure 7-2). Access the VT 100 Terminal Dial Options Screen (Figure 7-1) by pressing **Ctrl+D** from any screen. The dial options are only available when the ISU is configured for Dial Line operation (not Leased Line).

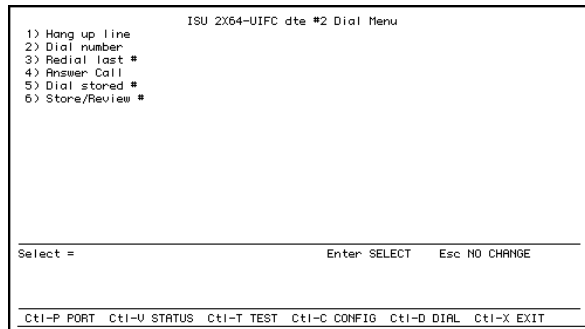

Figure 7-1
VT 100 Dial Options Screen

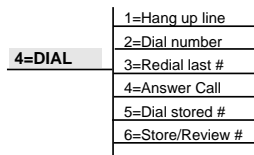

Figure 7-2
Dial Menu Tree

Hang up line

Terminates current call.

Dial number

Enter and dial a number from the keypad. If an error is made, press the Down arrow to edit the number. After the number is entered, press **Enter** to dial the number and save as stored number 9 for redialing purposes.

Redial last #

Redial the last number called (or attempted) from the front panel. This number is saved as stored number 9 from the last attempted phone call.

Answer Call

Selectively answer incoming calls when Auto answer is configured for disable. (Auto answer is described in the section Setting Auto Answer.)

Dial stored #

Dial one of ten stored phone numbers. The Up and Down arrows permit viewing/selection of a stored number. Press **Enter** to dial number and save as stored number 9 (SN9) for redial purposes.

Store/Review #

Enter and review stored numbers. Press the Up and Down arrows to scroll through the 10 stored numbers (SN0 - SN9). To store a number, scroll to the desired stored number location, enter the number to be stored, and press **Enter** to save the number. If an error is made, use the Up and Down arrows to edit the number. Press **Enter** to save the number and exit. Press **Cancel** to exit without changing the number.

Chapter 8

Quick Setup

QUICK SETUP CONFIGURATION

To configure the **DTE Options** quickly and easily, the **Quick Setup** menu is available to automatically set up the nine most common DTE configurations. (See Figure 8-1.) For fine-tuning a particular application and DTE settings, see *DTE Options for Asynchronous and Synchronous Operation* on page 50 for step-by-step procedures for detailed configuration of the DTE Options.

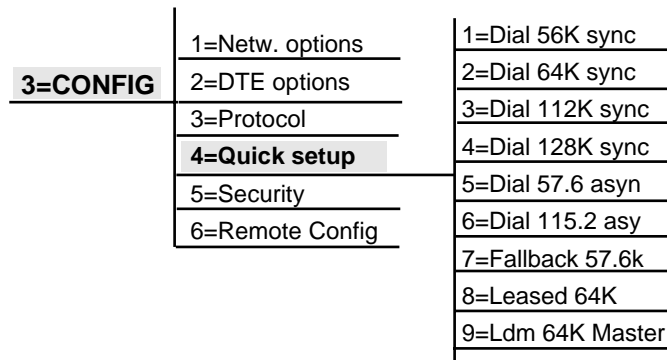

Figure 8-1
Quick Setup Menu Tree

Quick Setup

To aid in configuring the ISU 2x64, nine common configurations are preset for **Quick Setup**. These include:

- Synchronous dial operation for 56, 64, 112, and 128 kbps
- Asynchronous dial operation for 57.6 and 15.2 kbps
- 64 kbps Limited Distance Modem using Master clocking
- 64 kbps leased service
- Fallback 57.6



*If indicated with an asterisk, the option requires the end user to configure the ISDN switch type, SPID1-LDN1 and SPID2-LDN2. See the section **Setting the Dial Options**.*

Dial 56K sync*

When the ISU 2x64 is configured for **Dial 56 Sync** service, the following parameters are automatically preset:

Service type	ISDN dial line
Automatic answering.....	Enabled
ISDN call type	56 kbps data
Data protocol.....	Clear Channel
DTE mode.....	Synchronous
DTE connector bit rate	56 kbps
DTE flow control	none
RTS line	1 mS delay
CTS line	Forced on
Transmit data clock.....	Normal clock source
V.54 Loopbacks.....	Accepted

Dial 64K sync*

When the ISU 2x64 is configured for **Dial 64K sync** service, the following parameters are automatically preset:

Service type ISDN dial line
 Automatic answering Enabled
 ISDN call type 64 kbps data
 Data protocol Clear Channel
 DTE mode Synchronous
 DTE connector bit rate 64 kbps
 DTE flow control none
 RTS line 1 mS delay
 CTS line Forced on
 Transmit data clock Normal clock source
 V.54 Loopbacks Accepted

Dial 112K sync*

When the ISU 2x64 is configured for **Dial 112K sync** service, the following parameters are automatically preset:

Service type ISDN dial line
 Automatic answering Enabled
 ISDN call type 56 kbps data
 Data protocol BONDING mode 1
 DTE mode Synchronous
 DTE connector bit rate 112 kbps
 DTE flow control none
 RTS line 1 mS delay
 CTS line Forced On
 Transmit data clock Internal clock source
 BONDING timer TXINIT 10 seconds
 BONDING timer TXFA 10 seconds
 BONDING timer TXADD01 50 seconds
 BONDING timer TXDEQ 50 seconds
 BONDING timer TANULL 10 seconds
 BONDING timer TCID 5 seconds

Dial 128K sync*

When the ISU 2x64 is configured for **Dial 128K sync** service, the following parameters are automatically preset:

Service type	ISDN dial line
Automatic answering.....	Enabled
ISDN call type	64 kbps data
Data protocol.....	BONDING mode 1
DTE mode.....	Synchronous
DTE connector bit rate	128 kbps
DTE flow control	none
RTS line	1 mS delay
CTS line	Forced On
Transmit data clock.....	Internal clock source
BONDING timer TXINIT	10 seconds
BONDING timer TXFA	10 seconds
BONDING timer TXADD01	50 seconds
BONDING timer TXDEQ.....	50 seconds
BONDING timer TANULL.....	10 seconds
BONDING timer TCID	5 seconds

Dial 57.6 asyn*

When the ISU 2x64 is configured for **Dial 57.6 asyn** service, the following parameters are automatically preset.

Service type	ISDN Dial line
ISDN call type	64 kbps data
Data Protocol.....	V.120
DTE mode.....	Asynchronous
Data Bits.....	8
Parity Bits.....	none
Stop Bits	1
DTE connector bit rate	57.6 kbps
DTE flow control	none
RTS line	1 mS delay
CTS line	Forced On
Dialing Mode	AT Commands

Dial 115.2 asyn*

When the ISU 2x64 is configured for **Dial 115.2 asyn** service, the following parameters are automatically preset:

Service type ISDN dial line
 ISDN call type 64 kbps data
 Protocol BONDING mode 1
 DTE mode Asynchronous
 Data Bits 8
 Parity Bits none
 Stop Bits 1
 DTE connector bit rate 115.2 kbps
 DTE flow control none
 RTS line 1 mS delay
 CTS line Forced On
 Dialing Mode AT Commands

Fallback 57.6k*

When the ISU 2x64 is configured for **FALLBACK 57.6K** service, the following parameters are automatically set:

Service type Dial line
 Automatic answering Yes
 ISDN type 64 kbps data
 Data protocol Fallback
 DTE mode Asynchronous
 Data bits 8
 Parity bits none
 Stop bits 1
 DTE connector rate 57.6 kbps
 DTE flow control Hardware
 RTS line 1 mS delay
 CTS line Follows RTS
 Dialing Mode AT Commands

Leased 64K

When the ISU 2x64 is configured for **Leased 64K** service, the following parameters are automatically preset:

Service type Leased Line
Network clock source Slave
Channel rate 64K
Data Protocol..... Clear Channel
DDS loopbacks enabled..... Yes
DTE mode..... Synchronous
DTE connector bit rate 64 kbps
DTE flow control none
RTS line 1 mS delay
CTS line Forced On
Transmit data clock..... Normal clock source

Ldm 64K Master

When the ISU 2x64 is configured for a point-to-point application, such as a Limited Distance Modem arrangement, the **Ldm 64K Master** option automatically presets the following parameters:

Service type Leased Line
Network clock source Master
Channel rate 64K
Data Protocol..... Clear Channel
DDS loopbacks enabled..... Yes
DTE mode..... Synchronous
DTE connector bit rate 64 kbps
DTE flow control none
RTS line 1 mS delay
CTS line Forced On
Transmit data clock..... Normal clock source

Factory Setup

To restore the ISU 2x64 to the factory default setup, power the unit off and perform the following steps:

1. While pressing **0**, power the unit on.
2. Continue pressing **0** until the front panel displays the top of the menu tree. **1=STATUS** will be blinking.

Factory default erases all stored phone numbers, SPIDs, and LDNs, and sets parameters as follows:

Service type	ISDN dial line
ISDN switch type	AT&T 5ESS
ISDN call type	64 kbps data
Dialing Mode	Front Panel
Data protocol	Clear Channel
DTE connector bit rate	64 kbps
DTE flow control	none
RTS line	1 ms delay
CTS line	Forced CTS
CD line	Normal
DSR line	Forced
Transmit Data Clock	Normal clock source
BONDING timer TXINIT	10 seconds
BONDING timer TXFA	10 seconds
BONDING timer TXADD01	10 seconds
BONDING timer TXDEQ	50 seconds
BONDING timer TANULL	50 seconds
BONDING timer TXID	5 seconds
AT Command Escape character	+
AT Command End-of-Line character value	13
AT Command Line Feed character value	10
AT Command Backspace character value	8
RS-366 Dialing Default	5 seconds or EON
Automatic Answering	Enabled
AT Command Guard time	1 second
AT Command Miscellaneous Bits (S register 14)	10
AT Command MSG Bits (S register 22)	16

Chapter 9

Security and Remote Configuration

SECURITY

The ISU 2x64 provides a front panel keypad locking feature to prevent tampering with configuration settings. The feature requires a password to access menus below the top Current-Status menu level. The menu options are shown in Figure 9-1.

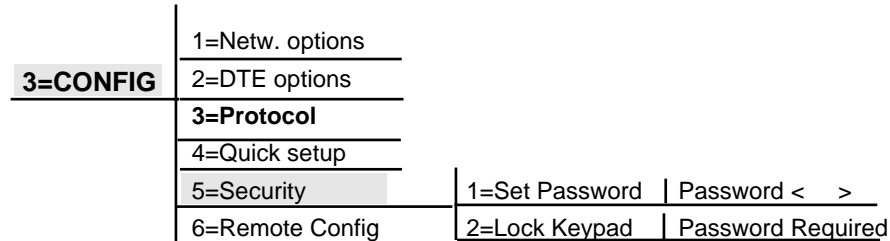

Figure 9-1
Security Menu Tree

When the front panel keypad is locked, only the top menu is available on the LCD display. The LCD can be toggled between **DTE1** and **DTE2** current status displays with the cursor keys. Any key other than a cursor key prompts the user for a password. If the entered password matches the stored password, the LCD displays a brief message indicating that the front panel is active and the configuration menus will be displayed as normal. After configuration is complete, the users must re-enable front panel locking by selecting **2=Lock Keypad** in the Security menu. If the entered

password does not match the stored password, the LCD displays a brief message indicating that the entered password was invalid and the top menu is displayed.

Set Password

Set Password prompts the user to enter a numeric code that will be required for access to configuration menus from the front panel. The code can be up to six digits long. The default state is nothing entered in the password option.

Lock Keypad

Lock Keypad locks the front panel keypad and displays a brief message on the LCD indicating that the front panel is locked. The top menu is displayed after the message.

REMOTE CONFIG

Remote Config (configuration) allows an ISU to be configured or tested over the ISDN line. A special call is made that places the answer unit in remote loopback for configuration or testing. The menu options are shown in Figure 9-2.

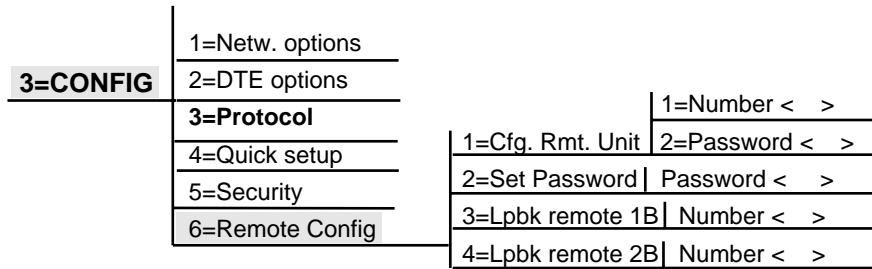

Figure 9-2
Remote Config Menu Tree

Cfg. Rmt. Unit

Cfg. Rmt. Unit causes the ISU 2x64 to place a call to a remote ISU for configuration. The user is prompted for the number to dial and the password for accessing the remote unit. After the call is placed, the local unit sends the entered password to the remote unit. If the password is correct, the remote unit confirms the password and configuration is allowed. If the remote unit has no password defined, press **Enter** at the prompt.

Set Password

Set Password prompts the user to enter a six digit numeric code that must be supplied when a remote configuration call is received. This password is the same as the password for front panel keypad locking. The default state is nothing entered in the password option.

Lpbk remote 1B

Lpbk remote 1B causes the ISU 2x64 to make a call to a remote ISU and place the remote ISU into a 1B-channel loopback. When the remoted unit is looped back, the local unit will send a test pattern (2047) to the remote unit and verify that the test pattern comes back uncorrupted. The user is prompted for the number to dial. Negotiation progress is displayed while the loopback call is in progress. Total bytes and Error bytes are displayed upon connection success. The **Cancel** key disconnects the call at any time.

Lpbk remote 2B

Lpbk remote 2B causes the ISU 2x64 to make a call to a remote ISU and place the remote ISU into a 2B-channel loopback. When the remoted unit is looped back, the local unit will send a test pattern (2047) to the remote unit and verify that the test pattern comes back uncorrupted. The user is prompted for the number to dial. Negotiation progress is displayed while the loopback call is in progress. Total bytes and Error bytes are displayed upon connection success. The **Cancel** key disconnects the call at any time.

Chapter 10

Troubleshooting

When the ISU 2x64 powers up, it performs an internal self test that takes approximately 10 seconds. At the end of the test, the front panel momentarily displays **Self Test Passed**.

If Self Test Fails

If **Self Test Passed** is not displayed, the following steps will verify whether or not the problem can be fixed locally:

1. Ensure the ISU 2x64 is receiving power.
2. Turn off the ISU 2x64 while holding down **0**, then power back on.
3. Continue to press down **0** for 15 seconds. This resets all the internal settings to factory defaults.
4. If the ISU 2x64 still does not pass self test, call ADTRAN Technical Support for assistance; see the back of this manual for phone numbers.

If The ISU 2x64 Does Not Read Ready

When the ISU 2x64 has been set up and connected to a line, but the front panel does not read **Ready** after a few minutes, use the following troubleshooting procedure:



If the Euro ISDN or VN4 switch type is selected, the unit will not enter the Ready state until a setup message is sent or received (part number 1200051L5 and 1200051L6).

1. Cycle power on the ISU 2x64, leaving it off for a minimum of 2 seconds. Turn the power on for one full minute to ensure the unit does not read **Ready**.
2. Disconnect the ISDN line from ISU 2x64. From a functioning voice phone, call the local directory number(s) provided with the line. Calling a good ISDN line with nothing connected usually results in a ring or fast busy tone. If someone answers or you get a not-in-service intercept, there is probably something wrong with the translation of the line. The phone service provider should be able to help.
3. If the ISU 2x64 continues to display **Link Down**, there is a physical problem with the phone line (more than likely, a problem with the layer 1 setup). The problem is in one or more of the following places:
 - The ISU 2x64 software setup
 - The ISU 2x64 hardware
 - The wiring on your premises
 - The telephone service provider's wiring
 - The telephone service provider's hardware
 - The telephone service provider's software setup

To isolate the problem, perform the following procedure:

- A. Ensure the ISDN line is plugged into the ISU 2x64 connector marked **ISDN IFC** on the back of the ISU 2x64.
- B. Ensure the ISU 2x64 is configured for dial line service.
- C. Try another piece of functioning ISDN equipment on the line.

- D. Talk to the service provider and ensure you have an ISDN Basic Rate U-Interface with 2B1Q line coding (wrong options are an S or T interface or AMI line coding) when using ISU 2x64 part number 1200051L1 or 1200051L3. If your ISDN line is extended from a PBX with an S/T line card, make sure you are using ISU 2x64 part number 1200051L2, 1200051L4, 1200051L5, or 1200051L6.
 - E. Ensure that the phone line is connected to the actual telephone line or PBX provided by your telephone company. If using ISU 2x64 part number 1200051L1 or 1200051L3 with the U-interface, make sure your line is not connected through another piece of equipment such as an NT1 in a wiring closet somewhere.
 - F. Ensure nothing else is bridged across the ISDN line pair.
 - G. With a minimum of extra wiring, try connecting to the ISDN line pair at the point where service provider's wiring ends.
 - H. With the ISU 2x64 connected to the ISDN line and powered up, talk to your service provider's repair group and inform them that your ISDN basic rate line has a physical layer 1 problem. Ask them to check the line. If using the ISU 2x64 1200051L1 or 1200051L3 with the U-interface, tell them that you have an NT1-like device at the end of the ISDN line.
4. If the ISU 2x64 continuously reads **Getting TEI #1**, the ISU 2x64 is physically connected to the local telephone service provider but is unable to establish logical layer 2. The problem is in one or more of the following places:
 - The ISU 2x64 software setup
 - The telephone service provider's software setup
 - Hardware configuration, if the line is extended from the switch

To isolate the problem, use the following procedure:

- A. Ensure the ISU 2x64 is set up for the correct switch type.
 - B. Ensure the quality of the line is satisfactory by checking for near- and far-end block errors (NEBEs and FEBEs). If the counts are non-zero, there may be a physical link problem as described under **Link Down** (Step 3).
 - C. Try another piece of functioning ISDN equipment on the ISDN line.
 - D. With the ISU 2x64 connected to the ISDN line and powered up, talk to the service provider's repair group and tell them you have an ISDN basic rate line that appears physically okay but has no terminal endpoint identifier (TEI). Ask them to check the line translation and ensure that the line supports dynamic TEI allocation. If using the ISU 2x64 part number 1200051L1 or 1200051L3 with the U-interface, tell them that you have an NT1 and terminal adapter device connected to the line.
5. If the ISU 2x64 continuously reads **Register SPID #1**, the ISU 2x64 is physically connected to the local telephone service provider and has established logical layer 2. The ISU 2x64 is unable to establish layer 3. The problem is in one or both of the following places:
- The ISU 2x64 software setup
 - The telephone service provider's software setup

To isolate the problem, perform the following procedure:

- A. Ensure the ISU 2x64 is set up for the correct switch type.
- B. Ensure the ISDN line is multipoint.
- C. Ensure that the ISU 2x64 is set up with the correct SPIDs and LDNs.
- D. Try another piece of functioning ISDN equipment on the ISDN line.

- E. With the ISU 2x64 connected to the ISDN line and powered up, talk to the service provider's repair group and tell them you have an ISDN basic rate line that appears physically okay but is unable to register its SPID(s). Ask them to check the line translation, ensure that the ISDN line supports dynamic TEI allocation, and verify the SPID(s). If using the ISU 2x64 part number 1200051L1 or 1200051L3 with the U-interface, tell them that you have an NT1 and terminal adapter device connected to the line.
6. If the ISU 2x64 continuously reads **Getting TEI #2**, the ISU 2x64 has completely initialized the first phone number but is unable to establish logical layer 2 for the second phone number. The problem is in one or both of the following places:
 - The ISU 2x64 software setup
 - The telephone service provider's software setup

To isolate the problem, perform the following procedure:

- A. Ensure the ISDN line is multipoint with two phone numbers.
- B. Ensure that the ISU 2x64 is set up with the correct SPIDs and LDNs.
- C. Try swapping SPID1 with SPID2 and LDN1 with LDN2. Determine if the problem is the second phone number or the quantity of phone numbers.
- D. Try another piece of functioning ISDN equipment on the ISDN line.
- E. With the ISU 2x64 connected to the ISDN line and powered up, talk to the service provider's repair group and tell them you have an ISDN basic rate line that appears physically okay but has no terminal endpoint identifier (TEI). Ask them to check the line translation and ensure that the ISDN line supports dynamic TEI allocation. If using the ISU 2x64 part number 1200051L1 or 1200051L3 with the U-interface, tell them that you have an NT1 and terminal adapter device connected to the line.

7. If the ISU 2x64 continuously reads **Register SPID #2**, the ISU 2x64 has completely initialized the first phone number but is unable to establish logical layer 3 for the second phone number. The problem is in one or more of the following places:
 - The ISU 2x64 software setup
 - The telephone service provider's software setup

To isolate the problem, perform the following procedure:

- A. Ensure the ISDN line is multipoint with two phone numbers.
- B. Ensure that the ISU 2x64 is set up with the correct SPIDs and LDNs.
- C. Try swapping SPID1 with SPID2 and LDN1 with LDN2. Determine if the problem is the second phone number or the quantity of phone numbers.
- D. Try another piece of functioning ISDN equipment on the ISDN line.
- E. With the ISU 2x64 connected to the ISDN line and powered up, talk to the service provider's repair group and tell them you have an ISDN basic rate line that appears physically okay but is unable to register its SPID(s). Ask them to check the line translation, ensure that the ISDN line supports dynamic TEI allocation, and verify the SPID(s). If using the ISU 2x64 part number 1200051L1 or 1200051L3 with the U-interface, tell them that you have an NT1 and terminal adapter device connected to the line.

If the Wrong DTE Port Answers a Call

A common mistake that can easily be made is entering the SPID/LDN pair swapped between the two DTE ports. For example, your telephone company has given you two SPID/LDN numbers as follows:

SPID1 - 201555701111 LDN1 - 5557011

SPID2 - 201555702222 LDN2 - 5557022

If you were to enter the pairs for DTE#1 as SPID1/LDN2 and SPID2/LDN1, the ISU 2x64 would get confused during incoming calls because the SPID/LDN pair does not match. Be sure to enter the SPID/LDN pairs for each DTE# as follows:

Enter SPID dte1	Enter LDN dte1
201555701111	5557011

Enter SPID dte2	Enter LDN dte2
201555702222	5557022



Proper entry of the SPID/LDN pair is crucial to proper operation of the ISU 2x64.

If you Cannot Connect Calls

See Table 10-A for corrective actions if you cannot place calls.

Table 10-A
Troubleshooting Calls

Condition	Corrective Action
The ISU 2x64 reads Ready but calls cannot be placed.	There is most likely a problem in the software setup (translation) at the CO switch or the network setup in the ISU 2x64.
Local voice calls can be transmitted, but data calls to the same exchange cannot.	The ISDN line is probably not set up to support data calls.
Local data calls go through, but long distance data calls do not.	Ensure the far end is working. If not already doing so, place the call explicitly specifying the prefix of the long distance service (for example, 10288 for AT&T). If this does not work, then most likely the problem is the long distance service provider. Another possibility is that the local service provider is not providing long distance access.
Data calls can be made, but BONDED data calls cannot.	There is most likely a problem in the software setup (translation) at the CO switch or the network setup in the ISU 2x64. Another possibility is that the data circuits provided are not good enough to support the BONDING negotiation process. If the line has two phone numbers, make sure the second SPID and LDN are entered correctly in SPID2 and LDN2 in the ISU 2x64. Check with the local service provider to ensure that the line supports two data calls. The ISU 2x64 status log buffer shows the sequence of events that occurred. You need to know which piece of equipment first caused the BONDING process to terminate. The status logs from both ends may be necessary to determine this.

Chapter 11

Specifications

Network Interface

- RJ-45 for ISDN Basic Rate U-Interface, part numbers 1200051L1 and 1200051L3
- RJ-45 for ISDN Basic Rate S/T Interface, part numbers 1200051L2, 1200051L4, 1200051L5, and 1200051L6.

DTE Interface

- Two DB-25s, each RS-530/EIA-232 interfaces (V.35 interfaces available with RS-530-to-V.35 adapters, part number 1200072L1)

Dialing Selections

- In-band DTE Dialing: V.25 bis or AT commands
- Dial Interfaces: Two RS-366 interfaces (DB-25s)
- Manual or automatic stored number dialing, DTR Assertion
- Front panel manual dialing

Data Rates (Network)

- 64 kbps (1 B channel), 128 kbps (2 B channels)

Data Rates (DTE)

When using single DTE interface:

- 300 bps to 115.2 kbps asynchronous
- 2400 bps to 128 kbps synchronous

When using dual DTE interfaces:

- 300 bps to 57.6 kbps asynchronous on each interface
- 2400 bps to 64 kbps synchronous on each interface

B Channel Aggregation

- BONDING Protocol Mode 1. Used for speeds over 64 kbps from a single DTE interface.
- RFC 1717 Multilink PPP used for speeds over 57.6 kbps for a single DTE interface.

Rate Adaptation

- T-Link
- CCITT V.120
- CCITT V.110
- Clear Channel
- SAP
- FALLBACK
- DSU 57.6 Async
- BONDING mode 1
- PPP Async-Sync
- Multilink PPP

Interoperability

- BONDING Mode 1-compatible Inverse Multiplexers (ASCEND, PROMPTUS, Teleos, etc.)
- Switched-56 DSUs (2-wire and 4-wire), ISU 128s, ISDN TAs
- PPP/Multilink compatible devices

Switch Compatibility

- AT&T 5ESS, NTI DMS-100, National ISDN-1, NEC, Euro ISDN*, TDX10*, TDX1B*, KDD*, NTT*, and VN4*.

**Only available on part numbers 1200051L5 and 1200051L6.*

Display

- Two-line by 16-character LCD
- LED Indicators:
 - RS Request to Send
Indicates the DTE is ready to transmit.
 - CS Clear to Send
Indicates the ISU 2x64 is ready to transmit.
 - TD Transmit Data
On when the DTE is transmitting to the ISU 2x64
 - RD Receive Data
On when the ISU 2x64 is receiving data from the far-end
 - CD Carrier Detect
On when the ISU 2x64 is ready to transmit data
 - TR Data Terminal Ready from DTE
On when DTR is active at the DTE interface
 - SR Data Set Ready

Environmental

- Operating Temperature: 0 to 50 °C
- Storage Temperature: -20 to 70 °C
- Relative Humidity: Up to 95%, non-condensing

Physical

- 2.25" high x 8.75" wide x 11.00" deep, 3 lbs

Power

- 115 VAC, 60 Hz, 8 W maximum dissipation (part numbers 1200051L1, 1200051L2, and 1200051L5)
- 220 VAC, 50 Hz, 10 W maximum dissipation (part numbers 1200051L3 and 1200051L4)
- 230 VAC, 50 Hz, 10 W maximum dissipation (part number 1200051L6)

Appendix A

AT Commands

This Appendix lists the supported AT commands and descriptions of their functions. Bold text indicates default settings.

Command	Function
A	Answer. Puts the ISU 2x64 in answer mode.
D	Dial. Precedes the telephone access number [ATD5551212].
H	Hang up. Disconnects the current call.
O	On line. Commands the unit to go back on line.
S	S Register.
SS	S String register.
Z	Reset. Resets the AT command processor.
&W	Save. Save current configuration to EEPROM.
+++	Break in. Break in AT command processor during an active call. The break in character can be defined in S2.
_U	Reset ISDN interface.
!S	Dump Status Buffer contents to the DTE port.
_Z	Power resets unit.

Command Function

Carrier Detect (CD) Control Line Options

&C0	CD forced On
&C1	CD normal
&C2	CD off with local disconnect (LOCD)
&C3	CD off with Link Down

Data Terminal Ready (DTR) Control Line Options

&D0	Ignore DTR
&D1	DTR Off forces command
&D2	Idle when Off, DTR Off forces idle (On allows auto answer)

Generic Unit Configurations

&F0	Resets all S-registers to factory preset values
&F1	Configures unit for Dial 56k sync
&F2	Configures unit for Dial 64k sync
&F3	Configures unit for Dial 112k sync
&F4	Configures unit for Dial 128k sync
&F5	Configures unit for Leased 64k
&F6	Configures unit for Ldm 64k master
&F7	Configures unit for Dial 57.6k async
&F8	Configures unit for Dial 115.2k async
&F11	Configures unit for FALLBACK 57.6k async

Network Options

&L0	Dial network
&L1	Leased network

Calling Number Identification

&N0	Number 1. Read far-end phone number 1 if service subscribed from telephone company.
&N1	Number 2. Read far-end phone number 2 if service subscribed from telephone company.

Command	Function
----------------	-----------------

DTE Data Type Options

&Q0	DTE is async
&Q1	DTE is sync

Clear-To-Send (CTS) Control Line Options

&R0	Follows RTS
&R1	Forced CTS

Data Set Ready (DSR) Control Line Options

&S0	DSR forced On
&S1	DSR if call up
&S2	DSR if link up

DTE Connector Data Synchronous Data Clocking Options

&X0	Internal transmit clock
&X1	External transmit clock

Assigning Stored Numbers for Dialing Options

&Z0	Stored number 0
&Z1	Stored number 1
&Z2	Stored number 2
&Z3	Stored number 3
&Z4	Stored number 4
&Z5	Stored number 5
&Z6	Stored number 6
&Z7	Stored number 7
&Z8	Stored number 8
&Z9	Stored number 9

Local Echo Options

E0	Disable local echo
E1	Enable local echo

Unit Identification

I0	Identify unit. Commands the unit to display model number.
I1	Identify software. Commands the unit to display software version.

Command Function

AT Command Response Message Options

Q0 **Response messages on**
Q1 Response messages off

AT Command Response Message Types

V0 Response messages codes
V1 **Response messages words**

AT Command Connect Message Options

X0 Simple connect message
X1-7 **Connect messages with bit rate**

Ready-To-Send (RTS) Control Line Options

_D0 **1 mS delay**
_D1 18 mS delay

MakeBusy Options

_B0 **Make DTE port not busy (same as S135=0).**
_B1 Make DTE port busy (same as S135=1).

Service Profile Identification (SPID) Access Options

_I0= Access SPID#1 for DTE #1
_I1= Access SPID#2 for DTE #2

Local Directory Number (LDN) Access Options

_N0= Access LDN1 for DTE #1
_N1= Access LDN2 for DTE #2

ISDN Switch Type Options

_S0 **5ESS**
_S1 DMS-100
_S2 National ISDN-1
_S3 NEC
_S4 Euro ISDN*
_S5 VN4*

Command Function**ISDN Switch Type Options (continued)**

_S6	TDX10*
_S7	TDX1B*
_S8	KDD*
_S9	NTT*

*Only available on part numbers 1200051L5 and 1200051L6.

ISDN U-Interface Operational Mode Options

_X0	ISU timing slaves to network (NT mode)
_X1	ISU is U-interface timing master (LT mode)

Data Flow Control Options

\Q0	No flow control
\Q1	Software
\Q2	CTS only
\Q3	Hardware

Dump Status Buffer

!S	Sends complete log of all messages stored in the StatusBuffer.
----	--

VT 100 Terminal Menus

!V	Enables VT 100 compatible menuing system via the DTE connector.
----	---

Appendix A: AT Commands

Appendix B

Current Status Messages

This appendix lists the status line messages and their definitions. Messages shown entirely in capital letters are generated by the ISDN network. Messages with lower case letters are generated by the ISU 2x64.

AT&T-5ESS Ready

The ISU is connected to an AT&T-5ESS switch and is ready to place/receive calls.

Call Connect B1

Bearer channel 1 is connected and is active.

Call Connect B2

Bearer channel 2 is connected and is active.

CALL xxxxxxxx

The ISU is calling phone number xxxxxxxx.

DEACTIVATED

The network interface is not active.

DISCONNECTED

The network has activated layer 1 but layer 2 is inactive. To activate the unit a setup message must be sent or received.

DISCONNECTING

The current phone call is being disconnected (hung up).

DMS-100 Ready

The ISU is connected to a DMS-100 switch and is ready to place/receive calls.

Euro ISDN Ready

The ISU 2x64 is connected to a Euro ISDN switch and is ready to place/receive calls.

Getting TEI #1

The ISU is receiving its first TEI from the network.

Getting TEI #2

The ISU is receiving its second TEI from the network.

ISDN-1 Ready

The ISU is connected to an ISDN-1 compliant switch and is ready to place/receive calls.

Link down

The network interface is not active.

Link In Sync

The ISU has successfully connected to the network but is waiting for the switch to issue the ACT bit.

LPBK DTE

The DTE connector is looped back in the DTE direction.

LPBK Netw

The ISU 2x64 is in a customer initiated loopback.

LPBK Protcl.Net

The ISU 2x64 has been commanded to perform a loopback in the network direction after letting the incoming data pass through the current protocol.

NEC Ready

The ISU 2x64 is connected to an NEC switch and is ready to place/receive calls.

NET EOC LOOPBACK

The ISU 2x64 has been commanded to perform an ISDN loopback toward the network.

NET REM LOOPBACK

The ISU 2x64 is performing a V.54 or DDS latching loopback toward the network.

Ready

The unit is ready to make or accept a call.

Register SPID #1

The ISU 2x64 is registering its first SPID with the network.

Register SPID #2

The ISU 2x64 is registering its second SPID with the network.

RINGING

The phone number just dialed is ringing.

xxxx nnnn

A rate adaptation is running at the bit rate specified by nnnn.

xxxxx Quitting

A rate adaptation protocol is turning off.

xxxxx Ready

A rate adaptation protocol is ready.

xxxxx Setup

A rate adaptation protocol is setting up.

xxxxx can be any of the following:

BONDING

Bandwidth on Demand Interoperability Users Group protocol.

CLEAR CHAN

No rate adaptation protocol (allows use of maximum bandwidth).

DSTOP

DSU 57.6 Async rate adaptation protocol.

DSU57.6

ADTRAN DSU asynchronous protocol.

FALLBACK

FALLBACK rate adaptation protocol.

SAP

Simple Adtran Protocol.

TLINK

TLINK rate adaptation protocol.

V120

V.120 rate adaptation protocol.

V110

V.110 rate adaptation protocol.

Appendix C

Status Buffer Messages

Messages shown entirely in capital letters are generated by the ISDN network. Messages with lower case letters are generated by the ISU 2x64.

Answer 1/2

The ISU answered a call on either the first or second B channel. The calling phone number is displayed if available.

ACCESS_INFO_DISCARDED

The network was unable to deliver access information to the far-end.

Back to online

ISU 2x64 went back on line.

Bad async BPS

The BONDING protocol determined that the selected asynchronous bit rate is not supported.

Bad AT bit field

User issued an AT command with an argument that was out of range.

Bad B channel

Bonding negotiation determined the delay in one of the Bearer channels was uncorrectable.

Bad call type

ISU 2x64 placed a call with an improper call type.

Bad DTE baud

The DTE bit rate does not match a valid bit rate for the protocol selected.

Bad DTE bps

Bonding negotiation determined the chosen DTE bit rate is invalid.

BAD_INFO_ELEM

Call control error.

Bad phone number

ISU 2x64 attempted to call an invalid phone number.

Bad TLK Version

Invalid TLINK parameters found during end-to-end negotiations.

Baud Rate

ISU 2x64 does not support the negotiated TLINK baud rate.

BEAR_CAP_NOT_AVAIL

The bearer channel requested by the user is not available.

Bearer mode

Incoming call is not of a type the ISU 2x64 can accept.

Bearer info mode

Incoming call information transfer capability is not known.

BONDING (+/- XXX)

The amount of bytes of corrected delay between the B2 and B1 bearer channels (XXX can range from -8000 to +8128 bytes).

BPS mismatch

Bonding negotiation found a bit rate mismatch.

Break to AT cmd

User issued a break-in request (+++).

Break ignored

User issued an extra break-in request.

BUSY

The called number is busy.

CallID 1 in use

ISU 2x64 tried to place a call using SPID 1 when SPID 1 was already in use.

CallID 2 in use

ISU 2x64 tried to place a call using SPID 2 when SPID 2 was already in use.

Call not ringing

User executed an answer command (ATA) but there was not a call present.

CALL_REJECTED

The call has been rejected by the ISDN network.

Can't go online

ISU 2x64 cannot go back on line. User issued an unknown AT command.

CAP_NOT_IMPLEMENTED

The network or far-end does not support the bearer capability requested.

CHAN_DOES_NOT_EXIST

The bearer channel requested is not present.

CHAN_NOT_IMPLEMENTED

The bearer channel requested has not been implemented.

CHANNEL_UNACCEPTABLE

The channel requested has not been subscribed.

CID>0 rcvd

Received an incoming call from a third party during Bonding set-up with far end.

DEST NOT ISDN

The number called is not ISDN (warning only).

DEST_OUT_OF_ORDER

The called number is out of order.

Dial1/2

The ISU 2x64 placed a call on either the first or second channel. The number called is displayed following the message.

Discon1/2

The call on either the first or second channel was disconnected from the network. The far-end phone number is displayed if available.

Disconnect Req

Far-end unit disconnected during BONDING negotiation.

DPUMP END RCVD

Indication of a hang-up or disconnect occurring during BONDING. Does not indicate an error condition has occurred.

DTE must be SYNC

For the protocol chosen, the DTE connector must be optioned as synchronous.

DTE not set V25

The DTE equipment is not optioned for the same bit rate as the ISU 2x64 for V.25 bis dialing.

DTR not up

ISU 2x64 tried to place a call in a dialing mode that requires DTR to be in an active state but it is not.

Dump call

ISU 2x64 could not accept an incoming call because it was already involved in a call.

Dump1/2

An incoming call on either the first or second channel was discarded by the ISU. The calling number is displayed if available.

FACILITY_NOT_IMPLEMENT

The network does not support the requested supplementary service.

FACILITY_REJECTED

A facility requested cannot be provided by the network.

FACILITY_NOT_SUBSCRIBED

The channel type requested has not been subscribed.

FALLBACK_ERROR

Attempt to fallback to normal mode failed.

FBW_disconnect

BONDING negotiation has failed due to a disconnect on a B-Channel.

FlowCtl_mismatch

Bonding negotiation determined a flow control mismatch.

FlowCtl_required

Bonding negotiation determined that flow control needs to be optioned on.

Hangup1/2

The call on either the first or second channel was disconnected by the ISU 2x64. The far-end phone number is also displayed.

InCmptblFound

TLINK end-to-end negotiations found an optioning incompatibility between the two end units.

INCOMMING_CALL_BARRED

The network will not allow an incoming call.

INCOMPATIBLE_DEST

The called number cannot accept the type of call that has been placed.

INTRWORKING_UNSPEC

A message was sent by a far-end network that was not understood.

INVALID_CALL_REF

Call control error.

INVALID_ELEM_CONTENTS

Call control error.

INVALID_MSG_UNSPEC

Invalid message, protocol error.

INVALID_NUMBER_FORMAT

The dialed number has an invalid format.

L1 not up

Call has been attempted while the network interface is not active.

L2 not up

Call has been attempted while the data link layer interface is not active.

L3 not up

Call has been attempted while the call control interface is not active.

L2 #2 not up

Call has been attempted while the data link layer interface for a second call (BONDING) is not active.

L3 #2 not up

Call has been attempted while the call control layer interface for a second call (BONDING) is not active.

LDN TOO LONG

The local directory number entered has too many digits.

MANDATORY_IE_LEN_ERR

Mandatory information element length error.

MANDATORY_IE_MISSING

Mandatory information element missing.

Need 2 B chan

The DTE bit rate requires the BONDING protocol.

Need 64K call

The BONDING protocol requires the ISU 2x64 to be configured for a 64kbps data call type.

Negotiation fail

The BONDING negotiation has failed.

NETWORK BUSY

The ISDN switch is busy and unable to process a call.

NETWORK_CONGESTION

The phone network is currently congested.

NETWORK_OUT_OF_ORDER

The phone network is out of order.

No 48K Support

The ISU 2x64 does not support 48 kbps TLINK. Local DTE setup error.

NO_CIRCUIT_AVAILABLE

The requested bearer channel is not available.

NONEXISTENT_MSG

Nonexistent message was sent by the ISU 2x64.

No Sreg number

Attempt to access an S register without specifying a specific S-register (example: ATS=1).

No Sreg value

Attempt to change an S-register without specifying a value (example: ATS2=).

NO_ROUTE

The phone network was unable to find a route to the destination number.

NO_USER_RESPONDING

The dialed number is not responding.

NORMAL_CLEARING

The network is disconnecting the current call.

NOT end2end ISDN

The path that the call was routed over is not ISDN from end-to-end (warning only).

NUMBER_CHANGED

The number dialed has been changed.

OUTGOING_CALL_BARRED

The network will not allow the outgoing call to be placed.

PROTOCOL_ERROR

Call control error.

REQ_CHANNEL_NOT_AVAIL

The channel type requested is currently not available.

Remote not ISU

Bonding negotiation determined the far-end unit is not another ISU. (Asynchronous rates can only be supported between two ADTRAN ISUs when Rev. 0 Bonding Mode 1 is selected. Rev. 1 Bonding Mode 1 will interoperate with other vendor terminal adapters in asynchronous DTE operation.)

RESP_TO_STAT_ENQ

Response to status inquiry.

Ring 1/2

An incoming call on either the first or second channel entered the Ring state. The calling phone number is displayed if available.

S cmd not = or ?

User did not use proper syntax.

SAP idle timeout

Unit at far-end is not configured to use the SAP protocol.

SERVICE_NOT_AVAIL

The requested service is not available.

SOURCE NOT ISDN

The incoming calling party is not ISDN (warning only).

SReg Set Error

Local DTE invalid S-register setting.

Sync BPS < 56K

The synchronous bit rate selected is too slow for the BONDING protocol.

Synch Mismatch

Both ends bad synchronization.

TAINIT expired

Bonding timer TAINIT expired.

TANULL expired

Bonding timer TANULL expired, non BONDING equipment attempted to call into the ISU 2x64 while optioned for BONDING.

TEMPORARY_FAILURE

The network has temporarily failed; try the call again.

TIMER_EXPIRY

Call control error.

TLINK ErrorOne

Catastrophic TLINK error.

TXADD01 expired

Bonding timer TXADD01 expired, probably making a long distance call to a foreign country; adjust timer value to correct.

TXFA1 expired

Bonding timer TXFA1 expired; other vendor's BONDING equipment did not operate properly.

TX FLOW ERROR

Flow control needs to be enabled.

TXFA2 expired

Bonding timer TXFA2 expired; other vendors BONDING equipment did not operate properly.

TXINIT expired

Bonding timer TXINIT expired, called non-BONDING equipment or B channel not error free.

UNASSIGNED_NUMBER

The phone number dialed does not exist.

Unknown AT & cmd

User issued an unknown AT command.

UNSPECIFIED_CAUSE

Received a cause message from the network that is not understood.

Unsupported baud

The ISU 2x64 does not support the negotiated baud rate.

USER_BUSY

The dialed number is busy.

V120 timeout

The far end unit is not set up for V.120 or B channel not error free.

V120 connected

The V.120 rate adaptation successfully connected to the far-end unit.

WRONG_MESSAGE

Call control error.

WRONG_MSG_FOR_STATE

Call control error.

Appendix D

S-Register List

S0.....AUTO ANSWER	Determines how the ISU 2x64 answers an incoming call. 0 = Disable (ISU 2x64 does not answer call) 1 = Enable (ISU 2x64 answers all calls) (default) 2 = Dump all calls
S2.....BREAK IN CHARACTER	Determines which key or character (in ASCII code) defines the escape command. The standard escape character is a + sign (ASCII value of 43 decimal). To change the character set, set S2 to the desired ASCII value. Range = 0 to 127
S3.....END OF LINE CHARACTER	Determines which key or character (in ASCII code) ends a command line. The standard end-of-line character is the carriage return (ASCII value of 13 decimal). Range = 0 to 127
S4.....LINE FEED CHARACTER	Determines which key or character (in ASCII code) advances the cursor to the next line after ending a command line or after an ISU 2x64 message. The standard character is the line feed (ASCII value of 10 decimal). Range = 0 to 127
S5.....BACK SPACE CHARACTER	Determines which key moves the cursor back one space to erase a character. The standard character is the backspace (ASCII value of 8 decimal). Range = 0 to 127

Appendix D: S-Register List

S6.....DTR DIAL DELAY	Delay time in minutes between consecutive outgoing calls when DTR is set for Dial #0 if on option.
S7.....CONNECT TIME	Determines how long the ISU 2x64 waits for an outgoing call to be answered. 15 = 15 seconds 30 = 30 seconds (default) 60 = 1 minute 120 = 2 minutes 240 = 4 minutes
S9.....CLEAR CHAN DELAY	The value multiplied by eight determines the number of bytes between receive data and transmit data.
S10.....DISABLE REMOTE CONFIG	Disables the two-second delay at the beginning of each incoming call that scans for remote configuration data. <i>FALLBACK protocol cannot be used when this option is set!</i> 0 = Remote Config enabled 1 = Remote Config disabled
S12.....ESCAPE TIME	Determines the delay required immediately before and after entering the escape command for the ISU 2x64 to recognize and execute the command. Range = 0 to 127 (default = 1 second)
S14.....MISC BITS	Miscellaneous bits (bit 8 is most significant bit) . Bit 2 = 1: enables on screen echo of AT commands. Bit 2 = 0: disables on screen echo of AT commands. Bit 3 = 0: enables AT responses from the ISU 2x64. Bit 3 = 1: disables AT responses from the ISU 2x64. Bit 4 = 1: enables AT responses to be displayed in text form. Bit 4 = 0: enables AT responses to be displayed in numeric form.
S15.....ASYNC BONDING REV	Determines the revision level Bonding negotiates for asynchronous connections. 0 = ADTRAN original Async. Bonding 1 = Multivendor Async. Bonding (default)

S22.....MSG BITS	Miscellaneous message bits (bit 8 is most significant bit). Bit 5 = bit 6 = bit 7 = 1 allows connect message with baud rate. Bit 5 = bit 6 = bit 7 = 0 connect message without baud rate.
S23.....MAKE BUSY FEATURE BUTTON NUMBER	Number assigned by the telephone company when requested by user. Make Busy option is translated for an ISDN line and the feature button number must be entered into this S register. Useful for Hunt-Group operation. Range = 0 to 255 0 is default.
S24.....V.120 LOW LAYER COMP.	Value determines whether or not the V.120 bit is set in setup messages for CCITT V.120 calls. Some terminal adapters require that this bit be set to connect V.120 calls. 0 = Set V.120 bit in call setup message (default) 1 = Do not set V.120 bit in call setup message
S25.....DTR DELAY	Value determines the minimum time a change of state on DTR must last before the unit responds. The value is in hundredths of seconds. Range = 0 to 255 5 is default (50 milliseconds)
S26.....DTE RATE ADJUST	Determines CLEAR CHAN protocol automatically reducing DTE RATE for non-64K call types. 0 = CLEAR CHAN changes DTE rate from 64K to 56K for non-64K call types (default). 1 = CLEAR CHAN does not change DTE rate from 64K to 56K for non-64K call types.
S27.....PPP MODE	Value determines whether PPP will be a single-link or multilink connection. 0 = Single-link operation (default) 1 = Multi-link operation 2 = Use compression

Appendix D: S-Register List

S30.....DTE CTS	Controls the operation of the DTE connector CTS line. 0 = Follows RTS 1 = Forced CTS (default)
S31.....DTE RTS	Controls operation of the RTS line. 0 = 1 ms delay (default) 17 = 18 ms delay
S32.....DTE DSR	Controls the operation of the Data Set Ready signal on the DTE connectors. 0 = Force DSR on always (default) 1 = DSR active only during a call 2 = DSR active only when network interface is on
S33.....DTE CD	Controls the operation of the Carrier Detect line on the DTE connectors. 0 = Force CD on always 1 = CD is active during a call (default) 2 = LOCD 3 = Off Link Down
S34.....DTE DTR	Determines how the ISU 2x64 responds to changes in DTR. 0 = Ignore DTR (default) 1 = Force AT command mode when DTR is off 2 = Dump incoming call when DTR is off 4 = Hang up incoming call when DTR is off 8 = Hang up outgoing call when DTR is off 40 = Dial #0 if on 60 = Dial / Answer if on 72 = Off on dial #0
S35.....DTE CONN	Determines which is the current operating DTE connector. 0 = RS-530 connector (default) 1 = V.35 connector 2 = EIA-232
S40.....BOND TXINIT	Specifies the number of seconds the originating endpoint attempts to detect the BONDING negotiation pattern from the answering endpoint before determining the BONDING call has failed. 0 to 256, 10 sec is default

S41.....BOND TXFA	Specifies the number of seconds both endpoints attempt to detect the BONDING frame pattern when a call is connected before deciding the BONDING call has failed. When operating with other manufacturer's BONDING equipment, it may be necessary to lengthen this timer to match TXADD01. 0 to 256, 10 sec is default
S42.....BOND TXADD01	The number of seconds both endpoints waits for the additional call to be connected at the end of negotiation before determining the BONDING call has failed. When dialing overseas it may be necessary to lengthen this timer to allow for lower call routing. 0 to 256, 50 sec is default.
S43.....BOND TXDEQ	The number of seconds both endpoints attempt to equalize the network delay between the bearer channels before determining the BONDING call has failed. 0 to 256, 5 sec is default.
S44BOND TANULL	The number of seconds the answering endpoint attempts to detect the BONDING negotiation pattern from the originating endpoint before aborting to clear channel mode. It may be necessary to shorten this timer if the DTE equipment connected to the ISU 2x64 also has timer constraints for completing non-BONDING parameter negotiation. 0 to 256, 10 sec is default.
S45.....BOND TCID	The number of seconds both endpoints attempt to negotiate agreeable values for bearer channels and channel capacities before determining the BONDING call has failed. 0 to 256, 5 sec is default.
S46.....V25 MODE	Selects the type of V.25 bis dialing used. 0 = Asynchronous V.25 1 = HDLC V.25 2 = BISYNC V.25

Appendix D: S-Register List

S47.....RS 366 TIME	Determines the amount of time the RS-366 port waits for either EON or inactivity to terminate a dial string before dialing a number. 0 = Wait for EON only 10 = Wait for 1 second or EON 20 = Wait for 2 seconds or EON 50 = Wait for 5 seconds or EON (default) 100 = Wait for 10 seconds or EON 200 = Wait for 20 seconds or EON
S50.....LINE MODE	Selects the operating mode of the ISU 2x64. 0 = Dial service (switched service) (default) 1 = Leased service (non-switched service)
S51.....LINE CLOCK	Selects the clock mode in leased mode. 0 = Slave (default) 1 = Master (Leased line only, LDM application only)
S52.....SWITCH TYPE	Selects the network switch type for dial service. 0 = AT&T 5ESS (default) 1 = Northern Telecom DMS-100 2 = National ISDN-1 3 = NEC 4 = Euro ISDN* 5 = VN4* 6 = TDX10* 7 = TDX1B* 8 = KDD* 9 = NTT*

**Only available on part numbers 1200051L5 and 1200051L6.*

S53.....CALL TYPE	Call type 0 = Speech 1 = Audio 2 = 56 kbps data 3 = 64 kbps data (default) 5 = 128 kbps data
-------------------	---

S54.....PROTOCOL TYPE	Rate adaptation protocol type. 1 = Clear Channel (no rate adaptation) (default) 2 = BONDING mode 1 3 = SAP (Simple Asynchronous Protocol) 4 = T-link 5 = V.110 6 = V.120 9 = DSU 57.6 kpbs asynchronous 11 = FALLBACK 12 = PPP
S55.....DIAL MODE	Selects dialing interface. 0 = Front panel only (dialing from front panel is always available) (default) 1 = RS-366 dialing port 2 = AT commands 3 = V.25 bis dialing
S56.....ECHO TONE	Enables an echo tone which suppresses the echo cancellers in a voice circuit. Can be used to trick the switch to allow sending data over a line optioned for voice ISDN service. 0 = None (default) 1 = Answer 2 = Originate 3 = Both
S57.....DDS TEST	Allows an ISU 2x64 optioned as a leased line unit to respond to either DDS inband latching loopback and/or V.54 loopback commands. 0 = No Rem Lpbks 1 = DDS Accepted 2 = V.54 Accepted (default) 3 = DDS + V.54 Accepted
S58.....CALL SCREENING	Allows the ISU 2x64 to screen incoming calls. 0 = Answer any call (default) 1 = Answer only calls from numbers matching those stored in SN0 through SN9.

Appendix D: S-Register List

S59.....CHANNEL RATE	Sets the available network bandwidth when the ISU 2x64 is in leased mode. 3 = 64 kbps 5 = 128 kbps
SS60.....SPID1 LOC	Primary SPID string location.
SS61.....SPID2 LOC	Secondary SPID string location.
SS62.....LDN1 LOC	Primary local directory number string location.
SS63.....LDN2 LOC	Secondary local directory number string location.
S70.....DTE MODE	Selects asynchronous or synchronous mode on the DTE connector. 0 = Asynchronous 1 = Synchronous (default)
S71.....DTE RATE	Selects the DTE connector bit rate. 1 = 300 3 = 1200 6 = 2400 8 = 4800 11 = 9600 15 = 19200 17 = 38400 18 = 48000 19 = 56000 20 = 57600 21 = 64000 (default) 22 = 112000 23 = 115200 24 = 128000
S72.....DATA BITS	Selects the number of asynchronous data bits. 0 = 8 bits (default) 1 = 7 bits
S73.....DTE PARITY	Selects the number of asynchronous parity bits. 0 = None (default) 1 = Odd 2 = Even

S74.....DTE STOP	Selects the number of asynchronous stop bits. More than one option can be set at the same time. 0 = 1 stop bit (default) 1 = 1.5 stop bits 2 = 2 stop bits
S75.....DTE FLOW	Selects asynchronous flow control 0 = None (default) 1 = Hardware flow. CTS from DCE controls DTE. 2 = Hardware flow. RTS from DTE controls DCE. 3 = Hardware flow. RTS and CTS flow control. 4 = Software flow. XON/XOFF from DCE controls DTE. 8 = Software flow. XON/XOFF from DTE controls DCE. 12 = Software flow. XON/XOFF controls DTE and DCE.
S76.....DTE CLOCK	Selects DTE connector transmit clock timing source. 0 = Internal (ISU 2x64 supplies timing) (default) 1 = External (DTE supplies timing)
S135.....	Value determines whether or not the ISDN switch should consider a DTE port busy. S23 must be programmed before this register is used. 0 = DTE port is not busy (default) 1 = DTE port is busy

The following are the string locations for stored numbers 0 - 9:

SS80.....SN0 LOC	Stored number 0 string
SS81.....SN1 LOC	Stored number 1 string
SS82.....SN2 LOC	Stored number 2 string
SS83.....SN3 LOC	Stored number 3 string
SS84.....SN4 LOC	Stored number 4 string
SS85.....SN5 LOC	Stored number 5 string
SS86.....SN6 LOC	Stored number 6 string
SS87.....SN7 LOC	Stored number 7 string
SS88.....SN8 LOC	Stored number 8 string
SS89.....SN9 LOC	Stored number 9 string
S118 = 0	CHAP Authentication (default)
S118 =32	PAP Authentication (required for MP connection with WIN 95)

Appendix D: S-Register List

Appendix E

Connector Pinouts

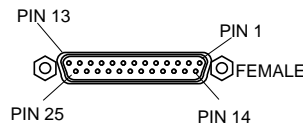

Figure E-1
EIA-232 Interface
Table E-A
EIA-232 Interface

Pin	Name	I/O	Description
1	Shield	I/O	Shield for cable
2	TD	I	Transmitted Data
3	RD	O	Received Data
4	RTS	I	Request to Send
5	CTS	O	Clear To Send
6	DSR	O	Data Set Ready
7	SG	I/O	Signal Ground
8	CD	O	Carrier Detect
9	NC	N/A	No Connection
10	NC	N/A	No Connection
11	NC	N/A	No Connection
12	NC	N/A	No Connection
13	NC	N/A	No Connection
14	NC	N/A	No Connection
15	TC	O	Transmit Clock
16	NC	N/A	No Connection
17	RC	O	Receive Clock
18	NC	N/A	No Connection
19	NC	N/A	No Connection
20	DTR	I	Data Terminal Ready
21	NC	N/A	No Connection
22	Ri	O	Ring Indicator
23	NC	N/A	No Connection
24	ETC	I	External Transmit Clock
25	NC	N/A	No Connection

I = Input..... O = Output.....N/A = Not Applicable

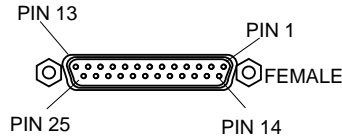

Figure E-2
RS-530 Interface
Table E-B
RS-530 Interface

Pin	Name	I/O	Description
1	Shield	I/O	Shield for cable
2	TD-A	I	Transmitted Data
3	RD-A	O	Received Data
4	RTS-A	I	Request To Send
5	CTS-A	O	Clear To Send
6	DSR-A	O	Data Set Ready
7	SG	I/O	Signal Ground
8	CD-A	O	Carrier Detect
9	RC-B	O	Receive Clock (return)
10	CD-B	O	Carrier Detect (return)
11	ETC-B	I	External Transmit Clock (return)
12	TC-B	O	Transmit Clock (return)
13	CTS-B	O	Clear To Send (return)
14	TD-B	I	Transmit Data (return)
15	TC-A	O	Transmit Clock
16	RD-B	O	Receive Data (return)
17	RC-A	O	Receive Clock
18	NC	N/A	No Connection
19	RTS-B	I	Request To Send (return)
20	DTR-A	I	Data Terminal Ready
21	NC	N/A	No Connection
22	DSR-B	O	Data Set Ready (return)
23	DTR-B	I	Data Terminal Ready (return)
24	ETC-A	I	External Transmit Clock
25	NC	N/A	No Connection

I = Input O = Output N/A = Not Applicable

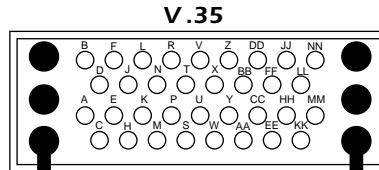

Figure E-3
V.35 Interface

Table E-C
V.35 Interface
 (Provided by RS-530/232-to-V.35 Adapter, part number 1200072L1)

Pin	Name	I/O	Description
A	Shield	I/O	Shield for cable
B	SG	I/O	Signal Ground
C	RTS	I	Request To Send
D	CTS	O	Clear To Send
E	DSR	O	Data Set Ready
F	CD	O	Carrier Detect
H	DTR	I	Data Terminal Ready
J	RI	O	Ring Indicator
P	SD-A	I	Send Data
R	RD-A	O	Receive Data
S	SDB	I	Send Data (return)
T	RD-B	O	Receive Data (return)
U	TCA	I	External Transmit Clock
V	RC-A	O	Receive Clock
W	TCB	I	External Transmit Clock (return)
X	RC-B	O	Receive Clock (return)
Y	ST-A	O	Send Timing
AA	ST-B	O	Send Timing (return)
K,L	NC	N/A	No Connection
M,N	NC	N/A	No Connection
BB	NC	N/A	No Connection
CC	NC	N/A	No Connection
DD	NC	N/A	No Connection
EE	NC	N/A	No Connection
FF	NC	N/A	No Connection
HH	NC	N/A	No Connection
JJ	NC	N/A	No Connection
KK	NC	N/A	No Connection
LL	NC	N/A	No Connection
MM	NC	N/A	No Connection
NN	NC	N/A	No Connection

I = Input..... O = Output..... N/A = Not Applicable

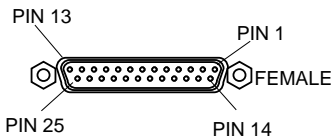

Figure E-4
RS-366 Interface

Table E-D
RS-366 Interface

Pin	Name	I/O	Description
1	Shield	I/O	Shield for cable
2	DPR	I	Digit Present
3	ACR	O	Abandon Call and Retry
4	CRQ	I	Call Request
5	PND	O	Present Next Digit
6	PWI	O	Power Indication
7	SG	I/O	Signal Ground
13	DSC	O	Distant Station Connect
14	NB1	I	Digit LSB
15	NB2	I	Digit bit 2
16	NB4	I	Digit bit 3
17	NB8	I	Digit bit MSB
22	DLO	O	Data Line Occupied
8-12	NC	N/A	No Connection
18-21	NC	N/A	No Connection
23-25	NC	N/A	No Connection

I = Input O = Output..... N/A = Not Applicable

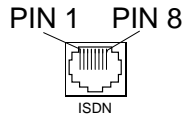

Figure E-5
RJ-45 Dial Line Connector U Interface

Table E-E
RJ-45 Dial Line Connector U Interface

Pin	Description
4	Ring
5	Tip

Table E-F
RJ-45 Dial Line Connector S/T Interface

Pin	Description
3	TxP
4	RxP
5	RxN
6	TxN

Table E-G
Maintenance Connector

Pin	Description
1	CD
2	RD
3	TD
4	DTR
5	SG
6	DSR
7	RTS
8	CTS
9	RING

Appendix E: Connector Pinouts

Appendix F

Ordering ISDN Without IOCs

ISDN is a complex service with multiple options. Obtaining service from your local telephone company and long distance providers can sometimes be complicated. This appendix guides you and your telephone company in specifying and obtaining your ISDN service requirements.

To support most of the features in the ISU 2x64, your telephone service needs to meet certain requirements. A general description of these requirements follows. Depending on your actual data service needs, some features may be deleted. Other features may not be available in your area. Also, features may be deleted for economic reasons, depending on your needs and local tariffs. Talk to your telephone company first, and find out which of the services listed on the following pages are provided.

The following form has been designed to assist you. Complete and FAX this form to your telephone company to request the proper type of ISDN telephone line for use with the ADTRAN ISU 2x64.

ISDN Service Ordering Information for the ADTRAN ISU 2x64

For ADTRAN ISU 2x64 applications, the following guide can be used as an aid in ordering basic ISDN service from your local telephone company.

The ADTRAN ISU 2x64 ISDN Service Unit (part numbers 1200051L1 and 1200051L3) includes NT1 and Terminal Adapter functionality and supports data at rates up to 128 kbps. The ADTRAN ISU 2x64s (part numbers 1200051L2 and 1200051L4) are traditional Terminal Adapters and do not include NT1 functionality. The ADTRAN ISU 2x64 International (part numbers 1200051L5 and 1200051L6) also do not include NT1 functionality.

Name: _____

Address: _____

City: _____ State: _____

Zip Code: _____ Daytime telephone number: _____

Request an ISDN Basic Rate Interface (BRI) line.

- U-interface reference point
- 2B1Q line coding
- 2B+D Service (supports up to 128 kbps)

The ISU 2x64 supports the following switch types and software protocols.

AT&T 5ESS	Custom, 5E6 and later software, National ISDN-1
NTI DMS-100	BCS-32 and later software (PVC1), National ISDN-1 (PVC2)
Siemens EWSD	National ISDN-1
NEC Switch	NTT Protocol
Euro ISDN	ETS300 Protocol

Request that the ISDN line allocate one dynamic terminal endpoint identifier (TEI) per phone number.

For service offered from an AT&T 5ESS, request a multipoint line, with the following features:

Feature	Value
B1 Service	On Demand (DMD)
B2 Service	On Demand (DMD)
Data Line Class	Multipoint
Maximum B Channels	2
Circuit Switched Voice Bearer (CSV) Channels	Any
Number of CSV calls	1 (recommended for testing purposes)
Circuit Switched Data (CSD) Bearer Channels	Any
Number of CSD calls	2
Terminal Type	Type A

Turn the following features off:

- Packet Mode Data
- Multiline Hunt
- Multiple Call Appearances
- Electronic Key Telephone Sets (EKTS)
- Shared Dictionary Numbers
- Accept *Special* Type of Number
- Intercom Groups
- Network Resource Selector (Modem Pools)
- Message Waiting
- Hunting
- InterLATA Competition

Appendix F: Ordering ISDN Without IOCs

For service offered from a Northern Telecom DMS-100, request a multipoint line, with the following features.

Line Type	Basic Rate, Functional
Electronic Key Telephone Sets (EKTS)	No
Call Appearance Handling (CACH)	No
Non-Initializing Terminal	No
Circuit Switched Service	Yes
Packet Switched Service	No
TEI	Dynamic
Bearer Service	Circuit Switched Voice and Data Permitted on any B Channel (Packet mode data not permitted)

Identify your long distance carrier of choice and request circuit-switched 64 kbps Clear Channel access if possible.

Long distance access should be provided through_____.

Ensure that the telephone company provides you with the following information for configuring the ISU 2x64:

- ISDN switch type
- ISDN switch protocol version
- ISDN phone number(s)
- Service profile identification (SPID) number(s) with prefixes and suffixes, if applicable (if ISDN line is multipoint)

LOCAL INTERFACE REQUIREMENTS

Physical Interface

- ISDN Basic Rate Interface (BRI) line
- U-interface reference point
- 2B1Q line coding

ISDN service must be provided from one of the following CO switches and protocols:

Switch	Protocol
AT&T 5ESS	Custom (5E6 or later software) National ISDN-1
Northern Telecom DMS-100	BCS-32 or later software (Pvc1) National ISDN-1 (Pvc2)
Siemens EWSD	National ISDN-1

The interface provides the ability to allocate one dynamic (TEI) per phone number.

Local Service

- Bearer capabilities:
 - Circuit mode voice service for speech and 3.1 kHz audio.
 - Circuit mode data service for 56 kbps and 64 kbps unrestricted data.
- Two simultaneous calls supported on the interface. Any mix of speech and data bearer capabilities is supported for both bearer channels on incoming and outgoing calls.
- Service provided inside the LATA for the bearer capabilities.
- Long distance access for the bearer capabilities to and from the long distance providers of choice.

Long Distance Service

If facilities are available, subscribe to long distance service supporting the bearer capabilities previously listed. Request service supporting circuit-switched 64 kbps or 56 kbps access. It is recommended that the same long distance carrier end-to-end throughout the network to be used.

Deciding What Services to Order

If you are new to ISDN, first obtain the features previously listed. Refer to the section *ISDN Service Ordering Information* in this appendix as a basic guide. It is easier to begin operating on a full featured line because more options are available. Later, features not actually used can be deleted.

If all of the previous features are not available, compare the actual data service requirements with those which are available. A likely problem is the lack of a clear trunk to provide 64 kbps unrestricted data service. A solution is to use to 56 kbps service. Sometimes voice circuits are suitable for data service at a reduced bit rate.

5ESS Custom Line Additional Parameters

The AT&T 5ESS central office telephone switch supports a proprietary ISDN D-channel call control protocol called Custom which is based on CCITT recommendations. The ISU 2x64 configured for switch type AT&T 5ESS will work with lines providing this protocol on 5ESS switches with software version 5E6 or later.

The ISU 2x64 supports the following configurations on 5ESS custom lines:

- Point-to-point with one phone number
- Multipoint with one phone number
- Multipoint with two phone numbers (recommended configuration)

The requirements for the 5ESS point-to-point line are defined in Table F-A.

Table F-A
5ESS Features

B1 service	On-Demand (DMD)
B2 service	On-Demand(DMD)
Data line class	Point-to-point
Maximum B channels	2
Number of circuit switched voice (CSV) calls	2
Circuit switched voice bearer channels	Any
Number of circuit switched data (CSD) calls	2
Circuit switched data bearer channels	Any
Terminal type data bearer channels	Type A

Multipoint lines require the phone company to create a SPID for each phone number on the line. With the exception of the ability to spread two calls across two phone numbers, multipoint lines offer no special features, and may create complications. However, if you use a multipoint line, the parameters are similar to the point-to-point line, except for the SPIDs.

The 5ESS switch can provide a variety of supplementary features which the ISU 2x64 may not support. Enabling these features may have undesirable consequences. Avoid the following features:

- Packet Mode Data
- Multiline hunt groups
- Electronic key telephone set (EKTS)
- Shared directory numbers
- Intercom groups
- Network resource selector (modem pools)
- Message waiting
- Hunting
- InterLATA competition
- Accept special type of number

DMS-100 Protocol Version 1 Line Additional Parameters

The Northern Telecom DMS-100 telephone switch supports a proprietary ISDN D-channel call control protocol called Pvc1 which is based on CCITT recommendations. The ISU 2x64 configured for switch-type DMS-100 is functional on lines providing this protocol on DMS-100 switches with software version BCS-32 or later. The ISU 2x64 supports the following configurations on DMS-100 lines:

- Multipoint with one phone number (1B+D service)
- Multipoint with two phone numbers (for 2B+D service)

The requirements for the DMS-100 multipoint line are defined in the sections *Local Interface*, *Local Service*, and in Table F-B, all in this appendix. The line should have two service profiles with the following parameters to support BONDING.

Table F-B
DMS Features

Line type	Basic Rate, Functional
Electronic key telephone set (EKTS)	No
Call appearance handling (CACH)	No
Initializing terminal	Yes
Bearer service	Circuit Switched Voice and Data permitted. Packet mode data not permitted.
Circuit switched service	Yes
Packet switched service	No
Protocol Version	Functional PVC 1
TEI	Dynamic

After Service Is Installed

When the line is installed, the following information will be provided by the local phone service provider:

- A seven-digit LDN for the line. If the line is multipoint with two phone numbers, two LDNs are provided.
- If the line is multipoint, a SPID is provided for each LDN.
- Dialing information, including the area code, for the line.
- Any special instructions for dialing outside lines, dialing 4-digit local extension numbers, and prefixes for using the desired long distance provider.

SETTING UP THE ISU 2X64 FOR A NEW LINE

1. Disconnect the ISDN line from the ISU 2x64.
2. Turn on the ISU 2x64, verify that it passes self test.
3. Turn off the ISU 2x64; while holding down 0, turn on the ISU 2x64. Continue to press down 0 for 15 seconds. This will re-set all the internal settings to factory defaults.
4. The ISU 2x64 is now set up for 5ESS Custom. If this is not the correct line-type, select **CONFIG, Netw. Options, Dial Line, Switch Type**, and the desired switch type.
5. Enter the SPIDs and LDNs for the ISDN multipoint line. Select **CONFIG, Netw. Options, Dial Line, Terminal ID, Set SPID/Set LDN** and enter the SPIDs and LDNs. Make sure that SPID1 corresponds to LDN1 and SPID2 corresponds to LDN2.
6. Turn the ISU 2x64 off for 2 seconds, then on. This is required after changing any of the previous settings. The ISU 2x64 should now be set up for your ISDN line. You may wish to verify the settings.
7. Connect the ISDN line to the **ISDN IFC** connector on the ISU 2x64. The front panel should read **Link Down** and progress to **Ready** as the line is activated. This process may take a minute.

At this point, if the ISU 2x64 does not read **Ready**, see the section *If the ISU 2x64 Does Not Read Ready* in the chapter *Troubleshooting*.

Acronyms

2B1Q	2 Binary, 1 Quarternary
AMI	Alternate Mark Inversion
B (Channel)	A 64 kbps digital information channel
BONDING	Bandwidth On Demand Interoperability Group
bps	Bits per second
BRI	Basic Rate Interface
CCITT	Consultative Committee for International Telegraphy and Telephony
CD	Carrier Detect
CIC	Connect Incoming Call
CTS	Clear to Send
DCE	Data Communications Equipment
DMS	Digital Multiplex Switching
DSR	Data Set Ready
DTE	Data Terminal Equipment
EKTS	Electronic Key Telephone Service
FAX	Facsimile
HLC	High Layer Compatibility
ID	Identification
IFCE	Interface
I/O	Input/Output
ISDN	Integrated Services Digital Network
ISO	International Standardization Organization
kbps	Kilobits per second
kHz	Kilohertz
LAN	Local Area Network
LDN	Local Directory Number
Mbps	Megabits per second
NT1	Network Termination 1
PBX	Private Branch Exchange
PC	Personal Computer

Acronyms

PRI	Primary Rate Interface
SPCS	Stored Program Controlled Switching System
SPID	Service Profile Identifier
TA	Terminal Adapter
TE	Terminal Equipment
TEI	Terminal Endpoint Identifier
WAN	Wide Area Network

Glossary

asynchronous transmission

Not Synchronous. A method of data transmission which allows characters to be sent at irregular intervals by preceding each character with a *start* bit and following it with a *stop* bit. The timing of the transmission is not determined by the timing of a previous character. Applications include communication between most small computers (especially PCs) and mainframes, lower speed transmission, and less expensive computer transmission systems. See **Synchronous**.

B-channel

64 kbps *bearer* channel used for voice, circuit, or packet switched data.

bandwidth

The range of electrical frequencies a device is capable of handling. The amount of bandwidth a channel is capable of carrying tells you what kinds of communications can be carried on it. For example, a wide band circuit can carry a TV channel. A wide band circuit that is capable of providing one video channel can also provide 1,200 voice telephone channels.

bearer service

As defined by CCITT standards, a type of telecommunication service that provides the capability for the transmission of information between user-to-network interfaces. Bearer services defined for ISDN are circuit mode and packet mode.

BONDING mode 1 protocol

Industry standard B-channel aggregation protocol. Developed by the Bandwidth on Demand Interoperability Group.

BRA

basic rate access. The BRA includes two 64 kbps B-channels and one 16 kbps D-channel. Also known as Basic Rate Interface (BRI).

bridging

The technique whereby additional stations may be served from a two-point facility by extending the facility from a *bridge* at one of the facility's terminating points.

CCITT

Consultative Committee on International Telephony and Telegraphy. A body of the International Telegraph Union (ITU) which prepares recommendations, commonly referred to as international standards, to resolve technical telegraph and telephone problems.

central office (CO)

In telephony, the facility housing the switching system and related equipment that provides telephone service for customers in the immediate geographical area.

circuit mode

Type of switching that assigns a call to a specific circuit path. The circuit is not shared with other calls.

clear channel

A channel in which all the 64 kbps are used for transmission. To achieve this, bit robbing signalling must be eliminated. (NOTE: Not to be confused with clear channel protocol.)

common channel interoffice signalling (CCIS)

A signalling system developed for use between stored program switching systems. All of the signalling information for a group of trunks is transmitted over a dedicated high-speed data link rather than on a trunk. CCIS reduces call setup time compared to individual trunk signalling.

CPE

Customer premises equipment. A generic term for communications terminal gear owned by the customer, residing on customer premises.

CSU

Channel service unit. A component of CPE used to terminate a digital circuit, such as DDS or T1 at the customer site. Performs certain line-conditioning functions, ensures network compliance per FCC rules, and responds to loopback commands from the central office. Also ensures proper 1s density in transmitted bit stream and performs bipolar violation correction. See **DSU**.

D-channel

The ISDN channel that carries signalling information to control the call setup, tear-down, or invocation of supplementary services. The D-channel may also be used to provide packet mode data service.

DCE

data communications equipment. The portion of a data terminal that provides the interface to the network.

DDS

dataphone digital service. AT&T private line service for transmitting data over a digital system. The digital transmission system transmits electrical signals directly, instead of translating the signals into tone of varied frequencies as with traditional analog transmission systems. Digital techniques provide more efficient use of transmission facilities, resulting in lower error rates and costs than analog systems.

digital

Referring to communications procedures, techniques, and equipment where information is encoded as either a binary 1 or 0, the representation of information in discrete binary form, discontinuous in time, as opposed to the analog representation of information in variable but continuous waveforms.

DSU

data service unit. A device providing interface between a data terminal or other data communications device and a digital access line.

DTE

data terminal equipment. The portion of a data terminal that interfaces to the end-user's equipment. The main difference between DCE and DTE is that pins 2 and 3 are reversed on the EIA-232.

Frame

A group of bits sent serially over a communications channel. Generally a local transmission unit sent between data-link-layer entities that contains its own control information for addressing and error checking. The basic data transmission unit is employed with bit-oriented protocols, similar to blocks. In video transmission, a set of electron scan lines that comprise a television picture (usually 525 in the U.S.).

in-band signalling

Signalling made up of tones which pass within the voice frequency band and are carried along the same circuit as the talk path being established by the signals. Virtually all signalling (request for service, dialing, disconnect, etc.) in the U.S. is in-band signalling. Most of that signalling is MF (multi-frequency) dialing. The more modern form of signalling is out-of-band.

information element

The name for the data fields within an ISDN Layer 3 message.

interface

A common boundary between two systems over which the inter-system communication occurs.

interworking

Communication between two types of networks or end equipment. This may or may not involve a difference in signalling or protocol elements supported.

ISDN

Integrated service digital network. A network architecture that enables end-to-end digital connections. The network supports diverse services through integrated access arrangements and defines a limited set of standard, multipurpose interfaces for equipment vendors, network providers, and customers. Interworking with a public switched telephone network is retained.

LATA

Local Access and Transport Area. One of 161 local telephone serving areas in the United States, generally encompassing the largest standard statistical metropolitan areas. Subdivisions established as a result of the AT&T divestiture that now distinguish local from long distance service. Circuits with both end-points within the LATA (intraLATA) are generally the sole responsibility of the local telephone company, while circuits that cross outside the LATA (interLATA) are passed on to an interexchange carrier.

Loopback

A diagnostic procedure where data is sent to the device being tested, and the output of the device is fed directly back to its input, looped around, and the returning data is checked against that which was sent.

loopback test

A test typically run on a 4-wire circuit. Two transmit leads are joined to the two receive leads. A signal is then sent around the loop. Measuring differences between the sent and received signal is the essence of a loopback test.

master clock

The source of timing signals, or the signals themselves, which all network stations use for synchronization.

message

The Layer 3 information that is passed between the CPE and SPCS for signalling.

multiplexing

The combining of multiple data channels onto a single transmission medium. Any process through which a circuit normally dedicated to a single user can be shared by multiple users. Typically, user data streams are interleaved on a bit or byte basis (time division) or separated by different carrier frequencies (frequency division).

multipoint circuit

A circuit consisting of three or more stations connected directly electrically.

NEXT (near-end crosstalk)

Unwanted energy transferred from one circuit to an adjoining circuit. Occurs at the end of the transmission link where the signal source is located. The absorbed energy is usually propagated in the direction opposite to the absorbing channel's normal current flow. Caused by high-frequency or unbalanced signals and insufficient shielding.

non-ISDN line

Any connection from a CPE to a SPCS that is not served by D-channel signalling.

non-ISDN trunk

Any trunk not served by either SS7 or D-channel signalling.

NT1

Network Termination 1. A unit that provides physical and electromagnetic termination of the U-interface 2-wire transmission line, converts between Layer 1 formats used at the U- and T- reference points, and performs some maintenance functions.

packet mode

Refers to switching of packets of information for different users by statistically multiplexing them over the same transmission facilities. ISDN packet mode capabilities are based on CCITT Recommendation X.25 procedures.

point-to-point

Describing a circuit connecting two points directly with no intermediate processing nodes or computers (although switching facilities could exist). A type of connection that links two logical entities (i.e., phone-line circuit).

S-interface

S-reference point. The interface that connects an ISDN terminal (TE1) or Terminal Adapter (TA) to the NT2 reference point as defined in the I.411 Recommendation.

SPCS

stored program controlled switch. A digital switch that supports call control, routing, and supplementary services provision under software control. All ISDN switches are SPCSs

SDLC

synchronous data link control. A data communications line protocol associated with the IBM System Network Architecture. SDLC is a bit-oriented protocol (not a character-oriented protocol) that includes multiple block error checking and full duplex line operation.

sync bits

Framing or synchronizing bits in synchronous transmission.

synchronous

1. The condition occurring when two events happen in a specific time relationship with each other, both under control of a master clock. 2. A method of data transmission requiring the transmission of timing pulses to keep the sender and receiver synchronized in their communication used to send blocks of information. Synchronous data transmission is used in high-speed data circuits because there is less overhead than asynchronous transmission of characters which contain two extra bits per character to affect timing.

T1

Also T-1. A digital transmission link with a capacity of 1.544 Mbps. T1 uses two pairs of normal twisted wires. T1 normally can handle 24 voice conversations with each conversation being digitized at 64 kbps. With more advanced digital voice encoding techniques, it can handle more voice channels. T1 is a standard for digital transmission in North America.

TA

Terminal Adapter. A DCE that connects to the ISDN S-Interface and enables non-ISDN terminal equipment to communicate over ISDN.

TE1

terminal equipment type 1. ISDN-compatible terminals.

TE2

terminal equipment type 2. Non-ISDN terminal equipment linked at the EIA-232, RS-449, or V.35 interface.

transmission

The dispatching of a signal, message, or other form of intelligence by wire, radio, telegraphy, telephony, facsimile, or other means. A series of characters, messages or blocks including control information and user data. The signalling of data over communications channels.

transmission level

The power of a transmission signal at a point of a transmission facility. It may be measure in absolute terms (dBm) or in a ratio to its level at some reference point (dB).

twisted pair

Two wires twisted around each other to reduce induction (interference) from one wire to the other. Several sets of twisted pair wires may be enclosed in a single cable. Twisted pair is the normal cabling from a Central Office to your home or office, or from your PBX to your office phone. Twisted pair wiring comes in various thicknesses. As a general rule, the thicker the cable is, the better the quality of the conversation and the longer cable can be and still get acceptable conversation quality. However, the thicker it is, the more it costs.

2B+D

The basic rate interface (BRI) in ISDN. A single ISDN circuit divided into two 64 kbps digital channels for voice or data and one 16 kbps channel for low speed data (up to 9,600 baud) and signalling. 2B+D is carried on one or two pairs of wires depending on the interface, the same wire pairs that today bring a single voice circuit into your home or office. See **ISDN**.

U-interface

A twisted pair subscriber loop that connects the NT1 reference point to the ISDN network, as defined in the I.411 Recommendation. This interface provides basic rate access with an operating frequency of 160 kbps and an information rate of 144 kbps. Under U.S. regulations, this also marks the line of demarcation between customer-owned equipment and the public network.

V.32

9.6 kbps, 2-wire duplex modem standard.

videoconferencing

The real-time, usually two-way, transmission of digitized video images between two or more locations. Videoconferencing requires a wideband transmission facility. Transmitted images may be freeze-frame (where television screen is repainted every few seconds to every 20 seconds) or full motion. Bandwidth requirements for two-way video conferencing range from six MHz for analog, full-motion, full-color, commercial grade TV to 56 kbps for digitally-encoded freeze-frame to 1.544 kbps for high-quality, full-color, full-motion TV.

X.25

A packet data transfer protocol for the B and D-channels. Defines the interface between data terminal equipment (DTE) and data circuit terminating equipment (DCE) for terminals operating in the packet mode and connected to public data networks by dedicated circuits.

Glossary

Index

Numerics

- 2B1Q leased digital service 47
- 5ESS custom line additional parameters 130
- 5ESS features 131

A

- adapters
 - RS-530-to-V.35 14
- always tone 44
- answer call 64
- answer tone
 - setting 43
- async. rev. 58
- AT command processor 38
- AT commands 36, 37, 89
- AT commands, 85, 89
- AT&T 5ESS, 28
- audio 31
- auto answer 40
 - setting 42
- autobaud 54

B

- B channel aggregation 86
- bit rate 51
- BONDING mode 1 56

- busy out port
 - disabled 34
 - enabled 34
 - setting 33

C

- call screening
 - setting 45
- call type
 - setting 31
- CD options 51
- cfg. rmt. unit 75
- channel rate 48
- clear channel 56
- clock mode
 - slave/master 47
- configuration 27
 - quick setup 65
- configuration screen 22
- configuration, 27
- connect timeout
 - setting 45
- connection
 - dial interface 16
 - DTE data 14
 - network 13
- connector pinouts 119
- connector type 51
- CTS options 51

current status menu 18
current status messages 95

D

data 56kbps 31
data 64kbps 31
data format (async) 53
data rates
 (DTE) 86
 (network) 85
dial 112K sync 67
dial 115.2 asyn 69
dial 128K sync 68
dial 56K sync 66
dial 57.6 asyn 68
dial 64K sync 67
dial interface connection 16
dial line menu tree 27
dial line operation 27
dial line, 27
dial menu tree 63
dial number 64
dial options 63
 AT commands 36
 front panel 34
 RS 366 34
 setting 34
dial options, 73
dial stored # 64
dial stored #, 75
dialing 2
dialing options
 answer call, 75
 dial number, 75
 V.25 bis 39
dialing options screen 63
dialing selections 85
disabled 34
display 87
DSR options 52

DSU 57.6 async 59
DTE data connection 14
DTE indicators 3, 18
DTE interface 85
DTE options for async and sync operation 50
DTR options 52

E

EIA-232 interface 119
environmental specifications 87

F

factory setup 71
fallback 60
fallback 57.6k 69
FEBE 26
flow control 52
front panel 3, 4
 dialing options 63

G

getting started 19
getting TEI #2, 81

H

hang up line 64

I

if self test fails 77
if the ISU 2x64 does not read ready 77
if the wrong DTE port answers a call 83
if you cannot connect calls 84
in-band dialing
 disabled 42
incoming tone 44
indicators 3

installation
 ISU 2x64
 installation 13
interface
 maintenance 15
interfaces 2
interoperability 4, 86
ISDN
 ordering codes 9
 overview 1
 service 9
ISU 2x64
 dialing from 2
 front panel 3, 4
 interfaces 2
 interoperability 4
 operation 17
 overview 1
 rear panel 2
 single port operation 4

L

LCD configuration menu tree 29
ldm 64K master 70
LDNs
 setting 33
leased 64K 70
leased application with channel banks
 48
leased line service 47
LED indicators
 carrier detect, 87
 clear to send, 87
 data set ready, 87
 data terminal ready from DTE, 87
 receive data, 87
 request to send, 87
 transmit data, 87
LED indicators, 87
limited distance modem application 48

lock keypad 74
loopback both DTEs 26
loopback disable 25
loopback DTE 24
loopback network 24
loopback points 24
loopback protocol 24
loopback remote 25
Lpbk remote 1B 75
Lpbk remote 2B 75

M

maintenance connector 123
maintenance help screen 15
maintenance interface 15
menu navigation 17
multilink PPP 62

N

NEBE 26
negotiation fail, 105
network connection 13
network interface 85
no answer tone 44
Northern Telecom DMS-100, 28

O

operating protocols 6
operation 17
 dial line 27
ordering ISDN without IOCs 125
outgoing tone 44
out-of-band RS 366 dialing 16

P

physical specifications 87
pinouts

- maintenance connector, 123
 - RJ-45 dial line connector S/T interface, 123
 - RJ-45 dial line connector U interface, 122
 - RS-366, 122
 - RS-530, 120
 - V.35, 121
 - point-to-point async-to-sync 61
 - point-to-point protocol 62
 - power 87
 - PPP async-to-sync 61
 - PPP protocol 62
 - PPP with compression 62
 - protocol options
 - setting 55
- Q**
- quick setup configuration 65
 - quick setup menu tree 65
 - quick setup, 65, 66
- R**
- rate adaptation protocols 60
 - rate adaption 86
 - rear panel 2
 - recommended operating protocols 6
 - redial last # 64
 - register SPID #2, 82
 - remote config 74
 - remote config menu tree 74
 - RJ-45 dial line connector S/T interface 123
 - RJ-45 dial line connector U interface 122
 - RS 366 dialing
 - out-of-band 16
 - RS-366 interface 121, 122
 - RS-366 interface, 85
 - RS-530 interface 120
 - RS-530-to-V.35 adapters 14
 - RTS options 51
- S**
- SAP 59
 - Sbus termination 46, 49
 - security 73
 - security menu tree 73
 - self test fails 77
 - set password 74, 75
 - setting answer tone 43
 - setting auto answer 42
 - setting call screening 45
 - setting connect timeout 45
 - setting protocol options 55
 - setting the busy out port 33
 - setting the call type 31
 - setting the dial options 34
 - setting the LDN 33
 - setting the SPID 32
 - setting the switch protocol 28
 - setting the terminal ID 32
 - single port operation 4
 - smart dial strings 32
 - software version 26
 - specifications 85
 - speech 31
 - SPIDs 4, 6
 - setting 32
 - S-registers 37, 38
 - list 109
 - status buffer 20
 - status buffer messages 99
 - status screen 21
 - store/review # 64
 - switch compatibility 86
 - switch protocol
 - setting 28

T

TANULL 58
TCID 58
terminal ID
 setting 32
test 2047 both 26
test menu screen 23
test menu tree 24
test options 23
test remote 25
testing 23
T-link 59
transmit clock (async) 53
troubleshooting 77
troubleshooting calls 84
TXADD01 57
TXDEQ 58
TXFA 57
TXINIT 57

V

V.110 59
V.120 58
V.25 39
V.25 async dialing 40
V.25 bis, 85
V.25 HDLC flag 42
V.25 sync bisync dialing 42
V.25 sync HDLC Dialing 41
V.35 interface 120, 121
VT 100 configuration menu tree 28
VT 100 configuration screen 22
VT 100 dialing options screen 63
VT 100 maintenance help screen 15
VT 100 menu support 19
VT 100 status screen 21
VT 100 test menu screen 23

Index

Product Support Information

Presales Inquiries and Applications Support

Please contact your local distributor, ADTRAN Applications Engineering, or ADTRAN Sales:

Applications Engineering (800) 615-1176
Sales (800) 827-0807

Post-Sale Support

Please contact your local distributor first. If your local distributor cannot help, please contact ADTRAN Technical Support and have the unit serial number available.

Technical Support (888)4ADTRAN

Repair and Return

If ADTRAN Technical Support determines that a repair is needed, Technical Support will coordinate with the Customer and Product Service (CAPS) department to issue an RMA number. For information regarding equipment currently in house or possible fees associated with repair, contact CAPS directly at the following number:

CAPS Department (256) 963-8722

Identify the RMA number clearly on the package (below address), and return to the following address:

ADTRAN, Inc.
CAPS Department
901 Explorer Boulevard
Huntsville, Alabama 35806-2807

RMA # _____

Free Manuals Download Website

<http://myh66.com>

<http://usermanuals.us>

<http://www.somanuals.com>

<http://www.4manuals.cc>

<http://www.manual-lib.com>

<http://www.404manual.com>

<http://www.luxmanual.com>

<http://aubethermostatmanual.com>

Golf course search by state

<http://golfingnear.com>

Email search by domain

<http://emailbydomain.com>

Auto manuals search

<http://auto.somanuals.com>

TV manuals search

<http://tv.somanuals.com>