

INSTRUCTION BOOK

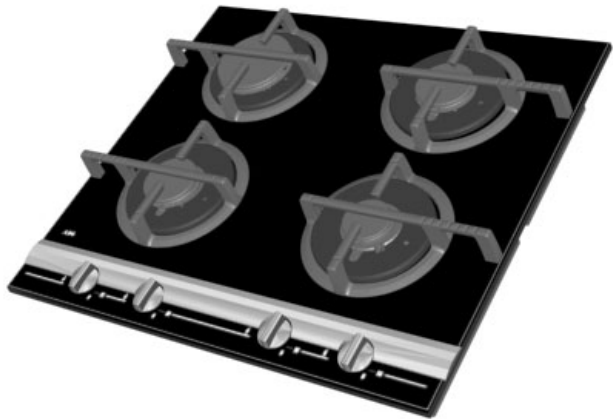

FM 6300G-an

GB

325 88-8281 rev. 1-335

949 601 853

Your New Appliance

Thank you for purchasing an AEG appliance.

To enable you to use your new appliance efficiently and safely, please read this instruction book carefully before installing or using the appliance, and retain for future reference. Should the appliance be transferred to a new owner please ensure this instruction book is left with the appliance in order that the new owner can get to know the functions of the appliance and the relevant warnings.

If you require further assistance or advice, please contact our Customer Care Department either by letter or telephone:

Customer Care Department
AEG Domestic Appliances
55-77 High Street
Slough
SL1 1DZ

Tel: 08705 350350*

* calls to this number may be recorded for training purposes

For the User

Your new appliance	2
Safety Information	5
Product Description	7
Ceramic Hob	8
Burners	8
Before use	9
Protect the Ceramic Hob	9
Clean the burners	9
How to Use the Hob	10
Ceramic Hob	10
Burners	11
Choice of Pans	12
Advice and tips on use of burners	13
Cleaning and Maintenance	14
Aluminium	14
Ceramic Hob	14
Burners	15
What to do if	27
Service and Spare Parts	28
Guarantee conditions	29

For the Installer

Unpacking 16
Technical Data..... 17
Important safety requirements 18
Installation..... 19
Mounting 21

How to read the operating instructions

1... 2...Step by step



Hints and tips



Safety information



Environmental information

The products are continuously being developed and it may occur that some product specifications are changed after this instruction book was printed. We therefore have to make reservation for any changes or printing errors.



Safety Information

The hob is intended for domestic use only. If it is used in any other way there is a risk of accidents.

Children

Keep an eye on children when the hob is in use. Pans get very hot when used and remain warm for some time after the hob has been turned off. Never let children touch or play with the controls.

Use

Take care to ensure that the burner rings and covers are positioned correctly over the burner tops. Never leave the hob unattended when deep frying or melting fat, paraffin wax or other easily ignited substances. Never leave paper, dish cloths, aluminium foil or any other easily ignited materials close to the hob. A hot hob can cause foil, plastic or paper to melt or burn.

Put out flames with a lid, and never use water.

Check that the hob is turned off when not in use.

Cleaning and Maintenance

Remember that the hotplate, the pan supports and the burners will stay hot for a long time after you have turned off the heat.

For hygienic and safety reasons the gas burners must be kept clean. Grease splashes and spilt food will give off fumes if heated up and in the worst cases could cause a fire.

Service

Service and repair must be performed by our service organisation or an organisation approved by us. Only spare parts supplied by our service organisation may be used.

Unpacking

Make sure the packaging is disposed of in such a manner that children cannot access the used packaging.

Installation

Installation of the cooker hob may only be carried out by a Corgi registered installer. Work carried out by unqualified persons could lead to personal injury or damage to property, and spoil the hob itself. During installation make sure the electricity cable is not pinched.

Disposal

Help prevent accidents when disposing of the product. Remove the cable from the wall plug and cut off the cable close to the product.

Product Description

1. Large burner
2. Medium burner
3. Medium burner
4. Small burner
5. Control panel

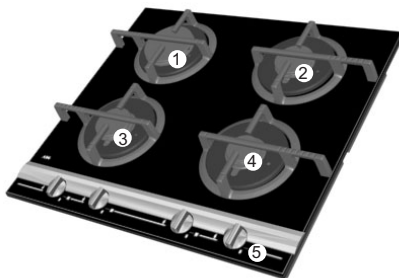

Control Panel



1. Control knob for rear left-hand burner
2. Control knob for rear right-hand burner
3. Control knob for front left-hand burner
4. Control knob for front right-hand burner

Ceramic hob

Ceramic glass is insensitive to temperature shock and very robust: however it is not unbreakable. Especially sharp and hard objects that fall on the cooking surface can damage it.

Burners

The burners are made up of a burner body, a burner ring and a burner cap. Each burner has electrical ignition which means you do not need matches to light it. Each burner has a safety device. If the flame goes out, the safety device will automatically shut off the gas supply.

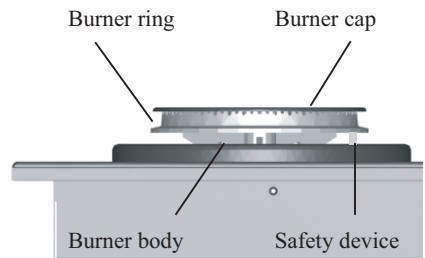

Before Use

Protect the ceramic hob

Before using the product for the first time, clean off any factory residues such as dust or dirt. Give the ceramic hob a protective coating before using it. This will make it easier to clean the hob and will prevent spills etc. burning on too hard. This is what you do:

1. Remove the pan support(s), burner ring and burner cover.
2. Sprinkle a few drops of a ceramic cleaning agent onto a piece of kitchen paper and rub into the whole surface.
3. Polish the hob with a clean cloth until dry.

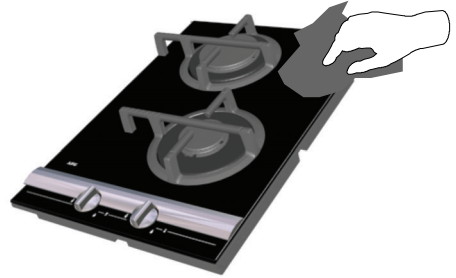

Clean the burners

Wash the pan stands, burner covers and burner rings in hot water and washing-up liquid.

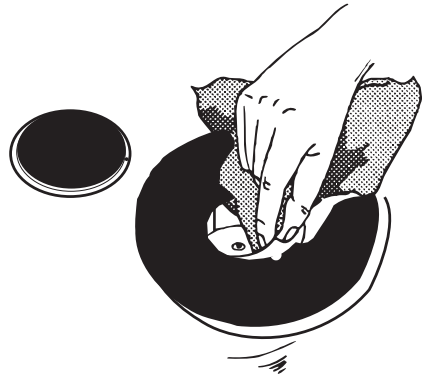

How to use

Ceramic hob



Never use a cracked ceramic hob. Water could boil over and/or cleaning agents penetrate into the live electrical parts. Switch off the power to the appliance and contact Service.

Never leave the hob unattended when deep frying or melting fat, paraffin wax or other easily ignited substances.

Never leave paper, dish cloths, aluminium foil or any other easily ignited materials in the immediate vicinity of the hob. A hot hob can cause foil, plastic or paper to melt or burn.

In case of fire, turn off all knobs and switch off any cooker hood. Extinguish the fire with a fire blanket or dampened cloth. Never use water.

Scrape any spillages from the hob immediately, using a hob scraper if necessary.

Spillages of sugar and sugar-rich foods (jam, fruit syrup etc.), melted plastic and aluminium foil can damage the hob.

Burners



Make quite sure the burner ring and burner cap are positioned correctly over the burner top.

For correct combustion the burner rings and burner cap must be positioned correctly over the burner body. If the burner rings and caps are off-centre, the gas flame will burn incorrectly and the burner cap may be ruined in a short space of time.

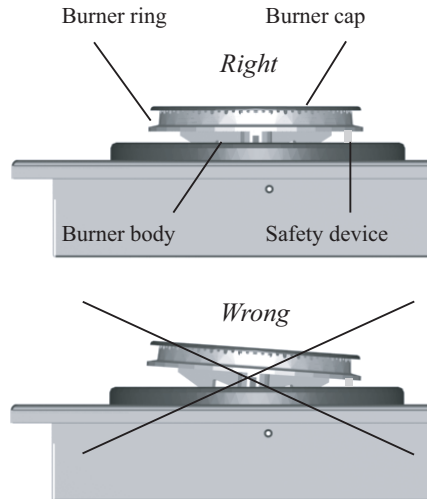

Control knobs

The control knobs have the following settings:

Off:

Minimum:

Maximum:

1. Press down the control knob for the desired burner
2. Hold the knob down while turning it to the left to
3. Keep the knob pressed down for 4-5 seconds. Then release it and turn the knob to the required setting.

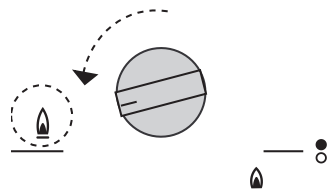
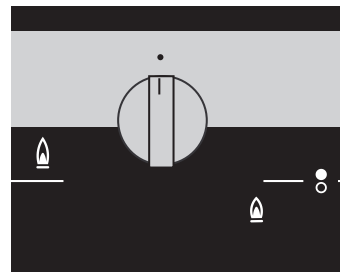

While the control knob is held down, sparks will be formed. This is done by the electrical ignition which lights the gas without your having to use matches. If no electrical connection is possible, you can light the gas with matches.

Choice of Pans

Make full use of energy by using good quality cooking pans. All pans designed for gas and electric stoves can be used.

Size of pans

The burner you use to cook with will depend on the base diameter of the cooking pan.

Small burner, recommended pan size: 90-130 mm

Medium burner, recommended pan size: 130-210 mm

Large burner, recommended pan size: 180-280 mm

You can check that you are using the right burner by looking at the flame.

At setting  the flame should remain approx. 1 cm inside the edge of the pan.

The flame should not “lick” up the side of the pan.

Advice and tips on use of burners



Follow the advice below to save energy and make cleaning easier.

- ▲ **The pans must match the burners.** At setting  the flame must remain approx. 1 cm inside the edge of the pan.
- ▲ **Use close-fitting lids on the pans.** Not using a lid on the pan uses three times as much gas. Place the pans on the cooking zone before you light the gas.
- ▲ **Save water: use as little water as possible.** Use just enough water to cover the item being cooked wherever possible.
- ▲ **Cover the pan with a close-fitting lid.** Bring to the boil at the maximum setting and turn down to the lowest possible level when steam starts emerging steadily from the lid. Estimate cooking time from when you turn down the heat. Avoid looking at the potatoes/vegetables until the cooking time is up.
- ▲ **Turn down the heat immediately the water boils.** Select the correct setting. Start at the maximum setting and turn down as far as possible, without letting the pan go off the boil.
- ▲ Defrost food in the refrigerator.
- ▲ You will save energy by cooking on the hob rather than in the oven.

Cleaning and Maintenance



For hygienic and safety reasons, keep the burners clean. Grease splashes and spilt food will give off fumes when heated and in the worst case can lead to a fire.

Aluminium

Carry out daily cleaning with a well wrung-out cloth. For more stubborn soiling, use a cloth or a soft plastic sponge together with washing-up liquid or all-purpose cleaner.

Never use metal cleaning pads, metal wool, hard plastic sponges, scouring powder, soft soap or other abrasive or caustic cleaning agents.

Ceramic hob

Immediately scrape off spillages and traces of sugar, sugar-rich food (jam, fruit juice etc.), melted plastic and aluminium foil from the hot surface. If the hob is allowed to cool down, damage may result.

1. Remove splashes etc. with a ceramichob scraper.
2. Make sure the hob has cooled down.
Use a cleaning agent designed for vitroceramic hobs.
Follow the instructions on the container.

3. Wipe the hob clean with a damp cloth or kitchen paper. Stubborn stains can be removed by rubbing hard with the cleaning agent sprinkled on a piece of kitchen paper.
4. Wipe off excess cleaning agent with a damp cloth.
5. If necessary, finish off with a dry cloth.

Make sure the hob is dry before heating up again. A damp hob may display rainbow-like stripes when heated up.

Burners

Clean the burner covers and rings in hot water and washing-up liquid.

Never use metal cleaning pads, metal wool or other abrasive cleaners.

Pan supports

Clean pan supports in hot water and washing-up liquid.

Never use metal cleaning pads, metal wool or other abrasive cleaners.

Burner tops

If hot food spills into the burner top, this must be removed before lighting again. Remove spillages in the burner top with a lint-free cloth.

Never use metal cleaning pads, metal wool or other abrasive cleaners.

Unpacking

Check that the appliance has no faults and is undamaged on delivery.

Transport Damages

Any damages resulting from a transport which you have not performed yourself must be communicated to the dealer within one week of receipt of the product.

On the rating plate which is placed on the back of the product you will find the CE marking and the product's serial number. Write the serial number on the front of this instruction book so it is easily accessible in the event of service.

Removal of Packaging

All packaging can be recycled. Contact your local authority if you do not know where to dispose of the packaging.

Technical Data

This gas appliance is CE-approved and CE-marked in accordance with the Gas Appliance Directive (90/396/EEC, Low Voltage Directive (73/23/EEC) and the EMC Directive (89/336/EEC as amended).

Approval authority:  0048 (Danmarks Gasmateriel Prøvning).

Model FM 6300G-an

Product dimensions:

Width: 580 mm
Depth: 520 mm
Height: 66 mm

Installation dimensions:

Width: 560 mm
Depth: 490 mm
Height: 55 mm

Output (natural gas)

Rear left 3 kW
Front left 1.9 kW
Rear right 1.9 kW
Front right 1 kW

Total output 7.8 kW

Gas consumption

Natural gas 0.74 m³/h
LPG 598 g/h
Consumption given as the max.
nominal gas consumption

Category and pressure:

GB: II2H3+ -20 - 28/37 mbar

Nozzle/connection pressure

Natural gas 20 mbar
LPG 30 mbar

FM 6300G-an is adjusted for natural gas G20-20 mbar.
An LPG conversion kit is included.

Voltage 230 V

Ignition transformer 50 Hz, 0.6 VA

CE identification no.: 048BN-0042

Important safety requirements

This hob must be installed in accordance with the Gas Safety (Installation and Use) Regulations (Current Edition) and the IEE Wiring Regulations (Current Edition).

Detailed recommendations are contained in the following British Standards Codes Of Practice: B.S. 6172/ B.S. 5440, Par. 2 and B.S. 6891 Current Editions.

The hob should not be installed in a bed sitting room with a volume of less than 20 m³. If it is installed in a room of volume less than 5 m³ an air vent of effective area of 110 cm² is required. If it is installed in a room of volume between 5 m³ and 10 m³ an air vent of effective area of 50 cm² is required, while if the volume exceeds 11 m³ no air vent is required.

However, if the room has a door which opens directly to the outside no air vent is required even if the volume is between 5 m³ and 11 m³.

If there are other fuel burning appliances in the same room, B.S. 5440 Part 2 Current Edition, should be consulted to determine the requisite air vent requirements.



This hob must be installed by qualified personnel to the relevant British Standards.

Any gas installation must be carried out by a CORGI registered installer.

The manufacturer will not accept liability, should the above instructions or any of the other safety instructions incorporated in this book be ignored

Installation

Gas installation



Installation may only be carried out by a Corgi registered installer. Work carried out by unqualified persons may lead to personal injury and/or damage to property, and may damage the product.

This gas appliance is CE-approved and CE-marked in accordance with the Gas Appliance Directive (90/396/EEC, Low Voltage Directive (73/23/EEC) and the EMC Directive (89/336/EEC as amended).

Gas installation must be carried out in accordance with the Gas Regulations (GR).

No alterations must be made to the technical design of this appliance.

Leak test

When leak testing, the appliance may be tested to a maximum of 150 mbar.

Electronic Control

Cable type 0.75 mm² HO5 VV-F

Installation must comply with any special requirements laid down by the local energy provider. The product must be connected via an external switch with a contact gap of at least 3 mm. (May be the main switch).

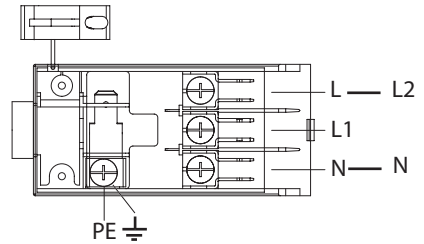

Mounting

The hob can be installed in any type of kitchen worktop with a thickness of 28-40 mm. However, if an oven is to be installed beneath it, the worktop must be at least 40 mm thick.

Cutting Out

When mounting this hob: Read the instructions on this and the following page.

When mounting this hob in conjunction with other units in this range: Read the instructions in the section “Mounting more than one hob”.

For mounting this hob you will need a Phillips screw driver and the four fixings supplied (See fig.).

Distance to wall:

Min. 150 mm from flammable material.

Min. 50 mm from non-flammable material.

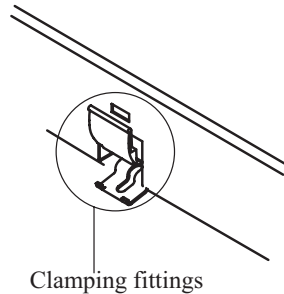



However, to ensure accessibility to the gas connection there should generally be at least 50 mm between the rear of the hole for the gas hob and the wall behind it.

1. Cut a hole in the worktop of the given dimensions, see “Technical data”, “installation dimensions”.
2. Place the hob upside down on a soft underlay. Make sure not to scratch the top surface.
3. Mount the fixings in the holes in the sides of the base box. (See fig.).
4. Insert the hob in the hole and tighten the fixings to the worktop with a screwdriver.

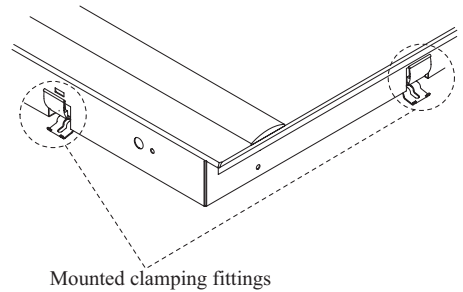

Mounting more than one hob

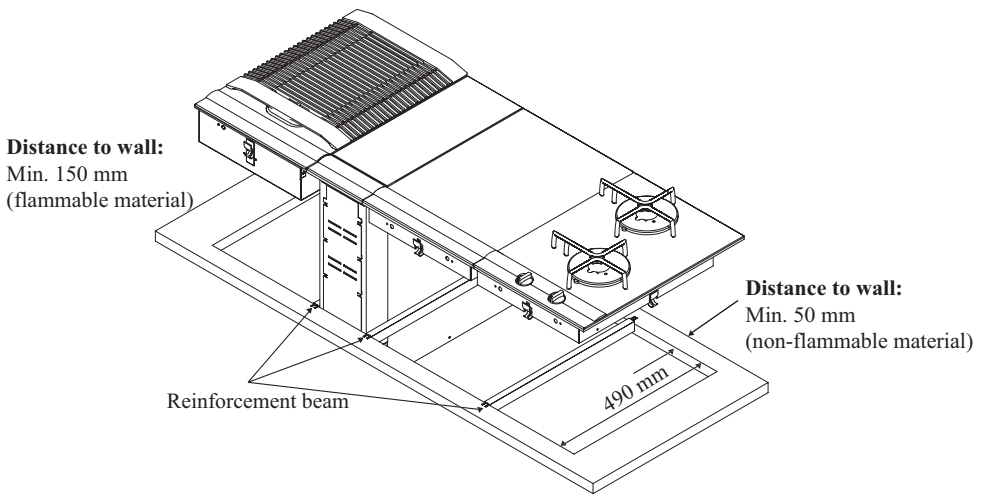

Cutting out

The measurement of the selected combination is calculated in the following way:

Depth: 490 mm

Width:

1. Calculate the sum of all units' width.
2. Subtract 20 mm from the total width.

Example:

A hob of 720 mm + a downdraft of 180 mm + a gas hob of 360 mm.

1. $720+180+360= 1260$ mm
2. Width of the hole: $1260-20=1240$ mm

Distance to Wall:

Min. 150 mm to flammable material.

Min. 50 mm to non-flammable material

Mounting:

When mounting several hobs together you must use a reinforcement beam between each hob as well as the silicone supplied with the hobs (see fig.)

1. Cut a hole of the calculated size in the table top
2. Place the individual hobs upside down on a mat. Take care that the top side is not scratched.
3. Mount the clamping fittings in the holes in the side of the base panels (see fig.)
4. Place the first hob in the hole.
5. Apply silicone to the two corners joining the next hob (see fig.)
Use only the silicone supplied with the hobs as this is intended to tolerate the high temperatures of the appliance.
6. Push a reinforcement beam up against the hob. Apply silicone on the reinforcement beam (see fig.)
7. Tighten the clamping fittings to the table top using a screwdriver.
8. Repeat the process for the other hobs.

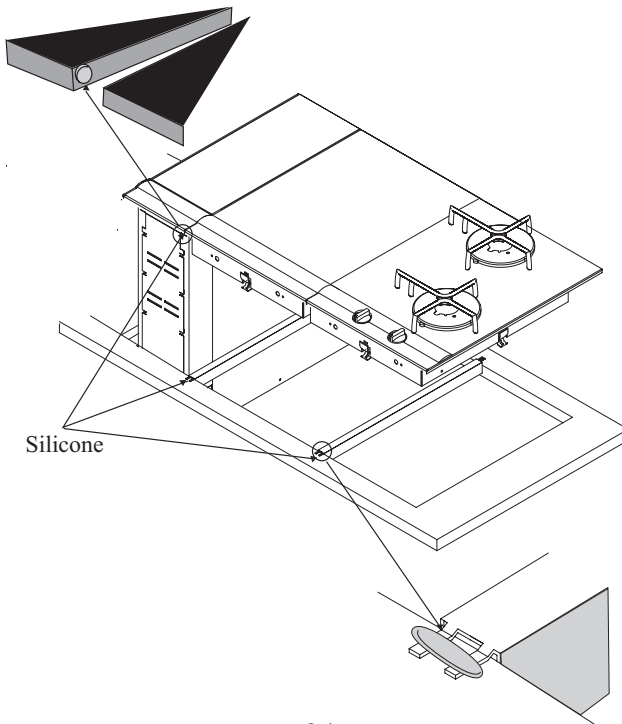

To optimise joints between the installed hobs, the gap between the ceramic hob may be grouted with silicone:

1. Remove the aluminium panels from the hobs.
2. Apply a stripe of silicone to the gap between the two ceramic hob. Use only the silicone supplied, as it is designed to tolerate the appliance's high temperature. (Fig. 1)
3. Splash a little soapy water (washing-up liquid) on the silicone stripe
4. Press the rubber block hard against the ceramic hob and pull it slowly from back to front (Fig. 2)
5. Leave the silicone to harden until the next day.
6. Remove surplus silicone coating from the ceramic hob with the razorblade supplied. Be careful not to damage the silicone in the gap. Run tools only along the joint, never across it.
7. Polish the ceramic hob with the supplied cleaning product for ceramic hobs.

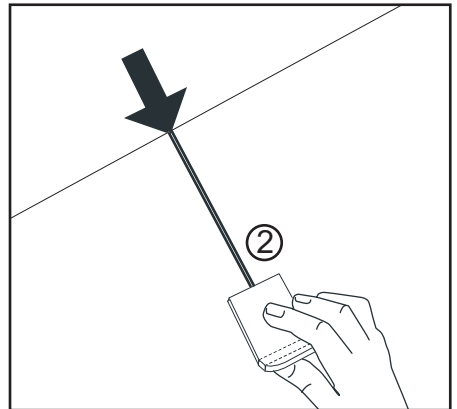
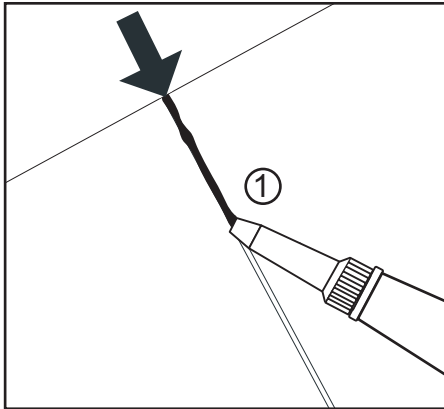

Overview of the outside width of the units

180 mm

Downdraft

360 mm

Glass ceramic hob with 2 cooking zones

Gas hob with 2 burners

Induction hob with 2 cooking zones

Grill

Grill / Fryer

Wok

580 mm

Glass ceramic hob with 4 cooking zones

Gas hob with 4 burners

720 mm

Glass ceramic hob with 4 cooking zones

Gas hob with 4 burners

Induction hob with 4 cooking zones

What to do if...

If the appliance is not working correctly, please carry out the following checks before contacting your local AEG Service Force Centre.

IMPORTANT: If you call out an engineer to a fault caused by incorrect use or installation, a charge will be made even if the appliance is under guarantee.

Problem	Remedy
The hob doesn't work.....	Check that the hob is switched on. Check the mains electricity is connected. Check the fuse for the hob. Check whether the gas has been turned on. Check whether the gas bottle is empty.
The gas isn't burning properly.....	Check that the burner ring and cover are correctly positioned. See the section "How to use the hob"
The electric ignition isn't working.....	Check the mains electricity is connected.
When the control knob is released, the gas goes out again	Make sure you press the control knob all the way in and hold it for 10 seconds.

In-guarantee customers should ensure that the above checks have been made as the engineer will make a charge if the fault is not a mechanical or electrical breakdown.

Please note that it will be necessary to provide proof of purchase for any in-guarantee service calls.

Service and Spare Parts



Work performed by unskilled persons may lead to injuries and or damages and deteriorate the appliance.



Interference with the appliance during the warranty period may only be performed by our service centre or by an organisation approved by our service centre.

In the event of your appliance requiring service, or if you wish to purchase spare parts, contact your local AEG Service Force Centre by telephoning:

08705 929 929

Your call will automatically be routed to the Service Centre covering your post code area.

For the address of your local Service Force Centre and further information about Service Force, please visit the website at www.serviceforce.co.uk

In-guarantee customers should ensure that the recommended checks under the heading “What to do if..” have been made as the engineer will make a charge if the fault is not a mechanical or electrical breakdown.

Please note that proof of purchase is required for in-guarantee service calls.

Help us to help you

Please determine your type of enquiry before writing or telephoning. When you contact us we need to know:

1. Your name, address, post code and telephone number
2. Clear and concise details of the fault.
3. Date of purchase
4. The model and serial number

This information can be found on the rating plate.

Customer Care

For general enquires concerning your AEG appliance or for further information on AEG products, please contact our Customer Care Department at the address below or visit our website at www.aeg.co.uk

Customer Care Department
AEG Domestic Appliances
55-77 High Street
Slough, Berkshire
SL1 1DZ
Tel 08705 350350*

***calls to this number may be recorded for training purposes**

GUARANTEE CONDITIONS

Standard guarantee conditions

We, AEG, undertake that if within 12 months of the date of the purchase this AEG appliance or any part thereof is proved to be defective by reason only of faulty workmanship or materials, we will, at our discretion repair or replace the same FREE OF CHARGE for labour, materials or carriage on condition that:

- The appliance has been correctly installed and used only on the electricity or gas supply stated on the rating plate.
- The appliance has been used for normal domestic purposes only, and in accordance with the manufacturer's operating and maintenance instructions.
- The appliance has not been serviced, maintained, repaired, taken apart or tampered with by any person not authorised by us.
- All service work under this guarantee must be undertaken by a Service Force Centre. Any appliance or defective part replaced shall become the Company's property.
- This guarantee is in addition to your statutory and other legal rights.
- Home visits are made between 8.30am and 5.30pm Monday to Friday. Visits may be available outside these hours in which case a premium will be charged.

Exclusions

This guarantee does not cover:

- Damage or calls resulting from transportation, improper use or neglect, the replacement of any light bulbs or removable parts of glass or plastic.
- Costs incurred for calls to put right an appliance which is improperly installed or calls to appliances outside the United Kingdom.
- Appliances found to be in use within a commercial environment, plus those which are subject to rental agreements.
- Products of AEG manufacture which are not marketed by AEG.

European Guarantee

If you should move to another country within Europe then your guarantee moves with you to your new home subject to the following qualifications:

- The guarantee starts from the date you first purchased your product.
- The guarantee is for the same period and to the same extent for labour and parts as exists in the new country of use for this brand or range of products.
- This guarantee relates to you and cannot be transferred to another user.
- Your new home is within the European Community (EC) or European Free Trade Area.
- The product is installed and used in accordance with our instructions and is only used domestically, i.e. a normal household.
- The product is installed taking into account regulations in your new country.

Before you move please contact your nearest Customer Care centre, listed below, to give them details of your new home. They will then ensure that the local Service Organisation is aware of your move and able to look after you and your appliances.

France	Senlis	+33 (0)3 44 62 29 29
Germany	Nürnberg	+49 (0)800 234 7378
Italy	Pordenone	+39 (0)800 117511
Sweden	Stockholm	+46 (0)8 672 53 60
UK	Slough	+44 (0)1753 219899

 **From the Electrolux Group.** *The world's No.1 choice.*

Electrolux is the world's largest producer of powered appliances for kitchen, cleaning and outdoor use. More than 55 million Electrolux Group products (such as refrigerators, cookers, vacuum cleaners, chain saws and lawn mowers), are sold each to a value of approx. 14 billion USD in more than 150 countries around the world.

Free Manuals Download Website

<http://myh66.com>

<http://usermanuals.us>

<http://www.somanuals.com>

<http://www.4manuals.cc>

<http://www.manual-lib.com>

<http://www.404manual.com>

<http://www.luxmanual.com>

<http://aubethermostatmanual.com>

Golf course search by state

<http://golfingnear.com>

Email search by domain

<http://emailbydomain.com>

Auto manuals search

<http://auto.somanuals.com>

TV manuals search

<http://tv.somanuals.com>