

Quick Start Guide

English

Simple Steps

To Get Your “Trellis-Ready”
AeroGarden® Deluxe
Up and Growing

KEEP THIS GUIDE!

CONGRATULATIONS

On your purchase of the AeroGarden Deluxe!

With this upgraded AeroGarden you get all the features of the original AeroGarden, enhanced with...

- **“24-Hour Light” Setting** – that lets you override the built-in light timer and decide how much light your plants receive (see details on page 10).
- **24” Extendable Arm** – which gives you the flexibility to grow tall plants, such as full-size tomato plants and bell peppers.
- **Enhanced Lamp Hood** – with 3 *Deluxe Grow Bulbs*, providing more light than the original *Grow Bulbs*, giving larger plants the light needed to grow and thrive.
- **Deluxe Trellis System** – lets you easily support heavy, fruit-filled branches on full-size plants such as tomatoes, peppers and cucumbers.
- **“Replace Grow Bulbs” Indicator** – alerts you to replace *Deluxe Grow Bulbs*. With this feature, you’ll be sure plants are always getting the right intensity and full spectrum of light needed for optimal growth.

Model #s: 100733-BLK; 100733-WHT
Input Voltage: 115V, 60Hz, 1.5A

Date Code:

IMPORTANT SAFETY INSTRUCTIONS

(SAVE THESE INSTRUCTIONS)

When using this AeroGarden Deluxe electrical furnishing, basic precautions should always be followed, including the following:

Read all instructions before using this AeroGarden furnishing.

1. To reduce the risk of electric shock, the AeroGarden Deluxe has a specific plug. Do not change plug in any way.

DANGER – to reduce risk of electric shock:

2. Always unplug AeroGarden Deluxe from electrical outlet before cleaning or changing Grow Bulbs (light bulbs).

WARNING – to reduce risk of burns, fire, electric shock, or injury to persons:

3. Unplug AeroGarden Deluxe from outlet before putting on or taking off parts.
4. Close supervision is necessary when AeroGarden Deluxe is used by or near children, invalids, or disabled persons.
5. Use AeroGarden Deluxe only for its intended use as described in the instructions. Do not use attachments not recommended by manufacturer.
6. Never operate AeroGarden Deluxe if it has a damaged cord or plug, if it is not working properly, if it has been dropped and damaged, or if it has been dropped in water. If any of these conditions occur/exist, contact www.aerogardensupport.com or your country's local distributor for instructions.
7. Keep cord away from heated surfaces.
8. Never operate furnishing with air openings blocked. Keep air openings free of lint, hair, and the like.
9. Never drop or insert any object into any electrical openings.
10. Do not use outdoors.
11. Do not operate where aerosol (spray) products are being used or where oxygen is being administered.
12. Do not touch moving parts or hot parts such as pumps, bulbs, reflective surfaces, and the like.
13. To disconnect, remove plug from outlet.
14. Do not place or submerge base, cord, plug, or lamp hood in water or other liquid to clean it.
15. Do not allow water to contact hot light bulbs.
16. Use only approved and supplied parts and accessories. Use only lamp model 100633 (N. America) or 200633 (Europe & Australia) Grow Bulbs with this AeroGarden model. Use of any other kind of accessory is not recommended. Replacement parts can be ordered from www.aerogardensupport.com or from your retailer.
17. Do not use AeroGarden Deluxe for other than intended purpose.
18. This product is intended for household and residential use only. This product is not approved for commercial applications.
19. Read and follow all important notices on the AeroGarden Deluxe and in the accompanying literature.
20. If supply cord is damaged, it must be replaced by manufacturer, its service agent, or similarly qualified technician in order to avoid a hazard.
21. Electrical wiring must be in accordance with local regulations.
22. This appliance is not intended for use by persons (including children) with reduced physical, sensory or mental capabilities, or lack of experience and knowledge, unless they have been given supervision or instruction concerning use of appliance by a person responsible for their safety.
23. Children should be supervised to ensure they do not play with the appliance.

SAVE THESE INSTRUCTIONS

1 Quick Start Assembly

A Unpack Your AeroGarden Deluxe



Lamp Hood
(front view)

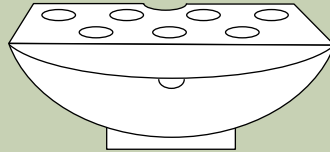

Bowl
(front view)



Lamp Arm
(back view)

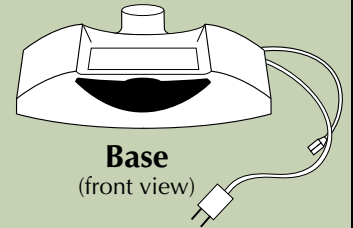

Base
(front view)

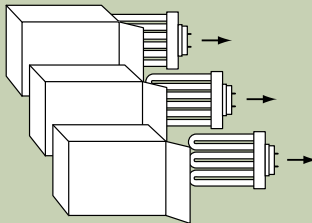

Deluxe
Grow Bulbs (3)



Master Gardener
Deluxe Kit

Trellis System Includes:

Instructions



Trellis Coil
Brackets (2)

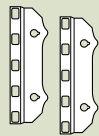

Trellis
Coils (2)



C Attach Trellis Brackets to Lamp Hood (Optional*)

Hand tighten pre-mounted screws with phillips head screwdriver. Do not over-tighten.

*Recommended for larger plants that need support, such as tomatoes, peppers or cucumbers. Can be added to AeroGarden Deluxe after garden is growing.

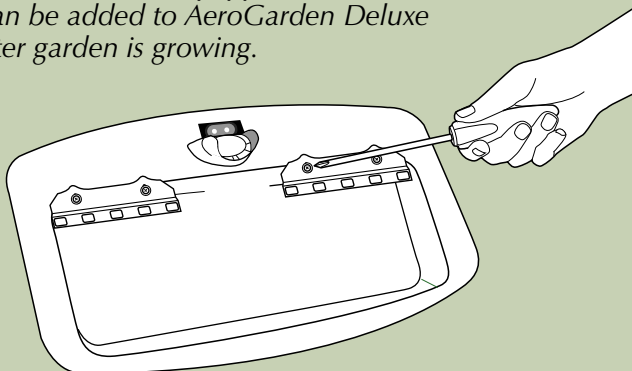

D Insert Deluxe Grow Bulbs into Lamp Hood

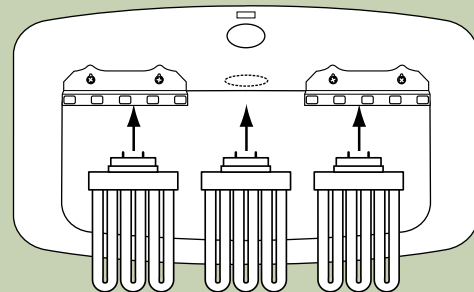

Lamp Hood (bottom view)

Push straight in.

DO NOT TWIST BULBS!

Remember to replace Grow Bulbs every 6 months.

B Insert Lamp Arm into Base

Push Lamp Arm down until you hear a "click."

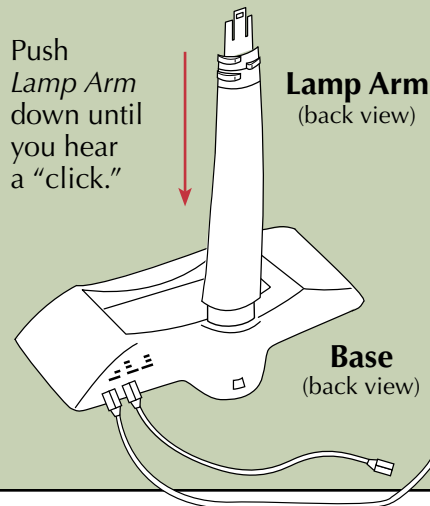

Lamp Arm
(back view)

Base
(back view)

Instructions Continued On Next Page  2

1 Quick Start Assembly (continued)

E Plug Lamp Cord into Lamp Hood

Push *Lamp Cord* firmly into socket in *Lamp Hood*.

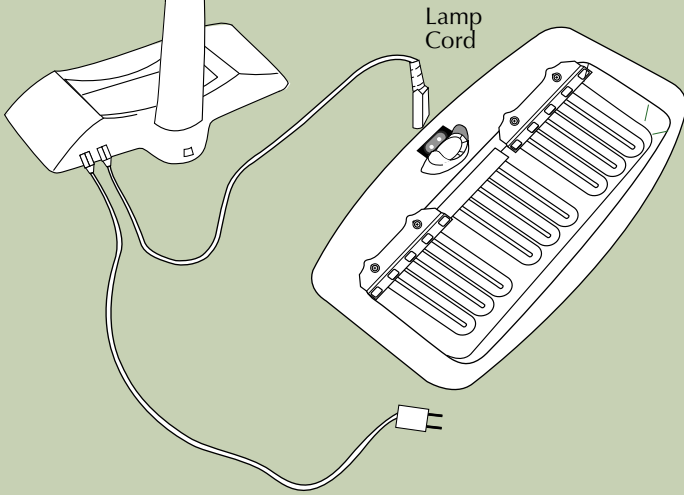

F Place Lamp Hood on Lamp Arm

Center hands over *Lamp Arm* and push *Lamp Hood* down until you hear a "click."

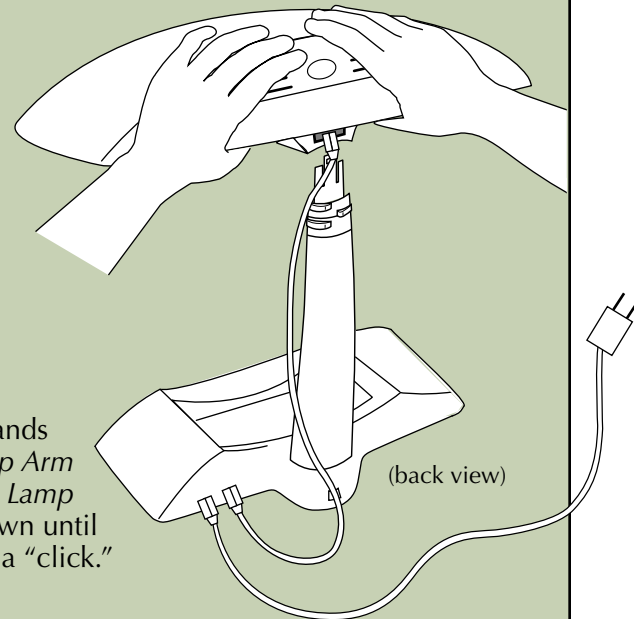

G Set Bowl into Base

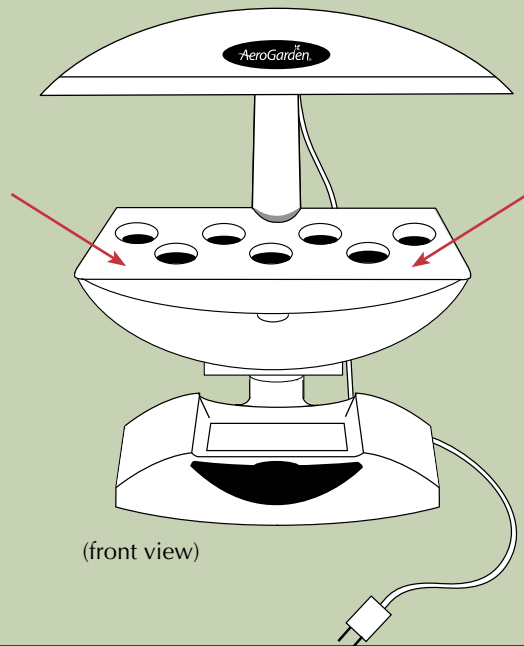

Check to be sure that *Bowl* is securely in place.

H Moving Your AeroGarden Deluxe

Use one hand to grasp *Lamp Arm*.

Gently slide AeroGarden toward the surface edge and place other hand under *Base*.

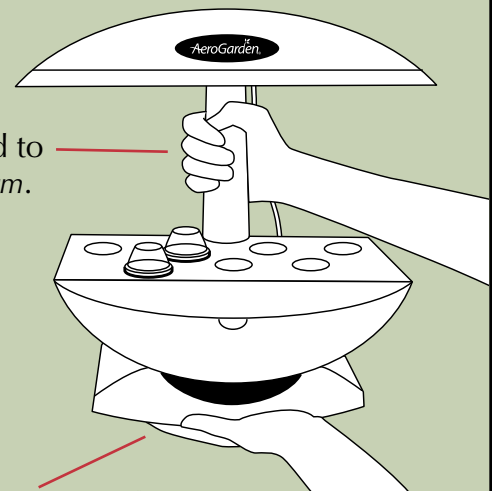

I Place Your Garden

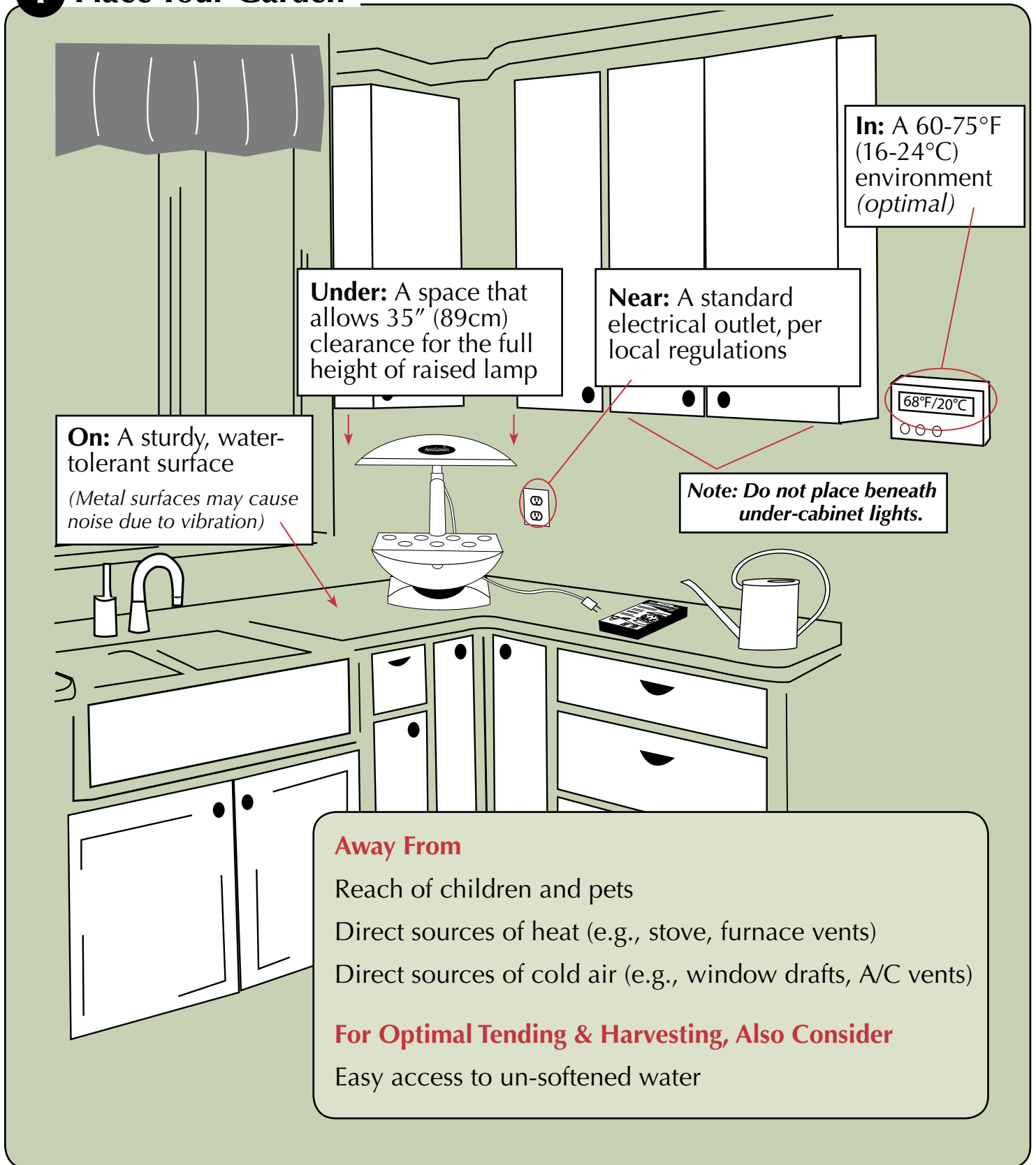

2 Planting Your Garden

A Add Water Using a Spouted Container

Use room temperature municipal tap, bottled or purified water. **Do not** use well or softened water.

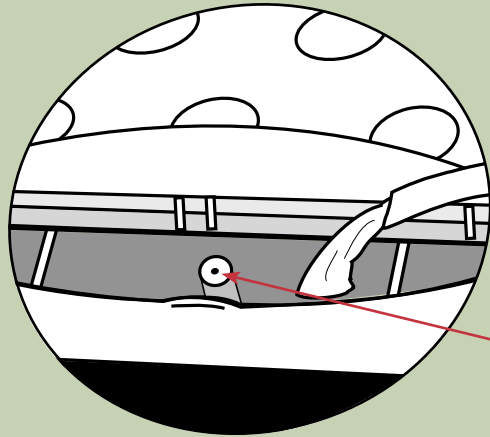

Fill to **"Fill To Here"**
(located inside the Bowl)

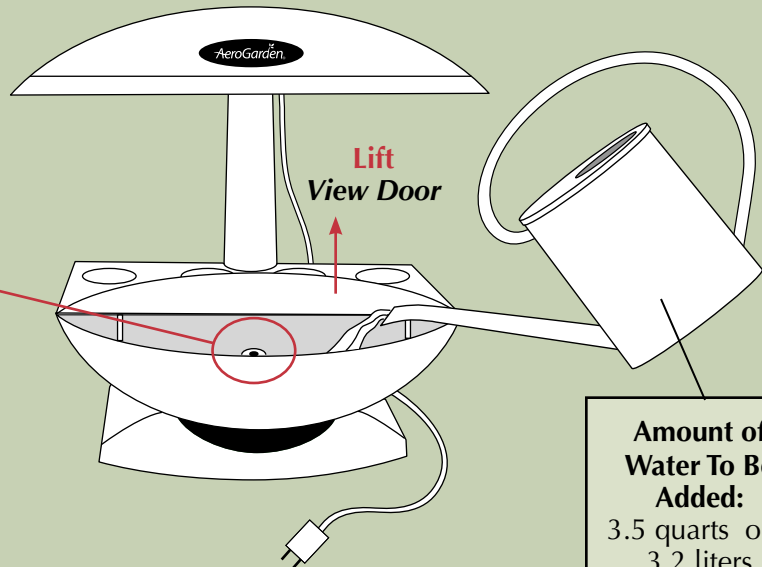

Amount of Water To Be Added:
3.5 quarts or...
3.2 liters

When additional water is needed, "Water Level Low" light on Control Panel will blink. Add water to raise level up to "Fill To Here" inside Bowl. It is okay to add water up to "Fill To Here" before "Water Level Low" light blinks.

B Plant Your Garden

The AeroGarden Deluxe comes with a *Master Gardener Deluxe Kit* for planting three (3) seasons of your own seeds.

Please refer to *Master Gardener Deluxe Guide* for detailed planting instructions.

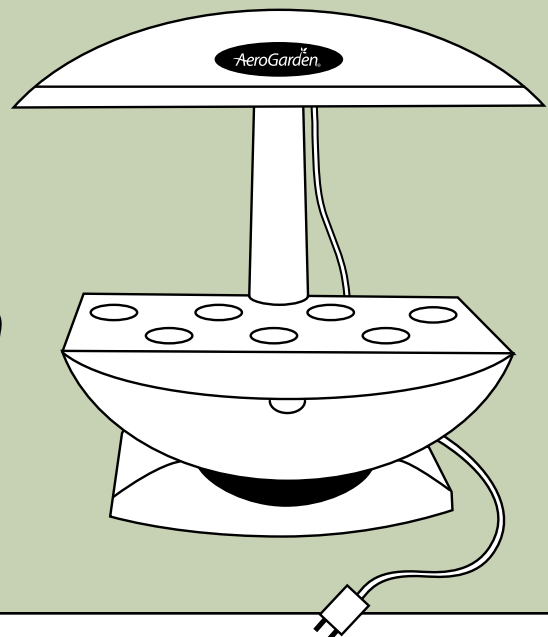
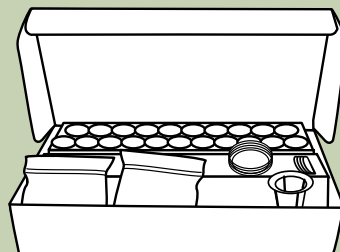

C Place Bio-Domes™ on Seed Pods

Place a *Bio-Dome* on each *Seed Pod*.

Press *Bio-Dome* down until its rim almost touches *Grow Surface*.

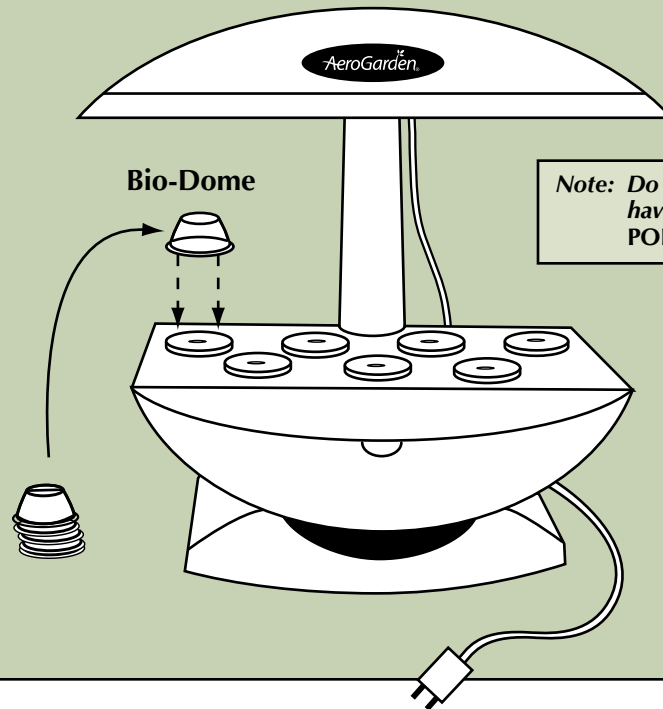

Note: Do not remove Bio-Domes until seeds have sprouted. NEVER REMOVE SEED POD LABELS.

D Add Starting Nutrient Tablets and Record Planting Date

Record Planting Date

We recommend that you record the date *Master Gardener Deluxe Seed Pods* were planted on a calendar or in a notebook.

Add 2 tablets from "Small" nutrient bag directly into *Bowl*.

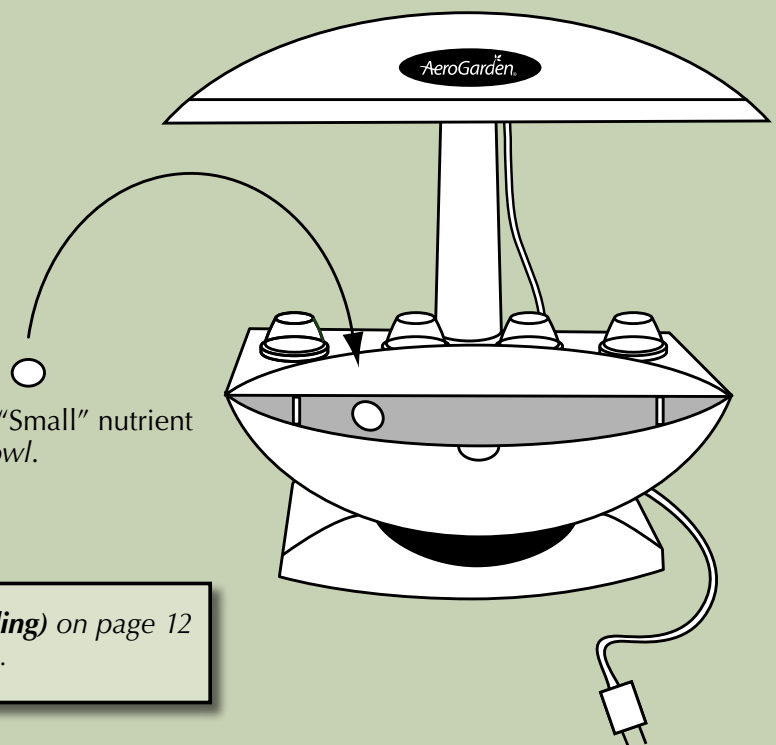

See "**Add Nutrient**" (*Feed Garden - Basic Feeding*) on page 12 of this guide for additional feeding instructions.

3 Starting Your Garden

A Plug Cord into Electrical Outlet

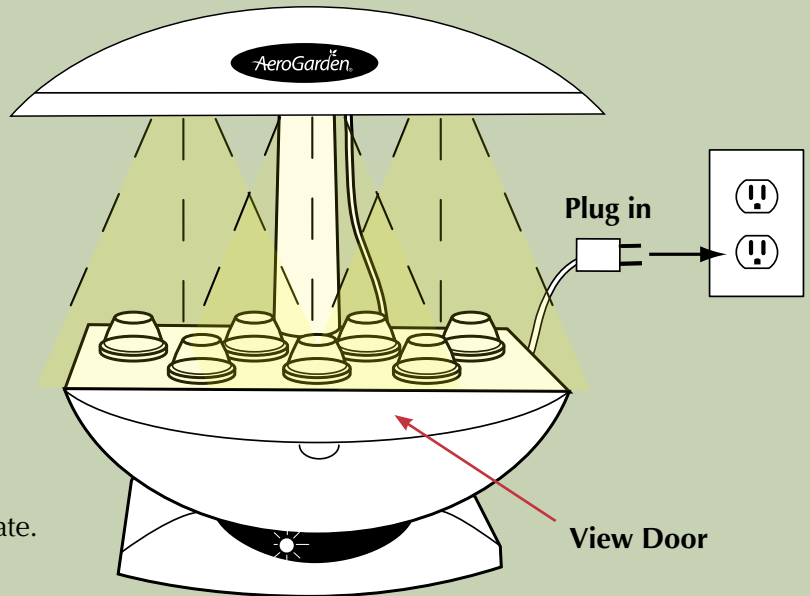

What will happen...

- 1 A white light on *Control Panel* will illuminate.
- 2 *Deluxe Grow Bulbs* will come on.
Look under Lamp Hood to check that all 3 bulbs are lit.
If not, check to see if:
 - *Deluxe Grow Bulbs* are properly inserted in *Lamp Hood* (page 2, step 1D).
 - *Lamp Cord* is plugged into *Lamp Hood* (page 3, step 1E).
 - You are getting power through the electrical outlet.
- 3 When Pump starts* it may make a gurgling noise for a moment.
Lift View Door. You should see water dripping from the bottom of Seed Pods into the Bowl.
If not, check to see if:
 - *Lamp Arm* is fully inserted into *Base* (page 2, step 1B).
 - *Bowl* is firmly seated in *Base* (page 3, step 1G).

*Pump may take up to twelve hours to start.

Note: You will hear water flowing until plant roots have grown to surface level of water (a few weeks). Keeping water level in Bowl up to "Fill To Here" will help reduce the sound of dripping water.

B Select Setting

Press the **SELECT** button until you reach the type of plants you are growing (Tomatoes/Peppers, Salad Greens, etc.).

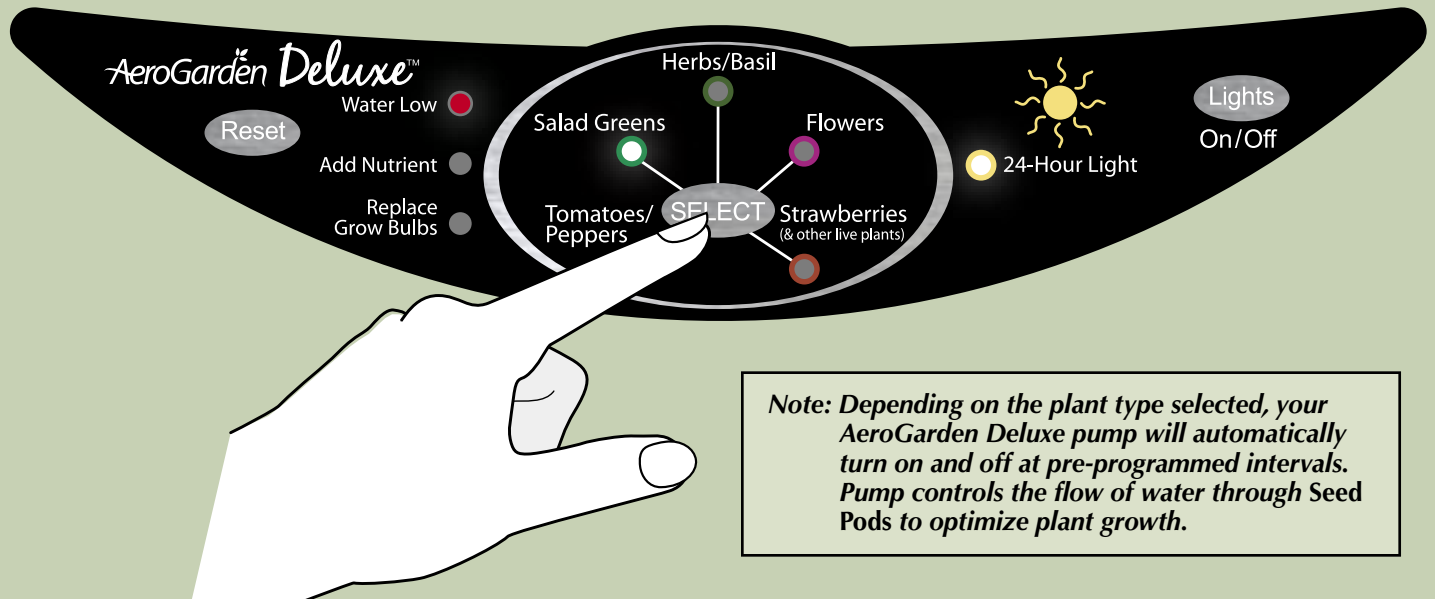

Note: Depending on the plant type selected, your AeroGarden Deluxe pump will automatically turn on and off at pre-programmed intervals. Pump controls the flow of water through Seed Pods to optimize plant growth.

C Your Light Timer

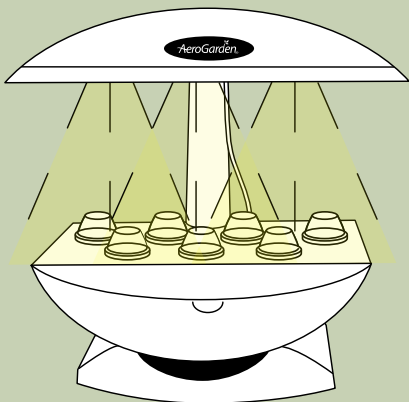

1

Your Light Timer is Set To Start Growing Your Plants...Starting Now!

2

If You Would Like to Change the Time of Day Your Lights Will Go Off...

See "Personalize Your Light Timer" on page 9.

- Your lights will **stay on for about 16 hours** and will shut off for about **8 hours**.*
- Your lights will come on every day at the time you plugged in your AeroGarden Deluxe.*

*Except when using "24-Hour Light" setting, which sets lights to be on for 24 hours.

Personalize Your Light Timer (optional)

Your AeroGarden has lights and a built-in timer that automatically provide plants with the optimal amount of “sunlight” (about 16 hours) and “night” (about 8 hours), depending on the plant type selected in the previous section.

As long as plants get this amount of light, it does not matter when lights are turned off.* Many people find it convenient to have lights go on in the morning and off at night to match their own wake and sleep schedule.

**The exceptions to this are Flower & Vegetable plants. They require a daily dark period in order to produce flowers. If your plants will receive any room light during the day (natural or artificial), we recommend setting your AeroGarden lights to be on during the day.*

5 Simple Steps...

In order to make this as simple as possible, you only need to set the time you want your AeroGarden

lights to go off (Off Time) and your built-in light timer automatically sets the On Time...nothing more for you to do.

Do the following to set the time you want your lights to go off:

- 1** Decide what time you want the lights to go *OFF*.
- 2** *AT THAT TIME* check that lights are on. If they are off, quickly press “Lights” button and immediately release. (Lights must be on in order to reset timer.)
- 3** With lights on, press and hold “Lights” button until white light next to the plant type you selected starts blinking – about 5 seconds.
- 4** Release the button.
- 5** When blinking stops (about 9 seconds), the lights will go off and your lights are now set to go off at this time every day.

You can reset your timer as often as you want.

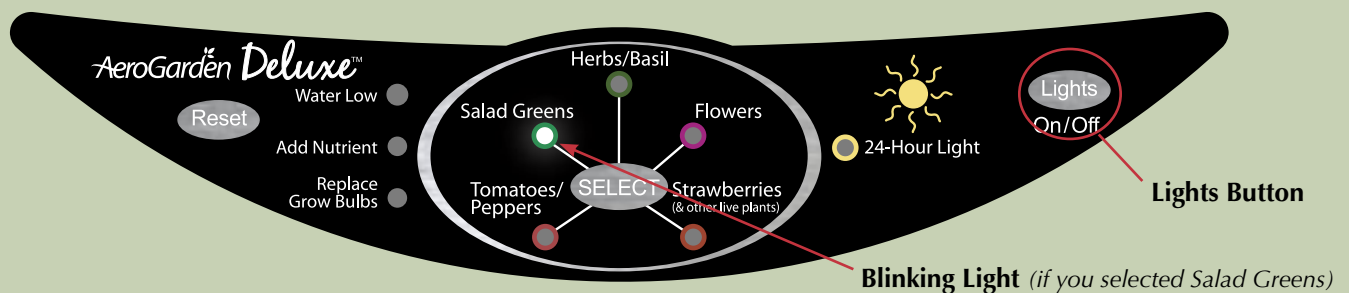

In case of power failure, your AeroGarden Deluxe has a backup system that stores light, nutrient & replace grow bulbs timers as well as plant selection settings. When power is restored, your AeroGarden will go back to the Off-On cycle you have set.

Personalize Your Light Timer (continued)

AeroGarden Deluxe “24-Hour Light” Setting

The “24-Hour Light” setting allows you to override the built-in light timer and keep lights on and pump running 24 hours a day. You can also customize the amount of light plants receive by manually turning lights on and off using the “Lights” button, or setting automatic on/off times, using a standard light timer.*

Use the “24-Hour Light” setting when growing plants that thrive with continual light and moisture, such as leafy greens and some herbs.

For the more experienced gardener, the “24-Hour Light” setting provides added flexibility when planting a custom garden. You are no longer limited to the pre-programmed light schedules associated with each plant type (such as Tomatoes/Peppers, Salad Greens, etc.).

NOTE: “24-Hour Light” setting is not recommended for Flower or Vegetable plants – they require a daily dark period to produce flowers.

Accessing the “24-Hour Light” Setting

- Press and release “Select” until the white light next to “24-Hour Light” is illuminated.
- To exit “24-Hour Light” setting, simply push the “Select” button.

*** Not included.** If you use a light timer to turn the lights on and off, the nutrient timer and pump will stop whenever the lights are OFF. Both will start up again when the lights turn back on. The nutrient timer does not record the time elapsed when lights are off. To ensure that plants are fed every 2 weeks, we recommend keeping track of your feeding schedule on a calendar.

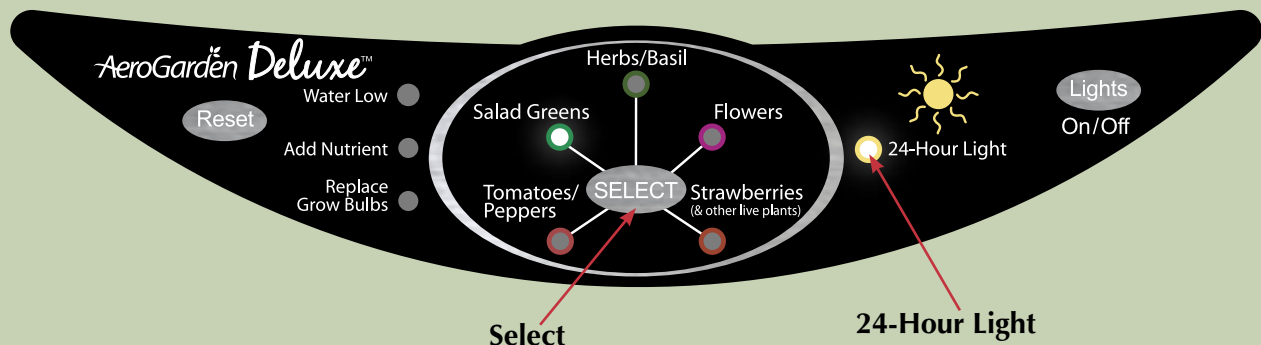

Once your AeroGarden Deluxe is set on the “24-Hour Light” setting, lights and pump will remain on 24 hours a day. To shorten the amount of time lights are on, quickly press and release “Lights” button, and lights will turn off. Lights will automatically come back on within 12 hours – or, you can press and release “Lights” button again, to turn lights back on.

Use *Trellis System* (optional)

- 1 Clip *Trellis Coil* on *Bracket*.

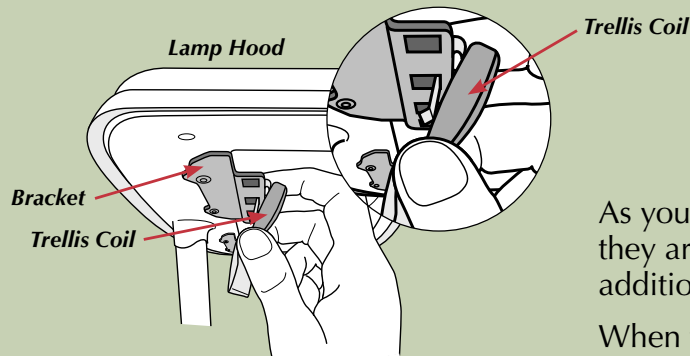

As your plants begin to produce fruit, you may find they are starting to tip over or even break due to the additional weight on branches.

When this occurs, support plants and bring them back to the upright position by using your *Trellis System**.

**Trellis Brackets* must be attached to the *Lamp Hood* in order to use the *Trellis System* (see *Bracket* attachment instructions on page 2, step 1C).

- 2 Pull down *Trellis Coil*.

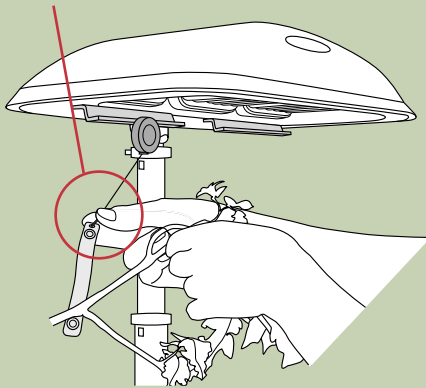

- 3 Wrap *Strap* around branch that needs support and snap closed.

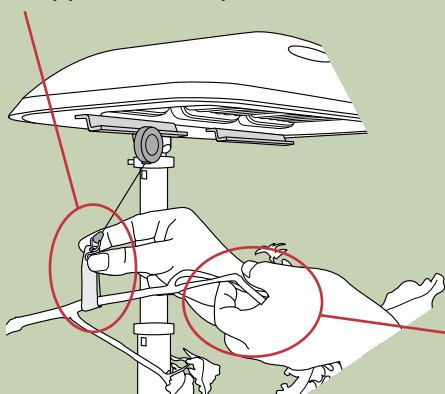

- 4 Gently push up on supported branch until it is at desired height.

As a safety precaution, unplug AeroGarden furnishing before performing this task. Be sure Grow Bulbs are cool to the touch before attaching or adjusting *Trellis Coil*.

Basic Reminders About Your AeroGarden

AeroGarden Deluxe Control Panel

• Water Low

When light blinks add water up to "Fill To Here."

• Lights On/Off

Use to *occasionally* override built-in light timer. Once pushed, lights will stay off/on until the next time built-in light timer is set to go on/off. This will not affect the timing of your light cycle and *occasional* use of this feature will not harm your plants.

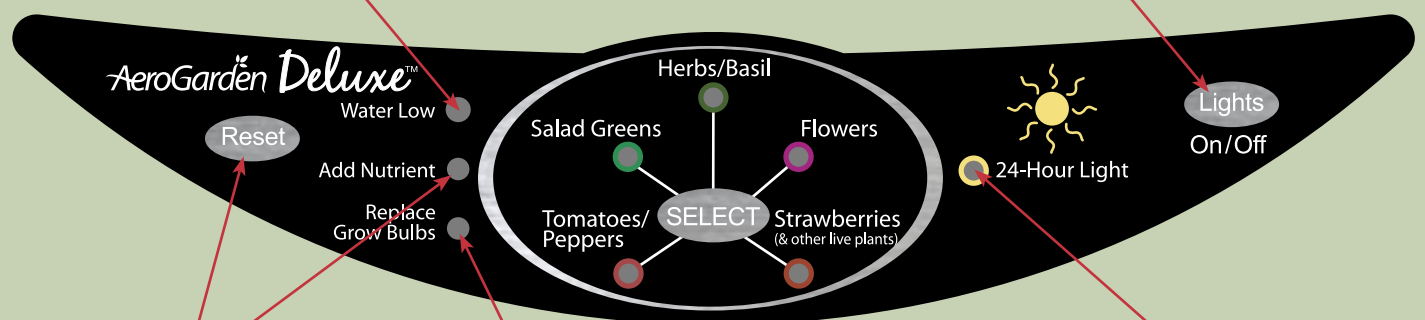

• Add Nutrient

(Feed Garden - Basic Feeding)

When "Add Nutrient" and "Water Low" lights start blinking (every 2 weeks), add 2 nutrient tablets* and fill the *Bowl* with water up to "Fill to Here." Press and release "Reset" button to restart nutrient timer and turn off blinking lights.

*See *Tending & Harvesting Guide* for plant-specific nutrient information.

• Replace Grow Bulbs*

When light blinks (after 6 months of use), it is time to replace *Deluxe Grow Bulbs*. Replacement bulbs can be ordered at www.aerogardensupport.com or from your retailer. After replacing *Deluxe Grow Bulbs*, press "Reset" button to restart grow bulb timer and turn off flashing light.

NOTE: If you store your *AeroGarden Deluxe* between uses, grow bulb timer automatically stops when *AeroGarden Deluxe* is unplugged.

*See complete replacement instructions on next page.

• 24-Hour Light

Illuminated white light indicates the *AeroGarden Deluxe* is on "24-Hour Light" setting.

• Remove Bio-Domes

When plants appear through hole in *Seed Pod Labels*, remove *Bio-Domes* and discard or recycle.

NOTE: Never remove *Seed Pod Labels*.

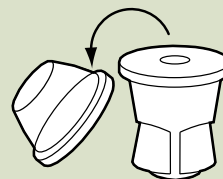

Basic Reminders About Your AeroGarden (continued)

AeroGarden Deluxe Lamp Arm & Hood Features

Raise Lamp Hood (Lights)

As plants grow to **1-2" from lights**, raise *Lamp Arm* one notch at a time (each of the three *Lamp Arm* sections has three notches). Be sure *Lamp Arm* is set at the lowest setting when you start your AeroGarden Deluxe.

1 Unplug AeroGarden Deluxe and remove *Bowl* from *Base*.

2 Raise *Lamp Arm/Lamp Hood*:

- Hold *Lamp Arm* where it connects to *Lamp Hood* with one hand. With other hand, push in *Locking Lever*.
- Release *Locking Lever* while pulling up on *Lamp Arm*.
- *Locking Lever* will automatically click into next notch in the *Lamp Arm* section.

3 Replace *Bowl* on *Base* and plug in AeroGarden Deluxe.

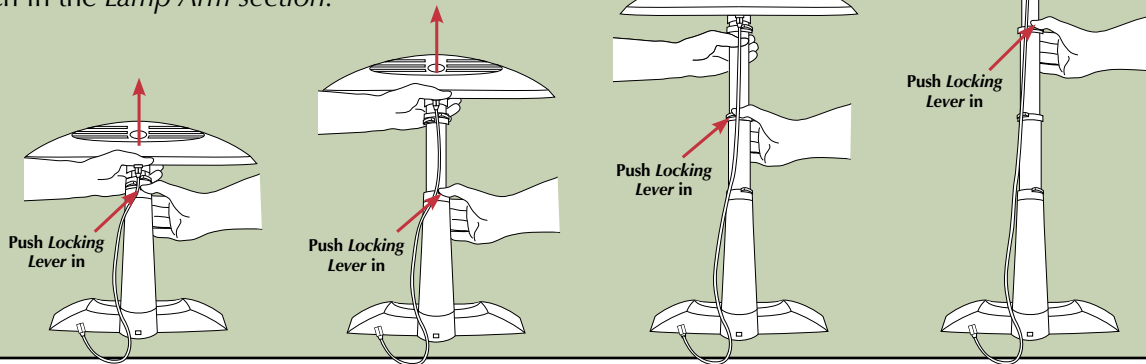

Replace Grow Bulbs – Order bulbs at www.aerogardensupport.com



When “Replace Grow Bulbs” light on *Control Panel* begins blinking after 6 months of use...

- Unplug AeroGarden Deluxe.
- Remove old *Grow Bulbs* and carefully discard*.
- **IMPORTANT:** To avoid burning, be sure *Grow Bulbs* are cool before handling.
- Insert new *Grow Bulbs* into *Lamp Hood*.
- Plug in AeroGarden Deluxe and press and release “Reset” button to restart grow bulb timer.

Early *Grow Bulb* Replacement

If you replace *Grow Bulbs* before “Replace Grow Bulbs” light illuminates, be sure to restart grow bulb timer as follows:

- Press and hold “Lights” button until white light next to your selected plant type starts blinking – about 5 seconds.
- Release “Lights” button. The plant type selected light will continue to blink for about 9 seconds. While plant light is still blinking...
- Quickly press and release “Reset” button. “Replace Grow Bulbs” light will blink once and the plant selected light will stop blinking.

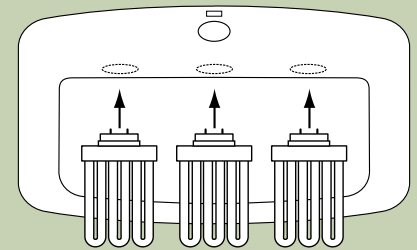

*Check with local recycling authorities for light bulb recycling availability in your area.

Prepare For Your Next Garden

Cleaning Instructions for your AeroGarden

Use only water and mild soap when cleaning your AeroGarden (except when Sanitizing - Step 7). Do not use abrasive cleaners or run through the dishwasher.

When your garden has completed it's growing cycle...

1 Unplug AeroGarden.

2 Carefully remove *Bowl* and *Grow Surface* from *Base* and bring to a sink. Set *Base* and *Lamp Hood* aside.

NEVER SUBMERSE BASE AND CONTROL PANEL IN WATER.

3 Remove *Grow Surface* from *Bowl* and place on a counter near a sink.

4 Empty contents of *Bowl* in sink.

5 Remove *Seed Pods* and plants from *Grow Surface*.

- Pull *Seed Pods* out of *Grow Surface* openings.
- Throw away *Seed Pods* and plant debris (plant growth and roots). If you compost, plant debris can be composted.

6 Rinse and clean *Grow Surface*, *Pump Stand* and *Pump Filter*.*

- Use a soft scrub brush to clean tangled roots from underside of *Grow Surface* and *Pump Stand*.
- Remove *Pump Filter* from *Pump Stand*. Gently scrub roots from *Pump Filter*.
- Place *Pump Filter* back into *Pump Stand*.

*After cleaning, there may still be a few roots in your *Grow Surface*, *Pump Stand* or *Pump Filter*. This will not affect the operation of your AeroGarden.*

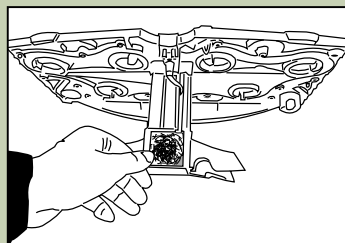
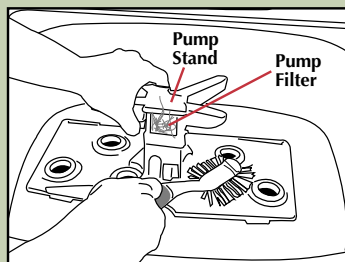
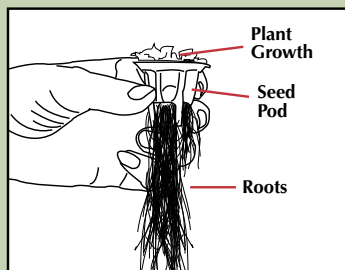
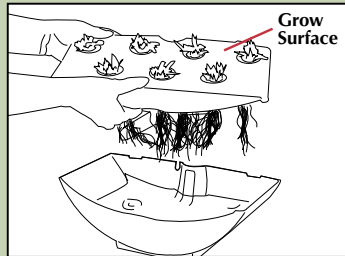

7 Sanitize AeroGarden.

- Fill *Bowl* $\frac{3}{4}$ full with water.
- Add $\frac{1}{4}$ cup (59ml) of chlorine bleach.
- Replace *Grow Surface* on *Bowl*, place *Bowl* on *Base* and plug in AeroGarden for 1-2 minutes. (*Select Salad Greens* on Control Panel to be sure water is flowing.)
- Unplug AeroGarden and empty bleach water from *Bowl*.

8 Rinse AeroGarden.

- Refill *Bowl* with tap water and replace on *Base*.
- Plug in and run AeroGarden for 1-2 minutes. (*Select Salad Greens* again.)
- Unplug AeroGarden, empty *Bowl* and repeat this step (step 8) one more time.

9 Towel dry the *Bowl* and *Grow Surface* before putting them back together and setting them back on the *Base*.

10 If your *Grow Bulbs* have been in use more than 6 months, they should be replaced at this time (see page 12).

Your AeroGarden is now ready for replanting.

*** IMPORTANT NOTE:** We recommend replacing the *Pump Filter* after growing two gardens. Order *Pump Filters* from www.aerogardensupport.com or from your retailer.

Prepare For Your Next Garden (continued)

Replanting Your AeroGarden

If you have already grown a garden in your AeroGarden, please follow the instructions below to reset the nutrient timer:

- Press and HOLD "Reset" button until red "Add Nutrient" light blinks (approximately 9 seconds).
- Release "Reset" button. "Add Nutrient" light will turn off.
- Your AeroGarden is now reset. (In some cases you may see other lights blink as well. This is nothing to worry about.)

NOTE: These steps do not reset grow bulb timer.

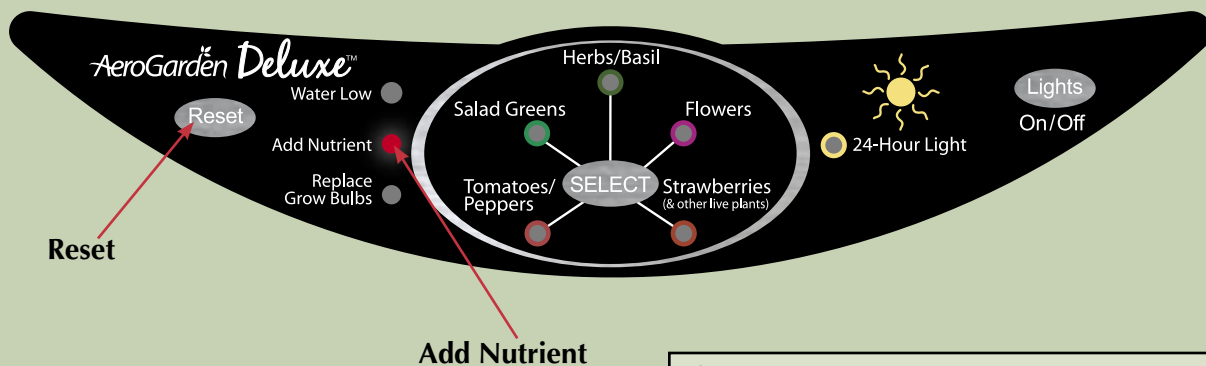

! Bundle cord when furnishing is not in use.

U.S. CAUTION – You are cautioned that any changes or modifications not expressly approved in this manual could void your authority to operate this equipment.

NOTE: This equipment has been tested and found to comply with the limits for a Class B digital device, pursuant to Part 15 of the FCC Rules. These limits are designed to provide reasonable protection against harmful interference in a residential installation. This equipment generates, uses, and can radiate radio frequency energy and, if not installed and used in accordance with the instructions, may cause harmful interference to radio communications. However, there is no guarantee that interference will not occur in a particular installation. If this equipment does cause harmful interference to radio or television reception, which can be determined by turning the equipment off and on, the user is encouraged to try to correct the interference by one or more of the following measures: Reorient or relocate the receiving antenna; Increase the separation between the equipment and receiver; Connect the equipment into an outlet on a circuit different from that to which the receiver is connected; or, Consult the dealer or an experienced radio/TV technician for help.

To reduce the risk of electric shock, this furnishing has a polarized plug (one blade is wider than the other). This plug will fit in a polarized outlet only one way. If the plug does not fit fully in the outlet, reverse the plug. If it still does not fit, contact a qualified electrician to install the proper outlet. Do not change the plug in any way.

CAUTION: TO PREVENT ELECTRIC SHOCK, MATCH WIDE BLADE OF PLUG TO WIDE SLOT, FULLY INSERT.

ATTENTION: POUR ÉVITER UN CHOC ÉLECTRIQUE, PRÉSENTER LA LAME LARGE À LA FENTE LARGE ET POUSSER JUSQU'AU FOND.

AeroGarden[®] Deluxe

© 2007-2008 AeroGrow International, Inc., Boulder, CO U.S.A. U.S. Patents Pending
5/8/08

Download from Www.Somanuals.com. All Manuals Search And Download.

Free Manuals Download Website

<http://myh66.com>

<http://usermanuals.us>

<http://www.somanuals.com>

<http://www.4manuals.cc>

<http://www.manual-lib.com>

<http://www.404manual.com>

<http://www.luxmanual.com>

<http://aubethermostatmanual.com>

Golf course search by state

<http://golfingnear.com>

Email search by domain

<http://emailbydomain.com>

Auto manuals search

<http://auto.somanuals.com>

TV manuals search

<http://tv.somanuals.com>