

Errata

Title & Document Type: 6296A Operating & Service Manual

Manual Part Number: 06296-90001

Revision Date: December 1966

HP References in this Manual

This manual may contain references to HP or Hewlett-Packard. Please note that Hewlett-Packard's former test and measurement, semiconductor products and chemical analysis businesses are now part of Agilent Technologies. We have made no changes to this manual copy. The HP XXXX referred to in this document is now the Agilent XXXX. For example, model number HP8648A is now model number Agilent 8648A.

About this Manual

We've added this manual to the Agilent website in an effort to help you support your product. This manual provides the best information we could find. It may be incomplete or contain dated information, and the scan quality may not be ideal. If we find a better copy in the future, we will add it to the Agilent website.

Support for Your Product

Agilent no longer sells or supports this product. You will find any other available product information on the Agilent Test & Measurement website:

www.tm.agilent.com

Search for the model number of this product, and the resulting product page will guide you to any available information. Our service centers may be able to perform calibration if no repair parts are needed, but no other support from Agilent is available.





DC Power Supply
HP Model 6296A
Operating and Service Manual

AAHO



**HEWLETT
PACKARD**

**OPERATING AND
SERVICE MANUAL**

**DC POWER SUPPLY
HP MODEL 6296A**

HP Part No. 06296-90001

SERIAL NUMBER PREFIX 6D

OTS LIBRARY

ONE YEAR WARRANTY

This HP product has a one year warranty. Please replace the first paragraph of the warranty statement on the inside front cover with the following:

This Hewlett-Packard hardware product is warranted against defects in material and workmanship for a period of one year from date of delivery. HP software and firmware products, which are designated by HP for use with a hardware product and when properly installed on that hardware product, are warranted not to fail to execute their programming instructions due to defects in material and workmanship for a period of 90 days from date of delivery. If HP receives notice of such defects during the warranty period, HP shall repair or replace software media and firmware which do not execute their programming instructions due to such defects. HP does not warrant that the operation for the software, firmware or hardware shall be uninterrupted or error free.

CALL CENTER LIBRARY



2400013351

Printed: December, 1966

CERTIFICATION

Hewlett-Packard Company certifies that this product met its published specifications at time of shipment from the factory. Hewlett-Packard further certifies that its calibration measurements are traceable to the United States National Bureau of Standards, to the extent allowed by the Bureau's calibration facility, and to the calibration facilities of other International Standards Organization members.

WARRANTY

This Hewlett-Packard hardware product is warranted against defects in material and workmanship for a period of one year from date of delivery. HP software and firmware products, which are designated by HP for use with a hardware product and when properly installed on that hardware product, are warranted not to fail to execute their programming instructions due to defects in material and workmanship for a period of 90 days from date of delivery. During the warranty period, HP Company will, at its option, either repair or replace products which prove to be defective. HP does not warrant that the operation of the software, firmware, or hardware shall be uninterrupted or error free.

For warranty service, with the exception of warranty options, this product must be returned to a service facility designated by HP. Customer shall prepay shipping charges by (and shall pay all duty and taxes) for products returned to HP for warranty service. Except for products returned to Customer from another country, HP shall pay for return of products to Customer.

Warranty services outside the country of initial purchase are included in HP's product price only if Customer pays HP international prices (defined as destination local currency price, or U.S. or Geneva Export price).

If HP is unable, within a reasonable time, to repair or replace any product to a condition as warranted, the Customer shall be entitled to a refund of the purchase price upon return of the product to HP.

LIMITATION OF WARRANTY

The foregoing warranty shall not apply to defects resulting from improper or inadequate maintenance by the Customer, Customer-supplied software or interfacing, unauthorized modification or misuse, operation outside of the environmental specifications for the product, or improper site preparation and maintenance. **NO OTHER WARRANTY IS EXPRESSED OR IMPLIED. HP SPECIFICALLY DISCLAIMS THE IMPLIED WARRANTIES OF MERCHANTABILITY AND FITNESS FOR A PARTICULAR PURPOSE.**

EXCLUSIVE REMEDIES

THE REMEDIES PROVIDED HEREIN ARE THE CUSTOMER'S SOLE AND EXCLUSIVE REMEDIES. HP SHALL NOT BE LIABLE FOR ANY DIRECT, INDIRECT, SPECIAL, INCIDENTAL, OR CONSEQUENTIAL DAMAGES, WHETHER BASED ON CONTRACT, TORT, OR ANY OTHER LEGAL THEORY.

ASSISTANCE

The above statements apply only to the standard product warranty. Warranty options, extended support contracts, product maintenance agreements and customer assistance agreements are also available. Contact your nearest Hewlett-Packard Sales and Service office for further information on HP's full line of Support Programs.

MANUAL CHANGES
Model 6296A DC Power Supply
Manual HP Part No. 06296-90001

Change Date 10/03/90

Make all corrections in the manual according to errata below, then check the following table for your power supply serial number and enter any listed change(s) in the manual.

| SERIAL | | MAKE CHANGES |
|--------|-------------|-----------------|
| Prefix | Number | |
| ALL | ----- | ERRATA |
| 6D | 00231-00260 | 1 |
| 6D | 00261-00290 | 1,2 |
| 7D | 00291-00320 | 1,2,3 |
| 7D | 00321-00350 | 1-4 |
| 7M | 00351-00380 | 1-5 |
| 7M | 00381-00410 | 1-6 |
| 7M | 00411-00522 | 1-7 |
| 7M | 00523-00612 | 1-8 |
| 7M | 00613-00712 | 1-9 |
| 7M | 00713-01776 | 1-10 |
| 1140A | 01777-01796 | 1-11 |
| 1140A | 01797-01816 | 1-12 |
| 1140A | 01817-02411 | 1-13 |
| 1551A | 02412-02419 | 1-14 |
| 1552A | 02420-02776 | 1-15 |
| 1730A | 02777-02956 | 1-16 |
| 1807A | 02957-02986 | 1-17 |
| 1816A | 02987-03146 | 1-18 |
| 1834A | 03147-03386 | 1-19 |
| 1918A | 03387-03545 | 1-20 |
| 1929A | 03547-04086 | 1-21 |
| 2114A | 04087-04246 | 1-22, *23 |
| 2133A | 04247-04486 | 1-23 |
| 2234A | 04487-04926 | 1-24 |
| 2410A | 04927-05566 | 1-25 |
| 2631A | 05567-05916 | 1-26 |
| 2841A | 05917-06036 | 1-27 |
| 2933A | 06037-06146 | 1-28 |
| 3003A | 06147-06206 | 1-29 |
| 3024A | 06207-up | 1-27, 29, 30 |

ERRATA

In Table 1-1 (and paragraph 5-20), change the INTERNAL IMPEDANCE AS A CONSTANT VOLTAGE SOURCE (Output Impedance) specification to read: "OUTPUT IMPEDANCE (TYPICAL): Approximated by a 5 milliohm resistance in series with a 1 microhenry inductance.

On page 3-2, Figure 3-4, disconnect strap between terminals A4 and A5 and connect A5 to +S. On page 3-3, Figure 3-6, disconnect strap between terminals A7 and A8 and connect A8 +S.

Add the following note to paragraph 3-18 on page 3-2 and to paragraph 4-41 on page 4-7: "A protection circuit which protects the series regulator from overload damage is activated whenever: (1) a short is placed across the supply, or (2) the output is rapidly down programmed by an increment of more than 4 to 10 volts. When activated, the protection circuit limits the supply's output current to about 10% of rating for a period of from 0.5 to 10 seconds depending on the model and the load conditions."

On page 5-6, paragraph 5-22, change steps a and f as follows:

- a. Connect test setup shown in Figure 5-4 with switch S1 closed.
- f. Insert load resistor (Ry) by opening switch S1. Also, add the following note: "The short circuit protection circuit in this supply will be activated if switch S1 is closed instead of opened during this test."

On page 5-8, in Step 3 of Table 5-4, change the text to read: "If it is not, proceed to Step 4."

ERRATA

In the parts list on page 6-5:

- Change C501 to HP P/N 0160-0710.
- Change C200 to fxd film .01 uF, 200 V, HP P/N 0160-0161.
- Change the listing for Q702, 800, 850, 852, 853 to 2N2907A, Sprague 56289, HP P/N 1853-0099.
- Change the part number for C803 to 0180-1986 and its voltage rating to 85 V.
- Add pilot light DS1 HP P/N 1450-0566.
- Change SCR CR502 and CR504 from HP P/N 1884-0019 to P/N 1884-0347.

On page 6-7:

- Add R865, var ww 250 ohm, HP P/N 2100-0439.
- Also add Spacer-round, HP P/N 0380-1551 and Internal-external lockwasher, HP P/N 2190-0576.
- Delete the two types of binding posts list and add the following:
 - black binding post, HP P/N 1510-0114, qty. 2
 - red binding post, HP P/N 1510-0115.
- Add: Insulator (CR502, 504), HP P/N 5020-5595.
- For all instruments delivered on or after July 1, 1978, change the HP P/N for fuseholder from 1400-0084 to fuseholder body 2110-0564 and fuseholder carrier 2110-0565.

On page 6-7:

Change the HP P/N for fuseholder nut from 2950-0038 to 2110-0569. If old fuseholder must be replaced for any reason, replace complete fuseholder and nut with new fuseholder parts. Do not replace new parts with old parts.

On page 6-8, note that effective January 1, 1977, Options 007 (10-turn voltage control) and 008 (10-turn current control) are no longer available individually, but are still available combined as Option 009. Likewise Options 013 (10-turn voltage control with decadal) are no longer available individually, but are available combined into a single new option designated Option 015. Make these changes wherever Option 007, 008, 013, or 014 is mentioned in the manual.

ERRATA

On the schematic diagram, indicate that the nominal value for R313 is 1 k. The exact value for R313 is factory selected to optimize the range of transient adjust pot R307.

In Appendix A, change Figure A-1 Overvoltage Protection Crowbar to appear as shown below:

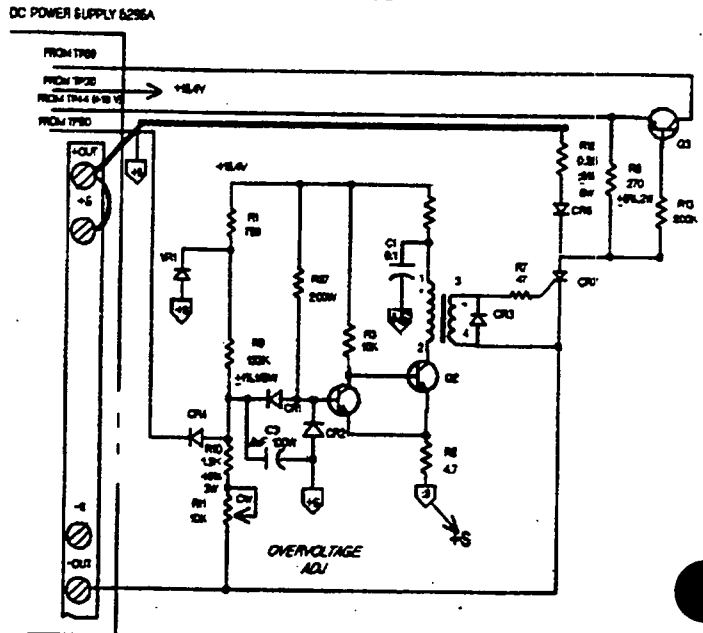

CHANGE 1

On page 6-5, change C500 from 10,000 uF to 2,000 uF, HP P/N 0180-1929.

CHANGE 2

On the component location drawing (schematic apron) make the following changes:

- a. Interchange collector (C) and emitter (E) designations for transistor Q853 on the lower right hand side of drawing.
- b. Remove TP21 designation from R205 on center left hand side of drawing. The TP21 designation at the bottom of R310 is unchanged.
- c. TP19 (bottom center) should point to bottom of R300.
- d. Interchange locations of Q401 and CR809 at bottom left of drawing. Electrical connections remain the same.

CHANGE 3

The serial number prefix of the instrument has been changed from 6D to 7D.

In the parts list and on the schematic, make the following changes: Add new resistor R402, 600 ohm, 5 W, HP P/N 0811-1860 across R309 (150 ohm). Change T801 to HP P/N 9100-2184.

On the schematic, the primary of bias transformer T801 should be connected as shown in the following sketch for 115 Vac operation. For 230 Vac operation, the jumpers between lugs 1 and 3, and 2 and 4 must be removed, and lugs 2 and 3 connected together. In addition, a new power transformer, T800, must be installed in accordance with Option 18.

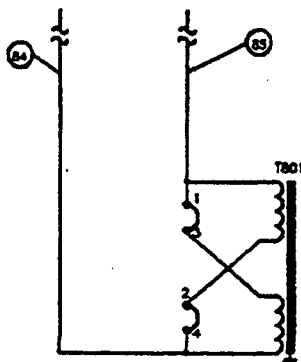

CHANGE 4

Make the following changes in the parts list:

- Add new diode CR603, 1N485B, HP P/N 1901-0033.
- Change R313 to 1 k, 5% (selected) 1/2 W, HP P/N 0686-1025.
- Change R707 to 2 W, I.R.C. Type BWH, HP P/N 0811-1674.
- Change R601 to 422 ohm, 1/4 W, HP P/N 0698-4590.
- Change R870 to 5 k pot, HP P/N 2100-1824.
- Change R871 to 750 ohm, 1%, HP P/N 0757-0420.
- Delete R872.
- Add new Zener diode VR800, 4.22 V, HP P/N 1902-3070.

On the schematic, delete R872 in the meter circuit and connect VR800 in its place. The anode of VR800 goes to base of Q850 and cathode goes to +15.4 V reference. Also, connect CR603 across VR600 in the reference circuit. The anode of CR603 goes to +S and the cathode goes to +9.4 volts.

CHANGE 5

The serial number prefix of the instrument has been changed from 7D to 7M. In the parts list, delete S1 (switch/indicator, ON/OFF) and replace with a separate toggle switch and pilot light as follows:

- S1, toggle switch, Carling, 2FA53-73-SKI, HP P/N 3101-0984.
- DS1, pilot light, Neon, Sloan, HP P/N 1450-0048.

Schematic connections to the new switch and pilot light remain the same except that the two are physically separate.

| DESCRIPTION | HP PART NO. | | |
|-----------------------|-------------|-------------|------------|
| | STANDARD | OPTION A85 | OPTION X95 |
| Front Panel, Lettered | 06296-60004 | 06296-60001 | <----- |
| Heat Sink Assembly | 5060-7968 | <----- | 5060-6131 |
| Rear Chassis | 5000-9485 | <----- | 5000-6103 |
| Cover, Top | 5000-9431 | <----- | 5000-6104 |
| Chassis, Right Side | 5000-9406 | <----- | 5000-6098 |
| Chassis, Left Side | 5000-9407 | <----- | 5000-6099 |

CHANGE 13 (Cont)

CHANGE 6

In the parts list, change R309 to 125 ohm, 40 W, HP P/N 0811-2621.

CHANGE 7

In the parts list, change R826 to 3.9 k, 5%, 1/2 W, HP P/N 0686-3925.

CHANGE 8

In the parts list, change R816 to 56 k, 5%, 1/2 W, AB, HP P/N 0686-5635.

CHANGE 9

In the parts list and on the schematic, change R501 and R502 to 22 ohm, 5%, 1/2 W, HP P/N 0686-2205.

CHANGE 10

In the parts list, delete Cable Clamp, HP P/N 1400-0332, qty. 2, and add Terminal Strip, HP P/N 0360-0417.

CHANGE 11

The serial prefix of the supply has been changed to 1140A. This is the only change.

CHANGE 12

In the replaceable parts list and on the schematic, change R702 to 1.5 k, ww, 3 W, HP P/N 0811-1805, and change R709 to 1.6 k, 5%, 1/2 W HP P/N 0686-1625.

CHANGE 13

The standard colors for this instrument are now mint gray (for front panels and rear panels) and olive gray (for all top, bottom, side, and other external surfaces).

Option X95 designates use of the former color scheme of light gray and blue gray. Option A85 designates use of a light gray front panel with olive gray used for all other external surfaces. New part numbers are shown above.

CHANGE 14

All primary ac connections have been removed from the circuit board and are now made directly to the transformer primaries. R903 has been removed from the PC board and is now on a new terminal strip (0360-1696) mounted on the SCR heatsink assembly. These changes do not affect the circuit schematic.

CHANGE 15

T800 has been replaced by a new transformer with a dual-winding primary for 115/ 230 Vac operation. The new transformer (HP P/N 06296-80091) replaces both T800 transformers previously used in this model for 115 V or 230 V operation.

Since it is no longer necessary to replace T800 to convert the supply from 115 to 230 V operation or vice-versa, Option 018 (which equipped the supply for 230 V operation only) has been replaced by a new option, Option 028. In the replaceable parts list, remove R903 (HP P/N 0686-1245) (qty 1).

Option 028 modifies the standard 115 V unit to a 230 V unit as described below. To convert the supply for 230 V operation:

- Remove the jumpers from between terminals terminals 1 and 3, and 2 and 4 of T800.
- Install a jumper between terminals 2 and 3 of T800.
- Replace F1 with a 3A 250 V fuse (2100-0003).

Note: Due to the circuit changes shown on the next figure, it is no longer necessary to change any jumper connections at T801. The dual primary windings of T801 are permanently wired in parallel across winding 3-4 of T800. The pilot light, in series with R903, is also connected across this winding.

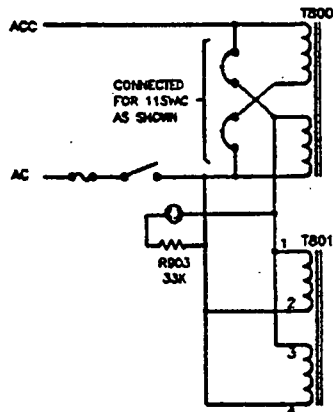

CHANGE 16

In the parts list and on the schematic, change R307 to 10 k, 10%, HP P/N 2100-3210.

CHANGE 17

In the parts list and on the schematic, add capacitor C901, 0.1 uF, 250 V HP P/N 0160-4065 as shown below:

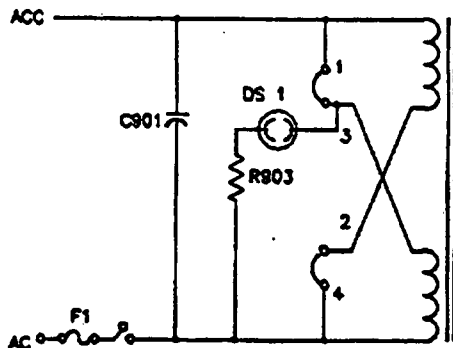

CHANGE 18

In the parts list and on the schematic, add resistor R904, 10 ohm, 5%, 1/2 W, HP P/N 0686-1005 in series with the negative lead of capacitor C801.

CHANGE 19

In the replaceable parts list and on the schematic, indicate that 12 k is the nominal value for R712. The value for R712 is factory selected to optimize the range of ramp adjust pot R711.

CHANGE 19 (Cont)

The procedure for selecting R712 is identical to the one given for 50 Hz operation in paragraph 5-55, steps g through j, except that the resistance value should be selected to provide a 3 V +/- .2 V drop across the series regulator. (For 50 Hz operation, the voltage drop across the series regulator remains 3.5 V) Center R711 before using the resistance box to determine the value for R712.

Also change VR600 to 9 V, HP P/N 1902-0785, change R606 to 9 k, HP P/N 698-5454, and change R611 to 490 ohm, 3 W, HP P/N 0811-1801.

CIRCUIT PATENTS APPLIED
FOR LICENSE TO USE MUST
BE OBTAINED IN WRITING FROM
HEWLETT-PACKARD CO.
HARRISON DIVISION.

NOTES:

1. All resistors are in ohms, 1/2W, +/-5% unless otherwise noted.
2. All capacitors are in microfarads unless otherwise noted.

CHANGE 20

In the parts list and on the schematic for the overvoltage protection crowbar, delete R1 and VR1; add U1 voltage regulator, HP P/N 1826-0276 and C2, fxd elect, 1 uF, 50 V, HP P/N 0180-0230; and change R9 to 1.5 k, HP P/N 0757-0427 and R10 to 1.5 k, 5%, HP P/N 0811-1805 as shown in the schematic below:

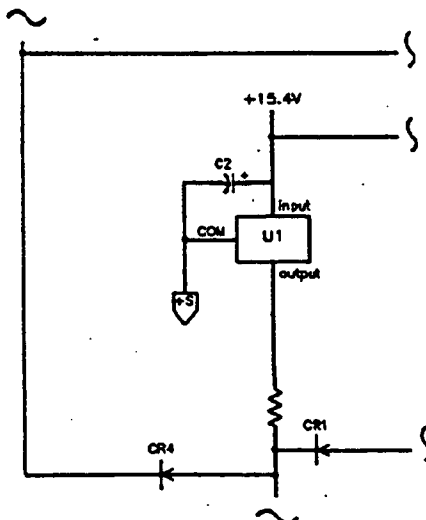

CHANGE 21

In the replaceable parts list, change the HP P/N's for the binding posts and associated hardware to the following: Red binding post, qty. 2, 1510-0091; Terminal lug, qty. 2, 0360-0042; Lockwasher, qty. 2, 2190-0079; Nut, qty 2, 2500-0001; Black binding post, qty 1, 1510-0107; Terminal lug, qty. 1, 0360-1190; Nut, qty. 3, 2950-0144.

CHANGE 22

In the replaceable parts list on page 6-7, change S1 (previously changed in Change 5) to HP P/N 3101-2456. On page 6-5, change Q40 to HP P/N 1854-0458.

CHANGE 23

* This change also applies to units with serial numbers 2114A-4177, 4190, and 4240.

In the replaceable parts list and on the schematic for the overvoltage protection crowbar, make the following changes: Change C2 (added in Change 20) to 2.2 uF, 20 V, HP P/N 0180-0155.

Add C3, fxd cer, 0.01 uF, 10%, 100 V, HP P/N 0160-4832. It is to be mounted between the cathode of CR1 and the anode of CR2.

Change CR4 to a two junction stabistor, HP P/N 1901-0701.

CHANGE 24

In the replaceable parts list on page 6-6, change R605 to 6.8 k, HP P/N 0757-0750.

CHANGE 25

In the replaceable parts list, page 6-7 add the following mechanical assembly; Barrier Strip Guard Assembly HP P/N 5060-2862, qty 1.

CHANGE 26

In the replaceable parts list, page 6-5, change Q400 to HP P/N 1854-1124 QTY 1, and Q303 to HP P/N 1854-1017.

CHANGE 27

In the replaceable parts list, change the part number for the bias transformer from HP P/N 9100-2184 to HP P/N 9100-4751. Note that the primary wiring colors have changed, the white/grey is now black/yellow and the grey is now black. See the figure below.

Figure 28a - Transformer Connections

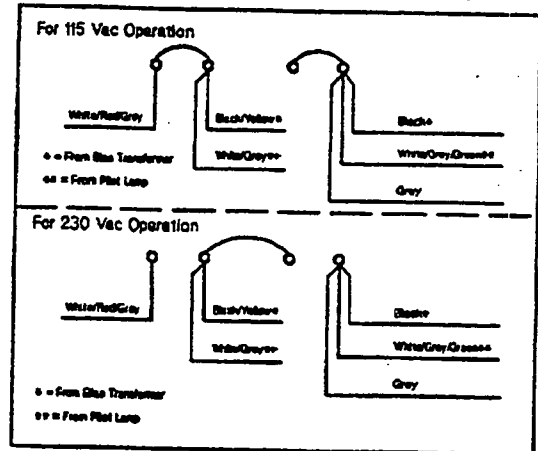

CHANGE 28

In the replaceable parts list, change Q400 from HP P/N 1854-1124 to HP P/N 1854-0458.

CHANGE 29

In the replaceable parts list, change the part number for Q851 from HP P/N 1854-0221 to HP P/N 1854-0229.

CHANGE 30

In the replaceable parts list, change Q400 to HP P/N 06296-80004. Use this part number for replacement on all units.

SAFETY SUMMARY

The following general safety precautions must be observed during all phases of operation, service, and repair of this instrument. Failure to comply with these precautions or with specific warnings elsewhere in this manual violates safety standards of design, manufacture, and intended use of the instrument. Hewlett-Packard Company assumes no liability for the customer's failure to comply with these requirements.

BEFORE APPLYING POWER

Verify that the product is set to match the available line voltage.

GROUND THE INSTRUMENT

This product is a Safety Class 1 instrument (provided with a protective earth terminal). To minimize shock hazard, the instrument chassis and cabinet must be connected to an electrical ground. The instrument must be connected to the ac power supply mains through a three-conductor power cable, with the third wire firmly connected to an electrical ground (safety ground) at the power outlet. Any interruption of the protective (grounding) conductor or disconnection of the protective earth terminal will cause a potential shock hazard that could result in personal injury. If the instrument is to be energized via an external autotransformer for voltage reduction, be certain that the autotransformer common terminal is connected to the neutral (earthed pole) of the ac power lines (supply mains). This instrument is equipped with a line filter to reduce electromagnetic interference (EMI), and must be connected to a properly grounded receptacle to minimize EMI.

FUSES

Fuses are contained inside the unit, and are not user-replaceable. Only trained service personnel should replace blown fuses, and only after identifying and correcting the problem which caused the fuse(s) to blow.

DO NOT OPERATE IN AN EXPLOSIVE ATMOSPHERE

Do not operate the instrument in the presence of flammable gases or fumes.

KEEP AWAY FROM LIVE CIRCUITS

Operating personnel must not remove instrument covers. Component replacement and internal adjustments must be made by qualified service personnel. Do not replace components with the power cable connected. Under certain conditions, dangerous voltages may exist even with the power cable removed. To avoid injuries, always disconnect power, discharge circuits and remove external voltage sources before touching components.

DO NOT SERVICE OR ADJUST ALONE

Do not attempt internal service or adjustment unless another person, capable of rendering first aid and resuscitation, is present.

DO NOT EXCEED INPUT RATINGS

Operation at line voltages or frequencies in excess of those stated on the data plate may cause leakage currents in excess of 3.5 mA peak.

SAFETY SYMBOLS



Instruction manual symbol: the product will be marked with this symbol when it is necessary for the user to refer to the instruction manual (refer to Table of Contents).



Indicates hazardous voltages.



or



Indicate earth (ground) terminal.

WARNING

or

Warning



The **WARNING** sign denotes a hazard. It calls attention to a procedure, practice, or the like, which, if not correctly performed or adhered to, could result in personal injury. Do not proceed beyond a **WARNING** sign until the indicated conditions are fully understood and met.

CAUTION

or

Caution



The **CAUTION** sign denotes a hazard. It calls attention to an operating procedure, or the like, which, if not correctly performed or adhered to, could result in damage to or destruction of part or all of the product. Do not proceed beyond a **CAUTION** sign until the indicated conditions are fully understood and met.

DO NOT CIRCUMVENT SAFETY DEVICES

AC mains power exists on exposed terminals in various locations in the mainframe and on the load modules. To protect the user against the danger of electric shock, the unit is equipped with a safety interlock that removes ac mains power when the top cover is removed. Do not attempt to defeat the function of the safety interlock.

DO NOT SUBSTITUTE PARTS OR MODIFY INSTRUMENT

Because of the danger of introducing additional hazards, do not install substitute parts or perform any unauthorized modification to the instrument. Return the instrument to a Hewlett-Packard Sales and Service Office for service and repair to ensure that safety features are maintained.

Instruments which appear damaged or defective should be made inoperative and secured against unintended operation until they can be repaired by qualified service personnel.

TABLE OF CONTENTS

| Section | Page No. | Section | Page No. |
|---------------------------------------|----------|---------------------------------------|----------|
| I GENERAL INFORMATION | 1-1 | IV PRINCIPLES OF OPERATION | |
| 1-1 Description | 1-1 | 4-8 Simplified Schematic | 4-3 |
| 1-6 Specifications | 1-1 | 4-10 Detailed Circuit Analysis | 4-3 |
| 1-8 Options | 1-1 | 4-11 Preregulator and Control Circuit | 4-3 |
| 1-10 Accessories | 1-2 | 4-19 Series Regulator | 4-5 |
| 1-12 Instrument Identification | 1-2 | 4-21 Constant Voltage Input Circuit | 4-5 |
| 1-15 Ordering Additional Manuals | 1-2 | 4-26 Constant Current Input Circuit | 4-6 |
| | | 4-31 Gating Circuit | 4-7 |
| II INSTALLATION | 2-1 | 4-34 Error Amplifiers | 4-7 |
| 2-1 Initial Inspection | 2-1 | 4-37 Fault Input Circuit | 4-7 |
| 2-3 Mechanical Check | 2-1 | 4-42 Reference Circuit | 4-8 |
| 2-5 Electrical Check | 2-1 | 4-46 Meter Circuit | 4-8 |
| 2-7 Installation Data | 2-1 | | |
| 2-9 Location | 2-1 | V MAINTENANCE | 5-1 |
| 2-11 Rack Mounting | 2-1 | 5-1 Introduction | 5-1 |
| 2-15 Input Power Requirements | 2-2 | 5-3 General Measurement | |
| 2-17 50Hz Operation | 2-2 | Techniques | 5-1 |
| 2-19 Power Cable | 2-2 | 5-8 Test Equipment Required | 5-1 |
| 2-22 Repackaging for Shipment | 2-2 | 5-10 Performance Test | 5-3 |
| | | 5-12 Constant Voltage Tests | 5-4 |
| III OPERATING INSTRUCTIONS | 3-1 | 5-21 Constant Current Tests | 5-6 |
| 3-1 Operating Controls and | | 5-25 Troubleshooting | 5-6 |
| Indicators | 3-1 | 5-27 Trouble Analysis | 5-7 |
| 3-3 Operating Modes | 3-1 | 5-34 Repair and Replacement | 5-7 |
| 3-5 Normal Operating Mode | 3-1 | 5-36 Adjustment and Calibration | 5-13 |
| 3-7 Constant Voltage | 3-1 | 5-38 Meter Zero | 5-13 |
| 3-9 Constant Current | 3-1 | 5-40 Voltmeter Tracking | 5-13 |
| 3-11 Connecting Load | 3-2 | 5-42 Ammeter Tracking | 5-13 |
| 3-14 Operation of Supply Beyond | | 5-44 Constant Voltage Programming | |
| Rated Output | 3-2 | Current | 5-14 |
| 3-16 Optional Operating Modes | 3-2 | 5-46 Constant Current Programming | |
| 3-17 Remote Programming, Constant | | Current | 5-14 |
| Voltage | 3-2 | 5-48 Overvoltage Trip | 5-14 |
| 3-24 Remote Programming, Constant | | 5-50 Transient Recovery Time | 5-14 |
| Current | 3-3 | 5-52 Preregulator Tracking (60 Hz | |
| 3-30 Remote Sensing | 3-3 | Operation) | 5-14 |
| 3-35 Series Operation | 3-4 | 5-54 Preregulator Tracking (50 Hz | |
| 3-39 Parallel Operation | 3-5 | Operation) | 5-14 |
| 3-42 Auto-Tracking Operation | 3-5 | | |
| 3-45 Special Operating Considerations | 3-6 | VI REPLACEABLE PARTS | 6-1 |
| 3-46 Pulse Loading | 3-6 | 6-1 Introduction | 6-1 |
| 3-48 Output Capacitance | 3-6 | 6-4 Ordering Information | 6-1 |
| 3-51 Reverse Voltage Loading | 3-6 | Reference Designators | |
| 3-53 Reverse Current Loading | 3-6 | Abbreviations | |
| | | Manufacturers | |
| IV PRINCIPLES OF OPERATION | 4-1 | 6-8 Code List of Manufacturers | 6-2 |
| 4-1 Overall Block Diagram | | Parts List Table | |
| Discussion | 4-1 | | |

SECTION I
GENERAL INFORMATION

1-1 DESCRIPTION

1-2 This power supply is completely transistorized and suitable for either bench or relay rack operation. It is a compact, well-regulated, Constant Voltage / Constant Current supply that will furnish full rated output voltage at the maximum rated output current or can be continuously adjusted throughout the output range. The front panel CURRENT controls can be used to establish the output current limit (overload or short circuit) when the supply is used as a constant voltage source and the VOLTAGE control can be used to establish the voltage limit (ceiling) when the supply is used as a constant current source. The supply will automatically crossover from constant voltage to constant current operation and vice versa if the output current or voltage exceeds these preset limits.

1-3 The power supply has both front and rear terminals. Either the positive or negative output terminal may be grounded or the power supply can be operated floating at up to a maximum of 300 volts off ground.

1-4 A single meter is used to measure either output voltage or output current in one of two ranges. The voltage or current ranges are selected by a METER switch on the front panel.

1-5 Barrier strip terminals located at the rear of the unit allow ease in adapting to the many operational capabilities of the power supply. A brief description of these capabilities is given below:

a. Remote Programming

The power supply may be programmed from a remote location by means of an external voltage source or resistance.

b. Remote Sensing

The degradation in regulation which would occur at the load because of the voltage drop in the load leads can be reduced by using the power supply in the remote sensing mode of operation.

c. Series and Auto-Series Operation

Power supplies may be used in series when a higher output voltage is required in the voltage mode of operation or when greater voltage compliance is required in the constant current mode of operation. Auto-Series operation permits one knob control of the total output voltage from a "master" supply.

d. Parallel and Auto-Parallel Operation

The power supply may be operated in parallel with a similar unit when greater output current capability is required. Auto-Parallel operation permits one knob control of the total output current from a "master" supply.

e. Auto-Tracking

The power supply may be used as a "master" supply, having control over one (or more) "slave" supplies that furnish various voltages for a system.

1-6 SPECIFICATIONS

1-7 Detailed specifications for the power supply are given in Table 1-1.

1-8 OPTIONS

1-9 Options are factory modifications of a standard instrument that are requested by the customer. The following options are available for the instrument covered by this manual. Where necessary, detailed coverage of the options is included throughout the manual.

Option No.

Description

05

50 Hz Regulator Realignment: Standard instruments will operate satisfactorily at both 60 and 50 Hz without adjustment. However Option 05 factory realignment results in more efficient operation at 50 Hz, and is recommended for all applications when continuous operation from a 50 Hz ac input is intended.

| <u>Option No.</u> | <u>Description</u> |
|-------------------|--|
| 07 | Voltage 10-Turn Control: A single control that replaces both coarse and fine voltage controls and improves output settability. |
| 08 | Current 10-Turn Control: A single control that replaces both coarse and fine current controls and improves output settability. |
| 09 | Voltage and Current 10-Turn Controls: Options 07 and 08 on same instrument. |
| 11 | Internal Overvoltage Protection "Crowbar". Operating and Service information is included in Appendix A at the rear of the manual. |
| 13 | Three Digit Graduated Decadal Voltage Control: Control that replaces 10-turn voltage control permitting accurate resettability. |
| 14 | Three Digit Graduated Decadal Current Control: Control that replaces coarse and fine current controls permitting accurate resettability. |
| 18 | 230V AC, Single Phase, Input: Supply is shipped for 115V ac operation. Option 18 consists of modifying the supply for 230Vac operation. |

1-10 ACCESSORIES

1-11 The accessories listed in the following chart may be ordered with the power supply or separately from your local Hewlett-Packard field sales office (refer to list at rear of manual for ad-

resses).

| <u>Part No.</u> | <u>Description</u> |
|-----------------|---|
| 14515A | Rack Kit for mounting one 5¼" high supply. (Refer to Section II for details.) |
| 14525A | Rack Kit for mounting two 5¼" high supplies. (Refer to Section II for details.) |

1-12 INSTRUMENT IDENTIFICATION

1-13 Hewlett-Packard power supplies are identified by a three-part serial number tag. The first part is the power supply model number. The second part is the serial number prefix, which consists of a number-letter combination that denotes the date of a significant design change. The number designates the year, and the letter A through M designates the month, January through December respectively. The third part is the power supply serial number.

1-14 If the serial number prefix on your power supply does not agree with the prefix on the title page of this manual, change sheets are included to update the manual. Where applicable, back-dating information is given in an appendix at the rear of the manual.

1-15 ORDERING ADDITIONAL MANUALS

1-16 One manual is shipped with each power supply. Additional manuals may be purchased from your local Hewlett-Packard field office (see list at rear of this manual for addresses). Specify the model number, serial number prefix, and stock number provided on the title page.

Table 1-1. Specifications

INPUT:

105-125 VAC, single phase, 50-60Hz,
4.5A, 250W.

OUTPUT:

0-60 volts @ 0-3 amps.

LOAD REGULATION:

Constant Voltage -- Less than 0.01% plus 1mV for a full load to no load change in output current.

Constant Current -- Less than 0.05% plus 1mA for a zero to maximum change in output voltage.

LINE REGULATION:

Constant Voltage -- Less than 0.01% plus 1mV for any line voltage change within the input rating.

Constant Current -- Less than 0.05% plus 1mA for any line voltage change within the input rating.

RIPPLE AND NOISE:

Constant Voltage -- Less than 500 μ V rms.

Constant Current -- Less than 3mA rms.

OPERATING TEMPERATURE RANGES:

Operating: 0 to 50°C. Storage: -20 to +85°C.

TEMPERATURE COEFFICIENT:

Constant Voltage -- Less than 0.02% plus 500 μ V per degree Centigrade.

Constant Current -- Less than 0.02% plus 1.5mA per degree Centigrade.

STABILITY:

Constant Voltage -- Less than 0.10% plus 2.5mV total drift for 8 hours after an initial warm-up time of 30 minutes at constant ambient, constant line voltage, and constant load.

Constant Current -- Less than 0.10% plus 7.5mA total drift for 8 hours after an initial warm-up time of 30 minutes at constant ambient, constant line voltage, and constant load.

INTERNAL IMPEDANCE AS A CONSTANT VOLTAGE SOURCE:

Less than 0.001 ohm from DC to 100Hz.

Less than 0.01 ohm from 100Hz to 1kHz.

Less than 0.2 ohm from 1kHz to 100kHz.

Less than 2.0 ohms from 100 kHz to 1 MHz.

TRANSIENT RECOVERY TIME:

Less than 50 μ sec for output recovery to within 15 mv following a current change in the output equal to the current rating of the supply or 5 amperes, whichever is smaller.

OVERLOAD PROTECTION:

A continuously acting constant current circuit protects the power supply for all overloads

including a direct short placed across the terminals in constant voltage operation. The constant voltage circuit limits the output voltage in the constant current mode of operation.

METER:

The front panel meter can be used as either a 0-70 or 0-7 volt voltmeter or as a 0-4 or 0-0.4 amp ammeter.

OUTPUT CONTROLS:

Coarse and fine voltage controls and coarse and fine current controls provide continuous adjustment over the entire output span.

OUTPUT TERMINALS:

Three "five-way" output posts are provided on the front panel and an output terminal strip is located on the rear of the chassis. All power supply output terminals are isolated from the chassis and either the positive or negative terminal may be connected to the chassis through a separate ground terminal. If the front panel terminals are used, the load regulation will be 0.5mV per ampere greater, due to the front terminal resistance.

ERROR SENSING:

Error sensing is normally accomplished at the front terminals if the load is attached to the front or at the rear terminals if the load is attached to the rear terminals. Also, provision is included on the rear terminal strip for remote sensing.

REMOTE PROGRAMMING:

Remote programming of the supply output at approximately 300 ohms per volt in constant voltage is made available at the rear terminals. In constant current mode of operation, the current can be remotely programmed at approximately 500 ohms per ampere.

COOLING:

Convection cooling is employed. The supply has no moving parts.

SIZE:

5 $\frac{1}{4}$ " H x 16" D x 8 $\frac{1}{2}$ " W. Two of the units can be mounted side by side in a standard 19" relay rack.

WEIGHT:

29 lbs. net. 38 lbs. shipping.

FINISH:

Light gray front panel with dark gray case.

POWER CORD:

A three-wire, five-foot power cord is provided with each unit.

SECTION II INSTALLATION

2-1 INITIAL INSPECTION

2-2 Before shipment, this instrument was inspected and found to be free of mechanical and electrical defects. As soon as the instrument is unpacked, inspect for any damage that may have occurred in transit. Save all packing materials until the inspection is completed. If damage is found, proceed as described in the Claim for Damage in Shipment section of the warranty page at the rear of this manual.

2-3 MECHANICAL CHECK

2-4 This check should confirm that there are no broken knobs or connectors, that the cabinet and panel surfaces are free of dents and scratches, and that the meter is not scratched or cracked.

2-5 ELECTRICAL CHECK

2-6 The instrument should be checked against its electrical specifications. Section V includes an "in-cabinet" performance check to verify proper instrument operation.

2-7 INSTALLATION DATA

2-8 The instrument is shipped ready for bench operation. It is necessary only to connect the in-

strument to a source of power and it is ready for operation.

2-9 LOCATION

2-10 This instrument is air cooled. Sufficient space should be allotted so that a free flow of cooling air can reach the sides and rear of the instrument when it is in operation. It should be used in an area where the ambient temperature does not exceed 50°C.

2-11 RACK MOUNTING

2-12 This instrument may be rack mounted in a standard 19 inch rack panel either alongside a similar unit or by itself. Figures 2-1 and 2-2 show how both types of installations are accomplished.

2-13 To mount two units side-by-side, proceed as follows:

- Remove the four screws from the front panels of both units.
- Slide rack mounting ears between the front panel and case of each unit.
- Slide combining strip between the front panels and cases of the two units.
- After fastening rear portions of units together using the bolt, nut, and spacer, replace panel screws.

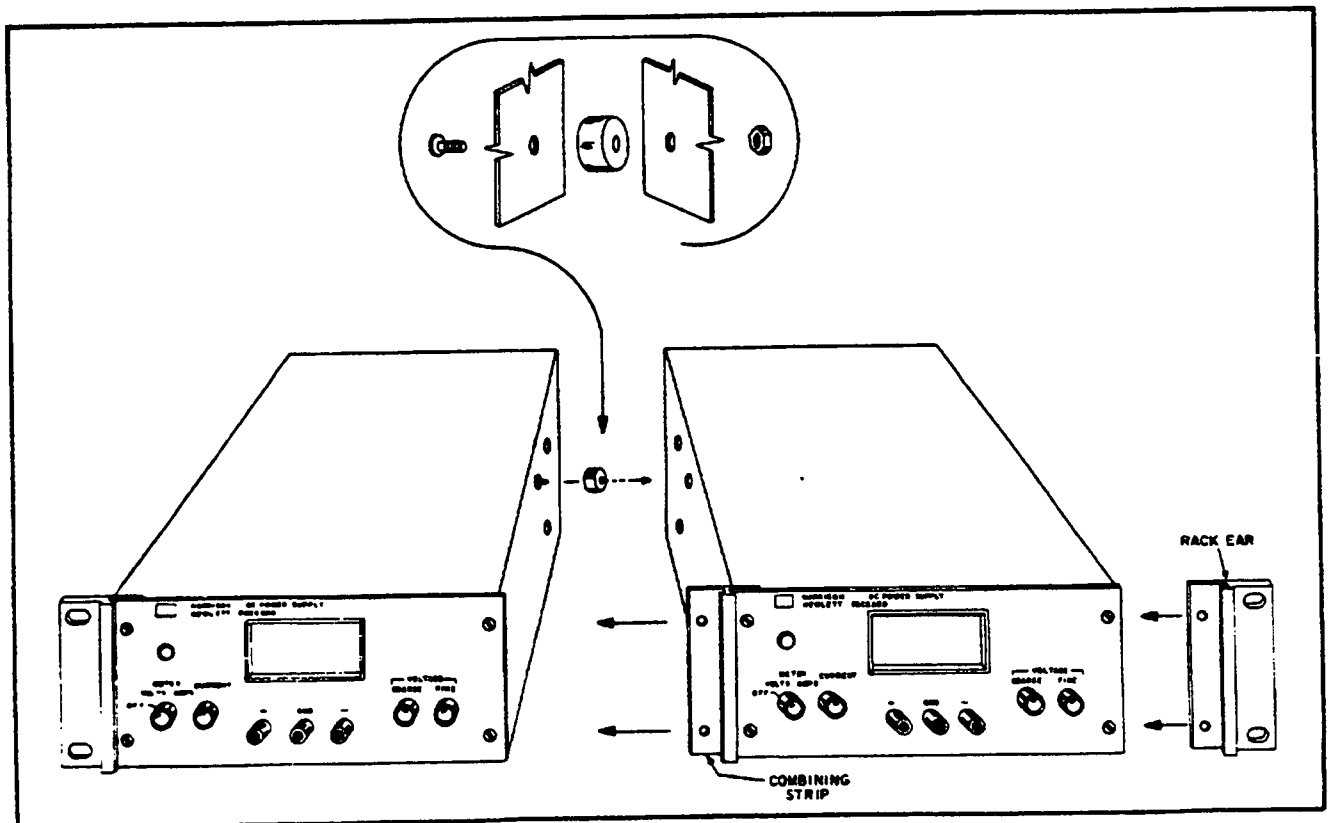

Figure 2-1. Rack Mounting, Two Units

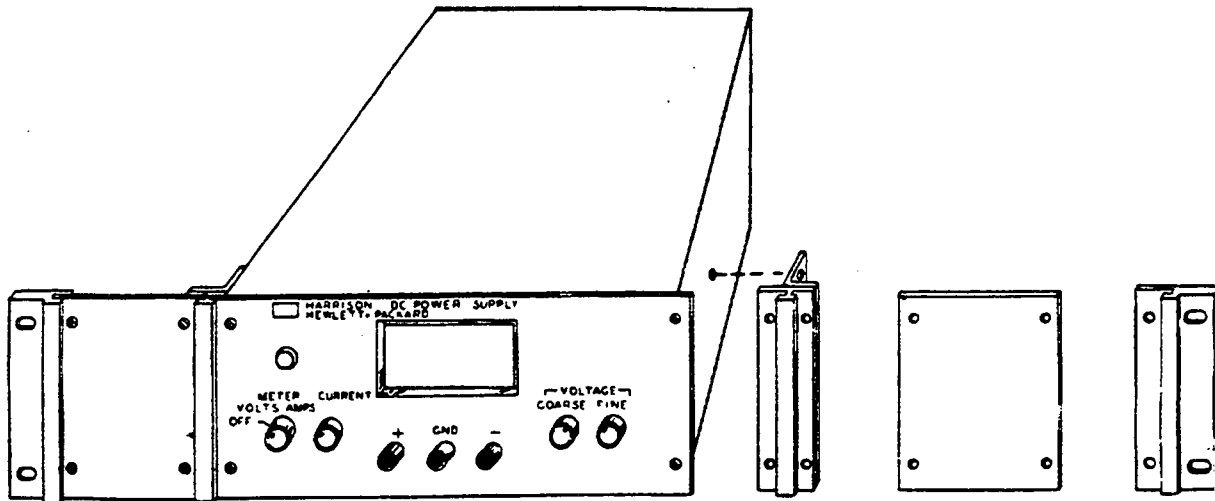

Figure 2-2. Rack Mounting, One Unit

2-14 To mount a single unit in the rack panel, proceed as follows:

- a. Bolt rack mounting ears, combining straps, and angle brackets to each side of center spacing panels. Angle brackets are placed behind combining straps as shown in Figure 2-2.
- b. Remove four screws from front panel of unit.
- c. Slide combining strips between front panel and case of unit.
- d. Bolt angle brackets to front sides of case and replace front panel screws.

2-15 INPUT POWER REQUIREMENTS

2-16 This power supply may be operated from either a nominal 115 volt or 230 volt 50-60 cycle power source. The unit, as shipped from the factory, is wired for 115 volt operation only. A factory modification (Option 18) must be made to permit operation from a 230 volt line. The input power required when operated from a 115 volt, 60 cycle power source at full load is given in the specification table in Section I.

2-17 50 Hz OPERATION

2-18 The unit as normally shipped from the factory can be operated from either a 50 or 60 Hz source. However, with a 50 Hz input, the operation of the unit may become somewhat degraded when the temperature exceeds 35° Centigrade (instead of the normal 50° Centigrade capability with a 60 Hz input). To permit optimum operation at 50 Hz, the unit must

be realigned. This realignment procedure is described in Paragraph 5-54 at the rear of the manual.

2-19 POWER CABLE

2-20 To protect operating personnel, the National Electrical Manufacturers' Association (NEMA) recommends that the instrument panel and cabinet be grounded. This instrument is equipped with a three conductor power cable. The third conductor is the ground conductor and when the cable is plugged into an appropriate receptacle, the instrument is grounded. The offset pin on the power cable three-prong connector is the ground connection.

2-21 To preserve the protection feature when operating the instrument from a two-contact outlet, use a three-prong to two-prong adapter and connect the green lead on the adapter to ground.

2-22 REPACKAGING FOR SHIPMENT

2-23 To insure safe shipment of the instrument, it is recommended that the package designed for the instrument be used. The original packaging material is reusable. If it is not available, contact your local Hewlett-Packard field office to obtain the materials. This office will also furnish the address of the nearest service office to which the instrument can be shipped. Be sure to attach a tag to the instrument which specifies the owner, model number, full serial number, and service required, or a brief description of the trouble.

SECTION III OPERATING INSTRUCTIONS

3-1 OPERATING CONTROLS AND INDICATORS

3-2 The front panel controls and indicators, together with the normal turn-on sequence, are shown in Figure 3-1.

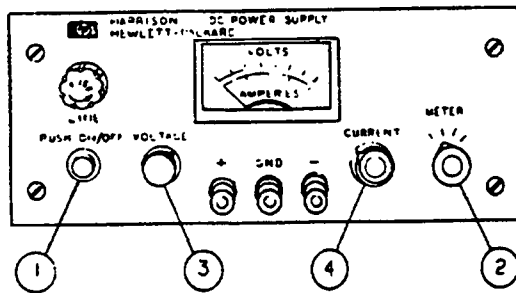

TURN-ON SEQUENCE

1. PUSH ON/OFF BUTTON AND BUTTON SHOULD LIGHT.
2. SET METER SWITCH TO DESIRED VOLTAGE RANGE.
3. ADJUST COARSE AND FINE VOLTAGE CONTROLS UNTIL DESIRED OUTPUT VOLTAGE IS INDICATED ON METER.
4. SET METER SWITCH DESIRED CURRENT RANGE AND SHORT CIRCUIT OUTPUT TERMINALS.
5. ADJUST CURRENT CONTROLS FOR DESIRED OUTPUT CURRENT.
6. REMOVE SHORT AND CONNECT LOAD TO OUTPUT TERMINALS (FRONT OR REAR).

Figure 3-1. Front Panel Controls and Indicators

3-3 OPERATING MODES

3-4 The power supply is designed so that its mode of operation can be selected by making strapping connections between particular terminals on the terminal strip at the rear of the power supply. The terminal designations are stenciled in white on the power supply above their respective terminals. Although the strapping patterns illustrated in this section show the positive terminal grounded, the operator can ground either terminal or operate the power supply up to 300 vdc off ground (floating). The following paragraphs describe the procedures for utilizing the various operational capabilities of the power supply. A more theoretical description concerning the operational features of this supply is contained in a power supply Application Manual and in various Tech. Letters published by the Harrison Division. Copies of these can be obtained from your local Hewlett-Packard field office.

3-5 NORMAL OPERATING MODE

3-6 The power supply is normally shipped with its rear terminal strapping connections arranged for Constant Voltage/Constant Current, local sensing, local programming, single unit mode of operation. This strapping pattern is illustrated in Figure 3-2. The operator selects either a constant voltage or a constant current output using the front panel controls (local programming, no strapping changes are necessary).

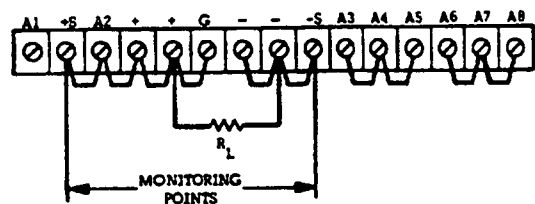

Figure 3-2. Normal Strapping Pattern

3-7 CONSTANT VOLTAGE

3-8 To select a constant voltage output, proceed as follows:

a. Turn-on power supply and adjust VOLTAGE controls for desired output voltage (output terminals open).

b. Short output terminals and adjust CURRENT controls for maximum output current allowable (current limit), as determined by load conditions. If a load change causes the current limit to be exceeded, the power supply will automatically crossover to constant current output at the preset current limit and the output voltage will drop proportionately. In setting the current limit, allowance must be made for high peak current which can cause unwanted cross-over. (Refer to Paragraph 3-46).

3-9 CONSTANT CURRENT

3-10 To select a constant current output, proceed as follows:

a. Short output terminals and adjust CURRENT controls for desired output current.

b. Open output terminals and adjust VOLTAGE controls for maximum output voltage allowable (voltage limit), as determined by load conditions. If a load change causes the voltage limit to be exceeded, the power supply will automatically crossover to constant voltage output at the preset voltage limit and the output current will drop proportionately. In setting the voltage limit, allowance must be made for high peak voltages which can cause unwanted crossover. (Refer to Paragraph 3-46).

NOTE

When Model 6291A is operated continuously in the crossover region, between Constant Voltage/Constant Current, the feedback loop may break into oscillation; particularly in the 0.5A to 1.5A output current range. Although the crossover region is not usually an area of continuous operation, this problem can be eliminated, if necessary, by connecting the emitter of Q300 to +S (instead of to the emitter of Q301) and readjusting R307. Note that when this is done, the transient recovery time of Model 6291A must be derated to "50 μ sec for recovery to within 25mV" (instead of 15mV).

3-11 CONNECTING LOAD

3-12 Each load should be connected to the power supply output terminals using separate pairs of connecting wires. This will minimize mutual coupling effects between loads and will retain full advantage of the low output impedance of the power supply. Each pair of connecting wires should be as short as possible and twisted or shielded to reduce noise pickup. (If shield is used, connect one end to power supply ground terminal and leave the other end unconnected.)

3-13 If load considerations require that the output power distribution terminals be remotely located from the power supply, then the power supply output terminals should be connected to the remote distribution terminals via a pair of twisted or shielded wires and each load separately connected to the remote distribution terminals. For this case, remote sensing should be used (Paragraph 3-30).

3-14 OPERATION OF SUPPLY BEYOND RATED OUTPUT

3-15 The shaded area on the front panel meter face indicates the amount of output voltage or current that is available in excess of the normal output. Although the supply can be operated in this shaded region without being damaged, it cannot be guaranteed to meet all of its performance specifications. However, if the line voltage is maintained above 115 Vac, the supply will probably operate within its specifications.

3-16 OPTIONAL OPERATING MODES

3-17 REMOTE PROGRAMMING, CONSTANT VOLTAGE

3-18 The constant voltage output of the power supply can be programmed (controlled) from a remote location if required. Either a resistance or voltage source can be used for the programming device. The wires connecting the programming terminals of the supply to the remote programming device should be twisted or shielded to reduce noise pick-up. The VOLTAGE controls on the front panel are disabled according to the following procedures.

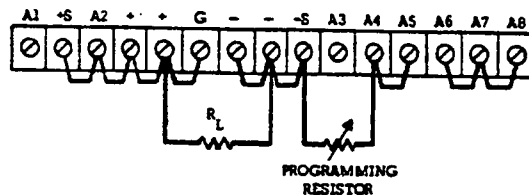

Figure 3-3. Remote Resistance Programming (Constant Voltage)

3-19 Resistance Programming (Figure 3-3). In this mode, the output voltage will vary at a rate determined by the programming coefficient, 200 ohms per volt (300 ohms per volt for Model 6296A). The output voltage will increase 1 volt for each 200 ohms (or 300 ohms) added in series with the programming terminals. The programming coefficient is determined by the programming current. This current is factory adjusted to within 2% of 5 ma (2% of 3.3 ma for Model 6296A). If greater programming accuracy is required, it may be achieved by changing resistor R806.

3-20 The output voltage of the power supply should be zero volts \pm 20 millivolts when zero ohms is connected across the programming terminals.

3-21 To maintain the stability and temperature coefficient of the power supply, use programming resistors that have stable, low noise, and low temperature (less than 30 ppm per degree Centigrade) characteristics. A switch can be used in conjunction with various resistance values in order to obtain discrete output voltages. The switch should have make-before-break contacts to avoid momentarily opening the programming terminals during the switching interval.

3-22 Voltage Programming (Figure 3-4). Employ the strapping pattern shown on Figure 3-4 for voltage programming. In this mode, the output voltage will vary in a 1 to 1 ratio with the pro-

programming voltage (reference voltage) and the load on the programming voltage source will not exceed 25 microamperes.

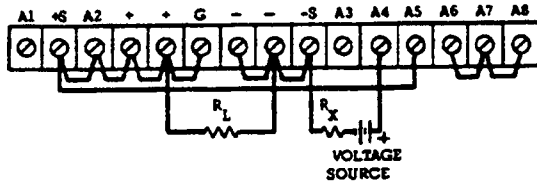

Figure 3-4. Remote Voltage Programming (Constant Voltage)

3-23 The impedance matching resistors (R_X) for the programming voltage source should be approximately 1000 ohms to maintain the temperature and stability specifications of the power supply.

3-24 REMOTE PROGRAMMING, CONSTANT CURRENT

3-25 Either a resistance or a voltage source can be used to control the constant current output of the supply. The CURRENT controls on the front panel are disabled according to the following procedures.

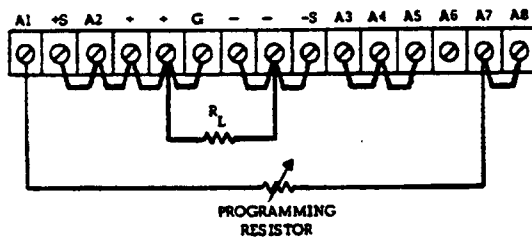

Figure 3-5. Remote Resistance Programming (Constant Current)

3-26 Resistance Programming (Figure 3-5). In this mode, the output current varies at a rate determined by the programming coefficient -- 100 ohms per ampere for Models 6282A and 6286A, 200 ohms per ampere for Models 6285A and 6291A, and 500 ohms per ampere for Models 6290A and 6296A. The programming coefficient is determined by the Constant Current programming current 1 mA for Models 6282A, 6285A, 6286A, and 6291A or 0.66 mA for Models 6290A and 6296A. This current is adjusted to within 10% at the factory. If greater programming accuracy is required, it may be achieved by changing resistor R808 as outlined in Section V.

3-27 Use stable, low noise, low temperature coefficient (less than 30 ppm/ $^{\circ}$ C) programming resistors to maintain the power supply temperature

coefficient and stability specifications. A switch may be used to set discrete values of output current. A make-before-break type of switch should be used since the output current will exceed the maximum rating of the power supply if the switch contacts open during the switching interval.

CAUTION

If the programming terminals (A1 and A7) should open at any time during this mode, the output current will rise to a value that may damage the power supply and/or the load. To avoid this possibility, connect a 1K resistor (1.5K for Models 6290A and 6296A) across the programming terminals. Like the programming resistor, this resistor should be of the low noise, low temperature coefficient type.

3-28 Voltage Programming (Figure 3-6). In this mode, the output current will vary linearly with changes in the programming voltage. The programming voltage should not exceed 1.5 volts. Voltage in excess of 1.5 volts will result in excessive power dissipation in the instrument and possible damage.

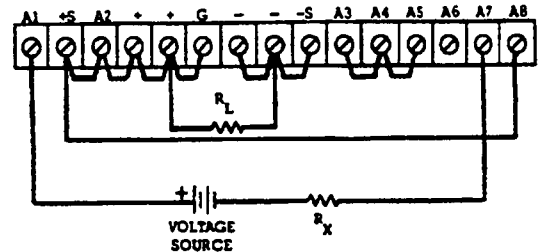

Figure 3-6. Remote Voltage Programming (Constant Current)

3-29 The output current will be the programming voltage divided by the internal current sampling resistance R800. The current required from the voltage source will be less than 10 microamperes. The impedance matching resistor (R_X) should be approximately 1000 ohms if the temperature coefficient and stability specifications of the power supply are to be maintained.

3-30 REMOTE SENSING (See Figure 3-7)

3-31 Remote sensing is used to maintain good regulation at the load and reduce the degradation of regulation which would occur due to the voltage drop in the leads between the power supply and the load. Remote sensing is accomplished by utilizing the strapping pattern shown in Figure 3-7. The power supply should be turned off before changing strapping patterns. It is not required

that these leads be as heavy as the load leads. However, they must be twisted or shielded to minimize noise pick-up.

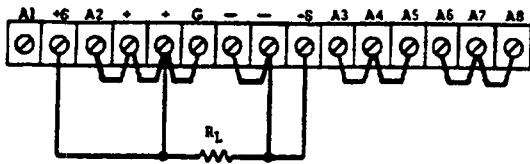

Figure 3-7. Remote Sensing

CAUTION

Observe polarity when connecting the sensing leads to the load.

3-32 Note that it is desirable to minimize the drop in the load leads and it is recommended that the drop not exceed 1 volt per lead if the power supply is to meet its DC specifications. If a larger drop must be tolerated, please consult a Hewlett-Packard field representative.

NOTE

Due to the voltage drop in the load leads, it may be necessary to re-adjust the current limit in the remote sensing mode.

3-33 The procedure just described will result in a low DC output impedance at the load. If a low AC impedance is required, it is recommended that the following precautions be taken:

- a. Disconnect output capacitor C803 by disconnecting the strap between A2 and +S.
- b. Connect a capacitor having similar characteristics (approximately same capacitance, same voltage rating or greater, and having good high frequency characteristics) across the load using short leads.

3-34 Although the strapping patterns shown in Figures 3-3 through 3-6 employ local sensing, note that it is possible to operate a power supply simultaneously in the remote sensing and Constant Voltage/Constant Current remote programming modes.

3-35 SERIES OPERATION

3-36 Normal Series Connections (Figure 3-8).

Two or more power supplies can be operated in series to obtain a higher voltage than that available from a single supply. When this connection

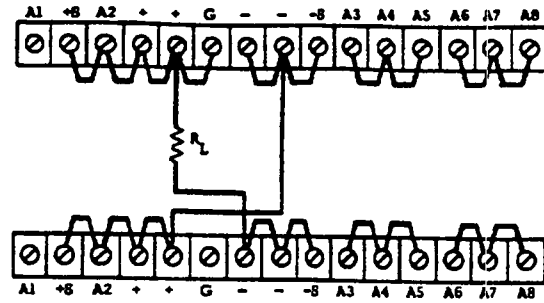

Figure 3-8. Normal Series Connections

is used, the output voltage is the sum of the voltages of the individual supplies. Each of the individual supplies must be adjusted in order to obtain the total output voltage. The power supply contains a protective diode connected internally across the output which protects the supply if one power supply is turned off while its series partner(s) is on.

3-37 Auto-Series Connections (Figure 3-9). The Auto-Series configuration is used when it is desirable to have the output voltage of each of the series connected supplies vary in accordance with the setting of a control unit. The control unit is called the master; the controlled units are called slaves. At maximum output voltage, the voltage of the slaves is determined by the setting of the front panel VOLTAGE control on the master. The master supply must be the most positive supply in the series. The output CURRENT controls of all series units are operative and the current limit is equal to the lowest control setting. If any output CURRENT controls are set too low, automatic crossover to constant current operation will occur and the output voltage will drop. Remote sensing and programming can be used; however, the strapping arrangements shown in the applicable figures show local sensing and programming.

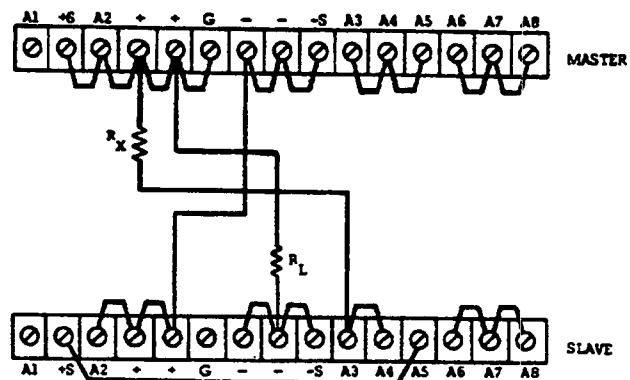

Figure 3-9. Auto-Series, Two Units

3-38 In order to maintain the temperature coefficient and stability specifications of the power supply, the external resistor (R_x) shown in Figure 3-9 should be stable, low noise, low temperature coefficient (less than 30 ppm per degree Centigrade) resistors. The value of this resistor is dependant on the maximum voltage rating of the "master" supply. The value of R_x is this voltage divided by the voltage programming current of the slave supply ($1/K_p$ where K_p is the voltage programming coefficient). The voltage contribution of the slave is determined by its voltage control setting.

3-39 PARALLEL OPERATION

3-40 Normal Parallel Connections (Figure 3-10). Two or more power supplies can be connected in parallel to obtain a total output current greater than that available from one power supply. The total output current is the sum of the output currents of the individual power supplies. The output CURRENT controls of each power supply can be separately set. The output voltage controls of one power supply should be set to the desired output voltage; the other power supply should be set for a slightly larger output voltage. The supply set to the lower output voltage will act as a constant voltage source; the supply set to the higher output voltage will act as a constant current source, dropping its output voltage until it equals that of the other supply. The constant voltage source will deliver only that fraction of its total rated output current which is necessary to fulfill the total current demand.

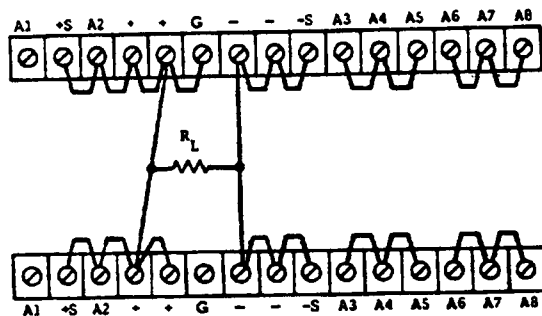

Figure 3-10. Normal Parallel Connections

3-41 Auto-Parallel. The strapping patterns for Auto-parallel operation of two power supplies are shown in Figure 3-11. Auto-Parallel operation permits equal current sharing under all load conditions, and allows complete control of output current from one master power supply. The output current of each slave will be approximately equal

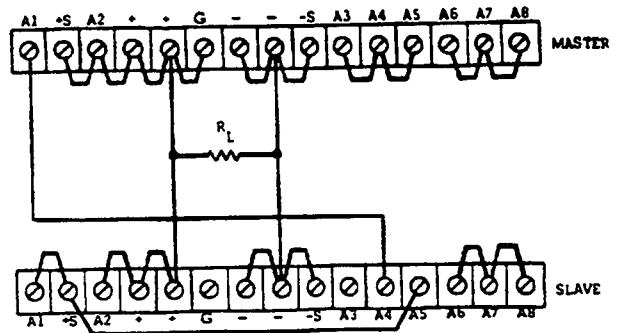
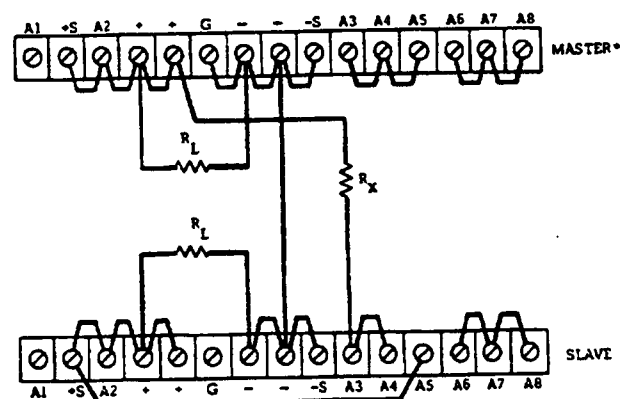

Figure 3-11. Auto-Parallel, Two Units

to the master's regardless of the load conditions. Because the output current controls of each slave are operative, they should be set to maximum to avoid having the slave revert to constant current operation; this would occur if the master output current setting exceeded the slave's.

3-42 AUTO-TRACKING OPERATION (See Figure 3-12)



*MASTER MUST BE MOST POSITIVE SUPPLY

Figure 3-12. Auto-Tracking, Two Units

3-43 The Auto-Tracking configuration is used when it is necessary that several different voltages referred to a common bus, vary in proportion to the setting of a particular instrument (the control or master). A fraction of the master's output voltage is fed to the comparison amplifier of the slave supply, thus controlling the slave's output. The master must have the largest output voltage of any power supply in the group (must be the most positive supply in the example shown on Figure 3-12).

3-44 The output voltage of the slave is a percentage of the master's output voltage, and is determined by the voltage divider consisting of R_x and the voltage control of the slave supply, R_p , where: $E_S = R_p/R_x + R_p$. Turn-on and turn-off the power supplies is controlled by the master. Remote sensing and programming can be used; although the strapping patterns for these modes show only local sensing and programming. In order to maintain the temperature coefficient and stability specifications of the power supply, the external resistors should be stable, low noise, low temperature (less than 30 ppm per °C) resistors.

3-45 SPECIAL OPERATING CONSIDERATIONS

3-46 PULSE LOADING

3-47 The power supply will automatically cross over from constant voltage to constant current operation, or the reverse, in response to an increase (over the preset limit) in the output current or voltage, respectively. Although the preset limit may be set higher than the average output current or voltage, high peak currents or voltages (as occur in pulse loading) may exceed the preset limit and cause crossover to occur. If this crossover limiting is not desired, set the preset limit for the peak requirement and not the average.

3-48 OUTPUT CAPACITANCE

3-49 An internal capacitor, connected across the output terminals of the power supply, helps to supply high-current pulses of short duration during constant voltage operation. Any capacitance added externally will improve the pulse current capability, but will decrease the safety provided by the constant current circuit. A high-current pulse may damage load components before the average output

current is large enough to cause the constant current circuit to operate.

3-50 The effects of the output capacitor during constant current operation are as follows:

a. The output impedance of the power supply decreases with increasing frequency.

b. The recovery time of the output voltage is longer for load resistance changes.

c. A large surge current causing a high power dissipation in the load occurs when the load resistance is reduced rapidly.

3-51 REVERSE VOLTAGE LOADING

3-52 A diode is connected across the output terminals. Under normal operating conditions, the diode is reverse biased (anode connected to negative terminal). If a reverse voltage is applied to the output terminals (positive voltage applied to negative terminal), the diode will conduct, shunting current across the output terminals and limiting the voltage to the forward voltage drop of the diode. This diode protects the series transistors and the output electrolytic capacitor.

3-53 REVERSE CURRENT LOADING

3-54 Active loads connected to the power supply may actually deliver a reverse current to the power supply during a portion of its operating cycle. An external source cannot be allowed to pump current into the supply without loss of regulation and possible damage to the output capacitor. To avoid these effects, it is necessary to preload the supply with a dummy load resistor so that the power supply delivers current through the entire operating cycle of the load device.

SECTION IV PRINCIPLES OF OPERATION

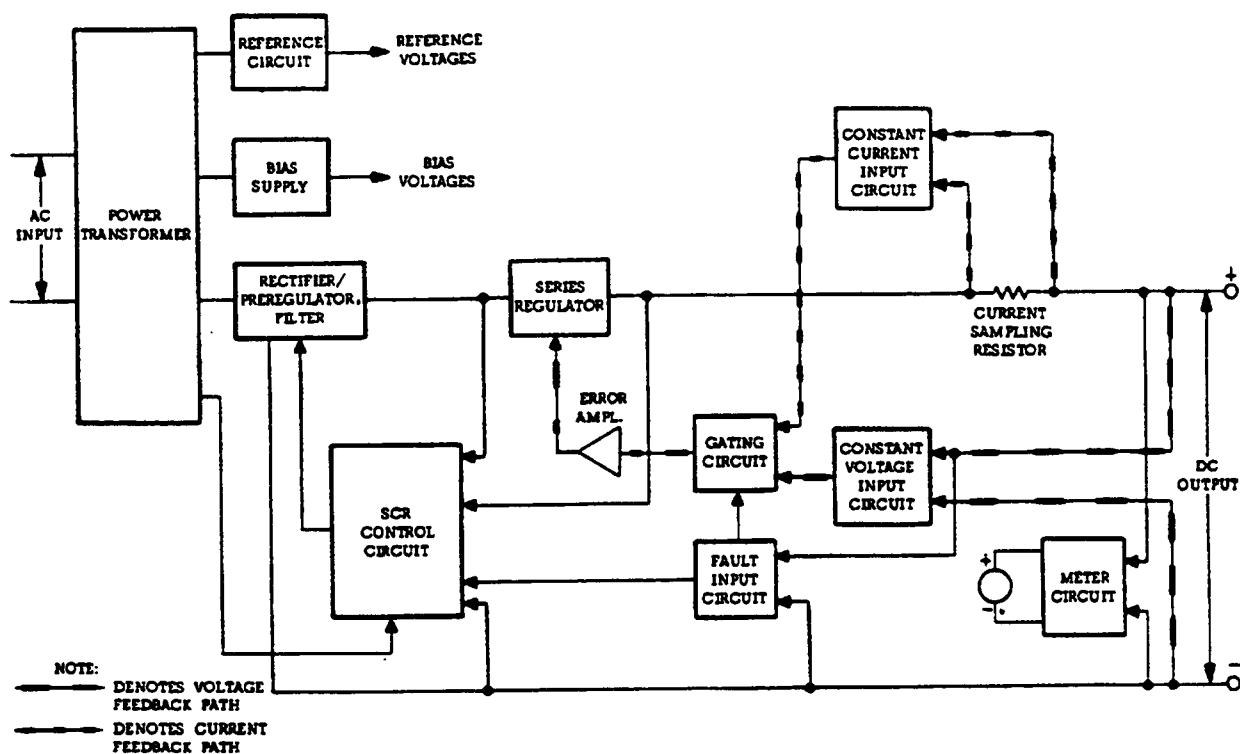

Figure 4-1. Overall Block Diagram

4-1 OVERALL BLOCK DIAGRAM DISCUSSION

4-2 The power supply, as shown on the overall block diagram on Figure 4-1, consists of a power transformer, a rectifier-preregulator-filter, preregulator (SCR) control circuit, series regulator, error amplifiers, gating circuit, a constant voltage input circuit, a constant current input circuit, a fault input circuit, a reference circuit, bias supply, and a meter circuit.

4-3 The input line voltage is reduced to the proper level by the power transformer and coupled to a rectifier bridge consisting of two rectifier diodes and two SCR's. The bridge simultaneously performs the necessary rectifying and preregulating functions. The SCR's, operating in conjunction with a control circuit, minimize the power dissipated by the series regulator by keeping the voltage drop across the regulator at a low and constant level. The SCR control circuit accom-

plishes this by issuing a firing pulse to one of the SCR's once during each half cycle of the input ac. The control circuit continuously samples the output voltage, the input line voltage, and the voltage across the series regulator and, on the basis of these inputs, determines at what time during each half cycle that the firing pulse will be generated.

4-4 The series regulator, part of another feedback loop, is made to alter its conduction to maintain a constant output voltage or current. Its conduction varies in accordance with feedback control signals obtained from the error amplifier. It should be noted that the series regulator provides fine and "fast" regulation of the output, while the preregulator handles large relatively "slow" regulation demands. The dc current from the series regulator passes through a current sampling resistor before reaching the positive output terminal.

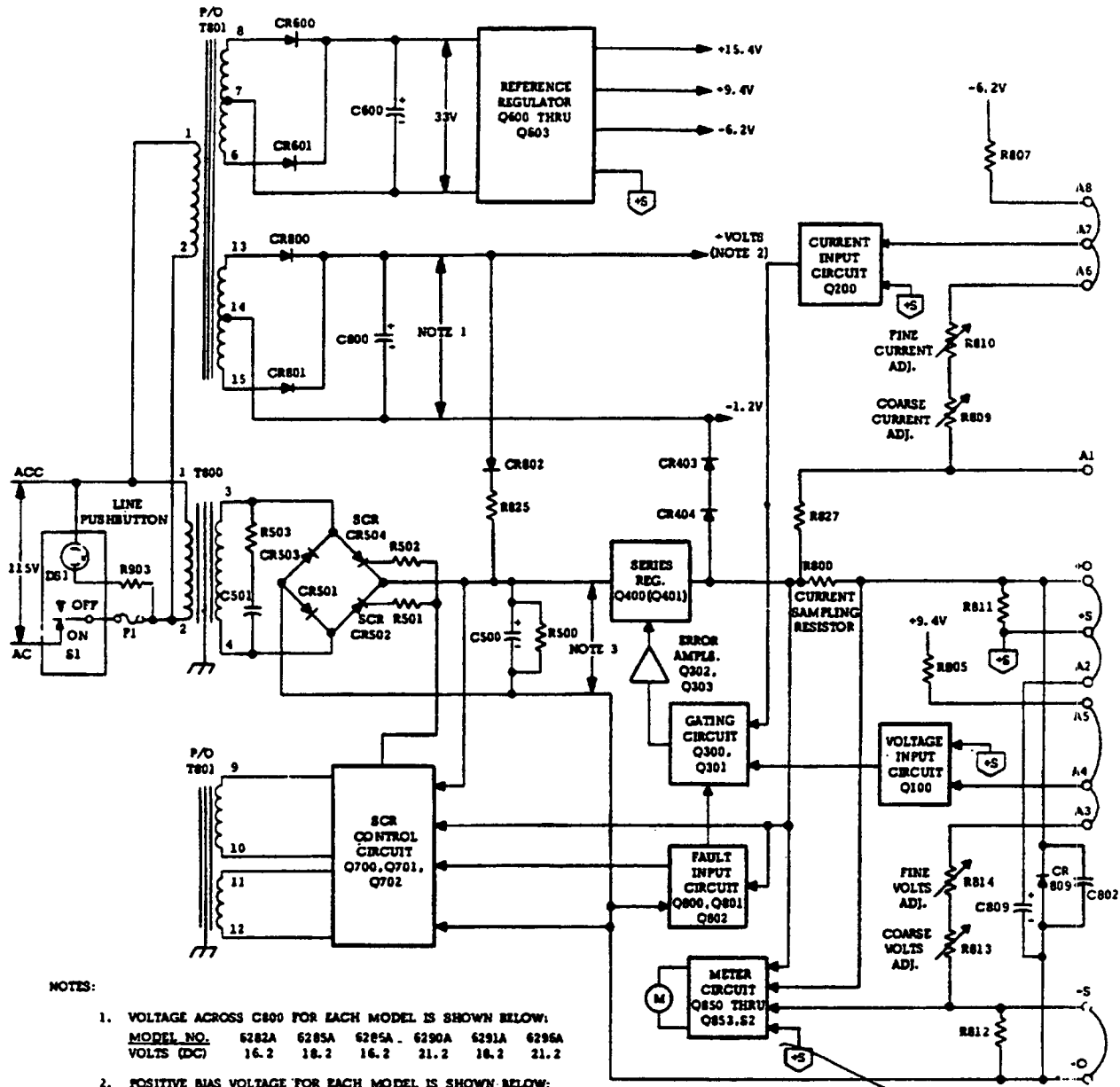

NOTES:

- VOLTAGE ACROSS C800 FOR EACH MODEL IS SHOWN BELOW:

| MODEL NO. | 6282A | 6285A | 6285A | 6290A | 6291A | 6296A |
|------------|-------|-------|-------|-------|-------|-------|
| VOLTS (DC) | 16.2 | 18.2 | 16.2 | 21.2 | 18.2 | 21.2 |
- POSITIVE BIAS VOLTAGE FOR EACH MODEL IS SHOWN BELOW:

| MODEL NO. | 6282A | 6285A | 6286A | 6290A | 6291A | 6296A |
|------------|-------|-------|-------|-------|-------|-------|
| VOLTS (DC) | +15V | +17V | +15V | +20V | +17V | +20V |
- VOLTAGE ACROSS INPUT FILTER CAPACITOR FOR EACH MODEL IS SHOWN BELOW:

| MODEL NO. | 6282A | 6285A | 6286A | 6290A | 6291A | 6296A |
|------------|-------|-------|-------|-------|-------|-------|
| VOLTS (DC) | 15 | 25 | 24 | 45 | 45 | 65 |

Figure 4-2. Simplified Schematic

4-5 The feedback signals that control the conduction of the series regulator are originated within the constant voltage input circuit or the constant current input circuit. The output voltage of the power supply is sampled by the constant voltage input circuit by means of the sensing terminals ($\pm S$). The voltage developed across the current sampling resistor is the input to the constant current input circuit. This voltage drop varies in direct proportion to the output current. Any changes in output voltage/current are detected in the constant voltage/constant current input circuit, amplified by the gating and error amplifiers, and applied to the series regulator in the correct phase and amplitude to counteract the changes.

4-6 The fault input circuit detects the presence of overvoltage or overcurrent conditions and generates the necessary turn-down signals to the SCR control circuit or the series regulator circuit. In the case of an overvoltage condition, a turn-down signal is applied to the SCR control circuit. The series regulator receives a turn-down signal via the gating circuit if an overcurrent condition is detected.

4-7 The reference circuit provides stable reference voltages which are used by the constant voltage/current input circuits for comparison purposes. The bias supply furnishes voltages which are used throughout the instrument for biasing purposes. The meter circuit provides an indication of output voltage or current in one of two ranges.

4-8 SIMPLIFIED SCHEMATIC

4-9 A simplified schematic of the power supply is shown in Figure 4-2. It shows the operating controls; the ON-off pushbutton, the voltage programming controls (R813 and R814) and the current programming controls (R809 and R810). The METER switch, included in the meter circuit block on Figure 4-2, allows the meter to read output voltage or current in one of two ranges. Figure 4-2 also shows the internal sources of bias and reference voltages and their nominal magnitudes with an input of 115 Vac and no load connected. Diode CR809, connected across the output terminals of the power supply, is a protective device which prevents internal damage that might occur if a reverse voltage were applied across the output terminals. Output capacitor, C809 stabilizes the feedback loop when the normal strapping pattern shown in Figure 4-2 is employed. Note that this capacitor can be removed if an increase in the programming speed is desired. Under these conditions, capacitor C802 serves to insure loop stability. Resistors R811 and R812 limit the output of the supply if the straps between the output and sensing terminals are inadvertently opened.

4-10 DETAILED CIRCUIT ANALYSIS

4-11 PREREGULATOR AND CONTROL CIRCUIT

4-12 The preregulator minimizes changes in the power dissipated by the series regulator due to output voltage or input line voltage changes. Preregulation is accomplished by means of a phase control circuit utilizing SCR's CR504 and CR502 as the switching elements. The appropriate SCR is fired once during each half-cycle (8.33 milliseconds) of the rectified ac (see Figure 4-3). Notice that when the SCR is fired at an early point during the half-cycle, the dc level applied to the series regulator is fairly high. When the SCR is fired later during the cycle, the dc level is relatively low.

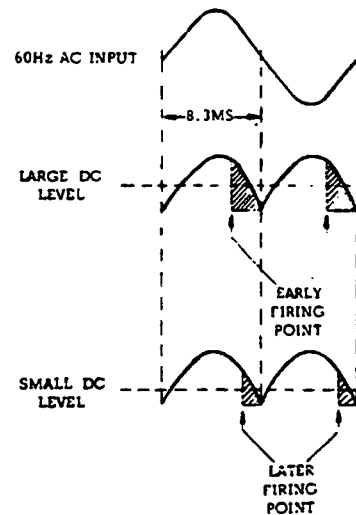

Figure 4-3. SCR Phase Control of DC Input Level

4-13 The SCR control circuit (See Figure 4-4) samples the input line voltage, the output voltage, and the voltage across the series transistor. It generates a firing pulse, at the time required, to fire the SCR so that the voltage across input capacitor C500 will be maintained at the desired level.

4-14 The inputs to the control circuit are algebraically summed across capacitor C700. All inputs contribute to the time required to charge C700. The input line voltage is rectified by CR704 through CR707, attenuated by voltage divider R700 and R701, and applied to the summing point at TP 59 via capacitor C700. Capacitor C701 is used for smoothing purposes.

4-15 Transistor Q702, connected in a common base configuration, provides a charging current for the summing capacitor which varies in accordance with the input signals applied to its emitter.

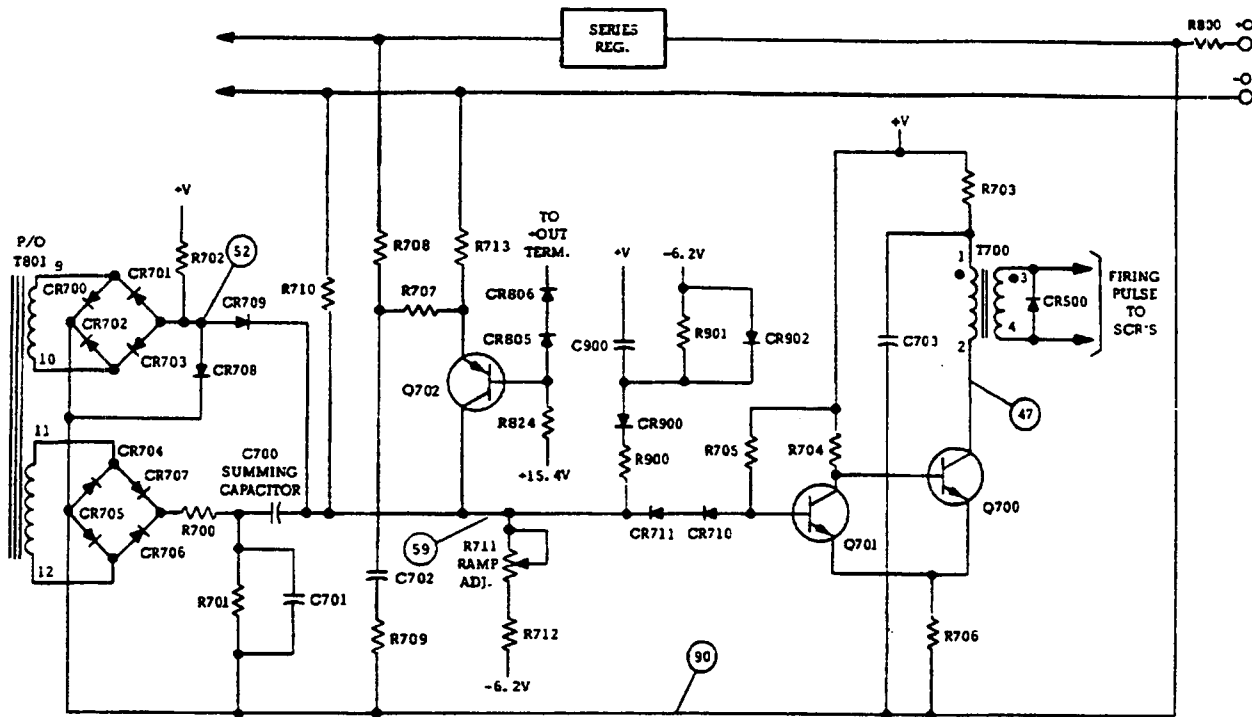
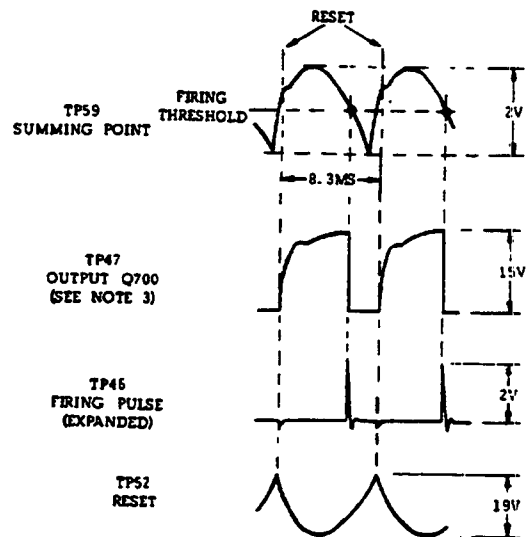

Figure 4-4. SCR Control Circuit, Simplified Schematic

Resistor R713, connected between the negative output line and the emitter of Q702, furnishes a signal which is proportional to the output voltage. Resistors R708 and R707 sample the voltage across, and the current through, the series regulator. Capacitor C702 and resistor R709 stabilize the control circuit feedback loop. Resistors R711 and R712 are the source of a constant offset current which sustains a net negative charging current to the summing point, ensuring that the SCR's will fire at low output voltages.

4-16 The summation of the input signals results in the generation of a voltage waveform at TP 59 similar to that shown on Figure 4-5. When the linear ramp portion of the waveform reaches a certain negative threshold voltage, diodes CR711 and CR710 become forward biased. The negative voltage then is coupled to the base of transistor Q701. Transistors Q701 and Q700 form a squaring circuit resembling a Schmitt trigger configuration. Q701 is conducting, prior to firing time, due to the positive bias connected to its base through R705. Transistor Q700 is cut off at this time because its base is connected directly to the collector of conducting transistor Q701. When the negative threshold voltage is reached, transistor Q701 is turned off which turns Q700 on. The conduction of Q700 allows capacitor C703 to discharge rapidly through pulse transformer T700 resulting in the SCR firing pulse shown on the



NOTES:

1. ALL WAVEFORMS REFERENCED TO INBOARD SIDE OF CURRENT SAMPLING RESISTOR R800 EXCEPT FIRING PULSE WHICH IS REFERENCED TO T. P. 45.
2. FOR CLARITY WAVEFORMS ARE NOT DRAWN TO SCALE.
3. AMPLITUDE OF THIS WAVEFORM IS APPROXIMATE AND VARIES SLIGHTLY FROM MODEL TO MODEL IN ACCORDANCE WITH THE POSITIVE COLLECTOR BIAS OBTAINED FROM C800.

Figure 4-5. SCR Control Circuit Waveforms

diagram. The firing pulse is relatively narrow because Q700 saturates rapidly causing the magnetic field surrounding T700 to collapse. Diode CR500 damps out the negative overshoot.

4-17 Reset of the control circuit occurs once every 8.33 milliseconds when the rectified ac voltage at test point 52 recedes to a level at which diode CR709 becomes forward biased. Summing capacitor C700 is then allowed to discharge through CR709. Diodes CR711 and CR710 become reverse biased at reset and transistor Q701 reverts to its "on" state. Consequently, Q700 is turned off and capacitor C703 charges up through R703 at a comparatively slow rate until the collector voltage of Q700 reaches approximately +17 volts. The above action causes the small negative spike that appears across the winding of pulse transformer T700 at reset time.

4-18 Capacitor C900, diode CR900, and resistor R900 form a long time constant network which achieves a slow turn-on characteristic. When the unit is first turned on, C900 provides a positive voltage to the cathode of CR711 to ensure that it is initially reverse biased. After C900 becomes fully charged, the control circuit is permitted to fire the SCR's. Diode CR902 provides a discharge path for C900 when the unit is turned off.

4-19 SERIES REGULATOR

4-20 The series regulator (transistor Q400 or Q400 and Q401, see schematic at rear of manual)

serves as the series, or "pass", element which provides precise and rapid control of the output. The conduction of the series transistor(s) is controlled by the feedback signals obtained from driver Q303. Diode CR400, connected across the regulator circuit, protects the series element(s) from reverse voltages that could develop across them during parallel operation if one supply is turned on before the other.

4-21 CONSTANT VOLTAGE INPUT CIRCUIT (See Figure 4-6)

4-22 The circuit consists of the programming resistors (R813 and R814) and a differential amplifier stage (Q100 and associated components). Transistor Q100 consists of two silicon transistors housed in a single package. The transistors have matched characteristics minimizing differential voltages due to mismatched stages. Moreover, drift due to thermal differentials is minimized, since both transistors operate at essentially the same temperature.

4-23 The constant voltage input circuit continuously compares a fixed reference voltage with a portion of the output voltage and, if a difference exists, produces an error voltage whose amplitude and phase is proportional to the difference. The error output is fed back to the series regulator, through the gating and error amplifiers. The error voltage changes the conduction of the series regulator which, in turn, alters the output voltage

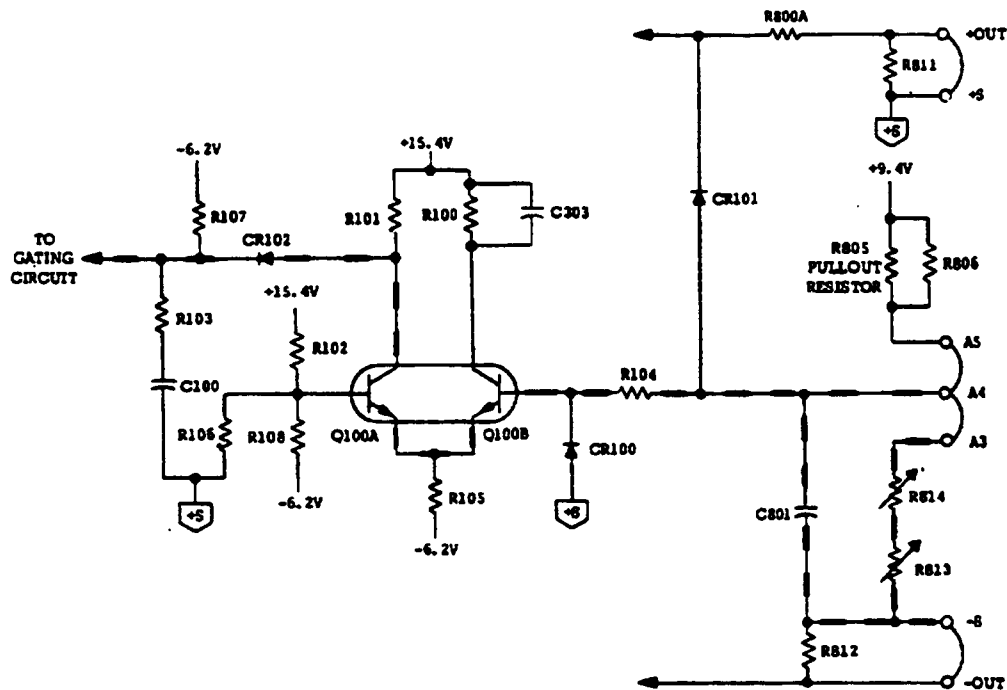

Figure 4-6. Constant Voltage Input Circuit, Simplified Schematic

so that the difference between the two input voltages applied to the differential amplifier is reduced to zero. This action maintains the output voltage constant.

4-24 Stage Q100A of the differential amplifier is connected to a common (+S) potential through impedance equalizing resistor R106. Resistors R102 and R108 are used to zero bias the input stage, offsetting minor base to emitter voltage differences in Q100. The base of Q100B is connected to a summing point (A4) at the junction of the programming resistors and the current pullout resistor R805. Instantaneous changes in the output (due to load variations) or changes due to the manipulation of R813, result in an increase or decrease in the summing point potential. Q100B is then made to conduct more or less, in accordance with summing point voltage change. The change in Q100B's conduction also varies the conduction of Q100A due to the coupling effects of the common emitter resistor, R105. The "error" voltage is taken from the collector of Q100A and ultimately varies the conduction of the series regulator.

4-25 Resistor R104, in series with the base of Q100B, limits the current through the programming resistors during rapid voltage turn-down. Diodes CR100 and CR101 form a limiting network which prevents excessive voltage excursions from over driving stage Q100B. Capacitor C801, shunting

the programming resistors, increase the high frequency gain of the input amplifier. Resistor R806, shunting the pullout resistor, serves as a trimming adjustment for the programming current. Diode CR102 establishes the proper collector bias for Q100A while R103 and C100 provide low frequency equalization for the feedback loop.

4-26 CONSTANT CURRENT INPUT CIRCUIT (See Figure 4-7)

4-27 This circuit is similar in appearance and operation to the constant voltage input circuit. It consists of the coarse and fine current programming resistors (R809 and R810), and a differential amplifier stage (Q200 and associated components). Like transistor Q100 in the voltage input circuit, Q200 consists of two transistors, having matched characteristics, that are housed in a single package.

4-28 The constant current input circuit continuously compares a fixed reference voltage with the voltage drop across the current sampling resistor. If a difference exists, the differential amplifier produces an "error" voltage which is proportional to this difference. The remaining components in the feedback loop (amplifiers and series regulator) function to maintain the drop across the current sampling resistor, and consequently the output current, at a constant value.

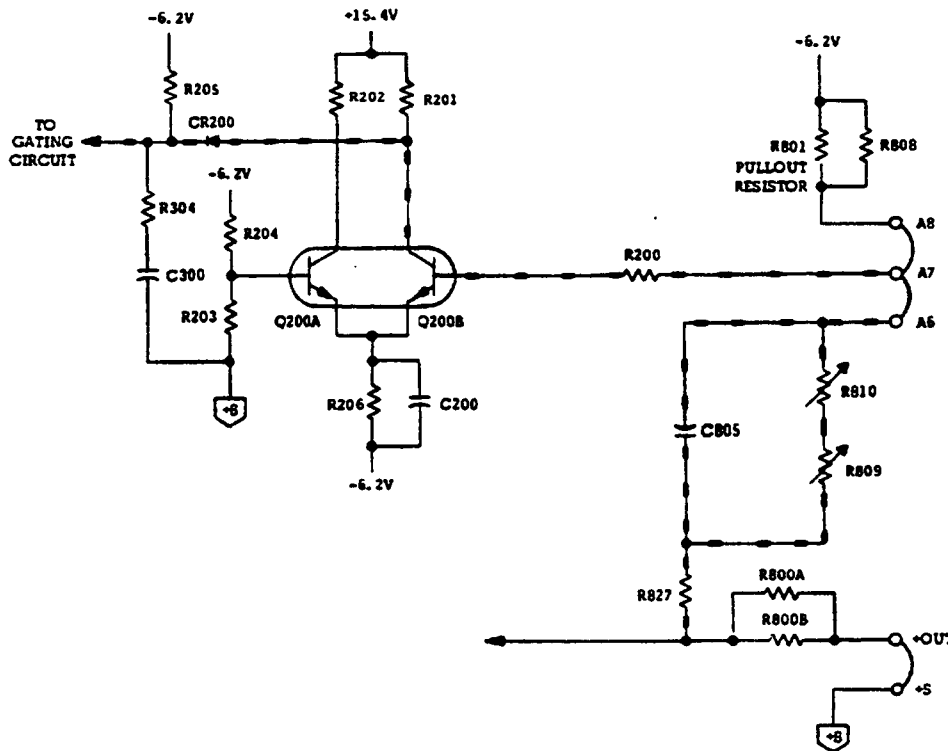

Figure 4-7. Constant Current Input Circuit, Simplified Schematic

4-29 Stage Q200A is connected to +S through impedance equalizing resistor R203. Instantaneous changes in output current on the positive line are felt at the current summing point (terminal A7) and, hence, the base of Q200B. Stage Q200B varies its conduction in accordance with the polarity of the change at the summing point. The error voltage is taken from the collector Q200B and ultimately varies the conduction of the series regulator.

4-30 Resistor R304, in conjunction with C300, helps stabilize the feedback loop. Resistor R808, shunting the pullout resistor, serves as a trimming adjustment for the programming current flowing through R809 and R810.

4-31 GATING CIRCUIT

4-32 The gating circuit (see schematic) consists of gating amplifiers Q301 and Q300 and associated OR-gate diodes, CR300 and CR301. The gating circuit provides sharp crossover between constant voltage and constant current operation. During steady state conditions, one transistor is saturated while the other is conducting in its linear region. The cathodes of the OR-gate diodes are always at a more positive potential than the saturation potential of Q300 or Q301. Thus, the diode associated with the saturated transistor is reverse biased while the diode associated with the other transistor is forward biased. In the constant voltage mode Q301 is operating in its linear region and Q300 is saturated due to the positive collector voltage of Q200B. OR-gate diode CR301 is therefore reverse biased while OR-gate diode CR300 is forward biased, coupling the constant voltage feedback signal to the error amplifier. Opposite conditions prevail during constant current operation.

4-33 Capacitor C302 is a commutating capacitor which improves the transient response of the unit. Resistor R300 is the biasing resistor for the OR-gate diodes.

4-34 ERROR AMPLIFIERS

4-35 The error amplifiers Q302 and Q303, amplify the feedback signal from the constant voltage or constant current input circuit to a level sufficient to drive the series regulator transistor. Transistor Q303 serves as the driver and Q302 the predriver, for the series regulator. The RC network, composed of C301 and R307, is an equalizing network which provides for high frequency roll-off in the loop gain response in order to stabilize the feedback loop.

4-36 Capacitor C900, diode CR901, and resistor R902 form a long time constant network which achieves a slow turn-on characteristic. When the unit is first turned on, C900 provides a positive voltage to the base of Q302 keeping the series regulator from conducting initially. As C900 charges up, the restrictive bias becomes less positive enabling the regulator to conduct. Diode CR902 provides a low resistance discharge path for C900 when the unit is turned off.

4-37 FAULT INPUT CIRCUIT

4-38 The fault input circuit (see schematic at rear) protects the power supply against overvoltage and overcurrent conditions. Transistor Q800, and associated components, comprise the overvoltage detector. With normal output voltages Q800 is cut off due to the +15.4V reference voltage connected to the top of voltage divider R823 and R821. If the output voltage exceeds a certain limit (about 20% above the maximum rated output voltage) transistor Q800 is driven into conduction. Current is then conducted away from the summing point and in opposition to the charge path of C700 in the SCR control circuit. As a result, the SCR's are fired at a later time, reducing the series regulator input voltage to a safe value.

4-39 A full wave rectified voltage, obtained from the SCR control circuit, exerts a stabilizing influence on transistor Q800. This signal tends to synchronize the conduction of Q800 at a 120 Hz rate preventing random firing of the SCR's.

4-40 Transistors Q801 and Q802 provide overcurrent and short circuit protection for the unit. Overcurrent protection is accomplished by Q802 which is activated only if the constant current input circuit should fail. Q802 monitors the voltage drop across the current sampling resistor and conducts if this drop exceeds a certain level. The output of Q802 is fed to gating amplifier Q301 via R815 and ultimately reduces the conduction of the series regulator.

4-41 Short circuit protection is provided by transistors Q801 and Q802. Transistor Q801, normally biased below cutoff, monitors the voltage drop across the series regulator. Under short circuit conditions, the increased voltage across the regulator drives Q801 into saturation. The positive going emitter voltage of Q801 also drives Q802 into conduction. The output of Q802 limits the current flow through the series regulator to a prescribed level.

4-42 REFERENCE CIRCUIT (See Schematic at Rear)

4-43 The reference circuit is a feedback power supply similar to the main supply. It provides stable reference voltages which are used throughout the unit. The reference voltages are all derived from smoothed dc obtained from the full wave rectifier (CR600 and CR601) and filter capacitor C600. The +9.4 and -6.2 voltages are developed across temperature compensated Zener diodes VR600 and VR601. Resistor R611 limits the current through the Zener diodes to establish an optimum bias level.

4-44 The regulating circuit consists of series regulating transistor Q600, error amplifier Q601, and differential amplifier Q602 and Q603. The voltage across the Zener reference diode VR600 and the voltage at the junction of divider R605 and R606 are compared, and any differences are de-

tected by Q602 and Q603. The error voltage is amplified and inverted by Q601 and applied to series regulator Q600 in the correct phase and amplitude to maintain the +15.4 volt output constant.

4-45 Zener diode VR601 provides an additional bias voltage of -6.2 volts. Resistor R601, connected across Q600, minimizes power dissipation in the series element. Output capacitor C602 stabilizes the reference regulator loop.

4-46 METER CIRCUIT

4-47 The meter circuit (see Figure 4-8) provides continuous indications of output voltage or current on a single multiple range meter. The meter can be used either as a voltmeter or an ammeter depending upon the position of METER switch S2 on the front panel of the supply. This switch

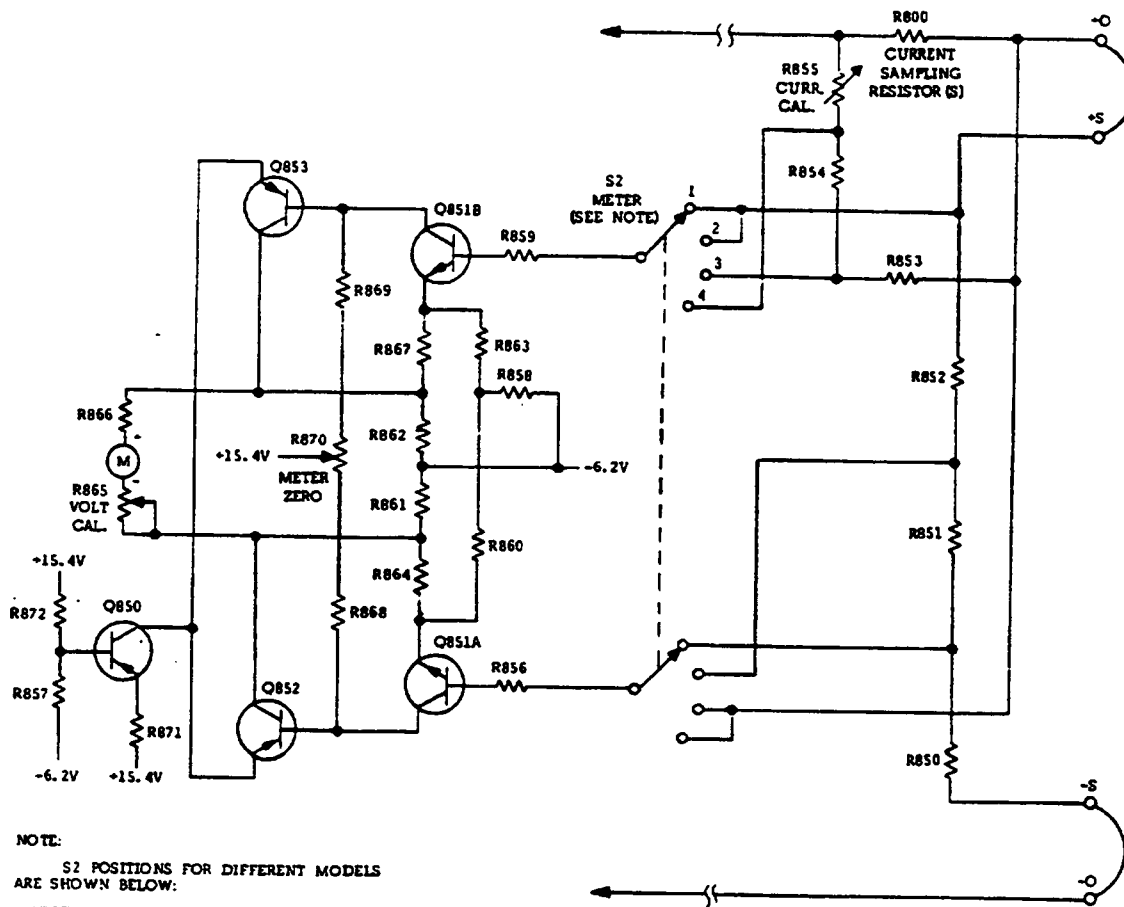

NOTE:

S2 POSITIONS FOR DIFFERENT MODELS ARE SHOWN BELOW:

| MODEL | S2 TERMINAL NOS. | | | |
|-------|------------------|-----|-----|------|
| | 1 | 2 | 3 | 4 |
| 6282A | 1.2V | 12V | 12A | 1.2A |
| 6285A | 2.4V | 24V | 6A | .6A |
| 6286A | 2.4V | 24V | 12A | 1.2A |
| 6290A | 5V | 50V | 4A | .4A |
| 6291A | 5V | 50V | 6A | .6A |
| 6296A | 7V | 70V | 4A | .4A |

Figure 4-8. Meter Circuit, Simplified Schematic

also selects one of two meter ranges on each scale. The metering circuit consists basically of a selection circuit (switch S2 and associated voltage dividers), a stable differential amplifier stage (Q851A and Q851B), two meter amplifiers (Q852 and Q853), and the meter movement.

4-48 The selection circuit determines which voltage divider is connected to the differential amplifier input. When S2 is in one of the voltage positions, the voltage across divider R850, R851, and R852 (connected across the output of the supply) is the input to the differential amplifier. When S2 is in one of the current positions, the voltage across divider R853, R854, and R855 (connected across the sampling resistor) is the input to the differential amplifier. With S2 in the higher voltage range (position 2) the voltage drop across R852 is applied to stage Q851A while stage Q851B is grounded to the +S terminal. For low output voltages, S2 can be set to position (1) resulting in the application of a larger percentage of the output voltage (drop across R851 and R852) to stage Q851A. With S2 in the higher current position (3) the voltage drop across R853 is applied

to stage Q851B while stage Q851A is grounded to the +S terminal. In the low current range, the voltage drop across R853 and R854 is applied to Q851B.

4-49 Differential amplifier stage Q851 is a stable device having a fixed gain of ten. To minimize temperature effects, the two stages are housed in a single package that is similar to those used in the constant voltage and current input circuits. The outputs of the differential amplifier drive meter amplifiers Q852 and Q853 which, in turn, deflect the meter. Transistor Q850 provides a constant bias current to the emitters of Q852 and Q853. Potentiometer R870 permits electrical zeroing of the meter.

4-50 The meter circuit contains an inherent current limiting feature which protects the meter movement against overloads. For example, if METER switch S2 is placed in the low current range when the power supply is actually delivering a higher ampere output, the differential amplifiers are quickly driven into saturation, limiting the current through the meter to a safe value.

SECTION V MAINTENANCE

5-1 INTRODUCTION

5-2 Upon receipt of the power supply, the performance check (Paragraph 5-10) should be made. This check is suitable for incoming inspection. If a fault is detected in the power supply while making the performance check or during normal operation, proceed to the troubleshooting procedures (Paragraph 5-41). After troubleshooting and repair (Paragraph 5-46), perform any necessary adjustments and calibrations (Paragraph 5-48). Before returning the power supply to normal operation, repeat the performance check to ensure that the fault has been properly corrected and that no other faults exist. Before doing any maintenance checks, turn on power supply, allow a half-hour warm-up, and read the general information regarding measurement techniques (Paragraph 5-3).

5-3 GENERAL MEASUREMENT TECHNIQUES

5-4 The measuring device must be connected across the sensing leads of the supply or as close to the output terminals as possible when measuring the output impedance, transient response, regulation, or ripple of the power supply in order to achieve valid measurements. A measurement made across the load includes the impedance of the leads to the load and such lead lengths can easily have an impedance several orders of magnitude greater than the supply impedance, thus invalidating the measurement.

5-5 The monitoring device should be connected to the +S and -S terminals (see Figure 3-2) or as shown in Figure 5-1. The performance characteristics should never be measured on the front terminals if the load is connected across the rear terminals. Note that when measurements are made at the front terminals, the monitoring leads are connected at A, not B, as shown in Figure 5-1. Failure to connect the measuring device at A will result in a measurement that includes the resistance of the leads between the output terminals and the point of connection.

5-6 For output current measurements, the current sampling resistor should be a four-terminal resis-

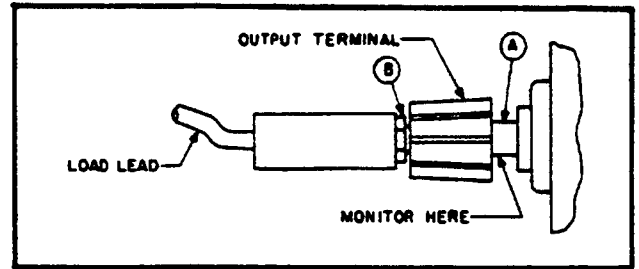

Figure 5-1. Front Panel Terminal Connections

tor. The four terminals are connected as shown in Figure 5-2. In addition, the resistor should be of the low noise, low temperature coefficient (less than 30ppm/°C) type and should be used at no more than 5% of its rated power so that its temperature rise will be minimized.

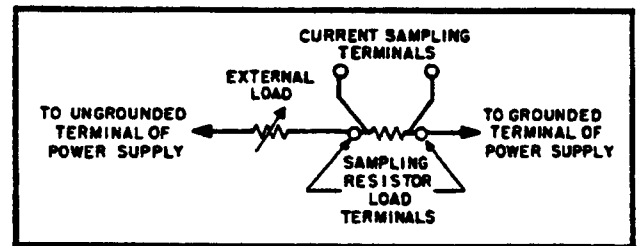

Figure 5-2. Output Current Measurement Technique

5-7 When using an oscilloscope, ground one terminal of the power supply and then ground the case of the oscilloscope to this same point. Make certain that the case is not also grounded by some other means (Power line). Connect both oscilloscope input leads to the power supply ground terminal and check that the oscilloscope is not exhibiting a ripple or transient due to ground loops, pick-up, or other means.

5-8 TEST EQUIPMENT REQUIRED

5-9 Table 5-1 lists the test equipment required to perform the various procedures described in this Section.

Table 5-1. Test Equipment Required

| Type | Required Characteristics | Use | Recommended Model |
|------------------------------|--|---|-----------------------------|
| Differential Voltmeter | Sensitivity: 1 mv full scale (min.). Input impedance: 10 megohms (min.). | Measure DC voltages; calibration procedures | Ⓢ 3420 (See Note) |
| Variable Voltage Transformer | Range: 90-130 volts. Equipped with voltmeter accurate within 1 volt. | Vary AC input | ----- |
| AC Voltmeter | Accuracy: 2%. Sensitivity: 1 mv full scale deflection (min.). | Measure AC voltages and ripple | Ⓢ 403 B |
| Oscilloscope | Sensitivity: 100 μ v/cm. Differential input. | Display transient response waveforms | Ⓢ 140 A plus 1400A plug in. |
| Oscillator | Range: 5Hz to 1 MHz. Accuracy: 2%. | Impedance checks | Ⓢ 200 CD |
| DC Voltmeter | Accuracy: 1%. Input resistance: 20,000 ohms/volt (min.). | Measure DC voltages | Ⓢ 412 A |
| Repetitive Load Switch | Rate: 60 — 400 Hz, 2 μ sec rise and fall time. | Measure transient response | See Figure 5-7 |
| Resistive Loads | Value: See Paragraph 5-14. and Figure 5-4. \pm 5% 250 watts. | Power supply load resistors | ----- |
| Current Sampling Resistor | Value: See Figure 5-4. 1%, 200 watts, 20ppm, 4-Terminal. | Measure current; calibrate meter | ----- |
| Resistor | 1K Ω \pm 1%. 2 watt non-inductive | Measure impedance | ----- |
| Resistor | 100 ohms, \pm 5%, 10 watt | Measure impedance | ----- |
| Resistor | Value: See Paragraph 5-45. \pm 0.1%, 20 watt. | Calibrate programming current | ----- |

| Type | Required Characteristics | Use | Recommended Model |
|-----------------------|--|-----------------------------------|-------------------|
| Resistor | Value: See Paragraph 5-47. ±0.1%, 1/2 watt. | Calibrate programming current | ----- |
| Capacitor | 500μf, 50 wvdc | Measure impedance. | ----- |
| Decade Resistance Box | Range: 0-500K. Accuracy: 0.1% plus 1 ohm Make-before-break contacts. | Measure programming coefficients. | ----- |

NOTE

A satisfactory substitute for a differential voltmeter is to arrange a reference voltage source and null detector as shown in Figure 5-3. The reference voltage source is adjusted so that the voltage difference between the supply being measured and the reference voltage will have the required resolution for the measurement being made. The voltage difference will be a function of the null detector that is used. Examples of satisfactory null detectors are: ④ 419 A null detector, a DC coupled oscilloscope utilizing differential input, or a 50 mv meter movement with a 100 division scale. For the latter, a 2 mv change in voltage will result in a meter deflection of four divisions.

CAUTION

Care must be exercised when using an electronic null detector in which one input terminal is grounded to avoid ground loops and circulating currents.

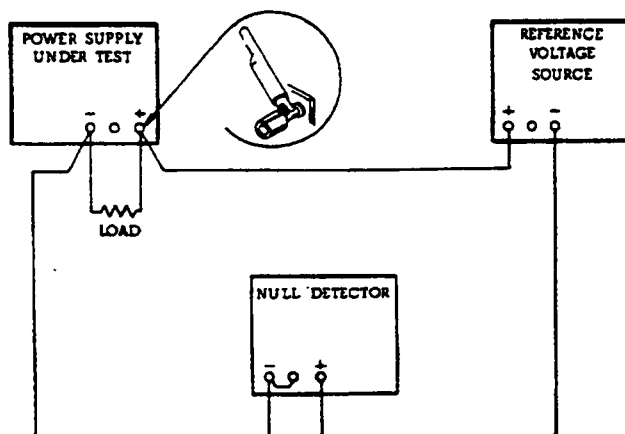

Figure 5-3. Differential Voltmeter Substitute, Test Setup

5-10 PERFORMANCE TEST

5-11 The following test can be used as an incoming inspection check and appropriate portions of the test can be repeated either to check the operation of the instrument after repairs or for periodic maintenance tests. The tests are performed using a 115-VAC 60 cps., single phase input power source. If the correct result is not obtained for a particular check, do not adjust any controls; proceed to troubleshooting (Paragraph 5-28).

5-12 CONSTANT VOLTAGE TESTS

5-13 Rated Output and Meter Accuracy.

5-14 Voltage. Proceed as follows:

- Connect load resistor across rear output terminals of supply. Resistor value to be as follows:

| Model | 6282A | 6285A | 6286A | 6290A | 6291A | 6296A |
|-------|------------|------------|------------|-------------|------------|-------------|
| Res. | 1 Ω | 4 Ω | 2 Ω | 13 Ω | 8 Ω | 20 Ω |
- Connect differential voltmeter across +S and -S terminals of supply observing correct polarity.
- Set METER switch to highest voltage range and turn on supply.
- Adjust VOLTAGE controls until front panel meter indicates exactly the maximum rated output voltage.
- Differential voltmeter should indicate maximum rated output voltage within $\pm 2\%$.

5-15 Current. Proceed as follows:

- Connect test setup shown in Figure 5-4, leaving switch S1 open.
- Turn CURRENT controls fully clockwise.
- Set METER switch to highest current range and turn on supply.
- Adjust VOLTAGE controls until front panel meter indicates exactly the maximum rated output current.
- Differential voltmeter should read 1.0 ± 0.02 Vdc.

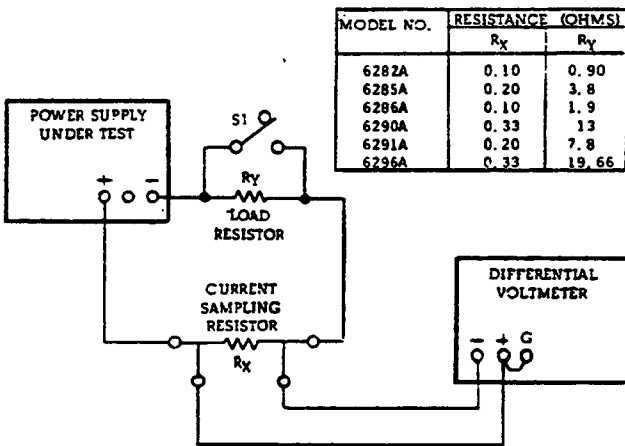

Figure 5-4. Output Current Test Setup

5-16 Load Regulation. To check constant voltage load regulation, proceed as follows:

- Connect test setup as shown in Figure 5-5.
- Turn CURRENT controls fully clockwise.
- Set METER switch to highest current range and turn on supply.

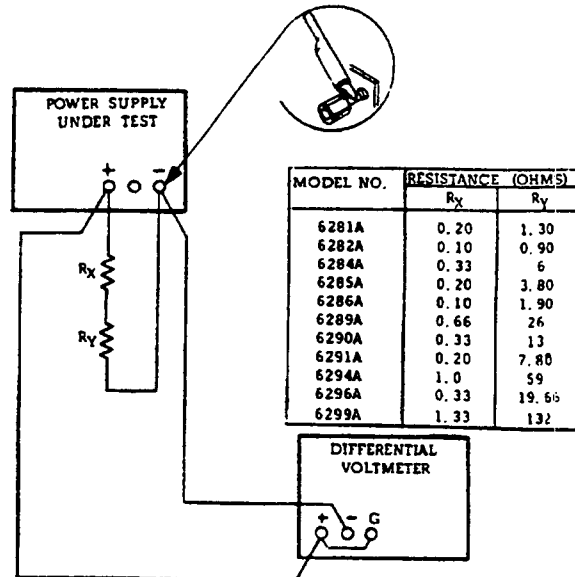

Figure 5-5. Load Regulation, Constant Voltage

- Adjust VOLTAGE controls until front panel meter indicates exactly the maximum rated output voltage.
- Read and record voltage indicated on differential voltmeter.
- Disconnect load resistors.
- Reading on differential voltmeter should not vary from reading recorded in step e by more than the following (variations expressed in mVdc):

| Model | 6282A | 6285A | 6286A | 6290A | 6291A | 6296A |
|-----------|---------|---------|---------|---------|---------|---------|
| Variation | ± 2 | ± 3 | ± 3 | ± 5 | ± 5 | ± 7 |

NOTE

If measurements are made at the front terminals, readings will be 0.5mV per amp greater due to front terminal resistance.

5-17 Line Regulation. To check the line regulation, proceed as follows:

- Connect variable auto transformer between input power source and power supply power input.
- Turn CURRENT controls fully clockwise.
- Connect test setup shown in Figure 5-5.
- Adjust variable auto transformer for 1.05 VAC input.
- Set METER switch to highest voltage range and turn on supply.
- Adjust VOLTAGE controls until front panel meter indicates exactly the maximum rated output voltage.
- Read and record voltage indicated on differential voltmeter.
- Adjust variable auto transformer for 1.25 VAC input.

i. Reading on differential voltmeter should not vary from reading recorded in step g by more than the following (variations expressed in mVdc):

| | | | | | | |
|-----------|-------|-------|-------|-------|-------|-------|
| Model | 6282A | 6285A | 6286A | 6290A | 6291A | 6296A |
| Variation | ±2 | ±3 | ±3 | ±5 | ±5 | ±7 |

5-18 Ripple and Noise. To check the ripple and noise, proceed as follows:

- Retain test setup used for previous line regulation test except connect AC voltmeter across output terminals as shown in Figure 5-6.
- Adjust variable auto transformer for 125 VAC input.
- Set METER switch to highest current range.
- Turn CURRENT controls fully clockwise and adjust VOLTAGE controls until front panel meter indicates exactly the maximum rated output voltage.
- AC voltmeter should read less than 0.50mVrms.

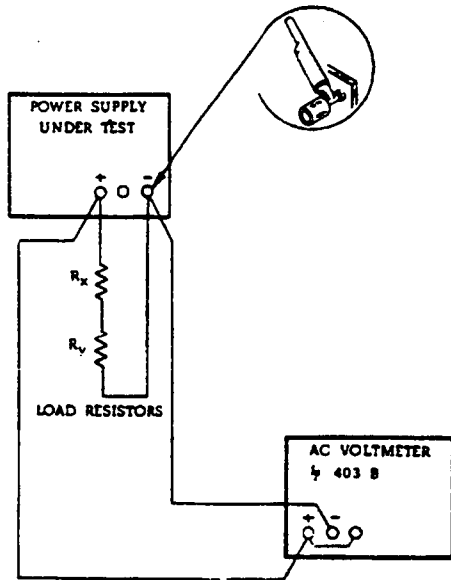
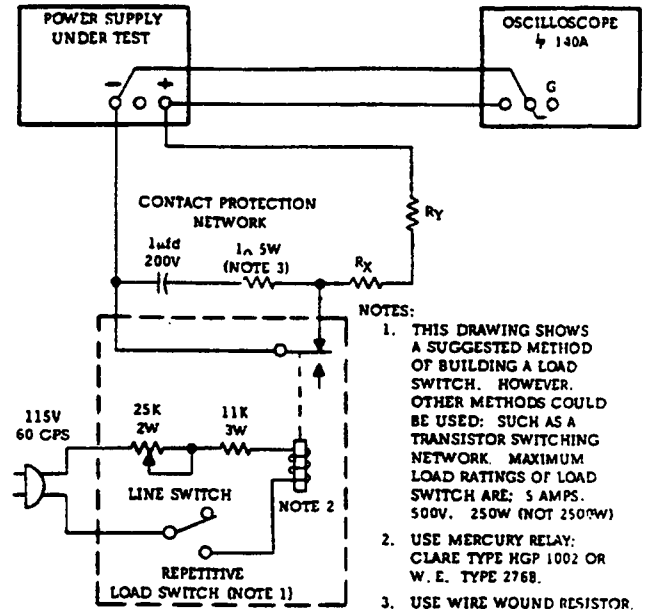

Figure 5-6. Ripple and Noise, Constant Voltage

5-19 Transient Recovery Time. To check the transient recovery time proceed as follows:

- Connect test setup shown in Figure 5-7.
- Turn CURRENT controls fully clockwise.
- Set METER switch to highest current range and turn on supply.
- Adjust VOLTAGE controls until front panel meter indicates exactly the maximum rated output current or 5 amperes, whichever is smaller.
- Close line switch on repetitive load switch setup.



| MODEL NO. | RESISTANCE (OHMS) | |
|-----------|-------------------|----------------|
| | R _x | R _y |
| 6282A | 0.10 | 0.90 |
| 6285A | 0.20 | 3.80 |
| 6286A | 0.10 | 1.90 |
| 6290A | 0.33 | 13.0 |
| 6291A | 0.20 | 7.80 |
| 6296A | 0.33 | 19.66 |

Figure 5-7. Transient Response, Test Setup

f. Adjust 25K potentiometer until a stable display is obtained on oscilloscope. Waveform should be within the tolerances shown in Figure 5-8 (output should return to within 15 mV of original value in less than 50 microseconds).

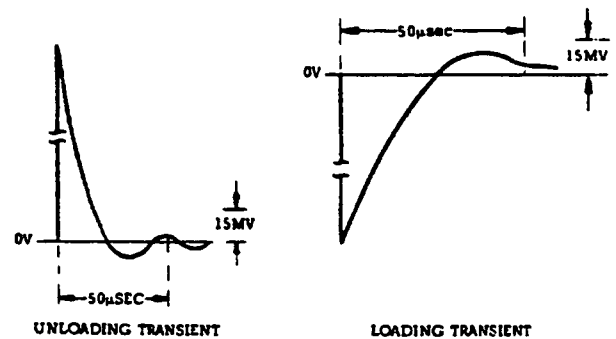

Figure 5-8. Transient Response Waveforms

5-20 Output Impedance. To check the output impedance, proceed as follows:

- Connect test setup shown in Figure 5-9.

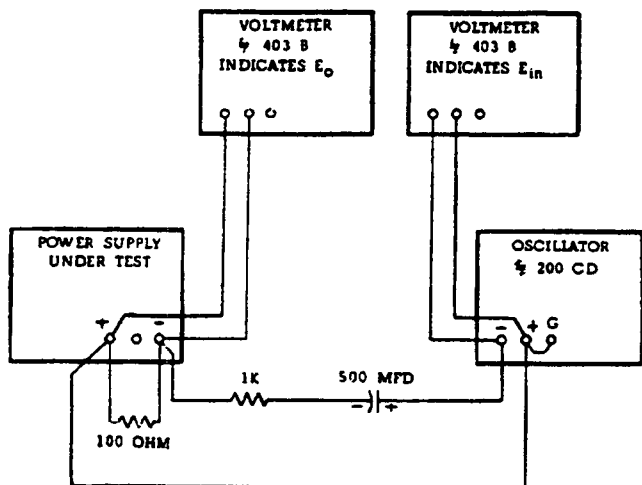

Figure 5-9. Output Impedance, Test Setup

b. Set METER switch to highest voltage range turn CURRENT controls fully clockwise, and turn on supply.

c. Adjust VOLTAGE controls until front panel meter reads 10 volts.

d. Set AMPLITUDE control on Oscillator to 10 volts (E_{in}), and FREQUENCY control to 100Hz.

e. Record voltage across output terminals of the power supply (E_o) as indicated on AC voltmeter.

f. Calculate the output impedance by the following formula:

$$Z_{out} = \frac{E_o R}{E_{in} - E_o}$$

E_o = rms voltage across power supply output terminals.

$R = 1000$

$E_{in} = 10$ volts

g. The output impedance (Z_{out}) should be less than 0.001 ohm.

h. Using formula of step f, calculate output impedance at frequencies of 1KHz, 100KHz, and 1MHz. Values should be less than 0.01 ohm, 0.2 ohm, and 2 ohms, respectively.

5-21 CONSTANT CURRENT TESTS

5-22 Load Regulation. To check the constant current load regulation, proceed as follows:

- Connect test setup shown in Figure 5-4.
- Turn VOLTAGE controls fully clockwise.
- Set METER switch to highest current range and turn on supply.
- Adjust CURRENT controls until front panel meter reads exactly the maximum rated output current.
- Read and record voltage indicated on differential voltmeter.

f. Short out load resistor (R_L) by closing switch S1.

g. Reading on differential voltmeter should not vary from reading recorded in step e by more than the following (variations expressed in mVdc):

| Model | 6282A | 6285A | 6286A | 6290A | 6291A | 6296A |
|-----------|------------|------------|------------|-------------|------------|-------------|
| Variation | ± 0.60 | ± 2.20 | ± 0.60 | ± 0.830 | ± 0.70 | ± 0.830 |

5-23 Line Regulation. To check the line regulation, proceed as follows:

- Utilize test setup shown in Figure 5-4 leaving switch S1 open throughout test.
- Connect variable auto transformer between input power source and power supply power input.
- Adjust auto transformer for 105VAC input.
- Turn VOLTAGE controls fully clockwise.
- Set METER switch to highest current range and turn on supply.
- Adjust CURRENT controls until front panel meter reads exactly the maximum rated output current.

g. Read and record voltage indicated on differential voltmeter.

h. Adjust variable auto transformer for 125 VAC input.

i. Reading on differential voltmeter should not vary from reading recorded in step g by more than the following (variations expressed in mVdc):

| Model | 6282A | 6285A | 6286A | 6290A | 6291A | 6296A |
|-----------|------------|------------|------------|-------------|------------|-------------|
| Variation | ± 0.60 | ± 2.20 | ± 0.60 | ± 0.830 | ± 0.70 | ± 0.830 |

5-24 Ripple and Noise. To check the ripple and noise, proceed as follows:

- Use test setup shown in Figure 5-4, except connect AC voltmeter across sampling resistor instead of differential voltmeter.
 - Rotate VOLTAGE controls fully clockwise.
 - Set METER switch to highest current range and turn on supply.
 - Adjust CURRENT controls until front panel meter indicates exactly the maximum rated output current.
 - Turn range switch on AC voltmeter to 1mV position.
 - The AC voltmeter should read as follows: (Readings are expressed in mVac)
- | Model | 6282A | 6285A | 6286A | 6290A | 6291A | 6296A |
|---------|-------|-------|-------|-------|-------|-------|
| Reading | 0.50 | 0.60 | 0.50 | 1.0 | 0.6 | 1.0 |

5-25 TROUBLESHOOTING

5-26 Components within Hewlett-Packard power supplies are conservatively operated to provide maximum reliability. In spite of this, parts within a supply may fail. Usually the instrument must be immediately repaired with a minimum of "down time" and a systematic approach as outlined in succeeding paragraphs can greatly simplify and speed up the repair.

5-27 TROUBLE ANALYSIS

5-28 General. Before attempting to trouble shoot this instrument, ensure that the fault is with the instrument and not with an associated circuit. The performance test (Paragraph 5-10) enables this to be determined without having to remove the instrument from the cabinet.

5-29 Once it is determined that the power supply is at fault, check for obvious troubles such as open fuse, a defective power cable, or an input power failure. Next, remove the top and bottom covers (each held by four retaining screws) and inspect for open connections, charred components, etc. If the trouble source cannot be detected by visual inspection, follow the detailed procedure outlined in succeeding paragraphs. Once the defective component has been located (by means of visual inspection or trouble analysis) correct it and re-conduct the performance test. If a component is replaced, refer to the repair and replacement and adjustment and calibration paragraphs in this section.

5-30 A good understanding of the principles of operation is a helpful aid in troubleshooting, and it is recommended that the reader review Section IV of the manual before attempting to troubleshoot the unit in detail. Once the principles of operation are understood, logical application of this knowledge used in conjunction with the normal voltage readings and waveforms shown on the schematic and the additional procedures given in the following paragraphs should suffice to isolate a fault to a component or small group of components. The component location diagram at the rear of the manual can be consulted to determine the location of components and test points. The normal voltages shown on the schematic are positioned adjacent to the applicable test points (identified by encircled numbers on the schematic and component location diagram). Additional test procedures that will aid in isolating troubles are as follows:

a. Reference circuit check (Paragraph 5-31). This circuit provides critical operating voltages for the supply and faults in the circuit could affect the overall operation in many ways. This circuit should be checked first, before proceeding to other areas of the unit.

b. Series regulator and preregulator feedback loop checks (Paragraph 5-32).

c. Procedures for dealing with common troubles (Paragraph 5-33).

5-31 Reference Circuit.

a. Make an ohmmeter check to be certain that neither the positive nor negative output terminal is grounded.

b. Turn front-panel VOLTAGE and CURRENT controls fully clockwise (maximum).

c. Turn on power supply (no load connected).

d. Proceed as instructed in Table 5-2.

5-32 Series Regulator and Preregulator Feedback Circuits. Generally, malfunction of these two feedback circuits is indicated by high or low (or no) output voltage. If one of these situations occur, disconnect the load and proceed as instructed in Table 5-3 or 5-4. Preregulator waveforms are included on the schematic at the rear of the manual.

5-33 Common Troubles. Table 5-6 lists the symptoms, checks, and probable causes for common troubles.

5-34 REPAIR AND REPLACEMENT

5-35 Before servicing a printed wiring board, refer to Figure 5-10. Section VI of this manual contains a list of replaceable parts. Before replacing a semiconductor device, refer to Table 5-7 which lists the special characteristics of selected semiconductors. If the device to be replaced is not listed in Table 5-7, the standard manufacturers part number listed in Section VI is applicable. After replacing a semiconductor device, refer to Table 5-8 for checks and adjustments that may be necessary.

Table 5-2. Reference Circuit Troubleshooting

| Step | Meter Common | Meter Positive | Normal Indication | If Indication Abnormal, Take This Action |
|------|--------------|----------------|-------------------|--|
| 1 | +S | 29 | 9.4 ±0.4Vdc | Check 15.4 volt bias or VR600 |
| 2 | 28 | +S | 6.2 ±0.3Vdc | Check diode VR601 |
| 3 | +S | 30 | 15.4 ±0.5Vdc | Check R605, Q600 through Q603, C600, CR600, and CR601. |

Table 5-3. High Output Voltage Troubleshooting

| Step | Measure | Response | Probable Cause |
|------|-------------------------------|--|--|
| 1 | Voltage between TP26 and TP90 | a. 0V or negative b. More positive than 0V | a. Q400 (Q401) shorted CR400 shorted b. Q303 open or R309 shorted Proceed to Step 2 |
| 2 | Voltage between +S and A4 | a. 0V to +0.8V b. More negative than 0V | a. Open strap A3—A4 R813 or R814 open R805 or R806 shorted b. Proceed to Step 3 |
| 3 | Voltage between +S and 11 | a. More positive than +1.5V b. +0.9V to +1.5V | a. Q100B shorted Q100A open b. Proceed to Step 4 |
| 4 | Voltage between +S and 21 | a. More negative than 0V | a. Q302 open Q301 open R305, R300 shorted |

Table 5-4. Low Output Voltage Troubleshooting

| Step | Measure | Response | Probable Cause |
|------|-------------------------------------|--|---|
| 1 | Voltage between TP26 and TP90 | a. More positive than 0V b. 0V or negative | a. Proceed to Step 2 b. Proceed to Step 3 |
| 2 | Voltage between TP90 and TP27 | a. Less positive than +4V b. More positive than +5V | a. Check fuse F1. If blown check CR502 or CR504 for short. If not blown, proceed to Table 5-5. b. Q400 (Q401) open Proceed to Step 3 |
| 3 | Disable Q200 by disconnecting CR200 | a. Normal output voltage b. Low output voltage | a. Constant Current circuit faulty; check Q200B, R810, R809, for short. b. If supply is furnishing current without load, check CR809, C802, or C803 for short. If it is not, proceed to Step 3 |
| 4 | Voltage between +S and A4 | a. More negative than 0V | a. Open strap A4—A5 R813, R814, C801 Proceed to Step 5 |

Table 5-4. Low Output Voltage Troubleshooting (Continued)

| Step | Measure | Response | Probable Cause |
|------|---------------------------|--|--|
| 5 | Voltage between +S and 11 | a. Less positive than +0.9V b. +0.9V to +1.5V | a. Q100B open Q100A shorted Q802 or Q801 shorted b. Proceed to Step 6 |
| 6 | Voltage between +S and 21 | a. 0V or positive | a. Q303 shorted Q302 shorted R310 shorted |

Table 5-5. Preregulator/Control Circuit Troubleshooting

| Step | Measure | Response | Probable Cause |
|------|----------------------------------|--|---|
| 1 | Waveform between 4 and 3 of T700 | a. Normal firing pulse b. No or abnormal firing pulse | a. CR502-CR504 defective R501-R502 open CR501, CR503, T800 defective b. T700 open CR500 shorted Proceed to Step 2 |
| 2 | Waveform between 90 and 47 | a. Zero or small positive voltage b. +16 to +20 Volt level c. Waveform distorted | a. Q700 shorted C703 shorted Q701 open R703, primary T700 open Proceed to Step 3 b. Q700 open R703 shorted Q701 shorted Proceed to Step 3 c. Proceed to Step 3 |
| 3 | Waveform between 90 and 59 | a. Amplitude incorrect b. Period incorrect | a. Q702 defective R707, R708, R713 incorrect value or open C700, CR710, C711 defective b. CR709 defective Proceed to Step 4 |
| 4 | Waveform between 90 and 52 | a. Amplitude incorrect b. Period incorrect | a. CR708, CR709, R702 defective b. CR700 through CR703 defective |
| 5 | Waveform between 90 and 54 | a. Amplitude incorrect b. Period incorrect | a. R700, R701, C701 defective b. CR704 through CR707 defective |

Table 5-6. Common Troubles

| Symptom | Checks and Probable Causes |
|--|---|
| High ripple | <ul style="list-style-type: none"> a. Check operating setup for ground loops. b. If output floating, connect 1μf capacitor between output and ground. c. Ensure that supply is not crossing over to constant current mode under loaded conditions. d. Check for low voltage across C500 or Q400. e. Check for excessive ripple on reference voltages. Peak-to-peak ripple should be less than 2mV for +9.4V and -6.2V and less than 4mV for +15.4V. |
| Poor line regulation | <ul style="list-style-type: none"> a. Check reference circuit (Paragraph 5-31). |
| Poor load regulation (Constant Voltage) | <ul style="list-style-type: none"> a. Measurement technique. (Paragraph 5-16.) b. Check reference circuit (Paragraph 5-31). c. Ensure that supply is not going into current limit. Check constant current input circuit. |
| Poor load regulation (Constant Current) | <ul style="list-style-type: none"> a. Check reference circuit (Paragraph 5-31). b. C802, C803, and CR809 leaky. c. Ensure that supply is not crossing over to constant voltage operation. Check constant voltage input circuit. |
| Oscillates (Constant Voltage / Constant Current) | <ul style="list-style-type: none"> a. Check C301 for open, adjustment of R307 (Paragraph 5-50). b. Check R103, C100 or R304, C300. |
| Poor Stability (Constant Voltage) | <ul style="list-style-type: none"> a. Check reference voltages (Paragraph 5-31). b. Noisy programming resistors R813, R814. c. CR100, CR101 leaky. d. Check R104, R805, R806, C801 for noise or drift. e. Stage Q100 defective. |
| Poor Stability (Constant Current) | <ul style="list-style-type: none"> a. Check reference voltages (Paragraph 5-31). b. Noisy programming resistors R809, R810. c. CR809, C803, C802 leaky. d. Check R807, R808, R200, R800, for noise or drift. e. Stage Q200 defective. |

Table 5-7. Selected Semiconductor Characteristics

| Reference Designator | Characteristics | Ⓢ Stock No. | Suggested Replacement |
|----------------------|---|-------------|-----------------------|
| Q100, Q200 | Matched differential amplifier. NPN Si Planar. 70 (min.) h _{FE} I _C = 1 mA. V _{CE} = 5V. I _{CO} 0.01 μ A @ V _{CB0} = 5V. | 1854-0229 | 2N2917 G. E. |
| Q303, Q400 (Q401) | NPN power. h _{FE} = 35 (min); @ I _C = 4A, V _{CE} = 4V. | 1854-0225 | 2N3055 R. C. A. |
| Q851 | Matched differential amplifier. NPN Si. | 1854-0221 | 2N4045 Union Carbide |

Table 5-7. Selected Semiconductor Characteristics (Continued)

| | | | |
|---|------------------------------------|-----------|-----------------|
| CR100-CR102, CR200, CR300, CR301, CR500, CR700, CR701 | Si diode, 200 mA, 200 prv | 1901-0033 | 1N485B Sylvania |
| CR402, CR602, CR803-CR806 | Si Stabistor, 200 mA, 15 prv | 1901-0461 | 1N4828 G. E. |
| VR300 | Zener diode, 4. 22V, ±5% 400 mw | 1902-3070 | 1N749 Motorola |

Table 5-8. Checks and Adjustments After Replacement of Semiconductor Devices

| Reference | Function | Check | Adjust |
|---------------------------|---|--|---------------------|
| Q100 | Constant voltage differential amplifier | Constant voltage (CV) line and load regulation. | |
| Q200 | Constant current differential amplifier | Constant current (CC) line and load regulation. | |
| Q300 | Constant Current gating amplifier | CC load regulation. | |
| Q301 | Constant Voltage gating amplifier | CV load regulation. | |
| Q302, Q303 | Error amplifiers | CV/CC load regulation Transient response | R307 |
| Q400 (Q401) | Series Regulator | CV/CC load regulation | |
| Q600, Q601, Q602, Q603 | Reference regulator | Reference voltages. Overvoltage trip point. | R604 |
| Q700, Q701 Q702 | SCR control | Voltage across series regulator | R711 |
| Q851, Q852, Q853 | Meter amplifiers | Meter zero. Voltmeter/ Ammeter tracking | R870, R865, R855 |
| Q801, Q802 | Overcurrent detectors | Short output, ensure that output goes to zero without damage to series regulator. | |
| CR100, CR101 | Limiting diodes | CV load regulation | |
| CR403, CR404 | Forward bias regulator | Voltage across each diode 0. 6 to 0. 9 volts. | |
| CR700-CR703 | Rectifier bridge | Waveform between 52 and 90 | |
| CR704-CR707 | Rectifier bridge | Waveform between 54 and 90 | |

Excessive heat or pressure can lift the copper strip from the board. Avoid damage by using a low power soldering iron (50 watts maximum) and following these instructions. Copper that lifts off the board should be cemented in place with a quick drying acetate base cement having good electrical insulating properties.

A break in the copper should be repaired by soldering a short length of tinned copper wire across the break.

Use only high quality rosin core solder when repairing etched circuit boards. NEVER USE PASTE FLUX. After soldering, clean off any excess flux and coat the repaired area with a high quality electrical varnish or lacquer.

When replacing components with multiple mounting pins such as tube sockets, electrolytic capacitors, and potentiometers, it will be necessary to lift each pin slightly, working around the components several times until it is free.

WARNING: If the specific instructions outlined in the steps below regarding etched circuit boards without eyelets are not followed, extensive damage to the etched circuit board will result.

1. Apply heat sparingly to lead of component to be replaced. If lead of component passes through an eyelet

in the circuit board, apply heat on component side of board. If lead of component does not pass through an

eyelet, apply heat to conductor side of board.

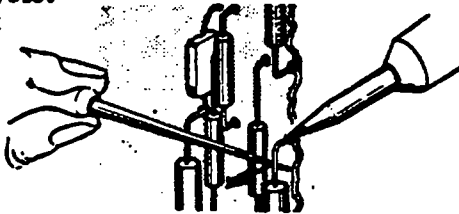

2. Reheat solder in vacant eyelet and quickly insert a small awl to clean inside of hole.

If hole does not have an eyelet, insert awl or a #57 drill from conductor side of board.

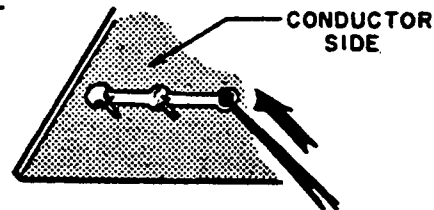

3. Bend clean tinned lead on new part and carefully insert through eyelets or holes in board.

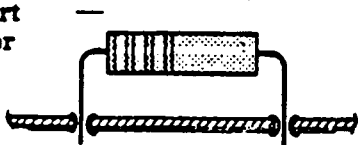

4. Hold part against board (avoid overheating) and solder leads.

Apply heat to component leads on correct side of board as explained in step 1.

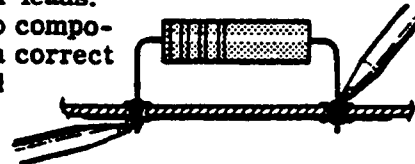

In the event that either the circuit board has been damaged or the conventional method is impractical, use method shown below. This is especially applicable for circuit boards without eyelets.

1. Clip lead as shown below.

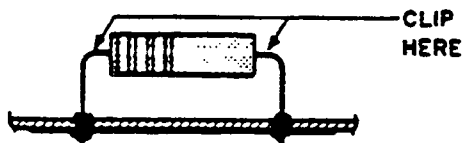

2. Bend protruding leads upward. Bend lead of new component

APPLY SOLDER around protruding lead. Apply solder using a pair of long nose pliers as a heat sink.

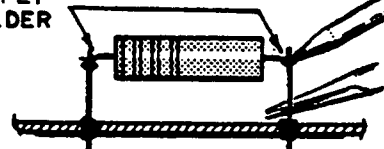

This procedure is used in the field only as an alternate means of repair. It is not used within the factory.

Figure 5-10. Servicing Printed Wiring Boards

Table 5-8. Checks and Adjustments After Replacement of Semiconductor Devices (Continued)

| | | | |
|---|--------------------|---|--|
| CR600, CR601, CR800, CR801, CR501-CR504 | Rectifier diodes | Voltage across appropriate filter capacitor | |
| VR600, VR601 | Reference voltages | Check +9.4V and -6.2V reference voltages | |

Table 5-9. Calibration Adjustment Summary

| Adjustment or Calibration | Paragraph | Control Device |
|-------------------------------|-----------|----------------|
| Meter Zero | 5-38 | Pointer |
| Voltmeter Tracking | 5-40 | R870 and R865 |
| Ammeter Tracking | 5-42 | R855 |
| "Voltage" Programming Current | 5-44 | R806 |
| "Current" Programming Current | 5-46 | R808 |
| Overtoltage Trip | 5-48 | R604 |
| Transient Response | 5-50 | R307 |
| Preregulator Tracking | 5-52 | R711 |

5-36 ADJUSTMENT AND CALIBRATION

5-37 Adjustment and calibration may be required after performance testing, troubleshooting, or repair and replacement. Perform only those adjustments that affect the operation of the faulty circuit and no others. Table 5-9 summarizes the adjustments and calibrations contained in the following paragraphs.

5-38 METER ZERO

5-39 Proceed as follows to zero meter:

- a. Turn off instrument (after it has reached normal operating temperature) and allow 30 seconds for all capacitors to discharge.
- b. Insert sharp pointed object (pen point or awl) into the small indentation near top of round black plastic disc located directly below meter face.
- c. Rotate plastic disc clockwise (cw) until meter reads zero, then rotate ccw slightly in order to free adjustment screw from meter suspension. If pointer moves, repeat steps b and c.

5-40 VOLTMETER TRACKING

5-41 To calibrate voltmeter tracking, proceed as follows:

- a. To electrically zero meter, set METER switch to highest current position and, with supply off and no load connected, adjust R870 until front panel meter reads zero.
- b. Connect differential voltmeter across supply, observing correct polarity.
- c. Set METER switch to highest voltage range and turn on supply. Adjust VOLTAGE control until differential voltmeter reads exactly the maximum rated output voltage.
- d. Adjust R865 until front panel meter also indicates maximum rated output voltage.

5-42 AMMETER TRACKING

5-43 To calibrate ammeter tracking, proceed as follows:

- a. Zero meter as described in step a of 5-41. Connect test setup shown on Figure 5-4 leaving switch S1 open.
- b. Turn VOLTAGE control fully clockwise and set METER switch to highest current range.
- c. Turn on supply and adjust CURRENT controls until differential voltmeter reads 1.0Vdc.
- d. Adjust R855 until front panel meter indicates exactly the maximum rated output current.

5-44 CONSTANT VOLTAGE PROGRAMMING CURRENT

5-45 To calibrate the constant voltage programming current, proceed as follows:

a. Connect a 0.1%, 20 watt resistor between terminals -S and A4 on rear barrier strip. Resistor value to be as follows:

| | | | | | | |
|--------------|-------|-------|-------|-------|-------|-------|
| <u>Model</u> | 6282A | 6285A | 6286A | 6290A | 6291A | 6296A |
| Res. | 2K | 4K | 4K | 8K | 8K | 18K |

b. Disconnect jumper between A3 and A4 on rear terminal barrier strip.

c. Connect a decade resistance in place of R806.

d. Connect a differential voltmeter between +S and -S and turn on supply.

e. Adjust decade resistance box so that differential voltmeter indicates maximum rated output voltage within the following tolerances:

| | | | | | | |
|--------------|-------|-------|-------|-------|-------|-------|
| <u>Model</u> | 6282A | 6285A | 6286A | 6290A | 6291A | 6296A |
| Tol.(Vdc) | ±0.2 | ±0.4 | ±0.4 | ±0.8 | ±0.8 | ±1.2 |

f. Replace decade resistance with resistor of appropriate value in R806 position.

5-46 CONSTANT CURRENT PROGRAMMING CURRENT

5-47 To calibrate the constant current programming current, proceed as follows:

a. Connect power supply as shown in Fig. 5-4.

b. Remove strap between A6 and A7 (leaving A7 and A8 jumpered).

c. Connect a 0.1%, 1/2 watt resistor between A1 and A7. Resistor value is 1K Ω (1.5K Ω for Models 6290A and 6296A).

d. Connect decade resistance box in place of R808.

e. Set METER switch to highest current range and turn on supply.

f. Adjust the decade resistance so that the differential voltmeter indicates 1.0 ± 0.02 Vdc.

g. Replace decade resistance with appropriate value resistor in R808 position.

5-48 OVERVOLTAGE TRIP

5-49 To adjust the overvoltage trip point, proceed as follows:

a. Connect differential voltmeter across +S and -S terminals of supply.

b. Rotate VOLTAGE controls fully clockwise.

c. Turn on unit. Differential voltmeter should read 20% above maximum rated output voltage within ±5%.

d. If it does not, turn off supply and connect decade resistance across R605 in place of R604.

e. Adjust decade resistance until differential voltmeter reads that indicated in step c.

NOTE

The +15.4V reference voltage must be kept within ±0.5Vdc when adjusting the decade resistance box.

f. Replace decade resistance with resistor of appropriate value in R604 position.

5-50 TRANSIENT RECOVERY TIME

5-51 To adjust the transient response, proceed as follows:

a. Connect test setup as shown in Figure 5-7.

b. Repeat steps a through e as outlined in Paragraph 5-19.

c. Adjust R307 so that the transient response is as shown in Figure 5-8.

5-52 PREREGULATOR TRACKING (60Hz OPERATION)

5-53 To adjust the preregulator control circuit with a 60Hz ac input, proceed as follows:

a. Connect proper load resistor across output terminals of supply. Resistance value to be as follows:

| | | | | | | |
|--------------|------------|------------|------------|-------------|------------|-------------|
| <u>Model</u> | 6282A | 6285A | 6286A | 6290A | 6291A | 6296A |
| Res. | 1 Ω | 4 Ω | 2 Ω | 13 Ω | 8 Ω | 20 Ω |

b. Connect DC voltmeter between TP27 and TP90 (across series regulator).

c. Turn on supply and adjust VOLTAGE controls for maximum rated output voltage.

d. Adjust R711 so that DC voltmeter reads 3 ± 0.2 Vdc.

5-54 PREREGULATOR TRACKING (50Hz OPERATION)

5-55 To adjust the preregulator control circuit when the ac input is from a 50Hz source, proceed as follows:

a. Connect load resistor across rear output terminal of supply. Resistor value to be as follows:

| | | | | | | |
|--------------|------------|------------|------------|-------------|------------|-------------|
| <u>Model</u> | 6282A | 6285A | 6286A | 6290A | 6291A | 6296A |
| Res. | 1 Ω | 4 Ω | 2 Ω | 13 Ω | 8 Ω | 20 Ω |

b. Connect oscilloscope (dc coupled) across series regulator, T. P. 27 to T. P. 90.

c. Disconnect R709 in the SCR control circuit, and connect decade resistance box in its place.

d. Rotate CURRENT controls fully clockwise and turn on supply.

e. Decrease resistance of decade resistance from normal value of R709 until sawtooth waveform on oscilloscope is symmetrical (amplitude of 50Hz sawtooth waves are equal).

f. Replace decade resistance box with appropriate value resistor in R709 position.

g. Adjust ramp potentiometer R711 for 3.5Vdc drop across series regulator.

h. If 3.5 volts cannot be obtained, remove R712 (in series with R711) and connect the decade resistance box in its place.

i. Increase value of decade resistance box from normal value of R712 until 3.5Vdc drop is obtained across series regulator.

j. Remove decade resistance and connect new resistance value in R712 position.

SECTION VI REPLACEABLE PARTS

6-1 INTRODUCTION

6-2 This section contains information for ordering replacement parts. Table 6-4 lists parts in alphanumeric order by reference designators and provides the following information:

- a. Reference Designators. Refer to Table 6-1.
- b. Description. Refer to Table 6-2 for abbreviations.
- c. Total Quantity (TQ). Given only the first time the part number is listed except in instruments containing many sub-modular assemblies, in which case the TQ appears the first time the part number is listed in each assembly.
- d. Manufacturer's Part Number or Type.
- e. Manufacturer's Federal Supply Code Number. Refer to Table 6-3 for manufacturer's name and address.
- f. Hewlett-Packard Part Number.
- g. Recommended Spare Parts Quantity (RS) for complete maintenance of one instrument during one year of isolated service.
- h. Parts not identified by a reference designator are listed at the end of Table 6-4 under Mechanical and/or Miscellaneous. The former consists of parts belonging to and grouped by individual assemblies; the latter consists of all parts not immediately associated with an assembly.

6-3 ORDERING INFORMATION

6-4 To order a replacement part, address order or inquiry to your local Hewlett-Packard sales office (see lists at rear of this manual for addresses). Specify the following information for each part: Model, complete serial number, and any Option or special modification (J) numbers of the instrument; Hewlett-Packard part number; circuit reference designator; and description. To order a part not listed in Table 6-4, give a complete description of the part, its function, and its location.

Table 6-1. Reference Designators

| | |
|-------------------------------|-------------------|
| A = assembly | E = miscellaneous |
| B = blower (fan) | electronic part |
| C = capacitor | F = fuse |
| CB = circuit breaker | J = jack, jumper |
| CR = diode | K = relay |
| DS = device, signaling (lamp) | L = inductor |
| | M = meter |

Table 6-1. Reference Designators (Continued)

| | |
|---------------------|---|
| P = plug | V = vacuum tube, neon bulb, photocell, etc. |
| Q = transistor | |
| R = resistor | VR = zener diode |
| S = switch | X = socket |
| T = transformer | Z = integrated circuit or network |
| TB = terminal block | |
| TS = thermal switch | |

Table 6-2. Description Abbreviations

| | |
|----------------------------------|----------------------------------|
| A = ampere | mfr = manufacturer |
| ac = alternating current | mod. = modular or modified |
| assy. = assembly | mtg = mounting |
| bd = board | n = nano = 10^{-9} |
| bkt = bracket | NC = normally closed |
| °C = degree Centigrade | NO = normally open |
| cd = card | NP = nickel-plated |
| coef = coefficient | Ω = ohm |
| comp = composition | obd = order by description |
| CRT = cathode-ray tube | OD = outside diameter |
| CT = center-tapped | p = pico = 10^{-12} |
| dc = direct current | P.C. = printed circuit |
| DPDT = double pole, double throw | pot. = potentiometer |
| DPST = double pole, single throw | p-p = peak-to-peak |
| elect = electrolytic | ppm = parts per million |
| encap = encapsulated | pvr = peak reverse voltage |
| F = farad | rect = rectifier |
| °F = degree Fahrenheit | rms = root mean square |
| fxd = fixed | Si = silicon |
| Ge = germanium | SPDT = single pole, double throw |
| H = Henry | SPST = single pole, single throw |
| Hz = Hertz | SS = small signal |
| IC = integrated circuit | T = slow-blow |
| ID = inside diameter | tan. = tantalum |
| incnd = incandescent | Ti = titanium |
| k = kilo = 10^3 | V = volt |
| m = milli = 10^{-3} | var = variable |
| M = mega = 10^6 | ww = wirewound |
| μ = micro = 10^{-6} | W = Watt |
| met. = metal | |

Table 6-3. Code List of Manufacturers

| CODE NO. | MANUFACTURER | ADDRESS |
|----------|--|-----------------------|
| 00629 | EBY Sales Co., Inc. | Jamaica, N. Y. |
| 00656 | Aerovox Corp. | New Bedford, Mass. |
| 00853 | Sangamo Electric Co. S. Carolina Div. | Pickens, S. C. |
| 01121 | Allen Bradley Co. | Milwaukee, Wis. |
| 01255 | Litton Industries, Inc. | Beverly Hills, Calif. |
| 01281 | TRW Semiconductors, Inc. | Lawndale, Calif. |
| 01295 | Texas Instruments, Inc. Semiconductor-Components Div. | Dallas, Texas |
| 01686 | RCL Electronics, Inc. | Manchester, N. H. |
| 01930 | Amerock Corp. | Rockford, Ill. |
| 02107 | Sparta Mfg. Co. | Dover, Ohio |
| 02114 | Ferrocube Corp. | Saugerties, N. Y. |
| 02606 | Fenwal Laboratories | Morton Grove, Ill. |
| 02660 | Amphenol Corp. | Broadview, Ill. |
| 02735 | Radio Corp. of America, Solid State and Receiving Tube Div. | Somerville, N. J. |
| 03508 | G. E. Semiconductor Products Dept. | Syracuse, N. Y. |
| 03797 | Eldema Corp. | Compton, Calif. |
| 03877 | Transitron Electronic Corp. | Wakefield, Mass. |
| 03888 | Pyrofilm Resistor Co. Inc. | Cedar Knolls, N. J. |
| 04009 | Arrow, Hart and Hegeman Electric Co. | Hartford, Conn. |
| 04072 | ADC Electronics, Inc. | Harbor City, Calif. |
| 04213 | Caddell & Burns Mfg. Co. Inc. | Mineola, N. Y. |
| 04404 | *Hewlett-Packard Co. Palo Alto Div. | Palo Alto, Calif. |
| 04713 | Motorola Semiconductor Prod. Inc. | Phoenix, Arizona |
| 05277 | Westinghouse Electric Corp. Semiconductor Dept. | Youngwood, Pa. |
| 05347 | Ultronix, Inc. | Grand Junction, Colo. |
| 05820 | Wakefield Engr. Inc. | Wakefield, Mass. |
| 06001 | General Elect. Co. Electronic Capacitor & Battery Dept. | Irmo, S. C. |
| 06004 | Bassik Div. Stewart-Warner Corp. | Bridgeport, Conn. |
| 06486 | IRC Div. of TRW Inc. Semiconductor Plant | Lynn, Mass. |
| 06540 | Amatom Electronic Hardware Co. Inc. | New Rochelle, N. Y. |
| 06555 | Beede Electrical Instrument Co. | Penacook, N. H. |
| 06666 | General Devices Co. Inc. | Indianapolis, Ind. |
| 06751 | Semcor Div. Components, Inc. | Phoenix, Arizona |
| 06776 | Robinson Nugent, Inc. | New Albany, Ind. |
| 06812 | Torrington Mfg. Co., West Div. | Van Nuys, Calif. |
| 07137 | Transistor Electronics Corp. | Minneapolis, Minn. |

| CODE NO. | MANUFACTURER | ADDRESS |
|----------|---|-----------------------|
| 07138 | Westinghouse Electric Corp. Electronic Tube Div. | Elmira, N. Y. |
| 07263 | Fairchild Camera and Instrument Corp. Semiconductor Div. | Mountain View, Calif. |
| 07387 | Birtcher Corp., The | Los Angeles, Calif. |
| 07397 | Sylvania Electric Prod. Inc. Sylvania Electronic Systems Western Div. | Mountain View, Calif. |
| 07716 | IRC Div. of TRW Inc. Burlington Plant | Burlington, Iowa |
| 07910 | Continental Device Corp. | Hawthorne, Calif. |
| 07933 | Raytheon Co. Components Div. Semiconductor Operation | Mountain View, Calif. |
| 08484 | Breeze Corporations, Inc. | Union, N. J. |
| 08530 | Reliance Mica Corp. | Brooklyn, N. Y. |
| 08717 | Sloan Company, The | Sun Valley, Calif. |
| 08730 | Vemaline Products Co. Inc. | Wyckoff, N. J. |
| 08806 | General Elect. Co. Minia- ture Lamp Dept. | Cleveland, Ohio |
| 08863 | Nylomatic Corp. | Norrisville, Pa. |
| 08919 | RCH Supply Co. | Vernon, Calif. |
| 09021 | Airco Speer Electronic Components | Bradford, Pa. |
| 09182 | *Hewlett-Packard Co. New Jersey Div. | Rockaway, N. J. |
| 09213 | General Elect. Co. Semiconductor Prod. Dept. | Buffalo, N. Y. |
| 09214 | General Elect. Co. Semiconductor Prod. Dept. | Auburn, N. Y. |
| 09353 | C & K Components Inc. | Newton, Mass. |
| 09922 | Burndy Corp. | Norwalk, Conn. |
| 11115 | Wagner Electric Corp. Tung-Sol Div. | Bloomfield, N. J. |
| 11236 | CTS of Berne, Inc. | Berne, Ind. |
| 11237 | Chicago Telephone of Cal. Inc. | So. Pasadena, Calif. |
| 11502 | IRC Div. of TRW Inc. Boone Plant | Boone, N. C. |
| 11711 | General Instrument Corp Rectifier Div. | Newark, N. J. |
| 12136 | Philadelphia Handle Co. Inc. | Camden, N. J. |
| 12615 | U. S. Terminals, Inc. | Cincinnati, Ohio |
| 12617 | Hamlin Inc. | Lake Mills, Wisconsin |
| 12697 | Clarostat Mfg. Co. Inc. | Dover, N. H. |
| 13103 | Thermalloy Co. | Dallas, Texas |
| 14493 | *Hewlett-Packard Co. Loveland Div. | Loveland, Colo. |
| 14655 | Cornell-Dubilier Electronics Div. Federal Pacific Electric Co. | Newark, N. J. |
| 14936 | General Instrument Corp. Semicon- ductor Prod. Group | Hicksville, N. Y. |
| 15801 | Fenwal Elect. | Framingham, Mass. |
| 16299 | Corning Glass Works, Electronic Components Div. | Raleigh, N. C. |

*Use Code 28480 assigned to Hewlett-Packard Co., Palo Alto, California

Table 6-3. Code List of Manufacturers (Continued)

| CODE NO. | MANUFACTURER | ADDRESS | CODE NO. | MANUFACTURER | ADDRESS |
|----------|---|----------------------------|----------|--|-----------------------|
| 16758 | Delco Radio Div. of General Motors Corp. | Kokomo, Ind. | 70563 | Amperite Co. Inc. | Union City, N.J. |
| 17545 | Atlantic Semiconductors, Inc. | Asbury Park, N.J. | 70901 | Beemer Engrg. Co. | Fort Washington, Pa. |
| 17803 | Fairchild Camera and Instrument Corp Semiconductor Div. Transducer Plant | Mountain View, Calif. | 70903 | Belden Corp. | Chicago, Ill. |
| 17870 | Daven Div. Thomas A. Edison Industries McGraw-Edison Co. | Orange, N.J. | 71218 | Bud Radio, Inc. | Willoughby, Ohio |
| 18324 | Signetics Corp. | Sunnyvale, Calif. | 71279 | Cambridge Thermionic Corp. | Cambridge, Mass. |
| 19315 | Bendix Corp. The Navigation and Control Div. | Teterboro, N.J. | 71400 | Bussmann Mfg. Div. of McGraw & Edison Co. | St. Louis, Mo. |
| 19701 | Electra/Midland Corp. | Mineral Wells, Texas | 71450 | CTS Corp. | Elkhart, Ind. |
| 21520 | Fansteel Metallurgical Corp. | No. Chicago, Ill. | 71468 | I. T. T. Cannon Electric Inc. | Los Angeles, Calif. |
| 22229 | Union Carbide Corp. Electronics Div. | Mountain View, Calif. | 71590 | Globe-Union Inc. Centralab Div. | Milwaukee, Wis. |
| 22753 | UID Electronics Corp. | Hollywood, Fla. | 71700 | General Cable Corp. Cornish Wire Co. Div. | Williamstown, Mass. |
| 23936 | Pamotor, Inc. | Pampa, Texas | 71707 | Coto Coil Co. Inc. | Providence, R. I. |
| 24446 | General Electric Co. | Schenectady, N.Y. | 71744 | Chicago Miniature Lamp Works | Chicago, Ill. |
| 24455 | General Electric Co. Lamp Div. of Con- sumer Prod. Group | Nela Park, Cleveland, Ohio | 71785 | Cinch Mfg. Co. and Howard B. Jones Div. | Chicago, Ill. |
| 24655 | General Radio Co. | West Concord, Mass. | 71984 | Dow Corning Corp. | Midland, Mich. |
| 24681 | LTV Electrosystems Inc Memcor/Com- ponents Operations | Huntington, Ind. | 72136 | Electro Motive Mfg. Co. Inc. | Willimantic, Conn. |
| 26982 | Dynacool Mfg. Co. Inc. | Saugerties, N.Y. | 72619 | Dialight Corp. | Brooklyn, N.Y. |
| 27014 | National Semiconductor Corp. | Santa Clara, Calif. | 72699 | General Instrument Corp. | Newark, N.J. |
| 28480 | Hewlett-Packard Co. | Palo Alto, Calif. | 72765 | Drake Mfg. Co. | Harwood Heights, Ill. |
| 28520 | Heyman Mfg. Co. | Kenilworth, N.J. | 72962 | Elastic Stop Nut Div. of Amerace Esna Corp. | Union, N.J. |
| 28875 | IMC Magnetics Corp. New Hampshire Div. | Rochester, N. H. | 72982 | Erie Technological Products Inc. | Erie, Pa. |
| 31514 | SAE Advance Packaging, Inc. | Santa Ana, Calif. | 73096 | Hart Mfg. Co. | Hartford, Conn. |
| 31827 | Budwig Mfg. Co. | Ramona, Calif. | 73138 | Beckman Instruments Inc. Helipot Div. | Fullerton, Calif. |
| 33173 | G. E. Co. Tube Dept. | Owensboro, Ky. | 73168 | Fenwal, Inc. | Ashland, Mass. |
| 35434 | Lectrohm, Inc. | Chicago, Ill. | 73293 | Hughes Aircraft Co. Electron Dynamics Div. | Torrance, Calif. |
| 37942 | P. R. Mallory & Co. Inc. | Indianapolis, Ind. | 73445 | Amperex Electronic Corp. | Hicksville, N.Y. |
| 42190 | Muter Co. | Chicago, Ill. | 73506 | Bradley Semiconductor Corp. | New Haven, Conn. |
| 43334 | New Departure-Hyatt Bearings Div. General Motors Corp. | Sandusky, Ohio | 73559 | Carling Electric, Inc. | Hartford, Conn. |
| 44655 | Ohmite Manufacturing Co. | Skokie, Ill. | 73734 | Federal Screw Products, Inc. | Chicago, Ill. |
| 46384 | Penn Engr. and Mfg. Corp. | Doylestown, Pa. | 74193 | Heinemann Electric Co. | Trenton, N.J. |
| 47904 | Polaroid Corp. | Cambridge, Mass. | 74545 | Hubbell Harvey Inc. | Bridgeport, Conn. |
| 49956 | Raytheon Co. | Lexington, Mass. | 74868 | Amphenol Corp. Amphenol RF Div. | Danbury, Conn. |
| 55026 | Simpson Electric Co. Div. of American Gage and Machine Co. | Chicago, Ill. | 74970 | E. F. Johnson Co. | Waseca, Minn. |
| 56289 | Sprague Electric Co. | North Adams, Mass. | 75042 | IRC Div. of TRW, Inc. | Philadelphia, Pa. |
| 58474 | Superior Electric Co. | Bristol, Conn. | 75183 | *Howard B. Jones Div. of Cinch Mfg. Corp. | New York, N.Y. |
| 58849 | Syntron Div. of FMC Corp. | Homer City, Pa. | 75376 | Kurz and Kasch, Inc. | Dayton, Ohio |
| 59730 | Thomas and Betts Co. | Philadelphia, Pa. | 75382 | Kilka Electric Corp. | Mt. Vernon, N.Y. |
| 61637 | Union Carbide Corp. | New York, N.Y. | 75915 | Littlefuse, Inc. | Des Plaines, Ill. |
| 63743 | Ward Leonard Electric Co. | Mt. Vernon, N.Y. | 76381 | Minnesota Mining and Mfg. Co. | St. Paul, Minn. |
| | | | 76385 | Minor Rubber Co. Inc. | Bloomfield, N.J. |
| | | | 76487 | James Millen Mfg. Co. Inc. | Malden, Mass. |
| | | | 76493 | J. W. Miller Co. | Compton, Calif. |

*Use Code 71785 assigned to Cinch Mfg. Co., Chicago, Ill.

Table 6-3. Code List of Manufacturers (Continued)

| CODE NO. | MANUFACTURER | ADDRESS |
|----------|--|--------------------------|
| 76530 | Cinch | City of Industry, Calif. |
| 76854 | Oak Mfg. Co. Div. of Oak | |
| | Electro/Netics Corp. | Crystal Lake, Ill. |
| 77068 | Bendix Corp., Electrodynamics Div. | |
| | | No. Hollywood, Calif. |
| 77122 | Palnut Co. | Mountainside, N. J. |
| 77147 | Patton-MacGuyer Co. | Providence, R. I. |
| 77221 | Phaotron Instrument and Electronic Co. | |
| | | South Pasadena, Calif. |
| 77252 | Philadelphia Steel and Wire Corp. | |
| | | Philadelphia, Pa. |
| 77342 | American Machine and Foundry Co. | |
| | Potter and Brumfield Div. | Princeton, Ind. |
| 77630 | TRW Electronic Components Div. | |
| | | Camden, N. J. |
| 77764 | Resistance Products Co. | Harrisburg, Pa. |
| 78189 | Illinois Tool Works Inc. Shakeproof Div. | |
| | | Elgin, Ill. |
| 78452 | Everlock Chicago, Inc. | Chicago, Ill. |
| 78488 | Stackpole Carbon Co. | St. Marys, Pa. |
| 78526 | Stanwyck Winding Div. San Fernando | |
| | Electric Mfg. Co. Inc. | Newburgh, N. Y. |
| 78553 | Tinnerman Products, Inc. | Cleveland, Ohio |
| 78584 | Stewart Stamping Corp. | Yonkers, N. Y. |
| 79136 | Waldes Kohinoor, Inc. | L. I. C., N. Y. |
| 79307 | Whitehead Metals Inc. | New York, N. Y. |
| 79727 | Continental-Wirt Electronics Corp. | |
| | | Philadelphia, Pa. |
| 79963 | Zierick Mfg. Co. | Mt. Kisco, N. Y. |
| 80031 | Mepco Div. of Sessions Clock Co. | |
| | | Morristown, N. J. |
| 80294 | Bourns, Inc. | Riverside, Calif. |
| 81042 | Howard Industries Div. of Msl Ind. Inc. | |
| | | Racine, Wisc. |
| 81073 | Grayhill, Inc. | La Grange, Ill. |
| 81483 | International Rectifier Corp. | |
| | | El Segundo, Calif. |
| 81751 | Columbus Electronics Corp. | Yonkers, N. Y. |
| 82099 | Goodyear Sundries & Mechanical Co. Inc. | |
| | | New York, N. Y. |
| 82142 | Airco Speer Electronic Components | |
| | | Du Bois, Pa. |
| 82219 | Sylvania Electric Products Inc. | |
| | Electronic Tube Div. Receiving | |
| | Tube Operations | Emporium, Pa. |
| 82389 | Switchcraft, Inc. | Chicago, Ill. |
| 82647 | Metals and Controls Inc. Control | |
| | Products Group | Attleboro, Mass. |
| 82866 | Research Products Corp. | Madison, Wis. |
| 82877 | Rotron Inc. | Woodstock, N. Y. |
| 82893 | Vector Electronic Co. | Glendale, Calif. |
| 83058 | Carr Fastener Co. | Cambridge, Mass. |
| 83186 | Victory Engineering Corp. | |
| | | Springfield, N. J. |
| 83298 | Bendix Corp. Electric Power Div. | |
| | | Eatontown, N. J. |
| 83330 | Herman H. Smith, Inc. | Brooklyn, N. Y. |
| 83385 | Central Screw Co. | Chicago, Ill. |
| 83501 | Gavitt Wire and Cable Div. of | |
| | Amerace Esna Corp. | Brookfield, Mass. |

| CODE NO. | MANUFACTURER | ADDRESS |
|----------|---|-----------------------|
| 83508 | Grant Pulley and Hardware Co. | |
| | | West Nyack, N. Y. |
| 83594 | Burroughs Corp. Electronic | |
| | Components Div. | Plainfield, N. J. |
| 83835 | U. S. Radium Corp. | Morristown, N. J. |
| 83877 | Yardeny Laboratories, Inc. | |
| | | New York, N. Y. |
| 84171 | Arco Electronics, Inc. | Great Neck, N. Y. |
| 84411 | TRW Capacitor Div. | Ogallala, Neb. |
| 86684 | RCA Corp. Electronic Components | |
| | | Harrison, N. J. |
| 86838 | Rummel Fibre Co. | Newark, N. J. |
| 87034 | Marco & Oak Industries a Div. of Oak | |
| | Electro/netics Corp. | Anaheim, Calif. |
| 87216 | Philco Corp. Lansdale Div. | Lansdale, Pa. |
| 87585 | Stockwell Rubber Co. Inc. | |
| | | Philadelphia, Pa. |
| 87929 | Tower-Olschan Corp. | Bridgeport, Conn. |
| 88140 | Cutler-Hammer Inc. Power Distribution | |
| | and Control Div. Lincoln Plant | |
| | | Lincoln, Ill. |
| 88245 | Litton Precision Products Inc, USECO | |
| | Div. Litton Industries | Van Nuys, Calif. |
| 90634 | Gulton Industries Inc. | Metuchen, N. J. |
| 90763 | United-Car Inc. | Chicago, Ill. |
| 91345 | Miller Dial and Nameplate Co. | |
| | | El Monte, Calif. |
| 91418 | Radio Materials Co. | Chicago, Ill. |
| 91506 | Augat, Inc. | Attleboro, Mass. |
| 91637 | Dale Electronics, Inc. | Columbus, Neb. |
| 91662 | Elco Corp. | Willow Grove, Pa. |
| 91929 | Honeywell Inc. Div. Micro Switch | |
| | | Freeport, Ill. |
| 92825 | Whitso, Inc. | Schiller Pk., Ill. |
| 93332 | Sylvania Electric Prod. Inc. Semi- | |
| | conductor Prod. Div. | Woburn, Mass. |
| 93410 | Essex Wire Corp. Stemco | |
| | Controls Div. | Mansfield, Ohio |
| 94144 | Raytheon Co. Components Div. | |
| | Ind. Components Oper. | Quincy, Mass. |
| 94154 | Wagner Electric Corp. | |
| | Tung-Sol Div. | Livingston, N. J. |
| 94222 | Southco Inc. | Lester, Pa. |
| 95263 | Leecraft Mfg. Co. Inc. | L. I. C., N. Y. |
| 95354 | Methode Mfg. Co. | Rolling Meadows, Ill. |
| 95712 | Bendix Corp. Microwave | |
| | Devices Div. | Franklin, Ind. |
| 95987 | Weckesser Co. Inc. | Chicago, Ill. |
| 96791 | Amphenol Corp. Amphenol | |
| | Controls Div. | Janesville, Wis. |
| 97464 | Industrial Retaining Ring Co. | |
| | | Irvington, N. J. |
| 97702 | IMC Magnetics Corp. Eastern Div. | |
| | | Westbury, N. Y. |
| 98291 | Sealectro Corp. | Mamaroneck, N. Y. |
| 98410 | ETC Inc. | Cleveland, Ohio |
| 98978 | International Electronic Research Corp. | |
| | | Burbank, Calif. |
| 99934 | Renbrandt, Inc. | Boston, Mass. |

| Reference Designator | Description | Quantity | Mfr. Part # or Type | Mfr. | Mfr. Code | Stock No. | RS |
|---|---|----------|---------------------|------------|-----------|-----------|----|
| C100 | fxd, film 0.082 μ f 200V | 1 | 192P82392 | Sprague | 56289 | 0160-0167 | 1 |
| C200 | fxd, film 0.0047 μ f 200V | 1 | 192P47292 | Sprague | 56289 | 0160-0157 | 1 |
| C300 | fxd, film 0.22 μ f 80V | 1 | 192P2249R8 | Sprague | 56289 | 0160-2453 | 1 |
| C302, 301, 303 | fxd, film 0.0022 μ f 200V | 3 | 192P22292 | Sprague | 56289 | 0160-0154 | 1 |
| C500 | fxd, elect 10,000 μ f 75V | 1 | D39062 | HLAB | 09182 | 0180-1924 | 1 |
| C501 | fxd, paper 0.1 μ f 400V | 1 | 160P10494 | Sprague | 56289 | 0160-0013 | 1 |
| C600 | fxd, elect 325 μ f 35V | 1 | D34656 | HLAB | 09182 | 0180-0332 | 1 |
| C601, 602, 702, 801 | fxd, elect 5 μ f 65V | 4 | D33689 | HLAB | 09182 | 0180-1836 | 1 |
| C700 | fxd, elect 1 μ f 35V | 1 | 150D105X9035A2 | Sprague | 56289 | 0180-0291 | 1 |
| C701 | fxd, elect 1 μ f 50V | 1 | 30D105G050BA4 | Sprague | 56289 | 0180-0108 | 1 |
| C703 | fxd, film 0.1 μ f 200V | 1 | 192P10492 | Sprague | 56289 | 0160-0168 | 1 |
| C800 | fxd, elect 1500 μ f 40V | 1 | D38733 | HLAB | 09182 | 0180-1894 | 1 |
| C802 | fxd, elect 10 μ f 100V | 1 | 30D106G100DC2M1 | Sprague | 56289 | 0180-0091 | 1 |
| C803 | fxd, elect 1600 μ f 70V | 1 | D41655 | HLAB | 09182 | 0180-1895 | 1 |
| C804 | NOT ASSIGNED | - | - | - | - | - | - |
| C805 | fxd, elect 4.7 μ f 35V | 1 | 150D475X9035B2 | Sprague | 56289 | 0180-0100 | 1 |
| C900 | fxd, elect 20 μ f 50V | 1 | 30D206G050DC4 | Sprague | 56289 | 0180-0049 | 1 |
| CR100-102, 200, 300, 301, 500, 700-711, 802, 807, 808, 900, 901 | Si. diode 200ma 200prv | 24 | | HLAB | 09182 | 1901-0033 | 9 |
| CR400, 501, 503, 809 | Si. rect 3A@75°C 200prv | 4 | MR1032B | Motorola | 04713 | 1901-0416 | 4 |
| CR401, 403, 404, 600, 601, 800, 801, 902, | Si. rect 500ma 200prv | 8 | 1N3253 | R. C. A. | 02735 | 1901-0389 | 6 |
| CR402, 602, 803, 804, 805, 806 | Si. diode 200ma 15prv | 6 | | HLAB | 09182 | 1901-0461 | 6 |
| CR502, 504 | SCR 8 amp 200prv | 2 | 2N3669 | R. C. A. | 02735 | 1884-0019 | 2 |
| F1 | Fuse cartridge 5A | 1 | 312005 | Littlefuse | 75915 | 2110-0010 | 5 |
| Q100, 200 | Si. NPN diff. amp. | 2 | | HLAB | 09182 | 1854-0229 | 2 |
| Q300, 301, 601, 602, 603 | Si. NPN | 5 | 4JX16A1014 | G. E. | 03508 | 1854-0071 | 5 |
| Q302, 700, 701, 801, 802 | Si. NPN | 5 | 2N3417 | G. E. | 03508 | 1854-0087 | 5 |
| Q303, 400 | Si. NPN power | 2 | | HLAB | 09182 | 1854-0225 | 2 |
| Q401 | NOT USED | - | - | - | - | - | - |
| Q600 | Si. PNP | 1 | 40362 | R. C. A. | 02735 | 1853-0041 | 1 |
| Q702, 800, 850, 852, 853 | Si. PNP | 5 | 2N2907A | Sprague | 56289 | 1853-0099 | 5 |
| Q851 | Si. NPN diff. amp. | 1 | | HLAB | 09182 | 1854-0221 | 1 |
| Q854 | NOT ASSIGNED | - | - | - | - | - | - |
| R100, 202, 819 | fxd, met. film 160K Ω \pm 1% 1/8w | 3 | Type CEA T-O | I. R. C. | 07716 | 0698-5092 | 1 |
| R101, 201, 820 | fxd, met. film 61.9K Ω \pm 1% 1/8w | 3 | Type CEA T-O | I. R. C. | 07716 | 0757-0460 | 1 |
| R102, 108, 204 | fxd, met. film 432K Ω \pm 1% 1/8w | 3 | Type CEA T-O | I. R. C. | 07716 | 0757-0480 | 1 |
| R103, 306, 815 | fxd, comp 1K Ω \pm 5% 1/2w | 3 | EB-1025 | A. B. | 01121 | 0686-1025 | 1 |
| R104 | fxd, ww 490 Ω \pm 5% 3w 20ppm | 1 | 242E-4915 | Sprague | 56289 | 0811-1801 | 1 |
| R105, 206 | fxd, met. film 33.0K Ω \pm 1% 1/8w | 2 | Type CEA T-O | I. R. C. | 07716 | 0698-5089 | 1 |
| R106, 200, 203 | fxd, met. film 1.5K Ω \pm 1% 1/8w | 3 | Type CEA T-O | I. R. C. | 07716 | 0757-0427 | 1 |
| R107, 205 | fxd, met. film 47.5K Ω \pm 1% 1/8w | 2 | Type CEA T-O | I. R. C. | 07716 | 0757-0457 | 1 |

| Reference Designator | Description | Quantity | Mfr. Part # or Type | Mfr. | Mfr. Code | Stock No. | RS |
|----------------------|--|----------|---------------------|----------|-----------|-----------|----|
| R300 | fxd, comp 330K Ω \pm 5% $\frac{1}{2}$ w | 1 | EB-3345 | A. B. | 01121 | 0686-3345 | 1 |
| R301 | fxd, comp 39 Ω \pm 5% $\frac{1}{2}$ w | 1 | EB-3905 | A. B. | 01121 | 0686-3905 | 1 |
| R302, 303 | fxd, comp 36K Ω \pm 5% $\frac{1}{2}$ w | 2 | EB-3635 | A. B. | 01121 | 0686-3635 | 1 |
| R304 | fxd, comp 75 Ω \pm 5% $\frac{1}{2}$ w | 1 | EB-7505 | A. B. | 01121 | 0686-7505 | 1 |
| R305 | fxd, comp 6.2K Ω \pm 5% $\frac{1}{2}$ w | 1 | EB-6225 | A. B. | 01121 | 0686-6225 | 1 |
| R307 | var. ww 10K Ω | 1 | Series 70 | C. T. S. | 71450 | 2100-0092 | 1 |
| R308 | fxd, comp 3K Ω \pm 5% $\frac{1}{2}$ w | 1 | EB-3025 | A. B. | 01121 | 0686-3025 | 1 |
| R309 | fxd, comp 150 Ω \pm 5% 40w | 1 | 40S/817 MTG | W. L. | 63743 | 0811-1924 | 1 |
| R310 | fxd, comp 47K Ω \pm 5% $\frac{1}{2}$ w | 1 | EB-4735 | A. B. | 01121 | 0686-4735 | 1 |
| R311 | fxd, ww 6.8 Ω \pm 5% | 1 | Type BWH | I. R. C. | 07716 | 0811-1676 | 1 |
| R312, 811, 812 | fxd, ww 100 Ω \pm 5% $\frac{1}{2}$ w | 3 | EB-1015 | A. B. | 01121 | 0686-1015 | 1 |
| R313 | fxd, ww 10K Ω \pm 5% $\frac{1}{2}$ w | 1 | EB-1035 | A. B. | 01121 | 0686-1035 | 1 |
| R400 | Strap | 1 | - | - | - | - | - |
| R401 | LEAVE OPEN | - | - | - | - | - | - |
| R500 | fxd, ww 800 Ω \pm 5% 10w | 1 | 10XM | W. L. | 63743 | 0811-0944 | 1 |
| R501, 502 | fxd, comp 47 Ω \pm 5% $\frac{1}{2}$ w | 2 | EB-4705 | A. B. | 01121 | 0686-4705 | 1 |
| R503 | fxd, comp 820 Ω \pm 5% $\frac{1}{2}$ w | 1 | EB-8215 | A. B. | 01121 | 0686-8215 | 1 |
| R600 | fxd, comp 100K Ω \pm 5% $\frac{1}{2}$ w | 1 | EB-1045 | A. B. | 01121 | 0686-1045 | 1 |
| R601 | fxd, met. film 1K Ω \pm 1% $\frac{1}{2}$ w | 1 | Type CEB T-O | I. R. C. | 07716 | 0757-0338 | 1 |
| R602, 871 | fxd, met. film 1.33K Ω \pm 1% $\frac{1}{2}$ w | 2 | Type CEB T-O | I. R. C. | 07716 | 0698-3134 | 1 |
| R603 | fxd, met. film 2K Ω \pm 1% $\frac{1}{2}$ w | 1 | Type CEB T-O | I. R. C. | 07716 | 0757-0739 | 1 |
| R604, 806, 808 | fxd, comp SELECTIVE \pm 5% $\frac{1}{2}$ w | 3 | Type EB | A. B. | 01121 | | 1 |
| R605, 608, 609, 610 | fxd, met. film 6.2K Ω \pm 1% $\frac{1}{2}$ w | 4 | Type CEB T-O | I. R. C. | 07716 | 0698-5149 | 1 |
| R606 | fxd, met. film 9.31K Ω \pm 1% $\frac{1}{2}$ w | 1 | Type CEB T-O | I. R. C. | 07716 | 0698-3283 | 1 |
| R607 | fxd, met. film 560 μ \pm 1% $\frac{1}{2}$ w | 1 | Type CEB T-O | I. R. C. | 07716 | 0698-5146 | 1 |
| R611 | fxd, ww 390 Ω \pm 5% 3w | 1 | 242E-3915 | Sprague | 56289 | 0811-1799 | 1 |
| R700 | fxd, met. ox 270 Ω \pm 5% 2w | 1 | Type C42S | Corning | 16299 | 0698-3629 | 1 |
| R701 | fxd, comp 24 Ω \pm 5% $\frac{1}{2}$ w | 1 | EB-2405 | A. B. | 01121 | 0686-2405 | 1 |
| R702 | fxd, ww 2.4K Ω \pm 5% 3w | 1 | 242E-2425 | Sprague | 56289 | 0811-1807 | 1 |
| R703, 707 | fxd, comp 3.9K Ω \pm 5% $\frac{1}{2}$ w | 2 | EB-3925 | A. B. | 01121 | 0686-3925 | 1 |
| R704 | fxd, comp 9.1K Ω \pm 5% $\frac{1}{2}$ w | 1 | EB-9125 | A. B. | 01121 | 0686-9125 | 1 |
| R705 | fxd, comp 110K Ω \pm 5% $\frac{1}{2}$ w | 1 | EB-1145 | A. B. | 01121 | 0686-1145 | 1 |
| R706 | fxd, comp 4.7 Ω \pm 5% 1w | 1 | GB-0475 | A. B. | 01121 | 0689-0475 | 1 |
| R708 | fxd, comp 4.3K Ω \pm 5% $\frac{1}{2}$ w | 1 | EB-4325 | A. B. | 01121 | 0686-4325 | 1 |
| R709 | fxd, comp 8.2K Ω \pm 5% $\frac{1}{2}$ w | 1 | EB-8225 | A. B. | 01121 | 0686-8225 | 1 |
| R710 | fxd, comp 1.1M Ω \pm 5% $\frac{1}{2}$ w | 1 | EB-1155 | A. B. | 01121 | 0686-1155 | 1 |
| R711 | var. ww 5K Ω | 1 | Type 110-F4 | C. T. S. | 11236 | 2100-1824 | 1 |
| R712 | fxd, comp 12K Ω \pm 5% $\frac{1}{2}$ w | 1 | EB-1235 | A. B. | 01121 | 0686-1235 | 1 |
| R713 | fxd, comp 270K Ω \pm 5% $\frac{1}{2}$ w | 1 | EB-2745 | A. B. | 01121 | 0686-2745 | 1 |
| R800 | fxd, ww 0.33 Ω \pm 5% 40w | 1 | | HLAB | 09182 | 0811-1953 | 1 |
| R805 | fxd, ww 3K Ω \pm 5% 3w | 1 | 242E-3025 | Sprague | 56289 | 0812-0010 | 1 |
| R807 | fxd, ww 10K Ω \pm 5% 3w | 1 | 242E-1035 | Sprague | 56289 | 0811-1816 | 1 |
| R809, 810 | var. ww 1.8K Ω - 20 Ω | | | | | | |
| | DUAL POT | 2 | | HLAB | 09182 | 2100-0995 | 1 |
| R813, 814 | var. ww 22K Ω - 200 Ω DUAL POT | 2 | | HLAB | 09182 | 2100-0998 | 1 |
| R816 | fxd, comp 43K Ω \pm 5% $\frac{1}{2}$ w | 1 | EB-4335 | A. B. | 01121 | 0686-4335 | 1 |
| R817 | fxd, comp 62 Ω \pm 5% $\frac{1}{2}$ w | 1 | EB-6205 | A. B. | 01121 | 0686-6205 | 1 |
| R818 | fxd, comp 27K Ω \pm 5% $\frac{1}{2}$ w | 1 | EB-2735 | A. B. | 01121 | 0686-2735 | 1 |
| R821 | fxd, met. film 68.1K Ω \pm 1% 1/8w | 1 | Type CEA T-O | I. R. C. | 07716 | 0757-0461 | 1 |
| R822 | fxd, comp 82K Ω \pm 5% $\frac{1}{2}$ w | 1 | EB-8235 | A. B. | 01121 | 0686-8235 | 1 |
| R823 | fxd, met. film 15K Ω \pm 1% 1/8w | 1 | Type CEA T-O | I. R. C. | 07716 | 0757-0446 | 1 |
| R824 | fxd, comp 15K Ω \pm 5% $\frac{1}{2}$ w | 1 | EB-1535 | A. B. | 01121 | 0686-1535 | 1 |
| R825 | fxd, met. ox 160 Ω \pm 5% 2w | 1 | Type C42S | Corning | 16299 | 0698-3625 | 1 |
| R826 | fxd, comp 3.3K Ω \pm 5% $\frac{1}{2}$ w | 1 | EB-3325 | A. B. | 01121 | 0686-3325 | 1 |
| R827 | fxd, ww 3 Ω \pm 5% 3w | 1 | 242E3R05 | Sprague | 56289 | 0811-1224 | 1 |

| Reference Designator | Description | Quantity | Mfr. Part # or Type | Mfr. | Mfr. Code | Stock No. | RS |
|----------------------|---|----------|---------------------|----------------|-----------|-----------|----|
| R828 | fxd. comp 680K Ω \pm 5% $\frac{1}{2}$ w | 1 | EB-6845 | A. B. | 01121 | 0686-6845 | 1 |
| R850 | fxd. met. film 61.9K Ω \pm 1% 1/8w | 1 | Type CEA T-O | I. R. C. | 07716 | 0757-0460 | 1 |
| R851, 854, 856, 859 | fxd. met. film 900 Ω \pm 1% 1/8w | 4 | Type CEA T-O | I. R. C. | 07716 | 0757-1099 | 1 |
| R852, 853 | fxd. met. film 100 Ω \pm 1% 1/8w | 2 | Type CEA T-O | I. R. C. | 07716 | 0757-0401 | 1 |
| R857 | fxd. met. film 5.2K Ω \pm 1% $\frac{1}{4}$ w | 1 | Type CEB T-O | I. R. C. | 07716 | 0698-5148 | 1 |
| R858 | fxd. met. film 9.31K Ω \pm 1% $\frac{1}{4}$ w | 1 | Type CEB T-O | I. R. C. | 07716 | 0698-3283 | 1 |
| R860, 863 | fxd. met. film 365 Ω \pm 1% $\frac{1}{4}$ w | 2 | Type CEB T-O | I. R. C. | 07716 | 0757-0723 | 1 |
| R864, 867, 861, 862 | fxd. met. film 3.40K Ω \pm 1% $\frac{1}{4}$ w | 4 | Type CEB T-O | I. R. C. | 07716 | 0698-4642 | 1 |
| R866 | fxd. met. film 750 Ω \pm 1% 1/8w | 1 | Type CEA T-O | I. R. C. | 07716 | 0757-0420 | 1 |
| R868, 869 | fxd. met. film 36.5K Ω \pm 1% $\frac{1}{4}$ w | 2 | Type CEB T-O | I. R. C. | 07716 | 0757-0765 | 1 |
| R870 | var. ww 10K Ω | 1 | Type 110-F4 | C. T. S. | 11236 | 2100-0396 | 1 |
| R872 | fxd. met. film 2K Ω \pm 1% 1/8w | 1 | Type CEA T-O | I. R. C. | 07716 | 0757-0283 | 1 |
| R900 | fxd. comp 39K Ω \pm 5% $\frac{1}{2}$ w | 1 | EB-3935 | A. B. | 01121 | 0686-3935 | 1 |
| R901 | fxd. comp 180K Ω \pm 5% $\frac{1}{2}$ w | 1 | EB-3935 | A. B. | 01121 | 0686-1845 | 1 |
| R902 | fxd. comp 3K Ω \pm 5% $\frac{1}{2}$ w | 1 | EB-3935 | A. B. | 01121 | 0686-3025 | 1 |
| R903 | fxd. comp 33K Ω \pm 5% $\frac{1}{2}$ w | 1 | EB-3935 | A. B. | 01121 | 0686-3335 | 1 |
| S1 | Switch PL. Lt. (red) ON/OFF | 1 | 54-61681-26 A1H | Oak | 87034 | 3101-0100 | 1 |
| S2 | Switch Rotary (meter) 3 pole 4 position | 1 | | HLAB | 09182 | 3100-1910 | 1 |
| T700 | Pulse Transformer | 1 | | HLAB | 09182 | 9100-1824 | 1 |
| T800 | Power Transformer 115V | 1 | | HLAB | 09182 | 9100-1846 | 1 |
| T800 | Power Transformer 230V (Special for 230V operation only) | | | HLAB | 09182 | 9100-2141 | |
| T801 | Bias Transformer | 1 | | HLAB | 09182 | 9100-1832 | 1 |
| VR300 | Diode, zener 4.22V \pm 5% 400MW | 1 | | HLAB | 09182 | 1902-3070 | 1 |
| VR600 | Diode, zener 9.4V \pm 5% 500MW | 1 | 1N2163 | U. S. Semcor | 06751 | 1902-0762 | 1 |
| VR601 | Diode, zener 6.2V \pm 5% | 1 | 1N821 | N. A. Electric | 06486 | 1902-0761 | 1 |
| | Side Chassis - right | 1 | | HLAB | 09182 | 5000-6098 | |
| | Side Chassis - left | 1 | | HLAB | 09182 | 5000-6099 | |
| | Chassis - rear | 1 | | HLAB | 09182 | 5000-6103 | |
| | Panel - front | 1 | | HLAB | 09182 | 5000-6100 | |
| | Heat sink - diode | 1 | | HLAB | 09182 | 5000-6101 | |
| | Heat sink - SCR | 1 | | HLAB | 09182 | 5000-6102 | |
| | Cover | 2 | | HLAB | 09182 | 5000-6104 | |
| | Guard - angle | 1 | | HLAB | 09182 | 5020-5540 | |
| | Meter $3\frac{1}{2}$ " DUAL SCALE 0-70V 0-4A | 1 | | HLAB | 09182 | 1120-1146 | 1 |
| | Meter bezel $\frac{1}{4}$ mod | 1 | | HLAB | 09182 | 4040-0294 | 1 |
| | Meter spring | 4 | | HLAB | 09182 | 1460-0256 | 1 |
| | Fuseholder | 1 | 342014 | Littlefuse | 75915 | 1400-0084 | 1 |
| | Lockwasher | 1 | 1224-08 | Shakeproof | 78189 | 2190-0037 | 1 |
| | Nut | 1 | 903-12 | Littlefuse | 75915 | 2950-0038 | 1 |
| | Washer - neoprene | 1 | 901-2 | Littlefuse | 75915 | 1400-0090 | 1 |
| | Binding post (maroon) | 1 | DF21 Mn | HLAB | 09182 | 1510-0040 | 1 |
| | Binding post (black) | 2 | DF21 BC | Superior | 58474 | 1510-0039 | 1 |
| | Rubber feet | 4 | MB-50 | Stockwell | 87575 | 0403-0088 | 1 |
| | Knob 5/8 dia. black | 1 | | HLAB | 09182 | 0370-0084 | 1 |

| Reference Designator | Description | Quantity | Mfr. Part # or Type | Mfr. | Mfr. Code | Stock No. | RS |
|----------------------|--|----------|---------------------|------------|-----------|-----------|----|
| | Knob pointer 5/8 dia | 2 | | HLAB | 09182 | 0370-0101 | 1 |
| | Knob 1/2 dia red | 2 | | HLAB | 09182 | 0370-0179 | 1 |
| | Barrier strip | 1 | | HLAB | 09182 | 0360-1234 | 1 |
| | Line cord 7 1/2' PH 151 | 1 | KH-4096 | Beldon | 70903 | 8120-0050 | 1 |
| | Strain relief | 1 | SR-SP-1 | Heyco | 28520 | 0400-0013 | 1 |
| | Mica washer | 2 | 734 | Reliance | 08530 | 0340-0174 | 1 |
| | Mica washer 1" dia | 4 | | Reliance | 08530 | 2190-0710 | 1 |
| | Capacitor clamp 3" dia | 1 | 4586-2A | Sprague | 56289 | 0180-1973 | 1 |
| | Mica washer 5/8 dia | 2 | | Reliance | 08530 | 2190-0708 | 1 |
| | Fastener (U-type) | 9 | 6-32 | Tinnerman | 89032 | | 2 |
| | Cable clamp 3/8 I. D. | 2 | T4-6 | Whitehead | 79307 | 1400-0332 | 1 |
| | Cable clamp 1/4 I. D. | 1 | T4-4 | Whitehead | 79307 | 1400-0330 | 1 |
| | Delrin bushing | 6 | | HLAB | 09182 | 0340-0169 | 2 |
| | Delrin bushing | 2 | | HLAB | 09182 | 0340-0171 | 1 |
| | Pem nuts #8-32 | 4 | CLA-832-2 | Penn. Eng. | 46384 | 0590-0395 | 1 |
| | Pem nuts #6-32 | 8 | CLA-632-2 | Penn. Eng. | 46384 | 0590-0393 | 2 |
| | Jumper (barrier strip) | 9 | 422-13-11 013 | Cinch | 71785 | 0360-1143 | 2 |
| | Handle 8" black (color no. Y-12561) | 1 | 7835 | HLAB | 09182 | 1440-0042 | 1 |

OPTION 07:
Voltage 10-Turn Potentiometer 1 Series 8400 I. R. C. 07716 2100-1867 1

OPTION 08:
Current 10-Turn Potentiometer 1 Series 8400 I. R. C. 07716 2100-2029 1

OPTION 09:
Voltage/Current 10-Turn Pot 1 (Includes:)
Voltage 10-Turn Potentiometer 1 Series 8400 I. R. C. 07716 2100-1867 1
Current 10-Turn Potentiometer 1 Series 8400 I. R. C. 07716 2100-2029 1

OPTION 13:
Voltage Decadial Control 1 (Includes:)
Voltage 10-Turn Potentiometer 1 Series 8400 I. R. C. 07716 2100-1867 1
Decadial Control 1 RD-411 I. R. C. 07716 1140-0020 1

OPTION 14:
Current Decadial Control 1 (Includes:)
Current 10-Turn Potentiometer 1 Series 8400 I. R. C. 07716 2100-2029 1
Decadial Control 1 RD-411 I. R. C. 07716 1140-0020 1

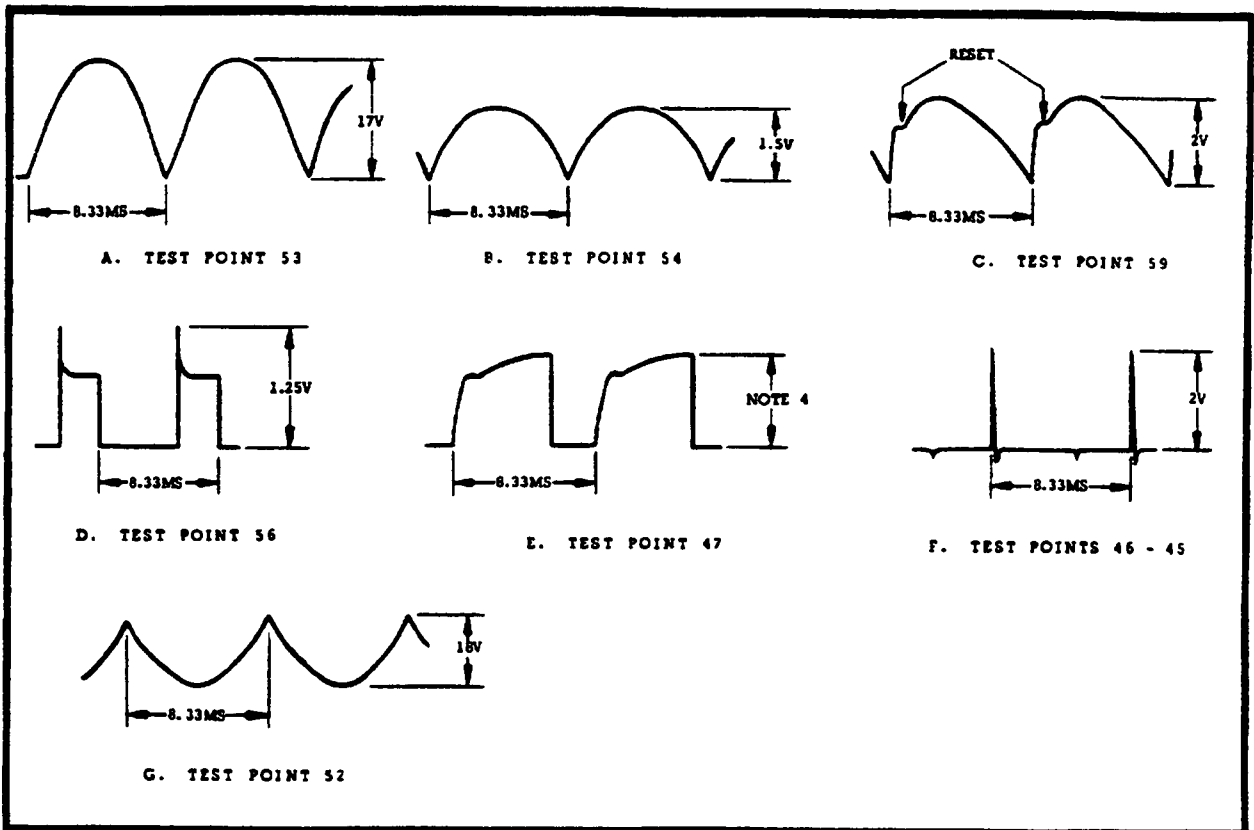

- NOTES:
1. ALL WAVEFORMS TAKEN WITH 115VAC, 60Hz, SINGLE-PHASE INPUT AT MAXIMUM RATED OUTPUT VOLTAGE AND NO LOAD CONNECTED. AMPLITUDES ARE TYPICAL $\pm 10\%$.
 2. OSCILLOSCOPE DC COUPLED AND REFERENCED TO T. P. 90 UNLESS OTHERWISE INDICATED.
 3. WAVEFORMS ARE NOT DRAWN TO SCALE.
 4. AMPLITUDE OF WAVEFORM AT T. P. 47 VARIES WITH DIFFERENT MODELS AS FOLLOWS:

| MODEL NO. | 6282A | 6285A | 6286A | 6290A | 6291A | 6296A |
|-----------|-------|-------|-------|-------|-------|-------|
| VOLTAGE | +15V | +17V | +15V | +20V | +17V | +20V |

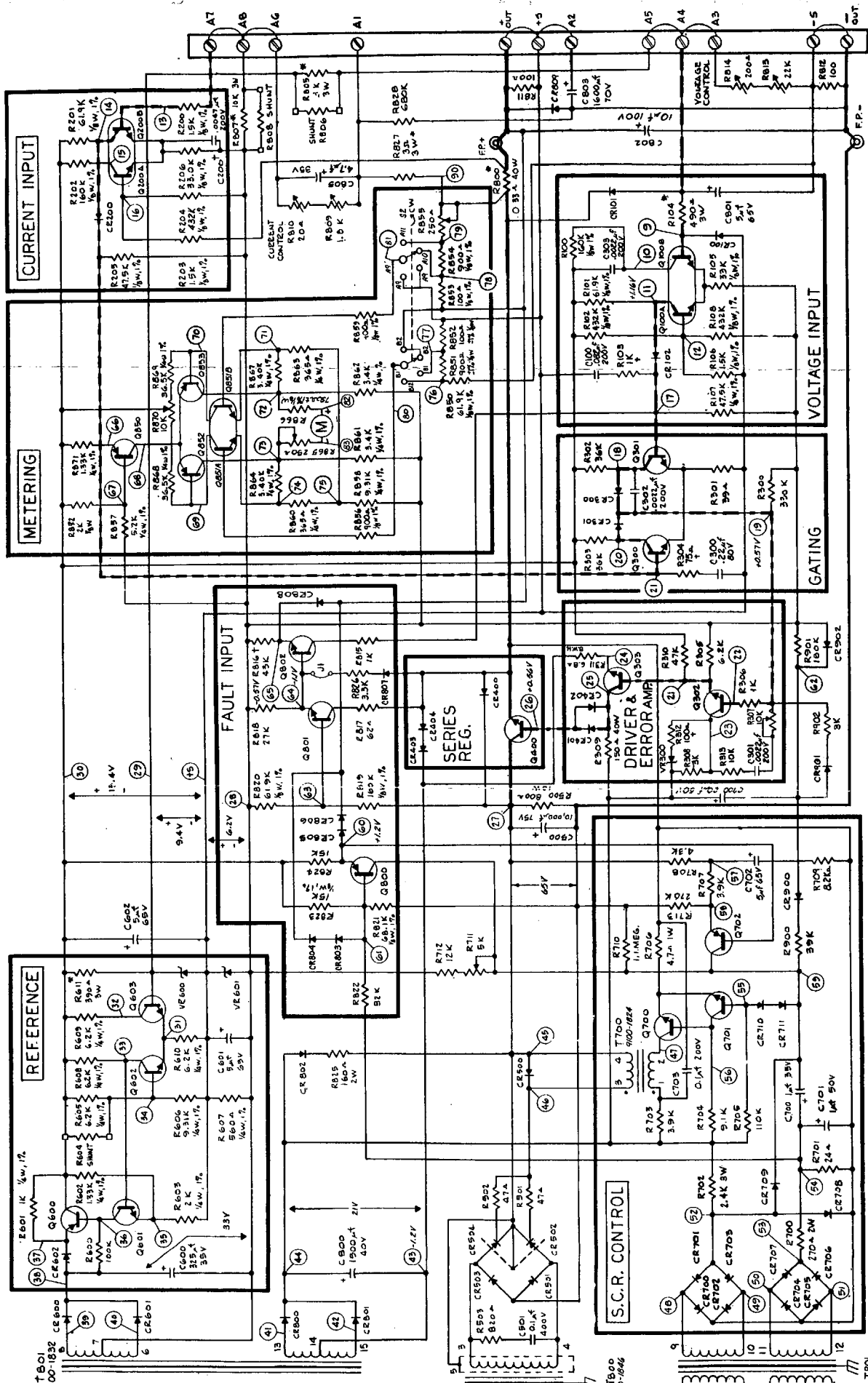

Model 6296A, Schematic Diagram

2. ALL RESISTORS ARE 1/2 W., 5% UNLESS NOTED OTHERWISE.
 3. # DENOTES 20 PPM/W. RES. TEMP. COEFF.
 4. REF. TERMINALS SHOWN IN NOMINAL STRAPPING.
 5. REF. VOLTAGES MEASURED AT FULLY LOADED.
 6. — DENOTES CURRENT SIGNAL, — DENOTES VOLTAGE SIGNAL.
 7. T DENOTES NOMINAL VALUE, SELECTED AT FACTORY FOR OPTIMUM PERFORMANCE.

NOTES:
 1. DC VOLTAGES WERE MEASURED UNDER THE FOLLOWING CONDITIONS:
 1. SIMON MODEL 28 OR EQUIVALENT
 2. 115VAC INPUT
 3. LOADS AS INDICATED TO #8, UNLESS OTHERWISE INDICATED
 4. VOLTAGES ARE TYPICAL, 20% UNLESS OTHERWISE INDICATED
 5. ALL READINGS TAKEN WITH SUPPLY IN CONSTANT VOLTAGE OPERATION
 6. AT MAXIMUM LOAD UNLESS OTHERWISE INDICATED
 7. CURRENT SHOULD BE TAKEN FULLY CLOSED

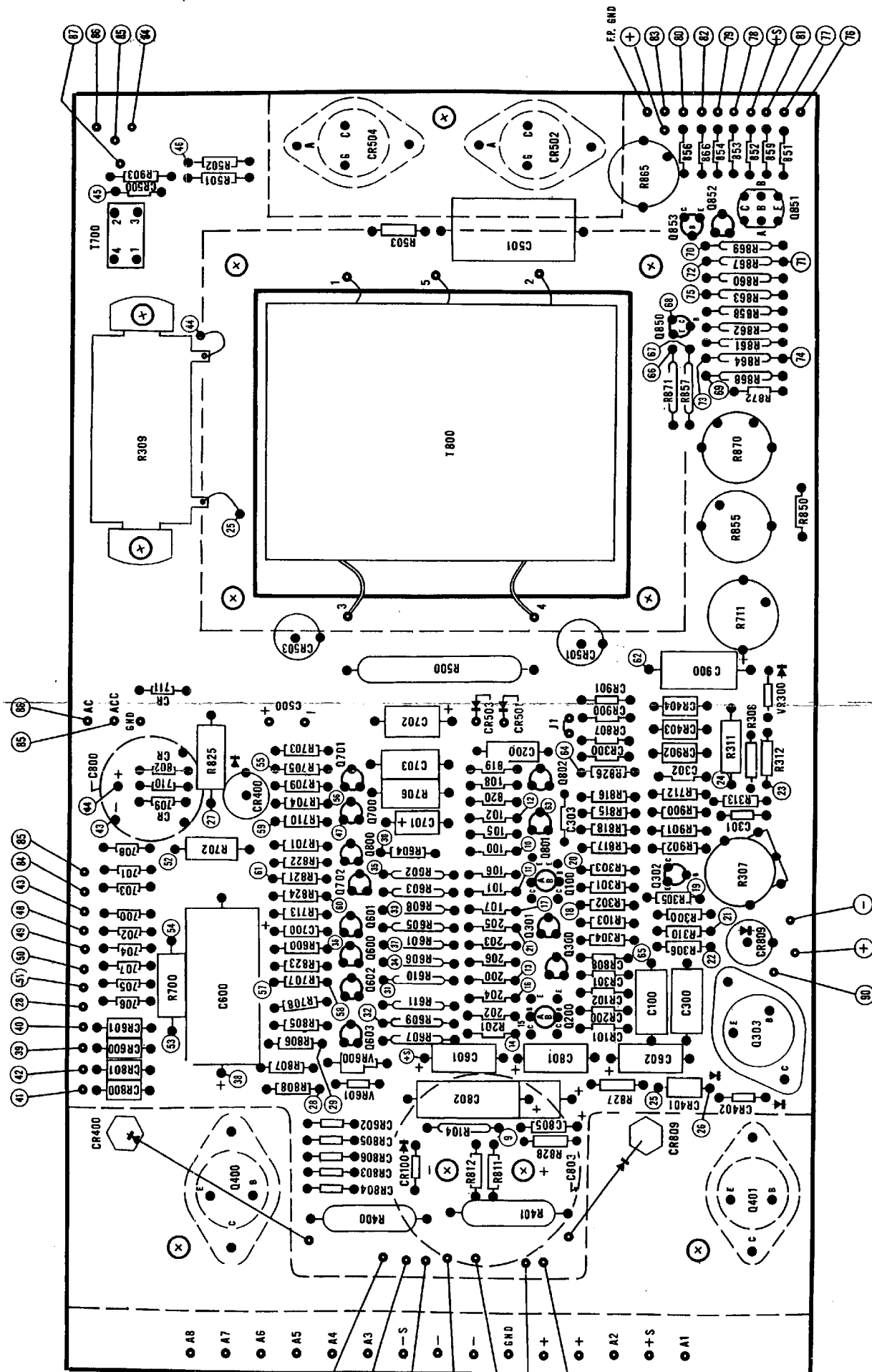

- NOTE:**
1. CATHODES OF ALL DIODES FACE TOWARDS BOTTOM OF BOARD.
 2. ALL TRANSISTOR BASES FACE TOWARDS THE RIGHT OF BOARD, EXCEPT OTHERWISE NOTED.
 3. ON MODELS 6282A, 6285A, 6286A AND 6291A, CR400, CR501, CR503, AND CR609 MOUNTED ON HEAT SINKS NOT PRINTED CIRCUIT BOARD.
 4. ON MODELS 6290A AND 6296A, CR400, CR501, CR503, CR609 ARE MOUNTED ON PRINTED CIRCUIT BOARD NOT HEAT SINKS
 5. ON MODELS 6285A, 6290A, 6291A, AND 6296A, R401 AND Q401 ARE NOT USED AND R400 IS REPLACED WITH A JUMPER

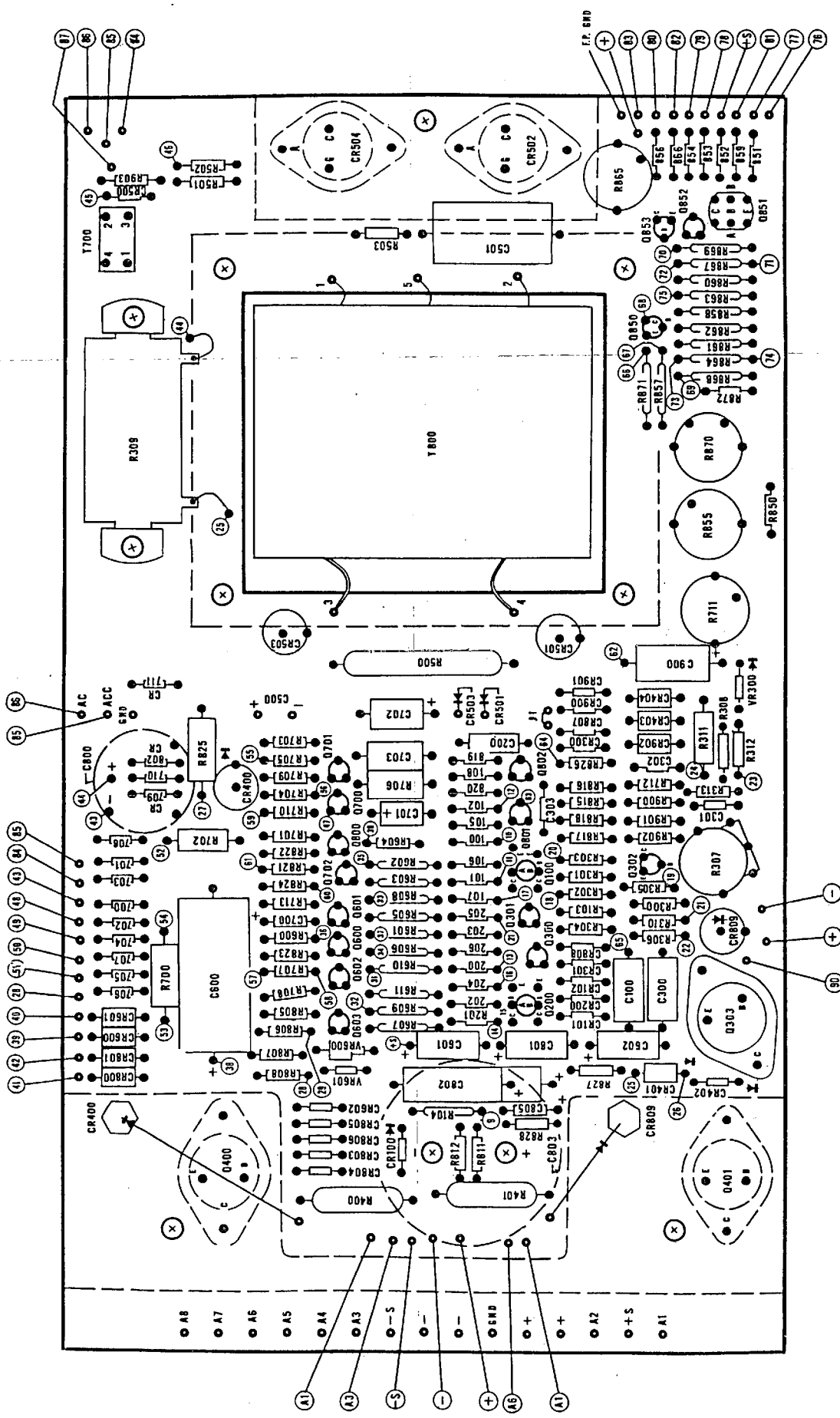

- NOTE:**
1. CATHODES OF ALL DIODES FACE TOWARDS BOTTOM OF BOARD.
 2. ALL TRANSISTOR BASES FACE TOWARDS THE RIGHT OF BOARD. EXCEPT OTHERWISE NOTED.
 3. ON MODELS 6285A, 6286A AND 6291A, CR400, CR501, CR503, AND CR804 MOUNTED ON HEAT SINKS NOT PRINTED CIRCUIT BOARD.
 4. ON MODELS 6290A AND 6296A, CR400, CR501, CR503, CR804 ARE MOUNTED ON PRINTED CIRCUIT BOARD NOT HEAT SINKS
 5. ON MODELS 6285A, 6290A, 6291A, AND 6296A, R401 AND Q401 ARE NOT USED AND R400 IS REPLACED WITH A JUMPER

APPENDIX A
Option 11, Overvoltage Protection "Crowbar"

DESCRIPTION:

This option is installed in DC Power Supplies, 6282A, 6285A, 6286A, 6290A, 6291A, and 6296A, and tested at the factory. It consists of a printed circuit board, screwdriver-type front panel potentiometer, and six wires that are soldered to the main power supply board.

The crowbar monitors the output voltage of the power supply and fires an SCR that effectively shorts the output when it exceeds the preset trip voltage. The trip voltage is determined by the setting of the CROWBAR ADJUST control on the front panel. The trip voltage range is as follows:

| Model | 6282A | 6285A | 6286A | 6290A | 6291A | 6296A |
|--------------------|-------|-------|-------|-------|-------|-------|
| Trip Voltage Range | 1-13V | 2-22V | 2-22V | 5-42V | 5-42V | 6-66V |

To prevent transients from falsely tripping the crowbar, the trip voltage must be set higher than the power supply output voltage by the following margin: 7% of the output voltage +1V. The margin represents the minimum crowbar trip setting for a given output voltage; the trip voltage can always be set higher than this margin.

OPERATION:

1. Turn the CROWBAR ADJUST fully clockwise to set the trip voltage to maximum.
2. Set the power supply VOLTAGE control for the desired crowbar trip voltage. To prevent false crowbar tripping, the trip voltage should exceed the desired output voltage by the following amount: 7% of the output voltage +1V.
3. Slowly turn the CROWBAR ADJUST ccw until the crowbar trips, output goes to 0V or a small positive voltage.
4. The crowbar will remain activated and the output shorted until the supply is turned off. To reset the crowbar, turn the supply off, then on.

Table A-1. Replaceable Parts

| REF. DESIG. | DESCRIPTION | TQ | MFR. PART NO. | MFR. CODE | HP PART NO. | RS |
|---------------|--|----|---------------|-----------|-------------|----|
| C1 | fxd, film .1 μ F 200Vdc | 1 | 192P10492 | 56289 | 0160-0168 | 1 |
| CR1-4 | Diode, Si. 200mA 200prv | 4 | 1N485B | 09182 | 1901-0033 | 4 |
| CR6 | Rect. Si. 12A 100prv | 1 | 1N1200A | 02735 | 1901-0002 | 1 |
| CR7 | SCR 8A 200prv | 1 | 2N3669 | 02735 | 1884-0019 | 1 |
| Q1 | SS NPN Si. | 1 | 2N2714 | 03508 | 1854-0027 | 1 |
| Q2 | SS NPN Si. | 1 | 2N3417 | 03508 | 1854-0087 | 1 |
| Q3 | SS PNP Si. | 1 | TZ173 | 56289 | 1853-0099 | 1 |
| R1 | fxd, comp 750 Ω \pm 5% $\frac{1}{2}$ W | 1 | EB-7515 | 01121 | 0686-7515 | 1 |
| R2 | fxd, comp 200K Ω \pm 5% $\frac{1}{2}$ W | 1 | EB-2045 | 01121 | 0686-2045 | 1 |
| R3 | fxd, comp 10K Ω \pm 5% $\frac{1}{2}$ W | 1 | EB-1035 | 01121 | 0686-1035 | 1 |
| R4 | fxd, comp 3.9K Ω \pm 5% $\frac{1}{2}$ W | 1 | EB-3925 | 01121 | 0686-3925 | 1 |
| R6 | fxd, comp 4.7 Ω \pm 5% $\frac{1}{2}$ W | 1 | EB-47G5 | 01121 | 0698-0001 | 1 |
| R7 | fxd, comp 47 Ω \pm 5% $\frac{1}{2}$ W | 1 | C425 | 16299 | 0698-3626 | 1 |
| R8 | fxd, met. ox. 180 Ω \pm 5% 2W | 1 | Type C425 | 16299 | 0698-3626 | 1 |
| R9 | fxd, met. film 2K Ω \pm 1% 1/8W | 1 | Type CEA T-O | 07716 | 0757-0283 | 1 |
| R10 | fxd, comp 3.3K Ω \pm 1% 1/8W | 1 | 242E3325 | 56289 | 0811-1809 | 1 |
| R11 | var. ww 22K Ω \pm 10% 2W | 1 | | 09182 | 2100-1850 | 1 |
| R12 | fxd, ww 0.5 Ω \pm 5% 5W | 1 | | 09182 | 0811-1848 | 1 |
| R13 | fxd, comp 200K Ω \pm 5% $\frac{1}{2}$ W | 1 | EB-2045 | 01121 | 0686-2045 | 1 |
| T1 | Pulse Transformer | 1 | | 09182 | 9100-1824 | 1 |
| VR1 | Diode, zener 5.62V \pm 5% | 1 | 1N3512 | 07716 | 1902-3104 | 1 |
| MISCELLANEOUS | | | | | | |
| | Bushing, Potentiometer | 1 | | 09182 | 1400-0052 | |
| | Nut, Hex | 1 | | 09182 | 2950-0034 | |
| | Printed Circuit Board Assembly, Includes Components | 1 | | 09182 | 06296-60021 | |
| | Printed Circuit Board, Bracket | 1 | | 09182 | 5000-6225 | |
| | Modified Front Panel, Includes Components | 1 | | 09182 | 06296-60003 | |

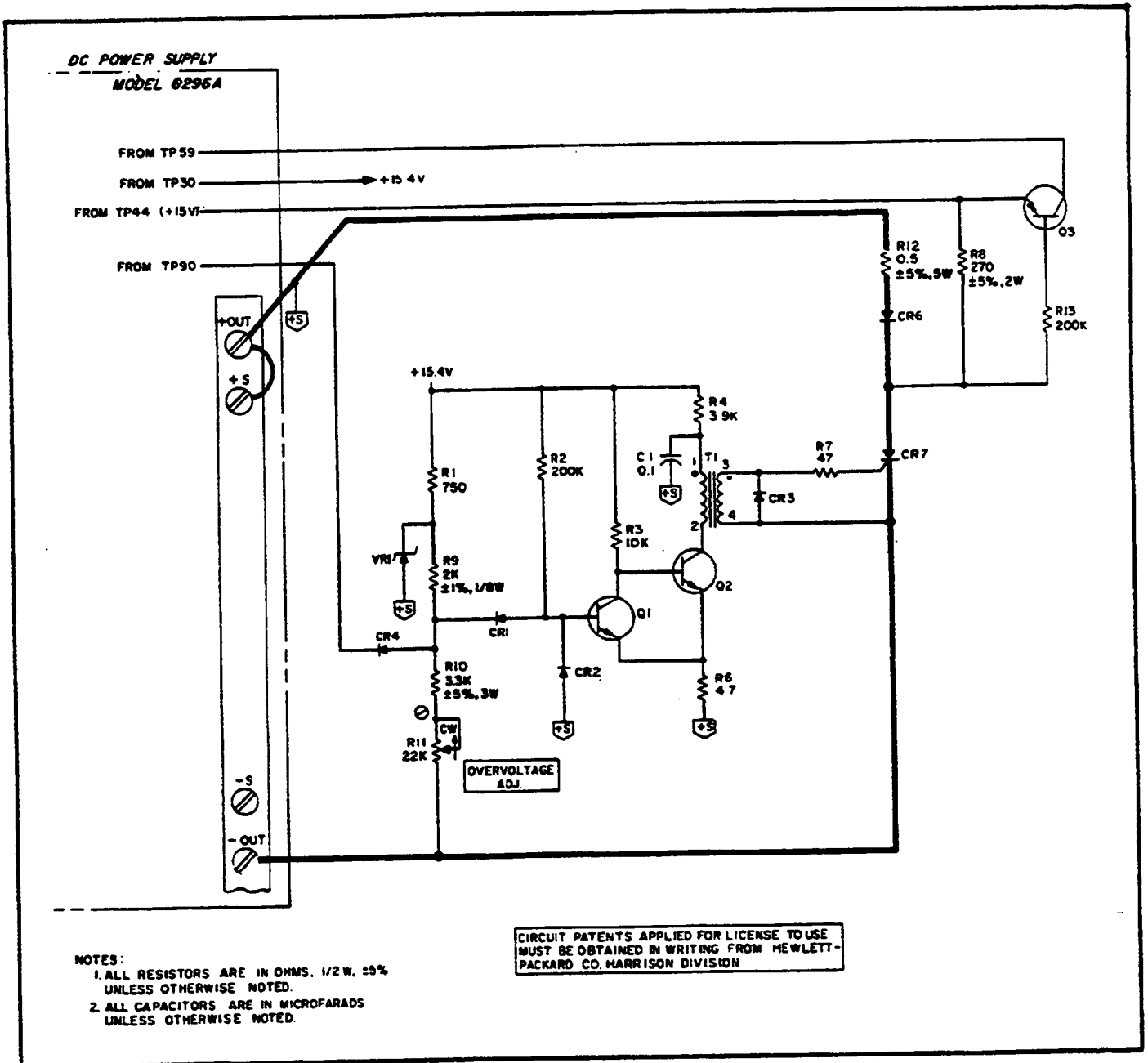

Figure A-1. Model 6296A Overvoltage Protection Crowbar

Order Part Number

06296-90001

E1266-U1090

Printed in USA

Manufacturing Part Number

06296-90001



Free Manuals Download Website

<http://myh66.com>

<http://usermanuals.us>

<http://www.somanuals.com>

<http://www.4manuals.cc>

<http://www.manual-lib.com>

<http://www.404manual.com>

<http://www.luxmanual.com>

<http://aubethermostatmanual.com>

Golf course search by state

<http://golfingnear.com>

Email search by domain

<http://emailbydomain.com>

Auto manuals search

<http://auto.somanuals.com>

TV manuals search

<http://tv.somanuals.com>