

# SECURITY GUARD STATION





## Model: GF-MK

### INSTALLATION & OPERATION MANUAL





**⚠** Configure your GF Security Guard Station system with GF-MK-compatible components; **GF-1DK, GF-1MDK** for Residential Stations (not GF-1D or GF-1MD), **GF-DA/B** for Audio module (not GF-DA/A), and **GF-NS/A** for Digital name scroll module (not GF-NS).





#### PRECAUTIONS

**⚠ WARNING** (Negligence could result in death or serious injury to people.)

- Do not open the unit case. 
- Do not dismantle or alter the unit. Fire or electric shock could result. 
- Keep the unit away from water or any other liquid. Fire or electric shock could result. 
- Do not put any metal into the unit through openings. Fire, electric shock or unit trouble could result. 

**⚠ CAUTION** (Negligence could result in injury to people or damage to property.)

- Mount the unit on wall in a convenient location, but not where it could be bumped or jarred. Injury could result. 
- Do not install or make any wire terminations while power supply is turned on. Unit trouble could result. 
- Before turning on power supply, make sure wires are not crossed or shorted. Unit trouble could result. 
- Do not manually hold down hook switch to verify chime volume. It sounds very loud near your ears and can cause your hearing damage. 
- Do not press hard or put high impact on LCD. If glass cover is broken, you may be injured, and never touch the liquid inside panel, as it can cause an inflammation on your skin. If the liquid adheres to any part of your body, mouth or eyes, immediately gargle or cleanse with clear water for at least 15 minutes and consult your doctor. 

- Do not install the unit in any of the following locations, as it may cause the system to malfunction;
  - High or extreme cold temperature area: under direct sunlight, near equipment that varies in temperature, in front of air conditioner, inside a refrigerated area, etc. 
  - Places subject to moisture or humidity extremes. 
  - Places subject to environmental conditions, such as oil, dust, chemicals, salt, etc. 
  - Places subject to constant vibration or impact. 
  - Places subject to steam or smoke, such as near heating appliances, cooking surface, etc. 

#### GENERAL PRECAUTIONS





- All the units, except the Entrance Station, is designed for indoor use only. Do not install them outdoors.
- The system is not operable during a power failure.
- In areas where broadcasting station antennas are close by, intercom system may be affected by radio frequency interference.
- Keep all wiring at least 30cm (1") away from AC 100-240V wiring, fluorescent lighting, or dimmer switches. Otherwise, cross AC wiring at a 90° angle.

 **General Prohibitions**  
 **Prohibitions to dismantle the unit**

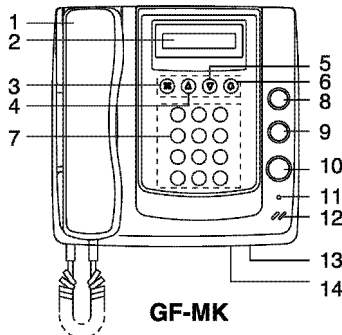
 **Prohibitions to subject the unit to water**

#### NAMES AND FUNCTIONS



- Handset
- LCD display
-  **CANCEL** (or decide & back)
-  **SCROLL backward** or move cursor to left
-  **SCROLL forward** or move cursor to right
-  **CALL** (or decide & next)
- Digital keypad (1 ~ 0, \*, #)  
When entering letters; A ~ Z, 0 = [ , ] [ - ] [ . ] [ / ] [ ]  
Functions : • Dialing Room #  
• Name search with (\* ) key and calling
- SERVICE** button (Option)
- LIGHT** button When communication with Entrance Station, press to turn on external light.

#### PACKAGE CONTENTS

- Security Guard Station (GF-MK)
- Mounting bracket
- Packet of screws
- Connecting cable
- INSTALLATION & OPERATION MANUAL

- DOOR RELEASE button
- Off-hook warning LED
- Call tone sounder
- Call tone volume control
- PC socket

#### PROGRAMMING METHODS

##### Programming by PC

- It is possible to write or change resident names from your PC, making data input.
- Download Programming & Alteration Method from Aiphone's Web Site: <http://www.aiphone.com/>
- Connect your PC with GF-MK in conjunction with the connecting cable supplied with GF-MK.

##### Programming by GF-MK

- On LCD display, see a message "AIPHONE" to confirm system is in standby.
- Prior to programming, it is suggested to have your own ID code newly registered, so that any other person cannot get into the system. → *Go to P.2*
- Firstly, enter program mode. → *Go to P.2*
- In case your programmed ID code is forgotten, → *Go to P.8*

#### COMMUNICATION FUNCTIONS

##### Calling & Communication

- with Residential Stations. → *Go to P.4*
- with Entrance Station. → *Go to P.5*
- with Security Guard Station. → *Go to P.6*
- PANIC call & Answer-back. → *Go to P.6*  
(\* Includes Line-off trouble alarm)

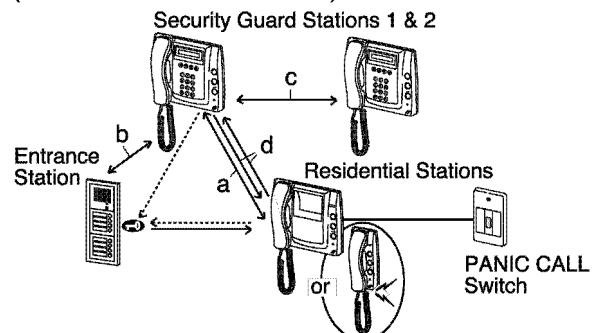

# PROGRAMMING

⚠ While being programmed, PANIC CALL is not receivable on GF-MK.

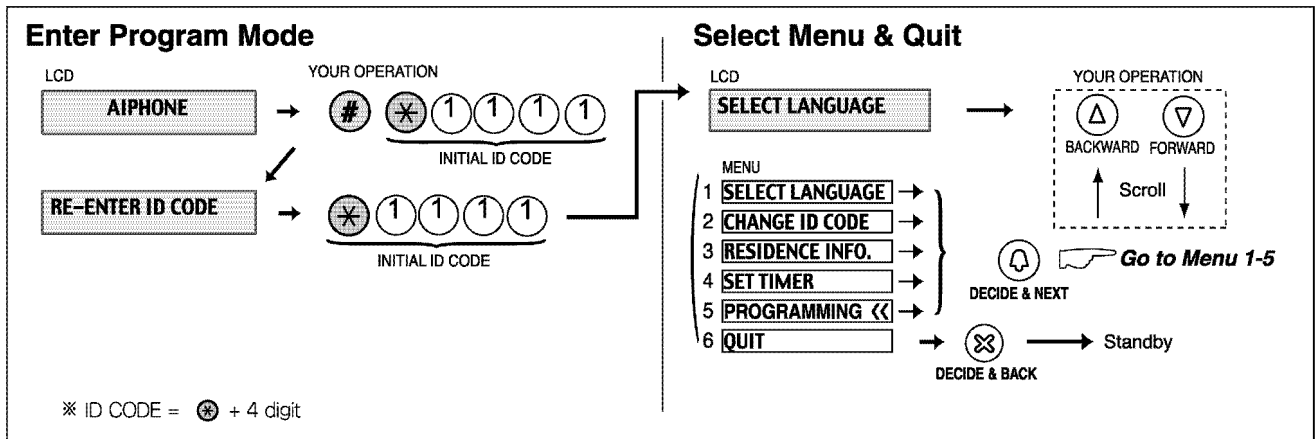

## Menu 1: Select language

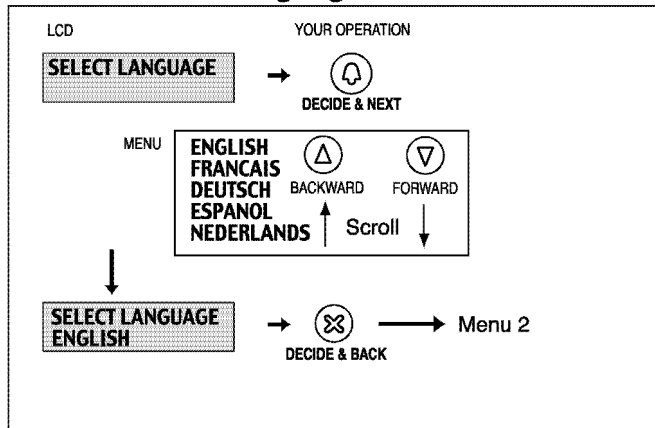

## Menu 2: Change ID code

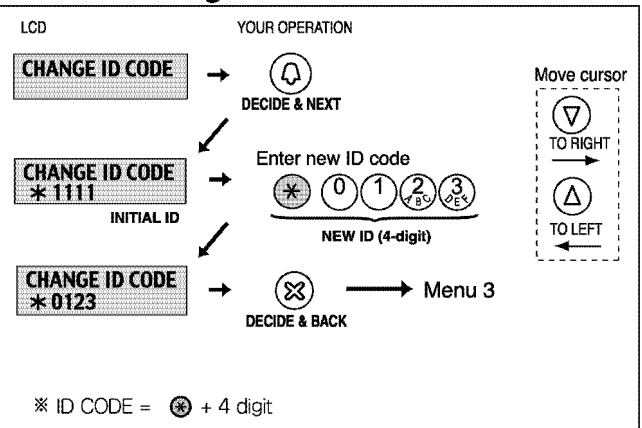

## Menu 3: Write Residence Info.

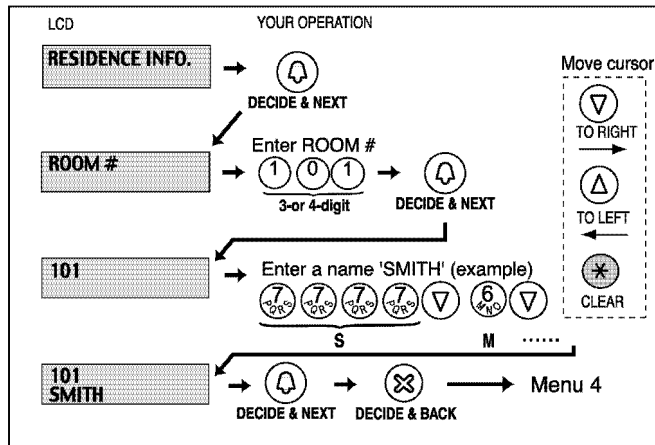

## Menu 4: Set input timeout timer

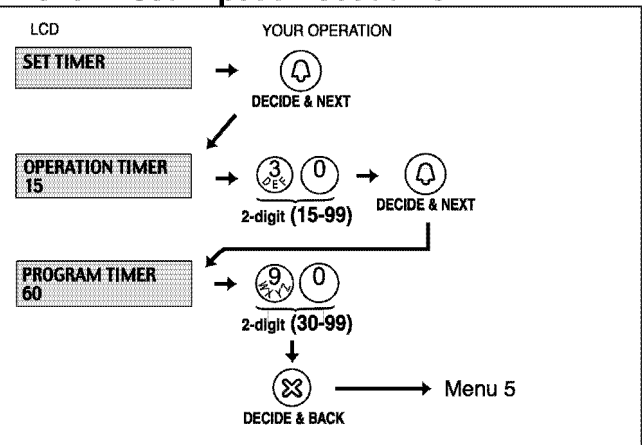

Note: Press \* to clear the previous name and enter a new name.

# Menu 5: Programming <<

 While connecting date to the system, whole system is not operable including PANIC CALL.

Before initiating PROGRAMMING << operation, make sure ROOM number has been programmed on Menu RESIDENCE INFO.

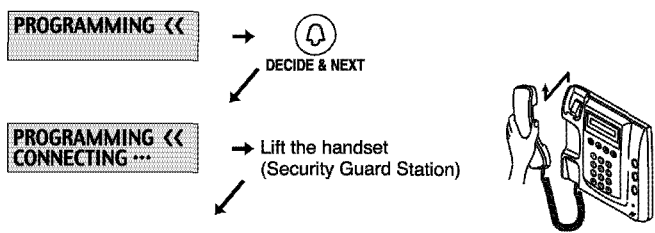

## Programming Step

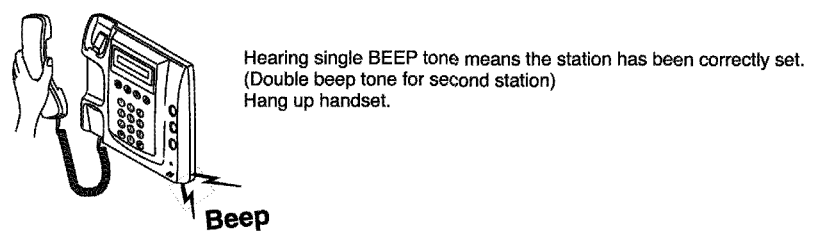
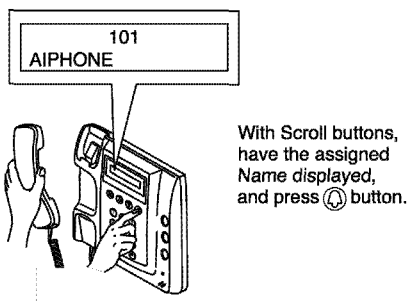

Go to each Residential stations, and consecutively program each handset station in the same manner as in Programming Step.



Hang up handset. (Security Guard station)

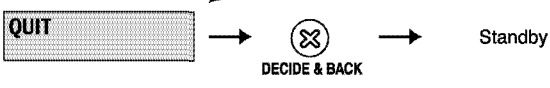
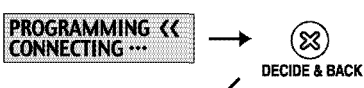

**NOTES;**  
If already two Residential Stations have been linked, setting a third station will produce a warning beep tone.  
To erase linkage have the assigned name displayed, press CALL button more than 3 seconds.  
Continuous tone notifies the link has been cancelled.

# WITH RESIDENTIAL STATION

## Calling a Residential Station

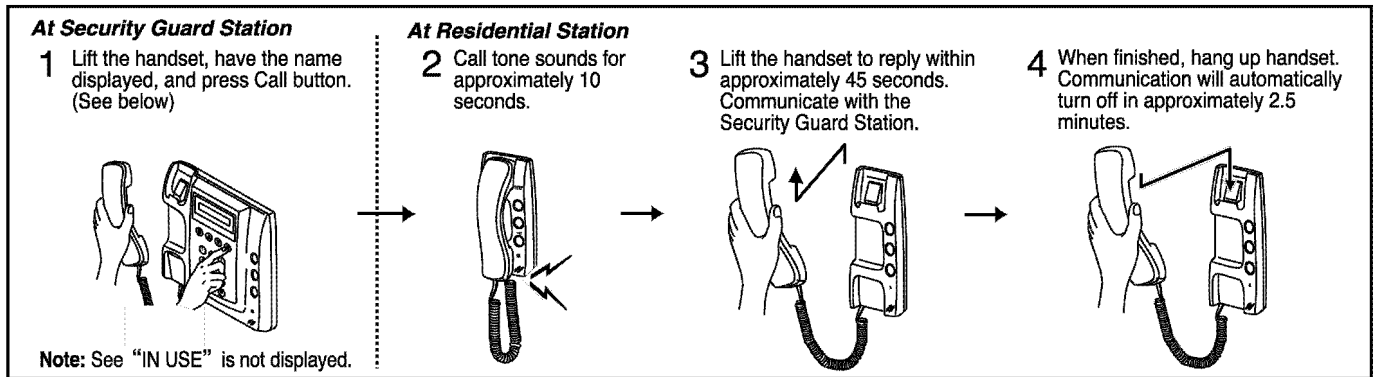

### 1. Calling

#### (1) By Scrolling Names

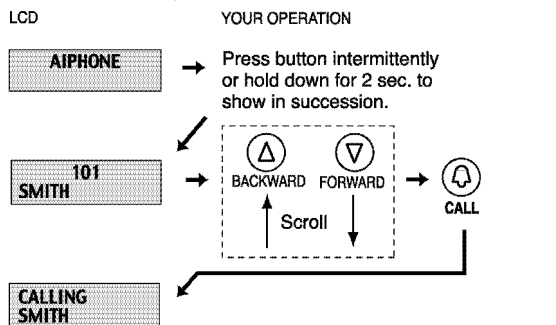

#### (2) By Dialing a Room Number

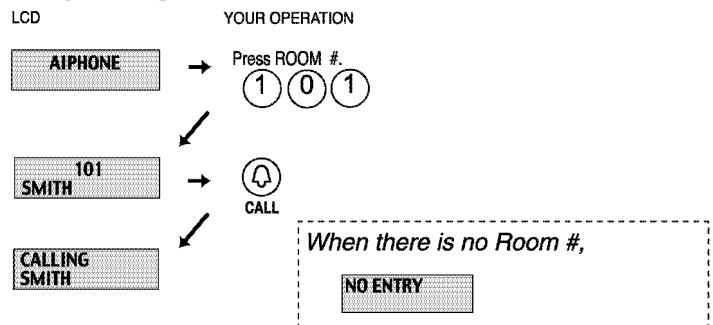

#### (3) By Selecting Name Entering Alphabets

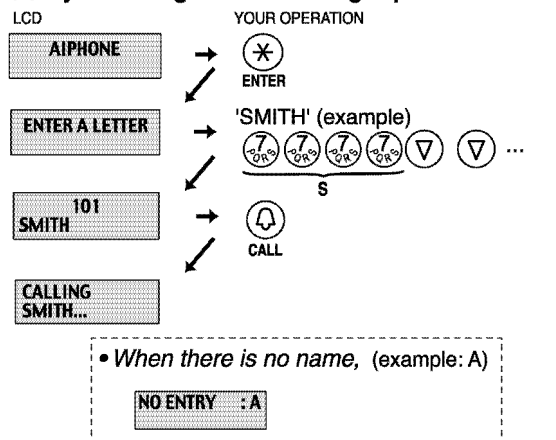

### 2. Communication (common operation)

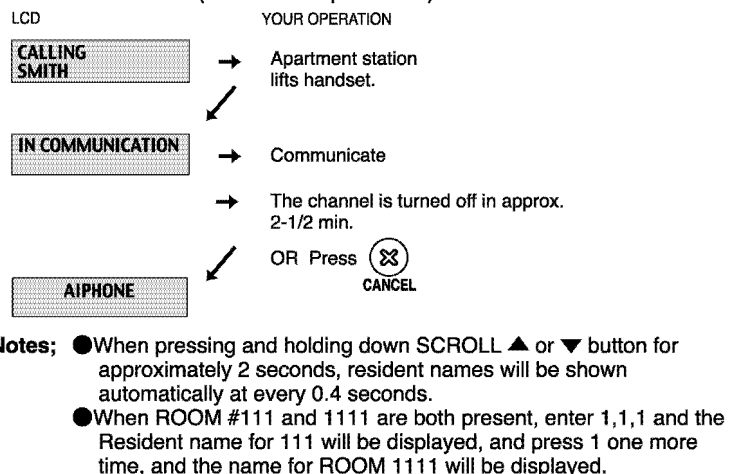

### Receiving a call from Residential station

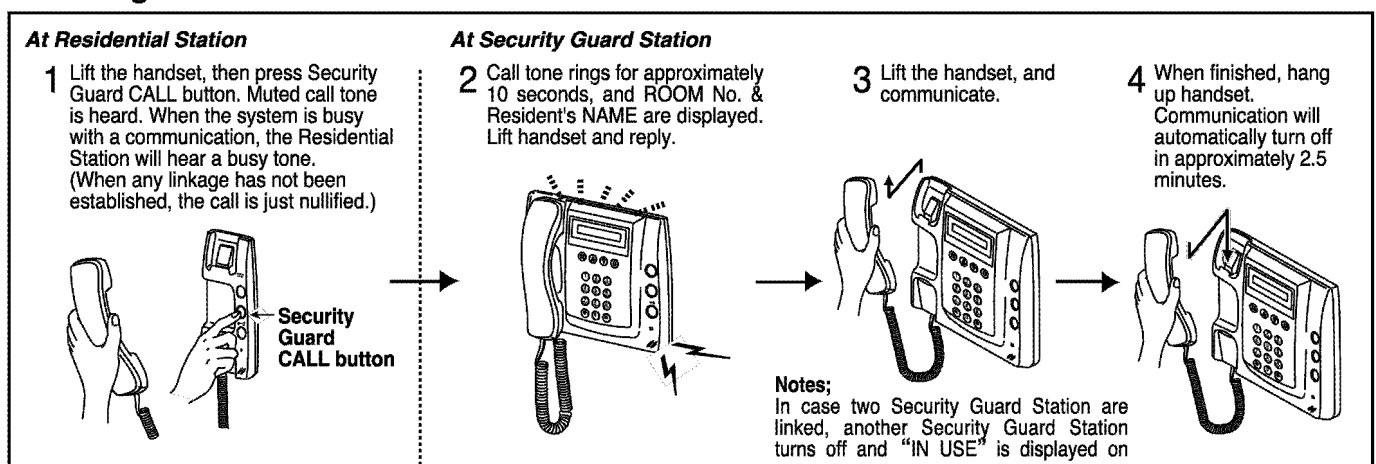

# WITH ENTRANCE STATION

## Receiving a call from Entrance Station

Requires name registration and linkage.

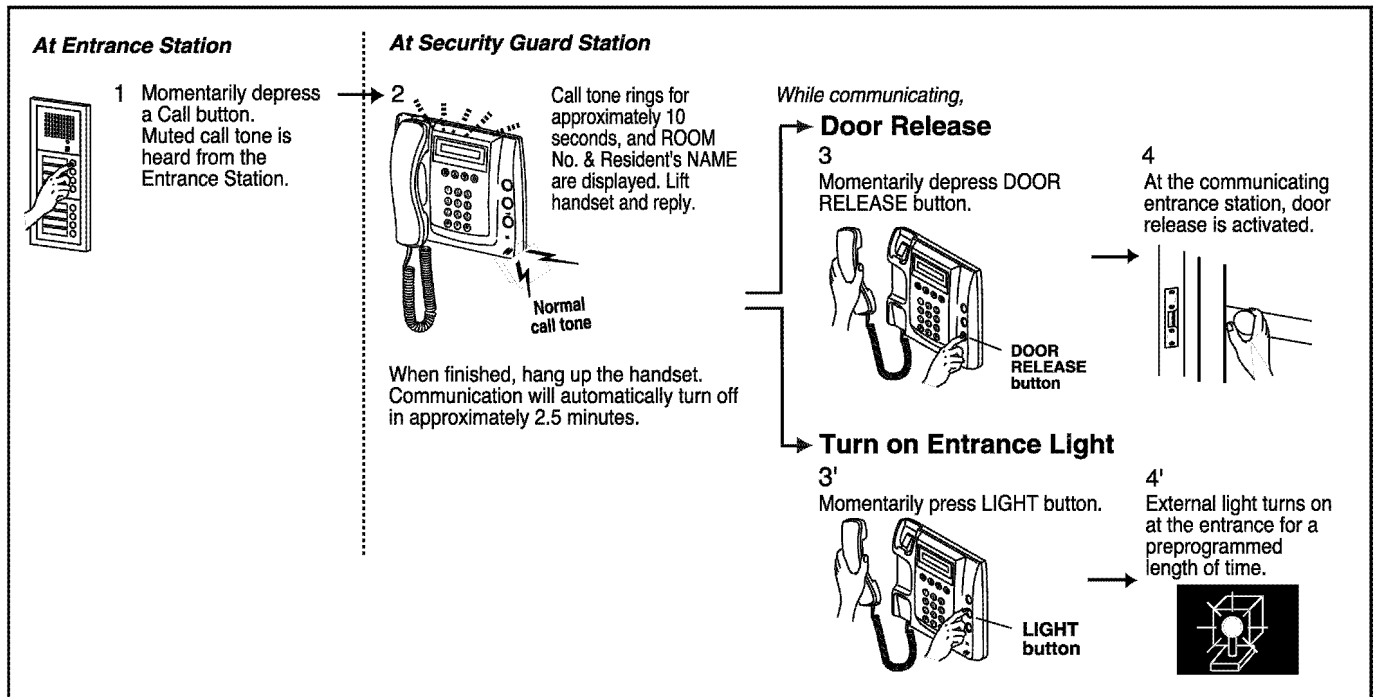

## Calling Entrance Station

Does not require name registration or linkage.

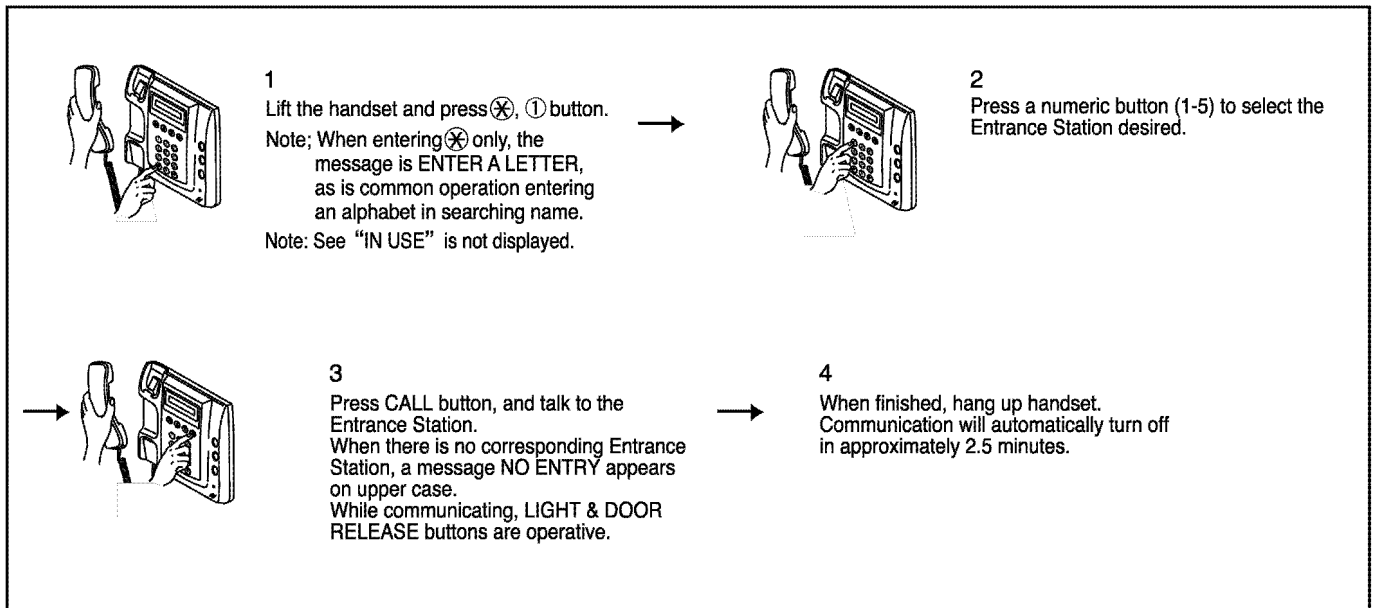

# BETWEEN SECURITY GUARD STATIONS

## At Calling Station

1

Lift the handset, press **⊗**, **①** buttons.  
Press **①** button, and CALL button.  
Muted call tone is heard from handset receiver.

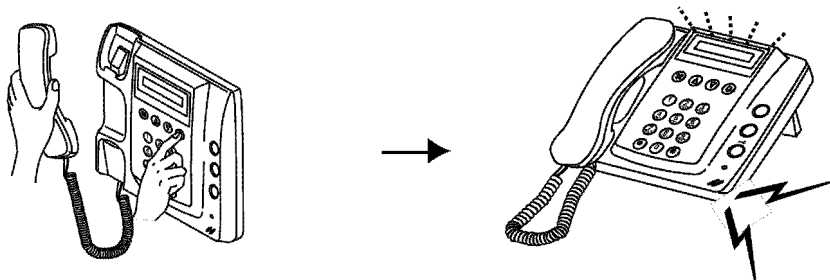

Notes: • See "IN USE" is not displayed at start of operation.  
• When entering **⊗** only, the message is ENTER A LETTER, as is common operation entering an alphabet in searching name as well.  
• When no Security Guard Station is registered, a message NO ENTRY comes on.

# PANIC CALL

## At Security Guard Station

3

Alarm sounds, and ROOM No. and EMERGENCY with Resident NAME, are displayed alternately. Stop alarm by pressing **⊗** CANCEL button.

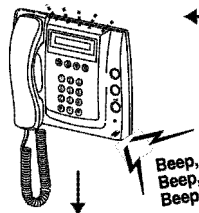

## PANIC CALL answer-back

4

Lift the handset, see the name on LCD display, and press RESIDENCE CALL button.

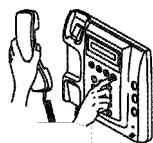

8

Press **⊗** CANCEL button to clear signal.

## At Residential Station

2

Alarm sounds from Residential Station.

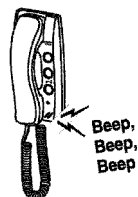

5

The alarm turning to normal call tone, sounds for approximately 45 seconds.

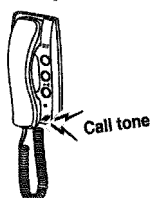

1

Push PANIC CALL switch\* to lock.

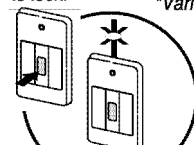

Or Line-off trouble takes place

6

Lift the handset and communicate with Security Guard Station.

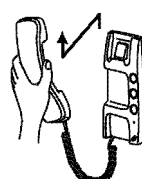

After communication, PANIC CALL alarm sounds comes back on.

7

Unlock PANIC CALL switch to place in standby.

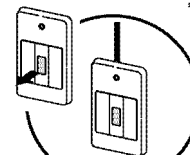

Restores to normal.

- Notes;**
1. When one Security Guard Station is already engaged in PANIC CALL and communication, the other Security Guard Station can not break in. (The busy tone is heard from the handset receiver.)
  2. At the Security Guard Station, either answer-back to a PANIC CALL originated Residential Station, or normal calling to other Residential Station is selectable. (Only name scroll buttons are not operational.) When the system is occupied, it can not operate.
  3. At the Residential Station, the PANIC CALL alarm sounds at the HIGH level regardless of adjusting of volume control.
  4. Even when the system is occupied, PANIC CALL can be activated. (Up to 10 Residential Stations can be linked with Security Guard Station.
  5. Security Guard Station, when received multiple PANIC CALLs, will have NEXT ALARM message displayed.
  6. When the Arrow message is present, it is possible to select other Residential Stations with SCROLL buttons.
  7. Even when system is occupied, PANIC CALL answer-back initiates after the other communication is turned off.
  8. At the Residential Station in same room, while sounding PANIC CALL signal, normal call or doorbell call can not be received. Answer-back from Security Guard Station is only available.

# MOUNTING

## Desk-top mounting on GFW-S stand

1. Separate mounting bracket on back of the unit.
2. Attach mounting bracket to GFW-S stand as shown.
3. Connect wires on terminal block, putting wires neatly in the slot.   
 ⚠ Unit cable with stand hook by convex to prevent to death by pulled out.

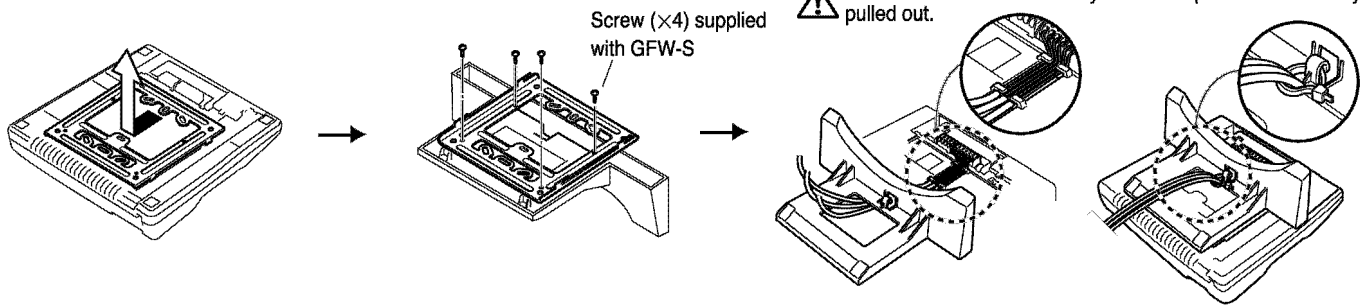

4. Place protection cover on terminal section.
5. Insert prongs of bracket and slide upward until locked.

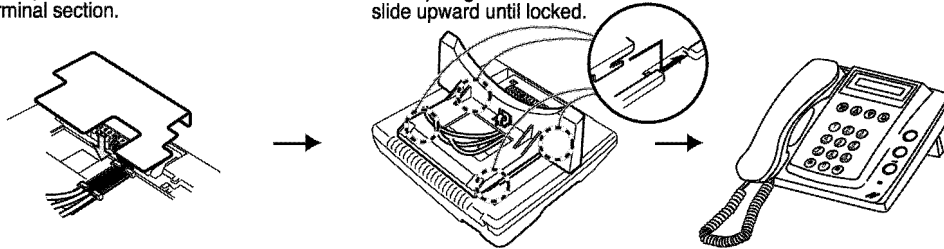

### GFW-S (not included) PACKAGE CONTENTS

- Desk-top stand (GFW-S)
- Packet of screws
- Convex

## Wall-mounting

It is suggested to mount the station so that the LCD display comes at the user's eye level.

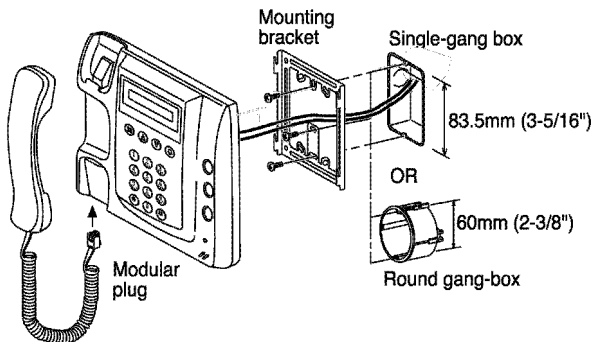

1. Attach the mounting bracket to Single-gang box.
2. Connect wires on terminal block.
3. Mount the unit on mounting bracket.

### Notes; To detach terminal block;

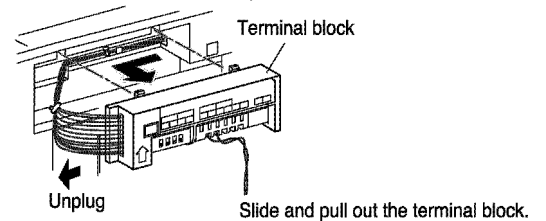

- ⚠ Strip cable jackets, and put all the wires neatly into slot, otherwise damages the wires by pinching.

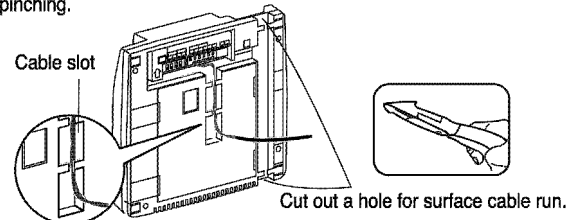

## WIRING

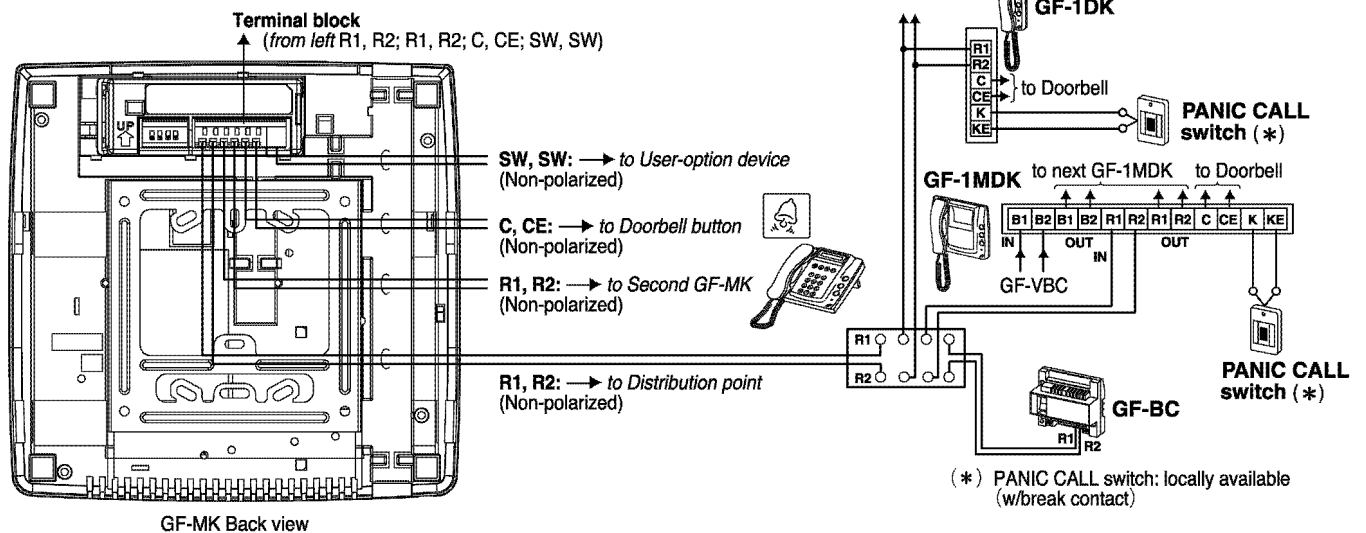

# TECHNICAL PRECAUTIONS

**Ambient temperature:** 0°C~40°C (+32°F~+104°F).  
**Asking for repairs:** In case the unit does not operate properly, ask qualified technician to repair it.  
**Cleaning:** Clean the equipment with a soft cloth dampened with neutral household cleanser. Never use any abrasive cleaner or cloth.

**Adjusting call tone volume;**

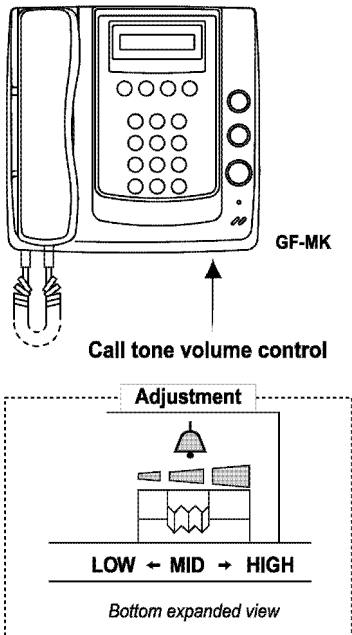

Call tone volume control

Adjustment

LOW ← MID → HIGH

*Bottom expanded view*

**Setting switches;**

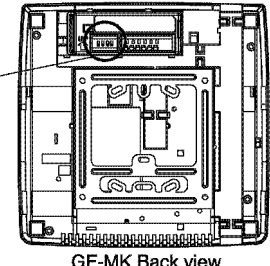

GF-MK Back view

**When you forgot your ID code**

ON  
↑ ↓  
1

Turn the switch on for approx. 2 sec.

↓

The ID code returns to initial (\*1111).

2: Remains unused.

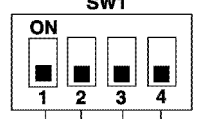

3: Remains unused.

**For the second Security Guard Station**

ON  
↑  
4

Put the switch 4 to ON position.

**Note;** After wiring, be sure to set for second GF-MK station, which must not be rechanged. If forgotten, "CALL-ID#ERROR" message will be displayed. In this case, put DIP SW4 to ON while GF-BC is turned off, and repower it.

## SPECIFICATIONS (GF-MK)

**LCD display:** Max. 16 letters for names.  
**Dimensions:** 210 H x 215 W x 69 D (mm). 8-1/4" H x 8-1/2" W x 2-3/4" D.  
**Unit weight:** Approximately 900g (1.98 lbs.)

This equipment has been tested and found to comply with the limits for a Class B digital device, pursuant to Part 15 of the FCC Rules. These limits are designed to provide reasonable protection against harmful interference in a residential installation. This equipment generates, uses, and can radiate radio frequency energy and, if not installed and used in accordance with the instructions, may cause harmful interference to radio communications. However, there is no guarantee that interference will not occur in a particular installation. If this equipment does cause harmful interference to radio or television reception, which can be determined by turning the equipment off and on, the user is encouraged to try to correct the interference by one or more of the following measures:

- Reorient or relocate the receiving antenna.
- Connect the equipment into an outlet on a circuit different from that to which the receiver is connected.
- Increase the separation between the equipment and receiver.
- Consult the dealer or an experienced radio/TV technician for help.

### WARRANTY

Aiphone warrants its products to be free from defects of material and workmanship under normal use and service for a period of one year after delivery to the ultimate user and will repair free of charge or replace at no charge, should it become defective upon which examination shall disclose to be defective and under warranty. Aiphone reserves unto itself the sole right to make the final decision whether there is a defect in materials and/or workmanship; and whether or not the product is within the warranty.

This warranty shall not apply to any Aiphone product which has been subject to misuse, neglect, accident, or to use in violation of instructions furnished, nor extended to units which have been repaired or altered outside of the factory. This warranty does not cover batteries or damage caused by batteries used in connection with the unit.

This warranty covers bench repairs only, and any repairs must be made at the shop or place designated in writing by Aiphone. Aiphone will not be responsible for any costs incurred involving on site service calls.

AIPHONE CO., LTD., NAGOYA, JAPAN  
 AIPHONE CORPORATION, BELLEVUE, WA, USA  
 AIPHONE EUROPE N.V., ANTWERP, BELGIUM

**AIPHONE®**

*Providing Peace of Mind*

<http://www.aiphone.com/>

*Printed in Thailand (E)*



## Free Manuals Download Website

<http://myh66.com>

<http://usermanuals.us>

<http://www.somanuals.com>

<http://www.4manuals.cc>

<http://www.manual-lib.com>

<http://www.404manual.com>

<http://www.luxmanual.com>

<http://aubethermostatmanual.com>

Golf course search by state

<http://golfingnear.com>

Email search by domain

<http://emailbydomain.com>

Auto manuals search

<http://auto.somanuals.com>

TV manuals search

<http://tv.somanuals.com>