



**SkyIPCam1620W**  
**Wireless N MPEG4 3GPP Network Camera**

Model # AIC1620W

**User's Manual**

Ver. 1.0

# Table of Content

<b>CHAPTER 1</b> .....	<b>2</b>
<b>INTRODUCTION TO YOUR CAMERA</b> .....	<b>2</b>
1.1 Checking the Package Contents .....	2
1.2 Getting to Know Your Camera .....	2
1.3 Features and Benefits .....	4
1.4 System Requirements .....	5
1.5 Applications of the Camera .....	6
<b>CHAPTER 2</b> .....	<b>7</b>
<b>HARDWARE INSTALLATION</b> .....	<b>7</b>
2.1 Connecting Your Camera to LAN .....	7
<b>CHAPTER 3</b> .....	<b>9</b>
<b>CAMERA CONFIGURATION</b> .....	<b>9</b>
3.1 Setting up Your Camera .....	9
3.2 Viewing Image via Your Camera .....	16
<b>CHAPTER 4</b> .....	<b>19</b>
<b>USING WEB CONFIGURATION</b> .....	<b>19</b>
4.1 Basic Setup .....	19
4.2 Network Settings .....	22
4.3 Setting up Video & Audio .....	28
4.4 Event Server .....	32
4.5 Motion Detect .....	35
4.6 Event Config .....	36
4.7 Tools .....	40
4.8 RS-485 .....	41
4.9 Information .....	43
<b>CHAPTER 5</b> .....	<b>44</b>
<b>USING SKYIPCAM ULTRAVIEW</b> .....	<b>44</b>
5.1 Starting the Program .....	44
5.2 Main Window and Item Feature .....	45
5.3 Accessing the Camera .....	48
5.4 Recording / Playing Video .....	53
5.5 Configuring the eMap View Setting .....	57
5.6 Configuring the System .....	62
5.7 Event Configuration .....	63
5.8 Changing System Language .....	66
5.9 Terminating Operation .....	67
<b>CHAPTER 6</b> .....	<b>68</b>
<b>APPENDIX</b> .....	<b>68</b>
A.1 Specification .....	68
A.2 GPIO Terminal Application .....	69
A.3 Bandwidth Reference Guide .....	70
A.4 Glossary of Terms .....	71
<b>TECHNICAL SUPPORT</b> .....	<b>75</b>

# CHAPTER 1

---

## INTRODUCTION TO YOUR CAMERA

### 1.1 Checking the Package Contents

Check the items contained in the package carefully. You should have the following:

- ☑ One SkyIPCam1620W Wireless N MPEG4 3GPP Network Camera
- ☑ One 2dBi Dipole Antenna
- ☑ One AC Power Adapter
- ☑ One Wall Mount Kit
- ☑ One GPIO & RS485 Adapter
- ☑ One Ethernet Cable (Cat.5)
- ☑ One Setup CD
- ☑ One Quick Installation Guide

**NOTE** Once any item contained is damaged or missing, contact the store where you purchased the product.

### 1.2 Getting to Know Your Camera

#### ■ Front and Top View

##### LED Indicators:

**Power** (left, steady amber light) indicates the camera is powered on.

**Link** (right, flashing green light) indicates the camera's network connectivity.

**Screw Hole\*** is used to attach the camera stand onto the camera by screwing the screw head of the camera stand into the screw hole of the camera.

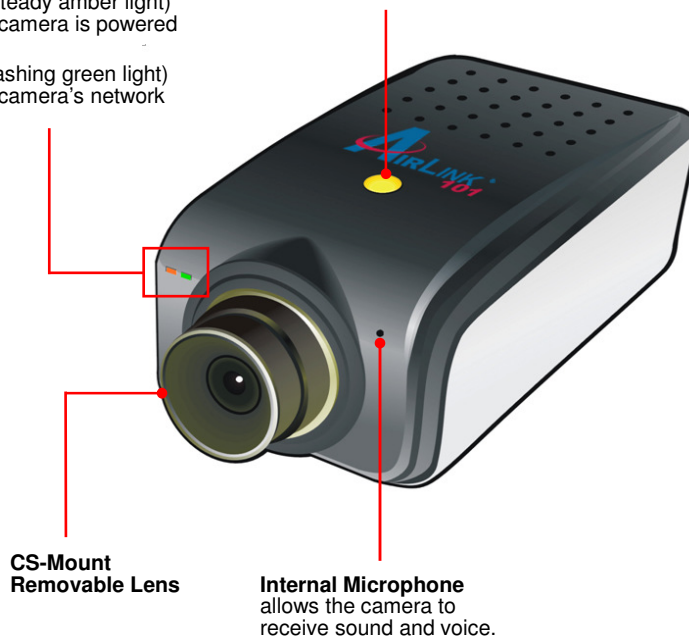

**CS-Mount Removable Lens**

**Internal Microphone** allows the camera to receive sound and voice.

\* The camera provides two screw holes that are located on its top and bottom panels, so that you can install the camera according to your application.

## ■ Rear View

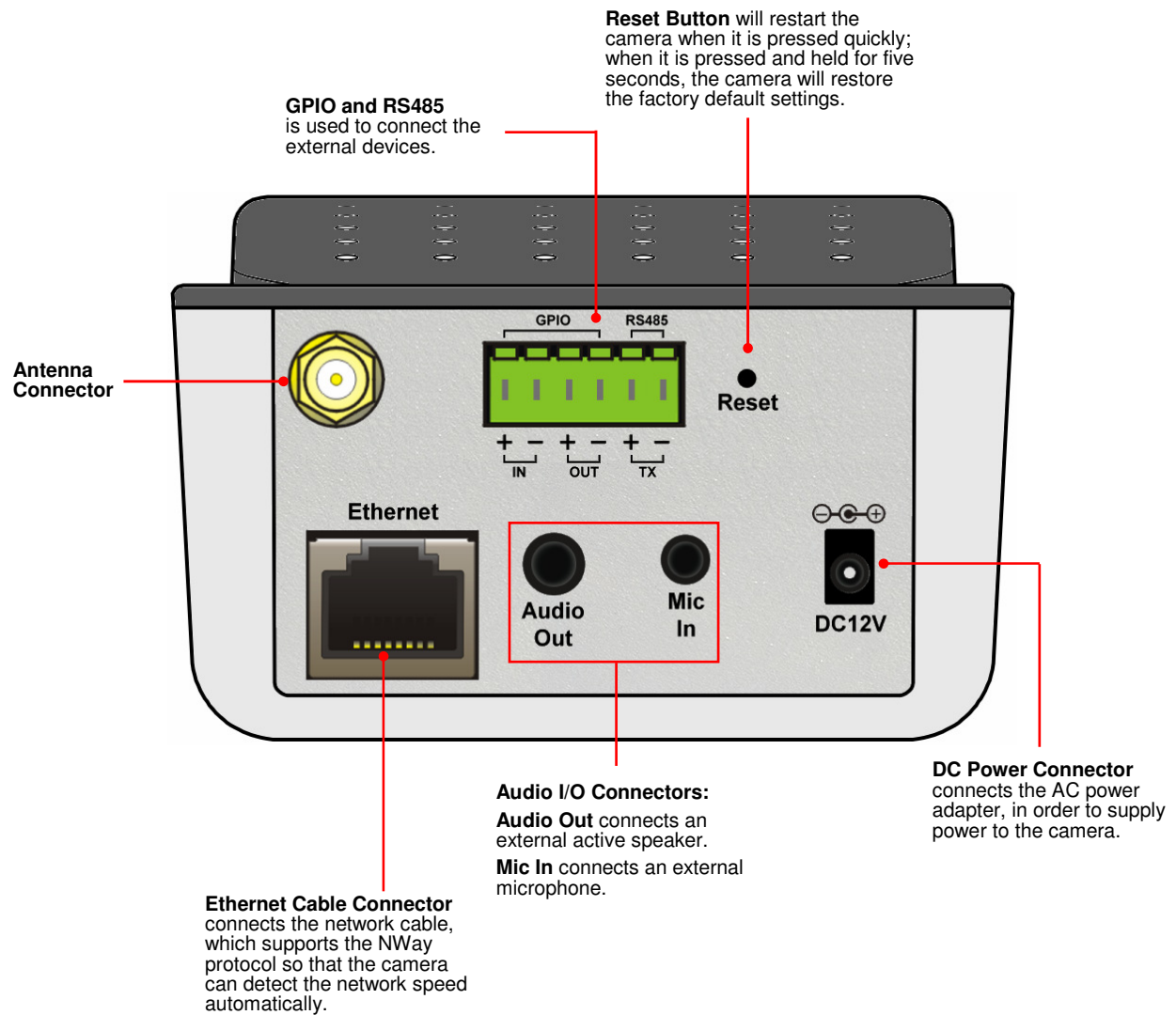

## 1.3 Features and Benefits

Thank you for purchasing the SkyIPCam1620W Wireless N MPEG4 3GPP Network Camera, a standalone system that can be connected directly to your network.

With MPEG4 image compression technology, you can record streaming video that utilizes high quality images to your hard drive, enable motion detection and set up automated e-mail alerts for security. The built-in microphone and audio ports provide you with the extensive 2-Way Audio function, allowing you to “listen” and “talk” to the area monitored by the camera. The camera can be managed remotely, so that you can use a web browser to access and control it from any desktop/notebook computer or mobile phone over the Intranet or Internet.

The simple installation procedures and web-based interface allow you to integrate it into your wired or wireless network easily. The camera features Wireless N technology which provides higher bandwidth and faster transmission speed as well as great flexibility of installation. With comprehensive applications supported, the camera is your best solution for demanding surveillance and remote monitoring applications.

- **MPEG4/MJPEG Dual-codec Supported**

The camera provides you with excellent images by the MPEG4/ MJPEG dual-codec selectable technology, allowing you to adjust image size and quality, and bit rate according to the networking environment.

- **Flexible 2-Way Audio Capability**

The camera allows you to connect an external microphone to receive on-the-spot audio via the Internet, allowing you to monitor the on-site voice. In addition, you can connect an external active speaker to the camera to speak through the camera (supporting mono audio only).

- **Supports RTSP**

The camera supports RTSP (Real Time Streaming Protocol), which is a technology that allows you to view streaming media via the network. You can view the real-time video with the Quick Time player or RealPlayer. To view the real-time streaming image on your computer, open the RTSP supported player and enter the link:

[rtsp://\(IP address of the camera\)/mpeg4](rtsp://(IP address of the camera)/mpeg4).

- **I/O Connectors and RS-485 Provided**

The I/O connectors (IN/OUT) of the camera provide the physical interface to send and receive digital signals to a variety of external alarm devices (such as motion detection, event triggering, alarm notification, and a variety of external control functions). The pins TX+ & TX- of the I/O connectors are used for RS-485 data transmission, which allow you to connect a special featured device (such as an external camera stand with Pan/Tilt function), configure the settings and control the device from the **GPIO Trigger** window of Web Configuration.

- **Remote Control Supported**

By using a standard Web browser or the complimentary UltraView software application, the administrator can easily change the configuration of the camera via Intranet or Internet. In addition, the camera can be upgraded remotely when a new firmware is available. The users are also allowed to monitor the image and take snapshots via the network.

- **Multiple Profiles Supported**

The camera supports multiple profiles simultaneously, so that you can separately set up different image settings (such as image quality and frame rate) for the three video types of the camera: MPEG4, MJPEG, and 3GPP.

- **Multiple Platforms Supported**

The camera supports multiple network protocols, including TCP/IP, SMTP e-mail, HTTP, and other Internet related protocols. Therefore, you can use the camera in a mixed operating system environment, such as Windows 7 / Vista / XP.

- **Multiple Applications Supported**

Through the remote access technology, you can use the cameras to monitor various objects and places for your own purposes. For example, babies at home, patients in the hospital, offices and banks, and more. The camera can capture both still images and video clips, so that you can keep the archives and restore them at any time.

## 1.4 System Requirements

- **Networking**

- **LAN:** 10Base-T Ethernet or 100Base-TX Fast Ethernet; Auto-MDIX
- **WLAN:** Compatible with IEEE 802.11b/g/n networks, data rate up to 150Mbps\*

- **Accessing the Camera using Web Browser**

- **Supported Browsers:** Microsoft® Internet Explorer 6.0 or above; Apple Safari and Mozilla Firefox with JAVA plug-in for MJPEG and QuickTime plug-in for MPEG4
- **CPU:** Intel Pentium III 800MHz or above
- **RAM:** 512MB
- **Resolution:** 800x600 or above

- **Accessing the Camera using Software SkyIPCam UltraView**

- **Platform:** Microsoft® Windows® 7, Vista, and XP
- **Hard Disk:** 80GB or above
- **Resolution:** 1024x768 or above
- **Hardware Requirement\*\***
  - **1~8 cameras connected:** Intel Core 2 Duo; 2GB RAM
  - **9~32 cameras connected:** Intel Core 2 Quad; 4GB RAM

**NOTE** If you connect multiple cameras and monitor them simultaneously, it is recommended that you use a computer with higher performance.

## 1.5 Applications of the Camera

The SkyIPCam1620W can be applied in multiple applications indoor, including:

- Monitor local and remote places and objects via Internet or Intranet.
- Capture still images and video clips remotely.
- Upload images or send email messages with the still images attached.

The following diagram explains one of the typical applications for your camera and provides a basic example for installing the camera.

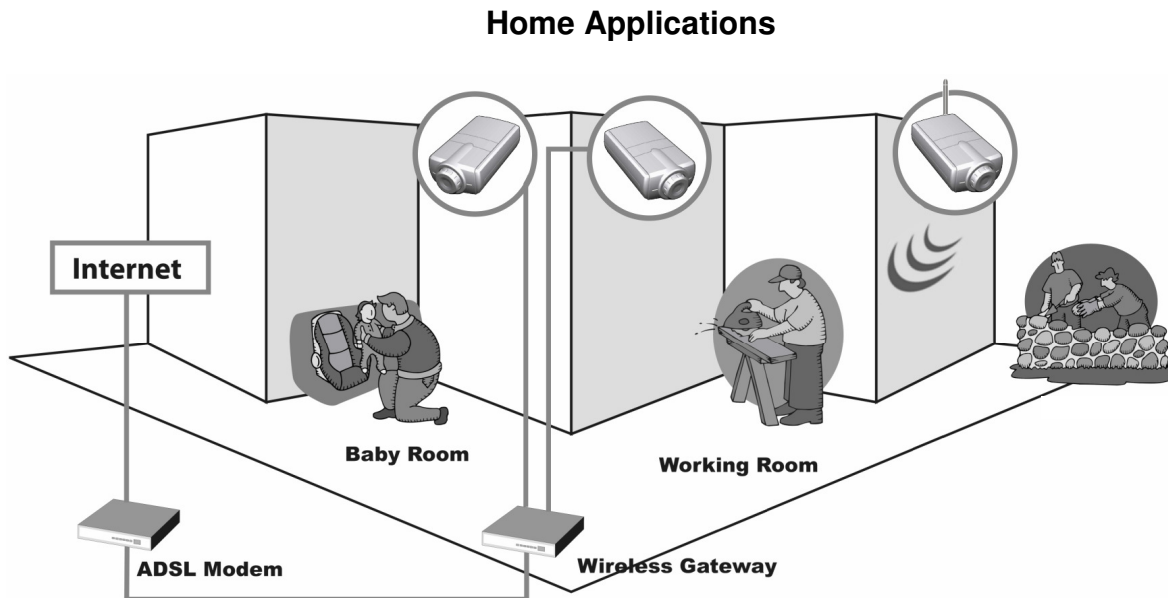

# CHAPTER 2

## HARDWARE INSTALLATION

### 2.1 Connecting Your Camera to LAN

**Step 1** Assemble and attach the provided wall mount kit to the camera.

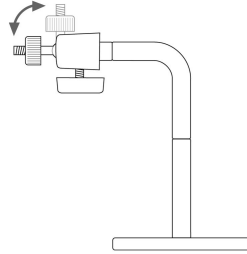

**Step 2** Attach the included external antenna to the camera.



**Step 3** Connect one end of a network cable to the IP Camera and connect the other end to one of the LAN ports on your router or switch.

**NOTE** You need to connect the camera to the local area network first in order to configure the wireless settings. After the setup finished, you will be able to disconnect the network cable

**Step 4** Power up the camera by connecting the supplied power adapter.

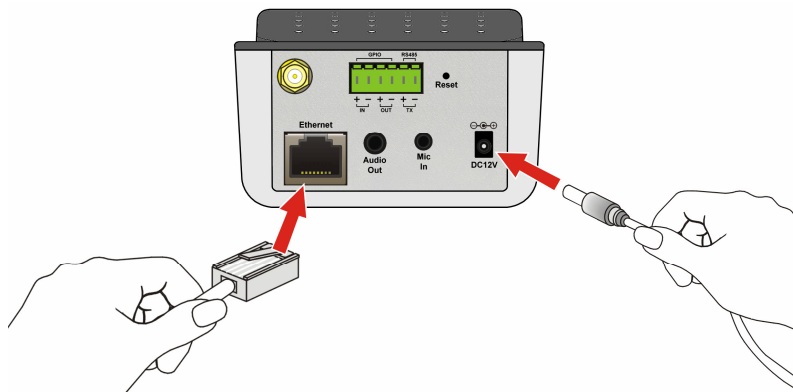



**Step 5** Please verify the LED status on the front panel and make sure it is on and ready for use now.

- **Power LED: Solid Amber**
- **Link LED: Flashing Green**

**Step 6** Please proceed to Chapter 3 for camera configuration.

# CHAPTER 3

---

## CAMERA CONFIGURATION

### 3.1 Setting up Your Camera

**Step 1** Insert the provided CD into your computer's CD ROM drive.

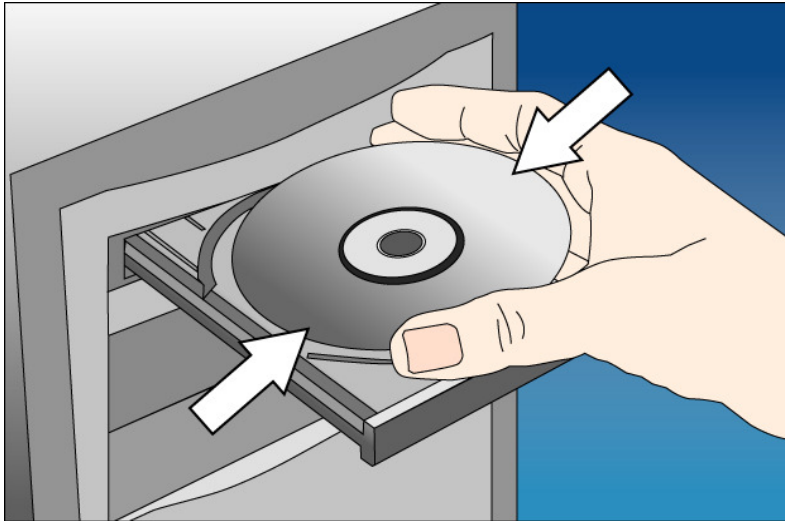

**Step 2** Click on **Install Utility and Software** when the autorun menu pops up on the screen.

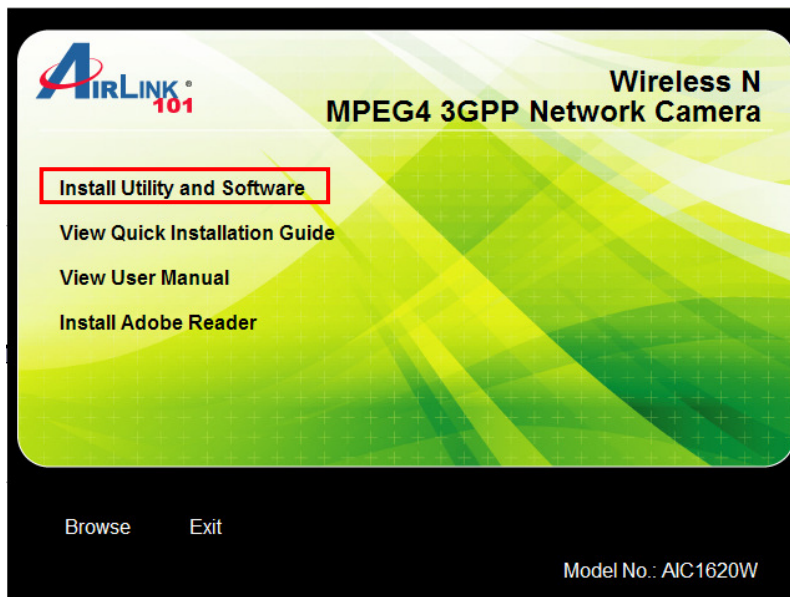

Note: If you do not see the autorun menu pops up on the screen, please go to your **CD-ROM drive** > **UltraView** folder > run "**Setup.exe**".

**Step 3** Click **Install** to install the utility.

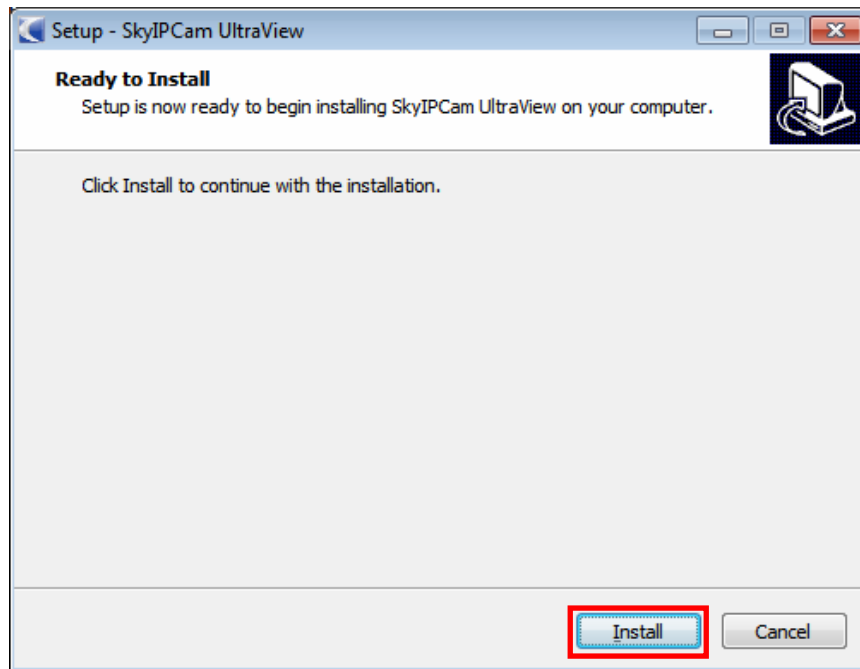

**Step 4** Click **Finish** when installation finishes.

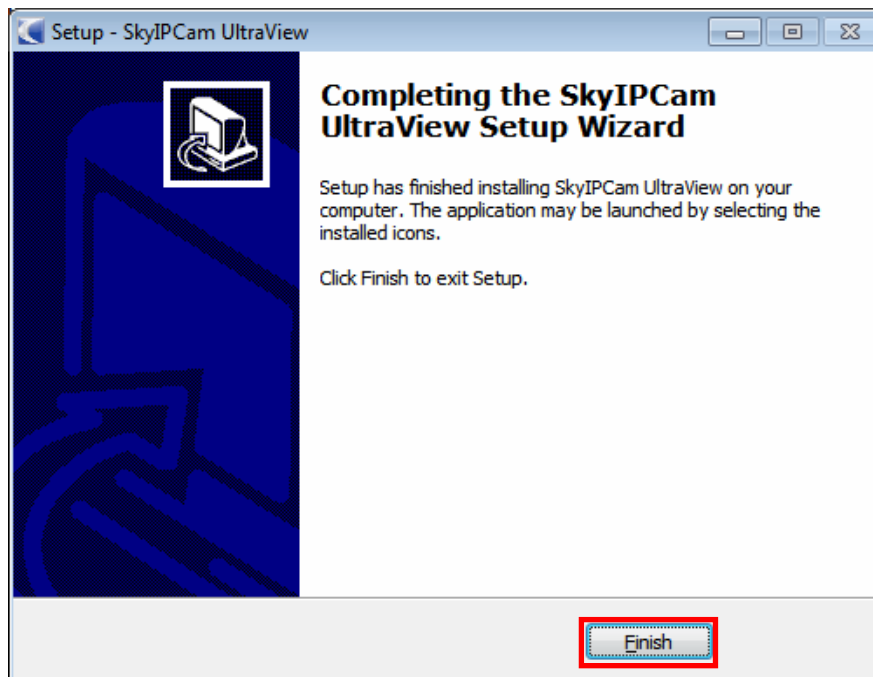

**Step 5** Open **SkyIPCam Utility** by double clicking on its icon on your desktop.

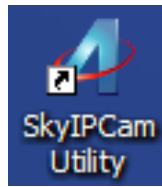

or clicking **Start**, then go to **(All) Programs > Airlink101 SkyIPCam UltraView > SkyIPCam Utility**.

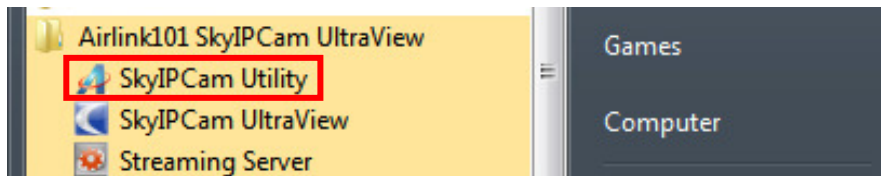

**Step 6** Click on **Search** to find the camera on your network. Select the Camera you wish to configure and click on **Link**.

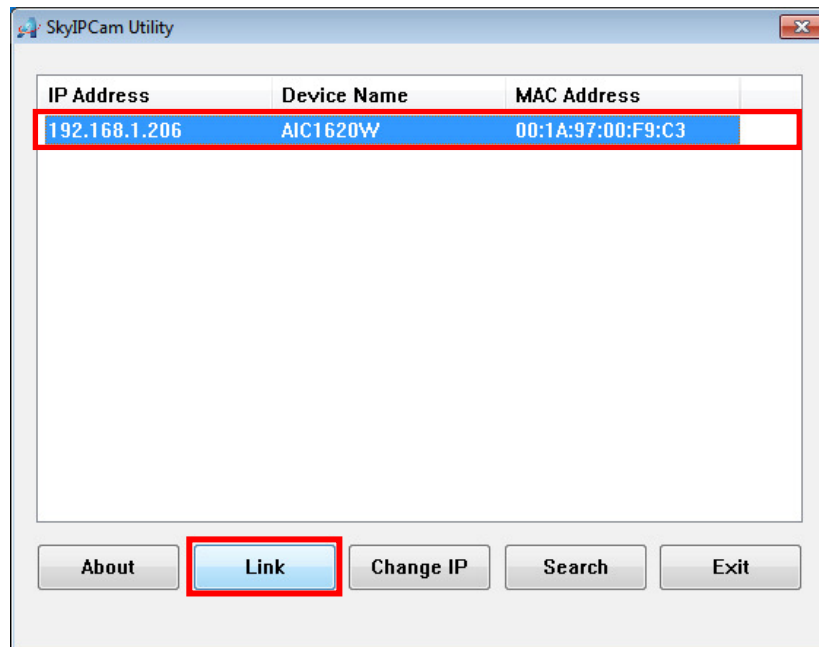

**Note** If the Camera you wish to configure does not show up in the utility, make sure the camera is properly connected to the same local network as your computer is, and the Green LED should be on. Click on **Search** to try again.

**Step 7** When you are prompted for the username and password, enter “**admin**” for both **Username** and **Password**, and click **OK**.

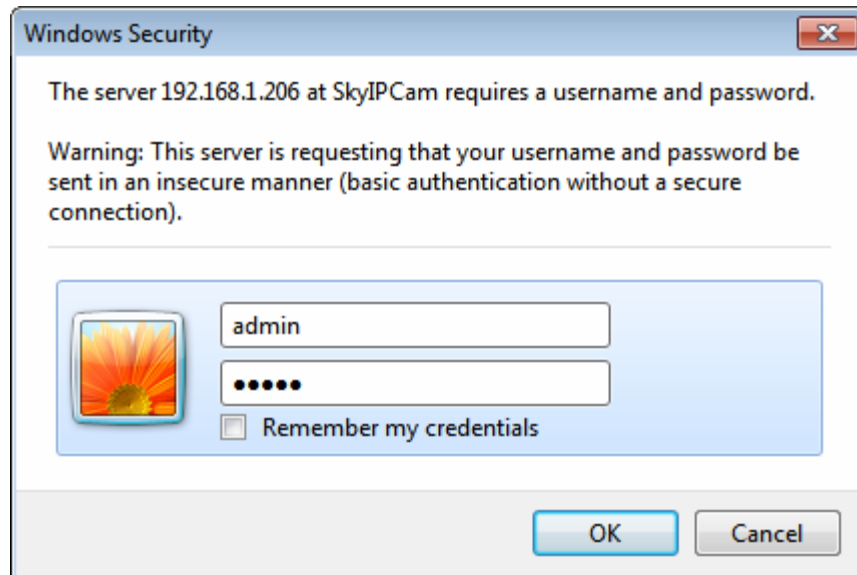

**Step 8** The camera viewing window will appear. Click on **Setup**, then click on **Smart Wizard**.

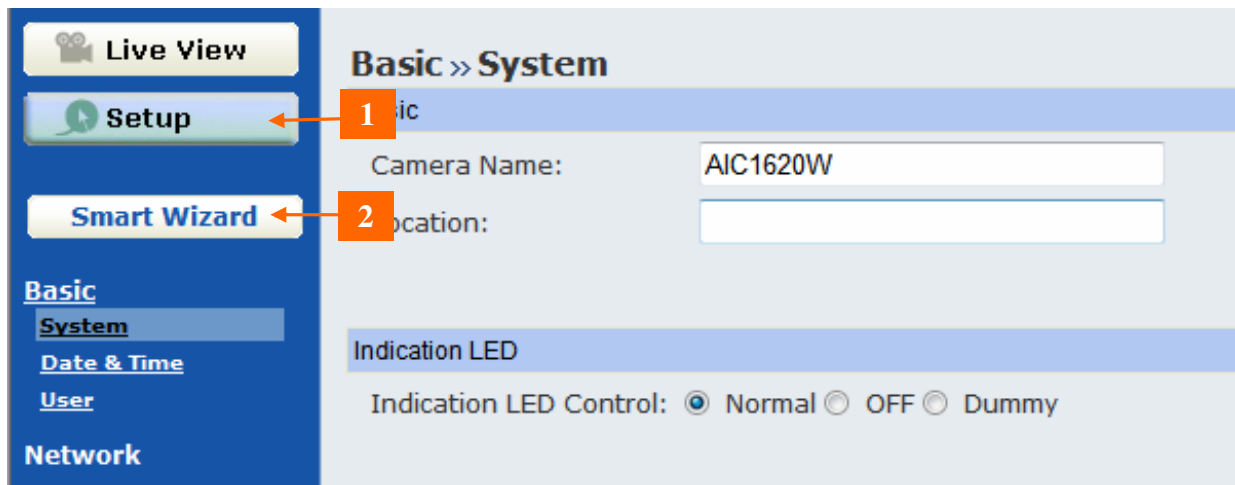

**Step 9** Enter a name for your camera and a location (i.e. Room 1). Create a password and enter it to **Admin Password** and **Confirm Password**. This will change the admin password of the camera. It is recommended to modify the admin's password to protect your privacy. Click **Next**.

Welcome to the Smart Wizard. This wizard will help you quickly set up the Network Camera to run on your network.

**Camera Setting**

**Camera Name:** Enter a descriptive name for the camera. For example, camera 1.

**Location:** Enter a descriptive name for the location used by the camera. For example, meeting room 1.

**Admin Password/Confirm Password:** Enter the administrator password twice to set and confirm the password to access the camera's Configuration Utility.

**Camera Setting**

Camera Name: AIC1620W

Location: Room 1

Admin Password: ●●●●

Confirm Password: ●●●●

Next > Cancel

**Step 10** You can specify a static IP address to this camera by selecting **Static IP**, and enter IP, Subnet Mask, Default Gateway, Primary/Secondary DNS addresses here provided by your ISP. If you are not sure how to configure Static IP Setting, please select **DHCP**. Click **Next**.

**IP Setting**

**DHCP:** Select this option when your network uses the DHCP server. When the camera starts up, it will be assigned an IP address from the DHCP server automatically.

**Static IP:** Select this option to assign the IP address for the camera directly.

- IP Address: For example, enter the default setting 192.168.2.240
- Subnet Mask: For example, enter the default setting 255.255.255.0
- Default Gateway: For example, enter the default setting 192.168.2.1
- Primary/Secondary DNS: Enter the DNS that are provided by your ISP.

**PPPoE:** Select this option when you use a direct connection via the ADSL modem. You should have a PPPoE account from your Internet service provider. Enter the user name and password in the following boxes. Please note that once the camera get an IP address from the ISP as starting up, it automatically sends a notification email to you. Therefore, when you select PPPoE as your connecting type, you have to set up the email configuration in next step .

**IP Setting**

DHCP

Static IP

IP: 192 . 168 . 1 . 206

Subnet Mask: 255 . 255 . 255 . 0

Default Gateway: 192 . 168 . 1 . 1

Primary DNS: 4 . 2 . 2 . 1

Secondary DNS: 4 . 2 . 2 . 5

PPPoE

User Name:

Password:

< Prev Next > Cancel

**Note** Be sure to enter Primary/Secondary DNS addresses assigned by your ISP if you set up Static IP for the camera so that the Email alert / FTP uploading can function properly.

**Step 11** If you would like to set up email alerts that you can receive in the future, enter your email information here. You can get this information from your Internet Service Provider. You can set this up at a later time. Click **Next**.

**Email Setting**

**SMTP Server Address:** Enter the mail server address. For example, mymail.com.

**Port Number:** Enter the mail server port number.

**Sender Email Address:** Enter the email address of the user who will send the email. For example, John@mymail.com.

**Authentication Mode:** If the mail server needs to login, please select SMTP.

**Sender User Name:** Enter the user name to login the mail server.

**Sender Password:** Enter the password to login the mail server.

**Receiver #1 Email Address:** Enter the first email address of the user who will receive the email.

**Receiver #2 Email Address:** Enter the second email address of the user who will receive the email.

SMTP Server Address: mymail.com

Port Number: 25

Sender Email Address: user1@mymail.com

Authentication Mode:  None  SMTP

Sender User Name: user1@mymail.com

Sender Password: ●●●●●●

Receiver #1 Email Address: abc@email.com

Receiver #2 Email Address:

< Prev Next > Cancel

**Step 12** Enter the Network ID (SSID) of your wireless network, or click on **Site Survey** and select from the list. Select the **Authentication** and **Encryption**, and enter the security **Key** of your wireless network. This information is stored in your wireless AP/router. Click **Next**.

**Wireless Networking**

**Network ID(SSID):** To connect the camera to a specified access point, set a SSID for the camera to correspond with the access point's ESS-ID. To connect the camera to an Ad-Hoc wireless workgroup, set the same wireless channel and SSID to match with the computer's configuration. Click **Site Survey** to display the available wireless networks, so that you can easily connect to one of the listed wireless networks.

**Wireless Mode:** Select the type of wireless communication for the camera.

- Infrastructure
- Ad-Hoc

**Channel:** Select the appropriate channel from the pull-down list.

**Authentication:** Select the authentication method to secure the camera from being used by unauthorized user.

- Open: The default setting of Authentication mode, which communicates the key across the network.
- Shared-key: Allow communication only with other devices with identical WEP settings.
- WPA-PSK/WPA2-PSK: Specially designed for the users who do not have access to network authentication servers. The user has to manually enter the starting password in their access point or gateway, as well as in each PC on the wireless network.

Network ID(SSID): airlink101 Site Survey

Wireless Mode:  Infrastructure  Ad-Hoc

Channel: 6

Authentication: WPA2-PSK

Encryption:  TKIP  AES

Pre-Shared Key:

< Prev Next > Cancel

**Note** You may contact the manufacturer of your wireless router/AP's to find out its SSID and wireless security settings.

**Step 13** Confirm your settings at this page. If everything is correct, click **Apply** to save the settings, then the camera will restart in 50 seconds.

**Confirm Settings**

Please confirm the configuration you have set up. When you confirm the settings, click **Apply** to finish the wizard and reboot the camera. Otherwise, click **prev** to go back to the previous step(s) and change the settings; or click **Cancel** to end the wizard and discard the changes.

Please note that the camera's IP Address will be updated if you changed the IP setting. This may cause the camera to lose the image screen. If this happens, use the supplied IP Finder software application to locate the camera's IP Address. Then, connect to the camera to resume the image screen.

**Confirm Settings**

Camera Name: AIC1620W  
Location: Room 1  
IP Mode: Static  
IP Address: 192.168.1.206  
Subnet Mask: 255.255.255.0  
Default Gateway: 192.168.1.1  
Primary DNS:  
Secondary DNS:  
SMTP Server Address: mymail.com  
Port Number: 25  
Sender Email Address: user1@mymail.com  
Authentication Mode: SMTP  
Sender User Name: user1@mymail.com  
Receiver #1 Email Address: abc@email.com  
Receiver #2 Email Address:  
ESSID: trigger  
Connection: Infrastructure  
Channel: 6  
Authentication: Open  
Encryption: WEP

< Prev Apply Cancel

**Step 14** After the camera is restarted, you can unplug the network cable from it. It will take around 1 or 2 minutes for the camera connecting to the wireless router/AP.

To make sure the wireless connection is successfully established, open the **SkyIPCam Utility** and click on **Search**. If the camera shows up in the list, it is connected to your wireless network successfully. If not, please verify the SSID and the wireless security settings you configured at **Step 12** are correct.

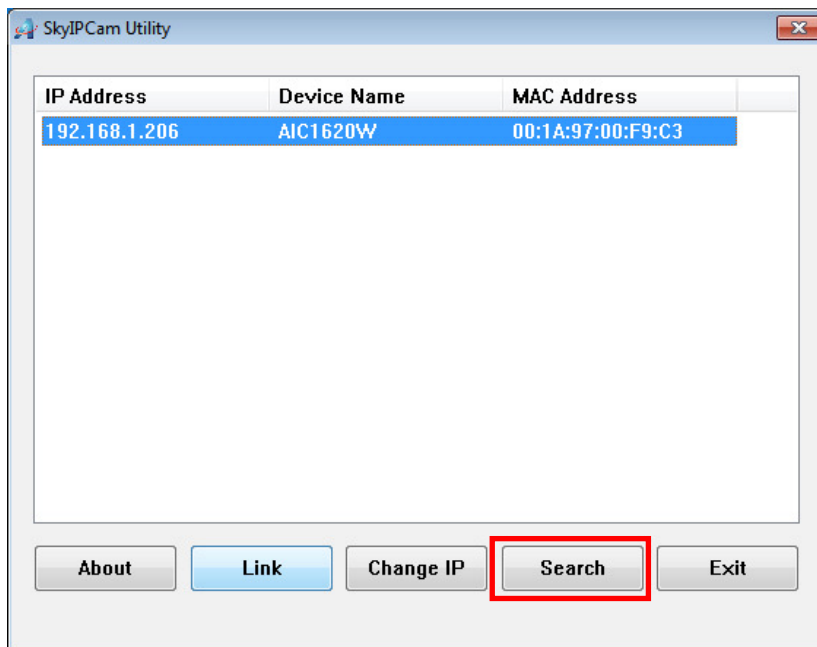



## 3.2 Viewing Image via Your Camera

### *Method A > Access Camera from SkyIPCam Utility*

**Step 1A** Open Airlink101 SkyIPCam Utility, select the camera you wish to connect to and click on **Link** button. Go to **Step 3**.

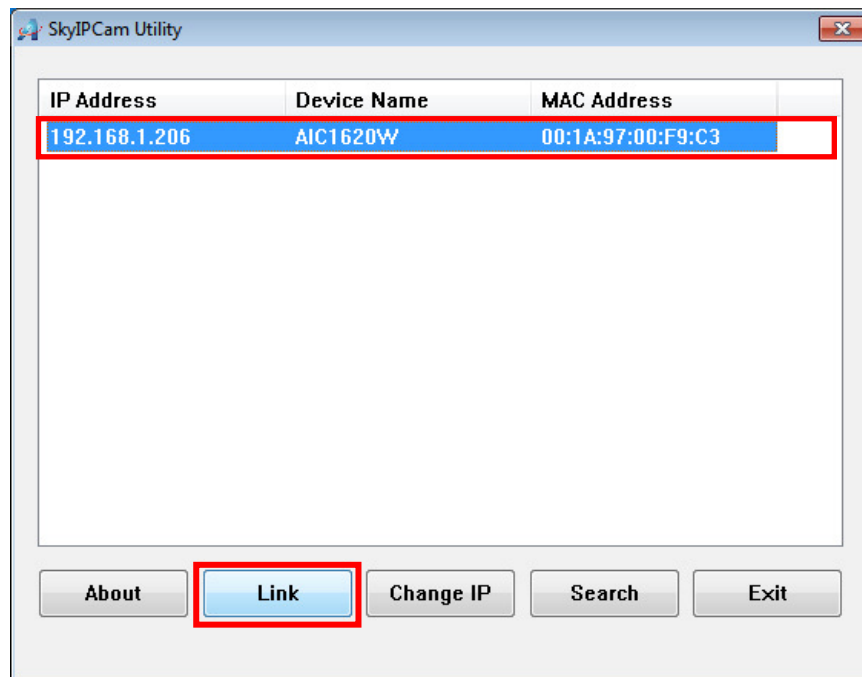

### *Method B > Access Camera from Web Browser*

**Step 1B** If you have assigned a static IP address for your camera, you may open the Web Browser on your computer.

**Step 2B** Type the IP address of your camera in the Address bar, and press **Enter**.

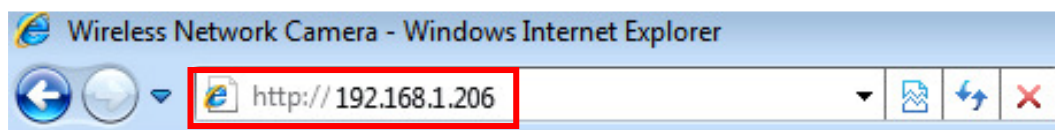

**Step 3** Enter administrator's username and password of the camera, then click **OK**. The default username and password are both "admin" if you did not make any change to it at Step 9, Section 3.1.

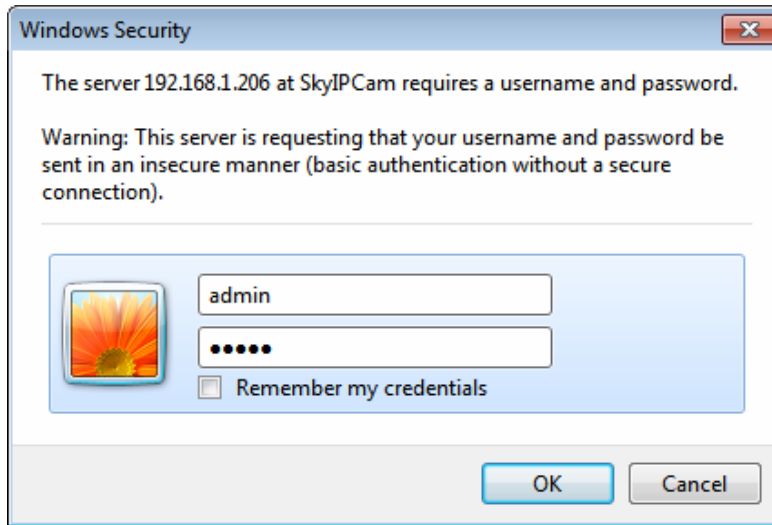

**Step 4 Internet Explorer User:** If this is the first time for your computer to view image from the web configuration page, you will be prompted to install the ActiveX Control. Click on the bar on top of the screen and click on **Run Add-on** or **Install ActiveX Control** (depends on different IE versions).

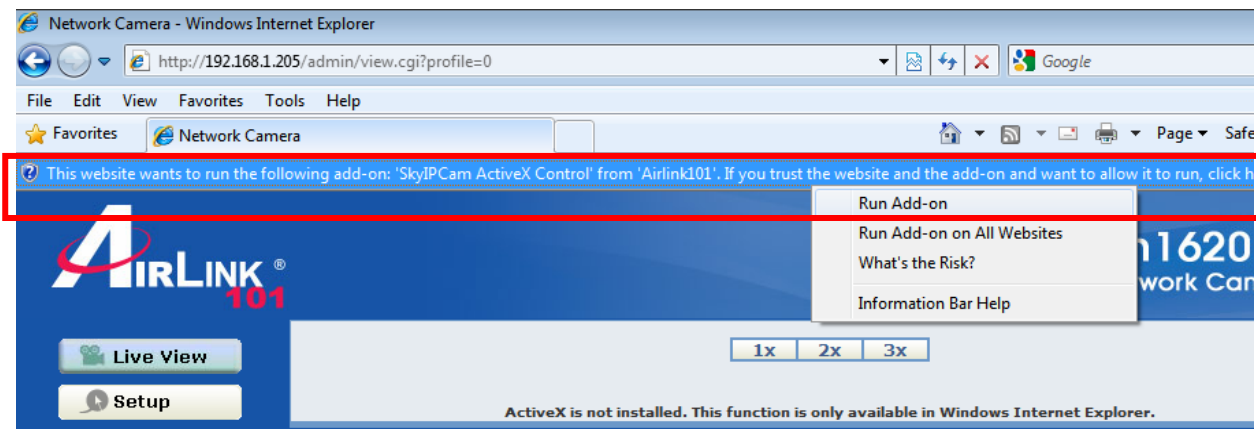

**Step 5** Click on **Run**, then you will be able to view the image.

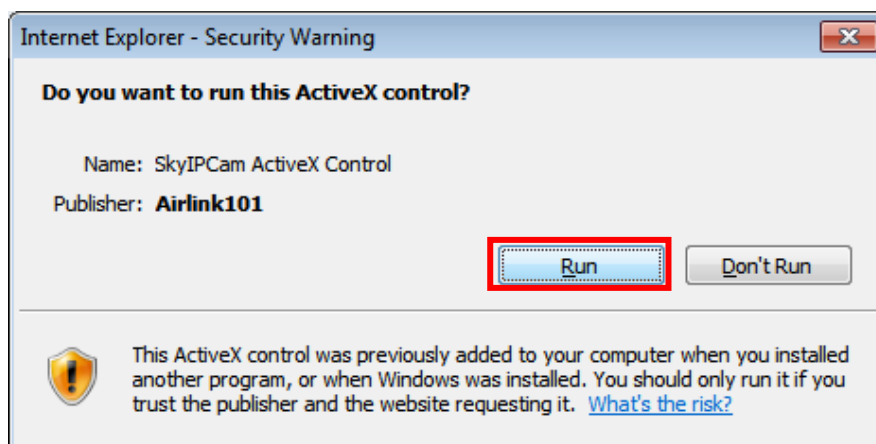



**Note** If you are using Mozilla Firefox or Safari and you are not able to view any image, please make sure you have Java and Quick Time add-ons installed.

# CHAPTER 4

## USING WEB CONFIGURATION

You can access and manage the camera through the Web browser and the provided software application SkyIPCam UltraView. This chapter describes the Web Configuration, and guides you through the configuration of the camera by using the web browser.

To open the Web Configuration page, please refer to **Chapter 3.2**, Viewing Image via Your Camera.

After you entered into the Web Configuration of the camera, click **Setup** on the main page. The Web Configuration will start from the **Basic** page.

### 4.1 Basic Setup

The Basic menu contains three sub-menus that provide the system settings for the camera, such as the Camera Name, Location, Date & Time, and User management.

The screenshot shows the web configuration interface. On the left is a blue sidebar with navigation buttons: 'Live View', 'Setup', 'Smart Wizard', and a menu for 'Basic' (with sub-items: System, Date & Time, User), 'Network', 'Video/Audio', and 'Event Server'. The 'Basic >> System' page is displayed. It has a 'Basic' section with 'Camera Name' (AIC1620W) and 'Location' (Room 1) fields. Below is an 'Indication LED' section with 'Indication LED Control' options: Normal (selected), OFF, and Dummy. 'Apply' and 'Cancel' buttons are at the bottom right.

#### Basic >> System

##### ■ Basic

- **Camera Name:** Enter a descriptive name for the camera.
- **Location:** Enter a descriptive name for the location used by the camera.

##### ■ Indication LED

This item allows you to set the LED illumination as desired. The available options include: **Normal**, **OFF**, and **Dummy**. You can select OFF to turn off the camera's LED signal in order to make it less noticeable, or you can select Dummy to leave the Link LED be on even when it is not connected to the network.

## Basic >> Date & Time

### ■ Date & Time

- **TimeZone:** Select the proper time zone for the region from the pull-down menu.
- **Synchronize with PC:** Select this option and the date & time settings of the camera will be synchronized with the connected computer.
- **Synchronize with NTP Server:** Select this option and the time will be synchronized with the NTP Server. You need to enter the IP address of the server and select the update interval in the following two boxes.
- **Manual:** Select this option to set the date and time manually.

## Basic >> User

### ■ Administrator

You can use this option to change the password for your camera

### ■ General User

- **User Name:** Enter the user's name you want to add to use the camera.
- **Password:** Enter the password for the new user.

When you are finished, click **Add/Modify** to add the new user to the camera. To modify the user's information, select the one you want to modify from **UserList** and click **Add/Modify**.

- **UserList:** Display the existing users of the camera. To delete a user, select the one you want to delete and click **Delete**.

#### ■ **Guest**

- **User Name:** Enter the guest's name you want to add to use the camera.
- **Password:** Enter the password for the new guest.
- **UserList:** Display the existing guests of the camera. To delete a user, select the one you want to delete and click **Delete**.

**NOTE** A "General User" can access the camera and control the Function buttons of the camera's Web Configuration; a "Guest" can only view the live view image from the main page of the Web Configuration while accessing the camera. Only the "Administrator" is allowed to configure the camera through the Web Configuration.

## 4.2 Network Settings

The Network menu contains three sub-menus that provide the network settings for the camera, such as the IP Setting, DDNS Setting, and IP Filter.

The screenshot shows the 'Network >> Network' configuration page. On the left is a navigation menu with 'Live View', 'Setup', 'Smart Wizard', and categories like 'Basic', 'Network', 'IP Filter', 'Video/Audio', 'Event Server', 'Motion Detect', and 'Event Config'. The 'Network' section is expanded to show 'IP Setting'. Under 'IP Setting', there are three radio buttons: 'DHCP', 'Static IP' (which is selected), and 'PPPoE'. The 'Static IP' section contains several input fields: 'IP' (192.168.2.240), 'Subnet Mask' (255.255.255.0), 'Default Gateway' (192.168.2.1), 'Primary DNS', and 'Secondary DNS'. The 'PPPoE' section has 'User Name' and 'Password' input fields.

### Network >> Network

#### ■ IP Setting

This item allows you to select the IP address mode and set up the related configuration.

- **DHCP:** Select this option to allow your router dynamically assign an IP address to your camera. When the camera starts up, it will obtain an IP address from the DHCP server of your router automatically. It is recommended to use Static IP instead of DHCP and assign a fixed IP address for each of your camera, so that you can always locate the camera on your network.
- **Static IP:** Select this option to assign a fixed IP address for the camera. You can use SkyIPCam Utility to obtain the related setting values.

<b>IP</b>	Enter the IP address of the camera. The default IP setting is <b>192.168.2.240</b> .
<b>Subnet Mask</b>	Enter the Subnet Mask of the camera. The default setting is <b>255.255.255.0</b> .
<b>Default Gateway</b>	Enter the Default Gateway of the camera. The default setting is <b>192.168.2.1</b> .
<b>Primary/ Secondary DNS</b>	DNS (Domain Name System) translates domain names into IP addresses. Enter the Primary DNS and Secondary DNS that are provided by ISP. It is usually recommended that you input the Default Gateway of your network, which is the IP address of your router. Check with your router manufacturer for that information. <b>THIS IS MANDATORY IF YOU WANT TO USE FTP OR EMAIL FUNCTIONS</b>

- **PPPoE:** Select this option when you use a direct connection via DSL modem. You should have a PPPoE account from your Internet service provider. Enter your DSL account's **User Name** and **Password** given by your DSL service provider. The camera will get an IP address from the ISP as starting up. If you are using a router, do NOT select this option.

**NOTE** Once the camera gets an IP address from the ISP as starting up, it automatically sends a notification email to you. Therefore, when you select PPPoE as your connecting type, you have to set up the email or DDNS configuration in advance.

<b>Tools</b> <b>RS-485</b> <b>Information</b>	DDNS Setting	
	<input type="checkbox"/> Enable	
	Provider:	members.dyndns.org ▼
	Host Name:	<input type="text"/>
	User Name:	<input type="text"/>
	Password:	<input type="password"/>

### ■ DDNS Setting

With the Dynamic DNS feature, you can assign a fixed host and domain name to a dynamic Internet IP address. To set up the DDNS:

1. Check **Enable** checkbox to enable this feature.
2. Select a DDNS **Provider** from the pull-down list. Please go to the DDNS provider's website and register a DDNS account, then you will obtain the information required below.
3. Enter the required information in the **Host Name**, **User Name**, and **Password** boxes.

	UPnP	
	<input checked="" type="checkbox"/> Enable	

### ■ UPnP

The camera supports UPnP (Universal Plug and Play), which is a set of computer network protocols that enable the device-to-device interoperability. In addition, it supports port auto mapping function so that you can access the camera if it is behind a NAT router or firewall. Select the **Enable** option to enable this feature.

	Ports Number	
	HTTP Port:	<input type="text" value="80"/> (default: 80)
	RTSP Port:	<input type="text" value="554"/> (default: 554)

### ■ Ports Number

- **HTTP Port:** The default HTTP port is **80**. Some ISP's have port 80 blocked. If you are having problems, you can change it to some other port. The suggested port to be used is anything between 1024 to 65535
- **RTSP Port:** Configure the transmission of streaming data within the network. The default RTSP (Real Time Streaming Protocol) port is **554**. To view the real-time streaming image on your computer, open the RTSP supported player and enter the link:  
[rtsp://\(IP address of the camera\)/mpeg4](rtsp://(IP address of the camera)/mpeg4).



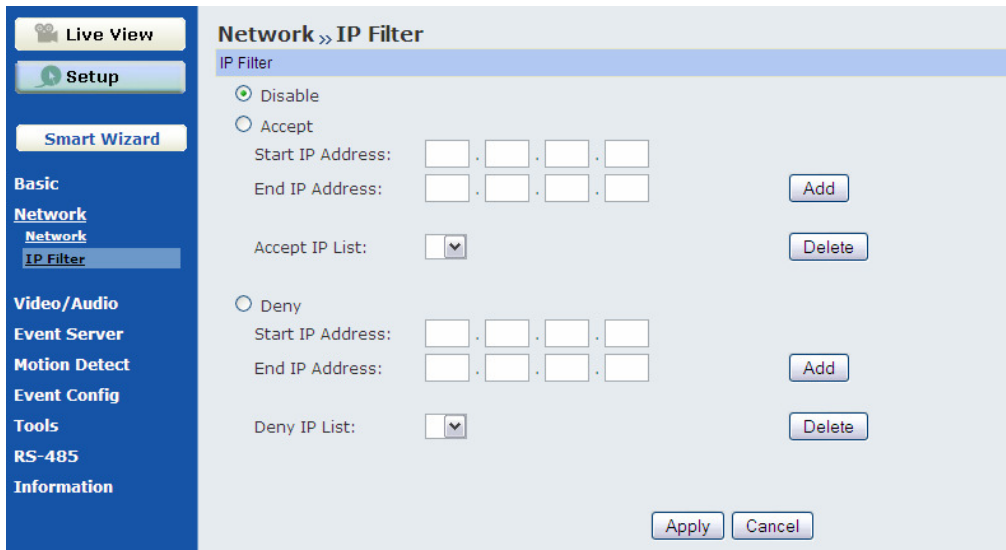

## Network >> IP Filter

The IP Filter setting allows the administrator of the camera to limit the users within a certain range of IP addresses to access the camera.

- **Disable:** Select this option to disable the IP Filter function of the camera.
- **Accept**
  - **Start/End IP Address:** Assign a range of IP addresses that are allowed to access the camera by entering the **Start IP address** and **End IP address** options. When you are finished, click **Add** to save the range setting. You can repeat the action to assign multiple ranges for the camera. For example, when you enter 192.168.0.50 in Start IP Address and 192.168.0.80 in End IP Address, the user whose IP address located within 192.168.0.50 ~ 192.168.0.80 will not be allowed to access the camera.
  - **Accept IP List:** The list displays the range setting(s) of IP addresses that are allowed to access the camera. To clear the setting, select a range of IP addresses from the list and click **Delete**.
- **Deny**
  - **Start/End IP Address:** Assign a range of IP addresses that are blocked to access the camera by entering the **Start IP address** and **End IP address** options. When you are finished, click **Add** to save the range setting. You can repeat the action to assign multiple ranges for the camera. For example, when you enter 192.168.0.50 in Start IP Address and 192.168.0.80 in End IP Address, the user whose IP address located within 192.168.0.50 ~ 192.168.0.80 will not be allowed to access the camera.
  - **Deny IP List:** The list displays the range setting(s) of IP addresses that are blocked to access the camera. To clear the setting, select a range of IP addresses from the list and click **Delete**.

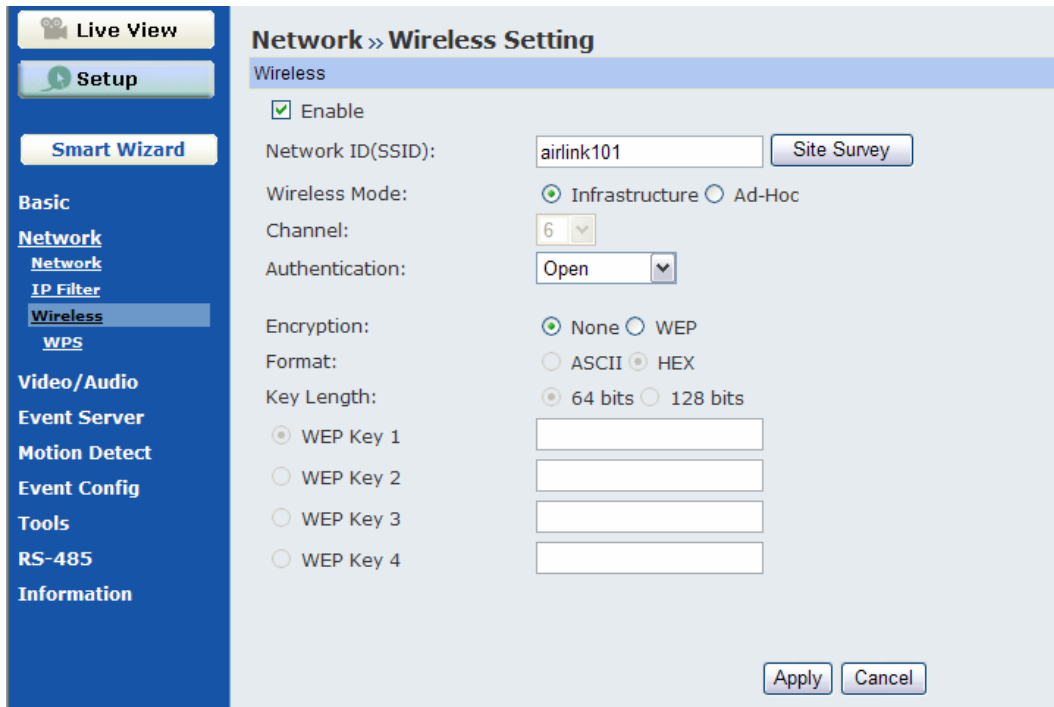

## Network >> Wireless Setting

The camera supports Wireless feature that can connect to your wireless network. Select the **Enable** option to enable this feature.

- Network ID (SSID):** Keep the default setting of this option to connect the camera to any access point under the infrastructure network mode. To connect the camera to a specified access point, set a SSID for the camera to correspond with the access point's ESSID. To connect the camera to an Ad-Hoc wireless workgroup, set the same wireless channel and SSID to match with the computer's configuration.

Click **Site Survey** to display the available wireless networks, so that you can easily connect to one of the listed wireless networks.

- Wireless Mode:** Select the type of wireless communication for the camera: **Infrastructure** or **Ad-Hoc**.
- Channel:** Select the appropriate channel from the list.
- Authentication:** Select the authentication method to secure the camera from being used by unauthorized user: **Open**, **Shared-key**, **WPA-PSK**, and **WPA2-PSK**. The following table explains the four options:

<b>Open</b>	The default setting of Authentication mode, which communicates the key across the network.
<b>Shared-key</b>	Allow communication only with other devices with identical WEP settings.
<b>WPA-PSK/WPA2-PSK</b>	WPA-PSK/WPA2-PSK is specially designed for the users who do not have access to network authentication servers. The user has to manually enter the starting password in their access point or gateway, as well as in each PC on the wireless network.

If you select **Open** or **Shared-key** as the Authentication mode, you need to complete the following settings:

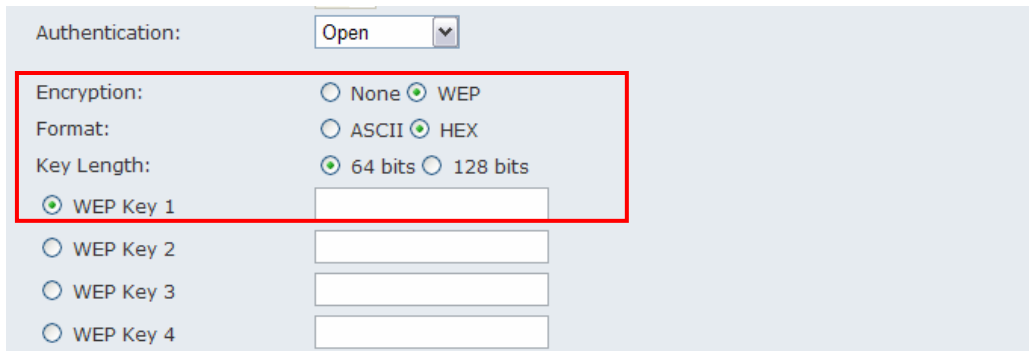

Authentication:

Encryption:  None  WEP

Format:  ASCII  HEX

Key Length:  64 bits  128 bits

WEP Key 1

WEP Key 2

WEP Key 3

WEP Key 4

- **Encryption:** Select the **WEP** option to enable the data encryption feature to secure the camera within the wireless network.
- **Format:** Once you enable the Encryption feature, you need to determine the encryption format by selecting **ASCII** or **HEX**. ASCII format causes each character you type to be interpreted as an eight-bit value. Hex format causes each pair of characters you type to be interpreted as an eight-bit value in hexadecimal (base 16) notation.
- **Key Length:** Select the WEP key length you use: **64 bits** or **128 bits**.
- **WEP Key 1/2/3/4:** Enter the WEP key(s) in the following boxes. This must match the WEP key value configured for your wireless router/AP.

If you select **WPA-PSK** or **WPA2-PSK** as the Authentication mode, you need to complete the following settings:

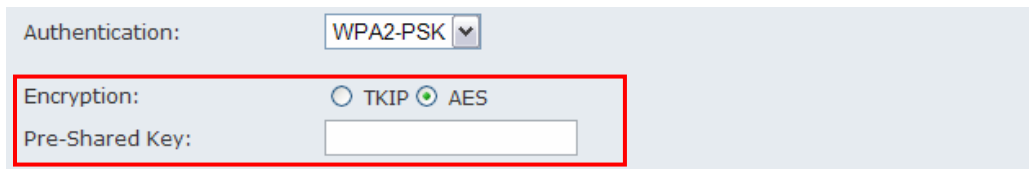

Authentication:

Encryption:  TKIP  AES

Pre-Shared Key:

- **Encryption:** Select **TKIP** or **AES**. TKIP (Temporal Key Integrity Protocol) changes the temporal key every 10,000 packets to insure much greater security than the standard WEP security. AES (Advanced Encryption Standard) is used to ensure the highest degree of security and authenticity for digital information. This must match the encryption type configured for your wireless router/AP.
- **Pre-Shared Key:** Enter your wireless network key into the box, and this must match the Pre-shared key value configured for your wireless router/AP.

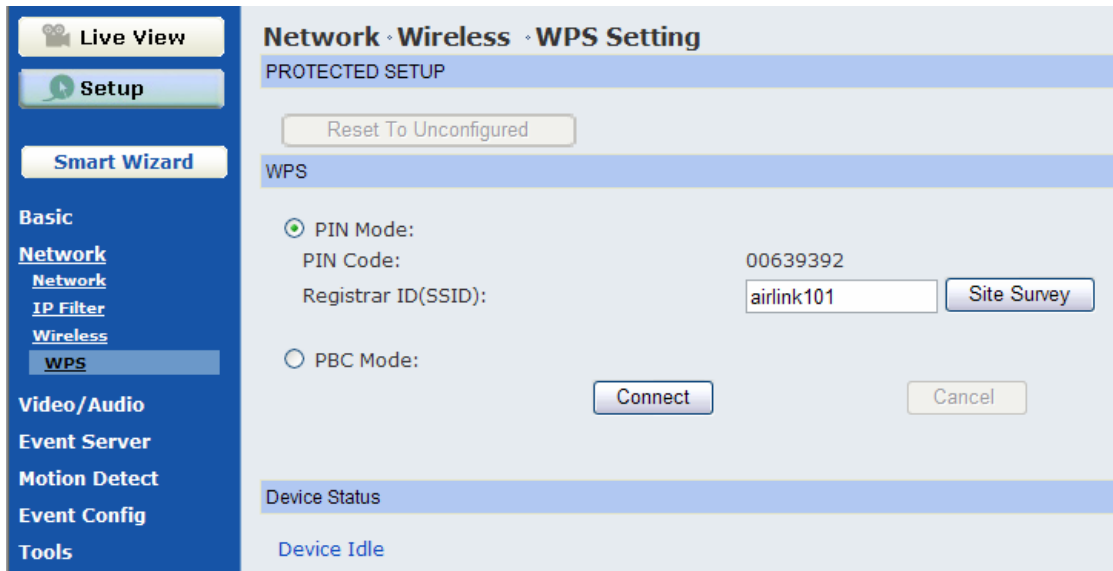

## Network >> Wireless >> WPS Setting

The camera supports WPS (WiFi Protected Setup™) feature that allows your camera to connect to the wireless network easily and safely without manually configuring the wireless security settings. **Please note that Your AP/Router must support WPS feature as well. If you are not sure, please refer to the manufacturer's manual of your AP/Router.**

Select either PIN or PBC mode to start the WPS session:

- **PIN Mode:**

- Step 1 Enter the SSID of the AP/Router you wish to connect to, or click **Site Survey** and select from the listed wireless networks.
- Step 2 Go to the WPS section of your AP/Router's web configuration page, then enter the PIN Code generated by the camera (in this case, "00639392") into the corresponding field. Please check your AP/Router's manufacturer's manual for more details.

- **PBC Mode (Recommended):**

- Step 1 Click on the Connect button.
- Step 2 Click on the WPS hardware or software button on your AP/Router.

Within 2 minutes, the camera will be wirelessly associated with your AP/Router.

## 4.3 Setting up Video & Audio

The Video & Audio menu contains three sub-menus that provide the video and audio settings for the camera.

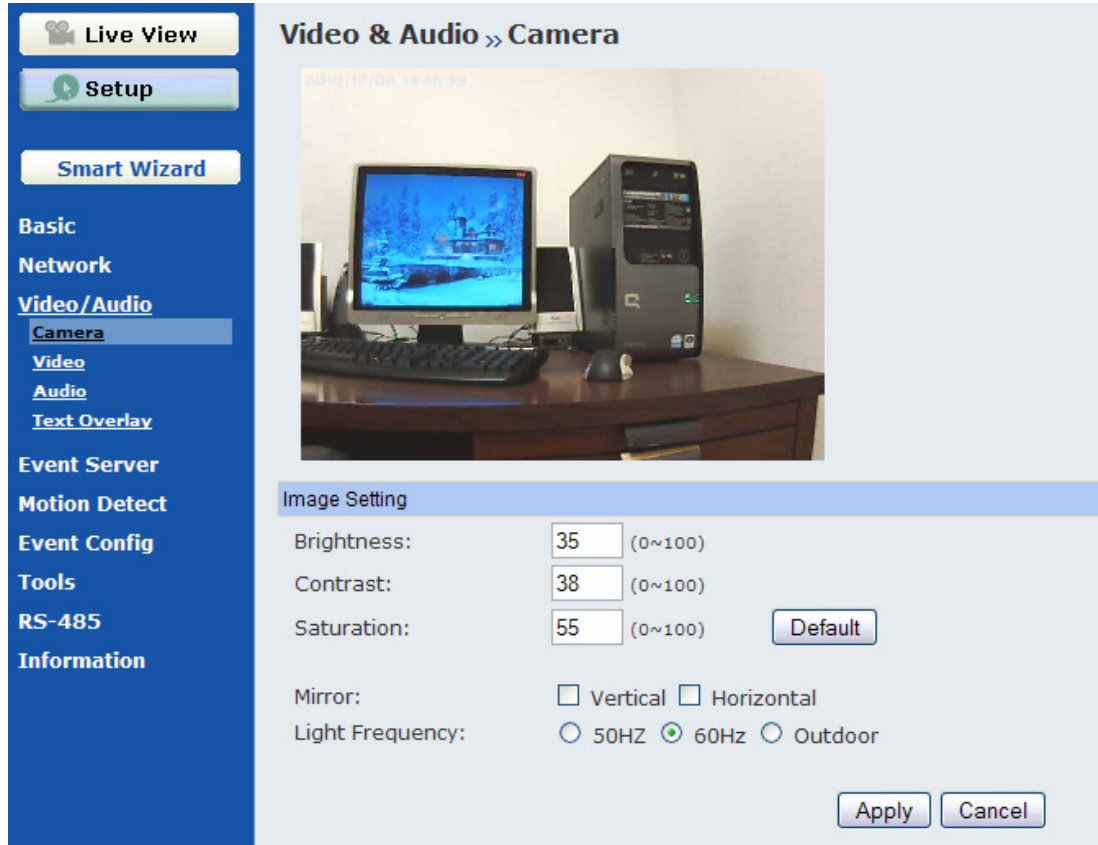

### Video & Audio >> Camera

#### ■ Image Setting

- **Brightness:** Adjust the brightness level from 0 ~ 100.
- **Contrast:** Adjust the contrast level from 0 ~ 100.
- **Saturation:** Adjust the colors level from 0 ~ 100.  
Click **Default** to restore the default settings of the three options above.
- **Mirror:** Depending on how you mount/view your camera, you may need to adjust the orientation of image. Check **Horizontal** to mirror the image horizontally. Check **Vertical** to mirror the image vertically.
- **Light Frequency:** Select the proper light frequency according to the camera's location: **50Hz**, **60Hz**, or **Outdoor**.

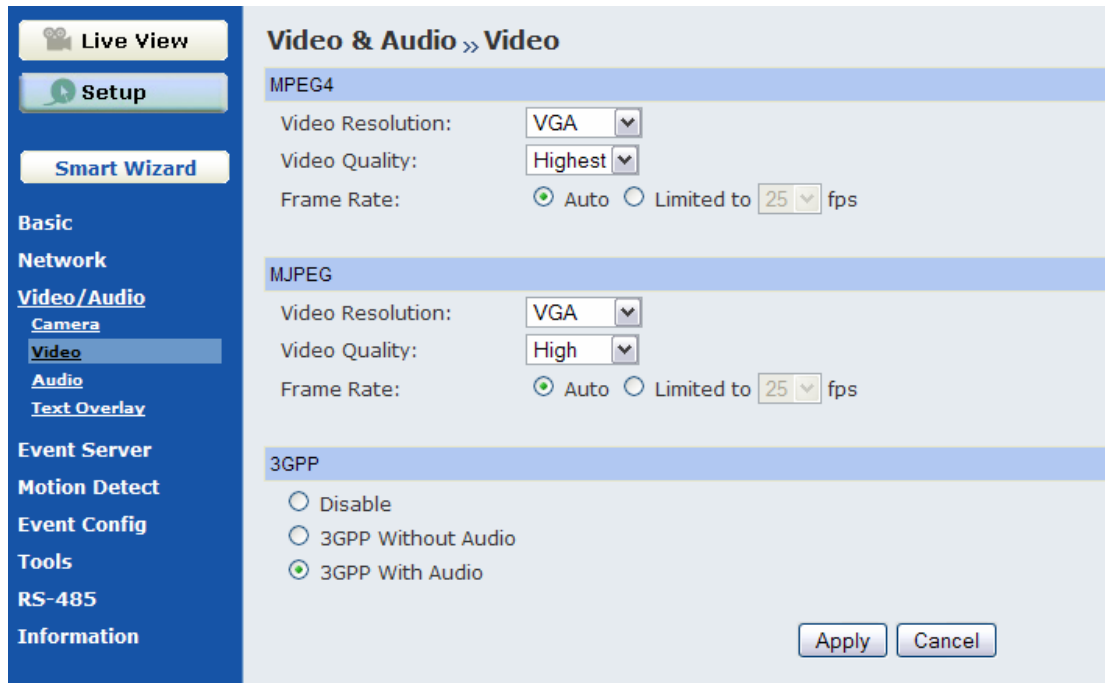

## Video & Audio >> Video

### ■ MJPEG

- **Video Resolution:** Select the desired video resolution from the three formats: **VGA**, **QVGA** and **QQVGA**. The higher setting (VGA) obtains better video quality while it uses more resource within your network.
- **Video Quality:** Select the desired image quality from five levels: **Lowest**, **Low**, **Medium**, **High**, and **Highest**.
- **Frame Rate:** Select **Auto** or a proper setting depending on your network status.

### ■ MJPEG

- **Video Resolution:** Select the desired video resolution from the three formats: **VGA**, **QVGA** and **QQVGA**. The higher setting (VGA) obtains better video quality while it uses more resource within your network.
- **Video Quality:** Select the desired image quality from five levels: **Lowest**, **Low**, **Medium**, **High**, and **Highest**.
- **Frame Rate:** Select **Auto** or a proper setting depending on your network status.

**NOTE** The camera supports both MPEG4 and MJPEG compression. MJPEG capture the images in JPEG format, which require higher bandwidth to view smooth video. The administrator can control the bandwidth of each connection well through the setting options above. For the bandwidth information, refer to the Appendix, Bandwidth Reference Guide.

### ■ 3GPP

- **Disable:** Disable access from 3G mobile device.
- **3GPP Without Audio:** Select this option to view the camera from your mobile device without audio.
- **3GPP With Audio:** Select this option to view the camera from your mobile device with audio.

If you use a mobile device, you can also view the real-time streaming image captured by the camera on your phone with the default (built-in) player by entering the RTSP link: [rtsp://\(IP address of the camera\)/3gp](rtsp://(IP address of the camera)/3gp).

**NOTE** Your mobile phone and the service provider must have data service. Please contact your service provider when you are failed to use this service.



## Video & Audio >> Audio

### ■ Camera Microphone In

Select the **Enable** option to enable the camera's audio function, so that you can receive the on-site sound and voice from the camera.

### ■ Camera Speaker Out

Select the **Enable** option to enable the camera's external speaker function, so that the connected speaker can play the sound and voice through the camera.

You can set the speaker's volume by entering the proper value in the **Volume** option. The default setting is **90**.

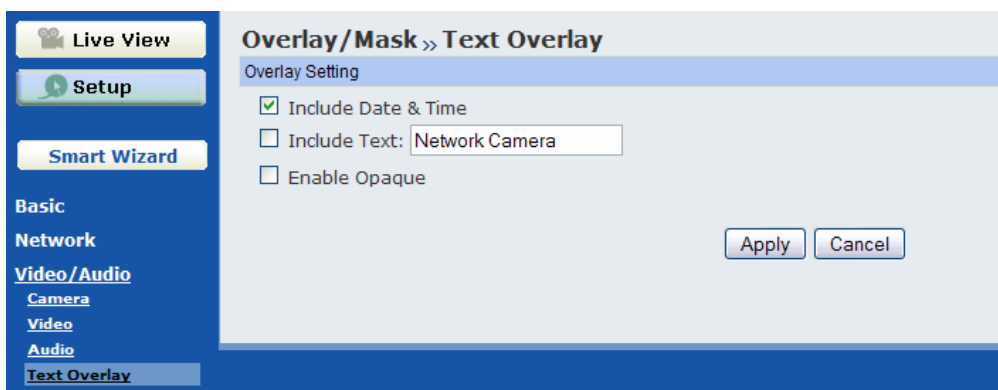

## Video & Audio >> Text Overlay

### ■ Overlay Setting

This option allows you to set the text overlay function of the camera, so that you can see the related information on the live view image.

- **Includes Date & Time:** Check this option to display the date & time stamp on the live view image.
- **Include Text:** Check this option and enter the text (i.e. Camera Room A01) you wish to display on the live view image.
- **Enable Opaque:** Check this option to set a black background to the displayed date & time stamp.



## 4.4 Event Server

The Event Server menu contains three sub-menus that allow you to upload images to FTP, send emails that include still images, and store video clips, still images to a network attached storage (NAS).

**Event Server Setting >> FTP**

FTP

Host Address:

Port Number:

User Name:

Password:

Directory Path:

Passive mode:  Enable

FTP Upload With:  One Snapshot  Pre-event  sec(s)  Post-event  sec(s)

### Event Server Setting>> FTP

#### ■ FTP

- **Host Address:** Enter the IP address of the target FTP server.
- **Port Number:** Enter the port number used for the FTP server.
- **User Name:** Enter the user name to login into the FTP server.
- **Password:** Enter the password to login into the FTP server.
- **Directory Path:** Enter the destination folder for uploading the images. For example, */Test/*.
- **Passive Mode:** Check the **Enable** box to enable passive mode. If you are having trouble, you can enable/disable this mode.
- **FTP Upload with:** Select upload to FTP with **One Snapshot** image or a series image in **Pre-event/Post-event** time when event triggered.

**NOTE** Due to the network environment, the camera may not upload number of images that you set.

When you complete the required settings for FTP, click **Test** to find out if the related configuration is correct or not. Once the camera connects to the server successfully, click **Apply**.

## Event Server Setting >> Email

### ■ Email

- **SMTP Server Address:** Enter the mail server address. For example, [mymail.com](mailto:mymail.com).
- **Sender Email Address:** Enter the email address of the user who will send the email. For example, [John@mymail.com](mailto:John@mymail.com).
- **Sender User Name:** Enter the user name to login the mail server.
- **Sender Password:** Enter the password to login the mail server.
- **Receiver #1 Email Address:** Enter the first email address of the user who will receive the email.
- **Receiver #2 Email Address:** Enter the second email address of the user who will receive the email.

**NOTE** If you configure a static IP for your camera, you must configure the Primary/Secondary DNS addresses under "Network" to let the Email function work properly.

When you complete the required settings for Email, click **Test** to find out if the related configuration is correct or not. Once the camera connects to the server successfully, click **Apply**.

## Event Server Setting >> NAS

### ■ Network Storage

- **Samba Server Address:** Enter the IP address of the Network Storage server.
- **Share:** Assign the folder on the Network Storage server to share the files to users.
- **Path:** Assign the path for uploading the files on the Network Storage server. For example, [/Test/](#).
- **User Name:** Enter the user name to login into the Network Storage server.
- **Password:** Enter the password to log in to the Network Storage server.
- **Split By:** When the file is too large to upload smoothly, use this option to split it by selecting **File Size** or **Recording Time**.
- **When Disk Full:** Select **Stop Recording** or **Recycle – Delete Oldest Folder of File** when the storage space on the Network Storage server is full.

**NOTE** The video recorded files in Network Storage are enclosed by AVI format without Audio.

When you complete the required settings for NAS, click **Test** to find out if the related configuration is correct or not. Once the camera connects to the server successfully, click **Apply**.

## 4.5 Motion Detect

*\*This function can only be configured in Windows Internet Explorer.*

The Motion Detect menu contains the command and option that allow you to enable and set up the motion detection feature of the camera. The camera provides two detecting areas.

To enable the detecting area, select **Window 1** or **2** from the pull-down list, and then check **Enable**. When the detecting area is enabled, you can use the mouse to move the detecting area and change the area coverage.

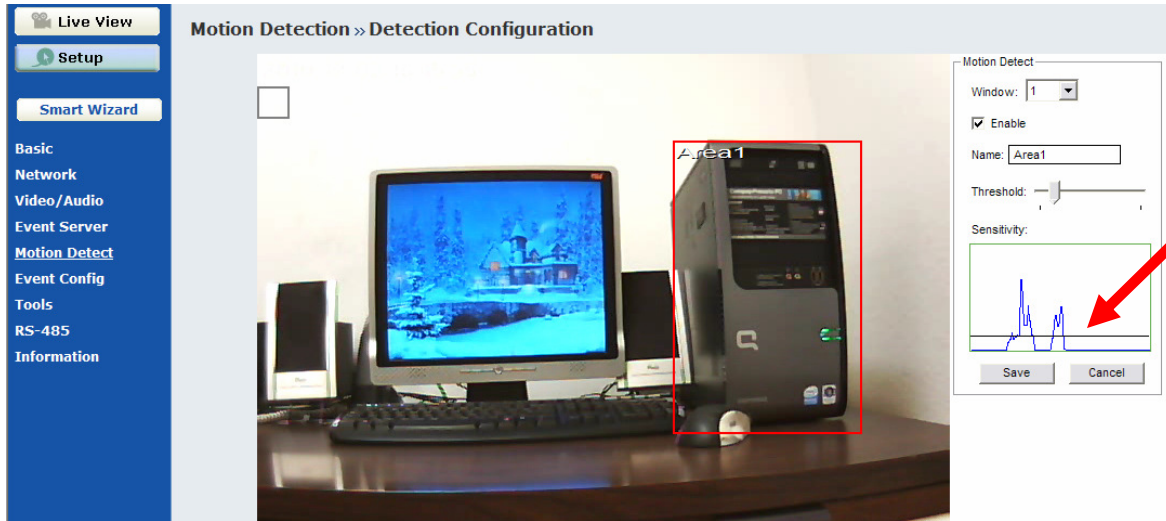

- **Name:** Assign a name to the detecting area.
- **Threshold:** Move the slide bar to adjust the level for detecting motion. Make sure the threshold (the horizontal line) is low (sensitive) enough to come across the waves (appear when motion detected), so that the events (i.e, emailing snapshot, FTP uploading) you set up in **Event Config** will be triggered.

## 4.6 Event Config

The Event Configuration menu contains five sub-menus that provide the commands to configure event profiles.

The screenshot shows the 'Event Configuration >> General Setting' window. On the left is a navigation menu with buttons for 'Live View', 'Setup', and 'Smart Wizard', and a list of menu items: 'Basic', 'Network', 'Video/Audio', 'Event Server', 'Motion Detect', 'Event Config', 'General' (highlighted), 'Schedule Profile', 'Motion Trigger', 'Schedule Trigger', and 'GPIO Trigger'. The main area is titled 'Event Configuration >> General Setting' and contains a 'General' section with three input fields: 'Snapshot/Recording Subfolder:' (empty), 'NAS Recording Time Per Event:' (20 sec(s)), and 'GPIO Trigger Out Retention Time Per Event:' (20 sec(s)). At the bottom right are 'Apply' and 'Cancel' buttons.

### Event Configuration >> General Setting

- **Snapshot/Recording Subfolder:** You can assign a given sub-folder for captured file. Otherwise, leave this option blank to use the default setting.
- **Network Storage Recording Time Per Event:** Limit the recording time while you are using the Network Storage solution.
- **GPIO Trigger Out Retention Time Per Event:** Limit the retention time of the GPIO Trigger Out function.

The screenshot shows the 'Event Configuration >> Arrange Schedule Profile' window. The left navigation menu is the same as in the previous screenshot, with 'Schedule Profile' highlighted. The main area is titled 'Event Configuration >> Arrange Schedule Profile' and contains a 'Schedule Profile' section. It features a list box with 'MorningShift' and 'Add'/'Delete' buttons. Below is a form for editing the profile: 'Profile Name:' (MorningShift), 'Days:' (radio buttons for Sun, Mon, Tue, Wed, Thu, Fri, Sat, with Mon selected), 'Time List:' (a list box containing '09:00 - 12:00' and 'Add', 'Delete', 'Copy this to all week days', 'Delete this from all week days' buttons), 'Start Time:' (09 : 00), and 'End Time:' (12 : 00). 'Save' and 'Cancel' buttons are at the bottom.

## Event Configuration >> Schedule Profile

This sub-menu displays the scheduled profile(s). To configure a new profile, click **Add** and then enter a descriptive name for the profile in the prompt dialog window. After entering the profile name, click **OK** and the profile is added to the Schedule Profiles list. To delete the profile, select the profile in the list and click **Delete**.

- **Profile Name:** Display the profile name that you select in the Schedule Profiles list.
- **Weekdays:** Select the weekday(s) that you want to separately assign in the schedule profile. The weekday that has been assigned will be displayed with green color.
- **Time List:** Display the time period that you have assigned within the selected weekday. To assign the same time period to every weekday, click **Copy this to all weekdays**; click **Delete this from all weekdays** to remove the selected time period from every weekday. Click **Delete** to remove the selected time period.
- **Start/End Time:** Enter the start and end time and then click **Add** to assign a time period within in the selected weekday.

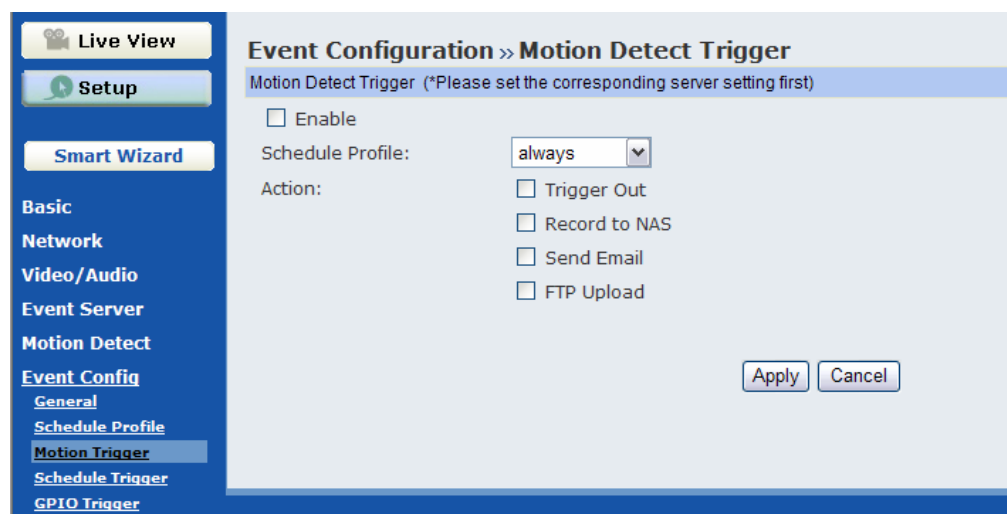

## Event Configuration >> Motion Detect Trigger

- **Motion Detect Trigger:** Check the **Enable** option to enable the trigger function of the camera, so that you can send captured images within the detecting area to the FTP server, email receiver, or the Network Storage server. You have to configure the corresponding settings, such as FTP or Email server under **Event Server** to allow these events working properly. Please note that you have to configure the related settings before enabling these features.
  - **Schedule Profile:** Select a schedule profile from the pull-down list.
  - **Action:** Set the **Trigger Out** function or the following options: **Record to Network Storage** (video clips without audio), **Send Email** (captured images), or **FTP Upload** (captured images).

## Event Configuration >> Schedule Trigger

You can configure the schedule for trigger function of the camera individually by **Email**, **FTP**, and **NAS**. Select the **Enable** option on each item, and then select a **Schedule Profile** from the pull-down list and set the **Interval** time.

## Event Configuration >> GPIO Trigger

This feature needs to be configured if you attach a device with GPIO interface to the camera (i.e. alarm system)

- GPIO Trigger:** Check the **Enable** option to enable the GPIO trigger function of the camera, so that you can set Trigger Out function or send captured images within the detecting area to the FTP server, email receiver, Network Storage server, or send an instant message. You have to configure corresponding settings, such as FTP server and email server, to enable this feature.

- **Schedule Profile:** Select a schedule profile from the pull-down list.
- **Action:** Set the **Trigger Out** function or select the destination that the captured images will be sent to: **Record to Network Storage**, **Send Email**, or **FTP Upload**.



## 4.7 Tools

The Tools menu provides the commands that allow you to restart or reset the camera. You can also backup and restore your configuration, and upgrade the firmware for the camera.

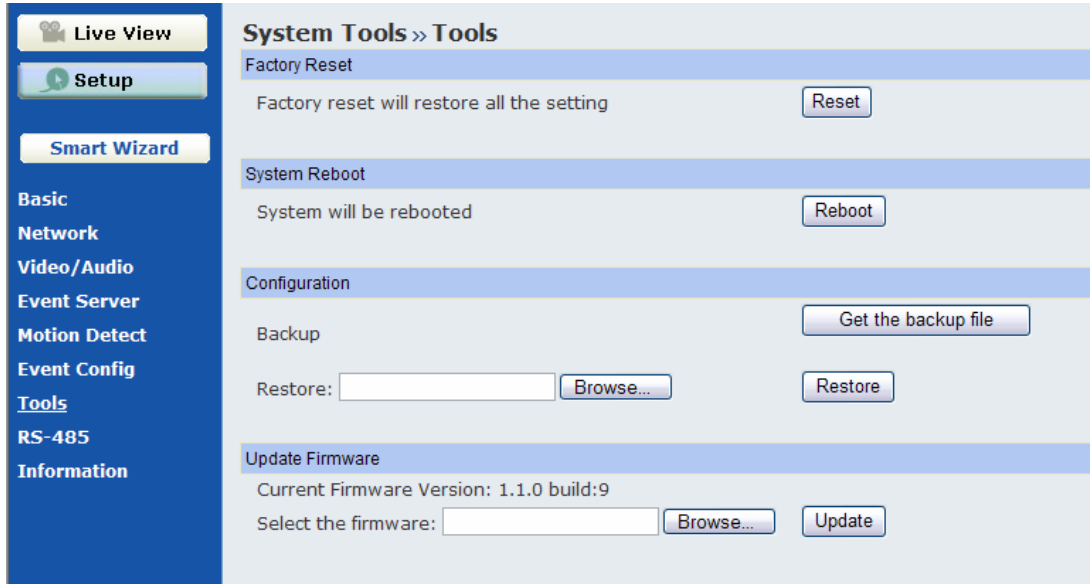

### ■ Factory Reset

Click **Reset** to restore all factory default settings for the camera.

### ■ System Reboot

Click **Reboot** to restart the camera just like turning the device off and on. The camera configuration will be retained after rebooting.

### ■ Configuration

You can save your camera configuration as a backup file on your computer. Whenever you want to resume the original settings, you can restore them by retrieving the backup file.

- **Backup:** Click **Get the backup file** to save the current configuration of the camera.
- **Restore:** Click **Browse** to locate the backup file and then click **Restore**.

### ■ Update Firmware

This item displays the current firmware version. You can upgrade the firmware for your camera once you obtained a latest version of firmware.

- **Select the firmware:** Click **Browse** to locate the backup file and then click **Update**.

**NOTE** Make sure to keep the camera connected to the power source during the process of upgrading firmware. Otherwise, the camera might be damaged because of failure of upgrading firmware.

## 4.8 RS-485

The RS-485 menu provides the control settings for external device through the I/O port. Check the **Enable** option and complete the required configuration to use the RS-485 function of the camera.

**RS-485 >> RS-485 Setting**

RS-485

Enable

Popular Protocol Setting

Protocol: Pelco-D

Custom Protocol Setting

Baud Rate: 2400

Home:  Test

Up:  Test

Down:  Test

Left:  Test

Right:  Test

Name	Command	
External Command 1:	<input type="text"/>	<input type="text"/> Test
External Command 2:	<input type="text"/>	<input type="text"/> Test
External Command 3:	<input type="text"/>	<input type="text"/> Test
External Command 4:	<input type="text"/>	<input type="text"/> Test
External Command 5:	<input type="text"/>	<input type="text"/> Test

Apply Cancel

- **Popular Protocol Setting:** Select this option and then select a protocol. When you enable the RS-485 function of the camera, it will display the additional control buttons on the live view screen (as shown on the next page).
- **Custom Protocol Setting:** Select this option to configure the commands protocol manually. You can click **Test** to test each command that you have assigned. In the **Name** and **Command** string boxes, you can customize more buttons for your needs. Please note that the setting values in the **Command** string boxes should be from the connected external device (please refer to the manual of the connected device).

## About the Control Buttons

After enabling RS-485 function, the control panel will appear on the Live View window.



### Control Buttons of RS-485

- **Left/Right/Up/Down/Home** buttons allow you to move the camera lens position. Clicking the **Home** (center) button will move the camera lens to the assigned home position.

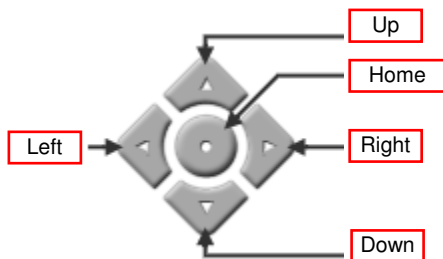

- Click the **Number button** (1~8) to move the camera lens to the preset position immediately. To set up the preset positions, move the camera lens by clicking the Left/Right/Up/Down buttons to the desired position first, and then select the number (1~8) from the pull-down list and click the **Apply** button. You can enter a descriptive name for the assigned position in the text box to identify it easily.
- **Pan Speed**: Adjust the moving speed (1 ~ 10) while panning the lens.
- **Tilt Speed**: Adjust the moving speed (1 ~ 10) while tilting the lens.

## 4.9 Information

The Information menu displays the current configuration and events log of the camera.

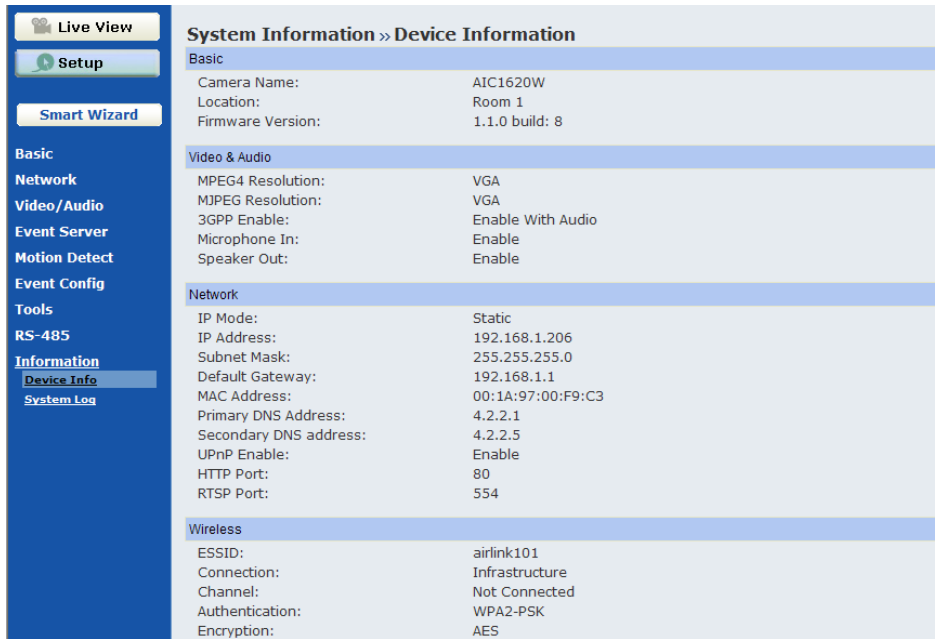

**System Information >> Device Information**

**Basic**

Camera Name: AIC1620W  
Location: Room 1  
Firmware Version: 1.1.0 build: 8

**Video & Audio**

MPEG4 Resolution: VGA  
MJPEG Resolution: VGA  
3GPP Enable: Enable With Audio  
Microphone In: Enable  
Speaker Out: Enable

**Network**

IP Mode: Static  
IP Address: 192.168.1.206  
Subnet Mask: 255.255.255.0  
Default Gateway: 192.168.1.1  
MAC Address: 00:1A:97:00:F9:C3  
Primary DNS Address: 4.2.2.1  
Secondary DNS address: 4.2.2.5  
UPnP Enable: Enable  
HTTP Port: 80  
RTSP Port: 554

**Wireless**

ESSID: airlink101  
Connection: Infrastructure  
Channel: Not Connected  
Authentication: WPA2-PSK  
Encryption: AES

### Information >> Device Info

Display the Basic, Video & Audio, and Network settings of the camera.

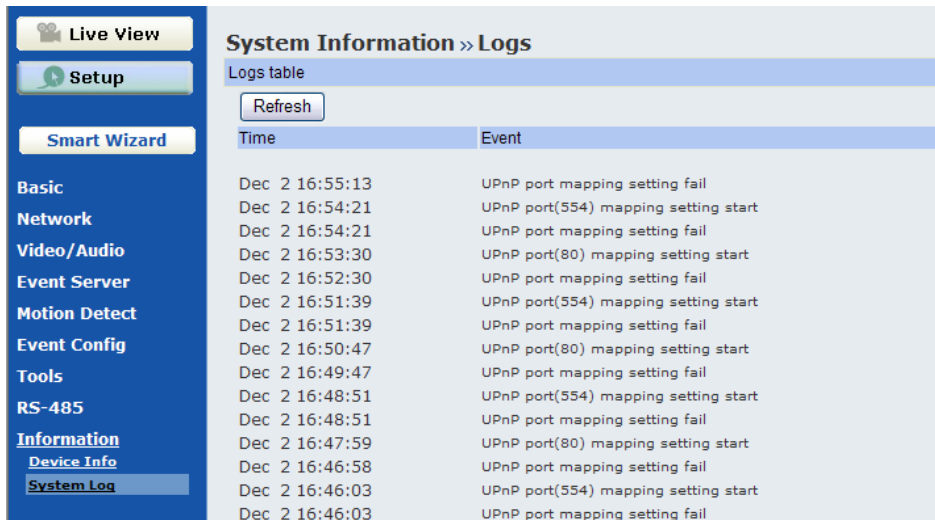

**System Information >> Logs**

Logs table

Time	Event
Dec 2 16:55:13	UPnP port mapping setting fail
Dec 2 16:54:21	UPnP port(554) mapping setting start
Dec 2 16:54:21	UPnP port mapping setting fail
Dec 2 16:53:30	UPnP port(80) mapping setting start
Dec 2 16:52:30	UPnP port mapping setting fail
Dec 2 16:51:39	UPnP port(554) mapping setting start
Dec 2 16:51:39	UPnP port mapping setting fail
Dec 2 16:50:47	UPnP port(80) mapping setting start
Dec 2 16:49:47	UPnP port mapping setting fail
Dec 2 16:48:51	UPnP port(554) mapping setting start
Dec 2 16:48:51	UPnP port mapping setting fail
Dec 2 16:47:59	UPnP port(80) mapping setting start
Dec 2 16:46:58	UPnP port mapping setting fail
Dec 2 16:46:03	UPnP port(554) mapping setting start
Dec 2 16:46:03	UPnP port mapping setting fail

### Information >> System Log

The Logs table displays the events log recorded by the system.

# CHAPTER 5

---

## USING SKYIPCAM ULTRAVIEW

### 5.1 Starting the Program

To start UltraView Pro, click **Start → (All) Programs → Airlink101 SkyIPCam UltraView → SkyIPCam UltraView**. Alternately, you can start the program by simply double-clicking the program icon on the desktop of your computer.

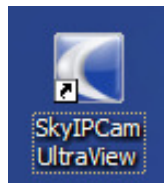

On the login window, enter the **User name/Password** and click **OK** to login. If this is the first time you start the program and login, use the default user name / password: *admin / admin*.

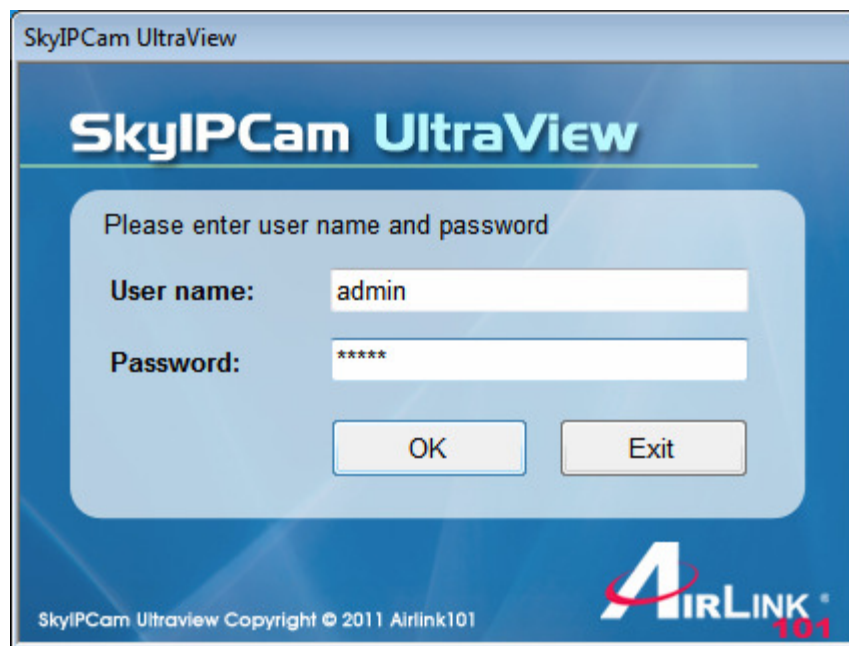

**NOTE** For security purpose, you are highly recommended to change the default user name and password after login. For more information, see the *Configuring the System > User Management* section.

## 5.2 Main Window and Item Feature









When you start and login to UltraView, the Main window will display as below:











The Main window provides you with the information on operating the system, as well as the control panel such as the Quick Launch buttons, and so on.

**NOTE** UltraView Pro requires the resolution setting up to 1024 x 768. For best view of the application, you are recommended to configure the resolution setting to 1024 x 768 or higher; otherwise, it cannot be displayed on the screen when launching the program.

- 1 **Live View Window** displays the live video of the connected camera(s).
- 2 **Quick Launch Buttons** are located below the Live View Window, providing you with the following quick-launch functions:

Button	Function
	Click to select <b>Logout</b> or <b>Close</b> UltraView Pro.
	Click to select <b>Restore Recording Type</b> , <b>All Continuous Recording</b> , or <b>Stop All Recording</b> .
	Click and then select to display the <b>View Setting</b> window, switch to the <b>eMap View</b> window, or check the <b>Camera Status</b> .
	Click to display the Playback window.
	Click to display the Schedule Configuration window.
	Click to configure the event settings: <b>Event Server</b> , <b>Address Book</b> , and <b>Event Trigger</b> .
	Click to configure <b>Device Setting</b> and <b>Recording Setting</b> .
	Click to set the <b>Account</b> , <b>Language</b> , and <b>System Setting</b> ; or view the <b>Version</b> or the program.

**3 Camera View Mode** buttons in this area allow you to switch the camera view mode.



Button	Function
	Display the connected camera(s) in single camera view mode.
	Display the connected camera(s) in quad view mode.
	Display the connected camera(s) in 3 x 3 grid view mode.
	Display the connected camera(s) in 13-camera view mode using a split window. The first camera is displayed as the major view.
	Display the connected camera(s) in 17-camera view mode using a split window. The first camera is displayed as the major view.
	Display the connected camera(s) in N x N grid view mode, supporting up to 36 views (up to 32 cameras).
	Display the live view of the selected camera in full screen mode.
	Automatically switch the live view of each connected cameras in single camera view mode by 30 seconds*. Click once to start and click again to stop. * The auto-switch time is set as 30 seconds by default, which can be changed by clicking the  → <b>System Setting</b> and then change the value from the pull-down list of the <b>Auto Switch time interval</b> option.



**4 System Information** displays the system information, including the date and time, and the available storage space of the system.

**5 Live View Status** provides the status of live view mode, including **Camera List** and **eMap**.

- **Camera List** displays the status of the connected cameras. If multiple cameras are connected, you can switch to the live view of each camera by simply selecting the camera from the list.
- **eMap** allows you to select the desired camera to the view from the map easily. Please note that you have to set up the eMap for monitoring in advance.

**6 Camera Control Buttons** provides the control buttons that allow you to control the selected camera.

Button	Function
	<b>Talk On/Off.</b> Click to enable/disable the speaker function of the connected camera. This option is available only in single camera view mode.
	<b>Listen On/Off.</b> Click to enable/disable the microphone function of the connected camera. This option is available only in single camera view mode.
	If the connected camera features pan/tilt functions, you can use this control panel to set the preset positions (up to 8 positions). Once configured, you can move the camera lens to the desired position quickly. To set the preset positions, adjust the camera lens to the desired position using the Navigation buttons, and then select the position number (1~8) from the Set button. To move to the preset position, simply select the position

	number (1~8) from the Go button.
	<p>Navigation Buttons (Left/Right/Up/Down/Home). If the connected camera features pan/tilt functions, the Navigation buttons allow you to move the camera lens position. Clicking the Home (center) button will move the camera lens to the assigned home position.</p> <p>**AIC1620W does not support Pan/Tilt function.</p>
	<p>The <b>Patrol/Stop</b> buttons are used to enable/disable the swinging function of the camera. Click <b>Patrol</b> to start patrolling through the preset positions once. Click <b>Stop</b> to stop patrolling.</p> <p>**AIC1620W does not support Pan/Tilt function.</p>



## 5.3 Accessing the Camera

Before you can access the camera, you have to add the camera to the system.

### ■ Adding a Camera

1. Click the  button and select **Device Setting** to display the Device Setting window.

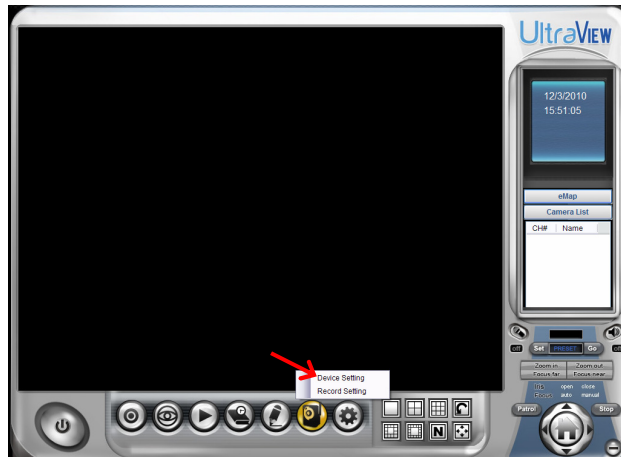

2. Click **New**.

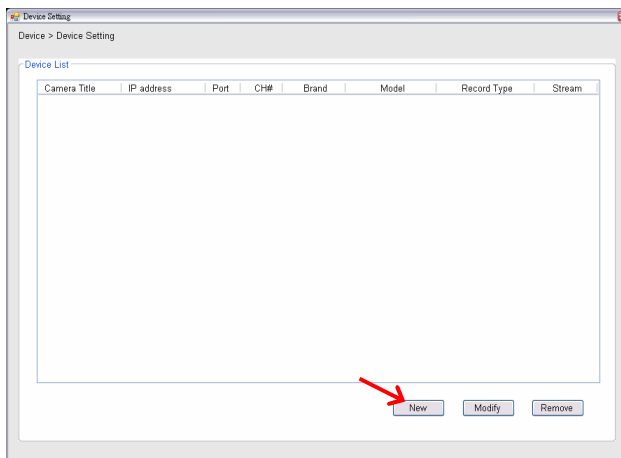

3. Click **Device Search** to search the camera(s) within your network.

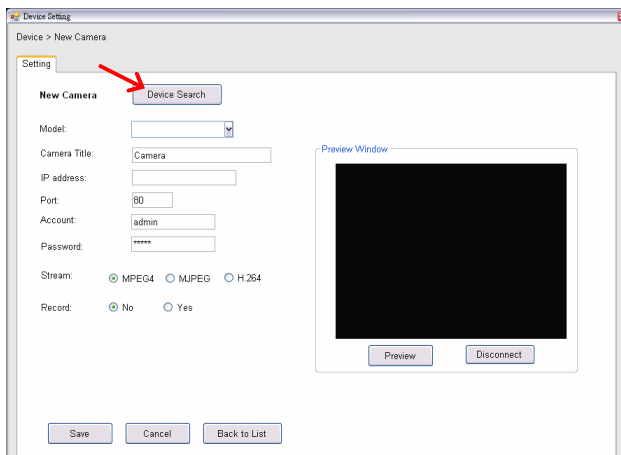

4. When search is finished, select the camera and click **Add**.

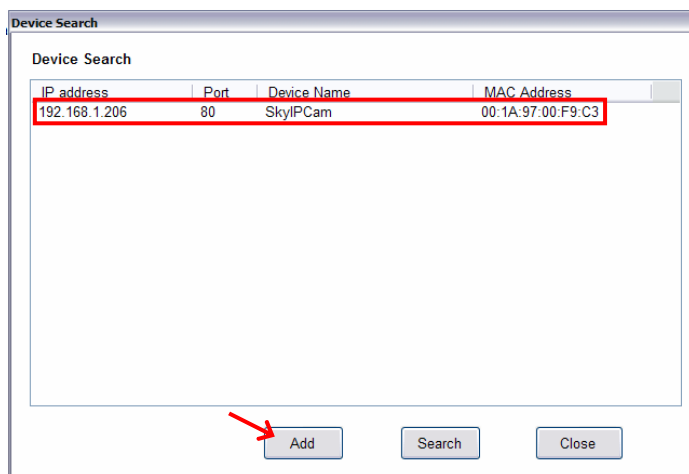

5. The information of the camera will be displayed on the window. When completed, click **Preview** and then click **Save** to return to the Device Setting window. The added camera will be displayed in the Device List.

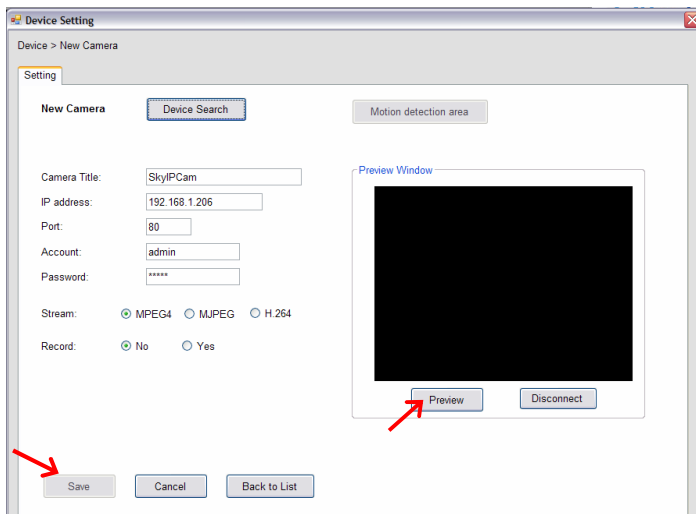

Option	Description
<b>Model</b>	Display the model name of the camera.
<b>Camera Title</b>	You have to assign a descriptive name for the camera.
<b>IP Address</b>	Display the IP address of the camera.
<b>Port</b>	Display the port path of the camera.
<b>Account</b>	Display the user name for accessing the camera.
<b>Password</b>	The password for accessing the camera will not be displayed.
<b>Stream</b>	Select the stream type as <b>MPEG4</b> , <b>MJPEG</b> , or <b>H.264</b> . (H.264 is not supported by AIC1620W)
<b>Record</b>	Select <b>Yes</b> or <b>No</b> to set up recording function of the camera.
<b>Preview</b>	This window allows you to preview the image of the

<b>Window</b>	camera. Click <b>Preview</b> to view the image; click <b>Disconnect</b> to stop previewing.
---------------	---

**TIP** You cannot set the motion detection area while adding the new camera. To set the motion detection area of the camera, select the desired camera and click the **Modify** button on the **Device Setting** window. See the following section for more information.

6. Close the Device Setting window and return to the Main window. The image of the camera will be displayed.

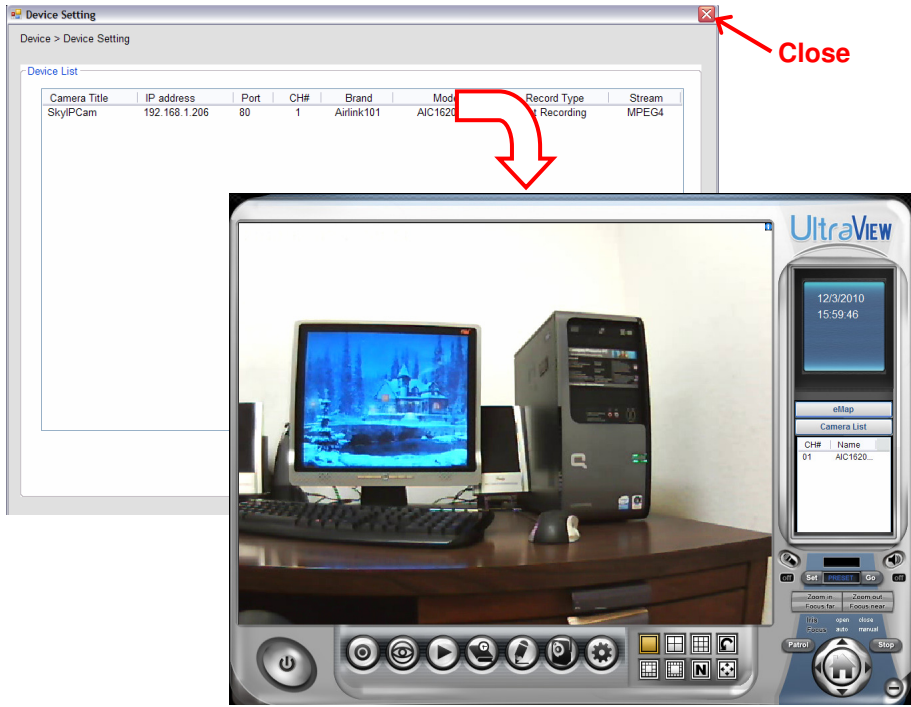

**TIP** When you add the camera and return to the Main window, the camera image will be displayed in full-screen mode by default. Press the ESC key on the PC keyboard to resume the Main window.

**NOTE** Divx/Xvid codec is required for viewing the image of camera. If the image cannot be displayed in the Live View/Preview window normally, click the following path to download and install the required component: <http://download.divx.com/divx/DivXInstaller.exe>

## ■ Editing / Deleting a Camera

Since you have added camera(s) to the system, you can select one to edit or remove.

1. On the Device Setting window, the connected camera(s) will be displayed in the Device List.

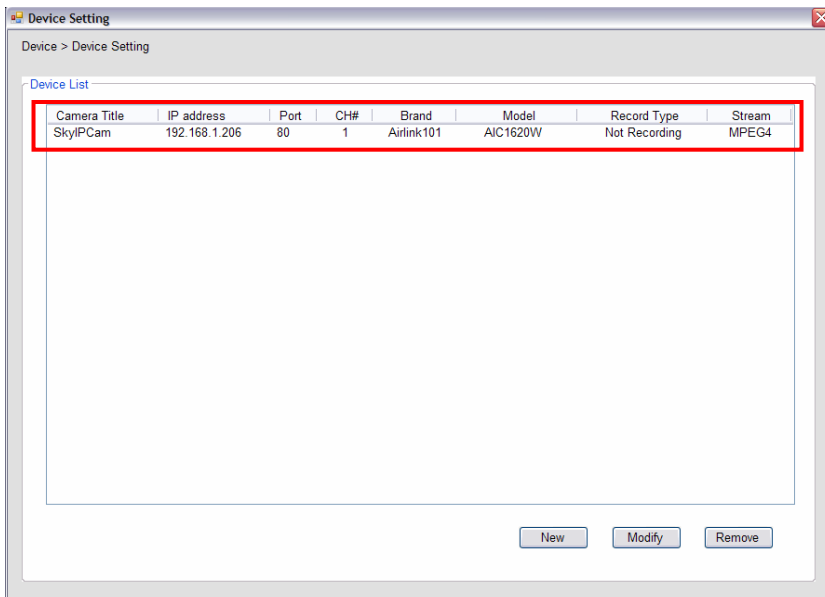

2. **To delete the camera:** select the desired one and then click **Remove**. When prompted, click **Yes** and then select **OK** to confirm deletion.

**To change the configuration of the camera:** select the desired one and then click **Modify**. The Modify Camera window will appear that allows you to change the configuration of the camera. When completed, click **Save** and then select **OK** to return to the Device Setting window.

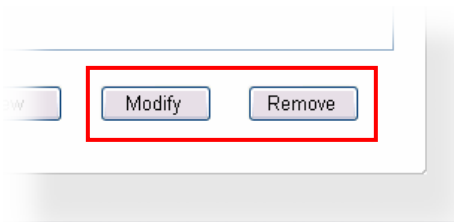

## ■ Viewing Image of the Camera

Since you have added camera(s) to the system, the image of the selected camera(s) will be displayed on the Live View Window automatically. You can view a maximum of 32 cameras simultaneously. Additionally, you can select one-camera or other view mode to display the video from the Camera View Mode buttons.

For example, if you use only one camera, select single camera view mode (  ), and the Live View Window will display the view as below. You can select the other modes according to your need.

The **Information icon** (  ) on the top-right corner of the window provides you with the options to connect/disconnect the camera, select a camera to be displayed in the window, capture a still image of the camera live video, or switch to eMap mode. Click the Information icon to pop up the shortcut menu and select the desired option.

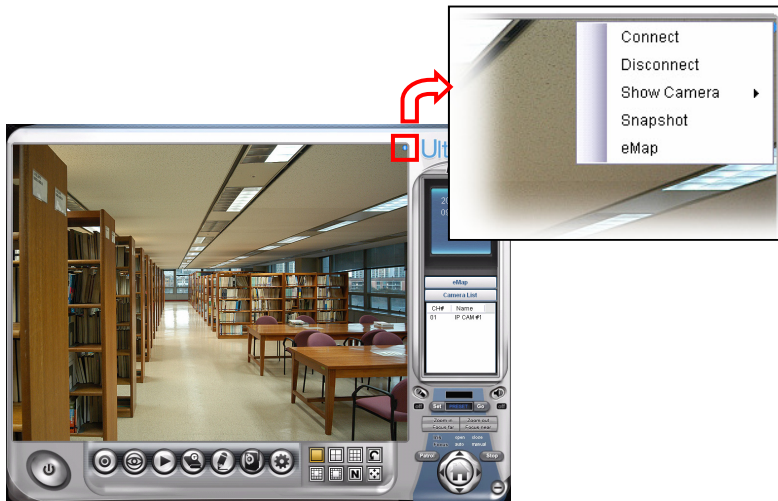

## 5.4 Recording / Playing Video

### ■ Enabling / Disabling Recording

Press **Preview** to activate the settings. While you are adding/editing the camera, you can enable the recording function for the camera by selecting the **Record** option. Click **Save** after you finish setting.

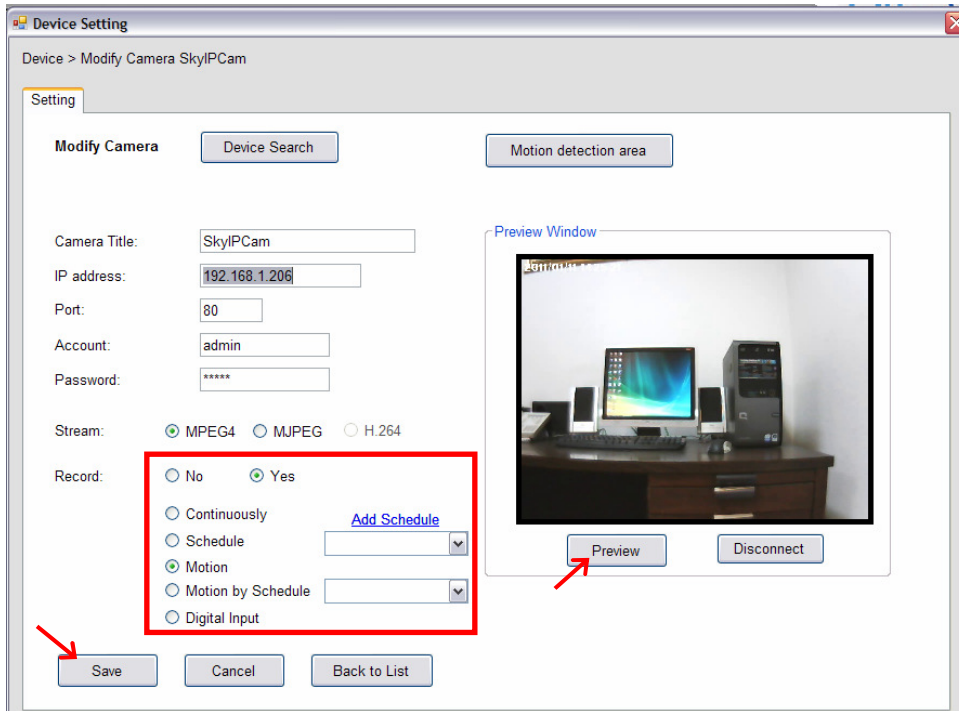

Alternately, you can set all cameras to start/stop recording when you connect multiple cameras. Click the  button and select **All Continuous Recording** to set all cameras to start recording, or select **Stop All Recording** to set all cameras to stop recording.



Since you have enabled the recording function of the camera, it will automatically start recording and save the video clips. The recording time of each file is set to 60 seconds by default.

## ■ Configuring the Recording Settings

The default directory for saving the recorded video files is "C:\". You can change the target folder for saving the files in the **Record Setting** option.

1. Click the  button and then select **Record Setting**.



2. To assign the target folder for saving the recorded files, click the **Browse** button next to the **Recording Path** option, and then select the desired directory. When completed, click **Save**.

To change the time of recording, select the desired time setting from the **Record File** pull-down menu.

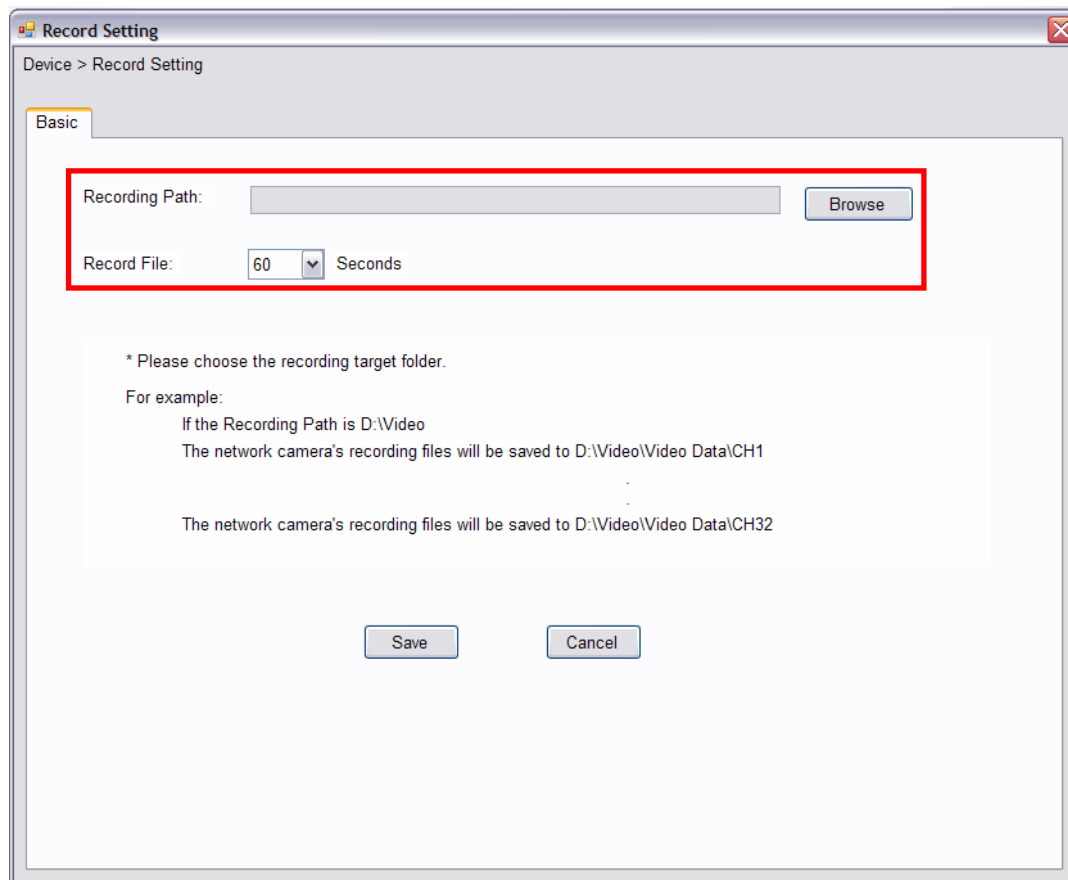

**NOTE** The system will automatically delete the oldest files (10%) when the size of recorded files is up to 90% of the storage space.

## ■ Setting up Schedule for Recording

The system features the schedule recording so that you can set up the schedule to record as you need.

Click the  button to display the Schedule Configuration window, which allows you to configure the recording schedule.

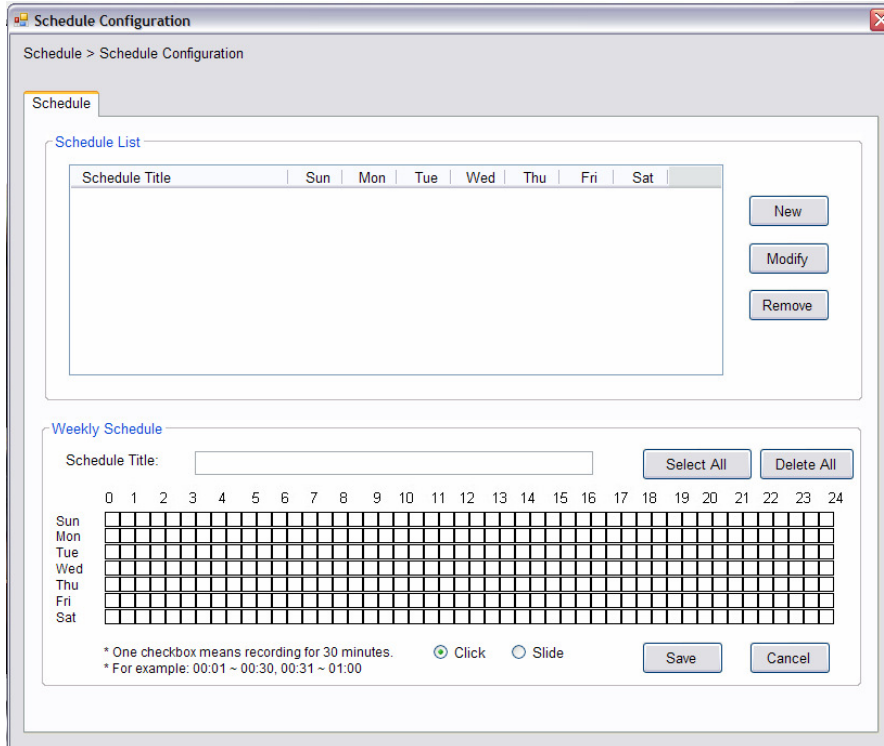

1. Click **New**, and then enter the Schedule Title.
2. Select the checkboxes below the Schedule Title to set the time to record video. One checkbox stands for 30 minutes of recording time. You can choose to assign the single checkbox repeatedly by using Click, or assign a period of time by using Slide. Alternately, you can quickly select/cancel the checkboxes by clicking **Select All** or **Delete All**.
3. When completed, click **Save**. The schedule profile will be added to the Schedule List.
4. To edit the schedule, select the desired schedule profile from the list, and then change the settings by using the **Modify** or **Remove** button.



## ■ Playback the Recording Files

**NOTE** Divx/Xvid codec is required for the system to play the video files. If the video clips cannot be displayed in the Playback window normally, click the following path to download and install the required component: <http://download.divx.com/divx/DivXInstaller.exe>

1. Click the  button to display the Playback window.



2. On the Playback window, set the conditions for search, such as selecting the camera and setting the begin/end date and time. When the search condition has been set, click **Search**.

The search result will be displayed in the Record File list.

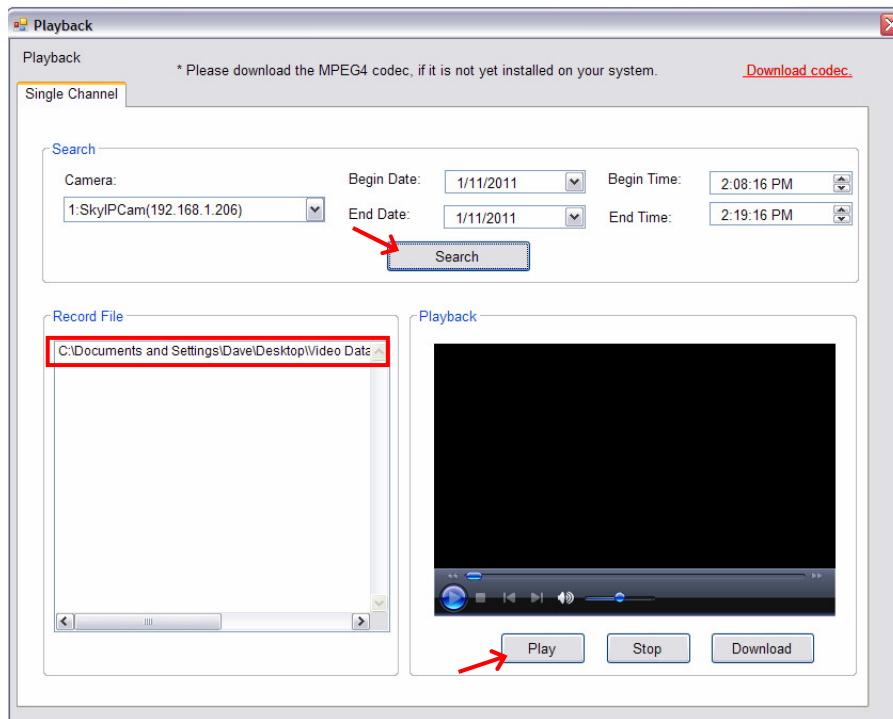

3. To playback the video clip, select the desired file and click **Play**.

## 5.5 Configuring the eMap View Setting

Click the  button and select **View Setting** to configure the camera view setting of eMap mode.



eMap refers to the geography and device scope of the UltraView Pro, which visually presents the devices in your security system. It uses a background of the area (e.g. a picture or a map) as the interface for monitoring.

1. On the View Setting window, click **New**.

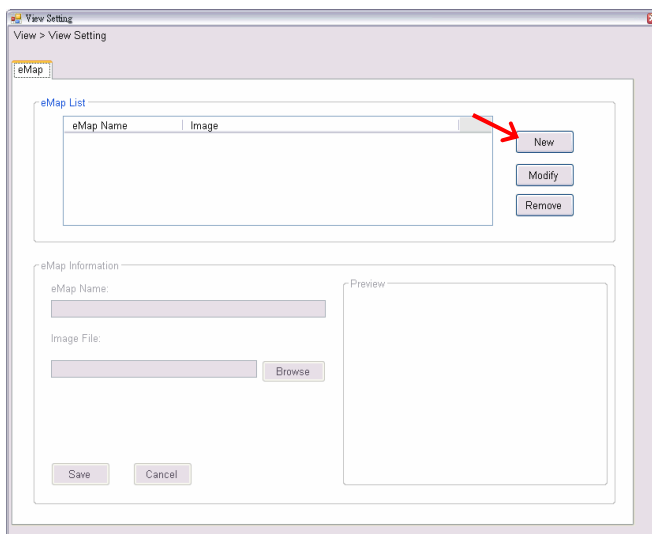

2. Enter the **eMap Name**.

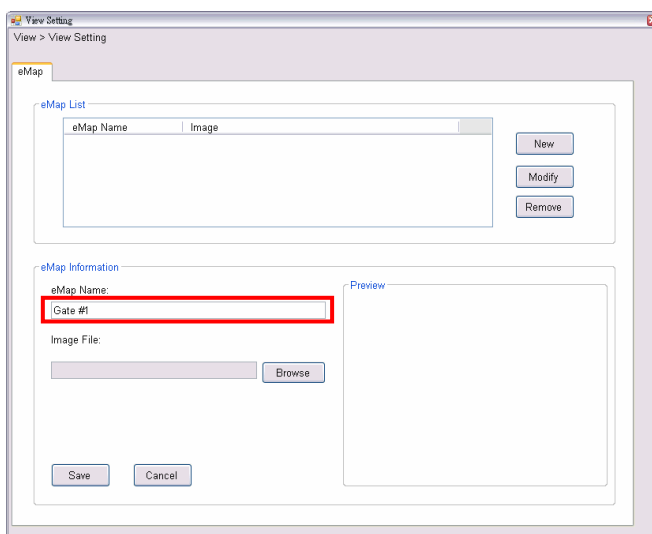

3. Click **Browse** to select a **Picture File** from your computer. The selected picture will be displayed in the Preview window.

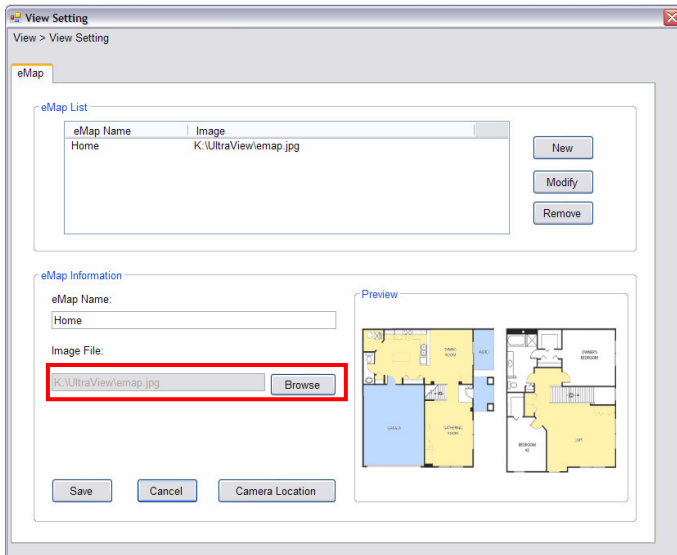

Click **Save** after you complete the settings.

4. On the following window, you can assign the camera position in the eMap.

Click the **Camera Location** button to display the Edit window. Select the camera from the Camera List, and then click the mouse on the desired position of the map. The camera icon will be displayed on selected position of the map.

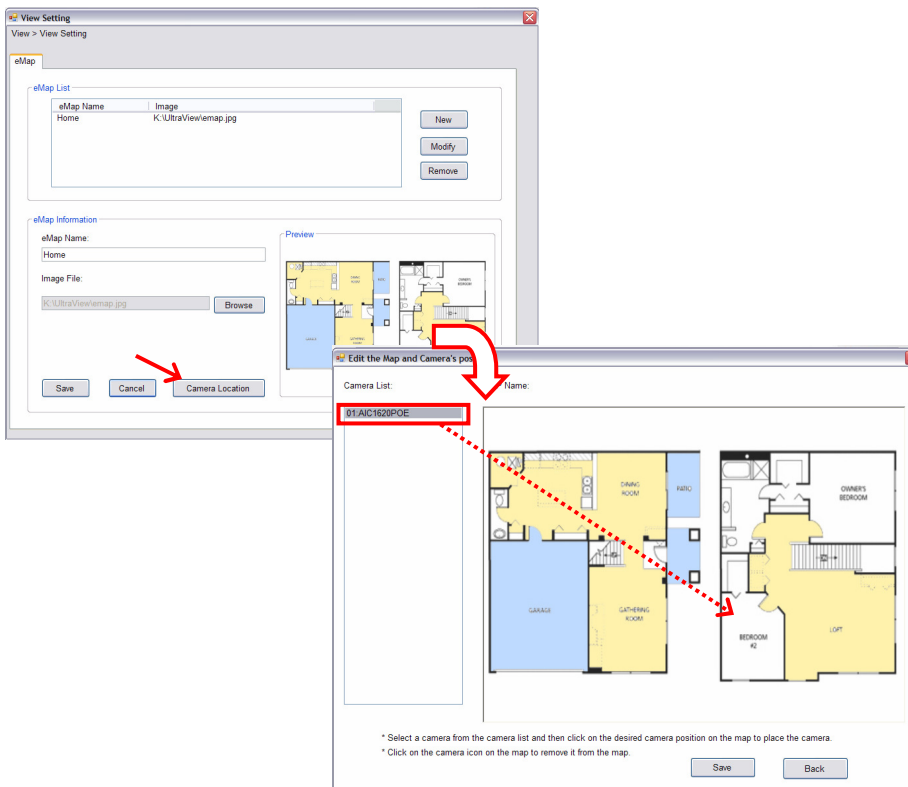

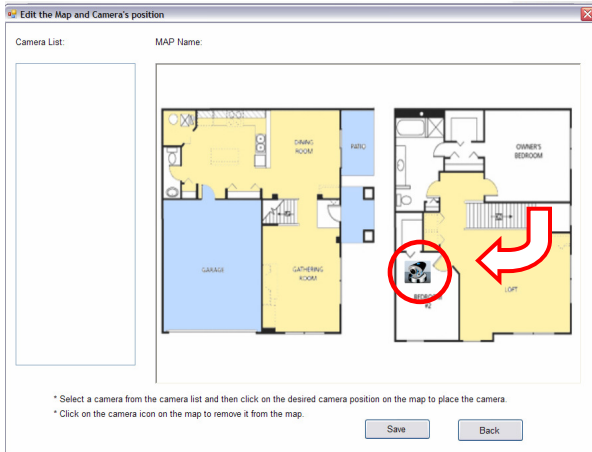

5. When completed, click **Save**. Click **Back** to go back to the Main window.

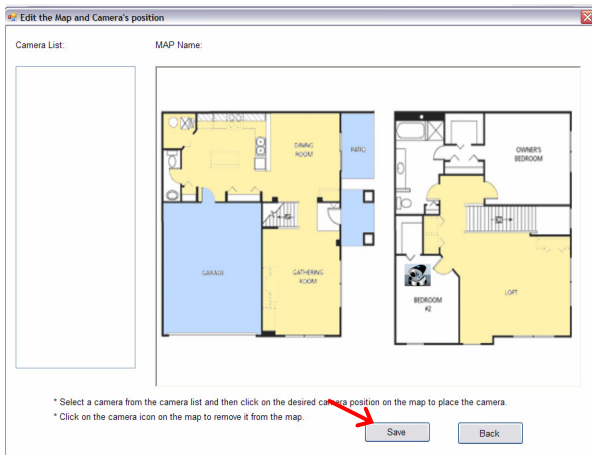

6. To view from eMap:

a. Click the  button and select **eMap View**.

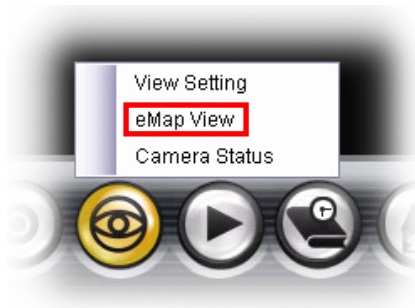

- b. Select the map from the eMap Name list.

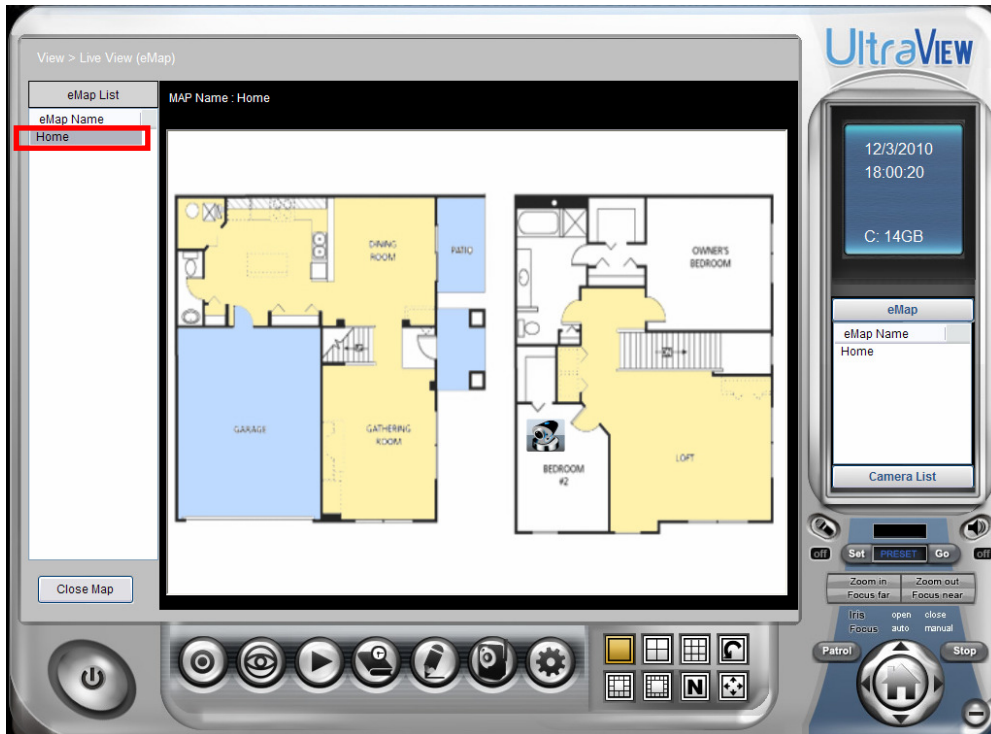

- c. Click the camera icon, the camera window will then pop up to display the image on the spot.

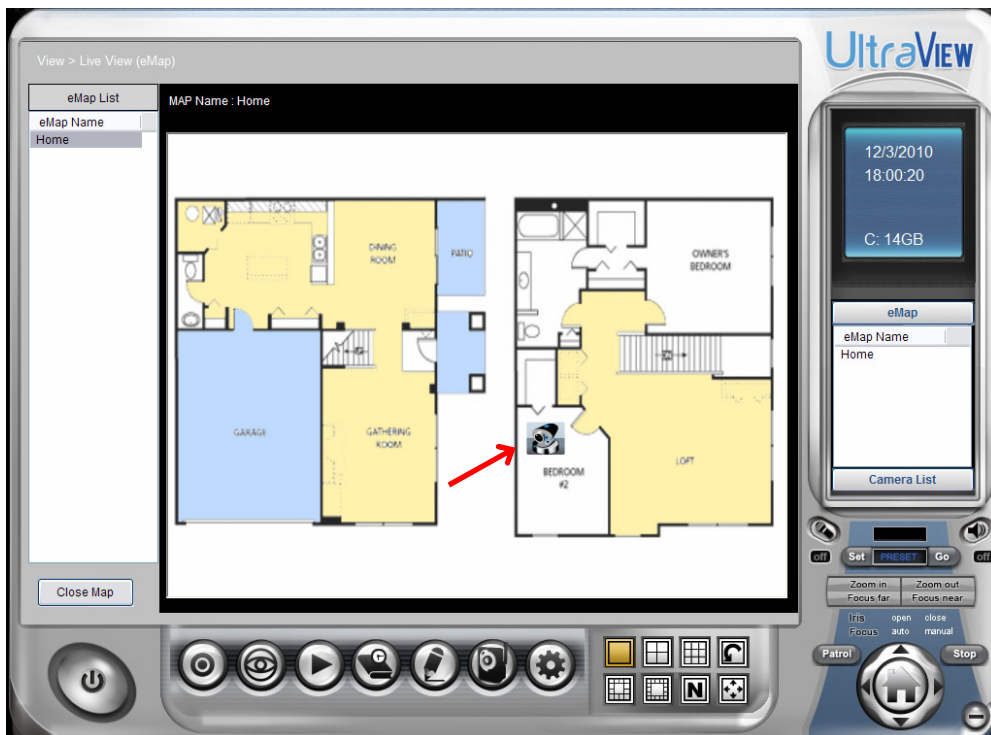

## ■ Editing / Deleting the eMap

1. Click the  button and select **View Setting**.
2. **To edit the eMap:** In the eMap List, select the desired map and click **Modify**.  
The map's information will be displayed, where you can change the map's information and then click **Save** when completed.
3. **To delete the eMap:** In the eMap List, select the desired one and click **Remove**.  
The selected map will be removed from the list.

## 5.6 Configuring the System

### ■ User Management

Click the  button and select **Account** to change the administrator password for the UltraView software.

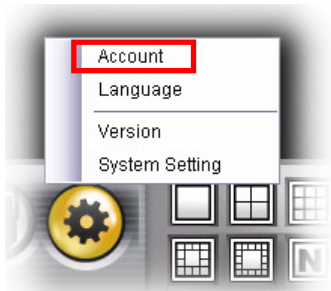

Enter the **Current password**, and then enter the new password twice (in the **Type new password** and **Retype password** boxes). When completed, click **Save**.

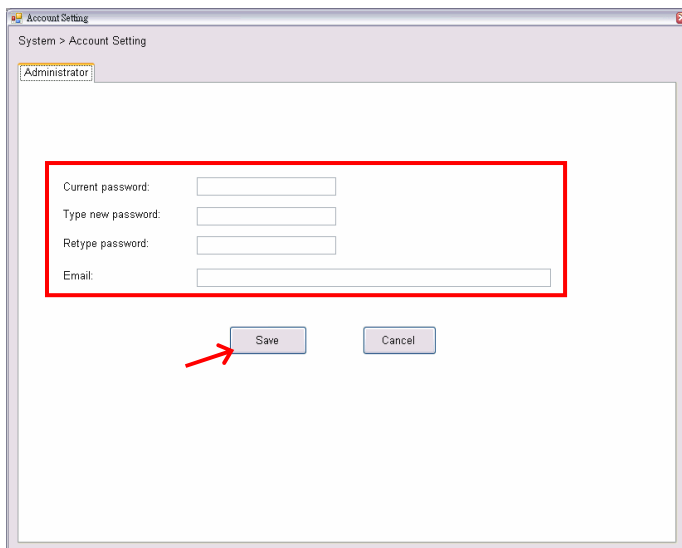
A screenshot of a dialog box titled 'Account Setting'. The dialog box has a title bar with 'System > Account Setting'. Below the title bar, there is a label 'Administrator' followed by a text input field. The main area of the dialog box contains four input fields: 'Current password:', 'Type new password:', 'Retype password:', and 'Email:'. A red rectangular box highlights these four input fields. At the bottom of the dialog box, there are two buttons: 'Save' and 'Cancel'. A red arrow points to the 'Save' button.

## 5.7 Event Configuration

### ■ Configuring Event Trigger



Click the  button and select **Event Trigger** to configure the trigger out function of the camera.



The 'Event Trigger' configuration window is divided into two main sections: 'Camera List' and 'Trigger Setting'.

**Camera List:** A table with columns for 'C...', 'Name', 'IP address', and 'Port'. It contains one entry:

C...	Name	IP address	Port
1	AIC1620...	192.168.1.205	80

**Trigger Setting:** This section includes several options and input fields:

- SMTP: When selected, it enables the 'Address Book List' section, which contains a table with 'Name' and 'Email' columns.
- Subject: A text input field.
- Message: A larger text input area.
- Play Sound: When selected, it enables a 'Browse' button and a 'Test' button.
- eMap Popup: When selected, it enables a pull-down menu.

At the bottom of the window are 'Save' and 'Cancel' buttons.

1. On the Event Trigger window, select the desired camera from the Camera List.
2. Do one of the following:
  - **SMTP:** Select this option and enter the Subject and Message, the system will send an email message to the selected user(s) in the Address Book List.
  - **Play Sound:** Select this option select a sound file from the computer, so that the system will alarm by the sound while triggering out.
  - **eMap Popup:** Select this option and select the eMap profile from the pull-down menu. The camera view of the eMap will be displayed while triggering out.



## ■ Setting up Event Server

Click the  button and select **Event Server** to configure the SMTP server, so that you can send emails that include still images as notification.

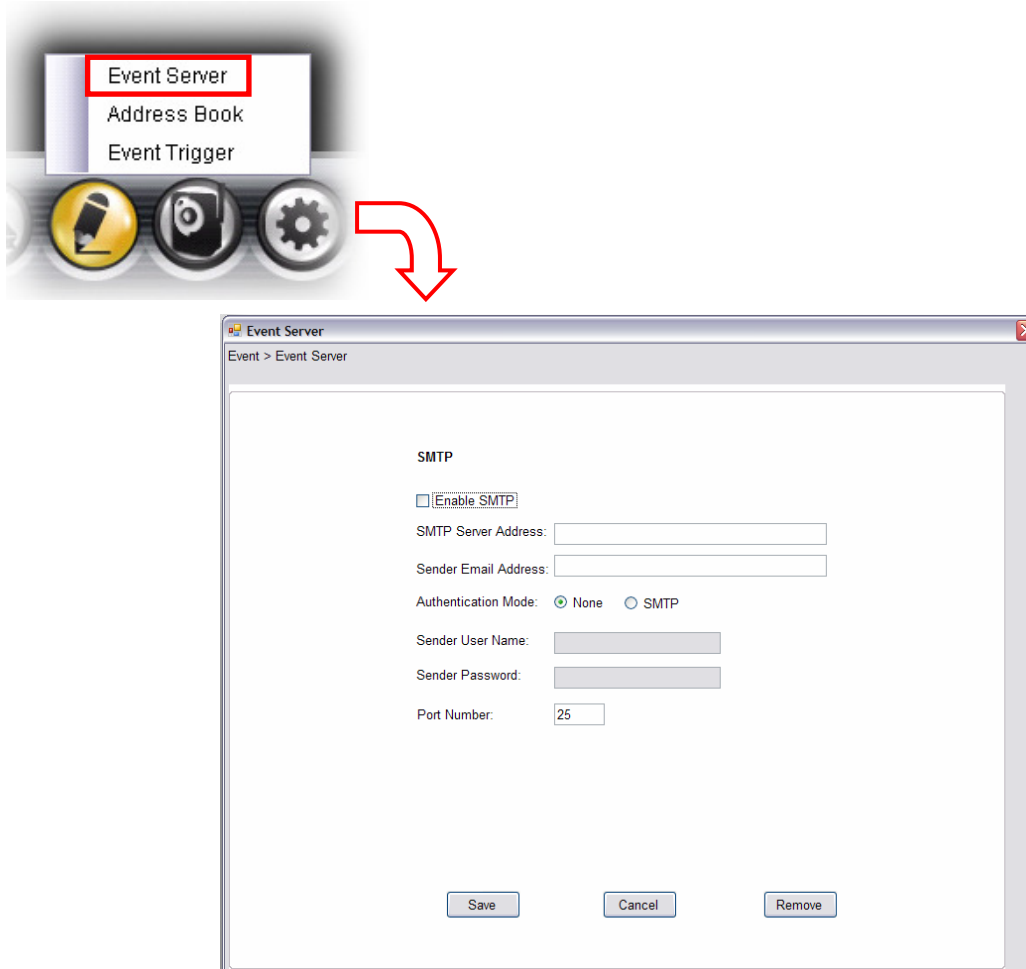

Select the **Enable SMTP** option to start the email service of the system. When you enable the service, you have to complete the following settings.

- **SMTP Server Address:** Enter the mail server address.  
For example, mymail.com.
- **Sender Email Address:** Enter the email address of the user who will send the email. For example, John@mymail.com.
- **Authentication Mode:** Select **None** or **SMTP** according to the mail server configuration.
- **Sender User Name:** Enter the user name to login the mail server.
- **Sender Password:** Enter the password to login the mail server.
- **Port Number:** Enter the port number used for the email server.
- **SSL:** If the mail server requires an encrypted connection, you should check the **SSL** option.

When completed, click **Save** and then select **OK**. The system will automatically start the Event Service.

**TIP** The status of Event Service is indicated by the  icon in the system bar.

## ■ Sending Email Notification



Click the  button and select **Address Book** to assign the user to the Address Book of the camera. The user will receive a real-time notification from the system while triggering out.

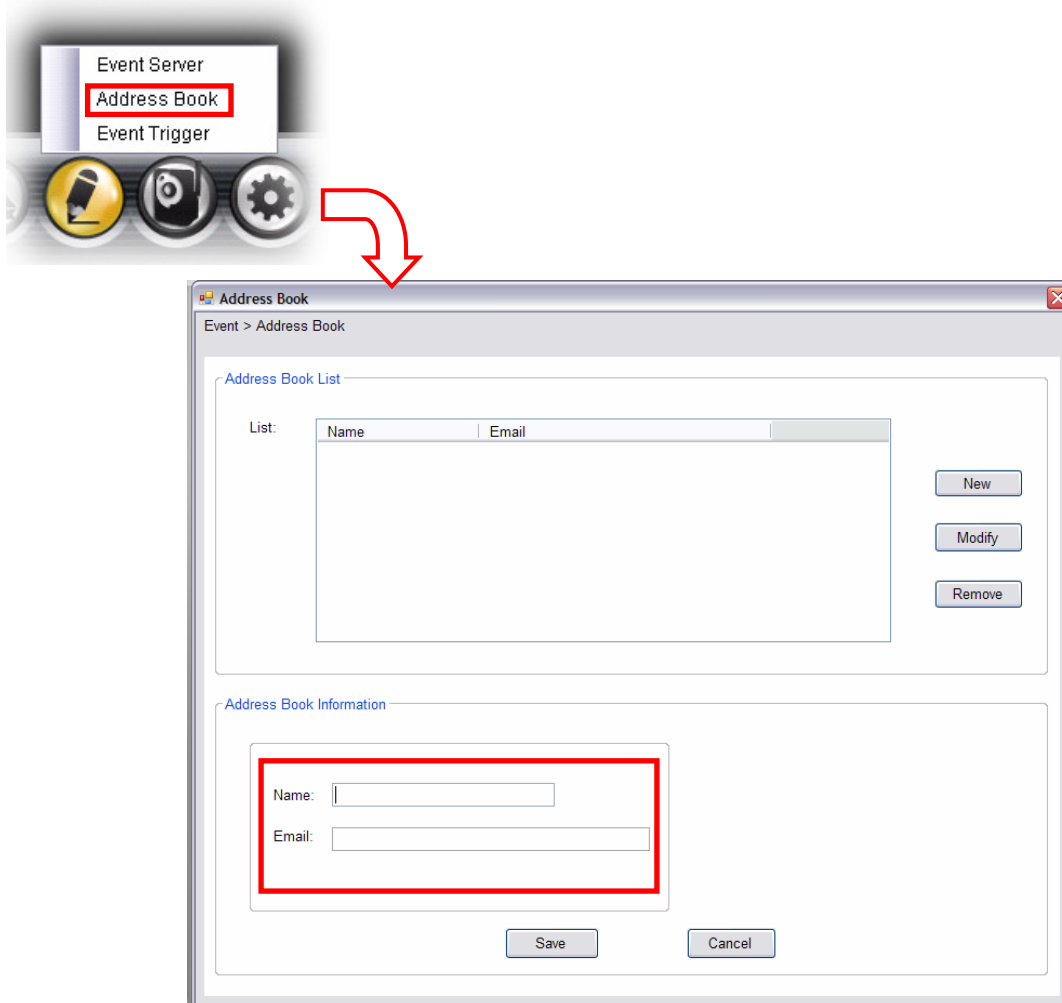

1. On the Address Book window, click **New**.
2. In the Address Book Information field, enter the **Name** and **Email** of receiver.
3. When completed, click **Save**. The receiver will be displayed in the Address Book List.
4. **To edit receiver:** In the Address Book List, select the desired receiver and click **Modify**. The receiver's information will be displayed, where you can change the receiver's information and then click **Save** when completed.
5. **To delete receiver:** In the Address Book List, select the desired receiver and click **Remove**. The selected user will be removed from the list.

## 5.8 Changing System Language

Click the  button and select **language** to change the displayed system language.

On the Language screen, select the preferred language (**English**, **Traditional Chinese**, or **Simplified Chinese**) and click **Save**.

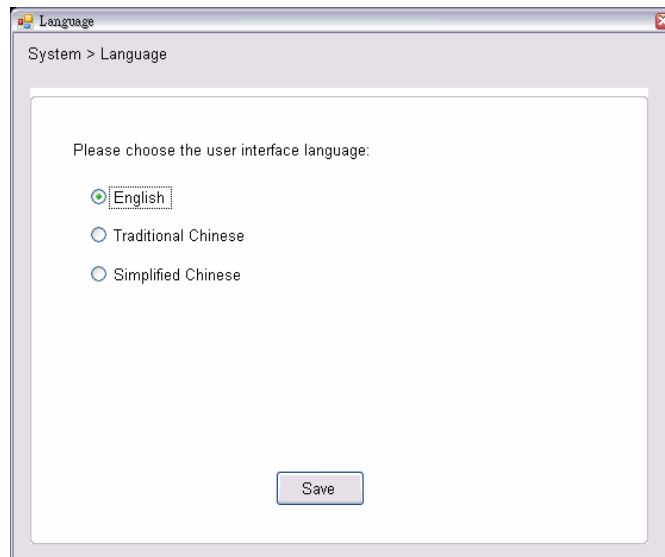
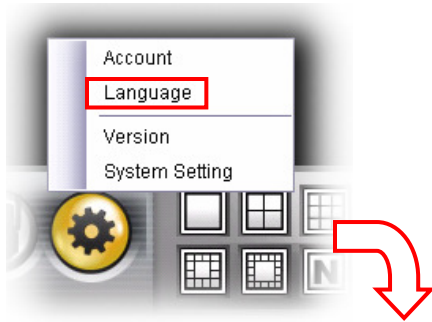

## 5.9 Terminating Operation

When you have finished operating, click the  button and select **Logout** to logout the system or **Close** to exit the program.

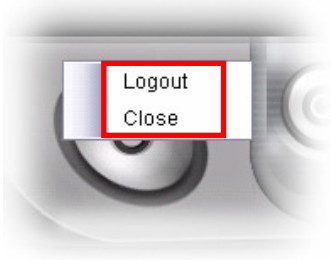

# CHAPTER 6

---

## APPENDIX

### A.1 Specification

#### Image Sensor

- Sensor Type: 1/3" Color CMOS
- Sensor Resolution: 640 x 480 pixel
- Minimum Illumination: 0.5 Lux

#### Lens

- Lens Type: CS-Mount
- View Angle (Diagonal): 72 degree
- Focal Length: 4mm
- Aperture (F/No.): F1.2

#### Video

- Image Compression: MPEG4/MJPEG
- Exposure, White Balance, Gain Control: Automatic
- Resolution and Frame Rate:
  - VGA (640 x 480): 30fps
  - QVGA (320 x 240): 30fps
  - QQVGA (160 x 120): 30fps

#### Audio

- Input: Built-in Microphone (Sensitivity: -48dB +/- 3dBFreq)
- Output: External Connector for Mono Speaker
- Codec: PCM / AMR

#### Communication

- IEEE802.3u 10/100Mbps Fast Ethernet
- IEEE802.11b / g / n, data rate of up to 150Mbps\*
- Supported Protocols: TCP/IP, UDP, ICMP, DHCP, NTP, DNS, DDNS, SMTP, FTP, HTTP, Samba, PPPoE, UPnP, RTP, RTSP, RTCP

#### Wireless Security

- WPA2/WPA-PSK
- WEP 64/128-bit

#### Multi-Profile

- 3 profiles streaming simultaneous

#### Antenna

- 2dBi Detachable Dipole Antenna

#### LED

- Power (Orange)
- Link (Green)

#### Interface & Buttons

- DC Power Connector
- Antenna Connector
- Ethernet Cable Connector
- GPIO (1 In & 1 Out) & RS485 Connector
- Audio-out port
- Microphone-in port
- Reset Button

#### Power Adapter

- Input: AC 100-240V, 50-60Hz
- Output: DC 12V / 1.5A
- Power Consumption: 8 watts Max.

#### Dimensions

- 135 x 77 x 48mm (L x W x H)

#### System Requirements

- To run setup utility and install UltraView: Windows XP/Vista/7
- To view/manage camera from web browser: Internet Explorer 6.0 or above, Safari and Mozilla Firefox (with Java plug-in for MJPEG and Quick Time plug-in for MPEG4)

#### Operating Environment

- Temperature : 0°C ~ 45°C
- Humidity : 20% ~ 85% non-condensing

#### Storage Environment

- Temperature : -15°C ~ 60°C
- Humidity : 0% ~ 90% non-condensing

#### Safety Approval

- FCC and CE

#### Warranty

- 1-Year Limited Warranty

## A.2 GPIO Terminal Application

Typically used in association with programming scripts for developing applications for motion detection, event triggering, alarm notification via e-mail, and a variety of external control functions. The 6-pin I/O Terminal Block is located on the rear panel and provides the interface to: a photo-coupled switch output, a photo-coupled input, and RS-485 interface. The RS-485 is typically used for pan/tilt control.

### ■ Connector Pin Assignment

PIN	FUNCTION	SPECIFICATION
IN+	Photo-Relay INPUT (+)	Active High voltage 9~40VDC Dropout voltage 0 VDC.
IN-	Photo-Relay INPUT (-)	
OUT+	Photo-Relay OUTPUT (Normal Open)	Close circuit current maximum 70mA AC or 100mA DC. Output resistance 30 Ohm. Open circuit voltage maximum 240V AC or 350V DC.
OUT-	Photo-Relay OUTPUT (Common)	
TX+	RS-485 (+) or (A)	Compliant to RS-485.
TX-	RS-485 (-) or (B)	

### ■ Interface Schematic

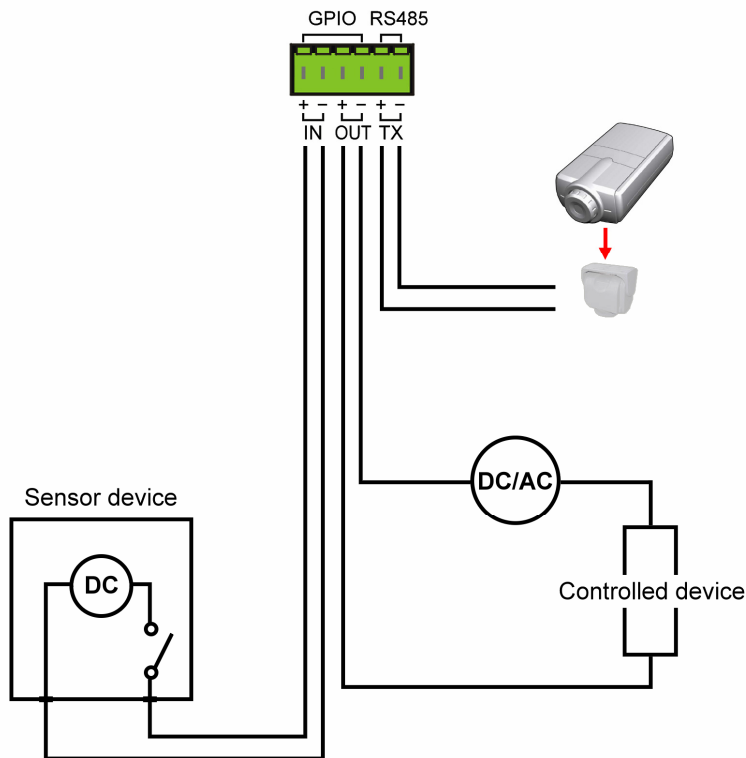

## A.3 Bandwidth Reference Guide

### ■ MPEG4

Resolution	Frame rate (fps)	Bit rate (Kbit/s)				
		Lowest	Low	Normal	High	Highest
QQVGA	30	128	128	128	128	128
QVGA	30	128	128	256	512	1024
VGA	30	128	256	512	1024	2048

### ■ MJPEG

Resolution	Image size (KB)				
	Lowest	Low	Normal	High	highest
QQVGA	1.5	1.9	2.4	2.7	4.1
QVGA	3.2	4.2	5.4	6.3	9.7
VGA	8.8	11.2	14	16	24.3

## A.4 Glossary of Terms

### NUMBERS

**10BASE-T** 10BASE-T is Ethernet over UTP Category III, IV, or V unshielded twisted-pair media.  
**100BASE-TX** The two-pair twisted-media implementation of 100BASE-T is called 100BASE-TX.

### A

**ADPCM** Adaptive Differential Pulse Code Modulation, a new technology improved from PCM, which encodes analog sounds to digital form.

**AMR** AMR (Adaptive Multi-Rate) is an audio data compression scheme optimized for speech coding, which is adopted as the standard speech codec by 3GPP.

**Applet** Applets are small Java programs that can be embedded in an HTML page. The rule at the moment is that an applet can only make an Internet connection to the computer form that the applet was sent.

**ASCII** American Standard Code For Information Interchange, it is the standard method for encoding characters as 8-bit sequences of binary numbers, allowing a maximum of 256 characters.

**ARP** Address Resolution Protocol. ARP is a protocol that resides at the TCP/IP Internet layer that delivers data on the same network by translating an IP address to a physical address.

**AVI** Audio Video Interleave, it is a Windows platform audio and video file type, a common format for small movies and videos.

### B

**BOOTP** Bootstrap Protocol is an Internet protocol that can automatically configure a network device in a diskless workstation to give its own IP address.

### C

**Communication** Communication has four components: sender, receiver, message, and medium. In networks, devices and application tasks and processes communicate messages to each other over media. They represent the sender and receivers. The data they send is the message. The cabling or transmission method they use is the medium.

**Connection** In networking, two devices establish a connection to communicate with each other.

### D

**DHCP** Developed by Microsoft, DHCP (Dynamic Host Configuration Protocol) is a protocol for assigning dynamic IP addresses to devices on a network. With dynamic addressing, a device can have a different IP address every time it connects to the network. In some systems, the device's IP address can even change while it is still connected. It also supports a mix of static and dynamic IP addresses. This simplifies the task for network administrators because the software keeps track of IP addresses rather than requiring an administrator to manage the task. A new computer can be added to a network without the hassle of manually assigning it a unique IP address. DHCP allows the specification for the service provided by a router, gateway, or other network device that automatically assigns an IP address to any device that requests one.

**DNS** Domain Name System is an Internet service that translates domain names into IP addresses. Since domain names are alphabetic, they're easier to remember. The Internet however, is really based on IP addresses every time you use a domain name the DNS will translate the name into the corresponding IP address. For example, the domain name *www.network\_camera.com* might translate to *192.167.222.8*.

### E

**Enterprise network** An enterprise network consists of collections of networks connected to each other over a geographically dispersed area. The enterprise network serves the needs of a widely distributed company and operates the company's mission-critical applications.



<b>Ethernet</b>	The most popular LAN communication technology. There are a variety of types of Ethernet, including 10Mbps (traditional Ethernet), 100Mbps (Fast Ethernet), and 1,000Mbps (Gigabit Ethernet). Most Ethernet networks use Category 5 cabling to carry information, in the form of electrical signals, between devices. Ethernet is an implementation of CSMA/CD that operates in a bus or star topology.
<b><u>F</u></b>	
<b>Fast Ethernet</b>	Fast Ethernet, also called 100BASE-T, operates at 10 or 100Mbps per second over UTP, STP, or fiber-optic media.
<b>Firewall</b>	Firewall is considered the first line of defense in protecting private information. For better security, data can be encrypted. A system designed to prevent unauthorized access to or from a private network. Firewalls are frequently used to prevent unauthorized Internet users from accessing private networks connected to the Internet, especially Intranets all messages entering or leaving the intranet pass through the firewall, which examines each message and blocks those that do not meet the specified security criteria.
<b><u>G</u></b>	
<b>Gateway Group</b>	A gateway links computers that use different data formats together. Groups consist of several user machines that have similar characteristics such as being in the same department.
<b><u>H</u></b>	
<b>HEX</b>	Short for hexadecimal refers to the base-16 number system, which consists of 16 unique symbols: the numbers 0 to 9 and the letters A to F. For example, the decimal number 15 is represented as F in the hexadecimal numbering system. The hexadecimal system is useful because it can represent every byte (8 bits) as two consecutive hexadecimal digits. It is easier for humans to read hexadecimal numbers than binary numbers.
<b><u>I</u></b>	
<b>Intranet</b>	This is a private network, inside an organization or company that uses the same software you will find on the public Internet. The only difference is that an Intranet is used for internal usage only.
<b>Internet</b>	The Internet is a globally linked system of computers that are logically connected based on the Internet Protocol (IP). The Internet provides different ways to access private and public information worldwide.
<b>Internet address</b>	To participate in Internet communications and on Internet Protocol-based networks, a node must have an Internet address that identifies it to the other nodes. All Internet addresses are IP addresses
<b>IP</b>	Internet Protocol is the standard that describes the layout of the basic unit of information on the Internet (the <i>packet</i> ) and also details the numerical addressing format used to route the information. Your Internet service provider controls the IP address of any device it connects to the Internet. The IP addresses in your network must conform to IP addressing rules. In smaller LANs, most people will allow the DHCP function of a router or gateway to assign the IP addresses on internal networks.
<b>IP address</b>	IP address is a 32-binary digit number that identifies each sender or receiver of information that is sent in packets across the Internet. For example 80.80.80.69 is an IP address. When you "call" that number, using any connection methods, you get connected to the computer that "owns" that IP address.
<b>ISP</b>	ISP (Internet Service Provider) is a company that maintains a network that is linked to the Internet by way of a dedicated communication line. An ISP offers the use of its dedicated communication lines to companies or individuals who can't afford the high monthly cost for a direct connection.
<b><u>J</u></b>	
<b>JAVA</b>	Java is a programming language that is specially designed for writing programs that can be safely downloaded to your computer through the Internet without the fear of viruses.

It is an object-oriented multi-thread programming best for creating applets and applications for the Internet, Intranet and other complex, distributed network.

## L

### **LAN**

Local Area Network a computer network that spans a relatively small area sharing common resources. Most LANs are confined to a single building or group of buildings.

## M

### **MJPEG**

MJPEG (Motion JPEG) composes a moving image by storing each frame of a moving picture sequence in JPEG compression, and then decompressing and displaying each frame at rapid speed to show the moving picture.

### **MPEG4**

MPEG4 is designed to enable transmission and reception of high-quality audio and video over the Internet and next-generation mobile telephones.

## N

### **NAT**

Network Address Translator generally applied by a router that makes many different IP addresses on an internal network appear to the Internet as a single address. For routing messages properly within your network, each device requires a unique IP address. But the addresses may not be valid outside your network. NAT solves the problem. When devices within your network request information from the Internet, the requests are forwarded to the Internet under the router's IP address. NAT distributes the responses to the proper IP addresses within your network.

### **Network**

A network consists of a collection of two or more devices, people, or components that communicate with each other over physical or virtual media. The most common types of network are:

**LAN** – (local area network): Computers are in close distance to one another. They are usually in the same office space, room, or building.

**WAN** – (wide area network): The computers are in different geographic locations and are connected by telephone lines or radio waves.

### **NWay Protocol**

A network protocol that can automatically negotiate the highest possible transmission speed between two devices.

## P

### **PCM**

PCM (Pulse Code Modulation) is a technique for converting analog audio signals into digital form for transmission.

### **PING**

Packet Internet Groper, a utility used to determine whether a specific IP address is accessible. It functions by sending a packet to the specified address and waits for a reply. It is primarily used to troubleshoot Internet connections.

### **PPPoE**

Point-to-Point Protocol over Ethernet. PPPoE is a specification for connecting the users on an Ethernet to the Internet through a common broadband medium, such as DSL or cable modem. All the users over the Ethernet share a common connection.

### **Protocol**

Communication on the network is governed by sets of rules called protocols. Protocols provide the guidelines devices use to communicate with each other, and thus they have different functions. Some protocols are responsible for formatting and presenting and presenting data that will be transferred from file server memory to the file server's network adapter Others are responsible for filtering information between networks and forwarding data to its destination. Still other protocols dictate how data is transferred across the medium, and how servers respond to workstation requests and vice versa. Common network protocols responsible for the presentation and formatting of data for a network operating system are the Internetwork Packet Exchange (IPX) protocol or the Internet Protocol (IP). Protocols that dictate the format of data for transfers the medium include token-passing and Carrier Sense Multiple Access with Collision Detection (CSMA/CD), implemented as token-ring, ARCNET, FDDI, or Ethernet. The Router Information Protocol (RIP), a part of the Transmission Control Protocol/Internet Protocol (TCP/IP) suite, forwards packets from one network to another using the same

network protocol.

## **R**

### **RJ-45**

RJ-45 connector is used for Ethernet cable connections.

### **Router**

A router is the network software or hardware entity charged with routing packets between networks.

### **RTP**

RTP (Real-time Transport Protocol) is a data transfer protocol defined to deliver **live media** to the clients at the same time, which defines the transmission of video and audio files in real time for Internet applications.

### **RTSP**

RTSP (Real-time Streaming Protocol) is the standard used to transmit **stored media** to the client(s) at the same time, which provides client controls for random access to the content stream.

## **S**

### **Server**

It is a simple computer that provides resources, such as files or other information.

### **SIP**

SIP (Session Initiated Protocol) is a standard protocol that delivers the real-time communication for Voice over IP (VoIP), which establishes sessions for features such as audio and video conferencing.

### **SMTP**

The Simple Mail Transfer Protocol is used for Internet mail.

### **SNMP**

Simple Network Management Protocol. SNMP was designed to provide a common foundation for managing network devices.

### **Station**

In LANs, a station consists of a device that can communicate data on the network. In FDDI, a station includes both physical nodes and addressable logical devices. Workstations, single-attach stations, dual-attach stations, and concentrators are FDDI stations.

### **Subnet mask**

In TCP/IP, the bits used to create the subnet are called the subnet mask.

## **T**

### **(TCP/IP)**

Transmission Control Protocol/Internet Protocol is a widely used transport protocol that connects diverse computers of various transmission methods. It was developed by the Department of Defense to connect different computer types and led to the development of the Internet.

### **Transceiver**

A transceiver joins two network segments together. Transceivers can also be used to join a segment that uses one medium to a segment that uses a different medium. On a 10BASE-5 network, the transceiver connects the network adapter or other network device to the medium. Transceivers also can be used on 10BASE-2 or 10BASE-T networks to attach devices with AUI ports.

## **U**

### **UDP**

The User Datagram Protocol is a connectionless protocol that resides above IP in the TCP/IP suite

### **User Name**

The USERNAME is the unique name assigned to each person who has access to the LAN.

### **Utility**

It is a program that performs a specific task.

### **UTP**

Unshielded twisted-pair. UTP is a form of cable used by all access methods. It consists of several pairs of wires enclosed in an unshielded sheath.

## Technical Support

E-mail: [support@airlink101.com](mailto:support@airlink101.com)

Toll Free: 1-888-746-3238

Web Site: [www.airlink101.com](http://www.airlink101.com)

\* AIC1620W supports most of the mobile devices, but compatibility with every mobile device is not guaranteed.

\*\* Monitoring multiple cameras simultaneously demands high performance computer system.

\*\*\* Theoretical maximum wireless signal rate derived from IEEE standard 802.11 specifications. Actual data throughput will vary. Network conditions and environmental factors, including volume of network traffic, building materials and construction, mix of wireless products used, radio frequency interference (e.g., cordless telephones and microwaves) as well as network overhead lower actual data throughput rate. Compatibility with 802.11n devices from other manufactures is not guaranteed. Specifications are subject to change without notice. Photo of product may not reflect actual content. All products and trademarks are the property of their respective owners. Copyright ©2011 Airlink101®

## Free Manuals Download Website

<http://myh66.com>

<http://usermanuals.us>

<http://www.somanuals.com>

<http://www.4manuals.cc>

<http://www.manual-lib.com>

<http://www.404manual.com>

<http://www.luxmanual.com>

<http://aubethermostatmanual.com>

Golf course search by state

<http://golfingnear.com>

Email search by domain

<http://emailbydomain.com>

Auto manuals search

<http://auto.somanuals.com>

TV manuals search

<http://tv.somanuals.com>