

aiwa

COMPACT
disc
DIGITAL AUDIO

OPERATING INSTRUCTIONS
MANUAL DE INSTRUCCIONES
MODE D'EMPLOI

CDC-X145 YU

STEREO CAR CD RECEIVER
RADIO-TOCADISCOS DE CD ESTEREOFONICO PARA
AUTOMOVIL

OWNER'S RECORD

For your convenience, record the model number and serial number (you will find them on the right side of your set) in the space provided below. Please refer to them when you contact your AIWA dealer in case of difficulty.

Model No.

Serial No.

Welcome

Thank you for your purchasing this AIWA product. To optimize the performance of this unit, please read through this manual carefully.

In addition to this operating instructions manual, be sure to refer to the separate installation and connections manuals as well.

PRECAUTIONS

- This unit is designed to be operated on a 12-volt DC negative-ground electrical system only.
- To prevent short-circuiting, disconnect the negative car battery terminal until the unit has been mounted and connected completely.
- When replacing the fuse, be sure to use one whose amperage rating is identical. Use of a fuse of higher amperage may cause serious damage to the unit.
- Do NOT attempt to disassemble this unit. Laser rays from the optical pickup are dangerous to the eyes.
- Make sure that pins or other foreign objects do not get inside the unit; they may cause malfunctioning, or a safety hazard such as electrical shock or exposure of laser rays.
- When your car was parked in direct sunlight resulting in a considerable rise in temperature inside the car, allow the unit to cool off before operating it.
- Keep the volume at such a level that you can hear outside warning sounds (horns, sirens, etc.).

NOTE

This equipment has been tested and found to comply with the limits for a Class B digital device, pursuant to Part 15 of the FCC Rules. These limits are designed to provide reasonable protection against harmful interference in a residential installation.

This equipment generates, uses, and can radiate radio frequency energy and, if not installed and used in accordance with the instructions, may cause harmful interference to radio communications. However, there is no guarantee that interference will not occur in a particular installation. If this equipment does cause harmful interference to radio or television reception, which can be determined by turning the equipment off and on, the user is encouraged to try to correct the interference by one or more of the following measures:

- Reorient or relocate the receiving antenna.
- Increase the separation between the equipment and receiver.
- Connect the equipment into an outlet on circuit different from that to which the receiver is connected.
- Consult the dealer or an experienced radio/TV technician for help.

CAUTION

Modifications or adjustments to this product, which are not expressly approved by the manufacturer, may void the user's right or authority to operate this product.

TABLE OF CONTENTS

FRONT PANEL	3
DETACHING AND ATTACHING THE FRONT PANEL	4
SETTING THE CLOCK	5
RADIO OPERATION	5
PRESETTING STATIONS	6
CD PLAY	8
SOUND ADJUSTMENTS	9
CONNECTING A PORTABLE CASSETTE PLAYER OR OTHER EQUIPMENT	10
TROUBLE SHOOTING	11
MAINTENANCE	11
SPECIFICATIONS	12

Notes on CDs

- A defective or soiled disc inserted into the unit can cause sound to drop out during playback.
- Handle the disc by holding its inner and outer edges.



- Do NOT touch the surface of the unlabeled side of the disc.
- Do NOT stick paper or tape etc. on the surface.



- Do NOT expose the disc to direct sunlight or excessive heat.

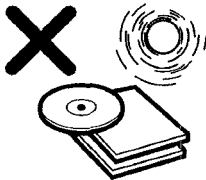

- Clean the disc before playback. Wipe the disc from the center outward with a cleaning cloth.



- NEVER use solvents such as benzine or alcohol to clean the disc.
- Smaller 3-inch (8cm) CDs can not be played on this unit. And do not use adaptor as it may cause malfunctioning.
- Do not use irregular shape CDs (example: heart-shaped, octagonal ones). It may result in malfunction.

FRONT PANEL

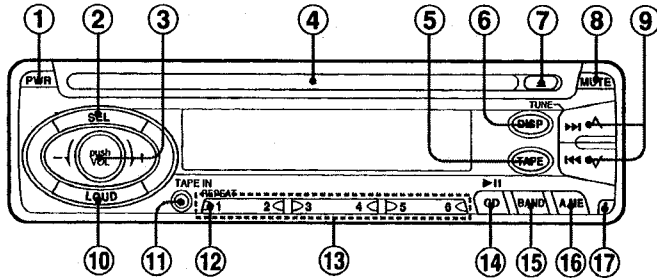

Display window

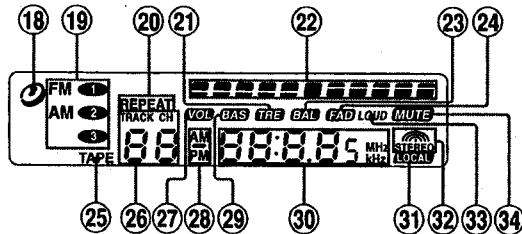

- | | |
|---|----------------------------------|
| ① PWR (power on/off) button | ⑱ CD indicator |
| ② SEL (select) button | ⑲ Band indicator |
| ③ VOL (volume/audio) control | ⑳ REPEAT indicator |
| ④ Disc compartment | ㉑ TRE (treble) indicator |
| ⑤ TAPE button | ㉒ Audio control indications |
| ⑥ DISP (display) button | ㉓ BAL (balance) indicator |
| ⑦ ▲ (eject) button | ㉔ FAD (fader) indicator |
| ⑧ MUTE button | ㉕ TAPE indicator |
| ⑨ ►► (forward skip)/TUNE ^ /
◄◄ (back skip)/TUNE v buttons | ㉖ Track/Preset number indication |
| ⑩ LOUD button | ㉗ VOL (volume) indicator |
| ⑪ TAPE IN jack (3.5-mm dia.) | ㉘ AM/PM indicator |
| ⑫ REPEAT button | ㉙ BAS (bass) indicator |
| ⑬ Preset station buttons 1-6 | ⑳ Main display section |
| ⑭ CD (CD play/pause) button | ㉑ LOCAL indicator |
| ⑮ BAND button | ㉒ STEREO indicator |
| ⑯ A.ME (auto memory/preset scan) button | ㉓ LOUD (loudness) indicator |
| ⑰ & (release) button | ㉔ MUTE indicator |

DETACHING AND ATTACHING THE FRONT PANEL

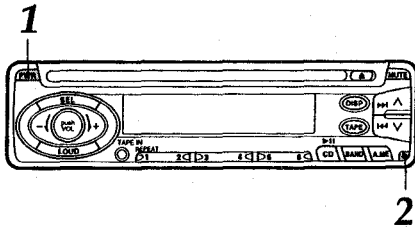

You can detach the front panel from the unit and carry it with you when you leave your car unattended.

When you carry the front panel out of your car, use the supplied carrying case.

Before detaching the front panel, remove the CD to prevent possible damage to the unit.

- 1 Press **PWR** to turn the unit off.
- 2 While supporting the front panel with one hand, press **⬇** to release one side of the panel. Care must be taken not to drop the panel. It may suddenly eject at this point.
- 3 When the front panel is lifted from the unit, remove it by pulling away from the unit.

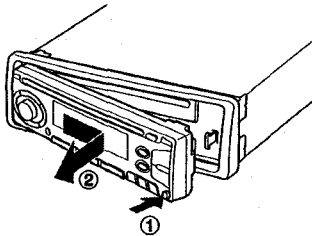

Do NOT touch the connector on the reverse side of the front panel, as doing so may contaminate the connector and cause a poor connection resulting in a malfunction.

Attaching the front panel

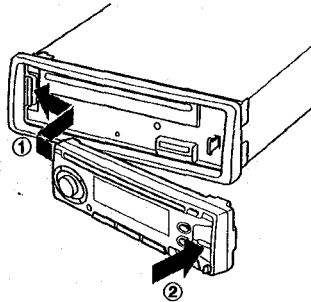

Security Lamp

When the front panel is detached, you can find an LED lamp on the front side of the unit. This lamp is designed to deter theft, and continues to flash when the car's ignition is turned off with the front panel detached. This unit is not equipped with any other security systems such as a security alarm, so there are limitations to its effectiveness.

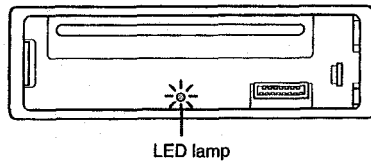

SETTING THE CLOCK

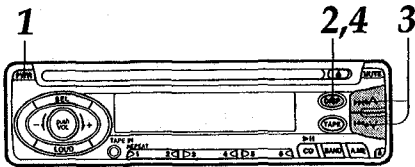

- 1 Press PWR to turn the unit on.
- 2 Press and hold DISP for more than 2 seconds.

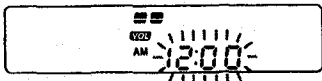

- 3 Press \wedge to set the hour.
Press \vee to set the minutes.
- 4 Press DISP.
The clock starts working from 0 second.

Having the clock displayed while the unit is turned on

Press DISP. The clock display appears for a few minutes, then the unit returns to its former display.

RADIO OPERATION

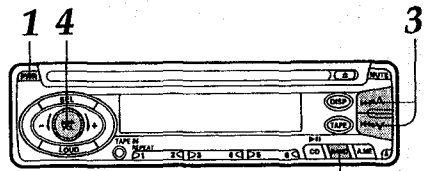

- 1 Press PWR to turn the unit on.
- 2 Press BAND to select the band from among FM1, FM2, FM3, AM1, and AM2. The band indication appears cyclically in order. FM1, FM2 and FM3 share the same frequency range. AM1 and AM2 share the same frequency range.

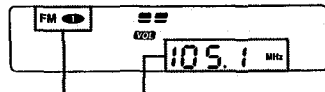

Band indication Frequency indication

- 3 Press (more than 0.5 second) either TUNE \wedge or TUNE \vee to tune in the desired station. Press \wedge to increase and \vee to decrease the frequency. The unit starts scanning and tunes in a station automatically (Seek tuning). Press the button again to deactivate the function. Repeat the procedure until the desired station is tuned in.

Note

If you press (less than 0.5 second at a time) either TUNE \wedge or TUNE \vee , the frequency decreases or increases step by step.

- 4 Press VOL to project out the control and turn it to $+$ or $-$ to adjust the volume.

To turn the unit off
Press PWR.

Note

The "STEREO" indicator lights up when the tuned-in station is broadcasting in stereo and the reception is good.

PRESETTING STATIONS

**To preset stations automatically
(auto memory)**

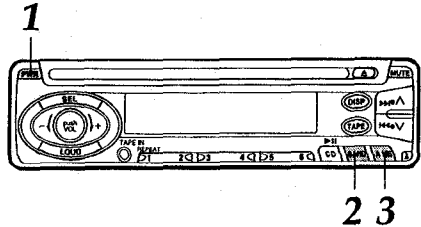

- 1 Press PWR to turn the unit on.
- 2 Press BAND to select a desired band from among FM1, FM2, FM3, AM1, and AM2.



- 3 Press and hold A.ME for more than 2 seconds to activate the automatic presetting function.

This unit can store up to 6 stations in memory for preset station button 1 to 6 with LOCAL indicator lights up.

If the unit could not search for all of 6 stations, LOCAL indicator goes off and starts searching for weaker stations again.

Use this function to automatically preset up to 6 stations each for FM1, FM2, FM3, AM1, and AM2 (up to a total of 30 stations).

- When auto memory is completed, the preset stations are automatically scanned in order.
- To stop auto memory, press A.ME again.

To check the preset stations (preset scan)

- If you wish to check the preset stations, press A.ME for less than 2 seconds. The preset stations stored in memory will be tuned in for 5 seconds each in order.
- To stop this function, press A.ME again or press any of the preset station buttons 1 to 6.

continued

ENGLISH 6

PRESETTING STATIONS

To preset stations manually

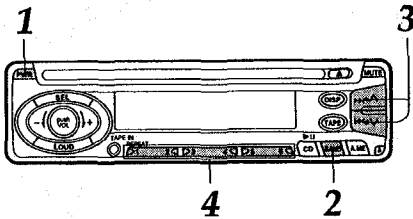

- 1 Press PWR to turn the unit on.
- 2 Press BAND to select the band from among FM1, FM2, FM3, AM1, and AM2.
- 3 Tune in the station that you wish to preset with TUNE ^ or TUNE v.
- 4 Press one of the preset station buttons 1 to 6 for approximately 2 seconds. While the station you are presetting is being registered in memory, the sound is momentarily muted.

The number of the pressed preset station button appears next to the frequency indication.

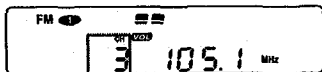

Preset number

Repeat these procedures to preset up to 6 stations each for FM1, FM2, FM3, AM1, and AM2.

- You can manually preset stations that have not been selected by auto memory.
- If you try to preset a station on a preset station button on which another station of the same band has already been preset, the previously preset station will be erased.

To tune in the preset stations

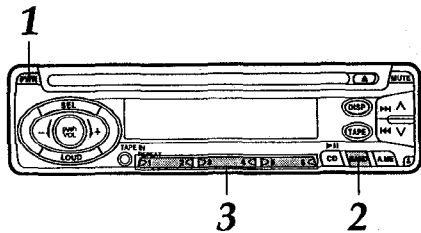

- 1 Press PWR to turn the unit on.
- 2 Press BAND to select a desired band from among FM1, FM2, FM3, AM1, and AM2.
- 3 Press the desired preset station button. The number of the pressed preset station button appears next to the frequency indication.

Active tuning reception control (ATRC)

This unit automatically suppresses FM noise caused by varying signal strength resulting from movement of the car.

- The built-in automatic blending circuit mixes the left and right channel signals according to the strength of the reception. At the same time, the high-cut circuit activates to maintain the sound quality.
- If the reception becomes even weaker, the unit automatically switches to Monaural mode to reduce noise.

CD PLAY

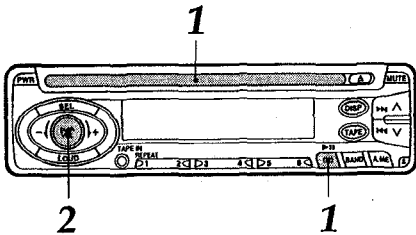

- 1 Insert a disc with the labeled side upward to start CD play.**
If a disc is already inserted, press PWR to start CD play.

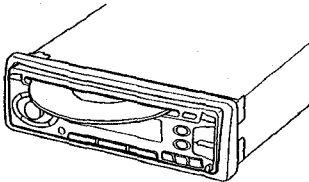

The track number and elapsed playing time appear.

CD indicator



Track number

Elapsed playing time

- 2 Press VOL to project out the control and turn it to + or - to adjust the volume.**

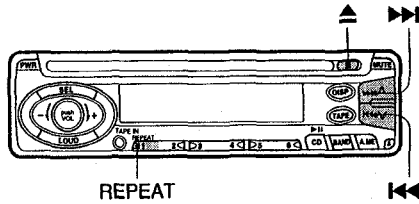

Press these buttons to operate CD play.

Press	To
▲	Eject a disc.
CD	Pause play. The track number and elapsed playing time flash. To resume play, press CD again.
▶▶	Skip to the next track with a short press (for less than 0.5 seconds). Each extra press skips forward one extra track. To search forward rapidly, press and hold ▶▶ down until the desired part is played, then release it.
◀◀	Restart the track currently in play with a short press (for less than 0.5 seconds). Each extra press skips backward one extra track. To search backward rapidly, press and hold ◀◀ down until the desired part is played, then release it.

Note

- The ▲ button is active only in CD mode.
- Smaller 3-inch (8 cm) CDs can not be played on this unit. And do not use an adaptor as it may cause malfunctioning.
- The CD play starts from the first track on the disc.

continued

ENGLISH 8

CD PLAY

Repeat Play

Press REPEAT during CD play.
The "REPEAT" indicator lights up and the currently selected track is played repeatedly.

Press REPEAT again to deactivate Repeat play.

Note

If Repeat play is not activated, all the tracks on the disc are played repeatedly.

SOUND ADJUSTMENTS

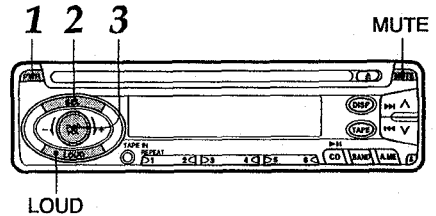

- 1 Press PWR to turn the unit on.
- 2 Press SEL to select the mode that you wish to adjust from: VOL (volume), BAS (bass), TRE (treble), BAL (balance), FAD (fader).

The following indications appear in cyclic order.



The selected mode switches to Volume mode if you do not proceed with step 2 within 9 seconds.

- 3 Press VOL to project out the control and turn it to + or - to adjust the level. Turn and hold the control to change the level rapidly.

Adjust each mode referring to the audio control indications in the display window.

	-	+
VOL	Decreases the volume level	Increases the volume level
BAS	Decreases the bass level	Increases the bass level
TRE	Decreases the treble level	Increases the treble level
BAL	Decreases the level of the right speaker(s)	Decreases the level of the left speaker(s)
FAD	Decreases the level of the front speakers	Decreases the level of the rear speakers

Without selecting any mode with SEL, only the volume level can be adjusted by turning VOL.

Note

Make sure to press VOL to hide the control when you finish sound adjustment.

MUTE button

Press this button to temporarily lower the volume. Press it again to restore the previous volume.

Loudness function

Press LOUD to reinforce both bass and treble especially when listening at low volume level.

CONNECTING A PORTABLE CASSETTE PLAYER OR OTHER EQUIPMENT

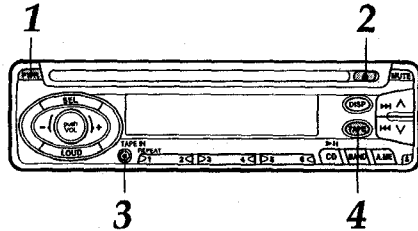

- 1 Press PWR to turn the unit on.**
- 2 If a CD is inserted, remove it to prevent possible damage to the unit.**
- 3 Connect a portable cassette player, etc. via the TAPE IN jack (3.5-mm dia.) on the unit.**
- 4 Press TAPE to listen to the connected equipment.**
The "TAPE" indicator lights up.
The clock display appears.

- For further information on the portable cassette player, etc., refer to the operating instructions for the equipment.

TROUBLESHOOTING

Reset button

The Reset button is visible when you detach the front panel. Try pressing this button if a CD does not operate properly. When you press this button, use the tip of a pointed object such as a pencil or toothpick.

Note that the memory contents, however, will be erased by pressing this button.

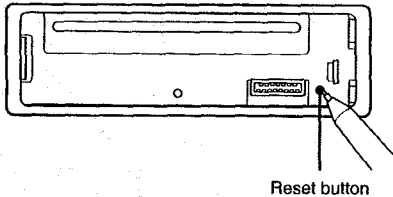

MAINTENANCE

Cleaning the front panel

When the front panel is soiled, wipe the surface of the panel with a dry and soft cloth.

Cleaning the connector

The connector on the reverse side of the front panel needs to be cleaned occasionally. Wipe the surface of the connector with a cotton swab slightly moistened with alcohol.

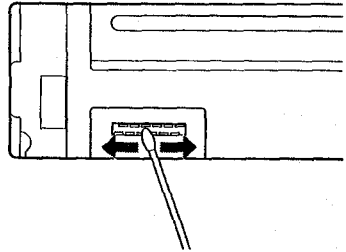

SPECIFICATIONS

RADIO SECTION

(FM)

Frequency Range: 87.5 MHz–108 MHz
(100-kHz steps)
87.5 MHz–108 MHz
(50-kHz steps)

Usable Sensitivity: 12.7 dBf

50 dB Quieting Sensitivity:
17.2 dBf

IF Rejection: 80 dB

Frequency Response: 30 Hz–15,000 Hz

S/N Ratio: 63 dB

Stereo Separation: 35 dB at 1 kHz

Alternate Channel Selectivity:
70 dB

Capture Ratio: 3 dB

(AM)

Frequency Range: 520 kHz–1,710 kHz
(10-kHz steps)
522 kHz–1,620 kHz
(9-kHz steps)

Usable Sensitivity: 30 μ V (30 dB)

CD SECTION

Frequency Response: 17 Hz–20 kHz +0/-3 dB

Dynamic Range: More than 80 dB

Channel Separation: More than 65 dB

S/N Ratio: More than 85 dB

Wow/Flutter: Unmeasurable

AUDIO SECTION

Max. Power Output: 40 W \times 4 channels

TAPE IN input

Input sensitivity (load impedance)
TAPE IN: 500 mV (10 k Ω)

GENERAL

Power-Supply Voltage:
14.4 V (11 to 16 V allowable),
DC, negative ground

Load Impedance: 4 Ω

Tone Control:
Bass \pm 10 dB at 100 Hz
Treble \pm 10 dB at 10 kHz

Preamp Output Voltage (load impedance):
2.2 V (10 k Ω)

Installation size: 182 (W) \times 53 (H) \times 155 (D) mm
(7 $\frac{1}{4}$ (W) \times 2 $\frac{1}{8}$ (H) \times
6 $\frac{1}{8}$ (D) inches)

Accessory supplied: Carrying case (1)

- Specifications and external appearance are subject to change without notice due to product improvement.

Free Manuals Download Website

<http://myh66.com>

<http://usermanuals.us>

<http://www.somanuals.com>

<http://www.4manuals.cc>

<http://www.manual-lib.com>

<http://www.404manual.com>

<http://www.luxmanual.com>

<http://aubethermostatmanual.com>

Golf course search by state

<http://golfingnear.com>

Email search by domain

<http://emailbydomain.com>

Auto manuals search

<http://auto.somanuals.com>

TV manuals search

<http://tv.somanuals.com>