



# CD/DVD Player

## Operating Instructions

### For customers in the U.S.A

#### Owner's Record

The model and serial numbers are located at the rear of the unit. Record the serial number in the space provided below. Refer to them whenever you call upon your Aiwa dealer regarding this product.

Model No. XD-AX10

Serial No. \_\_\_\_\_

### For assistance and information

visit us on the internet at

**[www.us.aiwa.com](http://www.us.aiwa.com)**

call toll free 1-800-BUY-AIWA

### For Customers in Canada

If this product is not working properly, please call 1-877-869-2492 for **Peace of Mind Warranty Replacement service.**

For other product related questions please contact our **Customer Information Service Centre** at 1-877-869-2492 or write to us at: Customer Information Service 115 Gordon Baker Road, Toronto, Ontario, M2H 3R6



## XD-AX10

© 2003 Sony Corporation

# WARNING

To prevent fire or shock hazard, do not expose the unit to rain or moisture. To avoid electrical shock, do not open the cabinet. Refer servicing to qualified personnel only.

## CAUTION

The use of optical instruments with this product will increase eye hazard. As the laser beam used in this CD/DVD player is harmful to eyes, do not attempt to disassemble the cabinet.

Refer servicing to qualified personnel only.



This symbol is intended to alert the user to the presence of uninsulated "dangerous voltage" within the product's enclosure that may be of sufficient magnitude to constitute a risk of electric shock to persons.



This symbol is intended to alert the user to the presence of important operating and maintenance (servicing) instructions in the literature accompanying the appliance.

## CAUTION:

TO PREVENT ELECTRIC SHOCK, MATCH WIDE BLADE OF PLUG TO WIDE SLOT, FULLY INSERT.

## CAUTION

You are cautioned that any change or modifications not expressly approved in this manual could void your authority to operate this equipment.

## Note

This equipment has been tested and found to comply with the limits for a Class B digital device, pursuant to Part 15 of the FCC Rules. These limits are designed to provide reasonable protection against harmful interference in a residential installation. This equipment generates, uses, and can radiate radio frequency energy and, if not installed and used in accordance with the instructions, may cause harmful interference to radio communications. However, there is no guarantee that interference will not occur in a particular installation. If this equipment does cause harmful interference to radio or television reception, which can be determined by turning the equipment off and on, the user is encouraged to try to correct the interference by one or more of the following measures:

- Reorient or relocate the receiving antenna.
- Increase the separation between the equipment and receiver.
- Connect the equipment into an outlet on a circuit different from that to which the receiver is connected.
- Consult the dealer or an experienced radio/TV technician for help.

# Welcome!

Thank you for purchasing this CD/DVD Player. Before operating this player, please read this manual thoroughly and retain it for future reference.

# Precautions

- The power requirements and power consumption of this player are indicated on the back of the player. Check that the player's operating voltage is identical with your local power supply.

Power requirements →



## On safety

- Caution – The use of optical instruments with this product will increase eye hazard.
- To prevent fire or shock hazard, do not place objects filled with liquids, such as vases, on the apparatus.
- Should any solid object or liquid fall into the cabinet, unplug the player and have it checked by qualified personnel before operating it any further.

## On power sources

- The player is not disconnected from the AC power source as long as it is connected to the wall outlet, even if the player itself has been turned off.
- If you are not going to use the player for a long time, be sure to disconnect the player from the wall outlet. To disconnect the AC power cord, grasp the plug itself; never pull the cord.
- Should the AC power cord need to be changed, have it done at a qualified service shop only.

## On placement

- Place the player in a location with adequate ventilation to prevent heat build-up in the player.
- Do not place the player on a soft surface such as a rug that might block the ventilation holes.
- Do not place the player in a location near heat sources, or in a place subject to direct sunlight, excessive dust, or mechanical shock.

## For the model supplied with the AC plug adaptor

If the AC plug of your unit does not fit into the wall outlet, attach the supplied AC plug adaptor.

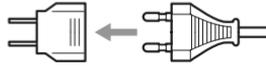

## On operation

- If the player is brought directly from a cold to a warm location, or is placed in a very damp room, moisture may condense on the lenses inside the player. Should this occur, the player may not operate properly. In this case, remove the disc and leave the player turned on for about half an hour until the moisture evaporates.
- When you move the player, take out any discs. If you don't, the disc may be damaged.

## On adjusting volume

Do not turn up the volume while listening to a section with very low level inputs or no audio signals. If you do, the speakers may be damaged when a peak level section is played.

## On cleaning

Clean the cabinet, panel, and controls with a soft cloth slightly moistened with a mild detergent solution. Do not use any type of abrasive pad, scouring powder or solvent such as alcohol or benzine.

## On cleaning discs

Do not use a commercially available cleaning disc. It may cause a malfunction.

### IMPORTANT NOTICE

Caution: This player is capable of holding a still video image or on-screen display image on your television screen indefinitely. If you leave the still video image or on-screen display image displayed on your TV for an extended period of time you risk permanent damage to your television screen. Plasma Display Panel televisions and projection televisions are susceptible to this.

If you have any questions or problems concerning your player, please consult your nearest Aiwa dealer.

# Table of Contents

WARNING . . . . .	2
Welcome! . . . . .	2
Precautions . . . . .	3
About This Manual . . . . .	6
This Player Can Play the Following Discs . . . . .	6
Notes about the Discs . . . . .	8
Index to Parts and Controls . . . . .	9
Guide to On-Screen Displays (Control Bar) . . . . .	13
<hr/>	
<b>Hookups . . . . .</b>	<b>15</b>
Hooking Up the Player . . . . .	15
Step 1: Unpacking . . . . .	15
Step 2: Inserting Batteries into the Remote . . . . .	15
Step 3: Connecting the Video Cords . . . . .	16
Step 4: Connecting the Audio Cords . . . . .	18
Step 5: Connecting the Power Cord . . . . .	23
Step 6: Quick Setup . . . . .	23
<hr/>	
<b>Playing Discs . . . . .</b>	<b>25</b>
Playing Discs . . . . .	25
Resuming Playback from the Point Where You Stopped the Disc (Disc Resume) . . . . .	27
Using the DVD's Menu . . . . .	28
Playing VIDEO CDs with PBC Functions (PBC Playback) . . . . .	29
Playing an MP3 Audio Track . . . . .	30
Various Play Mode Functions (Program Play, Shuffle Play, Repeat Play, A-B Repeat Play) . . . . .	32
<hr/>	
<b>Searching for a Scene . . . . .</b>	<b>36</b>
Searching for a Particular Point on a Disc (Scan, Slow-motion Play, Search, Freeze Frame) . . . . .	36
Searching for a Title/Chapter/Track/Scene, etc. (Search mode) . . . . .	37
<hr/>	
<b>Viewing Information About the Disc . . . . .</b>	<b>39</b>
Checking the Playing Time and Remaining Time . . . . .	39
<hr/>	
<b>Sound Adjustments . . . . .</b>	<b>41</b>
Changing the Sound . . . . .	41
Virtual Surround Settings . . . . .	42
<hr/>	
<b>Enjoying Movies . . . . .</b>	<b>44</b>
Displaying the Subtitles . . . . .	44
Adjusting the Playback Picture (PICTURE MODE) . . . . .	44
Changing the Angles . . . . .	45

---

<b>Locking Discs</b> .....	<b>46</b>
Limiting Playback by Children (PARENTAL CONTROL).....	46
<hr/>	
<b>Settings and Adjustments</b> .....	<b>49</b>
Using the Setup Display.....	49
Setting the Display or Sound Track Language (LANGUAGE SETUP) .....	50
Settings for the Display (SCREEN SETUP).....	51
Custom Settings (CUSTOM SETUP).....	52
Settings for the Sound (AUDIO SETUP) .....	53
<hr/>	
<b>Additional Information</b> .....	<b>55</b>
Troubleshooting .....	55
Self-diagnosis Function (When letters/numbers appear in the display).....	57
Glossary .....	58
Specifications.....	59
Language Code List.....	60
Index .....	61

## About This Manual

- Instructions in this manual describe the controls on the remote. You can also use the controls on the player if they have the same or similar names as those on the remote.
- The meaning of the icons used in this manual is described below:

Icon	Meaning
	Functions available for DVD VIDEOS and DVD-RWs/ DVD-Rs in video mode or DVD+RWs/DVD+Rs
	Functions available for VIDEO CDs, Super VCDs, or CD-Rs/ CD-RWs in video CD format or Super VCD format
	Functions available for music CDs or CD-Rs/CD-RWs in music CD format
	Functions available for DATA CDs (CD-ROMs/CD-Rs/CD-RWs containing MP3* audio tracks)

\* MP3 (MPEG 1 Audio Layer 3) is a standard format defined by ISO/MPEG which compresses audio data.

## This Player Can Play the Following Discs

Format of discs	
DVD VIDEO	
VIDEO CD	
Music CD	

The “DVD VIDEO” is a trademark.

## Region code

Your player has a region code printed on the back of the unit and only will play DVD VIDEO discs (playback only) labeled with identical region codes. This system is used to protect copyrights.

DVDs labeled  will also play on this player.

If you try to play any other DVD, the message “Playback prohibited by area limitations.” will appear on the TV screen. Depending on the DVD, no region code indication may be labeled even though playing the DVD is prohibited by area restrictions.



— Region code

---

## Example of discs that the player cannot play

The player cannot play the following discs:

- All CD-ROMs (including PHOTO CDs)/ CD-Rs/CD-RWs other than those recorded in the following formats:
    - music CD format
    - video CD format
    - MP3 format that conforms to ISO9660\* Level 1/Level 2, or its extended format, Joliet
  - Data part of CD-Extras
  - DVD-RWs in VR mode
  - DVD-ROMs
  - DVD Audio discs
  - HD layer on Super Audio CDs
  - Super VCDs in PAL format
- \* A logical format of files and folders on CD-ROMs, defined by ISO (International Standard Organization).

Also, the player cannot play the following discs:

- A DVD with a different region code.
- A disc recorded in a color system other than NTSC, such as PAL or SECAM (this player conforms to the NTSC color system).
- A disc that has a non-standard shape (e.g., card, heart).
- A disc with paper or stickers on it.
- A disc that has the adhesive of cellophane tape or a sticker still left on it.

### Notes

#### • Notes about DVD-RWs/DVD-Rs, DVD+RWs/ DVD+Rs or CD-Rs/CD-RWs

Some DVD-RWs/DVD-Rs, DVD+RWs/ DVD+Rs, or CD-Rs/CD-RWs cannot be played on this player due to the recording quality or physical condition of the disc, or the characteristics of the recording device and authoring software.

The disc will not play if it has not been correctly finalized. For more information, see the operating instructions for the recording device. Note that discs created in the Packet Write format cannot be played.

#### • Music discs encoded with copyright protection technologies

This product is designed to playback discs that conform to the Compact Disc (CD) standard. Recently, various music discs encoded with copyright protection technologies are marketed by some record companies. Please be aware that among those discs, there are some that do not conform to the CD standard and may not be playable by this product.

---

## Note on playback operations of DVDs and VIDEO CDs

Some playback operations of DVDs and VIDEO CDs may be intentionally set by software producers. Since this player plays DVDs and VIDEO CDs according to the disc contents the software producers designed, some playback features may not be available. Also, refer to the instructions supplied with the DVDs or VIDEO CDs.

---

## Copyrights

This product incorporates copyright protection technology that is protected by method claims of certain U.S. patents, other intellectual property rights owned by Macrovision Corporation, and other rights owners. Use of this copyright protection technology must be authorized by Macrovision Corporation, and is intended for home and other limited viewing uses only unless otherwise authorized by Macrovision Corporation. Reverse engineering or disassembly is prohibited.

---

## Notes about the Discs

- To keep the disc clean, handle the disc by its edge. Do not touch the surface.



- Do not expose the disc to direct sunlight or heat sources such as hot air ducts, or leave it in a car parked in direct sunlight as the temperature may rise considerably inside the car.
- After playing, store the disc in its case.
- Clean the disc with a cleaning cloth. Wipe the disc from the center out.



- Do not use solvents such as benzine, thinner, commercially available cleaners, or anti-static spray intended for vinyl LPs.

# Index to Parts and Controls

For more information, refer to the pages indicated in parentheses.

## Front panel

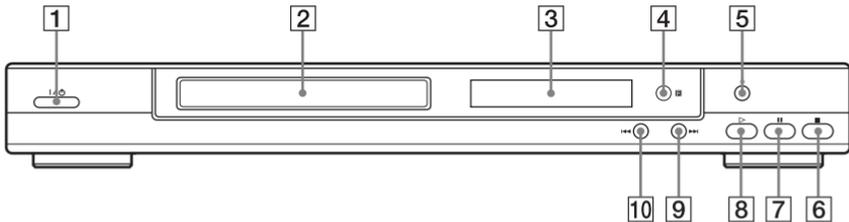

- 1** I/⏻ (on/standby) button (25)
- 2** Disc tray (25)
- 3** Front panel display (10)
- 4** □ (remote sensor) (15)
- 5** ⏻ (open/close) button (25)

- 6** ■ (stop) button (26)
- 7** || (pause) button (26)
- 8** ▷ (play) button (25)
- 9** ►► (next) button (26, 36)
- 10** ◀◀ (previous) button (26, 36)

# Front panel display

## When playing back a DVD

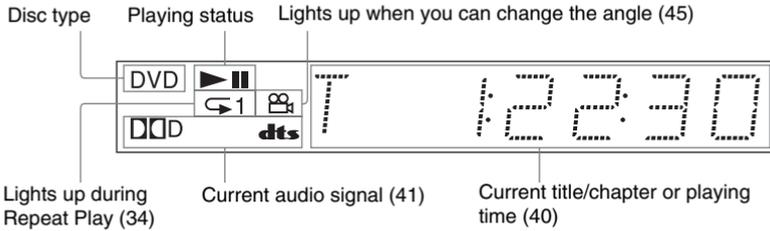

## When playing back a VIDEO CD with Playback Control (PBC) (29)

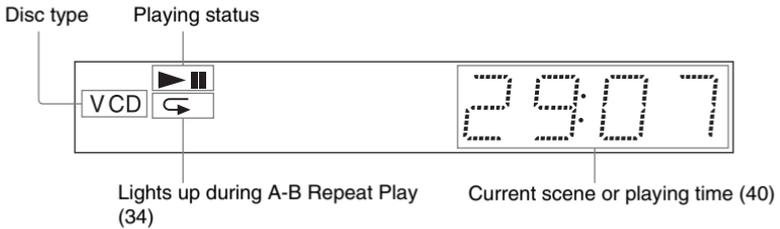

## When playing back a CD, DATA CD (MP3 audio), or VIDEO CD (without PBC)

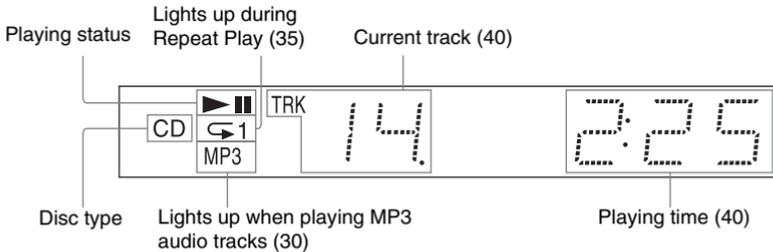

## Rear panel

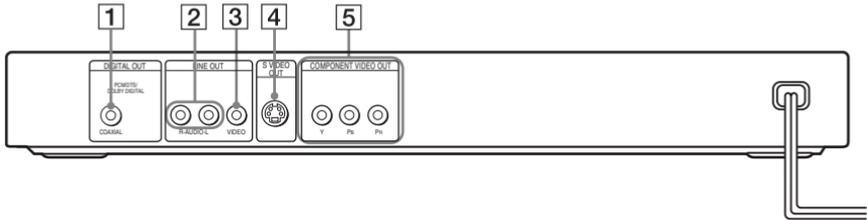

- 1** DIGITAL OUT (COAXIAL) jack (20, 21, 22)
- 2** LINE OUT L/R (AUDIO) jacks (19, 20, 21)
- 3** LINE OUT (VIDEO) jack (16)

- 4** S VIDEO OUT jack (16)
- 5** COMPONENT VIDEO OUT jacks (16)

## Remote

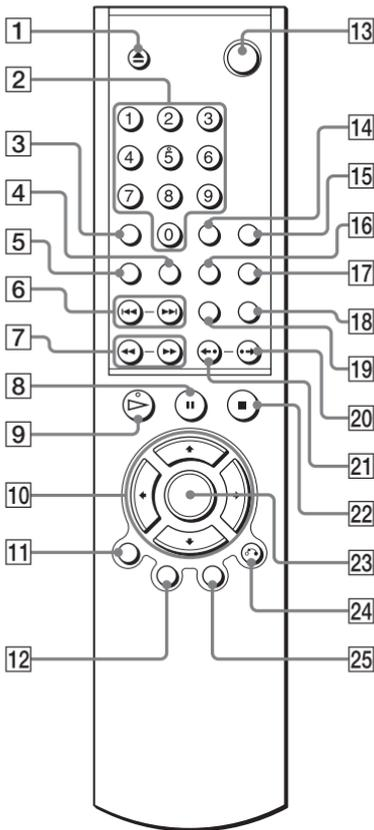

- 1** ▲ OPEN/CLOSE button (26)
- 2** Number buttons (28)  
The number 5 button has a tactile dot.\*
- 3** CLEAR button (32)
- 4** SUBTITLE button (44)
- 5** AUDIO button (41)
- 6** ◀◀/▶▶ PREV/NEXT (previous/next) buttons (26)
- 7** ◀◀◀◀/▶▶▶▶ SCAN/SLOW buttons (36)
- 8** || PAUSE button (26)
- 9** ▷ PLAY button (25)  
The ▷ button has a tactile dot.\*
- 10** ◀/↑/↓/▶ buttons (28)
- 11** DISPLAY button (13)
- 12** TOP MENU button (28)
- 13** I/⏻ (on/standby) button (25)
- 14** TIME/TEXT button (39)
- 15** PICTURE MODE button (44)
- 16** ANGLE button (45)
- 17** SUR (surround) button (42)
- 18** SEARCH MODE button (37)
- 19** REPEAT button (34)
- 20** •→/||▶ INSTANT SEARCH/STEP button (26, 37)
- 21** ◀•/◀|| INSTANT REPLAY/STEP button (26, 37)
- 22** ■ STOP button (26)
- 23** ENTER button (23)
- 24** ⏪ RETURN button (29)
- 25** MENU button (28, 30)

\* Use the tactile dot as a reference when operating the player.

# Guide to On-Screen Displays (Control Bar)

The following explains the Control Bar. The Control Bar is used for making adjustments to the settings or displaying information during playback.

The displayed contents differ according to the type of disc being played. The numbers in parentheses indicate reference pages.

## Displaying the Control Bar during playback

The following displays appear when the DISPLAY button is pressed repeatedly during playback. You can select the setting that suits the current playback item and view the related information.

### ◆Display 1

The following play modes ①~④ can be set. A check mark is indicated when activated. Example: When Repeat Play is selected. (The display will differ when A-B Repeat Play is set.)

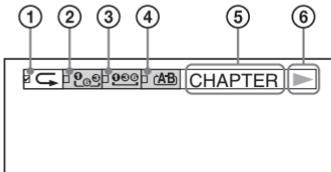

- ① Repeat Play (34)
- ② Shuffle Play (33)
- ③ Program Play (32)
- ④ A-B Repeat Play (35)
- ⑤ Unit being repeated in this example
- ⑥ Playback status (▶ Playback, || Pause, ■ Stop, etc.)



### ◆Display 2

The following playback information is displayed.

Example: When playing a DVD

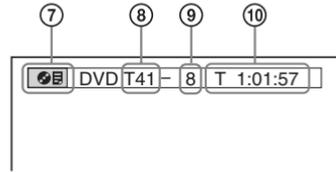

- ⑦ TIME/TEXT icon
- ⑧ Title number of the DVD (37)
- ⑨ Chapter number of the DVD (37)
- ⑩ Playing time or remaining time (39)



### ◆Display 3 (DVD playback only)

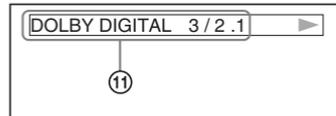

- ⑪ Format of the current audio signal (41)



### ◆No display



### ◆Return to Display 1

## Displaying the Control Bar in stop mode

The following displays appear when the DISPLAY button is repeatedly pressed during stop mode. You can make basic adjustments and customize the player to suit your viewing preferences.

### ◆Display 1

The following settings can be made.

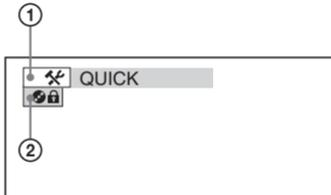

#### ① SETUP (49)

- Select QUICK to make the minimum number of basic adjustments for using the player.
- Select CUSTOM to make a full range of adjustments.
- Select RESET to return the SETUP adjustments to the default settings.

#### ② PARENTAL CONTROL (46)

- Set this to limit the playback of selected discs on this player.



### ◆Display 2

Shows the same information as Display 1 during playback.

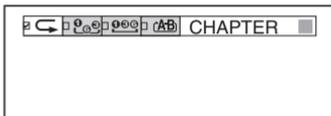

### ◆Display 3

Shows the same information as Display 2 during playback.

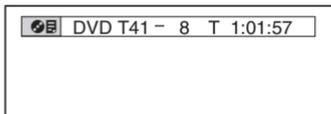

◆No display



◆Return to Display 1

## Hooking Up the Player

Follow Steps 1 to 6 to hook up and adjust the settings of the player.

### Notes

- Plug cords securely to prevent unwanted noise.
- Refer to the instructions supplied with the components to be connected.
- You cannot connect this player to a TV that does not have a video input jack.
- Be sure to disconnect the power of each component before connecting.

## Step 1: Unpacking

Check that you have the following items:

- Audio/video cord (pinplug × 3 ↔ pinplug × 3) (1)
- Remote commander (remote) (1)
- Size AA (R6) batteries (2)
- A plug adaptor is included with some models.

## Step 2: Inserting Batteries into the Remote

You can control the player using the supplied remote. Insert two Size AA (R6) batteries by matching the ⊕ and ⊖ ends on the batteries to the markings inside the compartment. When using the remote, point it at the remote sensor  on the player.

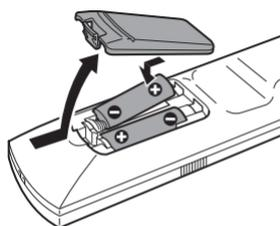

### Notes

- Do not leave the remote in an extremely hot or humid place.
- Do not drop any foreign object into the remote casing, particularly when replacing the batteries.
- Do not expose the remote sensor to direct light from the sun or a lighting apparatus. Doing so may cause a malfunction.
- If you do not use the remote for an extended period of time, remove the batteries to avoid possible damage from battery leakage and corrosion.

## Step 3: Connecting the Video Cords

Connect this player to your TV monitor, projector, or AV amplifier (receiver) using a video cord. Select one of the patterns **A** through **C**, according to the input jack on your TV monitor, projector, or AV amplifier (receiver).

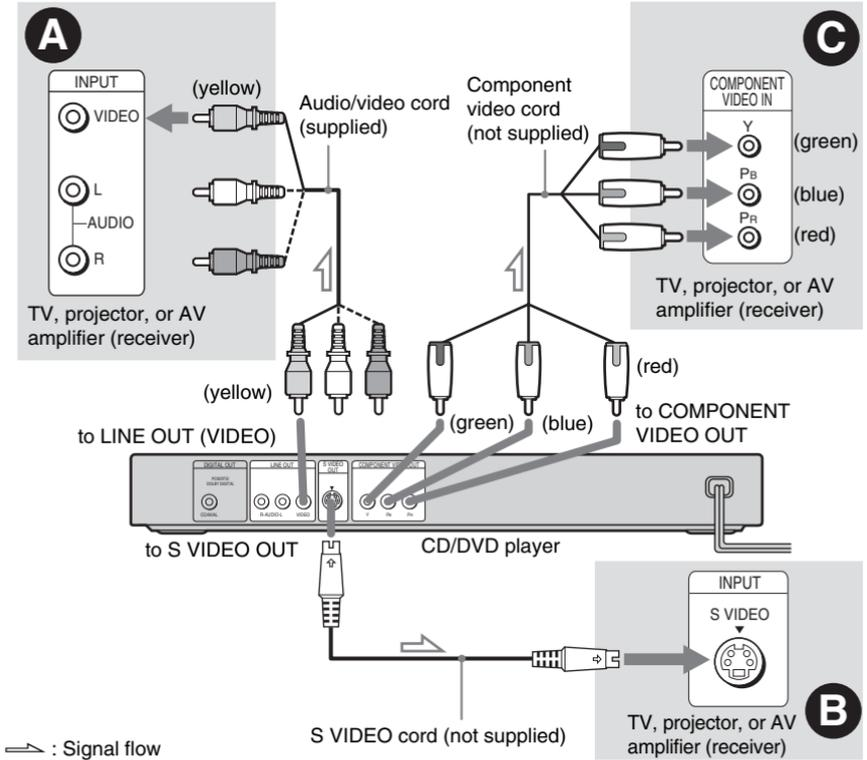

### **A** If you are connecting to a video input jack

Connect the yellow plug of the audio/video cord (supplied) to the yellow (video) jacks. You will enjoy standard quality images.

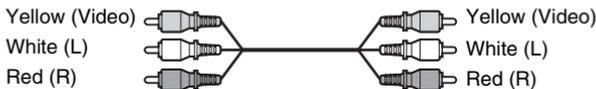

Use the red and white plugs to connect to the audio input jacks (page 19). (Do this if you are connecting to a TV only.)

### **B If you are connecting to an S VIDEO input jack**

Connect the S VIDEO cord (not supplied). You will enjoy high quality images.



### **C If you are connecting to a monitor, projector, or AV amplifier (receiver) having component video input jacks (Y, P<sub>B</sub>, P<sub>R</sub>)**

Connect the component via the COMPONENT VIDEO OUT jacks using a component video cord (not supplied) or three video cords (not supplied) of the same kind and length. You will enjoy accurate color reproduction and high quality images.

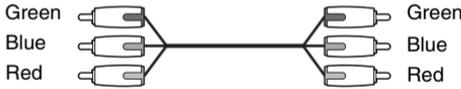

#### **When connecting to a wide screen TV**

Depending on the disc, the image may not fit your TV screen. If you want to change the aspect ratio, please refer to page 51.

#### **Note**

Connect the player directly to the TV. If you pass the player signals via the VCR, you may not receive a clear image on the TV screen.

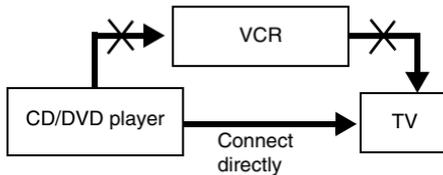

## Step 4: Connecting the Audio Cords

Refer to the chart below to select the connection that best suits your system. Be sure to also read the instructions for the components you wish to connect.

### Select a connection

Select one of the following connections, **A** through **D**.

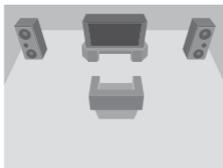
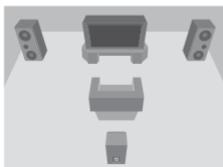
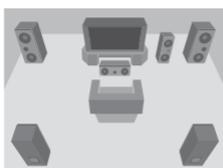
Components to be connected	Connection	Your setup (example)
<b>TV</b> • Surround effects: Virtual Surround WIDE (page 42)	<b>A</b> (page 19)	
<b>Stereo amplifier (receiver) and two speakers</b> or <b>MD deck/DAT deck</b>	<b>B</b> (page 20)	
<b>AV amplifier (receiver) having a Dolby* Surround (Pro Logic) decoder and 3 to 6 speakers</b> • Surround effects: Dolby Surround (Pro Logic) (page 58)	<b>C</b> (page 21)	
<b>AV amplifier (receiver) with digital input jacks having a Dolby Digital or DTS** decoder and 6 speakers</b> • Surround effects: – Dolby Digital (5.1ch) (page 58) – DTS (5.1ch) (page 58)	<b>D</b> (page 22)	

\* Manufactured under license from Dolby Laboratories. "Dolby," "Pro Logic," and the double-D symbol are trademarks of Dolby Laboratories.

\*\* "DTS" and "DTS Digital Out" are trademarks of Digital Theater Systems, Inc.

## A Connecting to your TV

This connection will use your TV speakers for sound.

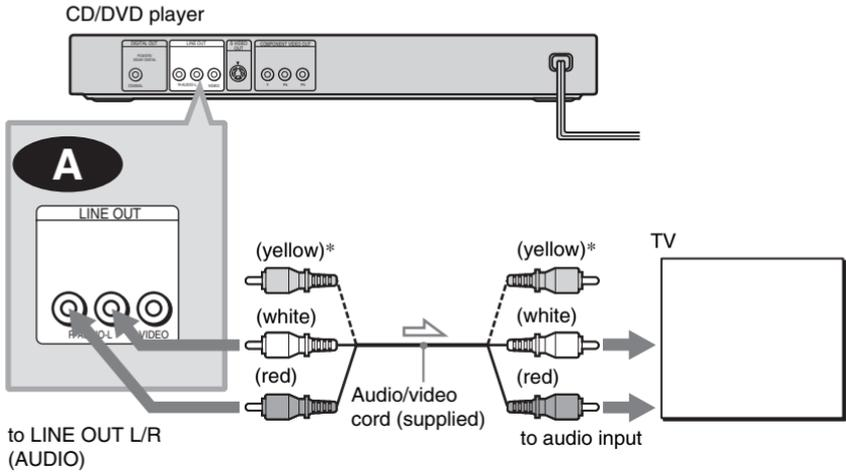

→ : Signal flow

\* The yellow plug is used for video signals (page 16).

### 💡 Hint

When connecting to a monaural TV, use a stereo-mono conversion cord (not supplied). Connect the LINE OUT L/R (AUDIO) jacks to the TV's audio input jack.

## **B** Connecting to a stereo amplifier (receiver) and 2 speakers/Connecting to an MD deck or DAT deck

If the stereo amplifier (receiver) has audio input jacks L and R only, use **B-1**. If the amplifier (receiver) has a digital input jack, or when connecting to an MD deck or DAT deck, use **B-2**. In this case, you can also connect the player directly to the MD deck or DAT deck without using your stereo amplifier (receiver).

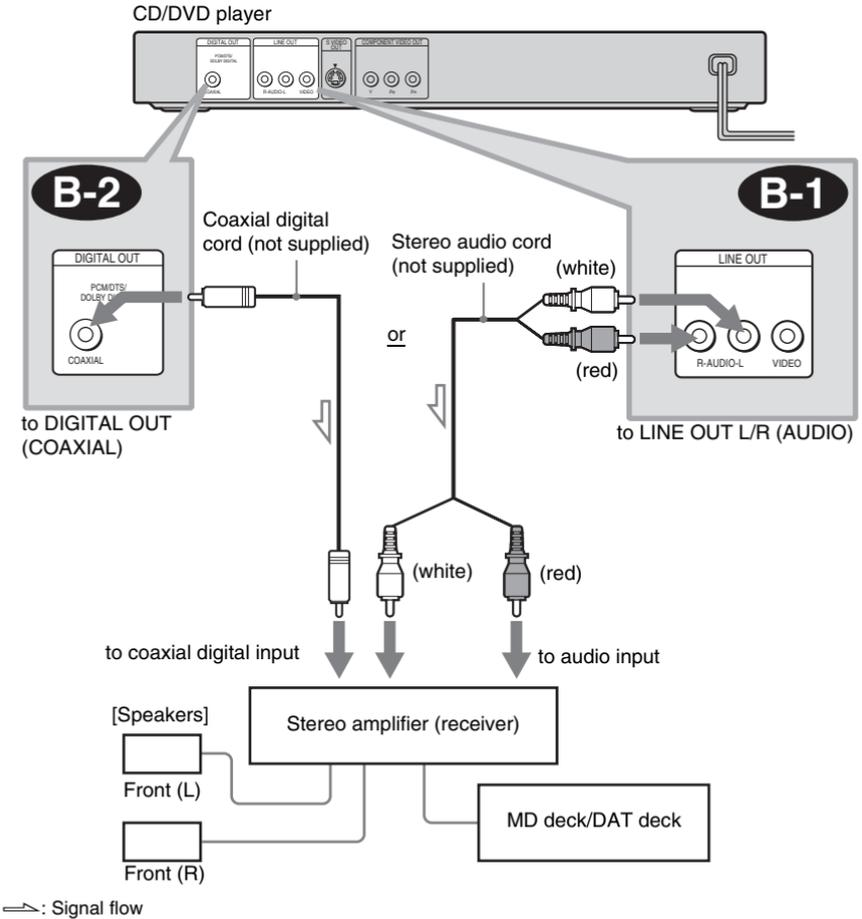

## **C** Connecting to an AV amplifier (receiver) having a Dolby Surround (Pro Logic) decoder and 3 to 6 speakers

You can enjoy the Dolby Surround effects only when playing Dolby Surround audio or multi-channel audio (Dolby Digital) discs.

If your amplifier (receiver) has L and R audio input jacks only, use **C-1**. If your amplifier (receiver) has a digital input jack, use **C-2**.

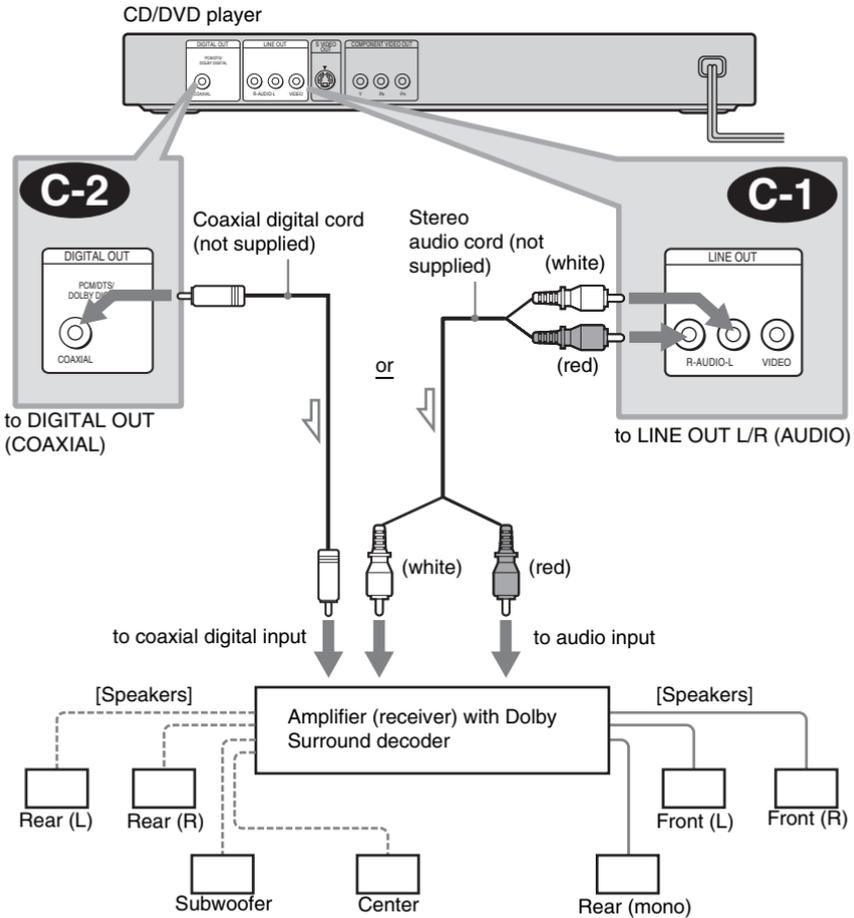

⇒: Signal flow

### Note

When connecting 6 speakers, replace the monaural rear speaker with a center speaker, 2 rear speakers and a subwoofer.

## **D** Connecting to an AV amplifier (receiver) with a digital input jack having a Dolby Digital or DTS decoder and 6 speakers

This connection will allow you to use the Dolby Digital or DTS decoder function of your AV amplifier (receiver).

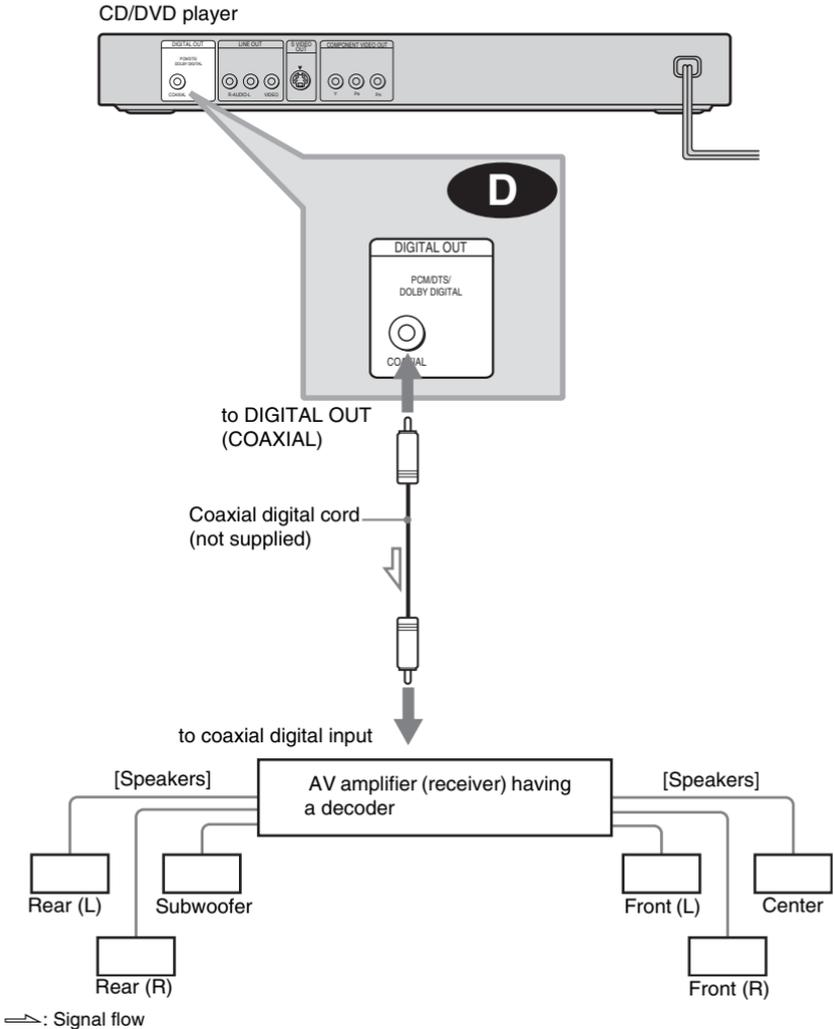

### **Note**

After you have completed the connection, be sure to set "DOLBY DIGITAL" to "DOLBY DIGITAL" and "DTS" to "ON" (page 23) in Quick Setup.

## Step 5: Connecting the Power Cord

Plug the player and TV power cords into an AC outlet.

## Step 6: Quick Setup

Follow the steps below to make the minimum number of basic adjustments for using the player. To skip an adjustment, press **▶▶▶**. To return to the previous adjustment, press **◀◀◀**.

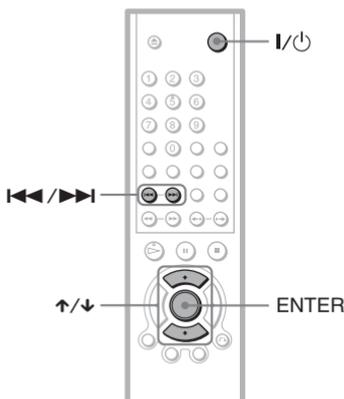

**1** Turn on the TV.

**2** Press I/⏻.

**3** Switch the input selector on your TV so that the signal from the player appears on the TV screen.

“Press [ENTER] to run QUICK SETUP” appears at the bottom of the screen. If this message does not appear, select “QUICK” under “SETUP” in the Control Bar to run Quick Setup (page 50).

**4** Press ENTER without inserting a disc.

The Setup Display for selecting the language used in the on-screen display appears.

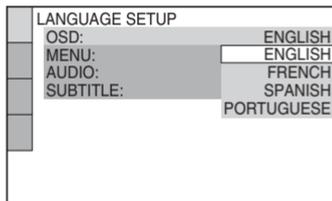

**5** Press **↑/↓** to select a language.

The player uses the language selected here to display the menu and subtitles as well.

**6** Press ENTER.

The Setup Display for selecting the aspect ratio of the TV to be connected appears.

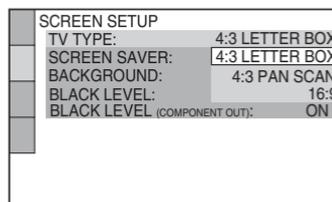

**7** Press **↑/↓** to select the setting that matches your TV type.

- ◆ If you have a 4:3 standard TV
  - 4:3 LETTER BOX or 4:3 PAN SCAN (page 51)
- ◆ If you have a wide-screen TV or a 4:3 standard TV with a wide-screen mode
  - 16:9 (page 51)

**8** Press ENTER.

The Setup Display for selecting the type of jack used to connect your amplifier (receiver) appears.

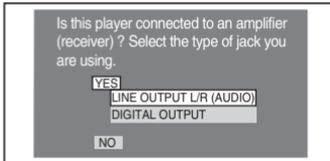

## 9 Press $\uparrow/\downarrow$ to select the type of jack (if any) you are using to connect to an amplifier (receiver), then press ENTER.

Choose the item that matches the audio connection you selected on pages 19 to 22 ( **A** through **D** ).

**A**

- If you connect just a TV and nothing else, select “NO.” Quick Setup is finished and connections are complete.

**B-1 C-1**

- Select “LINE OUTPUT L/R (AUDIO).” Quick Setup is finished and connections are complete.

**B-2 C-2 D**

- Select “DIGITAL OUTPUT.” The Setup Display for “DOLBY DIGITAL” appears.

## 10 Press $\uparrow/\downarrow$ to select the type of Dolby Digital signal you wish to send to your amplifier (receiver).

Choose the signal that matches the audio connection you selected on pages 20 to 22 ( **B** through **D** ).

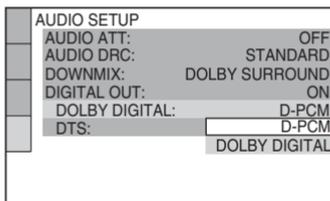

**B-2 C-2**

- D-PCM (page 54)

**D**

- DOLBY DIGITAL (only if the amplifier (receiver) has a Dolby Digital decoder) (page 54)

## 11 Press ENTER.

“DTS” is selected.

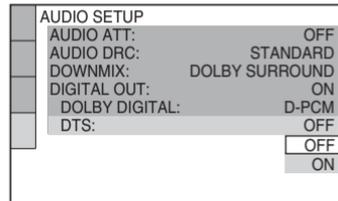

## 12 Press $\uparrow/\downarrow$ to select whether or not you wish to send a DTS signal to your amplifier (receiver).

Choose the item that matches the audio connection you selected on pages 20 to 22 ( **B** through **D** ).

**B-2 C-2**

- OFF (page 54)

**D**

- ON (only if the amplifier (receiver) has a DTS decoder) (page 54)

## 13 Press ENTER.

Quick Setup is finished. All connections and setup operations are complete.

## Enjoying the surround sound effects

To enjoy the surround sound effects of this player or your amplifier (receiver), set the following items as described below for the audio connection you selected on pages 20 to 22 ( **B** through **D** ). Each of these is the default setting and does not need to be adjusted when you first connect the player. Refer to page 49 for using the Setup Display.

### Audio Connection (pages 19 to 22)

**A**

- No additional settings are needed.

**B-1 C-1**

- Set “DOWNMIX” to “DOLBY SURROUND” (page 54)
- If the sound distorts even when the volume is turned down, set “AUDIO ATT” to “ON” (page 53)

**B-2 C-2 D**

- Set “DOWNMIX” to “DOLBY SURROUND” (page 54)
- Set “DIGITAL OUT” to “ON” (page 54)

## Playing Discs

## Playing Discs DVD VCD CD

## DATA CD

Depending on the DVD or VIDEO CD, some operations may be different or restricted. Refer to the operating instructions supplied with your disc.

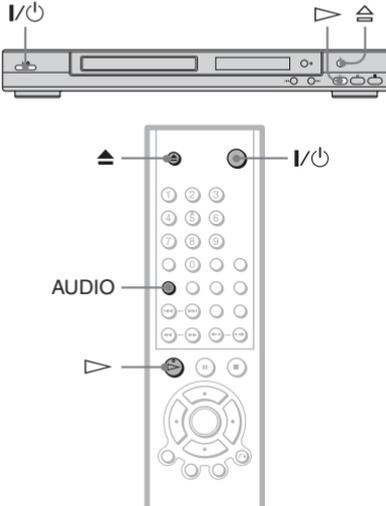

**1 Turn on your TV.**

**2 Press I/O.**

The player turns on.

**3 Switch the input selector on your TV so that the signal from the player appears on the TV screen.**

◆ **When using an amplifier (receiver)**

Turn on the amplifier (receiver) and select the appropriate channel so that you can hear sound from the player.

**4 Press  $\triangle$  on the player, and place a disc on the disc tray.**

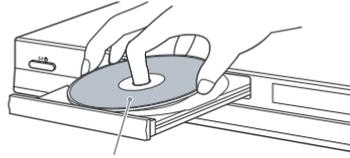

With the playback side facing down

**5 Press  $\triangle$ .**

The disc tray closes, and the player starts playback (continuous play). Adjust the volume on the TV or the amplifier (receiver).

Depending on the disc, a menu may appear on the TV screen. For DVDs, see page 28. For VIDEO CDs, see page 29.

### To turn off the player

Press I/O. The player enters standby mode.

### ⚡ Hint

You can have the player turn off automatically whenever you leave it in stop mode for more than 30 minutes. To turn on this function, set "AUTO POWER OFF" in "CUSTOM SETUP" to "ON" (page 52).

### Notes on playing DTS sound tracks on a CD

- When playing DTS-encoded CDs, excessive noise will be heard from the analog stereo jacks. To avoid possible damage to the audio system, the consumer should take proper precautions when the analog stereo jacks of the player are connected to an amplification system. To enjoy DTS Digital Surround™ playback, an external 5.1-channel decoder system must be connected to the digital jack of the player.
- Set the sound to "STEREO" using the AUDIO button when you play DTS sound tracks on a CD (page 41).

- Do not play DTS sound tracks without first connecting the player to an audio component having a built-in DTS decoder. The player outputs the DTS signal via the DIGITAL OUT (COAXIAL) jack even if “DTS” in “AUDIO SETUP” is set to “OFF” in the Setup Display (page 54), and may affect your ears or cause your speakers to be damaged.

### Notes on playing DVDs with a DTS sound track

- DTS audio signals are output only through the DIGITAL OUT (COAXIAL) jack.
- When you play a DVD with DTS sound tracks, set “DTS” to “ON” in “AUDIO SETUP” (page 54).
- If you connect the player to audio equipment without a DTS decoder, do not set “DTS” to “ON” in “AUDIO SETUP” (page 54). A loud noise may come out from the speakers, affecting your ears or causing the speakers to be damaged.

## Additional operations

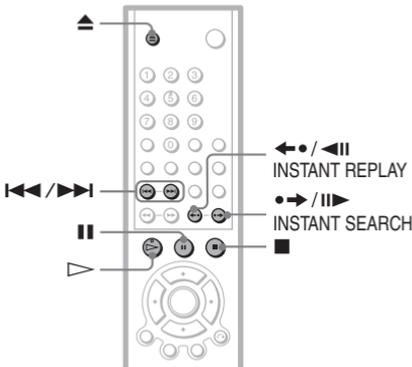

To	Operation
Stop	Press ■
Pause	Press ⏸
Resume play after pause	Press ⏸ or ▶
Go to the next chapter, track, or scene in continuous play mode	Press ▶▶
Go back to the previous chapter, track, or scene in continuous play mode	Press ◀◀

To	Operation
Stop play and remove the disc	Press ▲
Replay the previous scene*	Press ←•/◀ INSTANT REPLAY during playback
Briefly fast forward the current scene**	Press ▶•→/▶▶ INSTANT SEARCH during playback

\* For DVD VIDEOS and DVD-RWs/DVD-Rs only

\*\* For DVD VIDEOS and DVD-RWs/DVD-Rs or DVD+RWs only

### Hints

- The Instant Replay function is useful when you want to review a scene or dialog that you missed.
- The Instant Search function is useful when you want to pass over a scene that you don't want to watch.

### Note

You may not be able to use the Instant Replay or Instant Search function with some scenes.

## Locking the disc tray (Child Lock)

You can lock the disc tray to prevent children from opening it.

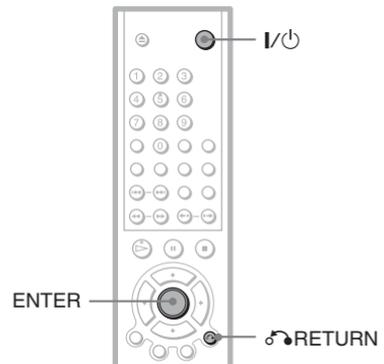

**When the player is in standby mode, press RETURN, ENTER, and I/Power in this order on the remote.**

The player turns on and “LOCKED” appears on the front panel display.

The ▲ button on the player or the remote does not work while the Child Lock is set.

## To unlock the disc tray

When the player is in standby mode, press **RETURN**, **ENTER**, and then **⏻** again.

### Note

Even if you select “RESET” under “SETUP” in the Control Bar (page 50), the disc tray remains locked.

# Resuming Playback from the Point Where You Stopped the Disc (Disc

Resume) **DVD** **VCD**

The player stores the point where you stopped the disc for up to 6 discs and resumes playback the next time you insert the same disc. When you store a resume playback point for the seventh disc, the resume playback point for the first disc is deleted.

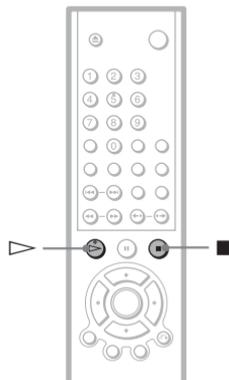

## 1 While playing a disc, press **■** to stop playback.

“RESUME” appears on the front panel display.

## 2 Press **▷**.

The player starts playback from the point where you stopped the disc in Step 1.

### 💡 Hints

- To play from the beginning of the disc, press **■** twice, then press **▷**.
- For CDs, and DATA CDs, the player remembers the resume playback point for the current disc unless the disc tray is opened, the power cord is disconnected, or only for DATA CDs, the player enters standby mode.

## Notes

- “DISC RESUME” in “CUSTOM SETUP” must be set to “ON” (default) for this function to work (page 53).
- The resume playback point for the current disc is cleared when:
  - you change the play mode.
  - you change the settings on the Setup Display.
- This function may not work with some discs.
- Resume Play does not work during Shuffle Play and Program Play.
- If “DISC RESUME” in “CUSTOM SETUP” is set to “ON” and you play a recorded disc such as DVD-RW, the player may play other recorded discs from the same resume point. To play from the beginning, press ■ twice and then press ▷.

## Using the DVD's Menu **DVD**

A DVD is divided into long sections of a picture or a music feature called “titles.” When you play a DVD which contains several titles, you can select the title you want using the TOP MENU button. When you play DVDs that allow you to select items such as the language for the subtitles and the language for the sound, select these items using the MENU button.

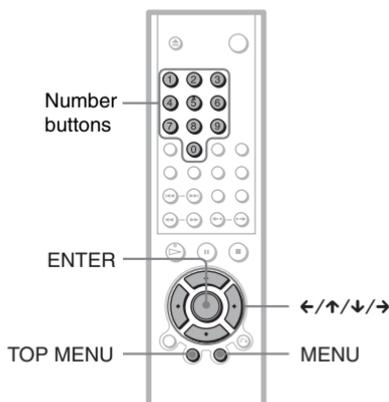

### 1 Press TOP MENU or MENU.

The disc's menu appears on the TV screen.

The contents of the menu vary from disc to disc.

### 2 Press ←/↑/↓/→ or the number buttons to select the item you want to play or change.

If you press the number buttons, the following display appears.

Press the number buttons to select the item you want.

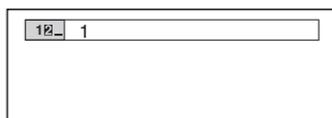

### 3 Press ENTER.

# Playing VIDEO CDs with PBC Functions (PBC Playback)

## VCD

PBC (Playback Control) allows you to play VIDEO CDs interactively by following the menu on the TV screen.

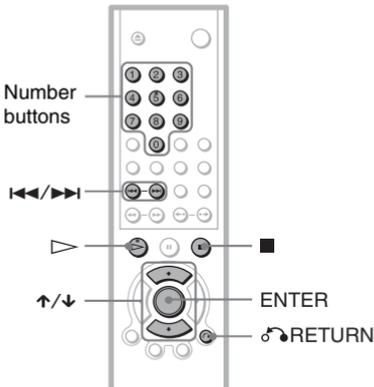

### 1 Start playing a VIDEO CD with PBC functions.

The menu for your selection appears.

### 2 Select the item number you want by pressing $\uparrow/\downarrow$ or the number buttons.

### 3 Press ENTER.

### 4 Follow the instructions in the menu for interactive operations.

Refer to the instructions supplied with the disc, as the operating procedure may differ depending on the VIDEO CD.

#### To return to the menu

Press  $\curvearrowright$  RETURN.

#### Hint

To play without using PBC, press  $\lll/\ggg$  or the number buttons while the player is stopped to select a track, then press  $\triangleright$  or ENTER.

“Play without PBC” appears on the TV screen and the player starts continuous play. You cannot play still pictures such as a menu.

To return to PBC playback, press  $\blacksquare$  twice then press  $\triangleright$ .

#### Notes

- Depending on the VIDEO CD, “Press ENTER” in step 3 may appear as “Press SELECT” in the instructions supplied with the disc. In this case, press  $\triangleright$ .
- The PBC functions of Super VCDs do not work with this player. Super VCDs are played in continuous play mode only.

# Playing an MP3 Audio Track

## DATA CD

You can play back DATA CDs (CD-ROMs/CD-Rs/CD-RWs) recorded in MP3 (MPEG1 Audio Layer 3) format.

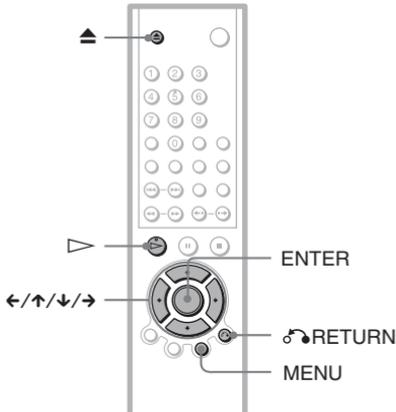

**1** Press and place a DATA CD on the disc tray.

**2** Press .

The disc tray closes, and the player starts to play the first MP3 audio track in the first album on the disc.

### Notes

- This player can play MP3 audio tracks recorded in the following sampling frequencies: 32 kHz, 44.1 kHz, 48 kHz.
- The playback order may be different from the edited order. See “The Playback order of MP3 audio tracks” on the next page for details.

## Selecting an album and track

**1** Press MENU.

The list of MP3 albums recorded on the DATA CD appears.



**2** Select an album using and press ENTER.

The list of tracks contained in the album appears.

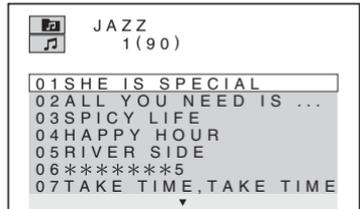

**3** Select a track using and press ENTER.

The selected track starts playing.

When a track or album is being played, its title is shaded.

**To go to the next or previous page**

Press or .

**To return to the previous display**

Press .

**To turn off the display**

Press MENU.

### Notes

- Only the letters in the alphabet and numbers can be used for album or track names. Anything else is displayed as an “ \* ”.
- ID3 tags cannot be displayed.

## About MP3 audio tracks

You can play MP3 audio tracks on CD-ROMs or CD-Rs/CD-RWs. However, the discs must be recorded according to ISO9660 level 1, level 2, or Joliet format for the player to recognize the tracks.

You can also play discs recorded in Multi Session.

See the instructions of the CD-R/CD-RW device or recording software (not supplied) for details on the recording format.

### To play a Multi Session CD

This player can play Multi Session CDs when an MP3 audio track is located in the first session. Any subsequent MP3 audio tracks, recorded in the later sessions, can also be played back.

When audio tracks and images in music CD format or video CD format are recorded in the first session, only the first session will be played back.

#### Notes

- If you put the extension “.MP3” to data not in MP3 format, the player cannot recognize the data properly and will generate a loud noise which could damage your speaker system.
- The player cannot play audio tracks in MP3PRO format.

### The Playback order of MP3 audio tracks

The playback order of albums and tracks recorded on a DATA CD is as follows.

#### ◆Structure of disc contents

Tree 1   Tree 2   Tree 3   Tree 4   Tree 5

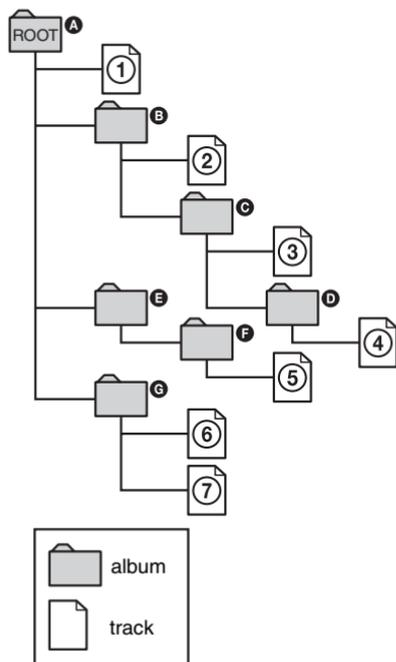

When you insert a DATA CD and press  $\triangleright$ , the numbered tracks are played sequentially, from ① through ⑦. Any sub-albums/tracks contained within a currently selected album take priority over the next album in the same tree. (Example: **C** contains **D** so ④ is played before ⑤.)

When you press MENU and the list of MP3 albums appears (page 30), the albums are arranged in the following order: **A** → **B** → **C** → **D** → **F** → **G**. Albums that do not contain tracks (such as album **E**) do not appear in the list.

#### 💡 Hints

- If you add numbers (01, 02, 03, etc.) to the front of the track file names, the tracks will be played in that order.
- Since a disc with many trees takes longer to start playback, it is recommended that you create albums of no more than two trees.

#### Notes

- Depending on the software you use to create the DATA CD, the playback order may differ from the illustration above.
- The playback order above may not be applicable if there are more than a total of 200 albums and tracks in the DATA CD.
- The player can recognize up to 100 albums (the player will count just albums, including albums that do not contain MP3 audio tracks). The player will not play any albums beyond the first 100 albums. Of the first 100 albums, the player will play no more than a combined total of 200 albums and tracks.

# Various Play Mode Functions (Program Play, Shuffle Play, Repeat Play, A-B Repeat Play)

You can set the following play modes:

- Program Play (page 32)
- Shuffle Play (page 33)
- Repeat Play (page 34)
- A-B Repeat Play (page 35)

## Note

The play mode is canceled when:

- you open the disc tray.
- the player enters standby mode by pressing **I/⏻**.

## Creating your own program (Program Play) **DVD** **VCD** **CD**

You can play the contents of a disc in the order you want by arranging the order of the titles, chapters, or tracks on the disc to create your own program. You can program up to 99 titles, chapters, and tracks.

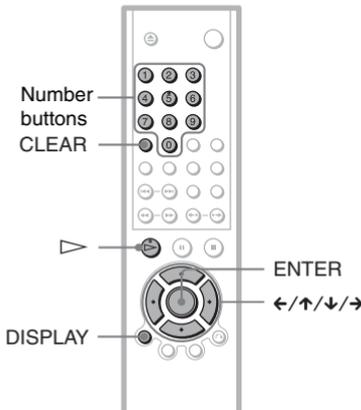

### 1 Press **DISPLAY** twice while the player is in stop mode.

The following Control Bar appears.

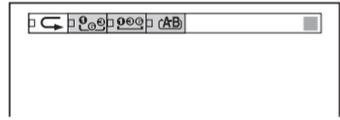

### 2 Press **←/→** to select **PROGRAM**, then press **ENTER**.

"TRACK" is displayed when you play a VIDEO CD or CD.

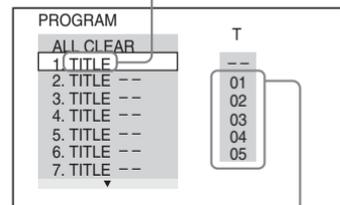

Titles or tracks recorded on a disc

### 3 Press **→**.

The cursor moves to the title or track row "T" (in this case, "01").

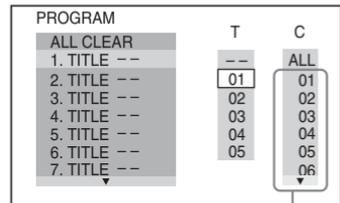

Chapters recorded on a disc

### 4 Select the title, chapter, or track you want to program.

#### ◆ When playing a DVD

For example, select chapter "03" of title "02."

Press **↑/↓** or the number buttons to select "02" under "T," then press **ENTER**.

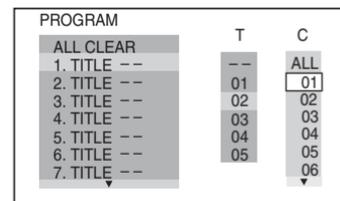

Next, press  $\uparrow/\downarrow$  or the number buttons to select "03" under "C," then press ENTER.

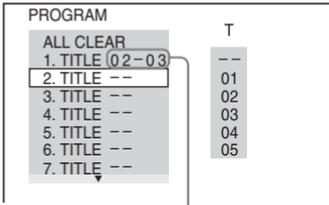

Selected title and chapter

◆ **When playing a VIDEO CD or CD**

For example, select track "02."  
Press  $\uparrow/\downarrow$  or the number buttons to select "02" under "T," then press ENTER.

Selected track

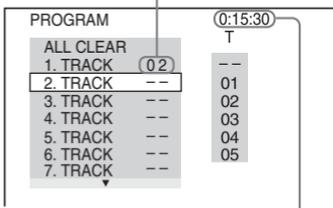

Total time of the programmed tracks

**5 To program other titles, chapters, or tracks, repeat Steps 3 to 4.**

The programmed titles, chapters, and tracks are displayed in the selected order.

**6 Press  $\triangleright$  to start Program Play.**

Program Play begins.  
When the program ends, you can restart the same program again by pressing  $\triangleright$ .

**To stop Program Play**

Press CLEAR.

**To turn off the display**

Press DISPLAY repeatedly until the display is turned off.

**To change or cancel a program**

- Follow Steps 1 and 2 of "Creating your own program (Program Play)."
- Select the program number of the title, chapter, or track you want to change or cancel using  $\uparrow/\downarrow$  or the number buttons, and press  $\rightarrow$ .

- Follow Step 4 for new programming. To cancel a program, select "--" under "T," then press ENTER.

**To cancel all the titles, chapters, or tracks in the programmed order**

- Follow Steps 1 and 2 of "Creating your own program (Program Play)."
- Press  $\uparrow$  and select "ALL CLEAR."
- Press ENTER.

**Hint**

You can do Repeat Play or Shuffle Play of the programmed titles, chapters, or tracks. During Program Play, follow the steps of "Repeat Play" (page 34) or "Shuffle Play" (page 33).

**Notes**

- When playing Super VCDs, the total time of the programmed tracks does not appear on the screen.
- You cannot use this function with VIDEO CDs with PBC playback.

**Playing in random order (Shuffle Play)** DVD VCD CD

You can have the player "shuffle" titles, chapters, or tracks. Subsequent "shuffling" may produce a different playing order.

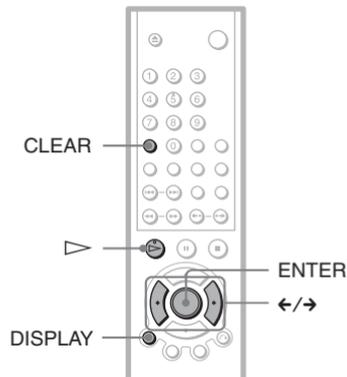

- Press DISPLAY during playback.**  
The following Control Bar appears.

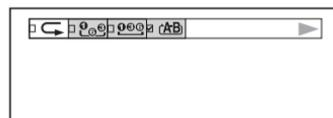

- 2** Press  $\leftarrow/\rightarrow$  to select  (SHUFFLE), then press ENTER repeatedly to select the item to be shuffled.



- ◆ **When playing a DVD**
  - TITLE
  - CHAPTER
- ◆ **When playing a VIDEO CD or CD**
  - TRACK
- ◆ **When Program Play is activated**
  - ON: shuffles titles, chapters, or tracks selected in Program Play.

### To return to normal play

Press CLEAR, or select "OFF" in Step 2.

### To turn off the Control Bar

Press DISPLAY repeatedly until the Control Bar is turned off.

### Hints

- You can set Shuffle Play while the player is stopped. After selecting the "SHUFFLE" option, press  $\triangleright$ . Shuffle Play starts.
- Up to 200 chapters in a disc can be played in random order when "CHAPTER" is selected.

### Note

You cannot use this function with VIDEO CDs with PBC playback.

## Playing repeatedly (Repeat Play)

**DVD** **VCD** **CD** **DATA CD**

You can play all of the titles or tracks on a disc or a single title, chapter, or track repeatedly.

You can use a combination of Shuffle or Program Play modes.

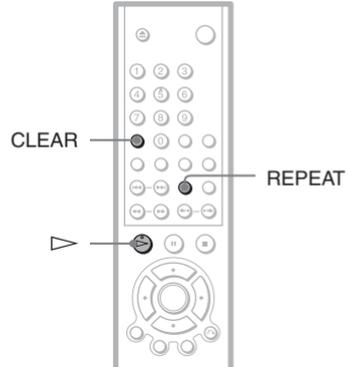

- 1** Press REPEAT during playback.

The following display appears.

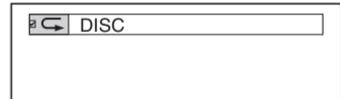

- 2** Press REPEAT repeatedly to select the item to be repeated.

- ◆ **When playing a DVD**
  - DISC: repeats all of the titles.
  - TITLE: repeats the current title on a disc.
  - CHAPTER: repeats the current chapter.
- ◆ **When playing a VIDEO CD or CD**
  - DISC: repeats all of the tracks.
  - TRACK: repeats the current track.
- ◆ **When playing a DATA CD (MP3 audio)**
  - DISC: repeats all of the albums.
  - ALBUM: repeats the current album.
  - TRACK: repeats the current track.
- ◆ **When Program Play or Shuffle Play is activated**
  - ON: repeats Program Play or Shuffle Play.

### To return to normal play

Press CLEAR, or select "OFF" in Step 2.

#### Hints

- You can set Repeat Play while the player is stopped. After selecting the "REPEAT" option, press . Repeat Play starts.
- You can also select "REPEAT" from the Control Bar (page 13).

#### Note

You cannot use this function with VIDEO CDs with PBC playback.

### Repeating a specific portion (A-B Repeat Play)

You can play a specific portion of a title, chapter or track repeatedly. (This function is useful when you want to memorize lyrics, etc.)

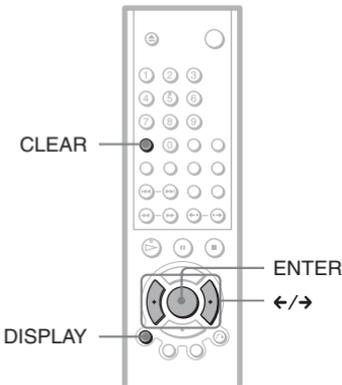

### 1 Press DISPLAY during playback.

The following Control Bar appears.

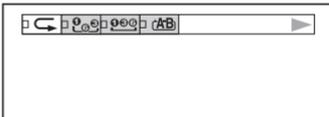

### 2 Press <-/> to select (A-B REPEAT).

### 3 During playback, when you find the starting point (point A) of the portion to be played repeatedly, press ENTER.

The starting point (point A) is set.

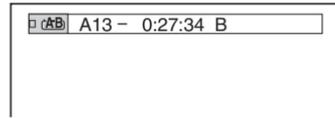

### 4 When you reach the ending point (point B), press ENTER again.

The set points are displayed and the player starts repeating this specific portion.

### To return to normal play

Press CLEAR.

### To turn off the Control Bar

Press DISPLAY repeatedly until the Control Bar is turned off.

#### Note

When you set A-B Repeat Play, the settings for Shuffle Play, Repeat Play, and Program Play are canceled.

## Searching for a Scene

# Searching for a Particular Point on a Disc (Scan, Slow-motion Play, Search, Freeze Frame)

You can quickly locate a particular point on a disc by monitoring the picture or playing back slowly.

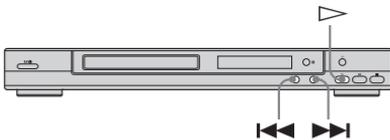
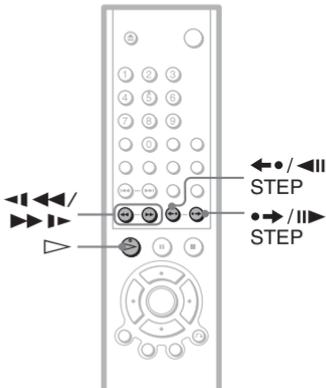

### Note

Depending on the DVD/VIDEO CD, you may not be able to do some of the operations described.

## Locating a point quickly by playing a disc in fast forward or fast reverse (Scan)

DATA CD

Press  $\lll$  or  $\ggg$  while playing a disc. When you find the point you want, press  $\triangleright$  to return to normal speed. Each time you press  $\lll$  or  $\ggg$  during scan, the playback speed changes. With each press the indication changes as follows:

### Playback direction



### Opposite direction

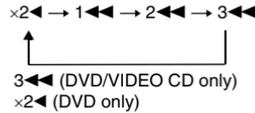

The " $\times 2$ " / " $\times 2 \leftarrow$ " playback speed is about twice the normal speed.

The " $3$ " / " $3 \leftarrow$ " playback speed is faster than " $2$ " / " $2 \leftarrow$ " and the " $2$ " / " $2 \leftarrow$ " playback speed is faster than " $1$ " / " $1 \leftarrow$ ".

## Watching frame by frame (Slow-motion play)

DVD VCD

Press  $\lll$  or  $\ggg$  when the player is in pause mode. To return to the normal speed, press  $\triangleright$ .

Each time you press  $\lll$  or  $\ggg$  during Slow-motion play, the playback speed changes. Two speeds are available. With each press the indication changes as follows:

### Playback direction



### Opposite direction (DVD only)



The " $2$ " / " $2 \leftarrow$ " playback speed is slower than " $1$ " / " $1 \leftarrow$ ".

## To locate a point quickly using the PREV (previous)/NEXT button (Search)

DVD VCD CD DATA CD

You can search for a particular point on a disc using  $\lll$  /  $\ggg$  on the player.

During playback, press and hold  $\ggg$  on the player to locate a point in the playback direction, or press and hold  $\lll$  to locate a point in the opposite direction. When you find the point you want, release the button to return to normal playback speed.

## Playing one frame at a time (Freeze Frame) **DVD VCD**

When the player is in the pause mode, press **STEP** to go to the next frame. Press **STEP** to go to the preceding frame (DVD only). If you hold the button down, you can view the frames in succession. To return to normal playback, press **▷**.

## Searching for a Title/Chapter/Track/Scene, etc. (Search mode) **DVD VCD CD**

### **DATA CD**

You can search a DVD by title or chapter, and you can search a VIDEO CD/CD by track, index, or scene. As titles and tracks are assigned unique numbers on the disc, you can select the desired one by entering its number. Or, you can search for a scene using the time code.

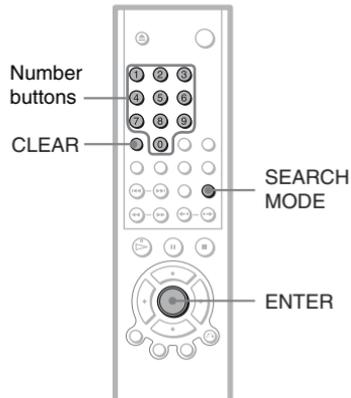

### **1 Press SEARCH MODE.**

The following display appears.

“-- (\*\*)” appears next to the icon (\*\* refers to a number).

The number in parentheses indicates the total number of titles, tracks, indexes, scenes, etc. of the disc.

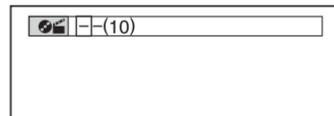

## 2 Press SEARCH MODE repeatedly to select the search method.

### ◆ When playing a DVD

-  TITLE
-  CHAPTER
-  TIME/TEXT
-  NUMBER INPUT

Select “TIME/TEXT” to search for a starting point by inputting the time code.

### ◆ When playing a VIDEO CD without PBC playback

-  TRACK
-  INDEX

### ◆ When playing a VIDEO CD with PBC Playback

-  SCENE
-  INDEX

### ◆ When playing a CD

-  TRACK
-  INDEX

### ◆ When playing a DATA CD (MP3 audio)

-  ALBUM
-  TRACK

## 3 Select the number of the title, track, scene, time code, etc. you want by pressing the number buttons to select the digit.

For example, to find the scene at 2 hours, 10 minutes, and 20 seconds after the beginning, select “TIME/TEXT” in Step 2 and enter “2:10:20.”

### If you make a mistake

Cancel the number by pressing CLEAR, then select another number.

## 4 Press ENTER.

The player starts playback from the selected number.

### Notes

- You cannot search for a scene on a DVD+RW using the time code.
- The title, chapter, or track number displayed is the same number recorded on the disc.

### Hint

When the display is turned off, you can search for a chapter (DVD) or track (CD) by pressing the number buttons and ENTER.

## Viewing Information About the Disc

# Checking the Playing Time and Remaining Time

**DVD VCD CD DATA CD**

You can check the playing time and remaining time of the current title, chapter, or track. Also, you can check the DVD/CD text or track name (MP3 audio) recorded on the disc.

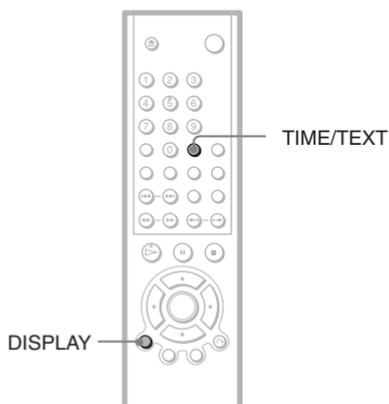

## 1 Press TIME/TEXT during playback.

The following display appears.

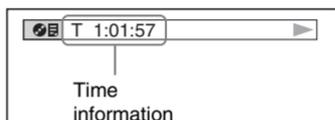

## 2 Press TIME/TEXT repeatedly to change the time information.

The display and the kinds of time that you can change depend on the disc you are playing.

### ◆ When playing a DVD

- T \*:\*: (hours: minutes: seconds)  
Playing time of the current title
- T- \*:\*:  
Remaining time of the current title
- C \*:\*:  
Playing time of the current chapter
- C- \*:\*:  
Remaining time of the current chapter

### ◆ When playing a VIDEO CD (with PBC functions)

- \*:\* (minutes: seconds)  
Playing time of the current scene

### ◆ When playing a VIDEO CD (without PBC functions) or CD

- T \*:\* (minutes: seconds)  
Playing time of the current track
- T- \*:\*  
Remaining time of the current track
- D \*:\*  
Playing time of the current disc
- D- \*:\*  
Remaining time of the current disc

### ◆ When playing a DATA CD (MP3 audio)

- \*:\* (minutes: seconds)  
Playing time of the current track

### ◆ When playing a Super VCD

- T \*:\* (minutes: seconds)  
Playing time of the current track

### To check the DVD/CD text or track name (MP3 audio)

Press TIME/TEXT repeatedly in Step 2 to display text recorded on the DVD/CD/DATA CD.

The DVD/CD text appears only when text is recorded in the disc. You cannot change the text. If the disc does not contain text, "NO TEXT" appears.

For DATA CDs, only the track name of the MP3 audio track appears.

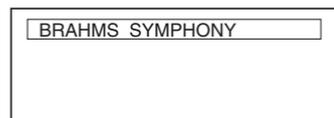

## Checking the information on the front panel display

You can view the time information and text displayed on the TV screen also on the front panel display. The information on the front panel display changes as follows when you change the time information on your TV screen.

### When playing a DVD

Playing time of the current title

T 10324



Remaining time of the current title

T- 11536



Playing time of the current chapter

C 02230



Remaining time of the current chapter

C-0 1320



Text

AIWA HI



Current title and chapter number

T 16 8

(returns to top automatically)

### When playing a DATA CD (MP3 audio)

Playing time and number of the current track

6 2:25



Track name

01HAPPY

### When playing a VIDEO CD (without PBC functions) or CD

Playing time and number of the current track

3 2:25

Remaining time of the current track

3 - 1:50



Playing time of the disc

32:12



Remaining time of the disc

-20:18



Text

AIWA HI



Current track and index number

3 1

(returns to top automatically)

### 💡 Hints

- When playing VIDEO CDs with PBC functions, the scene number or the playing time are displayed.
- Long text that does not fit in a single line will scroll across the front panel display.
- You can also check the time information and text using the Control Bar (page 13).

### Notes

- Depending on the type of disc being played, the DVD/CD text or track name may not be displayed.
- The player can only display the first level of the DVD/CD text, such as the disc name or title.
- Playing time of MP3 audio tracks may not be displayed correctly.

## Sound Adjustments

Changing the Sound **DVD****VCD CD DATA CD**

When playing a DVD recorded in multiple audio formats (PCM, Dolby Digital, or DTS), you can change the audio format. If the DVD is recorded with multilingual tracks, you can also change the language.

With CDs, DATA CDs, or VIDEO CDs, you can select the sound from the right or left channel and listen to the sound of the selected channel through both the right and left speakers. For example, when playing a disc containing a song with the vocals on the right channel and the instruments on the left channel, you can hear the instruments from both speakers by selecting the left channel.

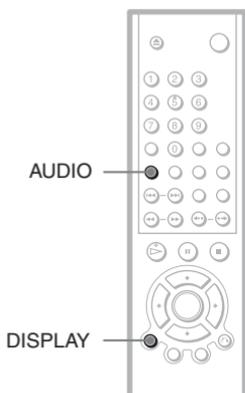

## 1 Press AUDIO during playback.

The following display appears. The number in parentheses indicates the total number of available audio signals.

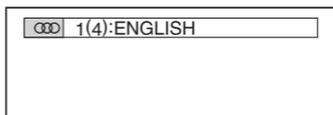

## 2 Press AUDIO repeatedly to select the desired audio signal.

### ◆ When playing a DVD

Depending on the DVD, the choice of language varies.

When 4 digits are displayed, they indicate a language code. Refer to “Language Code List” on page 60 to see which language the code represents. When the same language is displayed two or more times, the DVD is recorded in multiple audio formats.

### ◆ When playing a VIDEO CD, CD, or DATA CD (MP3 audio)

The default setting is underlined.

- STEREO: The standard stereo sound
- 1/L: The sound of the left channel (monaural)
- 2/R: The sound of the right channel (monaural)

### ◆ When playing a Super VCD

The default setting is underlined.

- 1:STEREO: The stereo sound of the audio track 1
- 1:1/L: The sound of the left channel of the audio track 1 (monaural)
- 1:2/R: The sound of the right channel of the audio track 1 (monaural)
- 2:STEREO: The stereo sound of the audio track 2
- 2:1/L: The sound of the left channel of the audio track 2 (monaural)
- 2:2/R: The sound of the right channel of the audio track 2 (monaural)

## Checking the audio signal format **DVD**

If you press DISPLAY repeatedly during playback, the format of the current audio signal (Dolby Digital, DTS, PCM, etc.) appears as shown below.

### Example:

Dolby Digital 5.1 ch

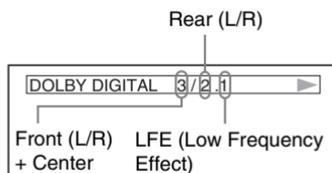

## About audio signals

Audio signals recorded in a disc contain the sound elements (channels) shown below. Each channel is output from a separate speaker.

- Front (L)
- Front (R)
- Center
- Rear (L)
- Rear (R)
- Rear (Monaural): This signal can be either the Dolby Surround Sound processed signals or the Dolby Digital sound's monaural rear audio signals.
- LFE (Low Frequency Effect) signal

### Notes

- If "DTS" is set to "OFF" in "AUDIO SETUP," the DTS track selection option will not appear on the screen even if the disc contains DTS tracks (page 54).
- While playing a Super VCD on which the audio track 2 is not recorded, no sound will come out when you select "2:STEREO," "2:1/L," or "2:2/R."

## Virtual Surround Settings

### DVD

When you connect a stereo TV or 2 front speakers, Virtual Surround lets you enjoy surround sound effects by using sound imaging to create virtual rear speakers from the sound of the front speakers (L: left, R: right) without using actual rear speakers. If the player is set up to output the signal from the DIGITAL OUT (COAXIAL) jack, the surround effect will only be heard when "DOLBY DIGITAL" is set to "D-PCM" (page 54).

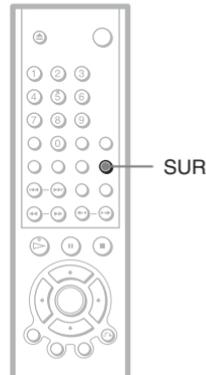

### 1 Press SUR during playback.

The following display appears.

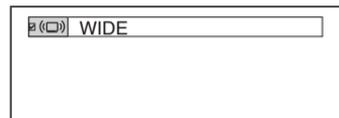

### 2 Press SUR repeatedly to select one of the Virtual Surround sounds.

Refer to the following explanations given for each item.

- WIDE
- NIGHT

## To cancel the setting

Select "OFF" in Step 2.

### ◆WIDE

Creates virtual rear speakers from the sound of the front speakers (L, R) without using actual rear speakers. The virtual speakers are reproduced as shown in the illustration below.

This mode is effective when the distance between the front L and R speakers is short, such as with built-in speakers on a stereo TV.

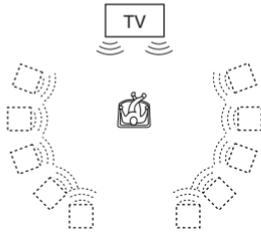

□: Virtual speaker

### ◆NIGHT

Large sounds, such as explosions, are suppressed, but the quieter sounds are unaffected. This feature is useful when you want to hear the dialog and enjoy the surround sound effects of "WIDE" at low volume.

## Notes

- When the playing signal does not contain a signal for the rear speakers, the surround effects will be difficult to hear.
- When you select one of the Virtual Surround modes, turn off the surround setting of the connected TV or amplifier (receiver).
- Make sure that your listening position is between and at an equal distance from your speakers, and that the speakers are located in similar surroundings.
- Not all discs will respond to the "NIGHT" function in the same way.

## Displaying the Subtitles

**DVD**

If subtitles are recorded on the discs, you can change the subtitles or turn them on and off whenever you want while playing a DVD.

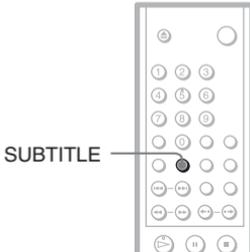

### 1 Press **SUBTITLE** during playback.

The following display appears. The number in parentheses indicates the total number of available subtitles.

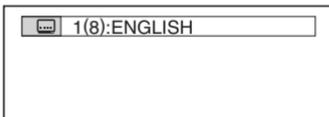

### 2 Press **SUBTITLE** repeatedly to select the language.

Depending on the DVD, the choice of language varies. When 4 digits are displayed, they indicate a language code. Refer to "Language Code List" on page 60 to see which language the code represents.

### To turn off the subtitles

Select "OFF" in Step 2.

#### Note

Depending on the DVD, you may not be able to change the subtitles even if multilingual subtitles are recorded on it. You also may not be able to turn them off.

## Adjusting the Playback Picture (PICTURE MODE) **DVD**

**VCD**

You can adjust the video signal of the DVD or VIDEO CD from the player to obtain the picture quality you want. Choose the setting that best suits the program you are watching.

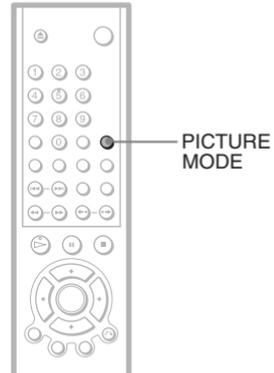

### 1 Press **PICTURE MODE** during playback.

The following display appears.

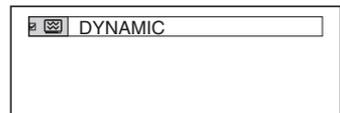

### 2 Press **PICTURE MODE** repeatedly to select the setting you want.

The default setting is underlined.

- STANDARD: displays a standard picture.
- DYNAMIC: produces a bold dynamic picture by increasing the picture contrast and the color intensity.
- CINEMA: enhances details in dark areas by increasing the black level.

#### Hint

When you watch a movie, "CINEMA" is recommended.

## Changing the Angles **DVD**

If various angles (multi-angles) for a scene are recorded on the DVD, “” appears in the front panel display. This means that you can change the viewing angle.

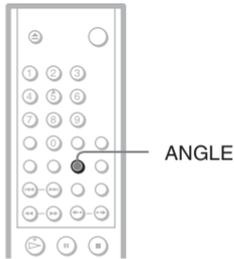

### 1 Press ANGLE during playback.

The number of the angle appears on the display.

The number in parentheses indicates the total number of angles.



### 2 Press ANGLE repeatedly to select the angle number.

The scene changes to the selected angle.

#### Note

Depending on the DVD, you may not be able to change the angles even if multi-angles are recorded on the DVD.

# Limiting Playback by Children (PARENTAL CONTROL)

## DVD

The “PARENTAL CONTROL” function allows you to set a playback limitation level. Playback of some DVDs can be limited according to a predetermined level such as the age of the users. Scenes may be blocked or replaced with different scenes.

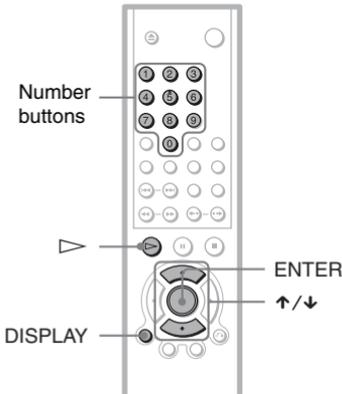

**1 Press DISPLAY while the player is in stop mode.**

The following Control Bar appears.

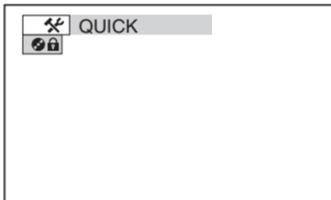

**2 Press ↑/↓ to select  (PARENTAL CONTROL), then press ENTER.**

The options for “PARENTAL CONTROL” appear.

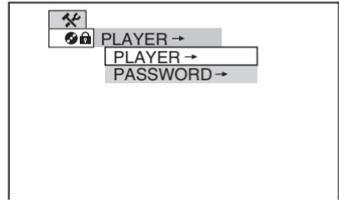

**3 Press ↑/↓ to select “PLAYER →,” then press ENTER.**

◆ **If you have not entered a password**

The display for registering a new password appears.

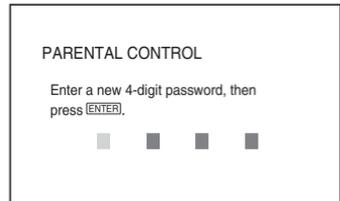

Enter a 4-digit password using the number buttons, then press ENTER. The display for confirming the password appears.

◆ **When you have already registered a password**

The display for entering the password appears.



**4** Enter or re-enter your 4-digit password using the number buttons, then press ENTER.

The display for setting the playback limitation level appears.

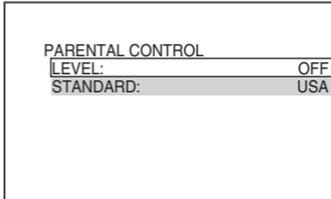

**5** Press  $\uparrow/\downarrow$  to select "STANDARD," then press ENTER.

The selection items for "STANDARD" are displayed.

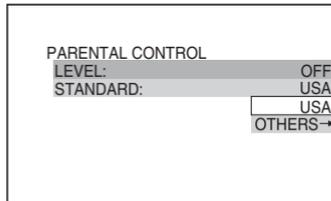

**6** Press  $\uparrow/\downarrow$  to select a geographic area as the playback limitation level, then press ENTER.

The area is selected.

When you select "OTHERS →," select and enter a standard code in the table on page 48 using the number buttons.

**7** Press  $\uparrow/\downarrow$  to select "LEVEL," then press ENTER.

The selection items for "LEVEL" are displayed.

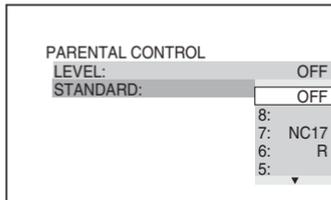

**8** Select the level you want using  $\uparrow/\downarrow$ , then press ENTER.

Parental Control setting is complete.

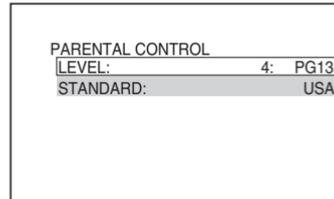

The lower the value, the stricter the limitation.

**To turn off the Parental Control function**  
Set "LEVEL" to "OFF" in Step 8.

**To play a disc for which Parental Control is set**

- 1 Insert the disc and press  $\triangleright$ .  
The display for entering your password appears.
- 2 Enter your 4-digit password using the number buttons, then press ENTER.  
The player starts playback.

**Hint**

If you forget your password, remove the disc and repeat Steps 1 to 3 of "Limiting Playback by Children (PARENTAL CONTROL)." When you are asked to enter your password, enter "199703" using the number buttons, then press ENTER. The display will ask you to enter a new 4-digit password. After you enter a new 4-digit password, replace the disc in the player and press  $\triangleright$ . When the display for entering your password appears, enter your new password.

**Notes**

- When you play discs which do not have the Parental Control function, playback cannot be limited on this player.
- Depending on the disc, you may be asked to change the parental control level while playing the disc. In this case, enter your password, then change the level. If the Resume Play mode is canceled, the level returns to the previous level.

## Area Code

Standard	Code number
Argentina	2044
Australia	2047
Austria	2046
Belgium	2057
Brazil	2070
Canada	2079
Chile	2090
China	2092
Denmark	2115
Finland	2165
France	2174
Germany	2109
India	2248
Indonesia	2238
Italy	2254
Japan	2276

Standard	Code number
Korea	2304
Malaysia	2363
Mexico	2362
Netherlands	2376
New Zealand	2390
Norway	2379
Pakistan	2427
Philippines	2424
Portugal	2436
Russia	2489
Singapore	2501
Spain	2149
Sweden	2499
Switzerland	2086
Thailand	2528
United Kingdom	2184

## If you make a mistake entering your password

Press **←** before you press ENTER and input the correct number.

## If you make a mistake

Press **↶** RETURN.

## To turn off the display

Press DISPLAY repeatedly until the display is turned off.

---

## Changing the password

- 1 Press DISPLAY while the player is in stop mode.**

The Control Bar appears.

- 2 Press **↑/↓** to select  (PARENTAL CONTROL), then press ENTER.**

The options for "PARENTAL CONTROL" appear.

- 3 Press **↑/↓** to select "PASSWORD →," then press ENTER.**

The display for entering the password appears.

- 4 Enter your 4-digit password using the number buttons, then press ENTER.**

- 5 Enter a new 4-digit password using the number buttons, then press ENTER.**

- 6 To confirm your password, re-enter it using the number buttons, then press ENTER.**
-

## Using the Setup Display

By using the Setup Display, you can make various adjustments to items such as picture and sound. You can also set a language for the subtitles and the Setup Display, among other things. For details on each Setup Display item, see pages from 50 to 54.

### Note

Playback settings stored in the disc take priority over the Setup Display settings and not all the functions described may work.

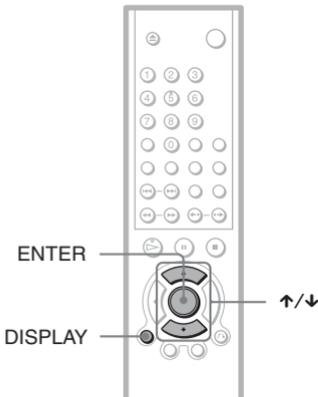

- 1 Press **DISPLAY** when the player is in stop mode.

The Control Bar appears.

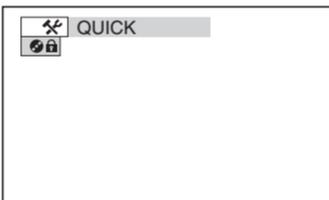

- 2 Press **↑/↓** to select **⚙️ (SETUP)**, then press **ENTER**.

- 3 Press **↑/↓** to select **"CUSTOM,"** then press **ENTER**.

The Setup Display appears.

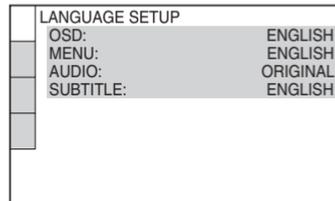

- 4 Press **↑/↓** to select the setup item from the displayed list: **"LANGUAGE SETUP," "SCREEN SETUP," "CUSTOM SETUP,"** or **"AUDIO SETUP."** Then press **ENTER**.

The Setup item is selected.

Example: "SCREEN SETUP"

Selected item

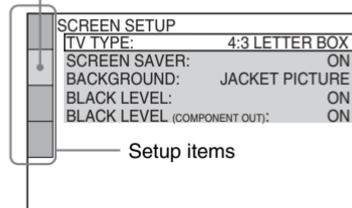

- 5 Select an item using **↑/↓**, then press **ENTER**.

The options for the selected item appear.

Example: "TV TYPE"

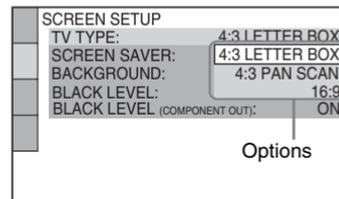

## 6 Select a setting using ↑/↓, then press ENTER.

The setting is selected and setup is complete.

Example: "16:9"

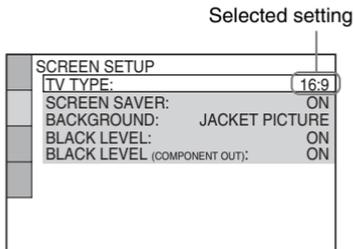

### To turn off the display

Press DISPLAY repeatedly until the display is turned off.

### To enter the Quick Setup mode

Select "QUICK" in Step 3. Follow from Step 5 of the Quick Setup explanation to make basic adjustments (page 23).

### To reset all of the "SETUP" settings

If you select "RESET" in Step 3, you can reset all of the "SETUP" settings on pages 50 to 54 to the default settings. After you select "RESET" and press ENTER, select "YES" and press ENTER to reset the settings (it takes a few seconds to complete), or select "NO" and press ENTER to return to the Control Bar. Do not press I/⏻ when resetting the player.

## Setting the Display or Sound Track Language (LANGUAGE SETUP)

"LANGUAGE SETUP" allows you to set various languages for the on-screen display or sound track.

Select "LANGUAGE SETUP" in the Setup Display. To use the display, see "Using the Setup Display" (page 49).

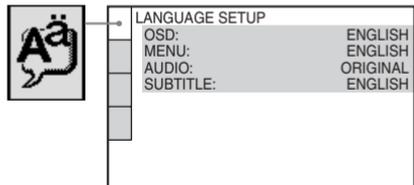

### ◆ OSD (On-Screen Display)

Switches the display language on the screen.

### ◆ MENU (DVD only)

You can select the desired language for the disc's menu.

### ◆ AUDIO (DVD only)

Switches the language of the sound track. When you select "ORIGINAL," the language given priority in the disc is selected.

### ◆ SUBTITLE (DVD only)

Switches the language of the subtitle recorded on the DVD.

When you select "AUDIO FOLLOW," the language for the subtitles changes according to the language you selected for the sound track.

### 💡 Hint

If you select "OTHERS →" in "MENU," "SUBTITLE," or "AUDIO," select and enter a language code from "Language Code List" on page 60 using the number buttons.

### Note

When you select a language in "MENU," "SUBTITLE," or "AUDIO" that is not recorded on the DVD, one of the recorded languages will be automatically selected.

# Settings for the Display

## (SCREEN SETUP)

Choose settings according to the TV to be connected.

Select "SCREEN SETUP" in the Setup Display. To use the display, see "Using the Setup Display" (page 49).  
The default settings are underlined.

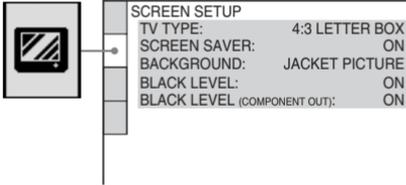

### ◆ TV TYPE

Selects the aspect ratio of the connected TV (4:3 standard or wide).

<u>4:3 LETTER BOX</u>	Select this when you connect a 4:3 screen TV. Displays a wide picture with bands on the upper and lower portions of the screen.
4:3 PAN SCAN	Select this when you connect a 4:3 screen TV. Automatically displays the wide picture on the entire screen and cuts off the portions that do not fit.
16:9	Select this when you connect a wide-screen TV or a TV with a wide mode function.

4:3 LETTER BOX



4:3 PAN SCAN



16:9



### Note

Depending on the DVD, "4:3 LETTER BOX" may be selected automatically instead of "4:3 PAN SCAN" or vice versa.

### ◆ SCREEN SAVER

The screen saver image appears when you leave the player in pause or stop mode for 15 minutes, or when you play back a CD or DATA CD (MP3 audio) for more than 15 minutes. The screen saver will help prevent your display device from becoming damaged (ghosting). Press  $\triangleright$  to turn off the screen saver.

<u>ON</u>	Turns on the screen saver.
OFF	Turns off the screen saver.

### ◆ BACKGROUND

Selects the background color or picture on the TV screen in stop mode or while playing a CD or DATA CD (MP3 audio).

<u>JACKET PICTURE</u>	The jacket picture (still picture) appears, but only when the jacket picture is already recorded on the disc (CD-EXTRA, etc.). If the disc does not contain a jacket picture, the "GRAPHICS" picture appears.
GRAPHICS	A preset picture stored in the player appears.
BLUE	The background color is blue.
BLACK	The background color is black.

### ◆ BLACK LEVEL

Selects the black level (setup level) for the video signals output from the jacks other than COMPONENT VIDEO OUT.

<u>ON</u>	Sets the black level of the output signal to the standard level.
OFF	Lowers the standard black level. Use this when the picture becomes too white.

### ◆ BLACK LEVEL (COMPONENT OUT)

Selects the black level (setup level) for the video signals output from the COMPONENT VIDEO OUT jacks.

<u>ON</u>	Sets the black level of the output signal to the standard level.
OFF	Lowers the standard black level. Use this when the picture becomes too white.

## Custom Settings (CUSTOM SETUP)

Use this to set up playback related and other settings.

Select "CUSTOM SETUP" in the Setup Display. To use the display, see "Using the Setup Display" (page 49).

The default settings are underlined.



<u>CUSTOM SETUP</u>	
<u>AUTO POWER OFF:</u>	<u>OFF</u>
<u>AUTO PLAY:</u>	<u>OFF</u>
<u>DIMMER:</u>	<u>BRIGHT</u>
<u>PAUSE MODE:</u>	<u>AUTO</u>
<u>TRACK SELECTION:</u>	<u>OFF</u>
<u>DISC RESUME:</u>	<u>ON</u>

### ◆ AUTO POWER OFF

Switches the Auto Power Off setting on or off.

<u>OFF</u>	Switches this function off.
ON	The player enters standby mode when left in stop mode for more than 30 minutes.

### ◆ AUTO PLAY

Switches the Auto Play setting on or off. This function is useful when the player is connected to a timer (not supplied).

<u>OFF</u>	Switches this function off.
ON	Automatically starts playback when the player is turned on.

### ◆ DIMMER

Adjusts the lighting of the front panel display.

<u>BRIGHT</u>	Makes the lighting bright.
DARK	Makes the lighting dark.

### ◆ PAUSE MODE (DVD only)

Selects the picture in pause mode.

<u>AUTO</u>	The picture, including subjects that move dynamically, is output with no jitter. Normally select this position.
FRAME	The picture, including subjects that do not move dynamically, is output in high resolution.

### ◆ TRACK SELECTION (DVD only)

Gives the sound track which contains the highest number of channels priority when you play a DVD on which multiple audio formats (PCM, DTS, or Dolby Digital format) are recorded.

<u>OFF</u>	No priority given.
AUTO	Priority given.

### Notes

- When you set the item to "AUTO," the language may change. The "TRACK SELECTION" setting has higher priority than the "AUDIO" settings in "LANGUAGE SETUP" (page 50).
- If you set "DTS" to "OFF" (page 54), the DTS sound track is not played even if you set "TRACK SELECTION" to "AUTO."
- If PCM, DTS, and Dolby Digital sound tracks have the same number of channels, the player selects PCM, DTS, and Dolby Digital sound tracks in this order.

### ◆ DISC RESUME (DVD/VIDEO CD only)

Switches the Disc Resume setting on or off. Resume playback can be stored in memory for up to 6 different DVD/VIDEO CD discs (page 27).

<u>ON</u>	Stores the resume settings in memory for up to six discs (The settings remain in memory even if you select OFF.)
OFF	Does not store the resume settings in memory. Playback restarts at the resume point only for the current disc in the player.

## Settings for the Sound

### (AUDIO SETUP)

"AUDIO SETUP" allows you to set the sound according to the playback and connection conditions.

Select "AUDIO SETUP" in the Setup Display. To use the display, see "Using the Setup Display" (page 49).

The default settings are underlined.

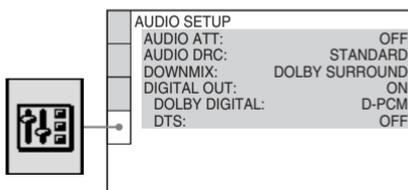

### ◆ AUDIO ATT (attenuation)

If the playback sound is distorted, set this item to "ON." The player reduces the audio output level.

This function affects the output of the LINE OUT L/R (AUDIO) jacks.

<u>OFF</u>	Normally, select this position.
ON	Select this when the playback sound from the speakers is distorted.

### ◆ AUDIO DRC (Dynamic Range Control) (DVD only)

Makes the sound clear when the volume is turned down when playing a DVD that conforms to "AUDIO DRC." This affects the output from the following jacks:

- LINE OUT L/R (AUDIO) jacks
- DIGITAL OUT (COAXIAL) jack only when "DOLBY DIGITAL" is set to "D-PCM" (page 54).

<u>STANDARD</u>	Normally select this position.
TV MODE	Makes the low sounds clear even if you turn the volume down.
WIDE RANGE	Gives you the feeling of being at a live performance.

◆ **DOWNMIX (DVD only)**

Switches the method for mixing down to 2 channels when you play a DVD which has rear sound elements (channels) or is recorded in Dolby Digital format. For details on the rear signal components, see “Checking the audio signal format” (page 41). This function affects the output of the following jacks:

- LINE OUT L/R (AUDIO) jacks
- DIGITAL OUT (COAXIAL) jack when “DOLBY DIGITAL” is set to “D-PCM” (page 54).

<b>DOLBY SURROUND</b>	Normally, select this position. Multi-channel audio signals are output to two channels for enjoying surround sounds.
<b>NORMAL</b>	Multi-channel audio signals are downmixed to two channels for use with your stereo.

◆ **DIGITAL OUT**

Selects if audio signals are output via the DIGITAL OUT (COAXIAL) jack.

<b>ON</b>	Normally select this position. When you select “ON,” see “Setting the digital output signal” for further settings.
<b>OFF</b>	The influence of the digital circuit upon the analog circuit is minimal.

**Setting the digital output signal**

Switches the method of outputting audio signals when you connect a component such as an amplifier (receiver) or MD deck with a digital input jack.

For connection details, see page 18. Select “DOLBY DIGITAL” and “DTS” after setting “DIGITAL OUT” to “ON.”

<b>AUDIO SETUP</b>	
AUDIO ATT:	OFF
AUDIO DRC:	STANDARD
DOWNMIX:	DOLBY SURROUND
DIGITAL OUT:	ON
DOLBY DIGITAL:	D-PCM
DTS:	OFF

If you connect a component that does not conform to the selected audio signal, a loud noise (or no sound) will come out from the speakers, affecting your ears or causing the speakers to be damaged.

◆ **DOLBY DIGITAL (DVD only)**

Selects the type of Dolby Digital signal.

<b>D-PCM</b>	Select this when the player is connected to an audio component without a built-in Dolby Digital decoder. You can select whether the signals conform to Dolby Surround (Pro Logic) or not by making adjustments to the “DOWNMIX” item in “AUDIO SETUP” (page 54).
<b>DOLBY DIGITAL</b>	Select this when the player is connected to an audio component with a built-in Dolby Digital decoder.

◆ **DTS (DVD only)**

Selects whether or not to output DTS signals.

<b>OFF</b>	Select this when the player is connected to an audio component without a built-in DTS decoder.
<b>ON</b>	Select this when the player is connected to an audio component with a built-in DTS decoder.

## Troubleshooting

If you experience any of the following difficulties while using the player, use this troubleshooting guide to help remedy the problem before requesting repairs. Should any problem persist, consult your nearest Aiwa dealer (for customers in the U.S.A only).

### Power

#### The power is not turned on.

- ➔ Check that the AC power cord is connected securely.

### Picture

#### There is no picture/picture noise appears.

- ➔ Re-connect the connecting cord securely.
- ➔ The connecting cords are damaged.
- ➔ Check the connection to your TV (page 16) and switch the input selector on your TV so that the signal from the player appears on the TV screen.
- ➔ The disc is dirty or flawed.
- ➔ If the picture output from your player goes through your VCR to get to your TV or if you are connected to a combination TV/VIDEO player, the copy-protection signal applied to some DVD programs could affect picture quality. If you still experience problems even when you connect your player directly to your TV, please try connecting your player to your TV's S VIDEO input (page 16).

#### Even though you set the aspect ratio in "TV TYPE" of "SCREEN SETUP," the picture does not fill the screen.

- ➔ The aspect ratio of the disc is fixed on your DVD.

### Sound

#### There is no sound.

- ➔ Re-connect the connecting cord securely.
- ➔ The connecting cord is damaged.
- ➔ The player is connected to the wrong input jack on the amplifier (receiver) (page 20, 21, 22).
- ➔ The amplifier (receiver) input is not correctly set.
- ➔ The player is in pause mode or in Slow-motion Play mode.
- ➔ The player is in fast forward or fast reverse mode.
- ➔ If the audio signal does not come through the DIGITAL OUT (COAXIAL) jack, check the audio settings (page 54).
- ➔ While playing a Super VCD on which the audio track 2 is not recorded, no sound will come out when you select "2:STEREO," "2:1/L," or "2:2/R."

#### Sound is noisy.

- ➔ When playing a CD with DTS sound tracks, noise will come from the LINE OUT L/R (AUDIO) jacks (page 25) or DIGITAL OUT (COAXIAL) jack.

#### Sound distortion occurs.

- ➔ Set "AUDIO ATT" in "AUDIO SETUP" to "ON" (page 53).

#### The sound volume is low.

- ➔ The sound volume is low on some DVDs. The sound volume may improve if you set "AUDIO DRC" to "TV MODE" (page 53).
- ➔ Set "AUDIO ATT" in "AUDIO SETUP" to "OFF" (page 53).

### Operation

#### The remote does not function.

- ➔ There are obstacles between the remote and the player.
- ➔ The distance between the remote and the player is too far.
- ➔ The remote is not pointed at the remote sensor on the player.
- ➔ The batteries in the remote are weak.

---

**The disc does not play.**

- ➔ The disc is turned over.  
Insert the disc with the playback side facing down on the disc tray.
- ➔ The disc is skewed.
- ➔ The player cannot play certain discs (page 7).
- ➔ The region code on the DVD does not match the player.
- ➔ Moisture has condensed inside the player (page 3).
- ➔ The player cannot play a recorded disc that is not correctly finalized (page 7).

---

**The MP3 audio track cannot be played (page 30).**

- ➔ The DATA CD is not recorded in the MP3 format that conforms to ISO9660 Level 1/ Level 2 or Joliet.
- ➔ The MP3 audio track does not have the extension “.MP3.”
- ➔ The data is not formatted in MP3 even though it has the extension “.MP3.”
- ➔ The data is not MPEG1 Audio Layer 3 data.
- ➔ The player cannot play audio tracks in MP3PRO format.

---

**The title of the MP3 audio album or track is not correctly displayed.**

- ➔ The player can only display numbers and alphabet. Other characters are displayed as “\*?”.

---

**The disc does not start playing from the beginning.**

- ➔ Program Play, Shuffle Play, Repeat Play, or A-B Repeat Play has been selected (page 32).
- ➔ Resume play has taken effect (page 27).

---

**The player starts playing the disc automatically.**

- ➔ The disc features an auto playback function.
- ➔ “AUTO PLAY” in “CUSTOM SETUP” is set to “ON” (page 52).

---

**Playback stops automatically.**

- ➔ While playing discs with an auto pause signal, the player stops playback at the auto pause signal.

---

**You cannot perform some functions such as Stop, Search, Slow-motion Play, Repeat Play, Shuffle Play, or Program Play.**

- ➔ Depending on the disc, you may not be able to do some of the operations above. See the operating manual that comes with the disc.

---

**The language for the sound track cannot be changed.**

- ➔ Try using the DVD’s menu instead of the direct selection button on the remote (page 28).
- ➔ Multilingual tracks are not recorded on the DVD being played.
- ➔ The DVD prohibits the changing of the language for the sound track.

---

**The subtitle language cannot be changed or turned off.**

- ➔ Try using the DVD’s menu instead of the direct selection button on the remote (page 28).
- ➔ Multilingual subtitles are not recorded on the DVD being played.
- ➔ The DVD prohibits the changing of the subtitles.

---

**The angles cannot be changed.**

- ➔ Try using the DVD’s menu instead of the direct selection button on the remote (page 28).
- ➔ Multi-angles are not recorded on the DVD being played.
- ➔ The angle can only be changed when the “” indicator lights up on the front panel display (page 10).
- ➔ The DVD prohibits changing of the angles.

---

**The player does not operate properly.**

- ➔ When static electricity, etc., causes the player to operate abnormally, unplug the player.

---

**5 numbers or letters are displayed on the screen and on the front panel display.**

- ➔ The self-diagnosis function was activated. (See the table on page 57.)

---

**The disc tray does not open and “LOCKED” appears on the front panel display.**

➔ Child Lock is set (page 26).

---

**The disc tray does not open and “TRAY LOCKED” appears on the front panel display.**

➔ Contact your Aiwa dealer or local authorized Aiwa service facility.

---

**“Data error” appears on the TV screen when playing a DATA CD.**

➔ The MP3 audio track you want to play is broken.

➔ The data is not MPEG 1 Audio Layer 3 data.

---

---

## Self-diagnosis Function

**(When letters/numbers appear in the display)**

When the self-diagnosis function is activated to prevent the player from malfunctioning, a five-character service number (e.g., C 13 50) with a combination of a letter and four digits appears on the screen and the front panel display. In this case, check the following table.



---

<b>First three characters of the service number</b>	<b>Cause and/or corrective action</b>
C 13	The disc is dirty. ➔ Clean the disc with a soft cloth (page 8).
C 31	The disc is not inserted correctly. ➔ Re-insert the disc correctly.
E XX (xx is a number)	To prevent a malfunction, the player has performed the self-diagnosis function. ➔ Contact your nearest Aiwa dealer or local authorized Aiwa service facility and give the 5-character service number. Example: E 61 10

---

---

# Glossary

## Chapter (page 10)

Sections of a picture or a music feature that are smaller than titles. A title is composed of several chapters. Depending on the disc, no chapters may be recorded.

---

## Dolby Digital (page 22, 54)

Digital audio compression technology developed by Dolby Laboratories. This technology conforms to 5.1-channel surround sound. The rear channel is stereo and there is a discrete subwoofer channel in this format. Dolby Digital provides the same 5.1 discrete channels of high quality digital audio found in Dolby Digital cinema audio systems. Good channel separation is realized because all of the channel data are recorded discretely and little deterioration is realized because all channel data processing is digital.

---

## Dolby Surround (Pro Logic) (page 21)

Audio signal processing technology that Dolby Laboratories developed for surround sound. When the input signal contains a surround component, the Pro Logic process outputs the front, center and rear signals. The rear channel is monaural.

---

## DTS (page 22, 54)

Digital audio compression technology that Digital Theater Systems, Inc. developed. This technology conforms to 5.1-channel surround sound. The rear channel is stereo and there is a discrete subwoofer channel in this format. DTS provides the same 5.1 discrete channels of high quality digital audio. Good channel separation is realized because all of the channel data is recorded discretely and little deterioration is realized because all channel data processing is digital.

---

## DVD (page 6)

A disc that contains up to 8 hours of moving pictures even though its diameter is the same as a CD.

The data capacity of a single-layer and single-sided DVD is 4.7 GB (Giga Byte), which is 7 times that of a CD. The data capacity of a double-layer and single-sided DVD is 8.5 GB, a single-layer and double-sided DVD is 9.4 GB, and double-layer and double-sided DVD is 17GB.

---

The picture data uses the MPEG 2 format, one of the worldwide standards of digital compression technology. The picture data is compressed to about 1/40 (average) of its original size. The DVD also uses a variable rate coding technology that changes the data to be allocated according to the status of the picture. Audio information is recorded in a multi-channel format, such as Dolby Digital, allowing you to enjoy a more real audio presence.

Furthermore, various advanced functions such as the multi-angle, multilingual, and Parental Control functions are provided with the DVD.

---

## DVD-RW (page 6)

A DVD-RW is a recordable and rewritable disc that is the same size as a DVD VIDEO. The DVD-RW has two different modes: VR mode and Video mode. DVD-RWs created in Video mode have the same format as a DVD VIDEO, while discs created in VR (Video Recording) mode allow the contents to be programmed or edited.

---

## DVD+RW (page 6)

A DVD+RW (plus RW) is a recordable and rewritable disc. DVD+RWs use a recording format that is comparable to the DVD VIDEO format.

---

## Index (CD)/Video Index (VIDEO CD) (page 37)

A number that divides a track into sections to easily locate the point you want on a CD or VIDEO CD. Depending on the disc, no index may be recorded.

---

## Scene (page 10)

On a VIDEO CD with PBC (playback control) functions, the menu screens, moving pictures and still pictures are divided into sections called "scenes."

---

## Title (page 10)

The longest section of a picture or music feature on a DVD, movie, etc., in video software, or the entire album in audio software.

---

## Track (page 10)

Sections of a picture or a music feature on a CD or VIDEO CD (the length of a song).

---

# Specifications

## System

**Laser:** Semiconductor laser

**Signal format system:** NTSC

## Audio characteristics

**Frequency response:** DVD VIDEO (PCM 96 kHz): 2 Hz to 44 kHz ( $\pm 1.0$  dB)/DVD VIDEO (PCM 48 kHz): 2 Hz to 22 kHz ( $\pm 0.5$  dB)/CD: 2 Hz to 20 kHz ( $\pm 0.5$  dB)

**Signal-to-noise ratio (S/N ratio):** 115 dB (LINE OUT (L/R) AUDIO jacks only)

**Harmonic distortion:** 0.003 %

**Dynamic range:** DVD VIDEO: 103 dB/CD: 99 dB

**Wow and flutter:** Less than detected value ( $\pm 0.001\%$  W PEAK)

The signals from LINE OUT L/R (AUDIO) jacks are measured. When you play PCM sound tracks with a 96 kHz sampling frequency, the output signals from the DIGITAL OUT (COAXIAL) jack are converted to 48 kHz sampling frequency.

## Outputs/Inputs

**(Jack name:** Jack type/Output or Input level/ Load impedance)

**LINE OUT (AUDIO):** Phono jack/2 Vrms/ 10 kilohms

**DIGITAL OUT (COAXIAL):** Phono jack/ 0.5 Vp-p/75 ohms

**COMPONENT VIDEO OUT (Y, P<sub>B</sub>, P<sub>R</sub>):** Phono jack/Y: 1.0 Vp-p/P<sub>B</sub>, P<sub>R</sub>: 0.65 Vp-p/75 ohms

**LINE OUT (VIDEO):** Phono jack/1.0 Vp-p/ 75 ohms

**S VIDEO OUT:** 4-pin mini DIN/Y: 1.0 Vp-p, C: 0.286 Vp-p/75 ohms

## General

### Power requirements:

120 V AC, 60 Hz

110 to 240 V AC, 50/60 Hz

See page 3 for further information.

### Power consumption:

 13 W

**Dimensions (approx.):** 430 × 55.5 × 234 mm (17 × 2 <sup>3</sup>/<sub>16</sub> × 9 <sup>1</sup>/<sub>4</sub> in.) (width/ height/depth) incl. projecting parts

**Mass (approx.):** 2.2 kg (4 lb 14 oz)

**Operating temperature:** 5 °C to 35 °C (41 °F to 95 °F)

**Operating humidity:** 25 % to 80 %

## Supplied accessories

See page 15.

Specifications and design are subject to change without notice.

ENERGY STAR® is a U.S. registered mark. As an ENERGY STAR® Partner, Sony Corporation has determined that this product meets the ENERGY STAR® guidelines for energy efficiency.

# Language Code List

For details, see pages 41, 44, 50.

The language spellings conform to the ISO 639: 1988 (E/F) standard.

Code Language	Code Language	Code Language	Code Language
1027 Afar	1183 Irish	1347 Maori	1507 Samoan
1028 Abkhazian	1186 Scots Gaelic	1349 Macedonian	1508 Shona
1032 Afrikaans	1194 Galician	1350 Malayalam	1509 Somali
1039 Amharic	1196 Guarani	1352 Mongolian	1511 Albanian
1044 Arabic	1203 Gujarati	1353 Moldavian	1512 Serbian
1045 Assamese	1209 Hausa	1356 Marathi	1513 Siswati
1051 Aymara	1217 Hindi	1357 Malay	1514 Sesotho
1052 Azerbaijani	1226 Croatian	1358 Maltese	1515 Sundanese
1053 Bashkir	1229 Hungarian	1363 Burmese	1516 Swedish
1057 Byelorussian	1233 Armenian	1365 Nauru	1517 Swahili
1059 Bulgarian	1235 Interlingua	1369 Nepali	1521 Tamil
1060 Bihari	1239 Interlingue	1376 Dutch	1525 Telugu
1061 Bislama	1245 Inupiak	1379 Norwegian	1527 Tajik
1066 Bengali;	1248 Indonesian	1393 Occitan	1528 Thai
Bangla	1253 Icelandic	1403 (Afan)Oromo	1529 Tigrinya
1067 Tibetan	1254 Italian	1408 Oriya	1531 Turkmen
1070 Breton	1257 Hebrew	1417 Punjabi	1532 Tagalog
1079 Catalan	1261 Japanese	1428 Polish	1534 Setswana
1093 Corsican	1269 Yiddish	1435 Pashto;	1535 Tonga
1097 Czech	1283 Javanese	Pushto	1538 Turkish
1103 Welsh	1287 Georgian	1436 Portuguese	1539 Tsonga
1105 Danish	1297 Kazakh	1463 Quechua	1540 Tatar
1109 German	1298 Greenlandic	1481 Rhaeto-	1543 Twi
1130 Bhutani	1299 Cambodian	Romance	1557 Ukrainian
1142 Greek	1300 Kannada	1482 Kirundi	1564 Urdu
1144 English	1301 Korean	1483 Romanian	1572 Uzbek
1145 Esperanto	1305 Kashmiri	1489 Russian	1581 Vietnamese
1149 Spanish	1307 Kurdish	1491 Kinyarwanda	1587 Volapük
1150 Estonian	1311 Kirghiz	1495 Sanskrit	1613 Wolof
1151 Basque	1313 Latin	1498 Sindhi	1632 Xhosa
1157 Persian	1326 Lingala	1501 Sangho	1665 Yoruba
1165 Finnish	1327 Laothian	1502 Serbo-	1684 Chinese
1166 Fiji	1332 Lithuanian	Croatian	1697 Zulu
1171 Faroese	1334 Latvian;	1503 Singhalese	
1174 French	Lettish	1505 Slovak	
1181 Frisian	1345 Malagasy	1506 Slovenian	1703 Not specified

# Index

## Numerics

- 16:9 51
- 4:3 LETTER BOX 51
- 4:3 PAN SCAN 51
- 5.1 Channel Surround 41

## A

- A-B REPEAT 35
- ALBUM 37
- Album 30
- ANGLE 45
- AUDIO 41, 50
- AUDIO ATT 53
- AUDIO DRC 53
- AUDIO SETUP 53
- AUTO PLAY 52
- AUTO POWER OFF 52

## B

- BACKGROUND 51
- Batteries 15
- BLACK LEVEL 51

## C

- CD 6, 25
- CHAPTER 37
- Chapter 10, 58
- Child Lock 26
- Connecting 16
- Continuous play
  - CD/VIDEO CD 25
  - DVD 25
- Control Bar 13
- CUSTOM 49
- CUSTOM SETUP 52

## D

- DATA CD 6, 30
- DIGITAL OUT 54
- Digital output 54
- DIMMER 52
- DISC RESUME 27, 53
- Display
  - Control Bar display 13
  - Front panel display 10
  - Setup Display 49
- DOLBY DIGITAL 22, 41, 54, 58
- DOWNMIX 54
- DTS 22, 41, 54, 58
- DVD 6, 25
- DVD+RW 6, 26, 58
- DVD's Menu 28
- DVD-RW 6, 26, 58

## F

- Fast forward 36
- Fast reverse 36
- Freeze Frame 36
- Front panel display 10

## H

- Handling discs 8
- Hooking up 15

## I

- INDEX 37
- Index 58
- Instant Replay 26
- Instant Search 26

## L

- LANGUAGE SETUP 50
- Locating
  - a specific point by watching the TV screen 36

## M

- MENU 50
- MP3 6, 30, 56

## N

- NUMBER INPUT 38

## O

- On-screen display
  - Control Bar display 13
  - Setup Display 49
- OSD 50

## P

- PARENTAL CONTROL 46
- PAUSE MODE 53
- PBC Playback 29
- PICTURE MODE 44
- PRO LOGIC 21, 54, 58
- PROGRAM 32
- Program Play 32

## Q

- QUICK 50
- Quick Setup 23, 50

## R

- Remote 15
- REPEAT 34
- Repeat Play 34
- RESET 50
- Resume Play 27

## S

- S VIDEO output 16
- Scan 36
- SCENE 37
- Scene 10, 58
- SCREEN SAVER 51
- SCREEN SETUP 51
- Searching 36
- SETUP 49
- Setup Display 49
- SHUFFLE 33
- Shuffle Play 33
- Slow-motion Play 36
- Speakers
  - Hooking up 18
- SUBTITLE 44, 50
- SURROUND 18, 42

## T

- TIME/TEXT 38, 39
- TITLE 37
- Title 10, 58
- TOP MENU 28
- TRACK 37
- Track 10, 30, 58
- TRACK SELECTION 53
- Troubleshooting 55
- TV TYPE 51

## U

- Usable discs 6

## V

- VIDEO CD 6, 25
- Virtual Surround 42







Printed on 100% recycled magazine paper.

Printed using VOC (volatile organic compound)-free vegetable oil based ink.

## Free Manuals Download Website

<http://myh66.com>

<http://usermanuals.us>

<http://www.somanuals.com>

<http://www.4manuals.cc>

<http://www.manual-lib.com>

<http://www.404manual.com>

<http://www.luxmanual.com>

<http://aubethermostatmanual.com>

Golf course search by state

<http://golfingnear.com>

Email search by domain

<http://emailbydomain.com>

Auto manuals search

<http://auto.somanuals.com>

TV manuals search

<http://tv.somanuals.com>