

aiwa

COMPACT DISC RECORDER
GRABADORA DE DISCOS COMPACTOS
ENREGISTREUR DE DISQUE COMPACT

XC-RW700

OPERATING INSTRUCTIONS
MANUAL DE INSTRUCCIONES
MODE D'EMPLOI

En (English)

E (Español)

F (Français)

For assistance and information,
call toll free 1-800-BUY-AIWA.
(United States and Puerto Rico)

U



8A-AJ2-901-21
001101CMK-H-L

WARNING

TO REDUCE THE RISK OF FIRE OR ELECTRIC SHOCK, DO NOT EXPOSE THIS APPLIANCE TO RAIN OR MOISTURE.

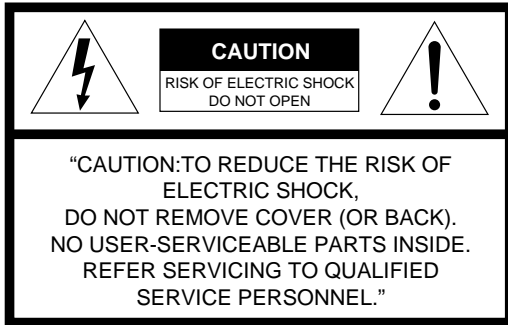

Explanation of Graphical Symbols:

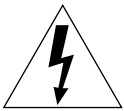

The lightning flash with arrowhead symbol, within an equilateral triangle, is intended to alert the user to the presence of uninsulated "dangerous voltage" within the product's enclosure that may be of sufficient magnitude to constitute a risk of electric shock to persons.



The exclamation point within an equilateral triangle is intended to alert the user to the presence of important operating and maintenance (servicing) instructions in the literature accompanying the appliance.

PRECAUTIONS

Read the Operating Instructions carefully and completely before operating the unit. Be sure to keep the Operating Instructions for future reference. All warnings and cautions in the Operating Instructions and on the unit should be strictly followed, as well as the safety suggestions below.

Installation

- 1 Water and Moisture** - Do not use this unit near water, such as near a bathtub, washbowl, swimming pool, or the like.
- 2 Heat** - Do not use this unit near sources of heat, including heating vents, stoves, or other appliances that generate heat. It also should not be placed in temperatures less than 5°C (41°F) or greater than 35°C (95°F).
- 3 Mounting surface** - Place the unit on a flat, even surface.

- 4 Ventilation** - The unit should be situated with adequate space around it so that proper heat ventilation is assured. Allow 10 cm (4 in.) clearance from the rear and the top of the unit, and 5 cm (2 in.) from each side.
 - Do not place the unit on a bed, rug, or similar surface that may block the ventilation openings.
 - Do not install the unit in a bookcase, cabinet, or airtight rack where ventilation may be impeded.
- 5 Objects and liquid entry** - Take care that objects or liquids do not get inside the unit through the ventilation openings.
- 6 Carts and stands** - When placed or mounted on a stand or cart, the unit should be moved with care. Quick stops, excessive force, and uneven surfaces may cause the unit and cart to overturn or fall.
- 7 Condensation** - Moisture may form on the CD pickup lens when:
 - The unit is moved from a cold spot to a warm spot
 - The heating system has just been turned on
 - The unit is used in a very humid room
 - The unit is cooled by an air conditionerWhen this unit has condensation inside, it may not function normally. Should this occur, leave the unit for a few hours, then try to operate again.
- 8 Wall or ceiling mounting** - The unit should not be mounted on a wall or ceiling, unless specified in the Operating Instructions.



Electric Power

- 1 Power Sources** - Connect this unit only to power sources specified in the Operating Instructions, and as marked on the unit.
- 2 Polarization** - As a safety feature, some units are equipped with polarized AC power plugs which can only be inserted one way into a power outlet. If it is difficult or impossible to insert the AC power plug into an outlet, turn the plug over and try again. If it still does not easily insert into the outlet, please call a qualified service technician to service or replace the outlet. To avoid defeating the safety feature of the polarized plug, do not force it into a power outlet.
- 3 AC power cord**
 - When disconnecting the AC power cord, pull it out by the AC power plug. Do not pull the cord itself.
 - Never handle the AC power plug with wet hands, as this could result in fire or shock.
 - Power cords should be routed to avoid being severely bent, pinched, or walked upon. Pay particular attention to the cord from the unit to the power socket.
 - Avoid overloading AC outlets and extension cords beyond their capacity, as this could result in fire or shock.
- 4 Extension cord** - To help prevent electric shock, do not use a polarized AC power plug with an extension cord, receptacle, or other outlet unless the polarized plug can be completely inserted to prevent exposure of the blades of the plug.
- 5 When not in use** - Unplug the AC power cord from the AC outlet if the unit will not be used for several months or more. When the cord is plugged in, a small amount of current continues to flow to the unit, even when the power is turned off.

Maintenance

Clean the unit only as recommended in the Operating Instructions.

Damage Requiring Service

Have the unit serviced by a qualified service technician if:

- The AC power cord or plug has been damaged
- Foreign objects or liquid have gotten inside the unit
- The unit has been exposed to rain or water
- The unit does not seem to operate normally
- The unit exhibits a marked change in performance
- The unit has been dropped, or the cabinet has been damaged

DO NOT ATTEMPT TO SERVICE THE UNIT YOURSELF.

FCC Part 15B, ClassB

FCC NOTICE

NOTE

This equipment has been tested and found to comply with the limits for a Class B digital device, pursuant to Part 15 of the FCC Rules. These limits are designed to provide reasonable protection against harmful interference in a residential installation.

This equipment generates, uses, and can radiate radio frequency energy and, if not installed and used in accordance with the instructions, may cause harmful interference to radio communications. However, there is no guarantee that interference will not occur in a particular installation. If this equipment does cause harmful interference to radio or television reception, which can be determined by turning the equipment off and on, the user is encouraged to try to correct the interference by one or more of the following measures:

- Reorient or relocate the receiving antenna.
- Increase the separation between the equipment and receiver.
- Connect the equipment into an outlet on circuit different from that to which the receiver is connected.
- Consult the dealer or an experienced radio/TV technician for help.

CAUTION

Modifications or adjustments to this product, which are not expressly approved by the manufacturer, may void the user's right or authority to operate this product.

Owner's record

For your convenience, record the model number and serial number (you will find them on the rear of your set) in the space provided below. Please refer to them when you contact your Aiwa dealer in case of difficulty.

| Model No. | Serial No. (Lot No.) |
|-----------|----------------------|
| XC-RW700 | |

TABLE OF CONTENTS

| | |
|--|----|
| PRECAUTIONS | 2 |
| FEATURES | 4 |
| BEFORE OPERATION | 4 |
| TYPES OF DISCS | 4 |
| ACCESSORIES | 4 |
| CLEANING THE CABINET | 5 |
| STORING DISCS | 5 |
| CARE OF DISCS | 5 |
| REMOTE CONTROL | 5 |
| GENERAL GUIDE | 6 |
| FRONT PANEL CONTROLS | 6 |
| INFORMATION DISPLAY | 7 |
| REAR PANEL CONNECTIONS | 8 |
| BUTTONS ON THE REMOTE CONTROL | 9 |
| CONNECTIONS | 10 |
| PLAY DECK CONNECTIONS | 11 |
| RECORD DECK CONNECTIONS | 11 |
| POWER CONNECTIONS | 11 |
| USING HEADPHONES | 11 |
| LOADING DISCS | 12 |
| INFORMATION DISPLAY | 12 |
| NOTES ON THE OPC LIMIT OF CD-R DISCS | 13 |
| RECORDING | 13 |
| PRECAUTIONS | 13 |
| DISC DUBBING | 14 |
| CD SYNC RECORDING | 15 |
| MANUAL RECORDING | 16 |
| NUMBERING TRACKS | 17 |
| FINALIZATION | 18 |
| UNFINALIZATION | 18 |
| ERASING AN ENTIRE CD-RW DISC | 19 |
| ERASING INDIVIDUAL TRACKS | 19 |
| PLAYBACK | 20 |
| BASIC OPERATION | 20 |
| RANDOM PLAYBACK | 20 |
| REPEAT PLAYBACK | 21 |
| PROGRAMMED PLAYBACK | 22 |
| DUAL PLAY MODE | 23 |
| CHANGING THE TIME | |
| DISPLAY MODE | 23 |
| TROUBLESHOOTING | 24 |
| ALERT MESSAGES | 25 |
| RESTRICTIONS ON DIGITAL RECORDING | 26 |
| SPECIFICATIONS | 26 |

En

FEATURES

- Dual deck CD player and CD-R/CD-RW recorder
- Dual play capability
- 4× dubbing speed for both CD-R and CD-RW discs
- Digital to analog converters for highest audio quality
- Built in 32 to 96 kHz sampling converter
- Optical and coaxial digital inputs and outputs
- Front panel digital input for use with portable devices
- Extensive playback programming capabilities

BEFORE OPERATION

TYPES OF DISCS

CD-R and CD-RW Discs

For recording and playback you can use the CD-R and CD-RW discs with the following logos:



With a CD-R disc, you can add recordings until the disc is full, but you cannot erase any of them.

With a CD-RW disc, you can add and erase recordings as needed.

| DISC | RECORDING | PLAYBACK |
|-------|---------------------------------------|---|
| CD-R | Can be recorded only incrementally. | When finalized, can be played on conventional CD players. |
| CD-RW | Can be recorded and erased as needed. | Even when finalized, can be played only on CD-RW compatible CD players. |

Conventional audio CDs

Discs with the following logo can be played back on this unit, but no recordings can be made on them.



When you load a CD-R, CD-RW or any other disc that is not compatible with this unit, "DISC ERROR" may appear on the display to warn you that the disc cannot be used with this unit.

NOTE

- Do not use irregular shape CDs (example: heart-shaped, octagonal ones). It may result in malfunction.
- Do not attach any seal or label to either side (the recordable side or the labeled side) of a CD-R/RW disc. It may cause malfunction.
- The unit may not play a CD-R/RW disc that is recorded on personal computers or some kinds of CD-R/RW recorders because of differences in recording platforms.
- Do not use a CD-R/RW disc which contains non-audio data, such as MP 3 or other computer files.
- Trouble may occur in this unit if a CD-R/RW disc with dirt or scratches is used. In such case, refer to "ALERT MESSAGES" on page 25.
- Depending on the conditions of the surface of CD-R/RW disc (e.g. dirt, scratch, fingerprint, etc.), the head part of the first recorded track may be cut off.

CAUTION

Do not open and close the disc tray of the record deck unnecessarily with a non-finalized CD-R disc inside. See page 13 for details.

WARNING

Digital recording capabilities this unit provides you with are only for personal use.

Dubbing copyrighted material without permission of the copyright owner is a violation of the copyright laws.

ACCESSORIES

The package contains the following items.

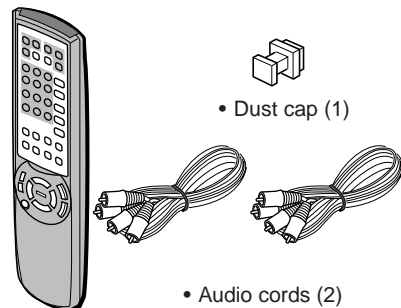

- Remote control (1)
- Operating instructions (1)

- Dust cap (1)

- Audio cords (2)

Insert the supplied dust cap in the **DIGITAL IN (OPTICAL)** jack on the front panel when not using the jack.

CLEANING THE CABINET

Use a soft, dry cloth. If the surfaces are extremely dirty, use a soft cloth lightly moistened with a mild detergent solution. Do not use strong solvents, such as alcohol, benzene or thinner, as these might damage the surface of the unit.

STORING DISCS

After recording or playing, store the disc in its case. Do not expose the disc to direct sunlight or sources of heat, or leave it in a parked car exposed to direct sunlight, as temperature may rise considerably inside the car.

CARE OF DISCS

- Discs can be scratched. Handle them carefully.
- When a disc becomes dirty, wipe it from the center out with a soft cleaning cloth.

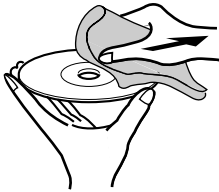

Do not use strong solvents such as alcohol, benzene, thinner, commercially available cleaners or anti-static spray intended for analog records.

REMOTE CONTROL

Inserting batteries

Detach the battery cover on the rear of the remote control and insert two R6 (size AA) batteries.

Load the batteries as illustrated.

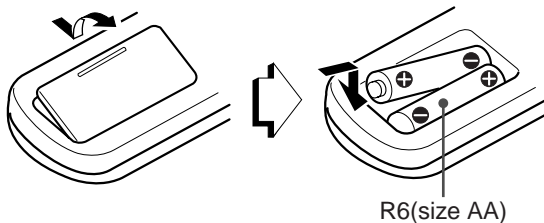

When to replace the batteries

The maximum operational distance between the remote control and the sensor on the main unit should be approximately 7 meters (23 feet). When this distance decreases, replace the batteries with new ones.

Using the shared buttons

The remote control is designed to operate both of the CD decks of the unit. Some buttons are dedicated to one specific CD deck, while others are shared between the two decks.

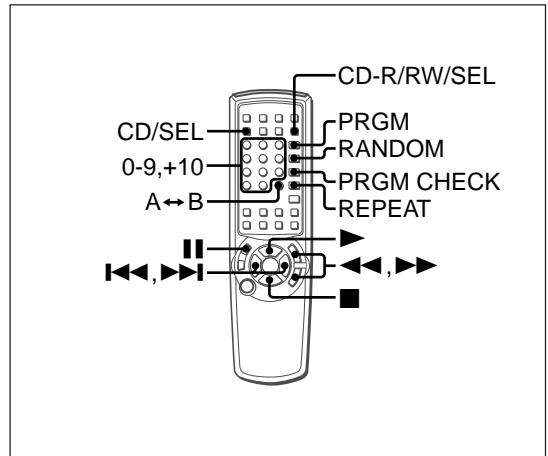

To use shared buttons, such as **▶**, **■**, **||**, **◀◀**, **▶▶**, **◀◀▶▶**, **▶▶|**, **PRGM**, **PRGM CHECK**, **RANDOM**, **REPEAT**, **A ↔ B** and numbered, first press either **CD/SEL** to control the play deck or **CD-R/RW/SEL** to control the record deck. When **CD/SEL** or **CD-R/RW/SEL** is pressed, "CDP" or "CDR" will appear on the appropriate information display to confirm the selection.

NOTE

- If the remote control is not going to be used for an extended period of time, remove the batteries to prevent possible electrolyte leakage.
- The remote control may not operate correctly when:
 - The line of sight between the remote control and the remote sensor (located on the front panel) is exposed to intense light, such as direct sunlight
 - Other remote controls are used nearby (television, etc.)

En

GENERAL GUIDE

FRONT PANEL CONTROLS

- 1 2 3...** : For CD Play Deck (CD)
1 2 3... : For CD Record Deck (CD-R/RW)
1 2 3... : For both Decks (CD and CD-R/RW)

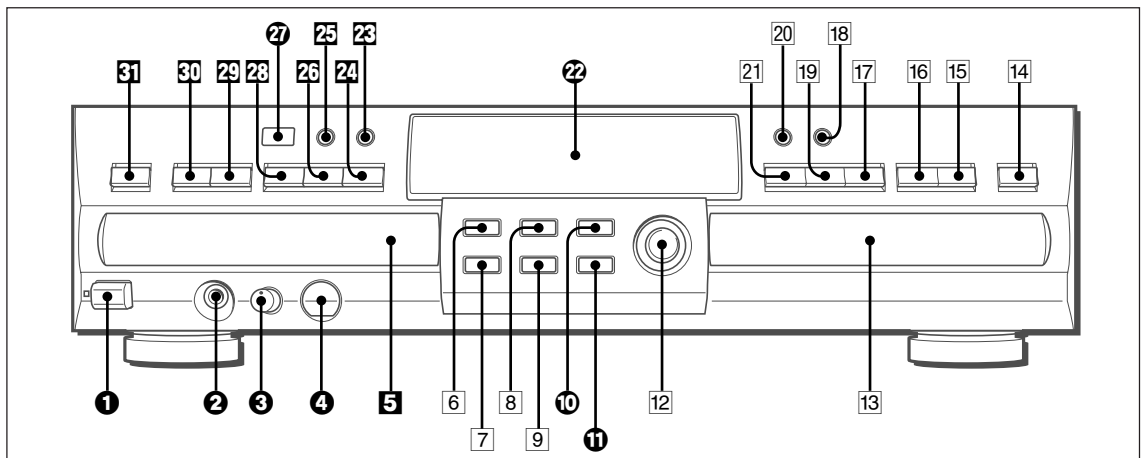

- 1 POWER**
Press to turn on the power.
- 2 PHONES**
Connect headphones with a standard stereo type plug.
- 3 PHONE LEVEL**
Turn to adjust the headphones volume level.
- 4 DIGITAL IN (OPTICAL)**
Use to connect a portable digital audio player to this unit for digital recording.
- 5 Play deck**
Use to play CD, CD-R or CD-RW discs that have been finalized.
- 6 RECORD**
Press to begin recording.
- 7 ERASE**
Press to erase one or more tracks of an unfinalized CD-RW disc.
- 8 CD SYNC**
Press to begin sync recording of a single track or an entire disc from an external CD, MD, DAT player.
- 9 FINALIZE**
Press to finalize the recording process.
- 10 DUBBING**
Press to make a complete copy of the disc to a CD-R or CD-RW.
- 11 SPEED**
Press to select the recording speed for internal dubbings.
- 12 REC LEVEL**
Use to control input level when making recordings in analog mode.
- 13 Record deck**
Use to playback CD and record CD-R and CD-RW discs.
- 14 OPEN/CLOSE**
Press to open the record deck. Press again to close the deck.
- 15 FFW/FF SKIP/SEARCH**
Press and hold to play the disc in fast-forward mode. Press to move to the next track.
- 16 RR/RW SKIP/SEARCH**
Press and hold to play in fast-reverse mode. Press to move to the previous track.
- 17 PAUSE**
Press to pause or restart the disc.
- 18 INPUT**
Press to select the input source for recording.
- 19 STOP**
Press to stop the CD in the record deck.
- 20 DISPLAY**
Press to cycle through the time display options for the record deck.
- 21 PLAY/SELECT**
Press to play a CD or to set a selection in the record deck.
- 22 Information display**
Displays the status of this unit.
- 23 DISPLAY**
Press to cycle through the time display options for the play deck.
- 24 PAUSE**
Press to pause or restart the disc.
- 25 DUAL**
Press to enable both CD decks to playback at the same time and function separately.
- 26 STOP**
Press to stop the CD in the play deck.
- 27 REMOTE SENSOR**
Receives commands from the remote control.

28 ► PLAY

Press to play a CD in the play deck.

29 ►►/►► SKIP/SEARCH

Press and hold to play the disc in fast-forward mode.
Press to move to the next track.

30 ◀◀/◀◀ SKIP/SEARCH

Press and hold to play in fast-reverse mode. Press to move to the previous track.

31 ▲ OPEN/CLOSE

Press to open the play deck. Press again to close the deck.

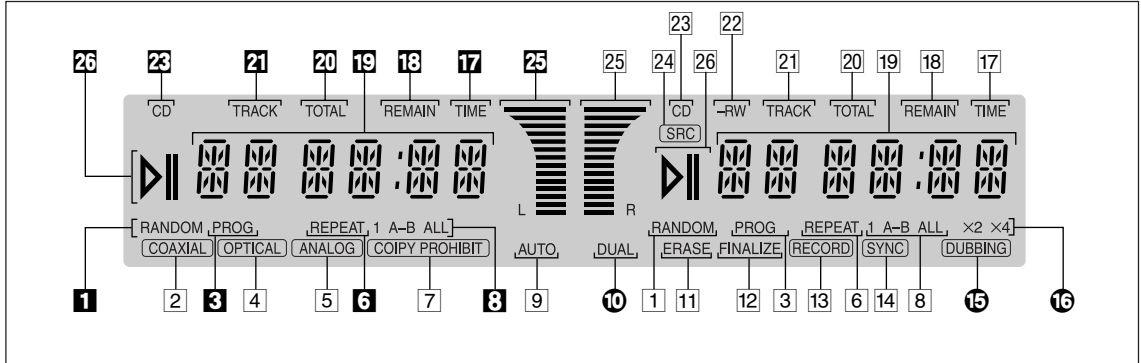
INFORMATION DISPLAY**1 1 RANDOM**

Lights when random playback has been programmed for one of the CD decks.

2 COAXIAL

Lights when signal from coaxial jacks is selected as the source.

3 3 PROG

Lights when one of the CD decks is being programmed for playback options.

4 OPTICAL

Lights when signal from optical jack (on the front panel or rear panel) is selected as the source.

5 ANALOG

Lights when signal from analog jacks is selected as source.

6 6 REPEAT

Lights when a repeat function is being used.

7 COPY PROHIBIT

Lights when a recording is not possible due to the Serial Copy Management System (SCMS).

8 8 1 A-B ALL

Displays the type of repeat function being used.

9 AUTO

Lights when the automatic method of incrementing tracks is selected for a recording session.

10 DUAL

Lights when the unit is playing in dual mode.

11 ERASE

Lights when a CD-RW disc is being erased.

12 FINALIZE

Lights when the unit is in the Finalization process.

13 RECORD

Lights when making a recording and flashes while preparing to make a recording.

14 SYNC

Lights when the unit has been programmed for a CD sync recording.

15 DUBBING

Lights when a dubbing is in progress between the two CD decks.

16 X2 X4

Indicates which speed has been selected for dubbing recordings.

17 17 TIME

Lights in conjunction with one of the time indicators TRACK, TOTAL, REMAIN, to show which of the time status mode is active.

18 18 REMAIN

Lights when the information display shows the time remaining on a disc.

19 19 Status display

Displays the disc playing time and messages about the discs recordings.

20 20 TOTAL

Lights when the information display shows the total time of all tracks on a disc.

21 21 TRACK

Lights when the information display shows the running time of the individual track being played.

22 -RW

Indicates the type of disc in the record deck. When a CD-R disc is in use, only "-R" is lit. When a CD-RW disc is in use, "-RW" is lit.

23 23 CD

Lights when a conventional audio CD is playing in the CD deck.

24 SRC

Lights when the Sample-Rate Converter is in use.

25 25 Level indicators

Displays the input/output level during an analog recording.

26 26 Play/Pause indicator

Indicates the status of the individual CD decks.

REAR PANEL CONNECTIONS

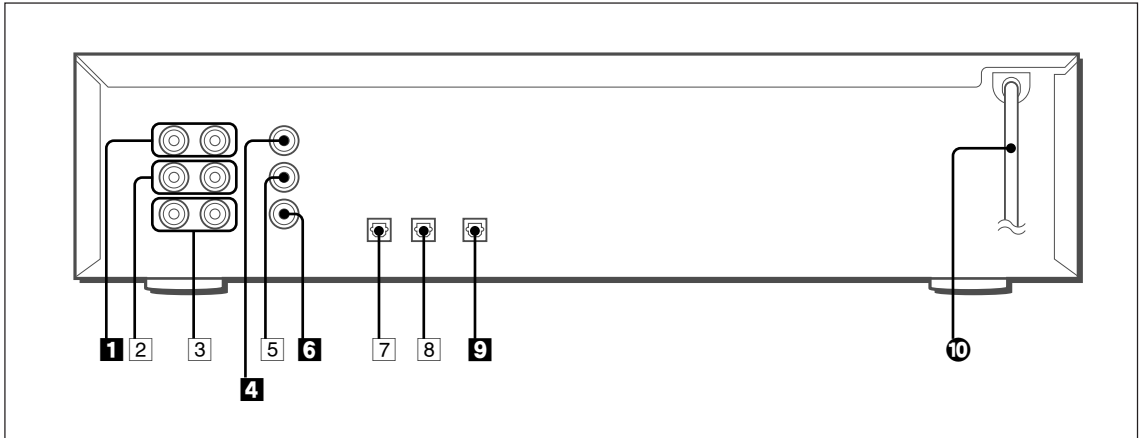

1 ANALOG CD OUT

These jacks carry the analog audio output signal from the play deck.

2 ANALOG CD-R/RW OUT

These jacks carry the analog audio output signal from the record deck.

3 ANALOG CD-R/RW IN

These jacks accept the analog signals that are used for CD recordings.

4 COAXIAL CD OUT

This jack carries the digital audio output signal from the play deck.

5 COAXIAL CD-R/RW OUT

This jack carries the digital audio output signal from the record deck.

6 COAXIAL CD-R/RW IN

This jack accepts the digital audio input signal from a compatible digital audio product.

7 OPTICAL CD-R/RW DIGITAL IN

This jack accepts the digital audio input signal from a compatible digital audio product.

8 OPTICAL CD-R/RW DIGITAL OUT

This jack carries the digital audio output signal from the record deck.

9 OPTICAL CD DIGITAL OUT

This jack carries the digital audio output signal from the play deck.

10 AC power cord

Connect this plug to an AC outlet.

BUTTONS ON THE REMOTE CONTROL

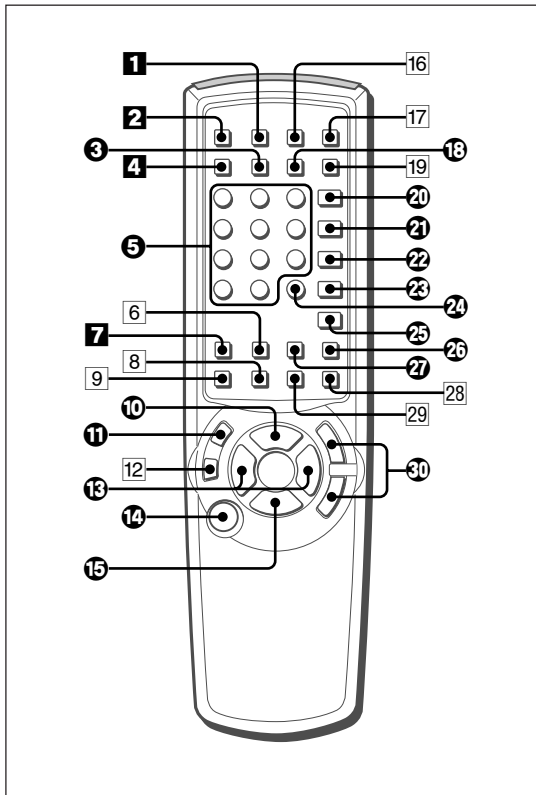

1 CD/DISP

Press to cycle through the various time display options for the disc in the play deck.

2 CD/▲

Press to open the play deck.

3 SINGLE

Press to control the unit as a two-disc CD player/changer.

4 CD/SEL

Press to control or program the functions of the disc in the play deck.

5 Numbered buttons

Press to access a specific track for playback or during the programming process.

6 CD SYNC

Press to begin sync recording from an external CD player when a digital connection is used.

7 AUTO/MANUAL

Press to select automatic or manual track increments during a recording session.

8 INPUT SEL

Press to select the input source (analog, digital-coaxial, or digital-optical) for recording.

9 TRACK INCR

Press to increase the track number.

10 ►

Use as a play and enter button.

11 ||

Press to pause and resume playback.

12 ●REC

Press to begin a manual recording.

13 ◀▶▶▶

Press to skip to the next/previous track.

14 POWER

Press to turn the unit on/off.

15 ■

Press to stop playback or recording.

16 CD-R/RW/DISP

Press to cycle through time-display options for the disc in the record deck.

17 CD-R/RW/▲

Press to open the record deck.

18 DUAL

Press to enable both CD decks to play back at the same time and function as independent CD units.

19 CD-R/RW/SEL

Press to control or program the functions of the disc in the record deck.

20 PRGM

Press to begin the programming sequence for one of the CD decks.

21 RANDOM

Press to begin random play of all tracks on a disc.

22 PRGM CHECK

Press to check or edit a programmed playback sequence.

23 REPEAT

Press to repeat a current track or an entire disc.

24 A ↔ B

Press to specify a segment of a disc for repeat play.

25 CLEAR

Press to clear an item in a program sequence.

26 SPEED

Press to select the recording speed for internal dubbings.

27 DUBBING

Press to begin a dubbing.

28 ERASE

Press to erase a track or an entire CD-RW disc or to unfinalize a disc.

29 FINALIZE

Press when a recording is complete to initiate the finalization process.

30 ◀▶▶▶

Press and hold to play the selected disc in reverse or fast forward mode to locate a desired passage.

CONNECTIONS

To prevent possible damage to your speakers or other components in your audio system, all system components, including this unit, should be turned off and unplugged from their AC power source when any connections are made or a new component is installed.

Precautions when operating this unit

Never move or tilt this unit or subject it to mechanical shock when recording or playback is in progress. The disc spinning at high speed may be damaged.

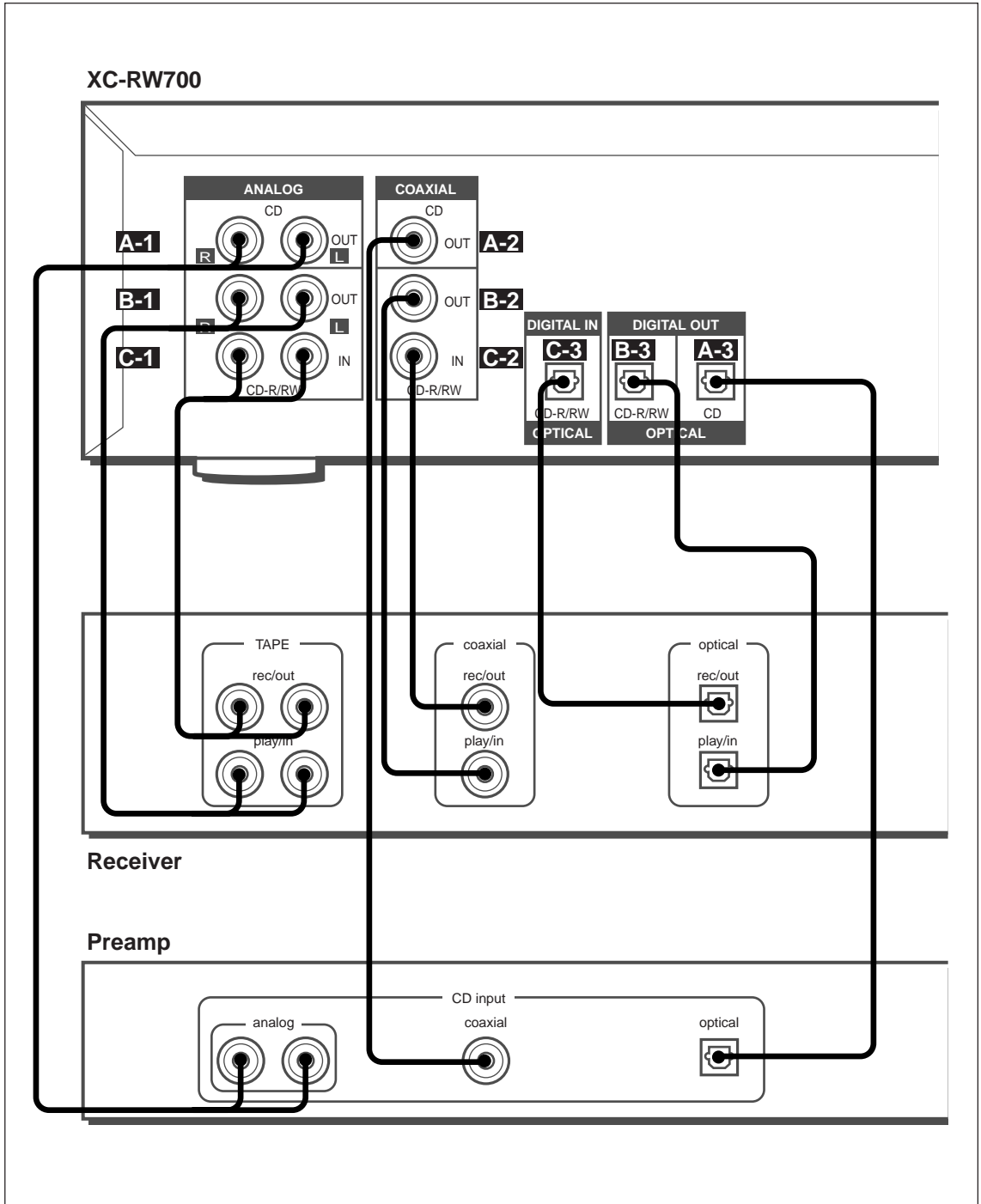

PLAY DECK CONNECTIONS

OUTPUT JACKS:

A-1 ANALOG

Connect the **ANALOG CD OUT** jacks to the CD input analog jacks on your receiver, preamp or surround processor.

A-2 COAXIAL

Connect the **COAXIAL CD OUT** to the CD input coaxial jack of your receiver, preamp, processor or external digital decoder.

A-3 OPTICAL

Connect the **OPTICAL CD DIGITAL OUT** to the CD input optical jack of your receiver, preamp, processor or external digital decoder.

RECORD DECK CONNECTIONS

OUTPUT JACKS:

B-1 ANALOG

Connect the **ANALOG CD-R/RW OUT** jacks to the TAPE play/in jacks on your receiver, preamp or surround processor.

B-2 COAXIAL

Connect the **COAXIAL CD-R/RW OUT** jack to the coaxial play/in jack on your receiver, preamp, processor or external digital decoder.

B-3 OPTICAL

Connect the **OPTICAL CD-R/RW DIGITAL OUT** jack to the optical play/in jack on your receiver, preamp, processor or external digital decoder.

INPUT JACKS:

C-1 ANALOG

Connect the **ANALOG CD-R/RW IN** jacks to the TAPE rec/out on your receiver or processor.

C-2 COAXIAL

Connect the **COAXIAL CD-R/RW IN** jack to the coaxial rec/out jack on your receiver or processor.

C-3 OPTICAL

Connect the **OPTICAL CD-R/RW DIGITAL IN** jack to the optical rec/out jack on your receiver or processor.

To make recordings from external digital sources

- If your receiver does not have digital output jacks, you may connect the **COAXIAL CD-R/RW IN / OPTICAL CD-R/RW DIGITAL IN** jacks on the unit directly to the coaxial/optical rec/out jacks on your CD player or other digital devices.
- If the CD player has both types of outputs, you may connect one to the input of your receiver and the other directly to the unit.

Using the **DIGITAL IN (OPTICAL)** jack on the front panel

Connections to a portable digital CD or MD player may be made by connecting the digital output of the player to the front panel **DIGITAL IN (OPTICAL)** jack on this unit.

NOTE

Consult the owner's manual on your receiver or processor for details, as the names of the jacks may vary from unit to unit.

IMPORTANT NOTES ON DIGITAL CONNECTIONS

Coaxial Connections

- Use a commercially available digital cable (or 75-ohm video cable).
- Do not use audio cords that are not appropriate for digital signal use.

Optical Connections

- Use a commercially available optical fiber cable.
- To ensure proper connection of optical cable, fully insert it into the jack until there is an audible click.
- Remember to save the plastic dust caps that cover the optical jacks, and replace them when a jack is not in use to prevent dust from entering the connection point.

POWER CONNECTIONS

Connect the AC Power Cord to an AC power source.

USING HEADPHONES

Connect headphones with a stereo standard plug (Ø 6.3 mm) to **PHONES**.

To adjust the volume, use **PHONE LEVEL** on the front panel.

- Adjusting **PHONE LEVEL** will not alter the output settings to the analog outputs. Those levels are fixed, and the volume should be adjusted using your receiver, preamp or processor.
- When the unit is in the dual playback mode (see page 23), only the output of the play deck will be fed to **PHONES** jack.

LOADING DISCS

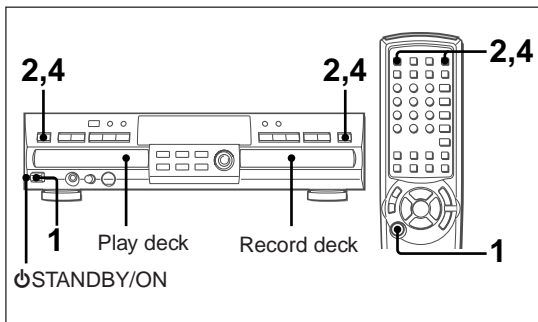

- 1 Press **POWER** on the front panel or remote control.
 STANDBY/ON will turn green, indicating that the unit is on and functioning.
- 2 Press appropriate **▲** on the front panel or remote control to open the desired deck.
- 3 Load a disc with the label side up.
 The play deck may not play the CD-R/RW discs, unless they are finalized. You can play them in the record deck.

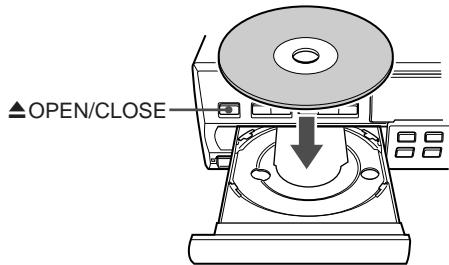

- 4 Press appropriate **▲** to close the desired deck.
 You can also close the deck by gently pressing on the outside of the disc tray.

NOTE

- Do not attach any seal or label to either side (the recordable side or the labeled side) of a CD-R/RW disc. It may cause malfunction.
- Do not use irregular shape CDs (example: heart-shaped, octagonal ones). It may cause malfunction.
- When loading an 8-cm (3-inch) disc, put it on the inner circle of the tray.
- Do not place more than one compact disc on one disc tray.
- Do not tilt the unit with discs loaded. Doing so may cause malfunctions.

INFORMATION DISPLAY

When the disc is loaded, the type or status of disc is displayed as follows:

Conventional audio CD, finalized CD-R or CD-RW disc

"TOC" will flash while the unit reads the disc's Table Of Contents information.



Table Of Contents



The total number of tracks and the total time of all tracks will be displayed. "CD" will also light to indicate that a conventional audio CD is in use.

"CD" lights



Total number of tracks

Total time of all tracks

Non-finalized CD-R or CD-RW disc

"OPC" will be displayed once "TOC" has been read. OPC determines the intensity and duration of the recording laser beam that is best for the currently loaded disc.

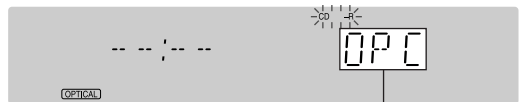

Optimum Power Control



The total number and total time of all tracks that have already been recorded will be displayed, and the appropriate indicator will light if a CD-R or CD-RW disc is in use.

"CD -R" or "CD -RW" lights



Total number of tracks

Total time of all tracks

Computer data disc

"DATA" and "DISC" will be displayed alternatively when there is an error. Data discs will not play and may not be recorded or dubbed in this unit.

NOTES ON THE OPC LIMIT OF CD-R DISCS

When a non-finalized CD-R is loaded in the record deck, "OPC" (Optimum Power Control) appears on the information display. OPC determines the intensity and duration of the recording laser beam that is best for the currently loaded disc.

Do not open and close the disc tray unnecessarily

OPC runs every time a non-finalized CD-R disc is loaded, and OPC can run only a limited number of times (approximately 100 times) on a non-finalized CD-R disc. OPC does not run when loading a finalized CD-R disc or a prerecorded music CD.

RECORDING

PRECAUTIONS

On recording programmed play

Do not attempt to record a sequence of tracks, as programmed on your DAT, DCC or other digital sources. Those tracks would not be numbered continuously. If you want to record a sequence of tracks, record them one by one.

About the update process

"UPDATE" is displayed after recording. The update process writes non-audio data in the PMA (Program Memory Area) of the disc. When finalizing the disc, TOC (Table Of Contents) is generated from the PMA data.

When digital input is interrupted during recording

If incoming digital input from the source device is interrupted momentarily, such as when the sampling frequency is changed on the source, a blank segment is recorded. If there is an interruption longer than 4 seconds, this unit stops recording and updates the PMA data.

When recording additional tracks

Additional recordings are made in sequence to the end of the last track on a non-finalized CD-R/RW if there is enough time remaining on the disc. Up to 99 tracks can be recorded on a single disc.

Minimum length of recording you can make

The shortest possible length of recording is restricted to 6 seconds. In other words, you cannot terminate recording before the first 6 seconds are up. During this interval, pressing ► or ■ has no effect.

Compressed audio, and video or graphics data

This unit is not capable of recording compressed audio like DTS and Dolby Digital Surround sounds. Non-audio data contained in a Graphics CD or HDCD cannot be recorded on this unit either.

Copy prohibit

Some commercial CD discs may contain a copy protection data bit that will prevent the disc from being dubbed. In this case, "COPY PROHIBIT" will light.

En

DISC DUBBING

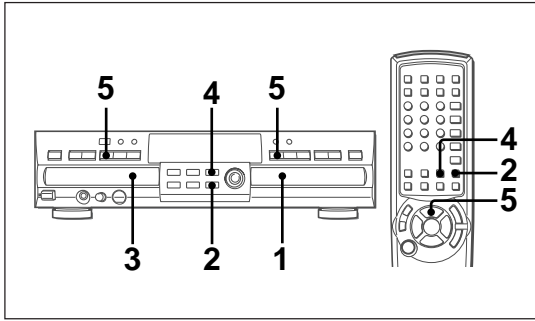

1 Load a blank or non-finalized CD-R/RW disc on the record tray.

After TOC and OPC process, total number of tracks and total time of all tracks will be displayed. "CD-R" or "CD-RW" will also light depending on the disc in the tray.

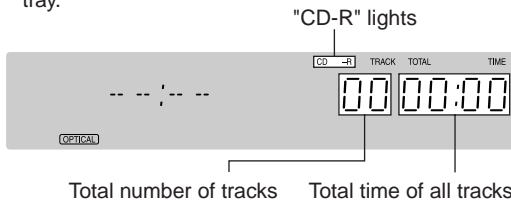

2 Press SPEED repeatedly to select dubbing speed.

With each press of the button, the dubbing speed changes as follows:

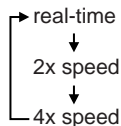

- The default dubbing speed is "real-time". The recording takes as long as the actual running time of the disc.
- When no speed indicator lights, the unit is set to real-time recording.
- Note that the slower the record-dubbing speed, the more tolerant the unit is of errors on the blank disc. However, with most high-quality blank discs, the 2x and 4x speeds should not present a problem.

3 Load the disc to be dubbed on the play tray.

After TOC process, total number of tracks and total time of all tracks will be displayed and CD will light.

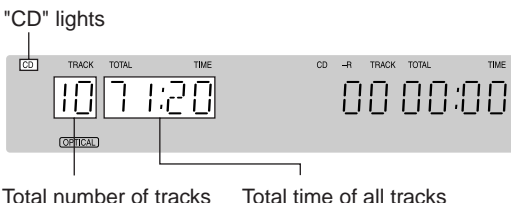

4 Press DUBBING , and wait until "01 00:00" is displayed.

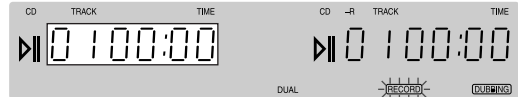

When "DISC FULL" is displayed

There is not enough space on the disc. Use another disc.

5 Press ► on the play deck or record deck. Alternatively, press ► on the remote control.

The dubbing will stop automatically when the source disc has played through to the end. After the dubbing is finished, "BUSY" and "UPDATE" will be displayed briefly.

To stop a dubbing operation manually

Press ■ on the play deck or record deck. Alternatively, press ■ on the remote control.

To play in other machines

As with all recorded CD-R/RW discs, the disc must be finalized before it can be played in other machines. See page 18 for details.

Changing the order of tracks to be dubbed

Before starting the dubbing, program the tracks so that they will be played in the desired order. See page 22 for details.

- Dub containing programmed playback may only be made by real-time or 2x speed. If you attempt to make a programmed dubbing at 4x speed, the unit will automatically select the 2x speed.

NOTE

- Recording levels may not be adjusted during digital recordings.
- It is possible to listen to the disc while it is being dubbed by selecting the appropriate input on your receiver, preamp or processor.
- Do not use high volume levels when listening to high-speed dubbings while they are in progress. It may cause malfunction.
- ■ does not operate while a dubbing is in progress.
- Tracks will be added automatically to mirror the track structure of the original disc.
- The total time indication of the recorded CD may vary slightly from the original due to variations in the spin speed of each drive. But no information has been lost in the recording process.
- If the original disc being dubbed is a digital copy or if it contains copy-prohibit signals, the unit will automatically make a copy with real-time speed in analog mode because of SCMS (see page 26).

CD SYNC RECORDING (from external CD or MD player.)

CD sync recording allows you to make an automatic digital recording from an external CD or MD player. During CD sync recording, the record deck starts in sync with the source, and tracks are added automatically.

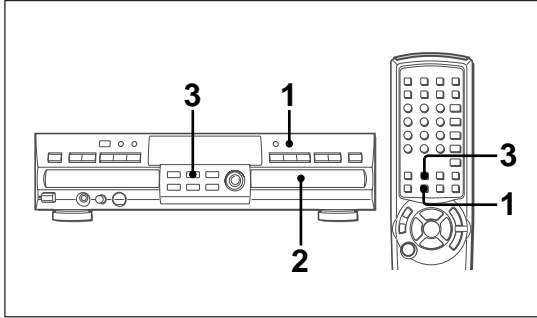

1 Press INPUT on the front panel or INPUT SEL on the remote control repeatedly until the desired input is displayed.

With each press of the button, the input changes as follows:

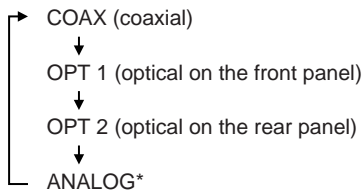

* CD sync recordings can not be made from an analog input.

2 Load a blank or non-finalized CD-R/RW disc on the record tray.

3 Press CD SYNC repeatedly on the front panel or remote control to select "1 TRK" or "ALL". To record only the first track from the source player, select "1 TRK".

To record the entire disc or tape, select "ALL".



4 Play the source device.

Recording starts in sync with the source, and stops when there is no incoming signal for more than three seconds.

After the recording is finished, "BUSY" and "UPDATE" will be displayed briefly.

- If the source material is a CD, tracks will be added automatically to mirror the track structure of the original disc.
- Recording levels may not be adjusted during digital recordings.

When "DISC FULL" is displayed

There is not enough space on the disc, use another disc.

To stop the recording manually

Press ■ on the record deck.

Alternatively, press CD-R/RW/SEL and then ■ on the remote control.

To play in other machines

As with all recorded CD-R/RW discs, the disc must be finalized before it can be played in other machines. See page 18 for details.

NOTE

You cannot start or resume recording from a halfway point.

- When in CD sync record-standby mode and switch the source device from pause to playback, this unit does not start recording, but remains in the standby mode.
- If you switch the source device from playback to pause during CD sync recording, this unit stops recording and runs the update process.
- It is possible to listen to the sound while recording by selecting the appropriate input on your receiver, preamp or processor.

MANUAL RECORDING (from external sources)

The recording can be started and paused at your will.

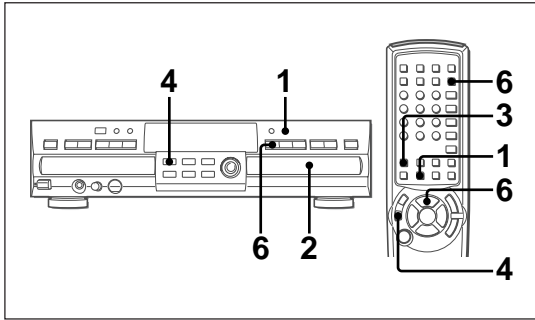

1 Press INPUT on the front panel or INPUT SEL on the remote control repeatedly until the desired input is displayed.

With each press of the button, the input changes as follows:

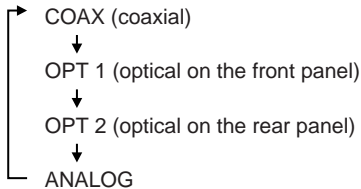

- Recording levels may not be adjusted during digital recordings.
- Recording level needs to be adjusted manually during analog recordings. Adjust the recording level using **REC LEVEL** so that the blue segments of the level indicator are almost lit, and the red segments flash only occasionally.
When recording level is adjusted too high, the red segments of the level indicator are always lit.

2 Load a blank or non-finalized CD-R/RW disc on the record tray.

3 Press AUTO/MANUAL on the remote control to select how tracks will be numbered on the recorded disc.

See page 17 for details.

4 Press ●RECORD on the front panel or press ●REC on the remote control.

"RECORD" will flash, and "BUSY" will briefly appear.



When the display returns to the track and running-time information, the unit is ready to record.



5 Play the source device.

6 Press ► on the record deck. Alternatively, press CD-R/RW/SEL and then ► on the remote control.

"RECORD" will stop flashing and the recording will be started.

To stop the recording

Press ■ on the record deck.

Alternatively, press CD-R/RW/SEL and then ■ on the remote control.

"BUSY" and "UPDATE" will be displayed briefly.

To pause the recording

Press || on the record deck.

Alternatively, press CD-R/RW/SEL and then || on the remote control.

To resume recording, press ► on the record deck.

Alternatively, press CD-R/RW/SEL and then ► on the remote control.

To play other machines

As with all recorded CD-R/RW discs, the disc must be finalized before it can be played in other machines. See page 18 for details.

When making a digital recording from a DVD player.

- From the DVD player, select "linear PCM" as audio output. Compressed digital signals, such as "DTS bit stream" or "Dolby Digital bit stream" cannot be used. Read and follow the manual attached to your DVD player about how to change the setting of audio output.
- Some DVD discs contain copy-prohibit signals. In such case, you can copy the disc by using an analog input.

NOTE

- It is possible to listen to the sound while recording by selecting the appropriate input on your receiver, preamp or processor.

NUMBERING TRACKS

The track numbers may be added automatically (auto mode) or manually (manual mode).

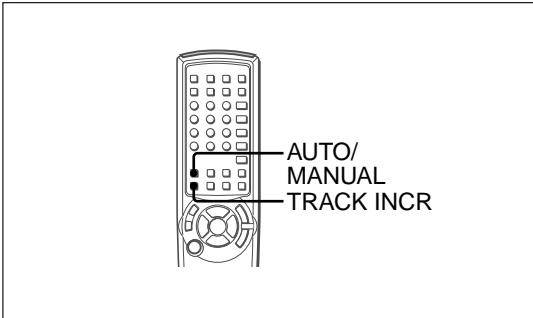

Auto mode

Auto mode can be used with either digital or analog recording.

The auto mode will add track numbers automatically, in one of two ways.

- When track data is present from a digital recording, it will be carried over to the new copy disc.
- In the auto mode for recordings from an analog source or a digital source with no track data, the track number will be increased when the unit receives silence for 3 seconds. The unit will also go into the pause mode until the input source resumes.

Manual mode

For digital or analog recordings, the track numbers may be added at any time by pressing **TRACK INCR** on the remote control.

To switch the numbering mode

Press **AUTO/MANUAL** repeatedly. When auto mode is selected, "AUTO" lights.



"AUTO" lights

FINALIZATION

Finalization completes the recording of a disc so that it can be played in other machines.

Precautions

- Once a CD-R disc is finalized, the disc cannot be unfinalized.
- A CD-RW disc can be unfinalized.
- During the finalization process, never switch the power off, or the disc may be damaged.
- Once started, the finalization process cannot be aborted.
- Dust or scratches on a disc may prevent it from being finalized successfully.
- The finalization process time depends on the disc and number of tracks.
- During the finalization process the record deck will not accept any operating commands.

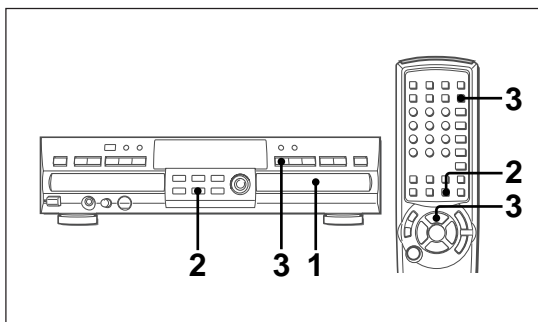

- 1 Load the CD-R/RW disc on the record tray.
- 2 Press **FINALIZE** on the front panel or remote control.
"FINALIZE" will begin flashing.



- 3 Within 3 seconds, press **▶** on the record deck.
Alternatively, press **CD-R/RW/SEL** and then **▶** on the remote control.
"FINALIZE" will stop flashing and remain lit.

 - The finalization process will take between 60 and 90 seconds, depending on the length of material recorded on the disc.
 - During the finalization process the record deck will not accept any operating commands.

When the finalization process is complete "FINALIZE" will go out, and "CD" will light as an indication that the disc is now playable on other players.

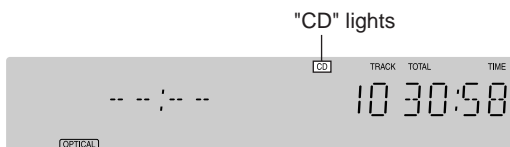

UNFINALIZATION

To keep the material that is already recorded on a CD-RW disc and to add an additional track and erase an individual track, you must first unfinalize the disc.

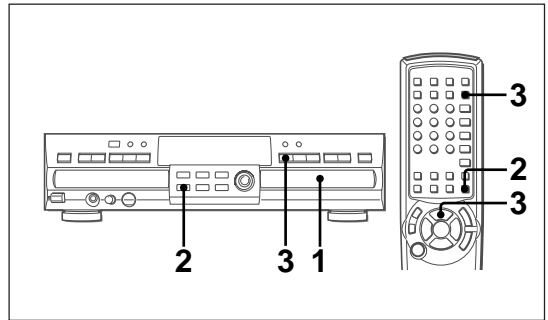

- 1 Load the CD-RW disc on the record tray.
- 2 Press **ERASE** on the front panel or remote control repeatedly until "TOC" is displayed.
"ERASE" will begin flashing.

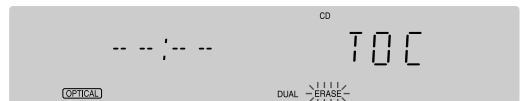

- 3 Within 3 seconds, press **▶** on the record deck.
Alternatively, press **CD-R/RW/SEL** and then **▶** on the remote control.
"ERASE" will stop flashing and remain lit.
When the unfinalization process is complete, "ERASE" will go out, and "CD-RW" will light.

ERASING AN ENTIRE CD-RW DISC

An entire disc erase is available for both finalized and non-finalized CD-RW disc.

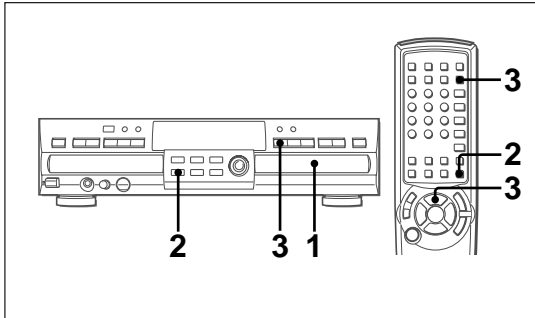

- 1 Load the CD-RW disc to be erased on the record tray.
- 2 Press ERASE on the front panel or remote control repeatedly until "DISC" is displayed. "ERASE" will begin flashing.



- 3 Within 3 seconds, press ► on the record deck. Alternatively, press CD-R/RW/SEL and then ► on the remote control. "ERASE" will stop flashing and remain lit. After the erasure process, "00 00:00" is displayed and "ERASE" goes out.

ERASING INDIVIDUAL TRACKS

- One or more individual tracks on a CD-RW disc may be erased at a time, starting with the last track on the disc.
- Individual track erase is available only for a non-finalized CD-RW disc. If you want to erase a track in a finalized CD-RW disc, the disc has to be unfinalized first.

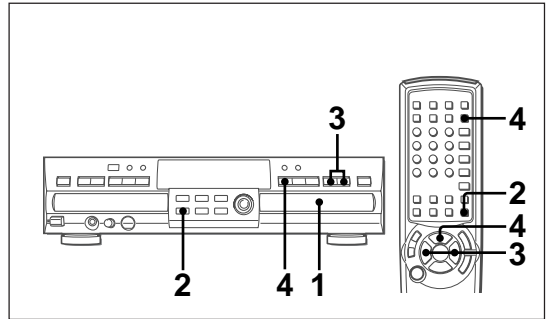

- 1 Load the CD-RW disc to be erased on the record tray.
- 2 Press ERASE on the front panel or remote control repeatedly until "01 TRK" is displayed. "ERASE" will begin flashing.



- 3 Within 3 seconds, press ◀◀ or ▶▶ on the record deck or remote control until the number of tracks to be erased is displayed. For example, when "06 TRK" is displayed a total of six tracks will be erased, counting back from the last track on the disc.



- 4 Within 3 seconds, press ► on the record deck. Alternatively, press CD-R/RW/SEL and then ► on the remote control. After the erasing process, "ERASE" will go out and the total number of tracks will be displayed.

Note

The time it takes to complete the erasing process varies from one disc to another.

En

PLAYBACK

BASIC OPERATION

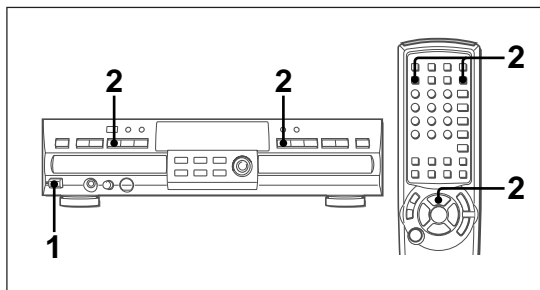

1 Turn on the power and load a disc.

See page 12 for details.

- 2 Press **▶** on the front panel for the appropriate deck.
Alternatively, press **CD/SEL** or **CD-R/RW/SEL** for the desired deck and then **▶** on the remote control.

"▶" will appear and the track number being played and the running time of the track will be displayed.



Track number being played

Elapsed time of the current track

When there is a disc in each deck

The player will respond in one of two ways depending on whether the dual play setting is activated or not. See page 23 for details.

In normal mode (single play mode)

When the disc in one deck finishes, the disc in the other deck will begin to play.

In dual mode

Each deck will operate as a separate, single play CD unit without regard to the status of the other deck.

When "DISC ERROR" is displayed

Non-finalized CD-R/RW discs will not play in the play deck. Play the disc in the record deck.

To stop playback

Press **■** on the front panel for the appropriate deck. Alternatively press **CD/SEL** or **CD-R/RW/SEL** for the desired deck and then **■** on the remote control.

To pause playback

Press **||** on the front panel for the appropriate deck. Alternatively press **CD/SEL** or **CD-R/RW/SEL** for the desired deck and then **||** on the remote control. Press either **▶** or **||** to resume playback.

To skip the track

To skip forward to other tracks during playback, pause or stop, press **▶▶** on the front panel as many times as necessary, or press **CD/SEL** or **CD-R/RW/SEL** on the remote control for the desired deck and then press **▶▶**. To skip backward, use **◀◀**.

To search the track

To move forward through the disc, press and hold **▶▶** on the front panel, or press **CD/SEL** or **CD-R/RW/SEL** on the remote control for the desired deck and then press and hold **▶▶**.

To move backward, use **◀◀** on the front panel or **◀◀** on the remote control.

Playing a specific track (Direct play)

To go directly to a specific track on a disc, enter the track number using the numbered buttons.

When selecting a two digit track number, the second number must be entered within 10 seconds after the first number pressed.

RANDOM PLAYBACK

All of the tracks can be played in random order.

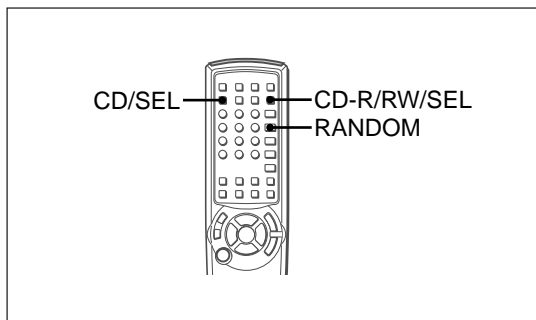

In stop mode or during playback, press **CD/SEL** or **CD-R/RW/SEL** for the desired deck, and then press **RANDOM**.

"RANDOM" will light.



"RANDOM" lights

- When **RANDOM** is pressed in stop mode, random playback will start automatically.
- Each track will be played in a random order until all tracks on the disc have been played.
- During the search, a clockwise circle is displayed to confirm the search.

To resume normal play

Press **RANDOM** again.

REPEAT PLAYBACK

One or all the tracks can be played repeatedly.

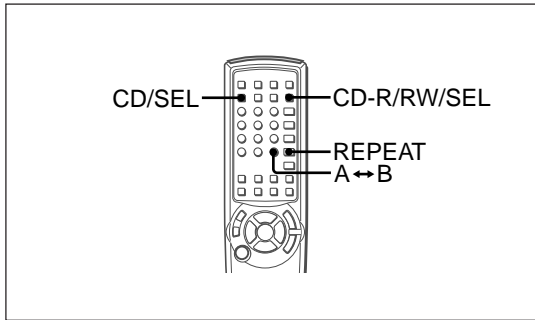

Repeat playback

During playback, press **CD/SEL** or **CD-R/RW/SEL** for the desired deck, and then press **REPEAT** repeatedly to display "REPEAT 1" or "REPEAT ALL".

To repeat the current track only, select "REPEAT 1".
To repeat all the tracks, select "REPEAT ALL".



"REPEAT 1" or "REPEAT ALL" lights

- If the track is changed by using **◀◀/▶▶** while the REPEAT 1 mode is active, the new track will now be repeated.
- In the REPEAT ALL mode, the disc will play from beginning to end continually, until **■** button is pressed.

To resume normal play

Press **REPEAT** repeatedly until "REPEAT 1" or "REPEAT ALL" goes out on the information display.

A-B repeat playback

- 1 During playback, press **CD SEL** or **CD-R/RW/SEL** for the desired deck, and then press **A ↔ B** at the starting point of the portion you want to repeat.

"REPEAT" and "A-" will flash.



"REPEAT A-" flashes

- 2 Press **A ↔ B** again at the ending point of the portion you want to repeat.

"REPEAT" and "A-B" will light.



"REPEAT A-B" lights

To resume normal play

Press **A ↔ B** again.

PROGRAMMED PLAYBACK

- You can program up to 20 tracks and play them in any order.
- You can program tracks only in stop mode.

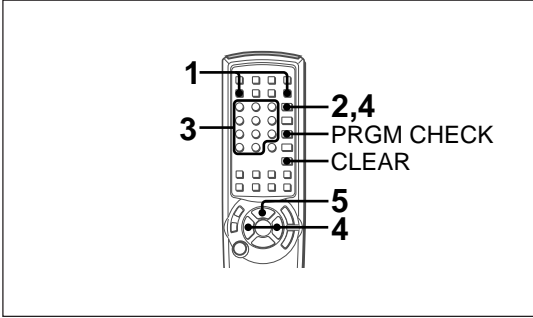

1 In stop mode, press CD/SEL or CD-R/RW/SEL for the desired deck.

2 Press PRGM.

"PROG" will light and "00 00:00" will be displayed.



"PROG" lights

3 Press the numbered button to program a track.

When selecting a two digit track number, the second number must be entered within 10 seconds after the first number pressed.

As each track is entered, the display will flash three times, alternating between two displays.



Programed track number

Program number



Last track programmed

Total playing time of programmed tracks

4 Repeat step 3 to program other tracks.

- Tracks may also be added using **◀◀** and **▶▶** to locate the track, and the **PRGM** to enter that track to the programmed sequence.

5 Press **▶** to start programmed playback.

The program will remain in the unit's memory until the disc is removed or the unit is turned off.

To check the program

To scroll through a program list, press **PRGM CHECK** repeatedly. Each press of the button will move through the tracks that have been programmed.

To add a new track

1 Press **PRGM CHECK** repeatedly until "00" is displayed.



2 Press a numbered button to add a new track.

To delete a track in the program

1 Press **PRGM CHECK** repeatedly to select the track you wish to delete.

2 Press **CLEAR**.

The selected track will be deleted and programmed tracks with higher numbers are decreased by one.

To change the program

1 Press **PRGM CHECK** repeatedly to select the track you wish to change.

2 Press the numbered button.

To clear the program

Press PRGM while the program is playing.

"PROG" will go out on the information display.

In stop mode, simply open and close the disc tray. Whenever a disc is removed or the unit is turned off, the program is cleared.

DUAL PLAY MODE

- You may play a different disc in both decks at the same time.
- The output of each deck will be sent to the appropriate output jacks.
- You may use the output of one deck to feed your main room system, while the second deck is used to feed a remote room.

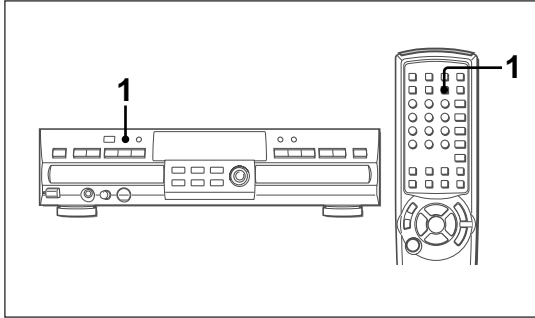

- To select dual mode, press DUAL on the front panel or remote control.**
"DUAL" will light.



"DUAL" lights

- Select the deck you wish to listen by using the input selectors on your receiver, preamp or processor.**

To return to single play mode

Press **SINGLE** on the remote control or **DUAL** on the front panel.

NOTE

Pressing **SINGLE** on the remote control or **DUAL** on the front panel while both decks are playing, will automatically stop playback of the disc in the record deck while the disc in the play deck continues to play.

CHANGING THE TIME DISPLAY MODE

Various information about the contents of a CD can be displayed on the information display.

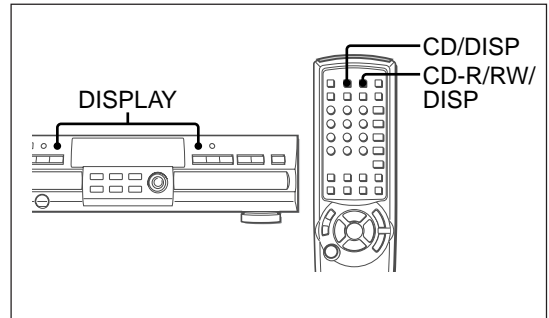

In stop mode

The total number of tracks and the total time of all tracks will be displayed.



Total number of tracks Total time of all tracks

During playback

Press appropriate **DISPLAY** on the front panel or press **CD/DISP** or **CD-R/RW/DISP** on the remote control repeatedly to change the time display as follows:



Track number being played Elapsed time of the current track



Track number being played Remaining time of the current track



Track number being played Total remaining time on disc

En

TROUBLESHOOTING

| SYMPTOM | POSSIBLE CAUSE | SOLUTION |
|--|---------------------------------|--|
| The unit does not operate when POWER on the front panel is pressed. | No AC power | Make sure AC power cord is plugged into an AC outlet. |
| Remote control does not function. | Wrong deck selected. | Press CD/SEL to control the play deck; press CD-R/RW/SEL to control the record deck. |
| | Sensor blocked | Remove obstructions from front panel. |
| | Dead batteries | Replace both batteries. |
| Disc cannot be erased. | CD-R disc is in use. | CD-R discs are not erasable. Use CD-RW discs. |
| Recorded CD-R/RW disc does not play in another CD player or "DISC ERROR" appears in play deck display. | CD-R/RW disc not finalized. | Finalize the CD-R/RW disc in the unit's record deck. (see page 18) |
| Recording suddenly stops. | Input source stopped or paused. | Recordings will always stop when the input source is paused for more than 3 seconds for digital recordings and 10 seconds for analog recordings. |

ALERT MESSAGES

| ERROR MESSAGE | EXPLANATION AND PROBABLE CAUSE | SOLUTION |
|---------------|--|--|
| CHECK DISC | A record-related button has been pressed when a finalized disc is in the record deck. | Unfinalize the disc to add tracks to a CD-RW disc. |
| | A record-related button has been pressed when a standard CD is in the record deck. | Replace the disc with a blank CD-R/RW disc. |
| DATA DISC | A non-audio CD-ROM or a Video CD disc has been placed in the unit. | Only audio CD discs will play in the unit; replace the disc. |
| DISC ERROR | A non-finalized disc has been placed in the play deck. | Finalize the disc. |
| | <ul style="list-style-type: none"> • A DVD disc has been placed in the unit. • This unit does not play or dub DVD discs. | Replace the disc. |
| DISC FULL | There is not enough time left on the disc to complete a planned recording. | <ul style="list-style-type: none"> • Use another blank CD-R/RW disc. • Erase one or more tracks on a CD-RW disc. |
| ERROR | The disc is not loaded properly. | Open the tray and check to see that the disc is properly loaded. |
| | There is a problem with the disc. | Try another disc. |
| FAILED | A dubbing has not been completed properly. | <ul style="list-style-type: none"> • Check the play disc. • Repeat the dubbing process. |
| FULL | Trying to program 21st track. | Up to 20 tracks can be programmed in this unit. |
| NO AUDIO | A record-related button has been pressed when a non-audio disc is in the record tray. | Replace the disc with a blank CD-R/RW Audio disc. |

En

RESTRICTIONS ON DIGITAL RECORDING

The Serial Copy Management System (SCMS) is implemented in this unit to protect the rights of copyright holders. SCMS allows you to make a 'first-generation' digital copy—a digital copy of the original source—but not a copy of this copy.

The SCMS copy restriction does not apply to analog recordings.

Recording from digital sources with copy prohibition code

Copyrighted CDs or copyright protected digital sources

Digital input ↓ OK

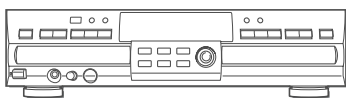

(First generation copy)

Digital input ↓ NO

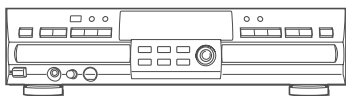

(Second generation copy)

Copying a disc recorded from analog sources

Any analog source

Analog input ↓ OK

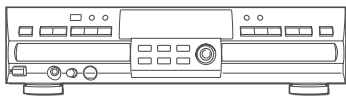

Digital input ↓ OK

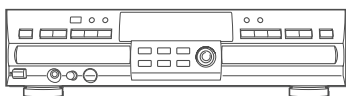

(First generation copy)

Digital input ↓ NO

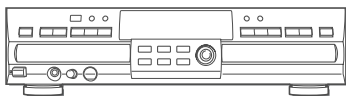

(Second generation copy)

SPECIFICATIONS

| | |
|---|--|
| Discs supported | CD/CD-R/CD-RW for digital audio |
| Frequency response | 2 Hz to 20 kHz |
| Playback signal-to-noise ratio | 105 dB |
| Playback total harmonic distortion | 0.005% / -88 dB |
| Digital input sampling frequency range | 32 to 96 kHz (sampling rate conversion) |
| Digital input format | IEC60958 |
| Recording format | 16 bits, 44.1 kHz |
| Analog in | RCA |
| Analog out | RCA |
| Digital in | Optical, Coaxial |
| Digital out | Optical, Coaxial |
| Power supply | 120 V AC, 60 Hz |
| Power consumption | 28 W |
| Dimensions (W × H × D) | 430 × 112 × 363 mm (17.0 × 4.4 × 14.2 in.) |
| Weight | 5.1 kg (11.3 lbs) |

Specifications and external appearance are subject to change without notice.

COPYRIGHT

Please check the laws on copyright relating to recordings from discs, radio or external tapes for the country in which the unit is being used.

For assistance and information

call toll free 1-800-BUY-AIWA (United States and Puerto Rico)

Printed in Korea

AIWA CO.,LTD.

CORRECTION**English**

Please read the incorrect descriptions in the Operating Instructions as follows

Page 7**10 10 OVER**

Never lights

Step 1 on Page 16 (MANUAL RECORDING)

When recording level is adjusted too high, the red segments of the level indicator are always lit

CORRECCIÓN**Español**

Le rogamos que lea las descripciones incorrectas del Manual de instrucciones de este modo

Página 7**10 10 OVER**

Nunca se enciende

Paso 1 de la página 16 (GRABACIÓN MANUAL)

Cuando el nivel de grabación esté demasiado alto, los segmentos rojos del indicador de nivel siempre estarán iluminados

CORRECTION**Français**

Veuillez noter les descriptions erronées dans le Mode d'emploi qui suit

Page 7**10 10 OVER**

Ne s'allume jamais

Etape 1 page 16 (ENREGISTREMENT MANUEL)

Si vous réglez le niveau d'enregistrement à une fréquence trop élevée, les segments rouges de l'indicateur de niveau d'enregistrement sont toujours allumés

PRODUCT REGISTRATION CARD

Complete the attached registration card and return today to receive these 3 important benefits:

▶ **Confirm Your Warranty:**

Your prompt product registration confirms your right to the protection available under the terms and conditions of your Aiwa warranty.

▶ **Protect Your Product:**

We will keep the model number and date of purchase of your new Aiwa product on file to help you refer to this information when necessary.

▶ **Register Your Purchase:**

Thank you for purchasing our product. Filling out the attached card is the only way of ensuring that we contact you in the event of any product issues that may arise.

aiwa

Please **do not** send product or other correspondence to this address

244D

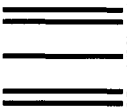

Please
Place
First-Class
Stamp
Here

aiwa

AUDIO/VIDEO REGISTRATION DEPARTMENT
PO BOX 44067
DENVER CO 80201-4067



For Technical Assistance or for further AIWA information, please call 1-800-BUY-AIWA. Visit us on the Internet at www.aiwa.com

AIWA AMERICA INC. ("AIWA") warrants to the original consumer purchaser that this product is free of defects in material and workmanship at the time of purchase.

WARRANTY PERIODS

During the applicable LABOR warranty period, AIWA will pay labor and service charges for the repair of defects or, at its option, will replace a defective product with a new or remanufactured equivalent product. During the applicable PARTS warranty period, AIWA will supply at no charge new or rebuilt replacement parts in exchange for defective parts. However, after the LABOR warranty period, all labor and service charges are your responsibility. Replacement parts are warranted for the remainder of the original PARTS warranty period.

The LABOR and PARTS warranty periods for your product are listed below. **All warranty periods commence with the purchase date.**

| | LABOR | PARTS |
|-------------------------|---------|---------|
| VCR/TV21" and below | 90 days | 1 year |
| Home Audio/TV above 21" | 1 year | 1 year |
| CRT | 2 years | 2 years |

WHO PERFORMS AIWA'S WARRANTY?

AIWA's warranty obligations must be performed by an AIWA Authorized Service Center. For the name of the AIWA Authorized Service Center nearest to you call toll free 1-800-289-2492 (1-800-BUY-AIWA).

WHAT YOU MUST DO

To obtain warranty performance, you must take the product, or deliver the product freight prepaid, to an AIWA Authorized Service Center. If shipped, the product must be packaged so that it is protected from possible shipping damage. You must pick up the product when warranty performance is completed or, if you choose, and the product was received by the Service Center during the LABOR warranty period, the repaired product will be returned to you freight prepaid. You must present to the Service Center, or include with your shipment, a dealer's bill of sale, or other original evidence, showing the date and place of purchase and describing the product purchased. Be sure to include your return address and daytime telephone number where you can be reached should the need arise.

WHAT THE WARRANTY DOES NOT COVER

This warranty does not cover (1) products purchased outside of the U.S.A., Puerto Rico or the U.S. Virgin Islands; (2) product set-up, adjustment of controls, repair of antenna systems outside the unit; (3) removal or reinstallation, batteries, carrying case, AC adapters and other accessories packaged with the product; (4) defects occurring after purchase due to repair or service other than by an AIWA Authorized Service Center, product modification, accident, misuse, abuse, or negligence; or (5) reception problems caused by signal conditions, or cable or antenna systems outside the unit. This warranty will not apply if the serial number of the unit has been altered or removed.

REPAIR OR REPLACEMENT AS PROVIDED IN THIS WARRANTY IS THE PURCHASER'S EXCLUSIVE WARRANTY REMEDY. IMPLIED WARRANTIES, INCLUDING THE WARRANTIES OF MERCHANTABILITY AND OF FITNESS FOR A PARTICULAR PURPOSE, SHALL NOT EXTEND BEYOND THE DURATION OF THE APPLICABLE PARTS WARRANTY PERIOD. IN NO EVENT SHALL AIWA BE LIABLE FOR INCIDENTAL OR CONSEQUENTIAL DAMAGES IN CONNECTION WITH THIS PRODUCT. Some states do not allow limitations on how long an implied warranty lasts or the exclusion or limitation of incidental or consequential damages, so the above limitations or exclusion may not apply to you. This warranty gives you specific legal rights, and you may also have other rights which may vary from state to state.

PRODUCT REGISTRATION

Although not required for warranty coverage, we urge you to return the attached Product Registration Card. The Product Registration Card will provide us with valuable marketing data and will enable AIWA to contact you should it ever be required.

IF YOU NEED HELP: Your AIWA Authorized Service Center should answer all of your warranty questions, or write to the AIWA Product Services Department, AIWA America, Inc., 800 Corporate Drive, Mahwah, New Jersey 07430-2048.

PLEASE CUT ALONG DOTTED LINE AND KEEP THIS PORTION FOR YOUR RECORDS)

IMPORTANT! Please fill out and return within the next 10 days!

aiwa

244D

1. Mr. 2. Mrs. 3. Ms. 4. Miss

First Name: _____ Initial: _____ Last Name: _____

Address: (Number and Street) _____ Apt #: _____

City: _____ State: _____ Zip Code: _____

2 E-Mail Address: _____ (Example: kaimathi@aol.com)

3 Phone #: _____ 4 Date of Purchase: _____

5 Model Purchased: _____ (EXAMPLE: NSXA72)

6 Serial Number: _____ 7 Purchase Price: _____

8 Store Name: _____ \$ _____ .00 (EXCLUDING TAX)

9 Is this: (Check all that apply) 14 Date of Your birth: _____

- 1. A first time purchase of this product type?
- 2. A replacement purchase of this product type?
- 3. An additional purchase of this product type?
- 4. A gift for you or someone else?

10 What three (3) factors most influenced your purchase of this Aiwa product?

- 1. Size
- 2. Special Features
- 3. Price/Value
- 4. Quality
- 5. Aiwa Reputation
- 6. Magazine/Newspaper Article
- 7. Previous Aiwa Experience
- 8. Friend/Relative Recommendation
- 9. Salesperson Recommendation
- 10. Other _____

11 What other brands did you consider?

- 1. RCA
- 2. Pioneer
- 3. Sony
- 4. Panasonic
- 5. Sanyo
- 6. Fisher
- 7. JVC
- 8. Kenwood
- 9. Sharp
- 10. Other _____

12 Do you own a personal computer?

- 1. Yes
- 2. No

13 Which of the following products do you own or plan to purchase?

| | Own | Plan to Buy |
|----------------------------------|-----------------------------|-----------------------------|
| 1. Head Phones | 1. <input type="checkbox"/> | 2. <input type="checkbox"/> |
| 2. Portable CD Player | 1. <input type="checkbox"/> | 2. <input type="checkbox"/> |
| 3. Portable Cassette Player | 1. <input type="checkbox"/> | 2. <input type="checkbox"/> |
| 4. Mini Audio System | 1. <input type="checkbox"/> | 2. <input type="checkbox"/> |
| 5. Multi Media Computer Speakers | 1. <input type="checkbox"/> | 2. <input type="checkbox"/> |
| 6. VCR | 1. <input type="checkbox"/> | 2. <input type="checkbox"/> |
| 7. DVD | 1. <input type="checkbox"/> | 2. <input type="checkbox"/> |
| 8. Home Theater System | 1. <input type="checkbox"/> | 2. <input type="checkbox"/> |
| 9. TV | 1. <input type="checkbox"/> | 2. <input type="checkbox"/> |
| 10. Subwoofer | 1. <input type="checkbox"/> | 2. <input type="checkbox"/> |

15 Marital Status: 1. Married 2. Single

16 For your primary residence, do you: 1. Own? 2. Rent?

17 Education (Check which category applies): 1. High School 3. Completed College
2. Some College 4. Graduate School

18 Which best describes your family income? 1. Under \$15,000 5. \$50,000-\$74,999
2. \$15,000-\$24,999 6. \$75,000-\$99,999
3. \$25,000-\$34,999 7. \$100,000-\$149,999
4. \$35,000-\$49,999 8. Over \$150,000

19 Including yourself, what is the total number of people living in your household? (EXAMPLES: 01, 02, 03, 04....)

20 NOT including yourself, what are the AGES of any other people living in your household? Age (in years)

Male: _____ Female: _____

21 In the last six (6) months have you or your spouse:

- 1. Purchased clothes through the mail?
- 2. Purchased gifts through the mail?
- 3. Worked in your garden?
- 4. Traveled on vacation?
- 5. Purchased a PC or PC software?
- 6. Purchased two or more books?
- 7. Purchased cassettes/CDs?
- 8. Donated to wildlife/environmental causes?
- 9. Donated to charities?

Thank you for filling out this questionnaire. Your answers are important to us. Please check here [] if you would prefer not to participate in additional market research for Aiwa or obtain information on new and interesting opportunities from other exciting companies.

Free Manuals Download Website

<http://myh66.com>

<http://usermanuals.us>

<http://www.somanuals.com>

<http://www.4manuals.cc>

<http://www.manual-lib.com>

<http://www.404manual.com>

<http://www.luxmanual.com>

<http://aubethermostatmanual.com>

Golf course search by state

<http://golfingnear.com>

Email search by domain

<http://emailbydomain.com>

Auto manuals search

<http://auto.somanuals.com>

TV manuals search

<http://tv.somanuals.com>