

AT-2711 Series Adapters

Fiber Fast Ethernet Adapters

- ❑ AT-2711FX/SC
- ❑ AT-2711FX/LC
- ❑ AT-2711FX/ST
- ❑ AT-2711FX/MT
- ❑ AT-2711LX/SC
- ❑ AT-2711LX/LC

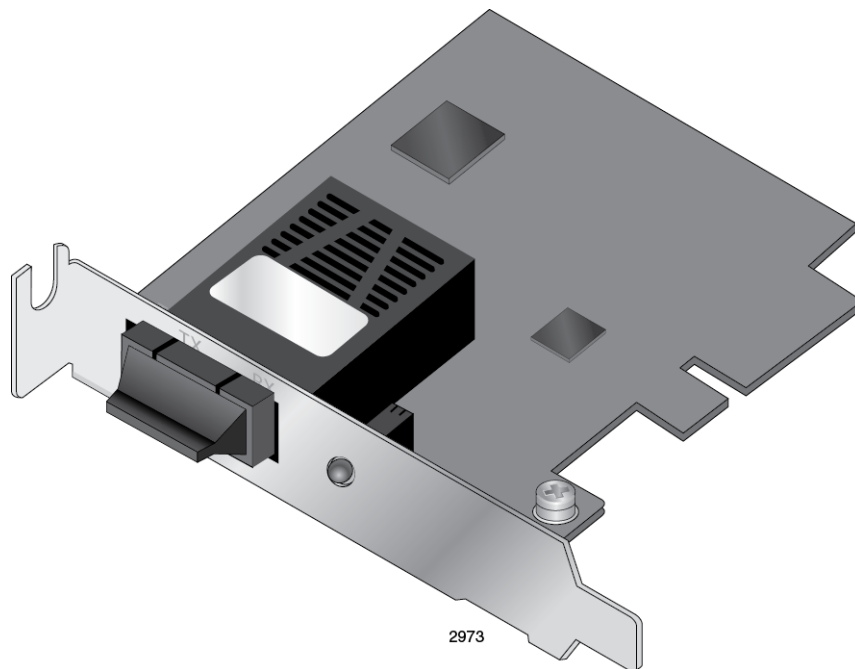

Installation and User's Guide

Copyright © 2013 Allied Telesis, Inc.

All rights reserved. No part of this publication may be reproduced without prior written permission from Allied Telesis, Inc. Microsoft and Internet Explorer are registered trademarks of Microsoft Corporation. Netscape Navigator is a registered trademark of Netscape Communications Corporation. All other product names, company names, logos or other designations mentioned herein are trademarks or registered trademarks of their respective owners.

Allied Telesis, Inc. reserves the right to make changes in specifications and other information contained in this document without prior written notice. The information provided herein is subject to change without notice. In no event shall Allied Telesis, Inc. be liable for any incidental, special, indirect, or consequential damages whatsoever, including but not limited to lost profits, arising out of or related to this manual or the information contained herein, even if Allied Telesis, Inc. has been advised of, known, or should have known, the possibility of such damages.

Electrical Safety and Emissions Standards

This product meets the following standards:

U.S. Federal Communications Commission	
Declaration of Conformity	
Manufacturer Name: Allied Telesis, Inc.	
Declares that the product: Fiber Fast Ethernet Adapter	
Model Numbers: AT-2711FX/SC, AT-2711FX/LC, AT-2711FX/ST, AT-2711FX/MT, AT-2711LX/SC, AT-2711LX/LC	
This product complies with FCC Part 15B, Class B Limits:	
This device complies with part 15 of the FCC Rules. Operation is subject to the following two conditions: (1) This device must not cause harmful interference, and (2) this device must accept any interference received, including interference that may cause undesired operation.	
Radiated Energy	
Note: This equipment has been tested and found to comply with the limits for a Class B digital device pursuant to Part 15 of FCC Rules. These limits are designed to provide reasonable protection against harmful interference in a residential installation. This equipment generates, uses and can radiate radio frequency energy and, if not installed and used in accordance with instructions, may cause harmful interference to radio or television reception, which can be determined by turning the equipment off and on. The user is encouraged to try to correct the interference by one or more of the following measures:	
<ul style="list-style-type: none"> - Reorient or relocate the receiving antenna. - Increase the separation between the equipment and the receiver. - Connect the equipment into an outlet on a circuit different from that to which the receiver is connected. - Consult the dealer or an experienced radio/TV technician for help. 	
Changes and modifications not expressly approved by the manufacturer or registrant of this equipment can void your authority to operate this equipment under Federal Communications Commission rules.	

Industry Canada	
This Class B digital apparatus complies with Canadian ICES-003.	
Cet appareil numérique de la classe B est conforme à la norme NMB-003 du Canada.	

European Union Restriction of the Use of Certain Hazardous Substances (RoHS) in Electrical and Electronic Equipment	
This Allied Telesis RoHS-compliant product conforms to the European Union Restriction of the Use of Certain Hazardous Substances (RoHS) in Electrical and Electronic Equipment. Allied Telesis ensures RoHS conformance by requiring supplier Declarations of Conformity, monitoring incoming materials, and maintaining manufacturing process controls.	

RFI Emissions	FCC Class B, EN55022 Class B, VCCI Class B, C-TICK, CE
Immunity	EN55024 Class B
Electrical Safety	EN60950-1 (TUV), UL 60950-1 (cUL _{US})



Laser Safety EN60825

Translated Safety Statements

Important: The  indicates that a translation of the safety statement is available in a PDF document titled “Translated Safety Statements” posted on the Allied Telesis website at: www.alliedtelesis.com/support/.

Contents

Preface	9
Safety Symbols Used in this Document	10
Contacting Allied Telesis	11
Chapter 1: Overview	13
Description	14
SC Fiber Optic Adapter	14
LC Fiber Optic Adapter	15
ST Fiber Optic Adapter	15
MT Fiber Optic Adapter	15
LED	16
Features	17
Supported Operating Systems	18
Windows Driver	18
Linux Driver	18
NDIS2 Driver Software for MS-DOS Platforms	18
Program Utilities	19
Accessing Documents	20
Allied Telesis Documents	20
Broadcom Document	20
Contents of Your Shipment	21
Warranty Registration	22
Chapter 2: Installing the Hardware	23
System Requirements	24
Reviewing Safety Precautions	25
Pre-Installation Checklist	27
Replacing the Bracket	28
Installing a Network Adapter Card	30
Connecting the Network Cables	34
Chapter 3: Installing the Driver Software for Windows Systems	35
Overview	36
Guidelines	36
Installing the Driver Using Device Manager	36
Installing the Driver Using the Silent Installation Method	36
Downloading the Driver Software	37
Accessing the Device Manager	39
Accessing Device Manager on Windows Server 2012 or Windows 8	39
Accessing Device Manager on Windows Server 2008, Windows Vista, or Windows 7	41
Accessing Device Manager on Windows Server 2003 or Windows XP	42
Installing the Driver Software	44
Installing the Driver Software on Windows Server 2012 or Windows 8	44
Installing the Driver Software on Windows Server 2008, Windows Vista, or Windows 7	47
Installing the Driver Software on Windows Server 2003 or Windows XP	50
Updating the Driver Software	54
Updating the Driver on Windows Server 2012 or Windows 8	54
Updating the Driver on Windows Server 2008, Windows Vista, or Windows 7	56
Updating the Driver on Windows Server 2003 or Windows XP	57
Performing the Silent Installation	59
Installing the Driver Silently	59

Viewing Supported DPInst Options	60
Chapter 4: Configuring the Ethernet Interface for Linux Systems	61
Overview	62
Configuring an Ethernet Interface on Linux Systems.....	63
Configuring an Ethernet Interface on Ubuntu	63
Configuring an Ethernet Interface on Red Hat.....	64
Chapter 5: Modifying Advanced Properties	67
Overview	69
Guidelines.....	69
Supported Advanced Properties.....	70
Windows XP and Server 2003.....	70
Windows Vista and Server 2008.....	71
Windows 7 and Server 2008R2.....	73
Windows 8 and Server 2012	75
Accessing Advanced Properties	76
802.1p QOS.....	78
802.3az EEE.....	79
ARP Offload.....	80
EEE Control Policies.....	81
Ethernet@WireSpeed.....	83
Flow Control.....	84
Interrupt Moderation	86
Checksum Offload	87
IPv4 Checksum Offload	88
Jumbo Mtu	89
Large Send Offload.....	90
Large Send Offload (IPv4).....	91
Large Send Offload v2 (IPv4).....	93
Large Send Offload v2 (IPv6).....	95
Locally Administered Address.....	96
Guidelines for Assigning a Locally Administered Address.....	96
Assigning the Locally Administered Address.....	96
Network Address.....	98
NS Offload	100
Priority & VLAN.....	101
Receive Side Scaling.....	103
Maximum Number of RSS Queues.....	104
RSS Queues.....	105
Speed & Duplex.....	106
TCP/UDP Checksum Offload (IPv4).....	108
TCP/UDP Checksum Offload (IPv6).....	110
VLAN ID.....	112
Wake Up Capabilities.....	113
Wake on Magic Packet	115
Wake on Pattern Match	116
WOL Speed	117
Chapter 6: Uninstalling the Driver Software	119
Overview	120
Guidelines.....	120
Uninstalling the Driver Software Using Device Manager	121
Uninstalling the Driver Software Silently	122
Chapter 7: Troubleshooting	123
Checking the Port LED on the Adapter.....	124
Troubleshooting Checklist.....	125
Testing Network Connectivity	126
Windows	126
Linux	127

Appendix A: Specifications	129
Physical Specifications	129
Environmental Specifications.....	129
Power Specifications	129
Maximum Cabling Distances	129
Appendix B: Cleaning Fiber Optic Connectors	131
Overview.....	132
Guidelines	132
Cleaning Using a Cartridge-Type Cleaner.....	133
Cleaning Using a Swab	135

Preface

This manual is the installation and user's guide for the AT-2711 Series Fiber Fast Ethernet Network Adapter cards. The adapter cards included in this series are:

- ❑ AT-2711FX/SC
- ❑ AT-2711FX/ST
- ❑ AT-2711FX/MT
- ❑ AT-2711FX/LC
- ❑ AT-2711LX/SC
- ❑ AT-2711LX/LC

The Preface contains the following sections:

- ❑ "Safety Symbols Used in this Document" on page 10
- ❑ "Contacting Allied Telesis" on page 11

Safety Symbols Used in this Document

This document uses the following conventions:

Note

Notes provide additional information.



Caution

Cautions inform you that performing or omitting a specific action may result in equipment damage or loss of data.



Warning

Warnings inform you that performing or omitting a specific action may result in bodily injury.



Warning

Warnings inform you that an eye and skin hazard exists due to the presence of a Class 1 laser device.

Contacting Allied Telesis

If you need assistance with this product, you may contact Allied Telesis technical support by going to the Support & Services section of the Allied Telesis web site at **www.alliedtelesis.com/support**. You can find links for the following services on this page:

- ❑ 24/7 Online Support - Enter our interactive support center to search for answers to your questions in our knowledge database, check support tickets, learn about Return Merchandise Authorization (RMA), and contact Allied Telesis technical experts.
- ❑ USA and EMEA phone support - Select the phone number that best fits your location and customer type.
- ❑ Hardware warranty information - Learn about Allied Telesis warranties and register your product online.
- ❑ Replacement Services - Submit an RMA request via our interactive support center.
- ❑ Documentation - View the most recent installation guides, user guides, software release notes, white papers and data sheets for your product.
- ❑ Software Updates - Download the latest software releases for your product.

For sales or corporate contact information, go to **www.alliedtelesis.com/purchase** and select your region.

Chapter 1

Overview

This chapter provides an introduction to the Allied Telesis AT-2711 Series Fiber Fast Ethernet Network Adapter cards and contains the following sections:

- ❑ “Description” on page 14
- ❑ “Features” on page 17
- ❑ “Supported Operating Systems” on page 18
- ❑ “Program Utilities” on page 19
- ❑ “Accessing Documents” on page 20
- ❑ “Contents of Your Shipment” on page 21
- ❑ “Warranty Registration” on page 22

Description

The AT-2711 series adapters are Fiber Fast Ethernet PCI Express (PCIe) cards developed based on Broadcom's BCM57762 chipset. The adapter connects a PCIe compliant server or workstation to a Fast Ethernet network using fiber optic cabling and operates at 100 Mbps full-duplex and half-duplex mode.

The AT-2711 series includes the following models:

- ❑ AT-2711FX/SC
- ❑ AT-2711FX/LC
- ❑ AT-2711FX/ST
- ❑ AT-2711FX/MT
- ❑ AT-2711LX/SC
- ❑ AT-2711LX/LC

The AT-2711FX/SC adapter card is shown in Figure 1.

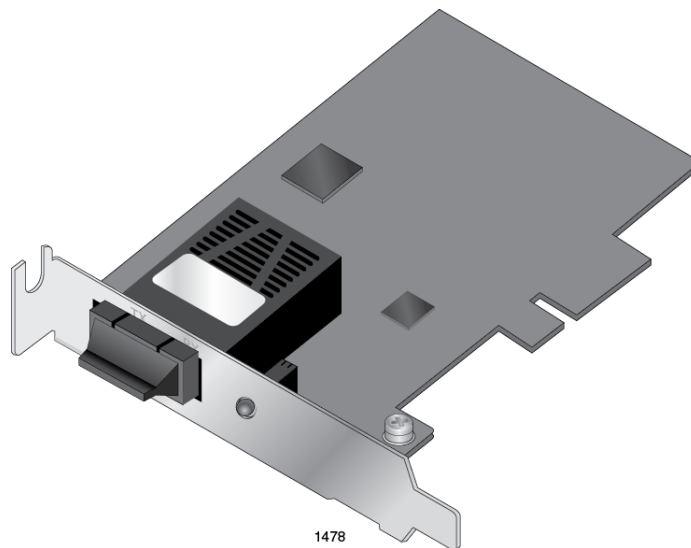

Figure 1. AT-2711FX/SC Adapter

The AT-2711 series adapter cards come with a 100BASE-FX or 100BASE-LX port with an SC, LC, ST, or MT adapter. The LED and software drivers are identical for all adapter models.

SC Fiber Optic Adapter

The AT-2711FX/SC and AT-2711LX/SC adapter cards are equipped with a 100BASE-FX or 100BASE-LX port with the SC adapter for attaching to the SC fiber optic connector.

The SC adapter is shown in Figure 2.

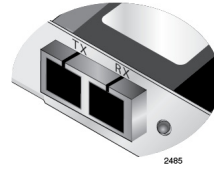

Figure 2. SC Fiber Optic Adapter

To connect the SC adapter to a network cable, you must have a fiber optic network cable with the SC connector.

LC Fiber Optic Adapter

The AT-2711FX/LC and AT-2711LX/LC adapter cards are equipped with a 100BASE-FX or 100BASE-LX port with the LC adapter for attaching to the LC fiber optic connector.

The LC fiber optic adapter is shown in Figure 3.

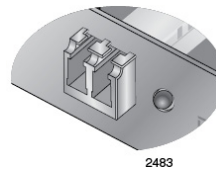

Figure 3. LC Fiber Optic Connector

To connect the LC adapter to a network cable, you must have a fiber optic network cable with the LC connector.

ST Fiber Optic Adapter

The AT-2711FX/ST adapter card is equipped with a 100BASE-FX port with the ST adapter for attaching to the ST fiber optic connector.

To connect the ST adapter to a network cable, you must have a fiber optic network cable with the ST connector.

MT Fiber Optic Adapter

The AT-2711FX/MT adapter card is equipped with a 100BASE-FX port with the MT adapter for attaching to the MT fiber optic connector.

To connect the MT adapter to a network cable, you must have a fiber optic network cable with the MT connector.

LED The adapter card has one LED per model. Table 1 describes the link states that the LED indicates.

Table 1. Fiber LED Status

State	Description
On	Valid link.
Off	No link.
Flashing	The port is receiving or transmitting network packets at 100 Mbps.

Features

The following list shows the features of the AT-2711 series adapter cards:

- One 100BASE-FX or -LX port with SC, LC, ST or MT fiber adapter
- PCI-Express x1 v1.1 interface
- Full/Half duplex MAC
- IPv4 and IPv6 Large Send Offload and Checksum Offload (LSO/TCO)
- Receive Side Scaling (RSS) for multi-core client processors
- Wake on LAN (WOL)
- Statistics for SNMP MIB II, Ethernet-like MIB, and Ethernet MIB (802.3z, Clause 30)
- Flow Control (IEEE 802.3x)
- VLAN Tag support ((802.1Q)
- Ethernet Priority (802.1P)
- Pre-boot Execution Environment (PXE) v2.1
- Audio/Video Bridging (AVB)
- Jumbo Packet
- 40KB Receive Buffer
- 22KB Transmit Buffer
- Link/Activity LED

Supported Operating Systems

The following list shows the supported operating systems for the AT-2711 series adapter cards:

- Windows Server 2012
- Windows 8
- Windows Server 2008 R2
- Windows 7
- Windows Server 2008
- Windows Vista
- Windows Server 2003
- Windows XP
- Linux

Windows Driver

To install driver software for Windows-based operation systems, see Chapter 3, “Installing the Driver Software for Windows Systems” on page 35.

Linux Driver

To install driver software for Linux operation systems, see Chapter 4, “Configuring the Ethernet Interface for Linux Systems” on page 61.

Broadcom also provides the documentation, the *Broadcom NetXtreme® 57XX User Guide*. To view this document, see “Broadcom Document” on page 20.

NDIS2 Driver Software for MS-DOS Platforms

The AT-2711 series adapter cards can be operated on MS-DOS based systems. To install the NDIS2 driver software, see the *Broadcom NetXtreme® 57XX User Guide*. To view the document, see “Broadcom Document” on page 20.

Program Utilities

You can run the following programs on the AT-2711 series adapter cards:

- DOS Diagnostics
- Broadcom Advanced Control Suite

Note

Broadcom provides documentation for these programs. To access the documents, see “Accessing Documents” on page 20.

Accessing Documents

Documents for AT-2711 series adapter cards are available at Allied Telesis websites. Broadcom also provides a document for the network adapters based on their 57XX chipset.

Allied Telesis Documents

To access these documents, do the following:

1. Open a web browser, such as Internet Explorer or FireFox, on your system and enter the following:

<http://www.alliedtelesis.com/>

The Allied Telesis home page is displayed.

2. Enter "2711" in the search box and press the enter key.
3. Select the product model of your AT-2711 series adapter card.

The AT-2711 series adapter page is displayed.

4. Click one of the listed documents.

The content of the document is displayed.

Broadcom Document

To access the *Broadcom NetXtreme® 57XX User Guide*, with a web browser, such as Internet Explorer or FireFox, click the following link:

http://www.broadcom.com/docs/support/ethernet_nic/Broadcom_NetLink-NetXtreme_DTM_15.4.pdf

Contents of Your Shipment

The following items are Included with your adapter card:

Antistatic bag

The antistatic bag protects the adapter card when stored or shipped. Keep the adapter card in its packaging until ready for installation.

Standard-profile bracket

The standard-profile bracket is longer than the low-profile bracket. The AT-2711 series adapter cards are shipped with a low-profile bracket attached.

Note

The AT-2711 series adapter card is not shipped with a software driver CD. You must download the driver software from the Allied Telesis website. See Chapter 3, “Downloading the Driver Software” on page 37.

Inform your network equipment supplier of any missing or damaged items. If you need to return the module, you must pack it in the original (or equivalent) packing material or the warranty will be voided. See “Contacting Allied Telesis” on page 11.

Warranty Registration

Allied Telesis hardware products are covered under limited warranties.

All Allied Telesis warranties are subject to and provided only on the terms and conditions set out in the Allied Telesis Limited Warranties listed on the Allied Telesis website at <http://alliedtelesis.com/support/warranty>.

Chapter 2

Installing the Hardware

This chapter contains the following sections:

- ❑ “System Requirements” on page 24
- ❑ “Reviewing Safety Precautions” on page 25
- ❑ “Pre-Installation Checklist” on page 27
- ❑ “Replacing the Bracket” on page 28
- ❑ “Installing a Network Adapter Card” on page 30
- ❑ “Connecting the Network Cables” on page 34

System Requirements

Before installing the AT-2711 Series Fiber Fast Ethernet Network Adapter cards, make sure your system meets the requirements listed below:

- ❑ PC with one of the following operating systems installed:
 - Windows XP
 - Windows Server 2003
 - Windows Vista
 - Windows Server 2008
 - Windows 7
 - Windows Server 2008 R2
 - Windows 8
 - Windows Server 2012
 - Linux
- ❑ One open PCIe-Ex1 (Express) slot
- ❑ 128 MB RAM (minimum)

Reviewing Safety Precautions

Review the following safety precautions before you begin to install a module.

Note

The  indicates that a translation of the safety statement is available in a PDF document titled “Translated Safety Statements” posted on the Allied Telesis website at www.alliedtelesis.com/support/software/.



Warning

Do not stare into the laser beam.  L2



Warning

This is a “Class 1 LED product”.  L3



Warning

Do not look directly at the fiber optic cable ends or inspect the cable ends with an optical lens.  L6



Warning

Do not work on this equipment or cables during periods of lightning activity.  E2



Warning

Operating Temperature: This product is designed for a maximum ambient temperature of 40 degrees C.  E7

Note

All Countries: Install this product in accordance with local and National Electric Codes.  E8



Warning

The module is being installed in a system that operates with voltages that can be lethal. Before you remove the cover of your system, you must observe the following precautions to protect yourself and to prevent damage to the system components.

- Remove any metallic objects or jewelry from your hands and wrists.
 - Make sure to use only insulated or nonconducting tools.
 - Verify that the system is powered OFF and unplugged before accessing internal components.
 - Installation or removal of modules must be performed in a static-free environment. The use of a properly grounded wrist strap or other personal antistatic devices and an antistatic mat is strongly recommended. ⚡ E39
-

Pre-Installation Checklist

Before installing the AT-2711 series adapter card, check the following list:

1. Check that your computer has an appropriate open PCIe slot.
2. Verify that your system is using the latest BIOS.
3. When you download the driver software from the Allied Telesis website, record the path to where the driver file resides on your system.
4. If your system is active, shut it down.
5. When system shutdown is complete, power OFF and unplug your system.
6. Holding the adapter card by the edges, remove it from its shipping package and place it on an antistatic surface.
7. Check the adapter for visible signs of damage, particularly on the card's edge connector.



Caution

Never attempt to install any damaged adapter card. If the adapter card is damaged, report it to Allied Telesis. See "Contacting Allied Telesis" on page 11.

Replacing the Bracket

The AT-2711 series adapter card is shipped with the low-profile bracket attached to the adapter. Depending on your system, you may need to replace the bracket attached to your adapter card.

The following procedure describes how to remove the low-profile bracket from the adapter card and replace it with the standard bracket. You can also use this procedure to remove the standard bracket and replace it with the low-profile bracket.

To replace the low-profile bracket with the standard bracket, perform the following procedure:

1. Remove the screws that attach the bracket to the adapter card. See Figure 4.

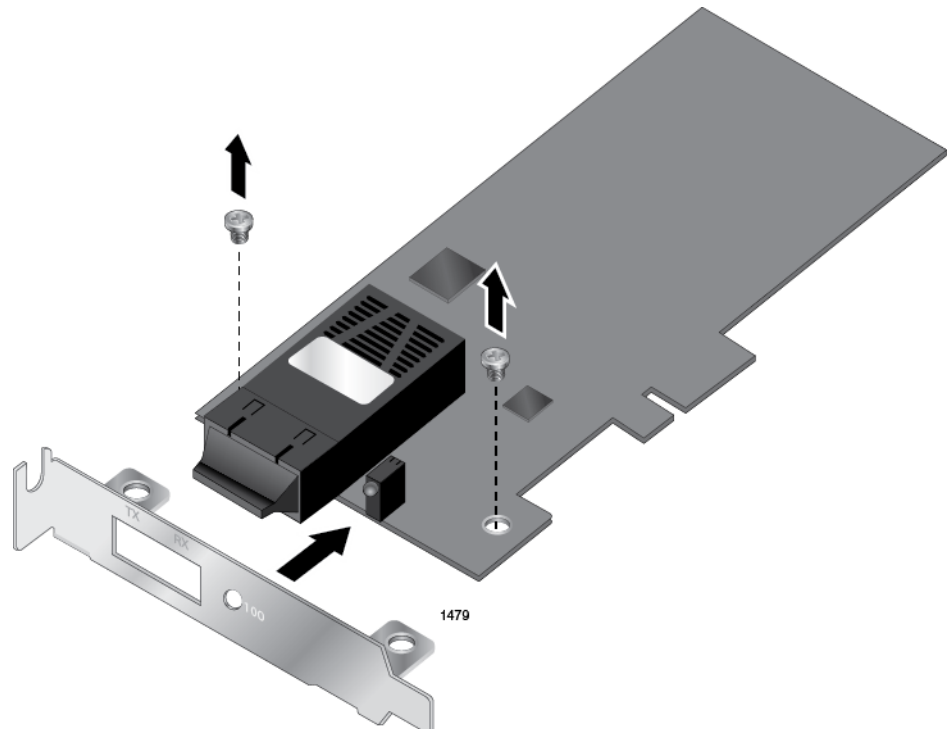

Figure 4. Removing the Low-Profile Bracket

2. Align the tabs of the standard bracket with the holes on the adapter card and fasten the screws onto the adapter card. See Figure 5 on page 29.

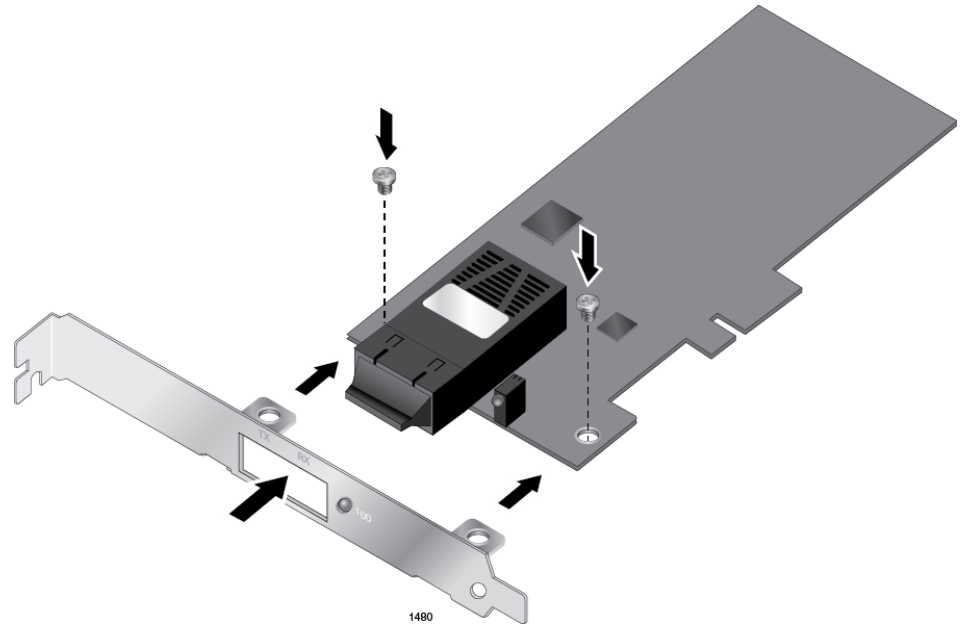

Figure 5. Fastening Screws onto Standard Bracket

Installing a Network Adapter Card

The following instructions apply to installing an AT-2711 series adapter card in most systems. Refer to the manuals that were supplied with your system for details about performing these tasks on your particular system.

To install the network adapter card, perform the following procedure:

1. Review the “Pre-Installation Checklist” on page 27 and “Reviewing Safety Precautions” on page 25.

Before installing the adapter card, ensure the system power is OFF and unplugged from the power outlet, and that proper electrical grounding procedures have been followed.



Warning

High voltage inside the system presents a safety hazard. Make sure the power is off before removing the cover.

2. Remove the system cover and select any empty PCIe slot. See Figure 6.

If you do not know how to identify a PCIe slot, refer to your system documentation.

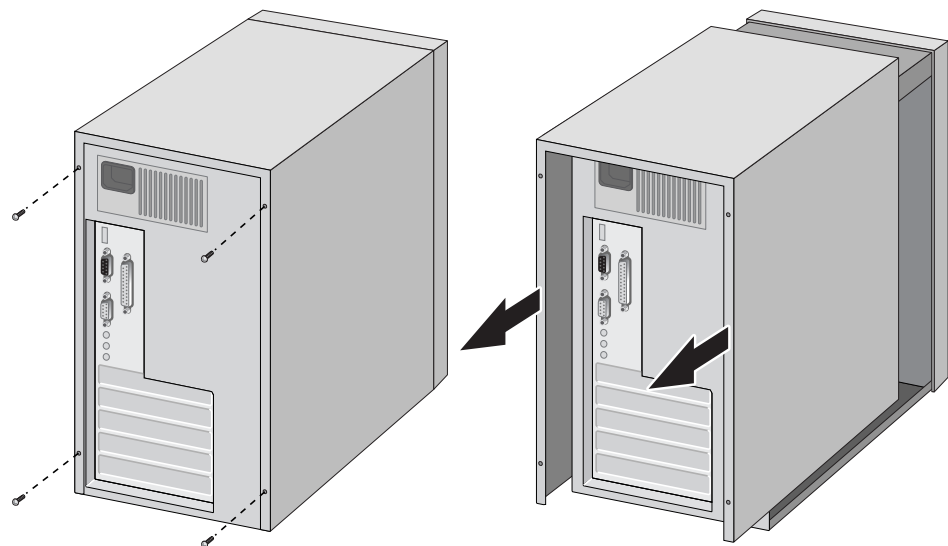

Figure 6. Removing the PC Cover

3. Select an empty, non-shared PCIe slot and remove the faceplate.

Keep the faceplate in a safe place. You may need it for future use. See Figure 7.

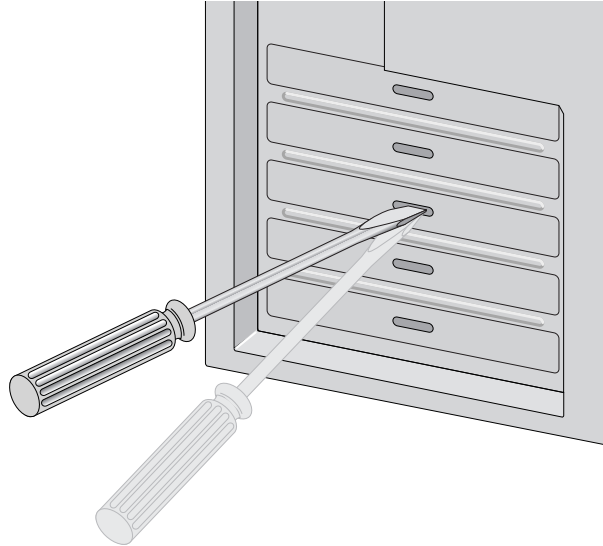

Figure 7. Removing the Faceplate From PCI Slot

Note

If you cannot locate or know how to find an PCIe slot, refer to the documentation that came with your system.

4. Remove the network adapter card from the shipping package and store the packaging material in a safe location.

**Caution**

Wear a grounding device and observe electrostatic discharge precautions when installing the network adapter card in a system. Failure to observe this caution could result in damage to the card.

5. Applying even pressure at both corners of the card, push the adapter card until it is firmly seated in the PCIe slot.

Make sure the card is securely seated. See Figure 8 on page 32.

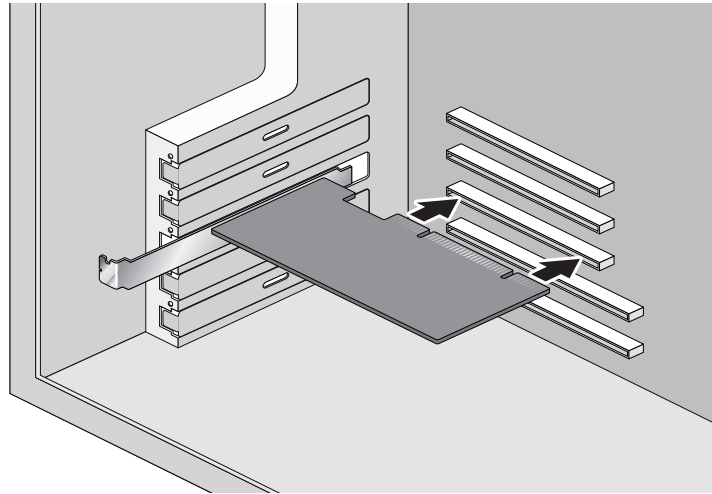

Figure 8. Inserting the Network Adapter Card



Caution

Do not use excessive force when seating the card, as this may damage the system or the adapter card. If the card resists seating, remove it from the system, realign it, and try again.

6. Secure the network adapter card to the chassis with a Phillips-head screw (not provided) as shown in Figure 9.

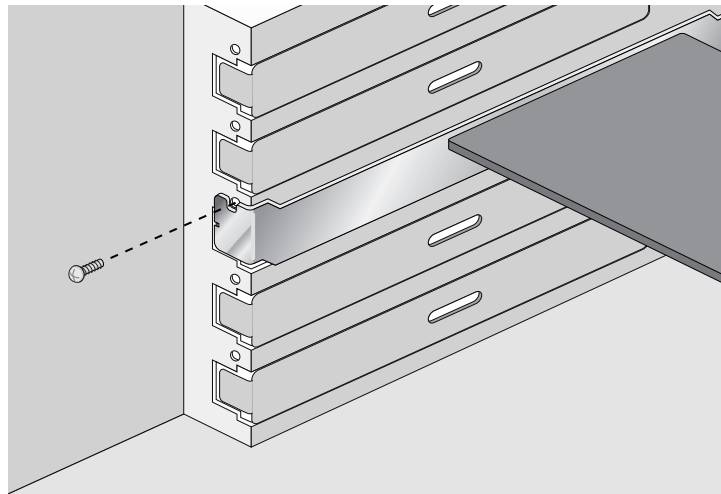

Figure 9. Securing the Adapter Card

7. Replace the system's cover and secure it with the screws removed in Step 2.
8. Disconnect any personal antistatic devices.

9. Power the system on.

Note

If you installed the adapter card in a Microsoft Windows 2003 or Windows XP system before installing the driver software, the Found New Hardware Wizard launches automatically. For more information, see Chapter 3, “Installing the Driver Software for Windows Systems” on page 35.

When the system returns to proper operation, the adapter hardware is fully installed. Next, connect the network cables. See “Connecting the Network Cables” on page 34.

Connecting the Network Cables

The AT-2711 series network adapter card is equipped with one of four types of fiber optic adapters: SC, LC, ST, and MT.

To connect a network cable to the adapter, perform the following procedure:

1. Prepare a fiber optic cable with an appropriate connector to your adapter.



Warning

The fiber optic ports contain a Class 1 laser device. When the ports are disconnected, always cover them with the provided plug. Exposed ports may cause skin or eye damage.

2. Remove a rubber plug from the adapter.
3. Connect one end of the cable to the adapter.
4. Connect the other end of the cable to the appropriate Ethernet network port or fiber optic port.

Note

After the cable is properly connected at both ends, the adapter card LED should be functional. See Table 1 on page 16 for a description of LED operation.

Chapter 3

Installing the Driver Software for Windows Systems

This chapter describes how to install driver software for the AT-2711 series adapter card onto your operating system. It contains the following topics:

- ❑ “Overview” on page 36
- ❑ “Downloading the Driver Software” on page 37
- ❑ “Accessing the Device Manager” on page 39
- ❑ “Installing the Driver Software” on page 44
- ❑ “Updating the Driver Software” on page 54
- ❑ “Performing the Silent Installation” on page 59

Overview

When you install the AT-2711 series adapter card on your computer, your next step is to install driver software onto your Windows operating system. You can install driver software using Device Manager or using the silent installation method.

When you install driver software using Device Manager, the dialog boxes guide you through the installation process. On the other hand, using the silent installation method, you can install software without constant interactions by suppressing dialog boxes.

Guidelines

Here are the guidelines for installing and updating the driver software on your operating system:

- To install or update the driver software, you must have administrative privileges.
- When you install the AT-2711 series adapter card on your computer and start the system, the Windows system detects a new adapter and may install a default driver. You must update the driver software for the AT-2711 series adapter card. See “Installing the Driver Using Device Manager”, or “Installing the Driver Using the Silent Installation Method”.
- When you install the AT-2711 series adapter card on your computer and start the system, the Windows system may install the native Broadcom driver if your computer has an onboard Broadcom network interface. You must update the driver for the AT-2711 series adapter card. See “Installing the Driver Using Device Manager”, or “Installing the Driver Using the Silent Installation Method”.

Installing the Driver Using Device Manager

To install or update the driver software using Device Manager, follow the steps below:

- “Downloading the Driver Software” on page 37
- “Accessing the Device Manager” on page 39
- “Installing the Driver Software” on page 44

Or

- “Updating the Driver Software” on page 54

Installing the Driver Using the Silent Installation Method

To install or update the driver software using the silent installation, follow the steps below:

- “Downloading the Driver Software” on page 37
- “Performing the Silent Installation” on page 59

Downloading the Driver Software

The AT-2711 series adapter card is not shipped with a software driver CD. You must download driver software from the Allied Telesis website.

To download driver software, do the following:

1. Open a web browser, such as Internet Explorer or FireFox, on your system and enter the following:

<http://www.alliedtelesis.com/support/software>

2. The Allied Telesis Software Download page is displayed.
3. Enter "2711" in the search box and press the enter key.

Figure 10 shows an example of the search result.

The screenshot shows the Allied Telesis website's 'Software Downloads' page. The page has a green header with the Allied Telesis logo and navigation links: Solutions, Services, Products, Support, About, Purchase. A search bar is located in the top right. Below the header, the page title is 'Support' with a breadcrumb trail: HOME » SUPPORT » SOFTWARE » SOFTWARE DOWNLOADS. A left sidebar contains a list of links: Support Center, Software, Documentation, Replacement Services, Open Source Downloads, Warranties, Service Contracts, and Training. The main content area is titled 'Software Downloads' and includes a prompt to 'Choose a product below for a comprehensive list of software, patches, and documentation available for download.' Below this, there is a note that 'Some software downloads are restricted' and a link to 'Log in to access restricted software.' A search bar and a product dropdown menu (set to '-- All Products --') are present. A table of search results follows, with columns for Product Name, Size, and Date.

Product	Size	Date
Firmware Upgrade Utility: Linux 32 & 64 bit	1.83 MB	16 Nov 2012
Firmware Upgrade Utility: Windows 32 bit	964.01 KB	16 Nov 2012
Firmware Upgrade Utility: Windows 64 bit	1.15 MB	16 Nov 2012
Firmware Update: AT-2711 Boot Code, Version 3.31 (Update 1)	11.67 KB	15 Feb 2013
Firmware, Bootloader and MIB Files: AT-S94 V3.0.0.45 *		07 Dec 2012
Firmware, Bootloader and MIB Files: AT-S95 V2.0.0.27 *		07 Dec 2012
Firmware and MIB Files: AT-S107 V1.1.3	6.45 MB	06 Dec 2012
Firmware and MIB Files: AT-S108 V1.1.3	6.45 MB	06 Dec 2012
Firmware and MIB Files: AT-S109 V1.1.3	6.45 MB	06 Dec 2012
Driver: 27xx and 29xx NICs - Windows 7, Vista, Windows Server 2008 (32 bit, v15.2.0.5, Update 1)	186.78 KB	06 Feb 2013
Driver: 27xx and 29xx NICs - Windows 7, Vista, Windows Server 2008, Windows Server 2008 R2 (64 bit, v15.2.0.5 Update 1)	210.64 KB	06 Feb 2013
Driver: 27xx and 29xx NICs - Windows 8, Windows Server 2012 (32 bit, v15.6.0.3)	198.46 KB	08 Feb 2013
Driver: 27xx and 29xx NICs - Windows 8, Windows Server 2012 (64 bit, v15.6.0.3)	209.50 KB	08 Feb 2013

Figure 10. Software Downloads Search Result Example

4. Select the driver for your adapter model and operating system.
5. Save the zip folder onto your system.
6. Right-click the zip folder and select **Extract All**.

A window as shown in Figure 11 pops up and prompts you to specify the location of a folder that you want to place unzipped files in.

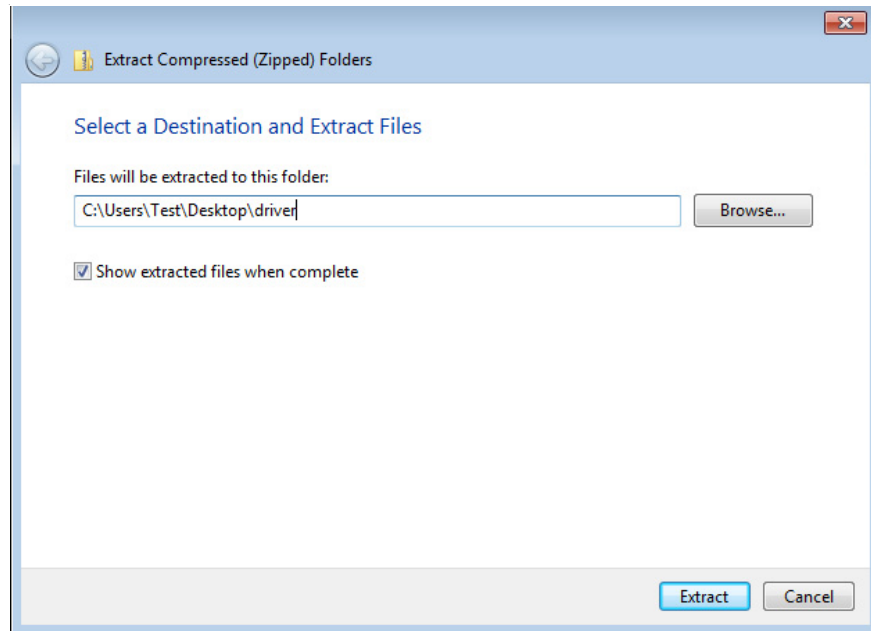

Figure 11. Specifying the Folder for Unzipped Files

7. Specify the location of the folder and click **Extract**.
8. Record the location of the folder.

Accessing the Device Manager

When you install or update the driver software for AT-2711 series adapter card, you must first access Device Manager.

The procedures for accessing Device Manager are slightly different among Windows operating systems. To access Device Manager on your operating system, follow one of the procedures below:

- ❑ “Accessing Device Manager on Windows Server 2012 or Windows 8,” next
- ❑ “Accessing Device Manager on Windows Server 2008, Windows Vista, or Windows 7” on page 41
- ❑ “Accessing Device Manager on Windows Server 2003 or Windows XP” on page 42

Accessing Device Manager on Windows Server 2012 or Windows 8

To access Device Manager on Windows Server 2012 or Windows 8, do the following:

1. Move the cursor to the lower left corner of the desktop.

The Start tile appears as shown in Figure 12.

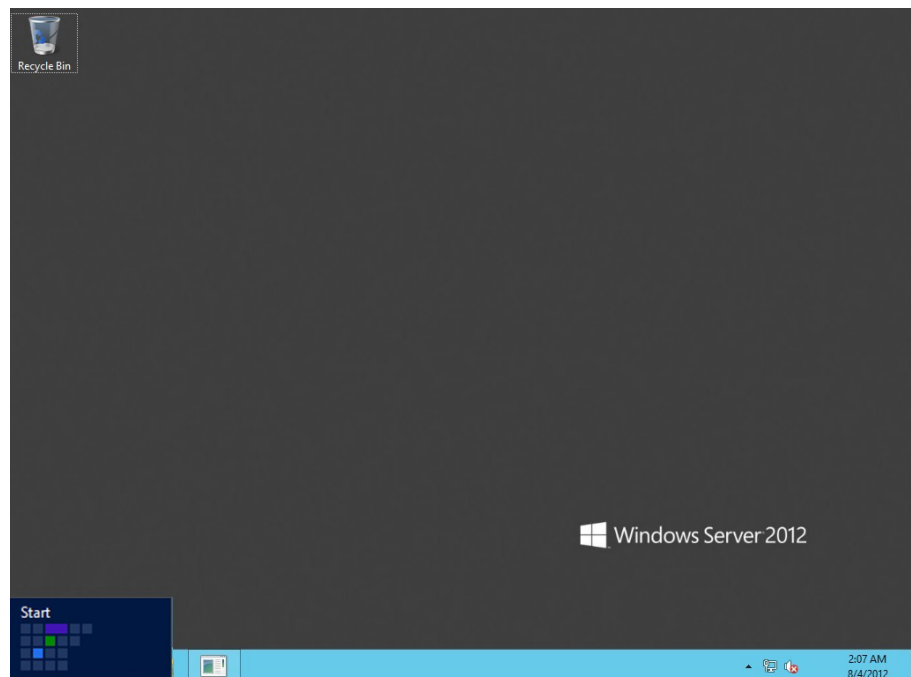

Figure 12. Start Tile on Windows Server 2012 and Windows 8

2. Right-click the **Start tile**.

The drop-up menu appears as shown in Figure 13.

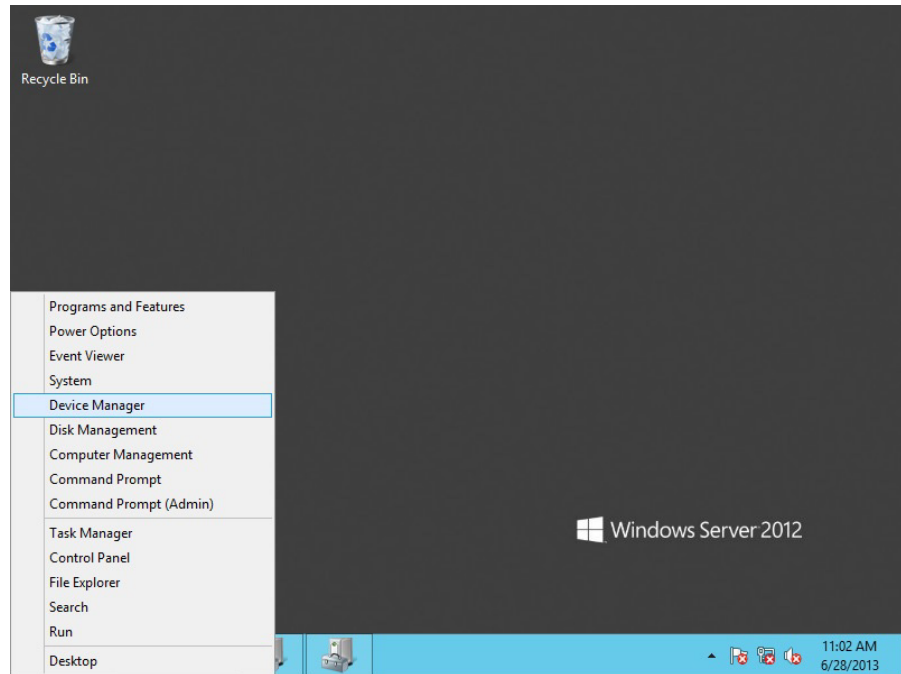

Figure 13. Drop-up Menu on Windows Server 2012 and Windows 8

3. Select **Device Manager** from the menu.

The Device Manager window appears as shown in Figure 14.

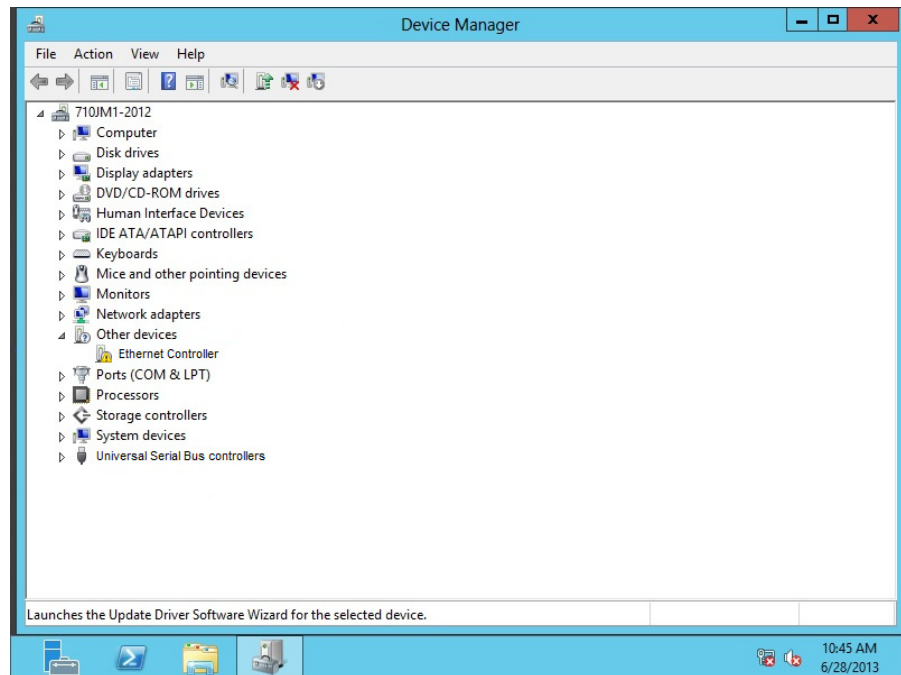

Figure 14. Device Manager on Windows Server 2012 and Windows 8

Accessing Device Manager on Windows Server 2008, Windows Vista, or Windows 7

To access Device Manager on Windows Server 2008, Windows Vista, or Windows 7, do the following:

1. Right-click the **Computer** icon on the desktop and select **Properties**.

The System window is opened as shown in Figure 15.

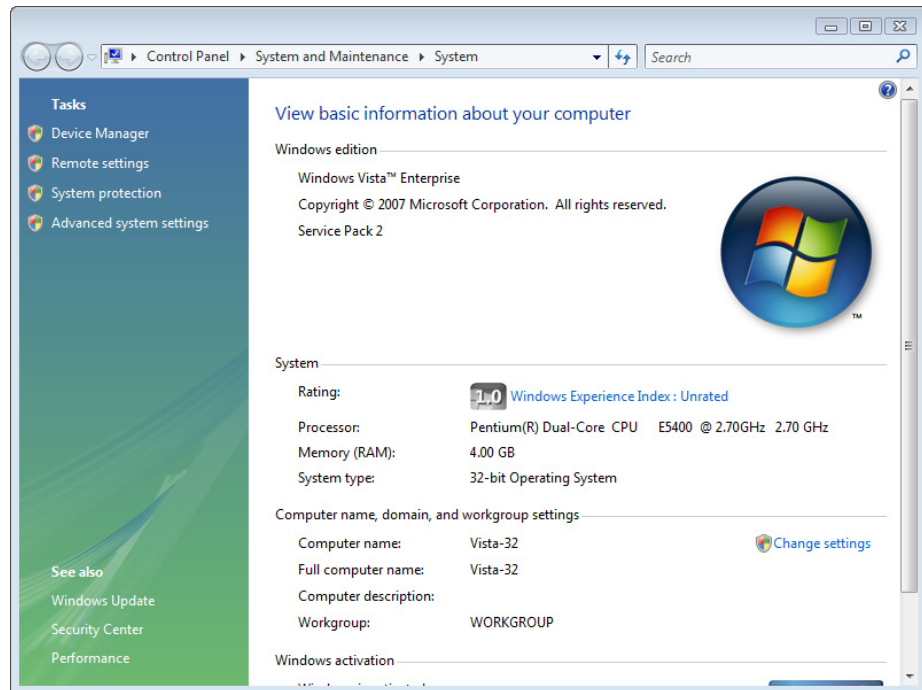

Figure 15. System Window on Server 2008, Vista, and 7

2. Click **Device Manager** on the left side bar.

The Device Manager window opens. Your AT-2711 series adapter card is detected as Ethernet Controller as shown in Figure 16 on page 42.

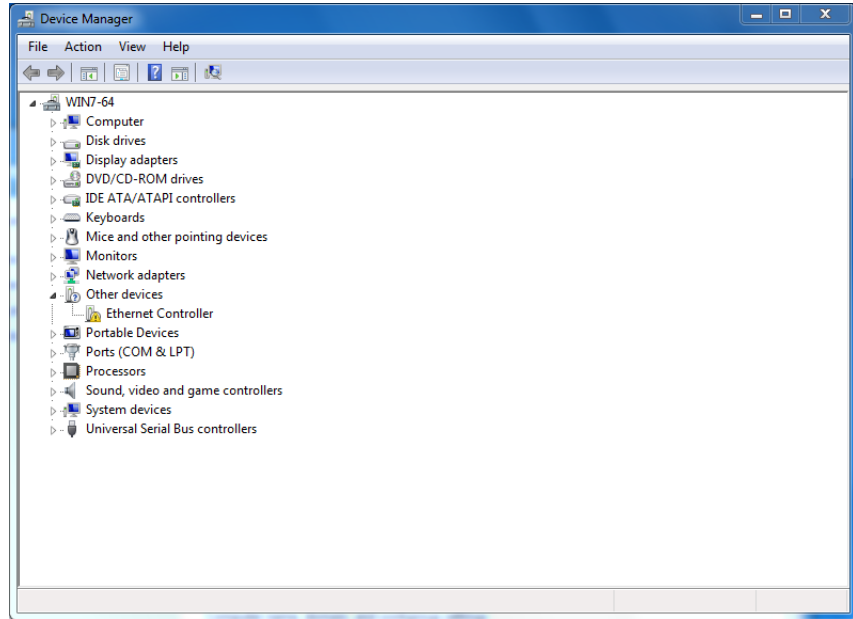

Figure 16. Device Manager Window on Server 2008, Vista, and 7

Accessing Device Manager on Windows Server 2003 or Windows XP

To access Device Manager on Windows Server 2003 or Windows XP, do the following:

1. Right-click the **My Computer** icon on the desktop and select **Properties**.

The System Properties window is opened as shown in Figure 17.

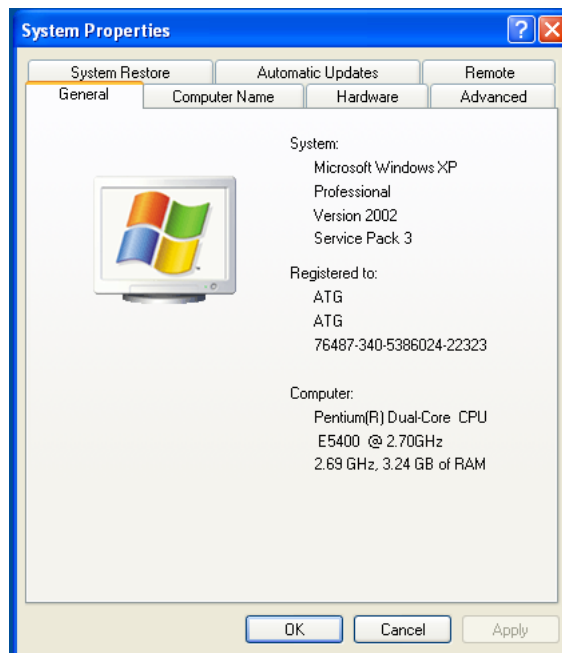

Figure 17. System Properties Window on Windows Server 2003 and XP

2. Select the **Hardware** Tab.

The Hardware page is shown in Figure 18.

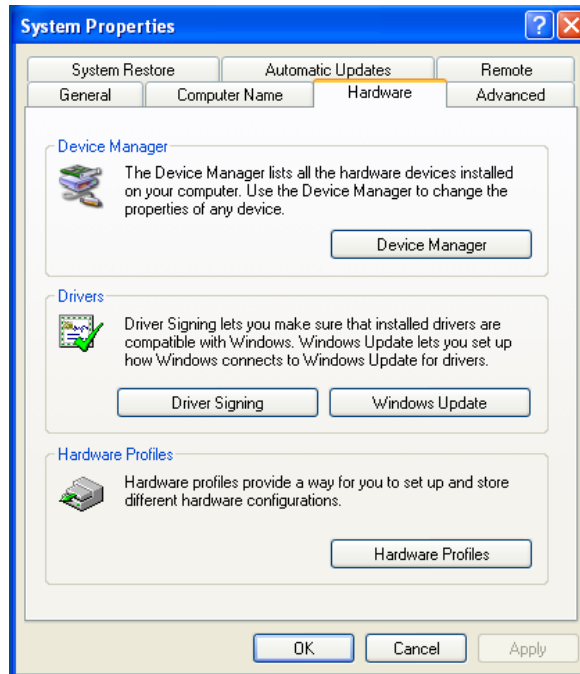

Figure 18. Hardware Page on Windows Server 2003 and XP

3. Click **Device Manager**.

The Device Manager window opens as shown in Figure 19.

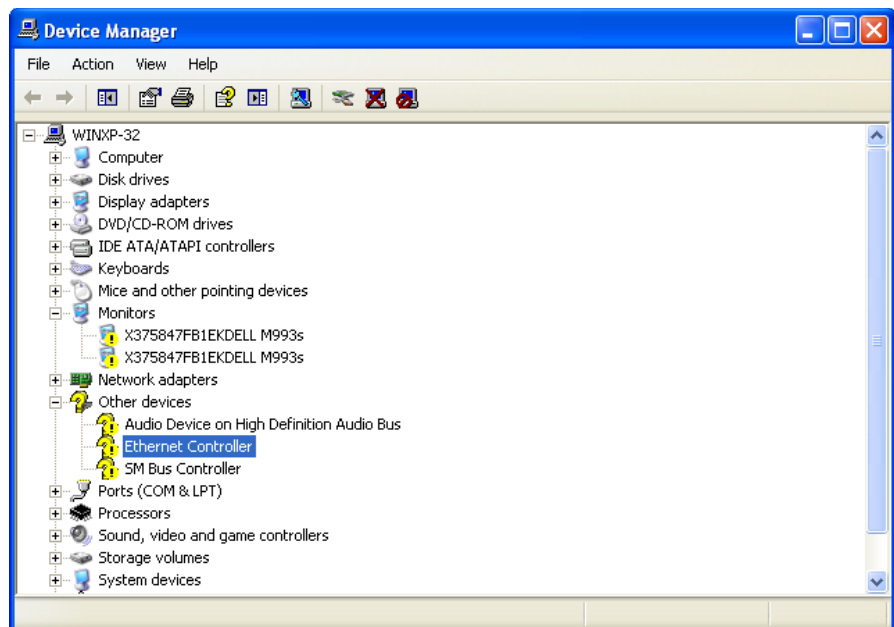

Figure 19. Device Manager Window on Windows Server 2003 and XP

Installing the Driver Software

Once you physically install the AT-2711 series adapter card, the system detects the new hardware and creates an entry in Device Manager when the Windows operating system first boots up. Shortly after you log in, you need to install the driver software for your adapter card.

Note

To install the driver software, you must have administrative privileges.

The procedures for installing the driver software are slightly different among Windows operating systems. To install the driver software on your system, follow one of the procedures below:

- ❑ “Installing the Driver Software on Windows Server 2012 or Windows 8,” next
- ❑ “Installing the Driver Software on Windows Server 2008, Windows Vista, or Windows 7” on page 47
- ❑ “Installing the Driver Software on Windows Server 2003 or Windows XP” on page 50

Installing the Driver Software on Windows Server 2012 or Windows 8

To install the driver software on Windows Server 2012 or Windows 8:

1. Access Device Manager. see “Accessing Device Manager on Windows Server 2012 or Windows 8” on page 39.
2. In the Device Manager window, right-click **Ethernet Controller**.

The shortcut menu appears as shown in Figure 20 on page 45.

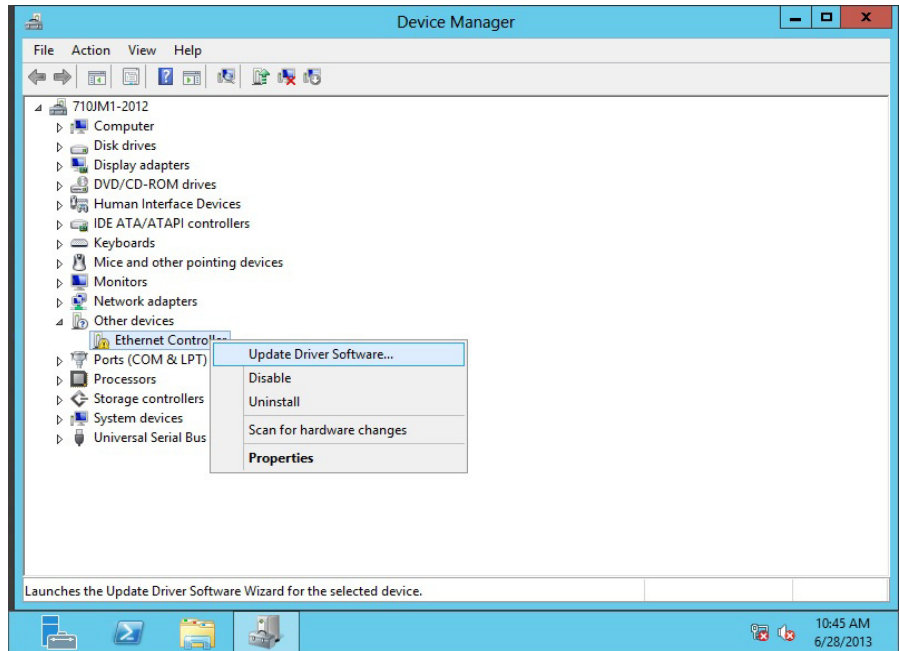

Figure 20. Ethernet Controller on Windows Server 2012 and Windows 8

3. Select **Update Driver Software**.

The Update Driver Software window pops up as shown in Figure 21.

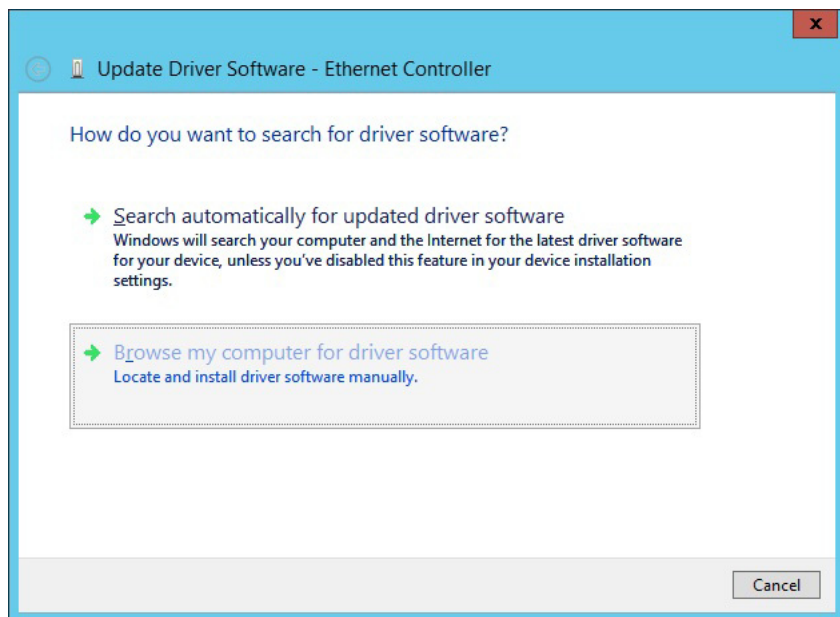

Figure 21. Update Driver Software Window on Windows Server 2012 and Windows 8

4. Select **Browse my computer for driver software**.

The Update Driver Software window prompts you to enter the location of the driver folder as shown in Figure 22.

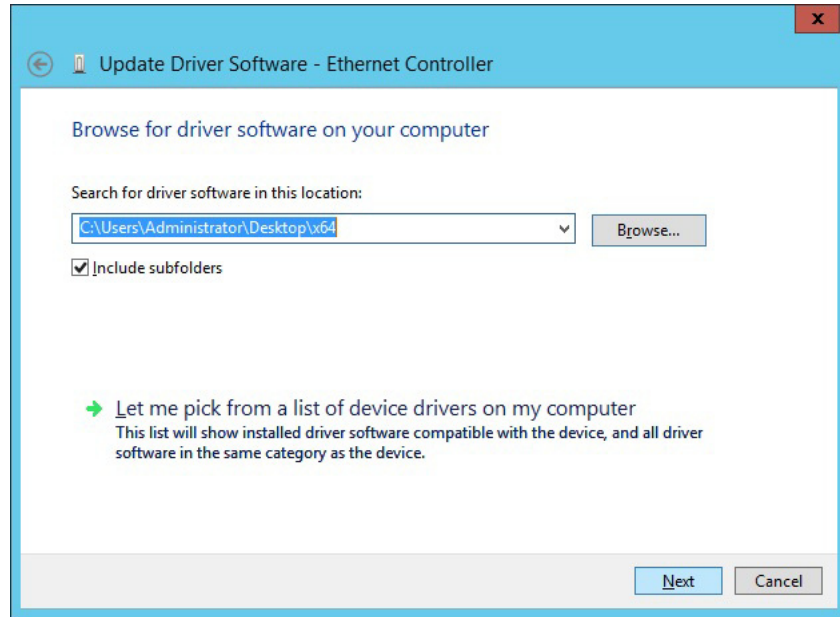

Figure 22. Update Driver Software Window on Windows Server 2012 and Windows 8

5. Specify the location of the driver software. See “Downloading the Driver Software” on page 37 for details.
6. Click **Next**.

The confirmation message shown in Figure 23 on page 47 appears when the driver software is successfully updated.

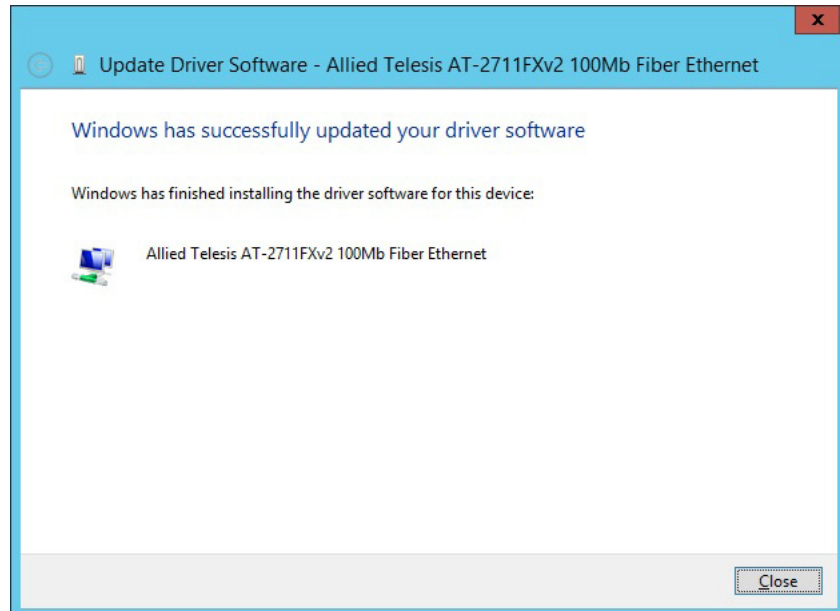

Figure 23. Update Driver Software Window on Windows Server 2012 and Windows 8

7. Click **Close**.

Installing the Driver Software on Windows Server 2008, Windows Vista, or Windows 7

To install the driver software on Windows Server 2008, Windows Vista or Windows 7, do the following:

1. Access Device Manager. see “Accessing Device Manager on Windows Server 2008, Windows Vista, or Windows 7” on page 41.
2. In the Device Manager window, right-click **Ethernet Controller**.

The shortcut menu appears as shown in Figure 24 on page 48.

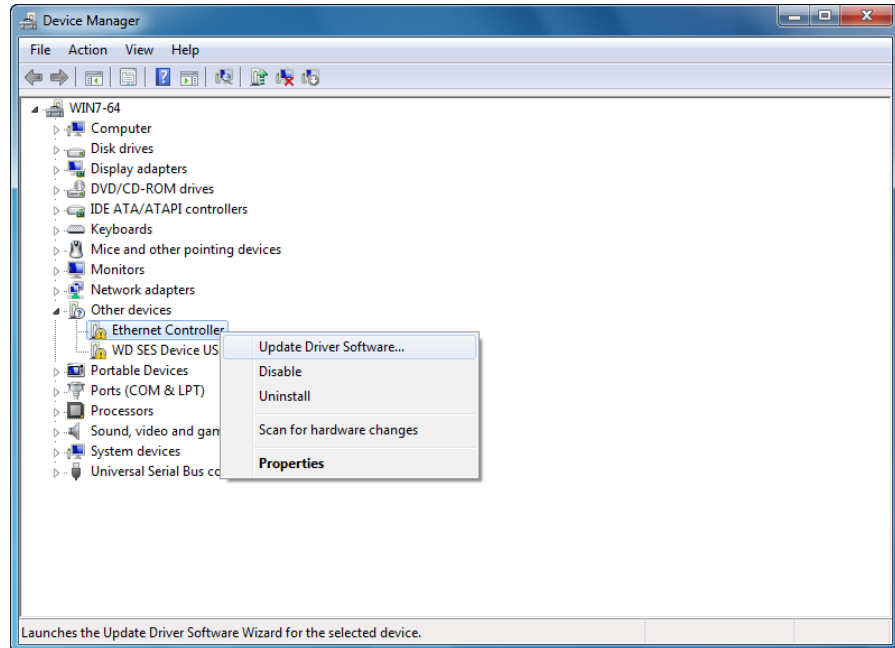

Figure 24. Ethernet Controller on Windows Server 2008, Vista, and 7

3. Select **Update Driver Software**.

The Update Driver Software window pops up as shown in Figure 25.

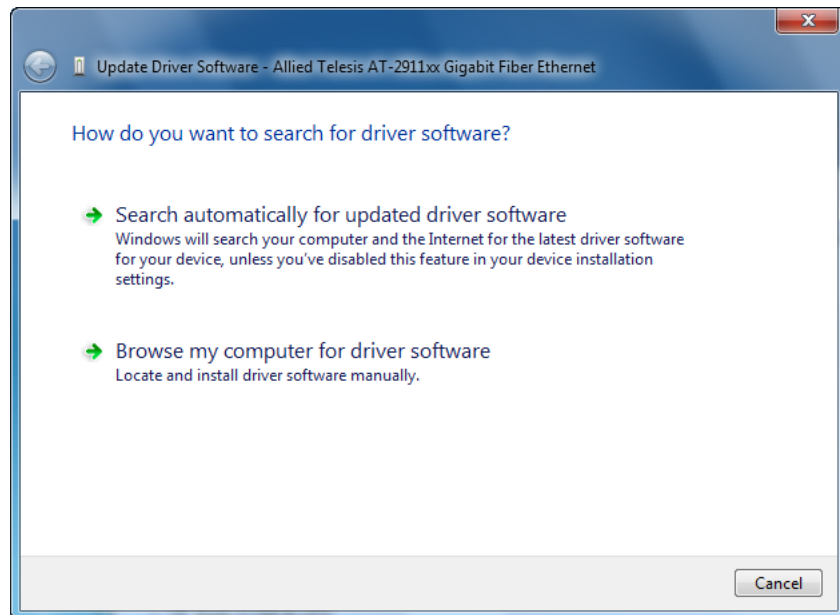

Figure 25. Update Driver Software Window on Windows Server 2008, Vista, and 7

4. Select **Browse my computer for driver software**.

The Update Driver Software window prompts you to enter the location of the driver folder as shown in Figure 26.

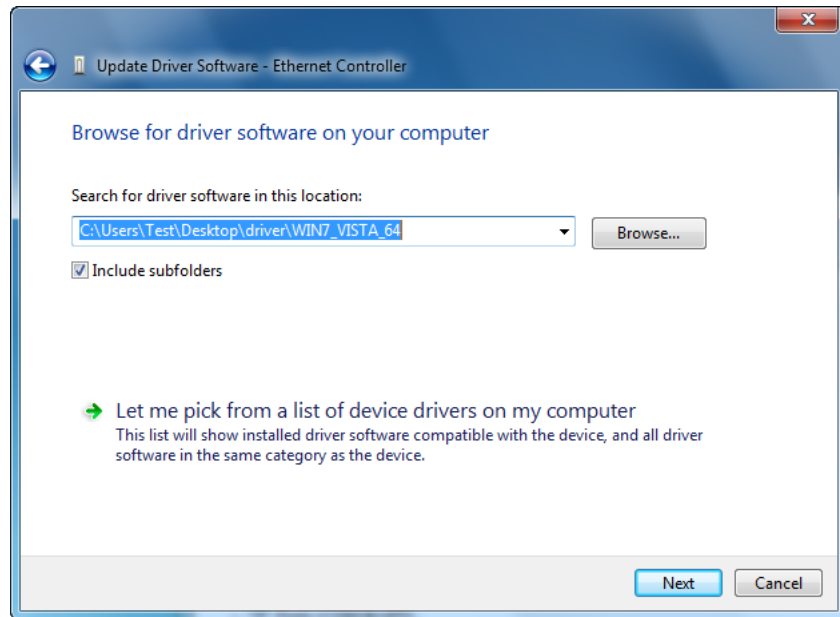

Figure 26. Update Driver Software Window on Windows Server 2008, Vista, and 7

5. Specify the location of the driver software. See “Downloading the Driver Software” on page 37 for details.

6. Click **Next**.

The confirmation message shown in Figure 27 on page 50 appears when the driver software is successfully updated.

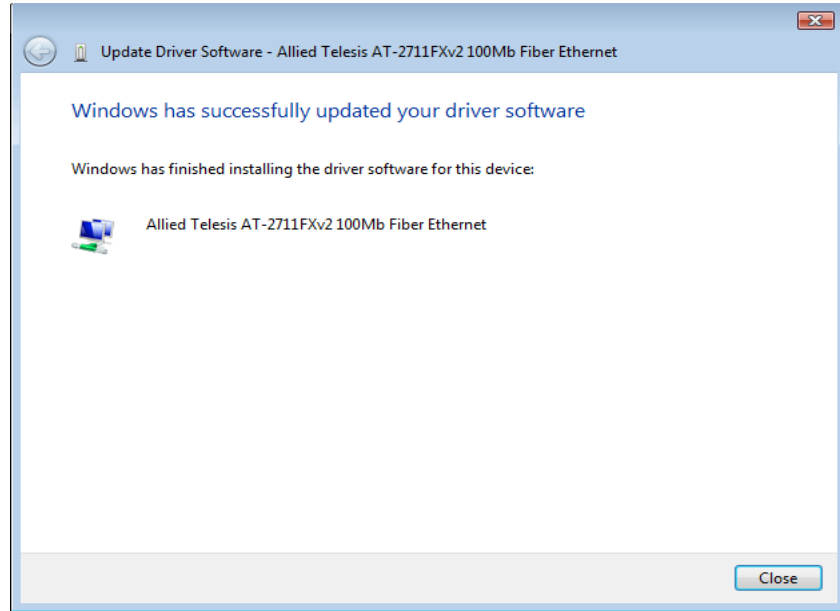

Figure 27. Update Driver Software Window on Windows Server 2008, Vista, and 7

7. Click **Close**.

Installing the Driver Software on Windows Server 2003 or Windows XP

To install the driver software onto Windows Server 2003 and Windows XP, do the following:

1. Access Device Manager. See “Accessing Device Manager on Windows Server 2003 or Windows XP” on page 42.
2. In the Device Manager window, right-click **Ethernet Controller**.

The shortcut menu appears as shown in Figure 28 on page 51.

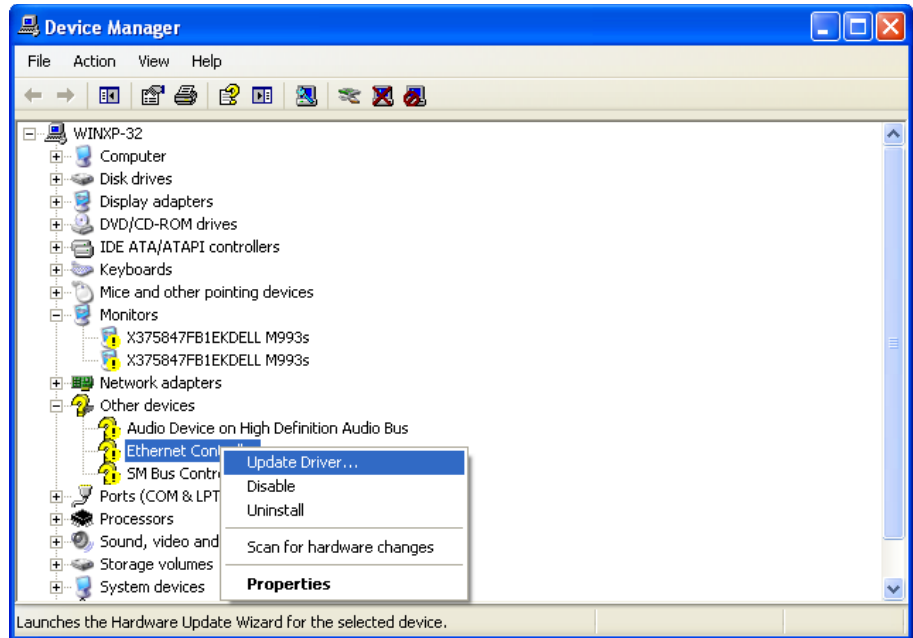

Figure 28. Ethernet Controller on Windows Server 2003 and XP

3. Select **Update Driver**.

The Hardware Update Wizard window pops up as shown in Figure 29.



Figure 29. Hardware Update Wizard 1

4. Select **No, not this time**.

5. Click **Next**.

The Hardware Update Wizard prompts you to select one of two options as shown in Figure 30

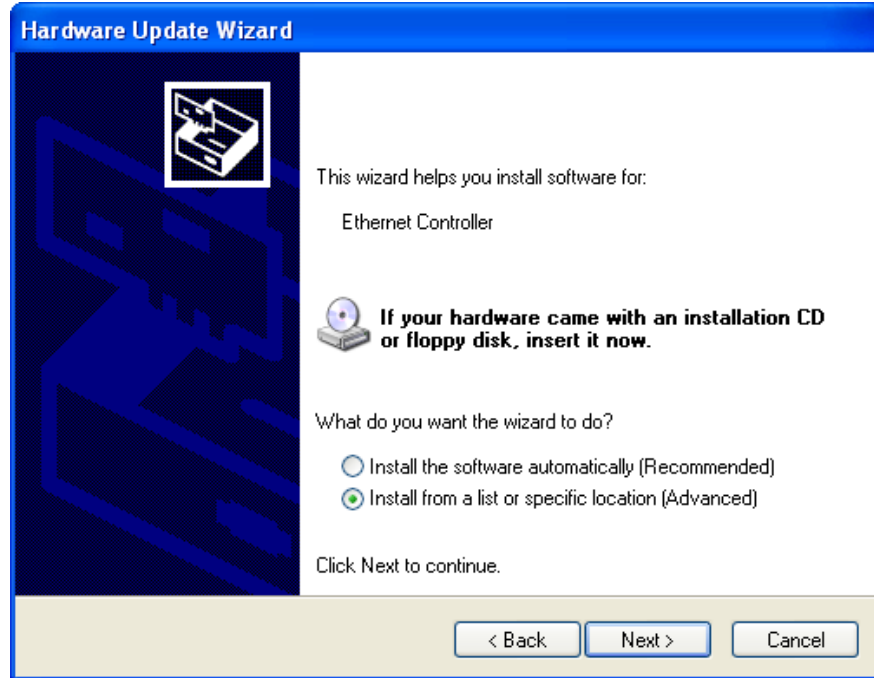

Figure 30. Hardware Update Wizard 2

6. Select **Install from a list or specific location (Advanced)**.
7. Click **Next**.

The Hardware Update Wizard prompts you to specify the location of your driver software as shown in Figure 31 on page 53.

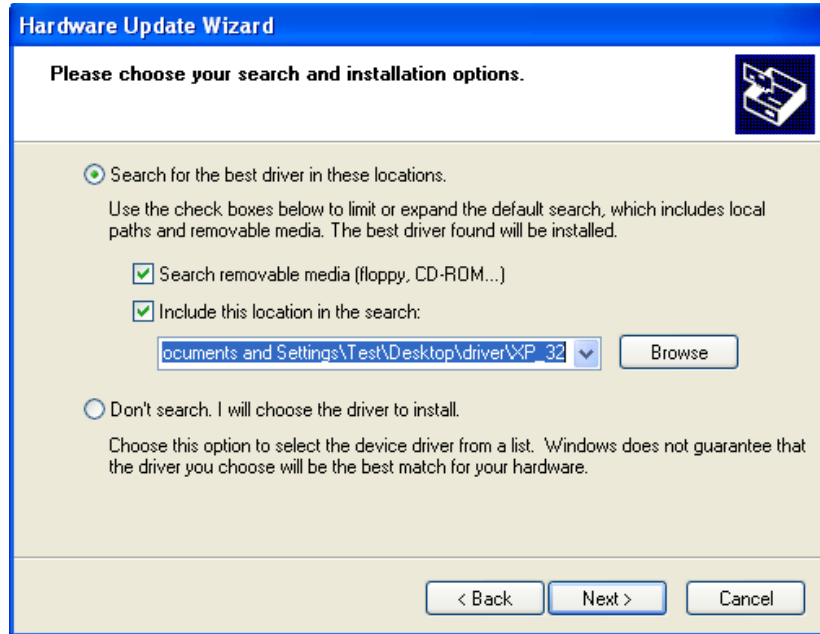

Figure 31. Hardware Update Wizard 3

8. Specify the location of the driver software.
9. Click **Next**.

The confirmation message is displayed as shown in Figure 32.

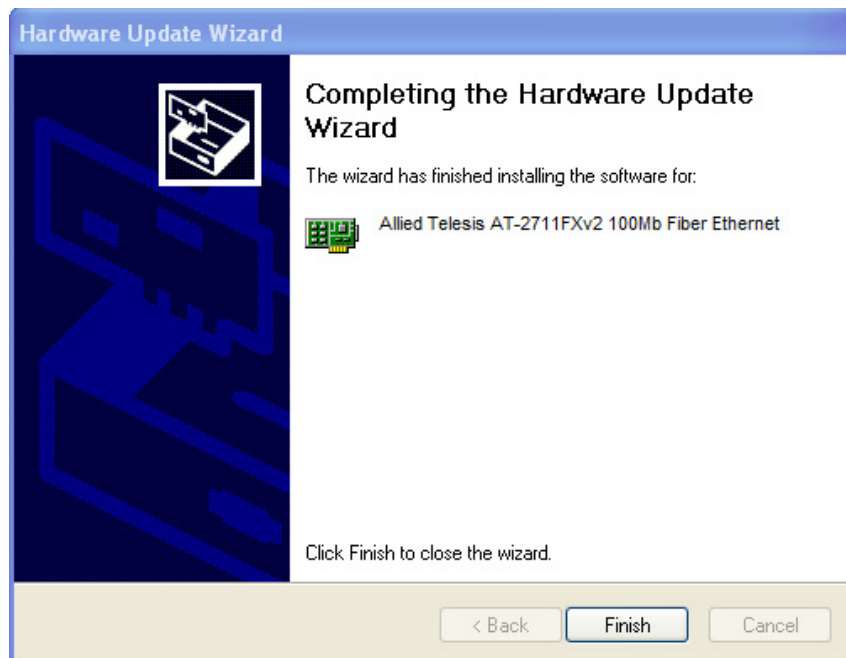

Figure 32. Hardware Update Wizard 4

10. Click **Finish**.

Updating the Driver Software

If your operating system detects the adapter card and installs a default driver, you need to update the driver software with the driver that you downloaded from the Allied Telesis website. To obtain the latest version of the AT-2711 series adapter driver, see “Downloading the Driver Software” on page 37.

To update the driver software, you use the same procedure for installing the driver software for the first time. The only difference between updating and installing the driver software is the name of your adapter that Device Manager detects and lists.

Device Manager lists your adapter card as Allied Telesis AT-2711xXv2 100Mb Fiber Ethernet once you installed the driver software. Before you installed the driver software, Device Manager lists your adapter as Ethernet Controller.

The procedures for installing the driver software are slightly different among Windows operating systems. To install the driver software on your system, follow one of the procedures below:

- “Updating the Driver on Windows Server 2012 or Windows 8,” next
- “Updating the Driver on Windows Server 2008, Windows Vista, or Windows 7” on page 56
- “Updating the Driver on Windows Server 2003 or Windows XP” on page 57

Updating the Driver on Windows Server 2012 or Windows 8

To update the driver software for your AT-2711 series adapter card, perform the following procedure:

1. Access the Device Manager. See “Accessing Device Manager on Windows Server 2012 or Windows 8” on page 39.

The Device Manager window pops up as shown in Figure 33 on page 55.

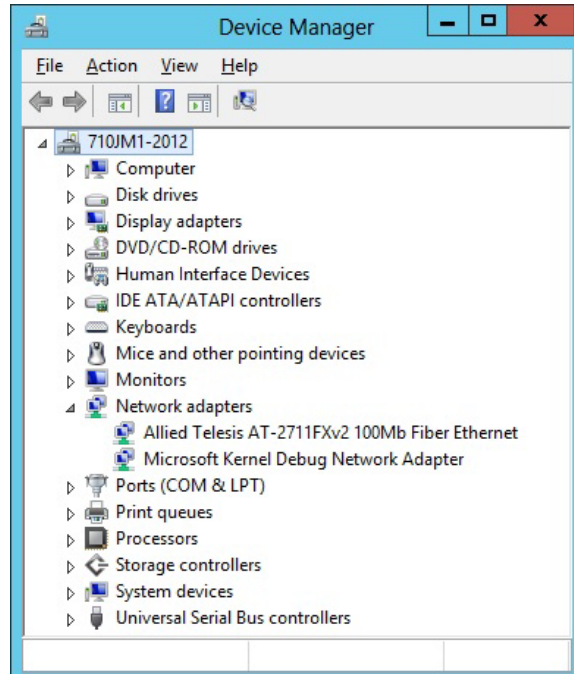

Figure 33. Device Manager on Windows Server 2012 and Windows 8

2. In the Device Manager window, right-click **Allied Telesis AT-2711xXV2 100Mb Fiber Ethernet**.

The shortcut menu appears.

3. Select **Update Driver Software**.

The Update Driver Software window pops up as shown in Figure 20 on page 45.

4. Select **Browse my computer for driver software**.

The Update Driver Software window prompts you to enter the location of the driver folder as shown in Figure 22 on page 46.

5. Specify the location of the driver software.

6. Click **Next**.

The confirmation message appears when the driver software is successfully updated. See Figure 23 on page 47.

7. Click **Close**.

Updating the Driver on Windows Server 2008, Windows Vista, or Windows 7

To update the driver software for your AT-2711 series adapter card, perform the following procedure:

1. Access the Device Manager. See “Accessing Device Manager on Windows Server 2008, Windows Vista, or Windows 7” on page 41.
2. In the Device Manager window, right-click **Allied Telesis AT-2711xXV2 100Mb Fiber Ethernet**.

The shortcut menu appears as shown in Figure 34.

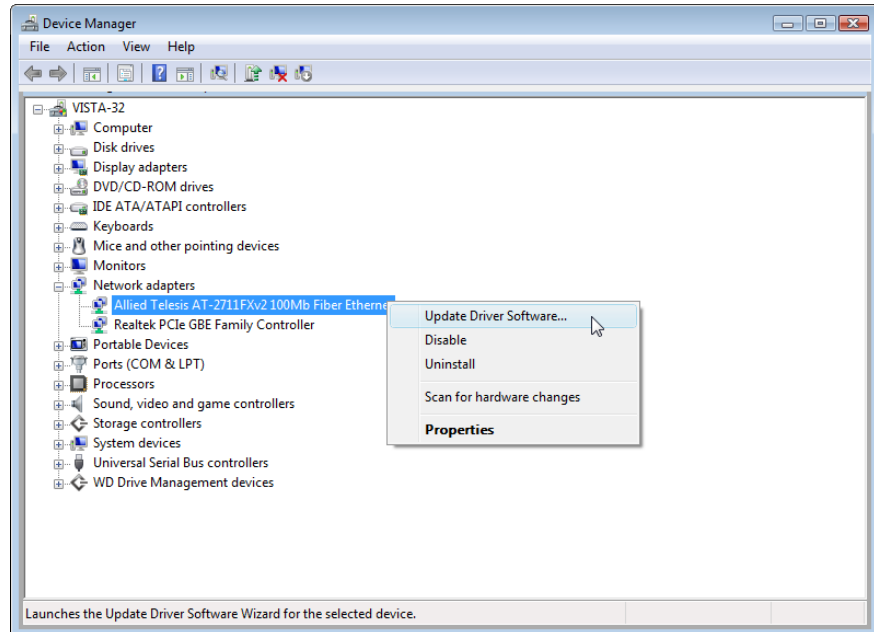

Figure 34. Device Manager with an Expanded List on Windows Server 2008, Vista, and 7

3. Select **Update Driver Software**.

The Update Driver Software window pops up as shown in Figure 25 on page 48.

4. Select **Browse my computer for driver software**.

The Update Driver Software window prompts you to enter the location of the driver folder as shown in Figure 26 on page 49.

5. Specify the location of the driver software.
6. Click **Next**.

The confirmation message appears when the driver software is successfully updated. See Figure 27 on page 50.

7. Click **Close**.

Updating the Driver on Windows Server 2003 or Windows XP

To install the driver software for the AT-2711 series adapter card onto the Windows Server 2003 and Windows XP, do the following:

1. Access Device Manager. See “Accessing Device Manager on Windows Server 2003 or Windows XP” on page 42.
2. In the Device Manager window, right-click **Allied Telesis AT-2711xXV2 100Mb Fiber Ethernet**.

The shortcut menu appears as shown in Figure 35.

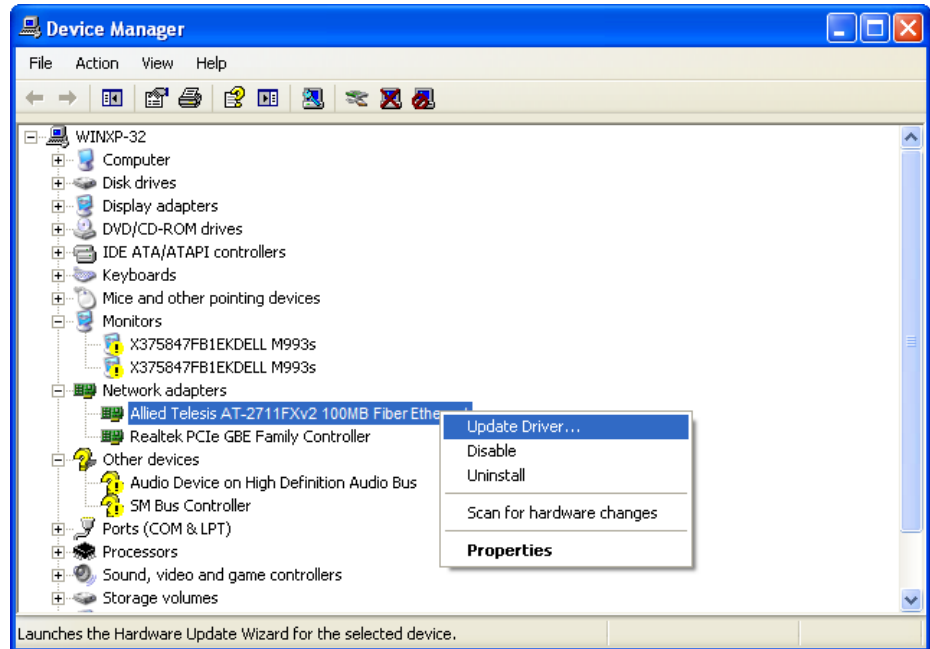

Figure 35. Network Adapters on Windows Server 2003 and XP

3. Select **Update Driver**.

The Hardware Update Wizard window pops up as shown in Figure 29 on page 51.

4. Select **No, not this time**.
5. Click **Next**.

The Hardware Update Wizard prompts you to select one of two options as shown in Figure 30 on page 52.

6. Select **Install from a list or specific location (Advanced)**.
7. Click **Next**.

The Hardware Update Wizard prompts you to specify the location of your driver software as shown in Figure 31 on page 53.

8. Specify the location of the driver software that you downloaded from Allied Telesis website.

9. Click **Next**.

The confirmation message is displayed as shown in Figure 32 on page 53.

10. Click **Finish**.

Performing the Silent Installation

To simplify the driver installation process, you may perform a silent installation when installing driver software for the AT-2711 series adapter cards. The silent installation is a method of installing software in the silent mode without constant interactions by suppressing dialog boxes.

Note

You can apply the silent installation method only to Microsoft certified drivers. The drivers that Allied Telesis provides for the AT-2711 series adapter cards are all Microsoft certified.

Use a command line utility called Driver package Installer (DPIInst) for the silent installation. DPIInst is included in the Windows Developer Kit (WDK) provided by Microsoft. You can obtain the latest DPIInst by downloading and installing the latest WDK from the Microsoft website.

Installing the Driver Silently

To install the driver silently, perform the following instructions:

1. Create a folder in your Windows system.
2. Download driver software for the AT-2711 series adapter card.

See "Downloading the Driver Software" on page 37.

3. Place the driver files that you downloaded into the folder that you created in step 1.

The folder should include the following driver files:

- .sys
- .inf
- .cat

4. Download the latest WDK to obtain the `dpinst` utility.

Consult Microsoft websites to download WDK.

5. Place the `dpinst.exe` and its supporting files in the same folder where you placed the driver files.

You must place the 64-bit `dpinst` utility if your operating system is the 64-bit version. Place the 32-bit `dpinst` utility for the 32-bit version operating system.

6. Open a command prompt window with administrator privileges.

7. Change the directory to the folder where the `dpinst` utility and the driver files reside.
8. Install the driver in the silent mode by entering the following command:

```
> dpinst /S
```

Note

Adding the `/S` switch to the `dpinst` command suppresses the display of wizard pages, user dialog boxes, and other user intervention requests.

The driver is installed silently.

Viewing Supported DPInst Options

You can display help information about the `dpinst` command-line options.

View all supported `dpinst` options by executing the following command:

1. Open a command prompt window with administrator privileges.
2. Change the directory to the folder where the `dpinst` utility and the driver files reside.

```
> dpinst /?
```

The command displays the help text.

Chapter 4

Configuring the Ethernet Interface for Linux Systems

This chapter provides procedures for configuring Ethernet interfaces for AT-2711 series adapters on Linux systems and contains the following sections:

- ❑ “Overview” on page 62
- ❑ “Configuring an Ethernet Interface on Linux Systems” on page 63

Overview

The AT-2711 series adapters use a Linux inbox driver to operate. A driver supplied with an operating system is called an inbox driver. Current Linux systems come with the inbox driver that the AT-2711 series adapters need.

Since the driver software for the AT-2711 series adapters has already been in place, you do not need to install it; however, the speed and duplex mode are not automatically negotiated. You must disable Auto-negotiation and sets these properties for the AT-2711 adapter interfaces manually. In addition, you must set the same property values on the port interfaces of the connected switch.

Configuring an Ethernet Interface on Linux Systems

This section provides how to set speed and duplex mode to the Ethernet interfaces of AT-2711 series fiber optic adapters. The following is the general instructions for Ubuntu and Red Hat Linux distributions. For other distributions of Linux, consult documentation for your systems.

Configuring an Ethernet Interface on Ubuntu

To configure Ethernet interfaces of AT-2711 series adapters:

1. Verify that the `ethtool` utility is installed on your system by entering the following command:

```
ethtool
```

If the `ethtool` utility is not installed on your system, the system shows an error message. If the `ethtool` utility is installed, skip step 2.

2. If your system does not have the `ethtool` utility installed, Install it by entering the following command:

```
sudo apt-get install ethtool
```

3. Obtain the name of the Ethernet interface for the AT-2711 series adapter, such as `eth0` and `eth1`, by entering the following command:

```
ifconfig
```

You have one Ethernet interface per AT-2711 series adapter card.

Note

To identify the Ethernet interface of the AT-2711 series adapter, match the MAC address of the `ethN` interface that the `ifconfig` command displays with one on the label of the shipping package.

4. Edit `/etc/network/interfaces` file to disable Auto-negotiation and set the speed and duplex mode by inserting the following statements:

```
auto ethx
iface ethx inet dhcp
pre-up/sbin/ethtool -s ethx speed 100 duplex full autoneg off
```

Note

Replace "`ethx`" with the name of the Ethernet interface that you obtained in step 3. "`ethx`" appears three times in the statement.

5. Repeat step 4 for all of the Ethernet interfaces of AT-2711 series adapters on your system.

6. Save the `/etc/network/interfaces` file.
7. Reboot your Linux system.
8. Verify that your AT-2711 series adapter is running 100 Mbps in the full-duplex mode by entering the following command:

```
ethtool ethx
```

The command output should display:

```
Advertised Auto-Negotiation is No  
Speed is 100  
Duplex mode is Full
```

9. Repeat step 8 for all of the Ethernet interfaces of AT-2711 series adapters on your system.

Configuring an Ethernet Interface on Red Hat

To configure Ethernet interfaces of AT-2711 series adapters:

1. Ensure that the `ethtool` utility is installed on your system.

Note

To verify that the `ethtool` utility is installed or install the `ethtool` utility on your system, consult the documentation for your Red Hat distribution.

2. Obtain the name of the Ethernet interface for the AT-2711 series adapter, such as `eth0` and `eth1`, by entering the following command:

```
ifconfig
```

You have one Ethernet interface per AT-2711 series adapter card.

Note

To identify the Ethernet interface of the AT-2711 series adapter, match the MAC address of the `ethN` interface that the `ifconfig` command displays with one on the label of the shipping package.

3. Create a new file with the name "`ifcfg-ethx`" in `/etc/sysconfig/network-scripts` directory.

For example, if the name of the Ethernet interface that you obtained in step 2 is `eth2`, then create a new file with the name "`ifcfg-eth2`."

4. Edit the `ifcfg-ethx` file to include the following information:

```
#####
DEVICE="ethx"
NM_CONTROLLED="yes"
ONBOOT=yes
HWADDR=xx:xx:xx:xx:xx:xx
TYPE=Ethernet
BOOTPROTO=dhcp
DEFROUTE=yes
PEERDNS=yes
PEERROUTES=yes
IPV4_FAILURE_FATAL=yes
IPV6INIT=no
NAME="auto ethx"
ETHTOOL_OPTS="autoneg off speed 100 duplex full"
#####
```

Note

Replace "ethx" with the name of the Ethernet interface that you obtained in step 2 and xx:xx:xx:xx:xx:xx with the hardware address of your adapter. "ethx" appears twice in the file.

5. Save the ifcfg-ethx file.
6. Repeat step 3 to 5 for all of the Ethernet interfaces of AT-2711 series adapters on your system.
7. Reboot your Linux system.
8. Verify that your AT-2711 series adapter is running 100 Mbps in the full-duplex mode by entering the following command:

```
ethtool ethx
```

The command output should display:

```
Advertised Auto-Negotiation is No
Speed is 100
Duplex mode is Full
```

9. Repeat step 8 for all of the Ethernet interfaces of AT-2711 series adapters on your system.

Chapter 5

Modifying Advanced Properties

This chapter includes the following topics:

- ❑ “Overview” on page 69
- ❑ “Supported Advanced Properties” on page 70
- ❑ “Accessing Advanced Properties” on page 76
- ❑ “802.1p QOS” on page 78
- ❑ “802.3az EEE” on page 79
- ❑ “ARP Offload” on page 80
- ❑ “EEE Control Policies” on page 81
- ❑ “Ethernet@WireSpeed” on page 83
- ❑ “Flow Control” on page 84
- ❑ “Interrupt Moderation” on page 86
- ❑ “Checksum Offload” on page 87
- ❑ “IPv4 Checksum Offload” on page 88
- ❑ “Jumbo Mtu” on page 89
- ❑ “Large Send Offload” on page 90
- ❑ “Large Send Offload (IPv4)” on page 91
- ❑ “Large Send Offload v2 (IPv4)” on page 93
- ❑ “Large Send Offload v2 (IPv6)” on page 95
- ❑ “Locally Administered Address” on page 96
- ❑ “Network Address” on page 98
- ❑ “NS Offload” on page 100
- ❑ “Priority & VLAN” on page 101
- ❑ “Receive Side Scaling” on page 103
- ❑ “Maximum Number of RSS Queues” on page 104
- ❑ “RSS Queues” on page 105
- ❑ “Speed & Duplex” on page 106
- ❑ “TCP/UDP Checksum Offload (IPv4)” on page 108
- ❑ “TCP/UDP Checksum Offload (IPv6)” on page 110
- ❑ “VLAN ID” on page 112
- ❑ “Wake Up Capabilities” on page 113

- “Wake on Magic Packet” on page 115
- “Wake on Pattern Match” on page 116
- “WOL Speed” on page 117

Overview

The AT-2711 series adapter allows you to modify the advanced properties to meet your requirements. To access the advanced properties, you must access Device Manager, then go to each advanced property page.

A set of advanced properties that you can control depends on your operating system and the driver software you install. See “Supported Advanced Properties” on page 70 for your operating system.

Guidelines Here are the guidelines to modifying the advanced properties:

- ❑ To change the advanced property settings, you must have Administrator privileges.
- ❑ When you upgrade the driver software, the settings of the advanced properties may change. Verify the settings after upgrading the driver software.

Supported Advanced Properties

The supported advanced properties for your AT-2711 series adapter depend upon your operating system. For Windows Vista, Windows Server 2008, Windows 7, and Windows Server 2008R2, two versions of driver software support different sets of advanced properties.

Windows XP and Server 2003

The driver software available for Windows XP and Windows Server 2003 is version 15.2.0.4. The supported advanced properties are shown in Table 2.

Table 2. Advanced Properties for Windows XP and Server 2003

Driver Version	Advanced Properties
15.2.0.4	<ul style="list-style-type: none"> <input type="checkbox"/> "802.1p QOS" on page 78 <input type="checkbox"/> "802.3az EEE" on page 79 <input type="checkbox"/> "Checksum Offload" on page 87 <input type="checkbox"/> "EEE Control Policies" on page 81 <input type="checkbox"/> "Ethernet@WireSpeed" on page 83 <input type="checkbox"/> "Flow Control" on page 84 <input type="checkbox"/> "Jumbo Mtu" on page 89 <input type="checkbox"/> "Large Send Offload" on page 90 <input type="checkbox"/> "Locally Administered Address" on page 96 <input type="checkbox"/> "Speed & Duplex" on page 106 <input type="checkbox"/> "Wake Up Capabilities" on page 113 <input type="checkbox"/> "WOL Speed" on page 117

Windows Vista and Server 2008

The driver software available for Windows Vista and Windows Server 2008 is versions 15.2.0.5 and 15.6.0.3. The sets of supported advanced properties for these driver versions are shown in Table 3.

Table 3. Advanced Properties for Windows Vista and Server 2008

Driver Version	Advanced Properties
15.2.0.5	<ul style="list-style-type: none"> <input type="checkbox"/> "802.3az EEE" on page 79 <input type="checkbox"/> "EEE Control Policies" on page 81 <input type="checkbox"/> "Ethernet@WireSpeed" on page 83 <input type="checkbox"/> "Flow Control" on page 84 <input type="checkbox"/> "Interrupt Moderation" on page 86 <input type="checkbox"/> "IPv4 Checksum Offload" on page 88 <input type="checkbox"/> "Jumbo Mtu" on page 89 <input type="checkbox"/> "Large Send Offload (IPv4)" on page 91 <input type="checkbox"/> "Large Send Offload v2 (IPv4)" on page 93 <input type="checkbox"/> "Large Send Offload v2 (IPv6)" on page 95 <input type="checkbox"/> "Network Address" on page 98 <input type="checkbox"/> "Priority & VLAN" on page 101 <input type="checkbox"/> "Receive Side Scaling" on page 103 <input type="checkbox"/> "RSS Queues" on page 105 <input type="checkbox"/> "Speed & Duplex" on page 106 <input type="checkbox"/> "TCP/UDP Checksum Offload (IPv4)" on page 108 <input type="checkbox"/> "TCP/UDP Checksum Offload (IPv6)" on page 110 <input type="checkbox"/> "VLAN ID" on page 112 <input type="checkbox"/> "Wake Up Capabilities" on page 113 <input type="checkbox"/> "WOL Speed" on page 117

Table 3. Advanced Properties for Windows Vista and Server 2008

Driver Version	Advanced Properties
15.6.0.3	<ul style="list-style-type: none"> <input type="checkbox"/> “802.3az EEE” on page 79 <input type="checkbox"/> “EEE Control Policies” on page 81 <input type="checkbox"/> “Ethernet@WireSpeed” on page 83 <input type="checkbox"/> “Flow Control” on page 84 <input type="checkbox"/> “Interrupt Moderation” on page 86 <input type="checkbox"/> “Jumbo Mtu” on page 89 <input type="checkbox"/> “Large Send Offload v2 (IPv4)” on page 93 <input type="checkbox"/> “Large Send Offload v2 (IPv6)” on page 95 <input type="checkbox"/> “Network Address” on page 98 <input type="checkbox"/> “Priority & VLAN” on page 101 <input type="checkbox"/> “Receive Side Scaling” on page 103 <input type="checkbox"/> “Maximum Number of RSS Queues” on page 104 <input type="checkbox"/> “Speed & Duplex” on page 106 <input type="checkbox"/> “TCP/UDP Checksum Offload (IPv4)” on page 108 <input type="checkbox"/> “TCP/UDP Checksum Offload (IPv6)” on page 110 <input type="checkbox"/> “VLAN ID” on page 112 <input type="checkbox"/> “Wake on Magic Packet” on page 115 <input type="checkbox"/> “Wake on Pattern Match” on page 116 <input type="checkbox"/> “WOL Speed” on page 117

Windows 7 and Server 2008R2

The driver software available for Windows 7 and Windows Server 2008R2 is versions 15.2.0.5 and 15.6.0.3. The sets of supported advanced properties for these driver versions are shown in Table 3.

Table 4. Advanced Properties for Windows 7 and Server 2008R2

Driver Version	Advanced Properties
15.2.0.5	<ul style="list-style-type: none"> <input type="checkbox"/> "802.3az EEE" on page 79 <input type="checkbox"/> "ARP Offload" on page 80 <input type="checkbox"/> "EEE Control Policies" on page 81 <input type="checkbox"/> "Ethernet@WireSpeed" on page 83 <input type="checkbox"/> "Flow Control" on page 84 <input type="checkbox"/> "Interrupt Moderation" on page 86 <input type="checkbox"/> "IPv4 Checksum Offload" on page 88 <input type="checkbox"/> "Jumbo Mtu" on page 89 <input type="checkbox"/> "Large Send Offload (IPv4)" on page 91 <input type="checkbox"/> "Large Send Offload v2 (IPv4)" on page 93 <input type="checkbox"/> "Large Send Offload v2 (IPv6)" on page 95 <input type="checkbox"/> "Network Address" on page 98 <input type="checkbox"/> "NS Offload" on page 100 <input type="checkbox"/> "Priority & VLAN" on page 101 <input type="checkbox"/> "Receive Side Scaling" on page 103 <input type="checkbox"/> "RSS Queues" on page 105 <input type="checkbox"/> "Speed & Duplex" on page 106 <input type="checkbox"/> "TCP/UDP Checksum Offload (IPv4)" on page 108 <input type="checkbox"/> "TCP/UDP Checksum Offload (IPv6)" on page 110 <input type="checkbox"/> "VLAN ID" on page 112 <input type="checkbox"/> "Wake Up Capabilities" on page 113 <input type="checkbox"/> "WOL Speed" on page 117

Table 4. Advanced Properties for Windows 7 and Server 2008R2

Driver Version	Advanced Properties
15.6.0.3	<ul style="list-style-type: none"> <input type="checkbox"/> “802.3az EEE” on page 79 <input type="checkbox"/> “ARP Offload” on page 80 <input type="checkbox"/> “EEE Control Policies” on page 81 <input type="checkbox"/> “Ethernet@WireSpeed” on page 83 <input type="checkbox"/> “Flow Control” on page 84 <input type="checkbox"/> “Interrupt Moderation” on page 86 <input type="checkbox"/> “Jumbo Mtu” on page 89 <input type="checkbox"/> “Large Send Offload v2 (IPv4)” on page 93 <input type="checkbox"/> “Large Send Offload v2 (IPv6)” on page 95 <input type="checkbox"/> “Network Address” on page 98 <input type="checkbox"/> “NS Offload” on page 100 <input type="checkbox"/> “Priority & VLAN” on page 101 <input type="checkbox"/> “Receive Side Scaling” on page 103 <input type="checkbox"/> “Maximum Number of RSS Queues” on page 104 <input type="checkbox"/> “Speed & Duplex” on page 106 <input type="checkbox"/> “TCP/UDP Checksum Offload (IPv4)” on page 108 <input type="checkbox"/> “TCP/UDP Checksum Offload (IPv6)” on page 110 <input type="checkbox"/> “VLAN ID” on page 112 <input type="checkbox"/> “Wake on Magic Packet” on page 115 <input type="checkbox"/> “Wake on Pattern Match” on page 116 <input type="checkbox"/> “WOL Speed” on page 117

Windows 8 and Server 2012

The driver software available for Windows 8 and Windows Server 2012 is version 15.6.0.3. The supported advanced properties are shown in Table 5.

Table 5. Advanced Properties for Windows 8 and Server 2012

Driver Version	Advanced Properties
15.6.0.3	<ul style="list-style-type: none"> <input type="checkbox"/> "802.3az EEE" on page 79 <input type="checkbox"/> "ARP Offload" on page 80 <input type="checkbox"/> "EEE Control Policies" on page 81 <input type="checkbox"/> "Ethernet@WireSpeed" on page 83 <input type="checkbox"/> "Flow Control" on page 84 <input type="checkbox"/> "Interrupt Moderation" on page 86 <input type="checkbox"/> "Jumbo Mtu" on page 89 <input type="checkbox"/> "Large Send Offload v2 (IPv4)" on page 93 <input type="checkbox"/> "Large Send Offload v2 (IPv6)" on page 95 <input type="checkbox"/> "Network Address" on page 98 <input type="checkbox"/> "NS Offload" on page 100 <input type="checkbox"/> "Priority & VLAN" on page 101 <input type="checkbox"/> "Receive Side Scaling" on page 103 <input type="checkbox"/> "Maximum Number of RSS Queues" on page 104 <input type="checkbox"/> "Speed & Duplex" on page 106 <input type="checkbox"/> "TCP/UDP Checksum Offload (IPv4)" on page 108 <input type="checkbox"/> "TCP/UDP Checksum Offload (IPv6)" on page 110 <input type="checkbox"/> "VLAN ID" on page 112 <input type="checkbox"/> "Wake on Magic Packet" on page 115 <input type="checkbox"/> "Wake on Pattern Match" on page 116 <input type="checkbox"/> "WOL Speed" on page 117

Accessing Advanced Properties

To modify advanced properties, first access Device Manager, open the properties of your AT-2711 series adapter card, and select a feature you want to change its setting.

1. To access the Device Manager, follow one of these procedures:
 - “Accessing Device Manager on Windows Server 2012 or Windows 8” on page 39
 - “Accessing Device Manager on Windows Server 2008, Windows Vista, or Windows 7” on page 41
 - “Accessing Device Manager on Windows Server 2003 or Windows XP” on page 42
2. In the Device Manager window, double-click **Allied Telesis AT-2711xXv2 100Mb Fiber Ethernet**.

The properties window pops up as shown in Figure 36.

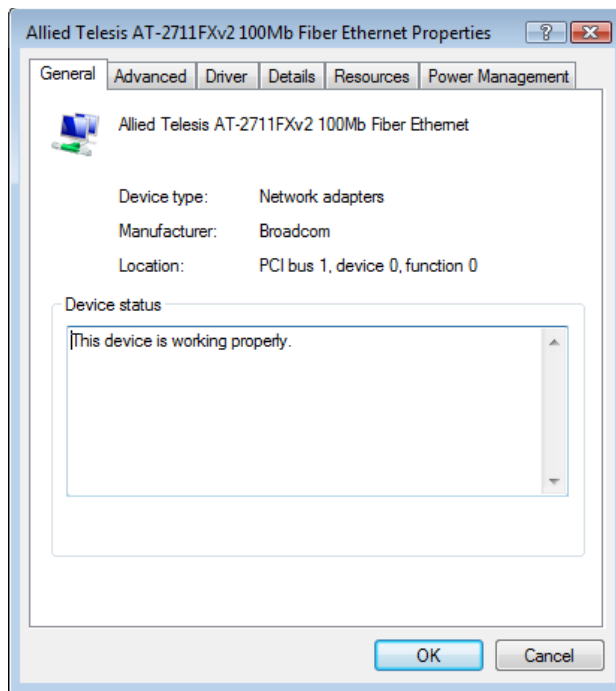

Figure 36. Properties Window

3. Click the **Advanced** tab.

The Advanced Properties window opens as shown in Figure 37.

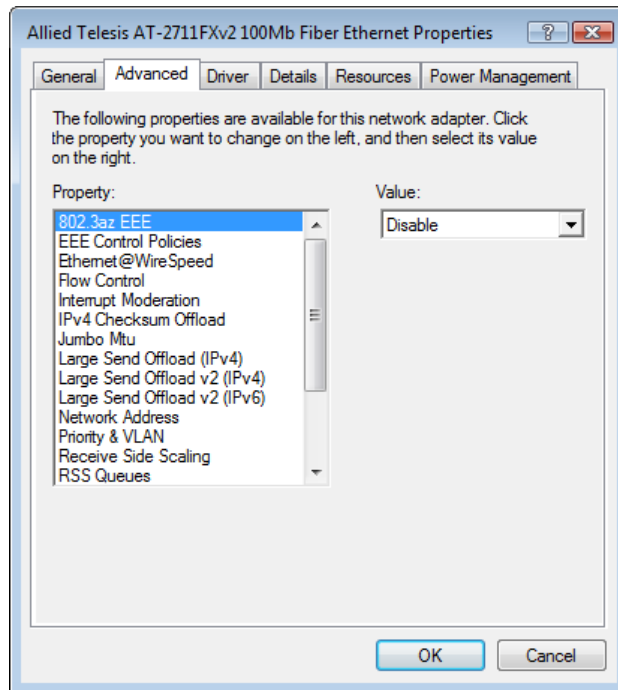

Figure 37. Advanced Properties Window

802.1p QOS

The 802.1p QOS property allows you to enable or disable the Quality of Service (QoS) feature on the adapter. QoS is a network standard for managing traffic by assigning priority to packets.

Note

Enable the 802.1p QOS property only when the network supports QoS.

To enable or disable the 802.1p QOS feature, do the following:

1. Access the Advanced Properties.

See “Accessing Advanced Properties” on page 76.

2. Select **802.1p QOS** in the Property box.

The 802.1p QOS page is displayed as shown in Figure 38.

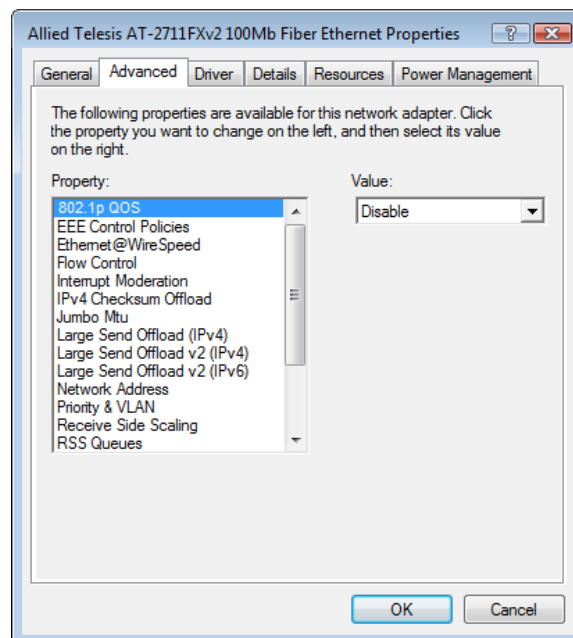

Figure 38. 802.1p QOS Page

3. Select one of the following options:

- Disable** — The 802.1p QOS feature is disabled. This is the default setting.
- Enable** — The 802.1p QOS feature is enabled.

4. Click **OK**.

802.3az EEE

The 802.3az EEE (Energy Efficient Ethernet) is an IEEE standard to optimize the energy usage of copper interfaces over Ethernet.

To view the 802.3az EEE setting, do the following:

1. Access the Advanced Properties.

See “Accessing Advanced Properties” on page 76.

2. Select **802.3az EEE** in the Property box.

The 802.3az EEE page is displayed as shown in Figure 39.

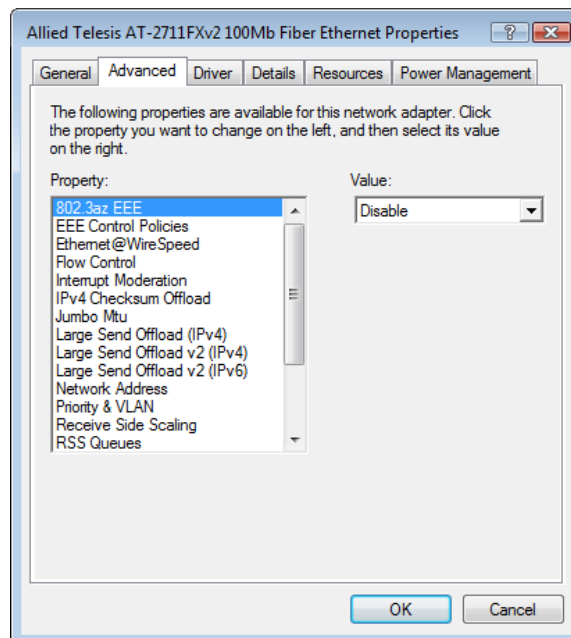

Figure 39. 802.3az EEE Page

The 802.3az EEE feature is disabled.

3. Click **OK**.

ARP Offload

The ARP Offload feature enables the adapter not to wake up when responding an ARP request. ARP is used to verify whether a computer is still present on the network and resolute an IP address into a MAC address.

To enable or disable the ARP Offload feature, do the following:

1. Access the Advanced Properties.
See “Accessing Advanced Properties” on page 76.
2. Select **ARP Offload** in the Property box.

The ARP Offload page is displayed as shown in Figure 40.

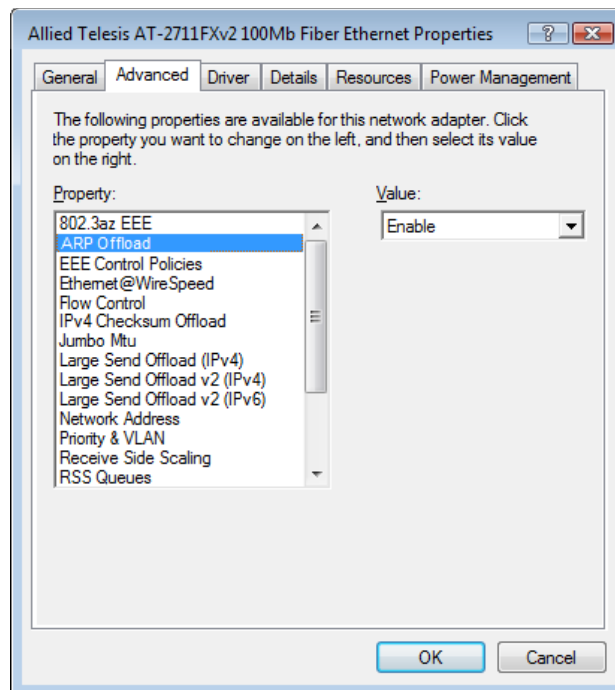

Figure 40. ARP Offload Page

3. Select one of the following options:
 - Disable** — This feature is disabled.
 - Enable** — The adapter does not wake up when responding to an ARP request. This is the default setting.
4. Click **OK**.

EEE Control Policies

The EEE (Energy-Efficient Ethernet) Control Policies feature enables the adapter to manage power for the best performance.

Note

The options and default setting depend on your operating system and driver version that you installed.

To change the setting of the EEE Control Policies feature, do the following:

1. Access the Advanced Properties.

See “Accessing Advanced Properties” on page 76.

2. Select **EEE Control Policies** in the Property box.

The EEE Control Policies page is displayed as shown in Figure 41.

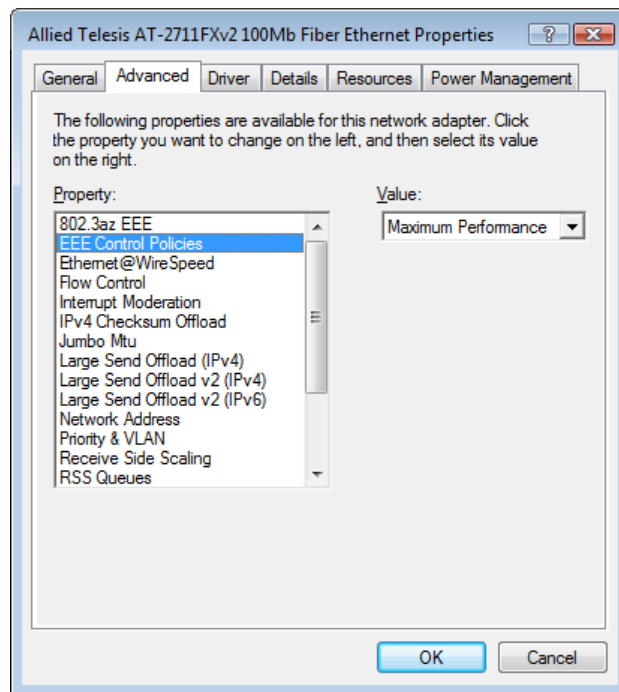

Figure 41. EEE Control Policies Page

3. Select one of the following options if available:

- Optimal Power and Performance** — The adapter manages the best trade-off between energy efficiency and performance. This is the default setting.
- Maximum Performance** — The adapter manages power for the

best performance.

- Maximum Power Saving** — The adapter manages power for the best energy saving.

4. Click **OK**.

Ethernet@WireSpeed

The Ethernet@WireSpeed is a feature to connect two gigabit devices even when the devices are connected through an impaired copper cable.

To view the Ethernet@WireSpeed setting, do the following:

1. Access the Advanced Properties.

See “Accessing Advanced Properties” on page 76.

2. Select **Ethernet@WireSpeed** in the Property box.

The Ethernet@WireSpeed page is displayed as shown in Figure 42.

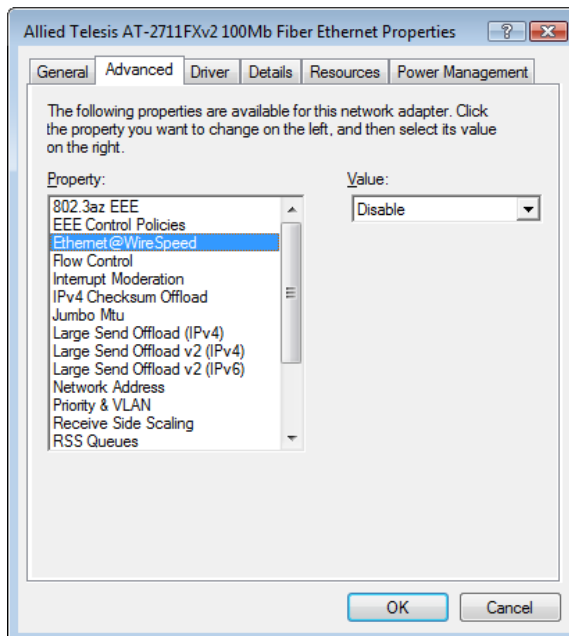

Figure 42. Ethernet@WireSpeed Page

The Ethernet@WireSpeed feature is disabled.

3. Click **OK**.

Flow Control

The Flow Control feature allows you to control the flow between the AT-2711 series adapter and its link partner. You can enable or disable the adapter to process received PAUSE frames and transmit PAUSE frames.

Note

The options and default setting depend on your operating system and driver version that you installed.

To enable or disable the Flow Control feature, do the following:

1. Access the Advanced Properties.

See “Accessing Advanced Properties” on page 76.

2. Select **Flow Control** in the Property box.

The Flow Control page is displayed as shown in Figure 43.

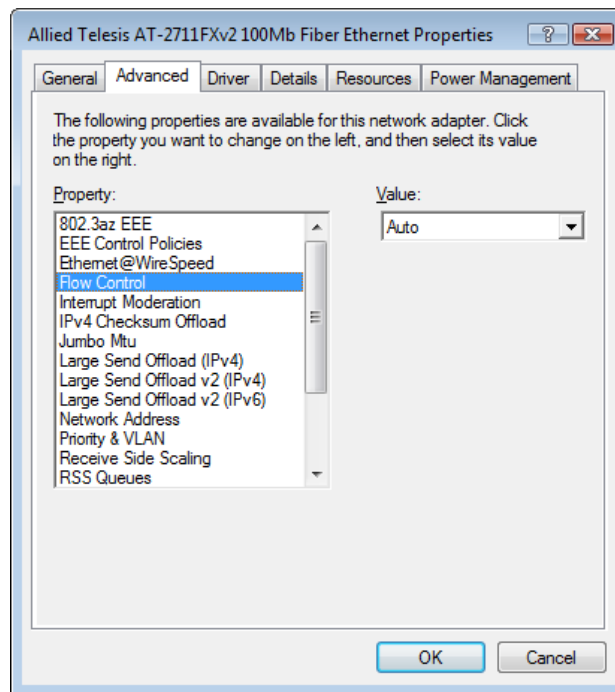

Figure 43. Flow Control Page

3. Select one of the following options:
 - Auto** — Receiving and transmitting PAUSE frames are optimized.
 - Disabled** — The adapter ignores PAUSE frames.
 - Tx & Rx Enabled (Tx/Rx PAUSE)** — The adapter processes PAUSE frames when receiving and transmits PAUSE frames.
 - Rx Enabled (Rx PAUSE)** — The adapter processes PAUSE frames when receiving, but does not transmit PAUSE frame.
 - Tx Enabled (Tx PAUSE)** — The adapter transmits PAUSE frames, but ignores PAUSE frames when receiving.
4. Click **OK**.

Interrupt Moderation

The Interrupt Moderation feature allows you to limit the rate of interrupts to the CPU during packet transmission and packet reception. When this feature is enabled, interrupts are handled as a group so that the CPU utilization decreases; however, the latency may increase.

To enable or disable the Interrupt Moderation feature, do the following:

1. Access the Advanced Properties.

See “Accessing Advanced Properties” on page 76.

2. Select **Interrupt Moderation** in the Property box.

The Interrupt Moderation page is displayed as shown in Figure 44.

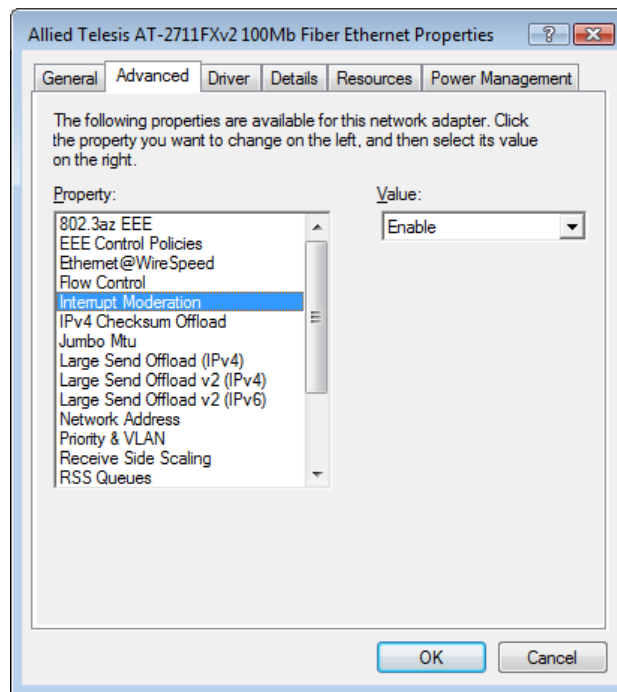

Figure 44. Interrupt Moderation Page

3. Select one of the following options:

- Disable** — The Interrupt Moderation feature is disabled
- Enable** — The Interrupt Moderation feature is enabled. This is the default setting.

4. Click **OK**.

Checksum Offload

The Checksum Offload feature allows the adapter to verify the TCP/IP checksum to enhance receive and transmit performance and reduce CPU utilization.

To enable or disable the Checksum Offload feature, do the following:

1. Access the Advanced Properties.
See “Accessing Advanced Properties” on page 76.
2. Select **Checksum Offload** in the Property box.

The Checksum Offload page is displayed as shown in Figure 45.

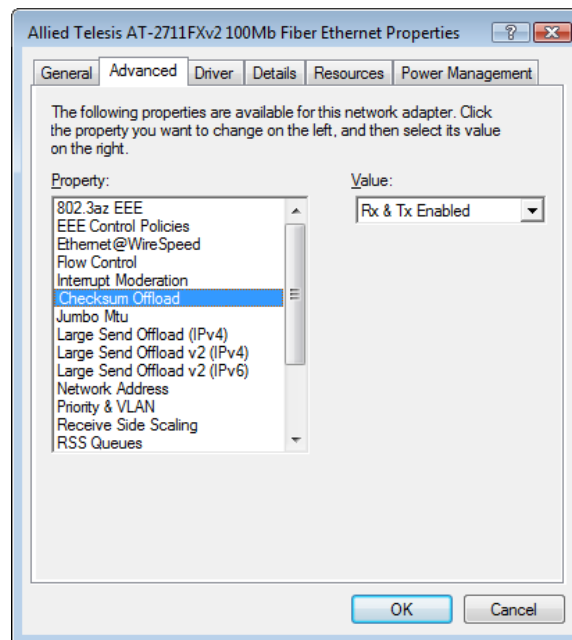

Figure 45. Checksum Offload Page

3. Select one of the following options:
 - None** — The TCP/IP Checksum feature is disabled.
 - Rx TCP/IP Checksum** — The adapter verifies TCP/IP Checksum only for receiving packets.
 - Tx TCP/IP Checksum** — The adapter verifies TCP/IP Checksum only for transmitting packets.
 - Tx/Rx TCP/IP Checksum** — The adapter verifies Checksum for both receiving and transmitting packets. This is the default setting.
4. Click **OK**.

IPv4 Checksum Offload

The IPv4 Checksum Offload feature allows the adapter to verify the IPv4 checksum to enhance IPv4 receive and transmit performance and reduce CPU utilization.

To enable or disable the IPv4 Checksum Offload feature, do the following:

1. Access the Advanced Properties.
 - See “Accessing Advanced Properties” on page 76.
2. Select **IPv4 Checksum Offload** in the Property box.

The IPv4 Checksum Offload page is displayed as shown in Figure 46.

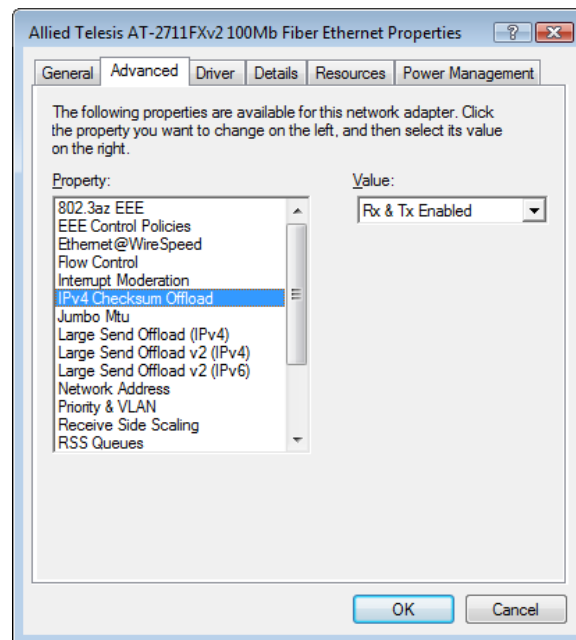

Figure 46. IPv4 Checksum Offload Page

3. Select one of the following options:
 - Rx & Tx Enabled** — The adapter verifies IPv4 Checksum for both receiving and transmitting packets. This is the default setting.
 - Disable** — The CPU verifies IPv4 checksum.
 - Rx Enabled** — The adapter verifies IPv4 Checksum only for receiving packets.
 - Tx Enabled** — The adapter verifies IPv4 Checksum only for transmitting packets.
4. Click **OK**.

Jumbo Mtu

The Jumbo Mtu (Maximum transmission unit) feature allows you to specify the size of the Ethernet frame that the adapter supports. The network performance usually improves when the larger frame size is specified; however, the network must be capable of supporting the oversized Ethernet frames.

To change the Jumbo Mtu setting, do the following:

1. Access the Advanced Properties.
See “Accessing Advanced Properties” on page 76.
2. Select **Jumbo Mtu** in the Property box.

The Jumbo Mtu page is displayed as shown in Figure 47.

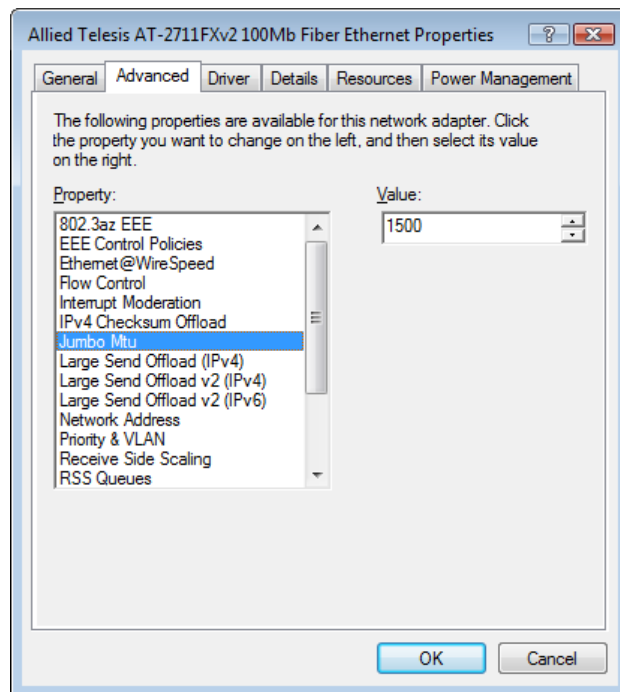

Figure 47. Jumbo Mtu Page

3. Specify the size of the frame in the Value box.

The range of the value is from 1,500 to 9,000. The default value is 1,500.

4. Click **OK**.

Large Send Offload

The Large Send Offload feature allows you to control the load of sending out large packets. When this feature is enabled, the AT-2711 series adapter segments large packets and reduces the CPU load.

To enable or disable the Large Send Offload feature, do the following:

1. Access the Advanced Properties.

See “Accessing Advanced Properties” on page 76.

2. Select **Large Send Offload** in the Property box.

The Large Send Offload page is displayed as shown in Figure 48.

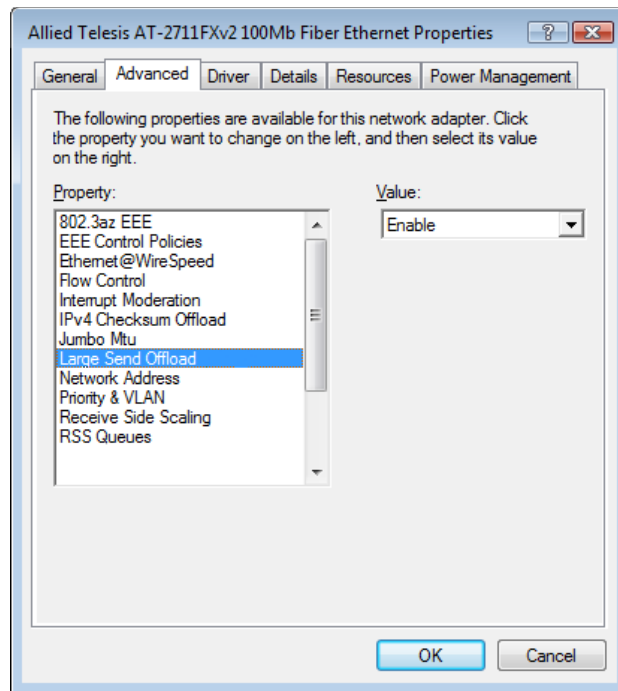

Figure 48. Large Send Offload Page

3. Select one of the following options:

- Disable** — This feature is disabled.
- Enable** — The adapter segments large packets up to 64kb before sending them out. This is the default setting.

4. Click **OK**.

Large Send Offload (IPv4)

The Large Send Offload (IPv4) feature allows you to control the load of sending out large packets. When this feature is enabled, the AT-2711 series adapter segments large packets and reduces the CPU load.

The Large Send Offload (IPv4) feature supports large packets up to 64kb. The Large Send Offload v2 (IPv4), which supports large packets up to 256kb, overrides the Large Send Offload (IPv4) feature if both features are enabled. For more information, see “Large Send Offload v2 (IPv4)” on page 93.

To enable or disable the Large Send Offload (IPv4) feature, do the following:

1. Access the Advanced Properties.

See “Accessing Advanced Properties” on page 76.

2. Select **Large Send Offload (IPv4)** in the Property box.

The Large Send Offload (IPv4) page is displayed as shown in Figure 49.

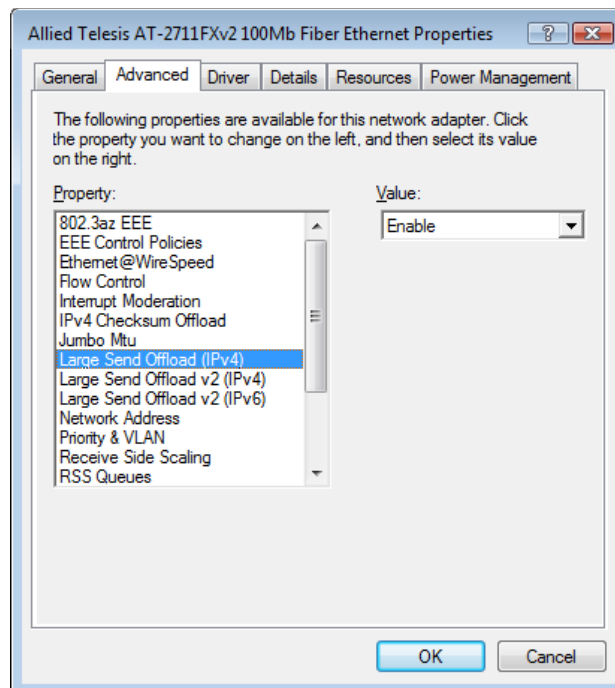

Figure 49. Large Send Offload (IPv4) Page

3. Select one of the following options:
 - Disable** — This feature is disabled.
 - Enable** — The adapter segments large packets up to 64kb for IPv4 traffic before sending them out. This is the default setting.
4. Click **OK**.

Large Send Offload v2 (IPv4)

The Large Send Offload v2 (IPv4) feature allows you to control the load of sending out large packets. When this feature is enabled, the AT-2711 series adapter segments large packets for IPv4 traffic and reduces the CPU load.

This feature, which supports large packets up to 256kb, overrides the Large Send Offload (IPv4) feature if both features are enabled.

To enable or disable the Large Send Offload v2 (IPv4) feature, do the following:

1. Access the Advanced Properties.
See “Accessing Advanced Properties” on page 76.
2. Select **Large Send Offload v2 (IPv4)** in the Property box.

The Large Send Offload v2 (IPv4) page is displayed as shown in Figure 50.

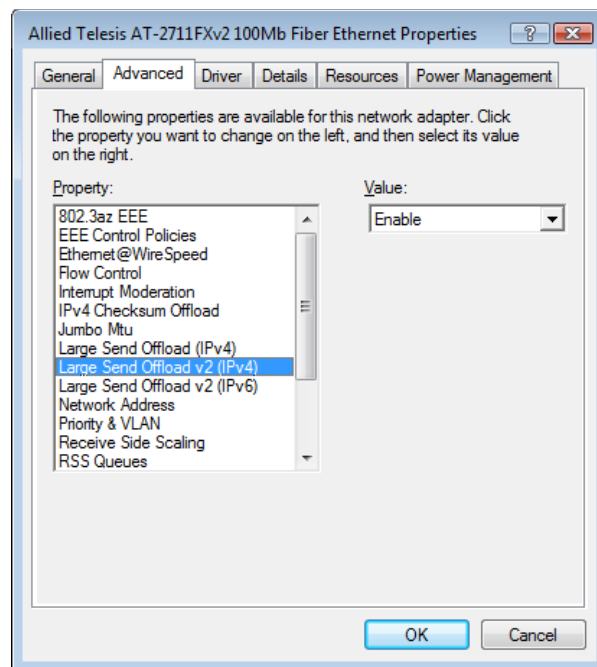

Figure 50. Large Send Offload v2 (IPv4) Page

3. Select one of the following options:
 - Disable** — The feature is disabled.
 - Enable** — The adapter segments large packets up to 256kb for IPv4 traffic before sending them out. This is the default setting.
4. Click **OK**.

Large Send Offload v2 (IPv6)

The Large Send Offload v2 (IPv6) feature allows you to control the load of sending out large packets. When this feature is enabled, the AT-2711 series adapter segments large packets for IPv6 traffic and reduces the CPU load.

To enable or disable the Large Send Offload v2 (IPv6) feature, do the following:

1. Access the Advanced Properties.
See “Accessing Advanced Properties” on page 76.
2. Select **Large Send Offload v2 (IPv6)** in the Property box.

The Large Send Offload v2 (IPv6) page is displayed as shown in Figure 51.

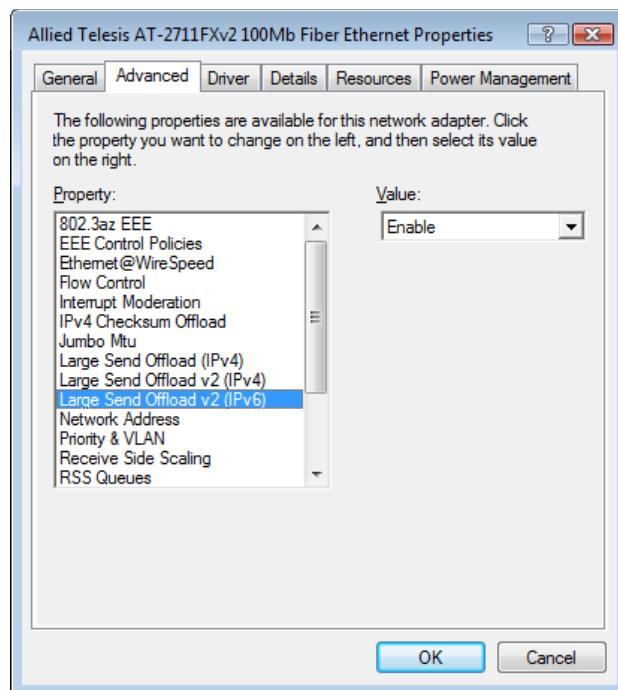

Figure 51. Large Send Offload (IPv6) Page

3. Select one of the following options:
 - Disable** — The adapter does not segment packets for IPv6 traffic.
 - Enable** — The adapter segments large packets up to 256kb for IPv6 traffic before sending them out. This is the default setting.
4. Click **OK**.

Locally Administered Address

The Locally Administered Address allows you to replace the MAC address originally assigned to the adapter with a user-defined address. The user-defined address that you assign to the adapter is called a locally administered address.



Caution

A locally administered address overrides the original MAC address stored in the AT-2711 series adapter card. When you change the MAC address, ensure that a unique MAC address is assigned.

Guidelines for Assigning a Locally Administered Address

Here are guidelines for assigning a locally administered address:

- The address must be unique.
- The address consists of a 12-digit hexadecimal number, for example, "020C46005501."
- The address must start with "02" in the most significant byte, for example, "020304050607."
- Do not assign "0000 0000 0000" or "FFFF FFFF FFFF."
- The range is from 0200 0000 0000 to 02FF FFFF FFFF.

Assigning the Locally Administered Address

To assign or change the Locally Administered Address, do the following:

1. Access the Advanced Properties.

See "Accessing Advanced Properties" on page 76.

2. Select **Locally Administered Address** in the Property box.

The Locally Administered Address page is displayed as shown in Figure 52 on page 97.

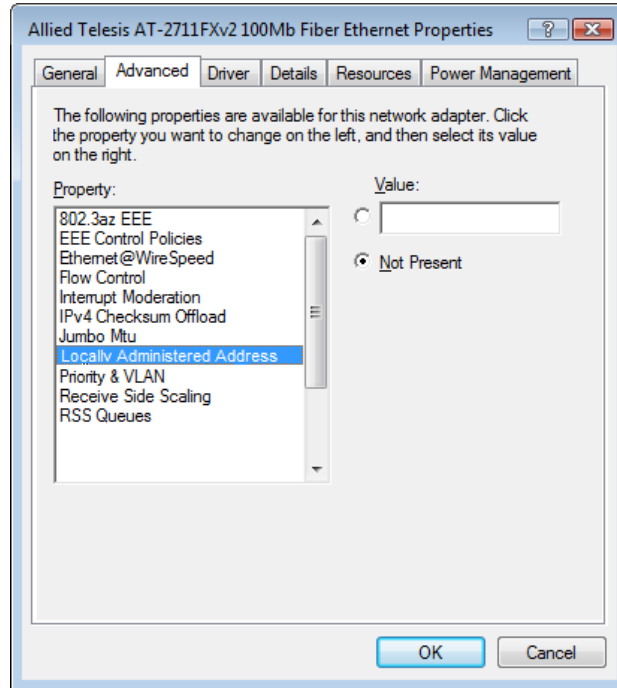

Figure 52. Locally Administered Address Page

3. In the **Value** text box, enter a locally administered address for the AT-2711 series adapter card.

By default, no locally administered address is assigned.

For more information, see “Guidelines for Assigning a Locally Administered Address” on page 96.

4. Click **OK**.

Network Address

The Network Address property allows you to replace the MAC address originally assigned to the adapter with a user-defined address. The user-defined address that you assign to the adapter is called a locally administered address.



Caution

The network address overrides the original MAC address stored in the AT-2711 series adapter card. When you change the MAC address, ensure that a unique MAC address is assigned.

To assign or change the Network Address, do the following:

1. Access the Advanced Properties.

See “Accessing Advanced Properties” on page 76.

2. Select **Network Address** in the Property box.

The Network Address page is displayed as shown in Figure 53.

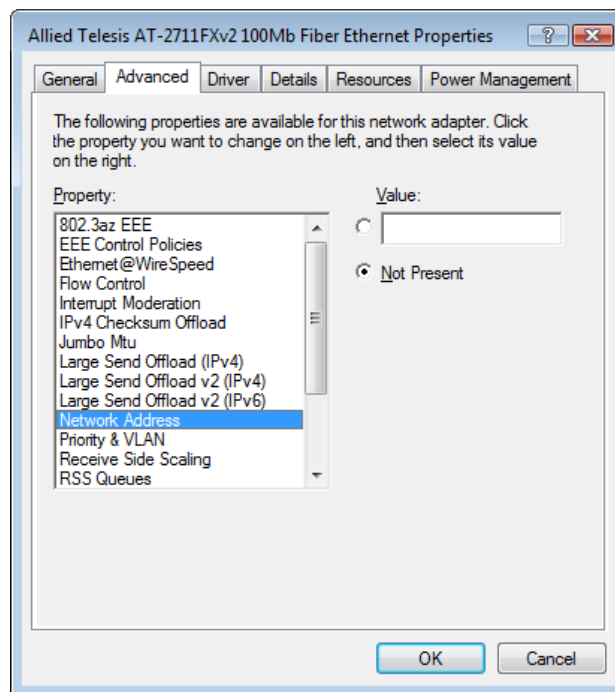

Figure 53. Network Address Page

3. In the **Value** text box, enter a locally administered address for the AT-2711 series adapter card.

By default, no locally administered address is assigned.

For more information, see “Guidelines for Assigning a Locally Administered Address” on page 96.

4. Click **OK**.

NS Offload

The NS (Neighbor Solicitation) Offload feature enables the adapter not to wake up when responding to an NS request.

To enable or disable the NS Offload feature, do the following:

1. Access the Advanced Properties.

See “Accessing Advanced Properties” on page 76.

2. Select **NS Offload** in the Property box.

The NS Offload page is displayed as shown in Figure 54.

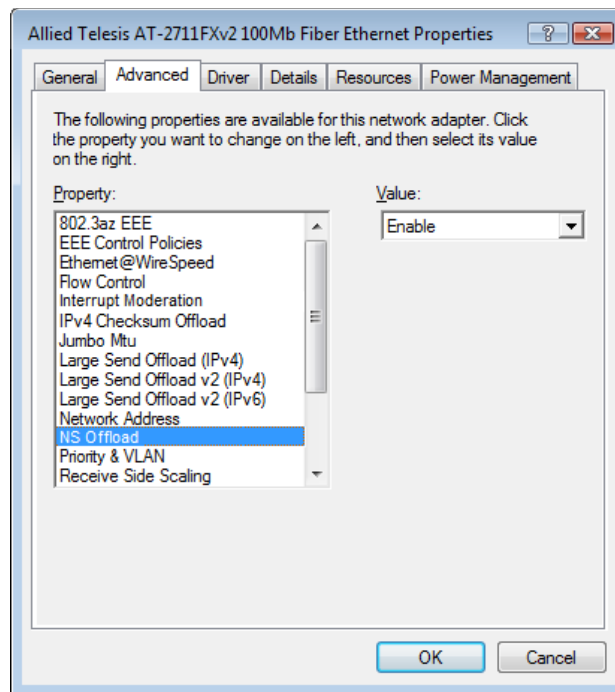

Figure 54. NS Offload Page

3. Select one of the following options:

- Disable** — This feature is disabled.
- Enable** — The adapter does not wake up when responding to an NS request. This is the default setting.

4. Click **OK**.

Priority & VLAN

The Priority & VLAN feature allows you to control sending and receiving tagged frames of QoS and VLAN.

When the property is set to Priority & VLAN Enabled, the adapter sends and receives QoS and VLAN tagged frames; with Priority Enabled, the adapter sends and receives QoS tagged frames; with VLAN Enabled, the adapter sends and receives VLAN tagged frames. To assign a VLAN ID to the adapter, see “VLAN ID” on page 112.

To enable or disable the Priority & VLAN feature, do the following:

1. Access the Advanced Properties.

See “Accessing Advanced Properties” on page 76.

2. Select **Priority & VLAN** in the Property box.

The Priority & VLAN page is displayed as shown in Figure 55.

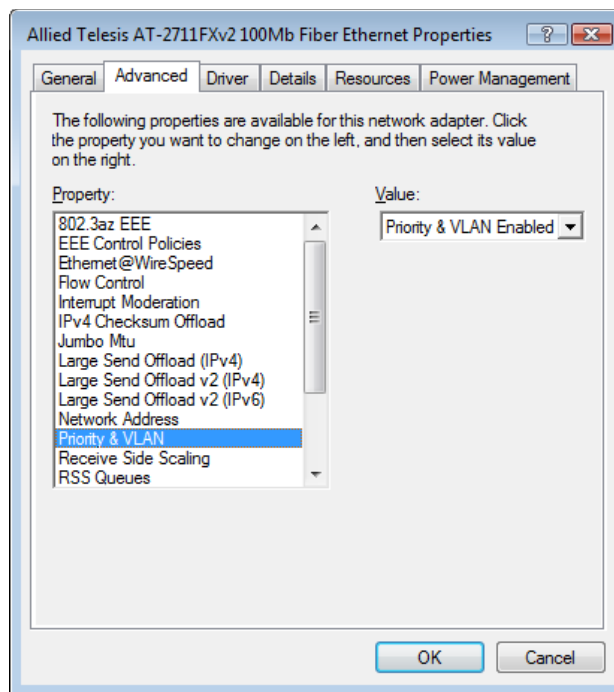

Figure 55. Priority & VLAN Page

3. Select one of the following options:
 - Priority & VLAN Enabled** — The adapter sends and receives QoS and VLAN tagged frames. This is the default setting.
 - Priority & VLAN Disabled** — The adapter does not send and ignores QoS and VLAN tagged frames.
 - Priority Enabled** — The adapter sends and receives QoS tagged frames.
 - VLAN Enabled** — The adapter sends and receives VLAN tagged frames.
4. Click **OK**.

Receive Side Scaling

The Receive Side Scaling (RSS) feature allows the adapter to efficiently distribute receive processing across multiple CPU's and to prevent from overloading a single CPU. To make this feature effective, the computer must have multiple CPU's in a multiprocessor system.

To enable or disable the Receive Side Scaling feature, do the following:

1. Access the Advanced Properties.

See "Accessing Advanced Properties" on page 76.

2. Select **Receive Side Scaling** in the Property box.

The Receive Side Scaling page is displayed as shown in Figure 56.

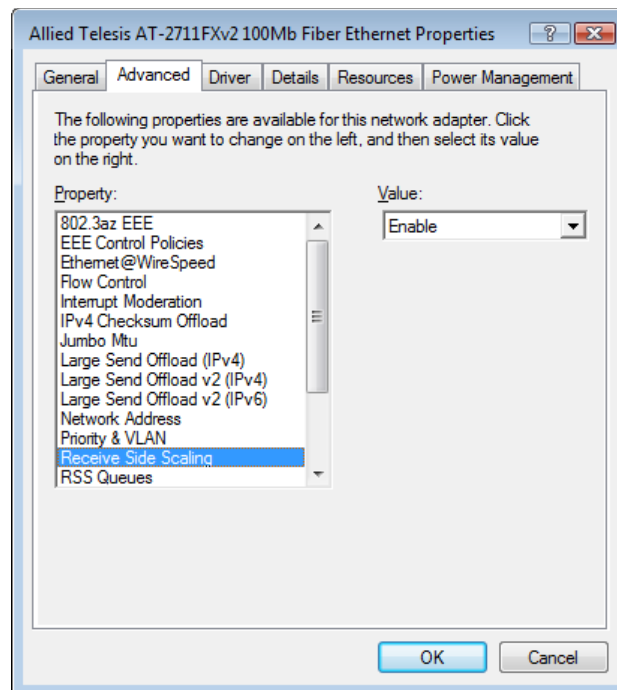

Figure 56. Receive Side Scaling Page

3. Select one of the following options:

- Enable** — Receiving data is processed by multiple CPU's. This is the default setting.
- Disable** — Receiving data is processed by a single CPU.

4. Click **OK**.

Maximum Number of RSS Queues

The Maximum Number of RSS Queues property allows you to specify the maximum number of RSS queues that the adapter assigns receiving data to.

To Specify the Maximum Number of RSS Queues, do the following:

1. Access the Advanced Properties.

See “Accessing Advanced Properties” on page 76.

2. Select **Maximum Number of RSS Queues** in the Property box.

The Maximum Number of RSS Queues page is displayed as shown in Figure 57.

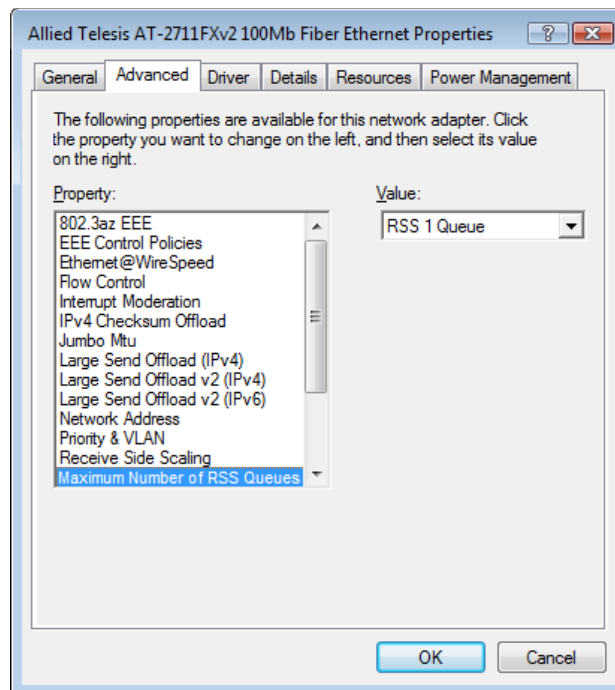

Figure 57. Maximum Number of RSS Queues Page

3. Select one of the following options:

- RSS 1 Queue** — The system allocates one RSS queue. This is the default setting.
- RSS 2 Queues** — The system allocates two RSS queues.
- RSS 4 Queues** — The system allocates four RSS queues.

4. Click **OK**.

RSS Queues

The RSS Queues feature allocates queue space between the adapter and processor, and allows you to specify the number of RSS queues that the adapter assigns receiving data to.

To Specify the RSS Queues value, do the following:

1. Access the Advanced Properties.
See “Accessing Advanced Properties” on page 76.
2. Select **RSS Queues** in the Property box.

The RSS Queues page is displayed as shown in Figure 58.

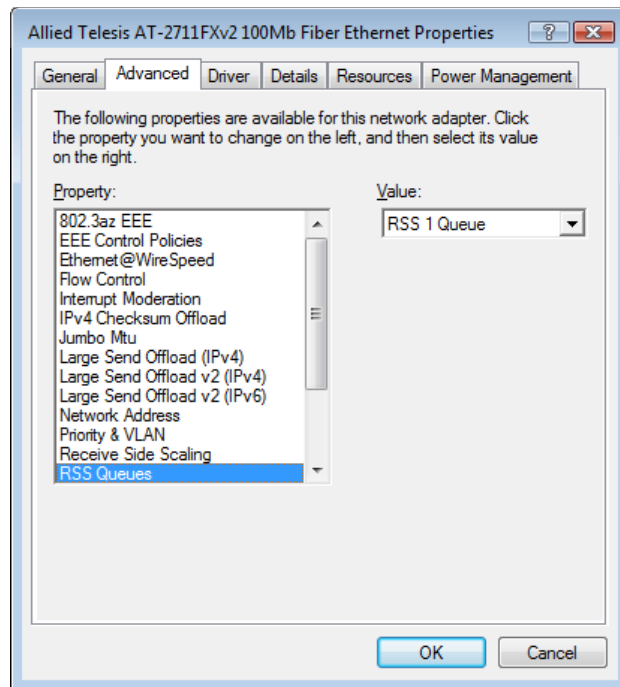

Figure 58. RSS Queues Page

3. Select one of the following options:
 - RSS 1 Queue** — The system allocates one RSS queue. This is the default setting.
 - RSS 2 Queues** — The system allocates two RSS queues.
 - RSS 4 Queues** — The system allocates four RSS queues.
4. Click **OK**.

Speed & Duplex

The Speed & Duplex feature sets the link speed and duplex mode of the adapter.

Note

When you change the duplex mode of the adapter, change the duplex mode of the link partner, such as a switch. The mismatch duplex mode may degrade performance and cause CRC errors.

To change the Speed & Duplex property, do the following:

1. Access the Advanced Properties.

See “Accessing Advanced Properties” on page 76.

2. Select **Speed & Duplex** in the Property box.

The Speed & Duplex page is displayed as shown in Figure 59.

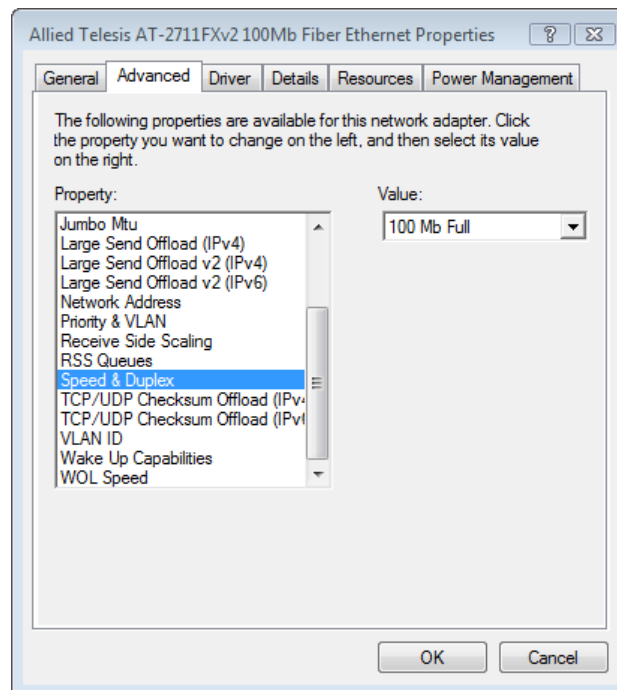

Figure 59. Speed & Duplex Page

3. Select one of the following options:
 - 100 Mb Full (100 Mbps Full Duplex)** — 100 Mbps speed in the half duplex mode. This is the default setting.
 - 100 Mb Half (100 Mbps Half Duplex)** — 100 Mbps speed in the full duplex mode. This is the default setting.
4. Click **OK**.

TCP/UDP Checksum Offload (IPv4)

The TCP/UDP Checksum Offload (IPv4) function enables the adapter to compute the checksum of transmitting IPv4 packets and verify the checksum of receiving IPv4 packets, taking load off from the CPU.

To modify the TCP/UDP Checksum Offload (IPv4) setting, do the following:

1. Access the Device Manager on your operating system.
See “Accessing Advanced Properties” on page 76.
2. Select **TCP/UDP Checksum Offload (IPv4)** in the Property box.

The TCP/UDP Checksum Offload (IPv4) page is displayed as shown in Figure 60.

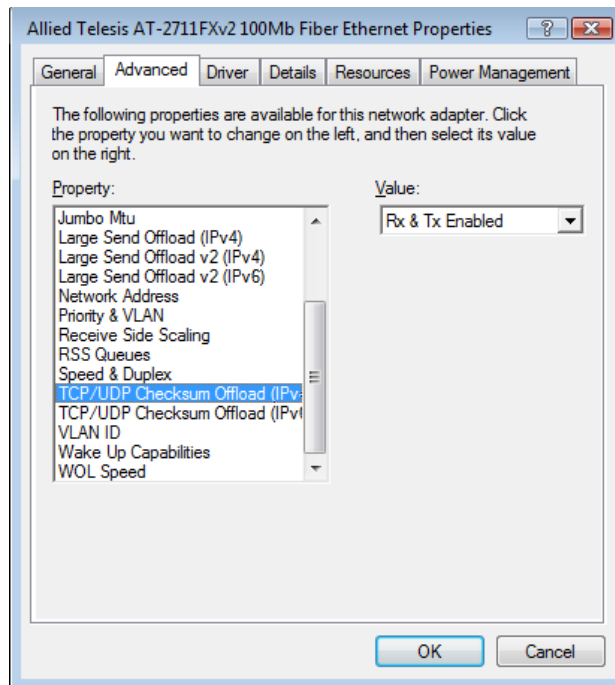

Figure 60. TCP/UDP Checksum Offload (IPv4) Page

3. Select one of the following options:
 - Rx & Tx Enabled** — Enables the TCP/UDP Checksum Offload (IPv4) function for both receiving and transmitting IPv4 packets. This is the default setting.
 - Disabled** — Disables the TCP/UDP Checksum Offload (IPv4) function for both receiving and transmitting.
 - Rx Enabled** — Enables the TCP/UDP Checksum Offload (IPv4) function only for receiving IPv4 packets.
 - Tx Enabled** — Enables the TCP/UDP Checksum Offload (IPv4) function only for transmitting IPv4 packets.
4. Click **OK**.

TCP/UDP Checksum Offload (IPv6)

The TCP/UDP Checksum Offload (IPv6) function enables the adapter to compute the checksum of transmitting IPv6 packets and verify the checksum of receiving IPv6 packets, taking load off from the CPU.

To enable or disable the TCP/UDP Checksum Offload (IPv6) feature, do the following:

1. Access the Device Manager on your operating system.

See “Accessing Advanced Properties” on page 76.

2. Select **TCP/UDP Checksum Offload (IPv6)** in the Property box.

The TCP/UDP Checksum Offload (IPv6) page is displayed as shown in Figure 61.

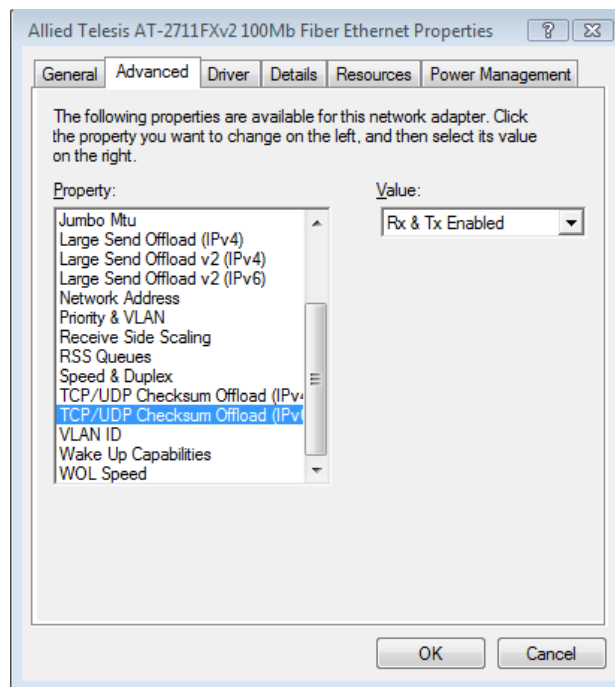

Figure 61. TCP/UDP Checksum Offload (IPv6) Page

3. Select one of the following options:
 - Rx & Tx Enabled** — Enables the TCP/UDP Checksum Offload (IPv6) function for both receiving and transmitting IPv6 packets. This is the default setting.
 - Disabled** — Disables the TCP/UDP Checksum Offload (IPv6) function for both receiving and transmitting.
 - Rx Enabled** — Enables the TCP/UDP Checksum Offload (IPv6) function only for receiving IPv6 packets.
 - Tx Enabled** — Enables the TCP/UDP Checksum Offload (IPv6) function only for transmitting IPv6 packets.
4. Click **OK**.

VLAN ID

The VLAN ID property allows you to specify a VLAN ID on your network to the adapter. The adapter adds the value of the VLAN ID to a frame in the VLAN tag before transmitting the frame.

To change the VLAN ID value, do the following:

1. Access the Advanced Properties.

See “Accessing Advanced Properties” on page 76.

2. Select **VLAN ID** in the Property box.

The VLAN ID page is displayed as shown in Figure 62.

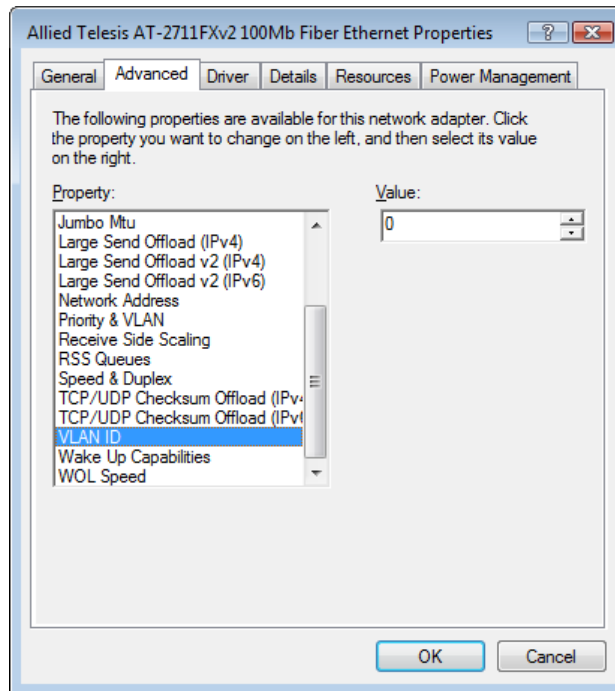

Figure 62. VLAN ID Page

3. Specify an VLAN ID in the Value box.

The range of the value is from 0 to 4094. The default value is 0.

4. Click **OK**.

Wake Up Capabilities

The Wake Up Capabilities feature enables the network adapter to wake up from a low-power mode when the adapter receives a network wake-up data unit. Two types of wake-up data units can be accepted: Magic packet and Wake Up frame.

To change the Wake Up Capabilities property, do the following:

1. Access the Advanced Properties.
See “Accessing Advanced Properties” on page 76.
2. Select **Wake Up Capabilities** in the Property box.

The Wake Up Capabilities page is displayed as shown in Figure 63.

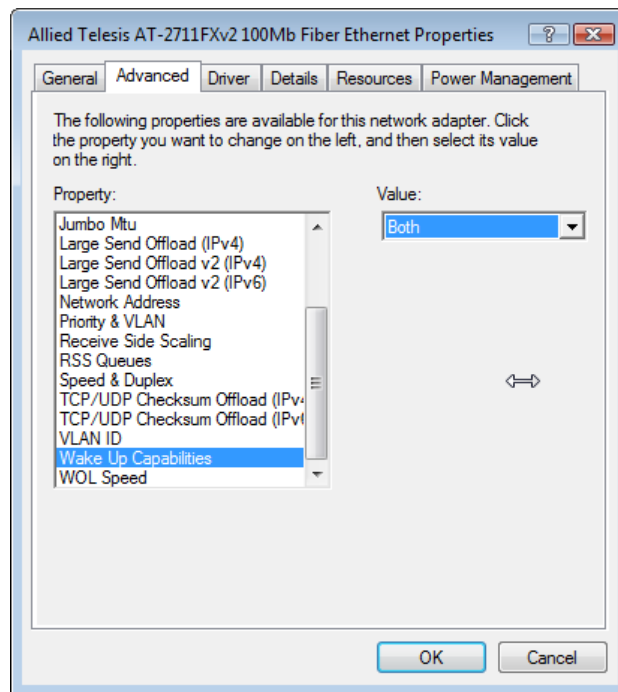

Figure 63. Wake Up Capabilities Page

3. Select one of the following options:
 - Both** — The adapter wakes up from a low-power mode when receiving a Magic packet or Wake Up frame. This is the default setting.
 - Magic Packet** — The adapter wakes up from a low-power mode when receiving a Magic packet.
 - None** — The adapter stays in a low-power mode.
 - Wake Up Frame** — The adapter wakes up from a low-power mode when receiving a Wake Up frame.
4. Click **OK**.

Wake on Magic Packet

The Wake on Magic Packet feature enables the network adapter to wake up from a low-power mode when the adapter receives a Magic packet.

To enable or disable the Wake on Magic Packet feature, do the following:

1. Access the Advanced Properties.

See “Accessing Advanced Properties” on page 76.

2. Select **Wake on Magic Packet** in the Property box.

The Wake on Magic Packet page is displayed as shown in Figure 63.

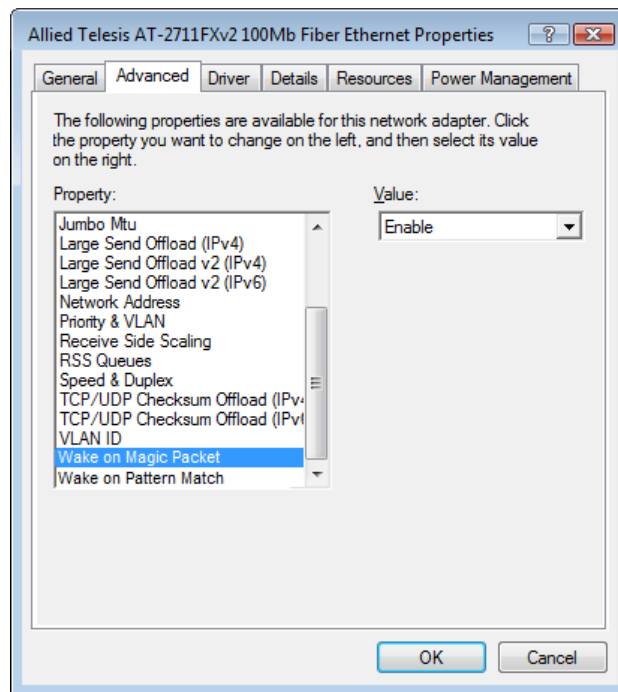

Figure 64. Wake on Magic Packet Page

3. Select one of the following options:

- Enable** — The adapter wakes up from a low-power mode when receiving a Magic Packet. This is the default setting.
- Disable** — The adapter stays in a low-power mode when receiving a Magic Packet.

4. Click **OK**.

Wake on Pattern Match

The Wake on Pattern Match feature enables the network adapter to wake up from a low-power mode when the packet matches the wake patterns specified in the operating system.

To enable or disable the Wake on Pattern Match feature, do the following:

1. Access the Advanced Properties.

See “Accessing Advanced Properties” on page 76.

2. Select **Wake on Pattern Match** in the Property box.

The Wake on Pattern Match page is displayed as shown in Figure 63.

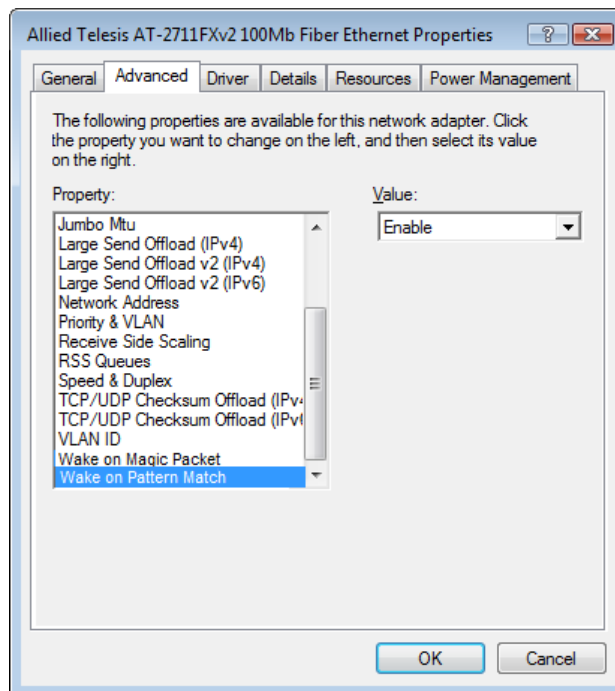

Figure 65. Wake on Pattern Match Page

3. Select one of the following options:

- Enable** — The adapter wakes up from a low-power mode when receiving a packet that matches one of the patterns specified in the operating system.
- Disable** — The adapter stays in a low-power mode.

4. Click **OK**.

WOL Speed

The WOL Speed property indicates the speed of Wake-on-LAN setting on your adapter.

To view this setting, do the following:

1. Access the Advanced Properties.

See “Accessing Advanced Properties” on page 76.

2. Select **WOL Speed** in the Property box.

The WOL Speed page is displayed as shown in Figure 63.

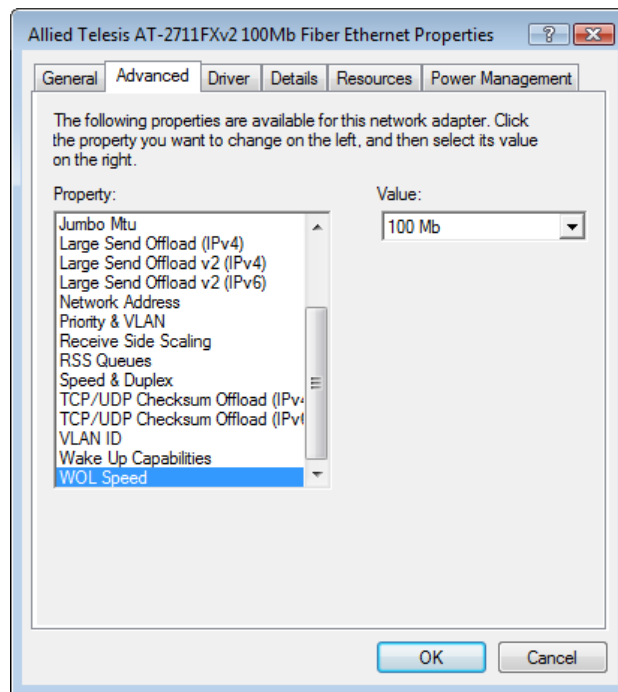

Figure 66. WOL Speed Page

The WOL Speed is set to 100Mb and has no option.

3. Click **OK**.

Chapter 6

Uninstalling the Driver Software

This chapter describes how to uninstall the driver software for the AT-2711 series adapter.

This chapter contains the following topics:

- ❑ “Overview” on page 120
- ❑ “Uninstalling the Driver Software Using Device Manager” on page 121
- ❑ “Uninstalling the Driver Software Silently” on page 122

Overview

When you no longer use the AT-2711 series adapter card for your computer, you may want to uninstall the driver software from your operating system.

As you can install driver software for the AT-2711 series adapter card using Device Manager or the silent installation method, you can also uninstall driver software in two ways:

- ❑ “Uninstalling the Driver Software Using Device Manager” on page 121
- ❑ “Uninstalling the Driver Software Silently” on page 122

Guidelines

Here are the guidelines to uninstalling the driver software from your system:

- ❑ You must have Administrator privileges to remove the driver software.
- ❑ Before uninstalling the Allied Telesis device, capture all of the Advanced Property settings for later use. The properties are lost during the uninstall process.

Uninstalling the Driver Software Using Device Manager

To uninstall the driver software from your operating system, do the following:

1. Start your Windows operating system and log in.
2. Access the Device Manager.
See “Accessing the Device Manager” on page 39.
3. In the Device Manager window, expand the Network Adapters folder.
4. Right-click **Allied Telesis AT-2711xXv2 xx 100Mb Fiber Ethernet**.

The shortcut menu appears. See Figure 34 on page 56.

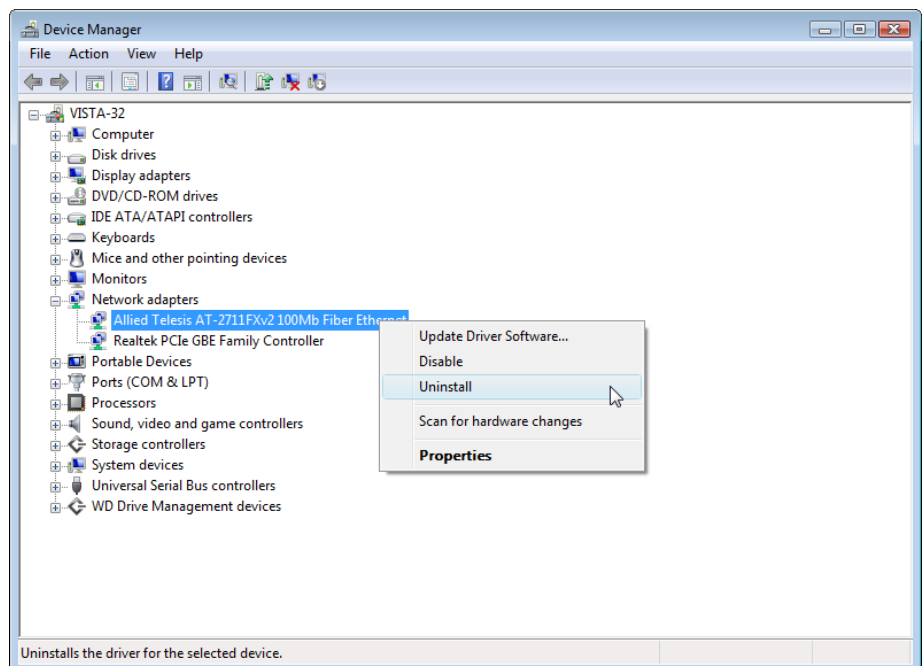

Figure 67. Confirm Device Uninstall Window

5. Select **Uninstall**.

The Confirm Device Uninstall window pops up.

6. Check the check box if you want to remove the driver software for your adapter.
7. Click **OK** to complete the uninstall.

Uninstalling the Driver Software Silently

You can apply the silent installation method to uninstall the driver.

Uninstall the driver without user-intervention, perform the following steps:

1. Open a command prompt window with administrator privileges.
2. Change the directory to the folder where the `dpinst` utility and the driver files reside.
3. Uninstall the driver silently by executing the following command:

```
> dpinst /U inf_file_name.inf /S
```

Note

Replace *inf_file_name* with the name of `.inf` file.

The driver is uninstalled without user-intervention.

Chapter 7

Troubleshooting

This chapter describes troubleshooting procedures. It contains the following sections:

- ❑ “Checking the Port LED on the Adapter” on page 124
- ❑ “Troubleshooting Checklist” on page 125
- ❑ “Testing Network Connectivity” on page 126

Checking the Port LED on the Adapter

The AT-2711 fiber adapter card has one port LED. You can use the status of the port LED for troubleshooting.

Note

Before the port LED can provide troubleshooting information, the driver software for your particular operating system must be installed and the adapter must be connected to the network. See Chapter 3, “Installing the Driver Software for Windows Systems” on page 35.

Table 6 describes the link states that the LED indicates.

Table 6. Fiber Optic Port 100 LED Status

State	Description
On	The port is operating at 100 Mbps and has a valid link.
Off	No valid link is present.
Flashing	The port is receiving or transmitting network packets at 100 Mbps.

Troubleshooting Checklist

The following checklist provides recommended actions to take to resolve problems installing the AT-2711 series network adapter card or running it in your system.



Warning

Before opening the cabinet of your system for removing or inserting the adapter card, review all precautions outlined under “Reviewing Safety Precautions” on page 25.

- Inspect all cables and connections. Verify that the cable connections between the adapter and the switch are attached properly. Make sure that the cable length and rating are compliant with the requirements listed in “Connecting the Network Cables” on page 34.”
- Check the adapter installation by reviewing Chapter 2, “Installing the Hardware” on page 23.
- Make sure that the adapter card is properly seated in a PCIe slot. Check for specific hardware problems, such as obvious damage to board components or the PCIe edge connector.
- Check the configuration settings and change them if they are in conflict with another device.
- Make sure that your system is using the latest BIOS.
- Try inserting the adapter card in another slot. If the new position works, the original slot in your system may be defective.
- Replace the failed adapter card with one that is known to work properly. If the second adapter card works in the slot where the first one failed, the original adapter card is probably defective.
- Install the adapter card in another functioning system and run the tests again. If the adapter card passed the tests in the new system, the original system may be defective.
- Remove all other adapter cards from the system and run the tests again. If the adapter card passes the tests, the other adapter cards may be causing contention.

Testing Network Connectivity

This section describes how to test network connectivity for Windows and Linux networks.

Note

Both the adapter and the switch must be set to the same speed and duplex mode. Set the adapter and switch to either 100Mb in the full duplex mode or 100Mb in the half duplex mode.

Windows To test the network connectivity for the Windows driver software, perform the following procedure.

Use the ping command to determine if network connectivity is working.

1. Select **Run** from the Windows Control Panel

The Run command window opens, as shown in Figure 68.

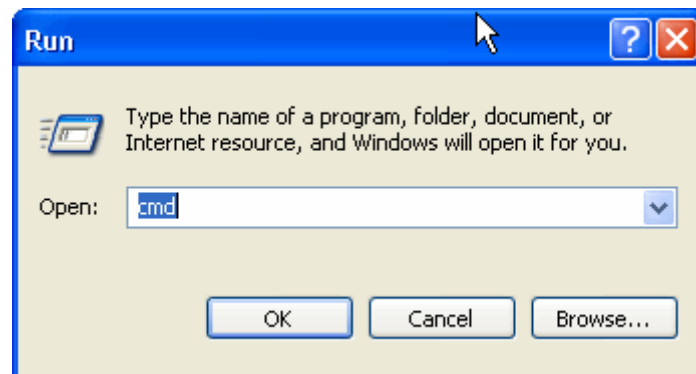

Figure 68. Run Command Window

2. Type **cmd** and click **OK**.
3. Type **ipconfig /all**

The command window opens, as shown in Figure 69 on page 127.

```

D:\>ipconfig /all

Windows IP Configuration

    Host Name . . . . . : whitebox
    Primary Dns Suffix . . . . . :
    Node Type . . . . . : Unknown
    IP Routing Enabled. . . . . : No
    WINS Proxy Enabled. . . . . : No
    DNS Suffix Search List. . . . . : netatnic.local

Ethernet adapter Local Area Connection 9:

    Connection-specific DNS Suffix . : netatnic.local
    Description . . . . . : Allied Telesyn AT-2711FX 100Mb Fiber
Ethernet Adapter #6
    Physical Address. . . . . : 00-10-18-C4-63-38
    Dhcp Enabled. . . . . : Yes
    Autoconfiguration Enabled . . . . . : Yes
    IP Address. . . . . : 192.162.1.46
    Subnet Mask . . . . . : 255.255.255.0
    Default Gateway . . . . . : 192.162.1.1
    DHCP Server . . . . . : 192.162.1.23
    DNS Servers . . . . . : 192.162.1.1
                          192.162.1.23
    Lease Obtained. . . . . : Wednesday, June 28, 2006 9:29:19 AM
    Lease Expires . . . . . : Wednesday, July 05, 2006 1:29:19 PM

D:\>

```

Figure 69. Command Window with ipconfig/all displayed

4. Type **ping** *IP_address* from the command line, then press **Enter**.

The network connectivity information is displayed, as shown in Figure 70.

```

D:\>ping 192.162.1.1

Pinging 192.162.1.1 with 32 bytes of data:

Reply from 192.162.1.1: bytes=32 time<1ms TTL=64
Reply from 192.162.1.1: bytes=32 time<1ms TTL=64
Reply from 192.162.1.1: bytes=32 time<1ms TTL=64
Reply from 192.162.1.1: bytes=32 time<1ms TTL=64

Ping statistics for 192.162.1.1:
    Packets: Sent = 4, Received = 4, Lost = 0 (0% loss),
    Approximate round trip times in milli-seconds:
        Minimum = 0ms, Maximum = 0ms, Average = 0ms

D:\>

```

Figure 70. Command Window with ping displayed

Linux To verify that the Ethernet interface is up and running, run 'ifconfig' to check the status of the Ethernet interface. In addition, you can use the 'netstat -i' command to check the statistics on the Ethernet interface. Consult the manual pages for more information about the 'ifconfig' and 'netstat' commands.

To ping an IP host on the network to verify connection has been established, perform the following procedure:

1. From the command line, type **ping *IP_address***.
2. Press **Enter**.

The command displays the packet send/receive status.

Appendix A

Specifications

Physical Specifications

Dimensions: 7.7 cm x 6.9 cm (3.0 in. x 2.7 in.)

Weight: 50 g (1.76 oz)

Environmental Specifications

Operating Temperature: 0°C to 50°C (+32°F to +122°F) at full load

Storage Temperature: -25°C to +70°C (-13°F to +158°F)

Relative Humidity: 5% to 90%, non-condensing

Power Specifications

Signaling Voltage: 3.3V

Power Consumption: 2.0 Watts max

Maximum Cabling Distances

Up to 2000m (6,560 ft.) in the full-duplex mode

Up to 412m (1,351 ft.) in the half-duplex mode

Appendix B

Cleaning Fiber Optic Connectors

This appendix provides how to clean fiber optic connectors and consists of the following sections:

- “Overview” on page 132
- “Cleaning Using a Cartridge-Type Cleaner” on page 133
- “Cleaning Using a Swab” on page 135

Overview

The fiber optic connector consists of a fiber optic plug and its adapter. The end of the fiber optic cable is held in the core of the ferrule in the plug as shown in Figure 71. Light signals are transmitted through the core of the fiber.

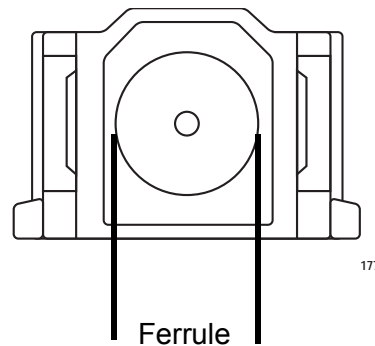

Figure 71. Ferrule in an SC Connector Plug

Even minor smudges or dirt on the end face of the fiber, completely invisible to the naked eye, can disrupt light transmission and lead to failure of the component or of the entire system. Figure 72 shows part of the end face of an unclean and clean ferrule.

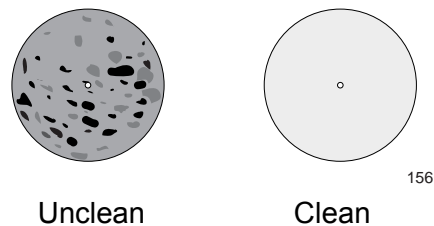

Figure 72. Unclean and Clean Ferrule

Guidelines

Here are general guidelines and warnings for fiber optic connectors:

- Always keep a dust cap on a fiber optic cable when it is not in use.
- Do not touch the end face of the ferrule in the connector.



Warning

Do not stare into the laser beam.  2



Warning

Do not look directly at the cable ends or inspect the cable ends with an optical lens.  31

Cleaning Using a Cartridge-Type Cleaner

Fiber optic cartridge cleaners are available from many vendors and are typically called “cartridge cleaners,” as shown in Figure 73.



Figure 73. Cartridge Cleaner

Note

Do not use compressed air or aerosol air to clean a fiber optic connector.

To clean a fiber optic connector using a cartridge cleaner, perform the following procedure:

1. With one hand, hold the cartridge cleaner and push the lever on the cleaning cartridge in the direction of the arrow to expose the cleaning surface, as shown in Figure 74.

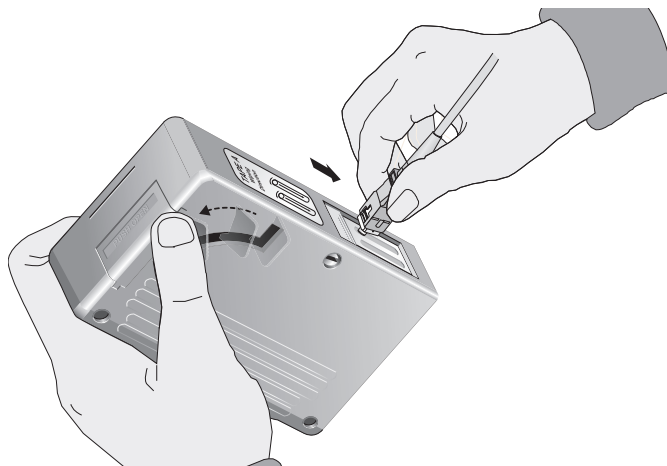

Figure 74. Rubbing the Ferrule Tip on the Cleaning Surface

2. Place the ferrule tip on the exposed cleaning surface and rub the ferrule in a downward direction, as shown in Figure 74.

Note

Rub the ferrule tip on the cleaning surface in one direction only.

3. When you reach the end of the cleaning surface, pick up the ferrule tip, rotate and place it at the top and rub downwards at least 2 times.



Caution

Failing to pick up the ferrule tip when you reach the bottom of the cleaning surface can result in static electricity that can damage the fiber optic cable.

4. If desired, repeat steps 2 and 3.
5. If a fiber inspection scope is available, use the scope to inspect the ferrule end face to make sure that it is clean.
6. Reconnect the cable to the port or protect the ferrule tip with a dust cap.

Cleaning Using a Swab

Specially treated swabs (stick cleaners) are available for cleaning inside connector adapters or hard-to-reach ferrule tips. These swabs, often referred to as “lint free” or “alcohol free” swabs, are available from many vendors. See Figure 75. Stick cleaners are available in both 2.5 mm and 1.25 mm sizes for use on SC and MU connectors respectively.

Note

NEVER use a household cotton swab and/or alcohol to clean a fiber optic connector. A cotton swab or alcohol may leave a residue on the ferrule tip.

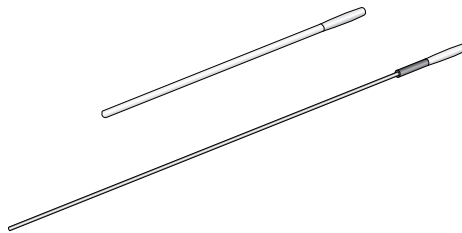

Figure 75. Lint-Free and Alcohol-Free Swabs

Note

Do not use compressed air or aerosol air to clean a fiber optic connector.

To clean a recessed ferrule using a swab, perform the following procedure:

1. Insert the swab into the adapter as shown in Figure 76 and rub the ferrule tip with the swab.

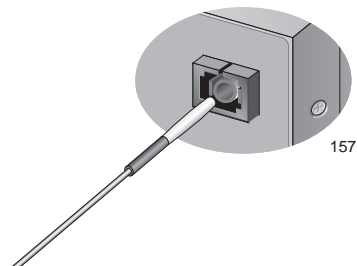

Figure 76. Cleaning a Recessed Ferrule

2. If desired, repeat step 1.

3. If a fiber inspection scope is available, use the scope to inspect the connector to make sure that it is clean.
4. Reconnect the cable to the port or protect the ferrule tip with a dust cap.

Free Manuals Download Website

<http://myh66.com>

<http://usermanuals.us>

<http://www.somanuals.com>

<http://www.4manuals.cc>

<http://www.manual-lib.com>

<http://www.404manual.com>

<http://www.luxmanual.com>

<http://aubethermostatmanual.com>

Golf course search by state

<http://golfingnear.com>

Email search by domain

<http://emailbydomain.com>

Auto manuals search

<http://auto.somanuals.com>

TV manuals search

<http://tv.somanuals.com>