

Alpha[®] Wet Blade Cutting Kit Instruction Manual

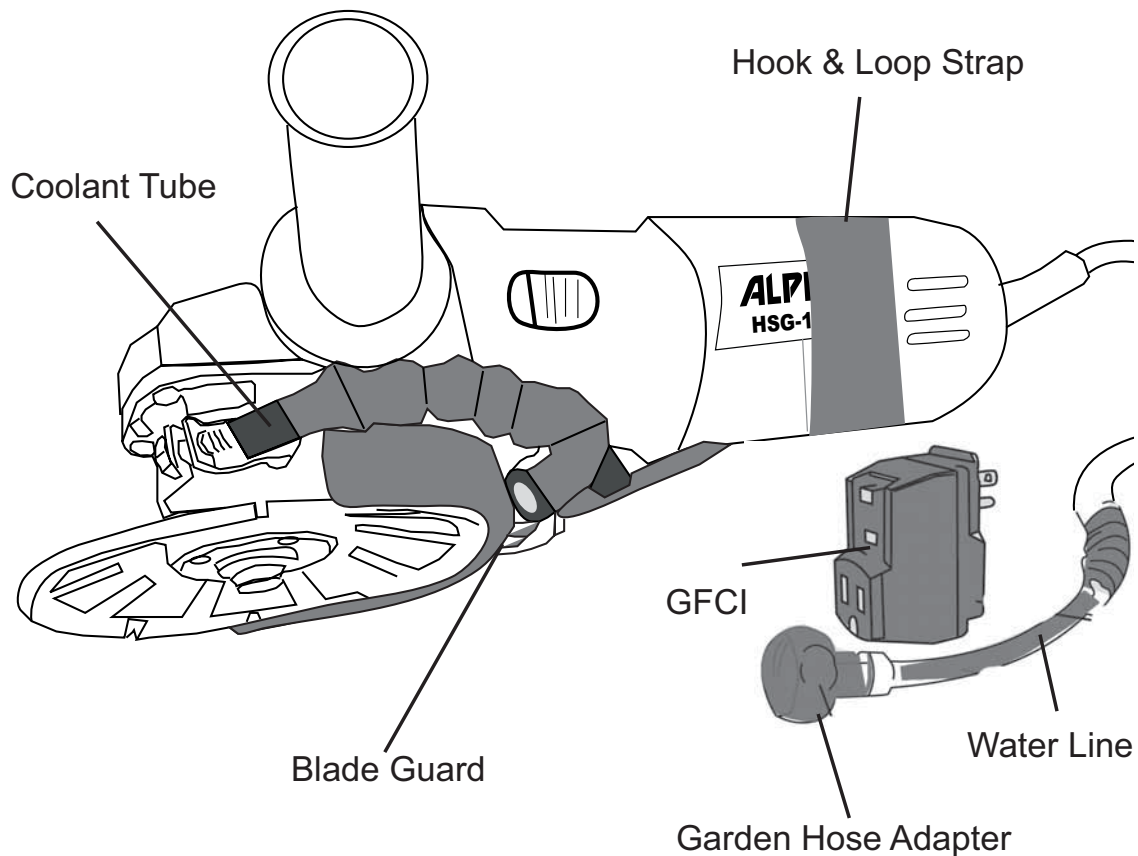

**Tool and Blade sold separately*

Part No: WBCKIT

 **Alpha Professional Tools**[®]

103 Bauer Drive, Oakland, NJ 07436 • 800-648-7229 • Fax: 800-286-0114
www.alpha-tools.com

► **TABLE OF CONTENTS**

CONTENTS

Parts List	3
Instructions	3
Creating Thread Holes for the Protective Guard	4
Assembly of WBCKIT Guard	4
Installation of WBCKIT Guard	5
Garden Hose Adapter Installation	6
Installation of Plastic Wire Wrap	7
Installation of GFCI	7
Completed Assembly	7

► **SERVICE**

Use only Alpha Professional Tools® accessories and spare parts. Should components which have been described need to be exchanged, please contact your dealer or Alpha Professional Tools®.

CAUTION!

- *Attach the Wet Blade Cutting Kit correctly by following the procedure in this instructional manual.*
- *During operation, be sure to wear personal safety equipment.*

► **NEED MORE INFORMATION**

For information on Alpha Professional Tools® complete product line, visit us on the web at www.alpha-tools.com.

► PARTS LIST



No.	Item Description	Part Number
1.	Protective Guard for HSG-125 <i>The WBCKIT can also be attached to other grinders with minimal alteration to their safety guards</i>	140007
2.	Water Line (10') 3m*	
3.	Garden Hose Adapter*	133287
4.	Ground Fault Circuit Interrupter	GFCI-1
5.	Hook & Loop Strap	140003
6.	Coolant Tube	140004
7.	90 degree Swivel Fitting	140005
8.	Plastic Ties	PDH-CABLETIES
9.	Plastic Wire Wrap	140002

* Not sold separately.

► INSTRUCTIONS

Alpha Professional Tools® provides the highest quality parts and manufacturing techniques in the manufacture of this product. In order to obtain the maximum effectiveness and provide the highest degree of safety, it is necessary to review and follow these instructions carefully before using the tool.

► CREATING THREAD HOLES FOR THE PROTECTIVE GUARD

Hole Size:
5mm or #8 Drill Bit

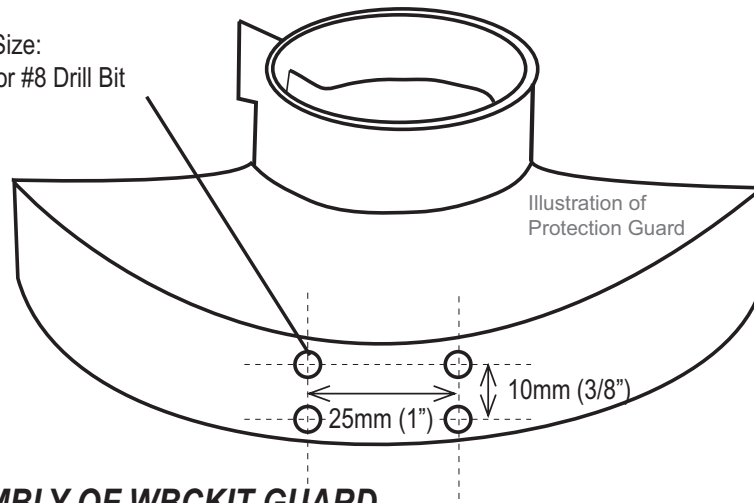

► ASSEMBLY OF WBCKIT GUARD

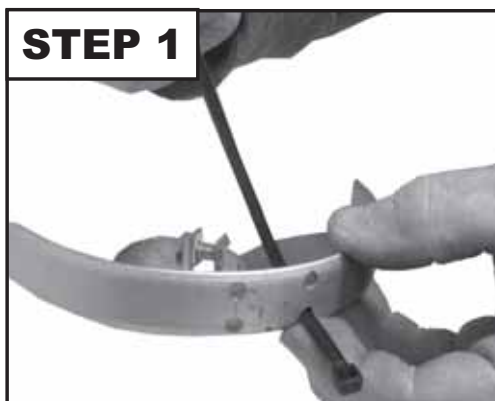

1. Thread plastic cable tie through holes in the guard. (If using another grinder the safety guard must be altered to accommodate cable ties as shown above).

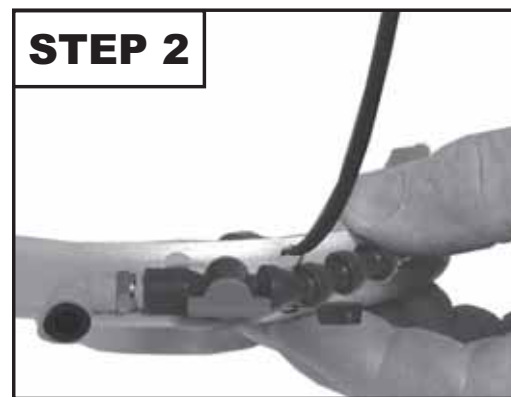

2. Place coolant tube between holes on Guard and tighten in place with plastic tie.



3. Repeat steps 1 and 2 to completely secure the coolant tube to the guard.



4. Trim plastic ties with pliers as shown above.

WBCKIT Guard Assembly

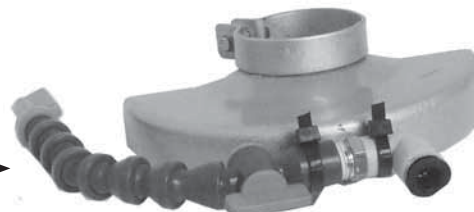

► INSTALLATION OF WBCKIT GUARD

Note: It is important to securely attach the WBCKIT to the tool.

1. Before tightening, slide the protective cover onto clamping collar so that the lip on the protective cover fits into the groove on the tool.
2. Position the protective cover with the shield facing backwards. Push down until the protective cover is firmly seated on the clamping collar.
3. Tighten the clamping screw to a snug fit. The protective cover should not be able to move.
4. Take one end of the water line and insert into the “push to connect” side of the 90 degree swivel fitting.
5. Push tubing until it contacts the bottom of the fitting. Pull back slightly on the tubing to ensure correct engagement.

Note: Tubing should not pull out from fitting.

6. To release tubing from fitting, push tubing inward, push down on the release collar and then pull tubing free from connection.

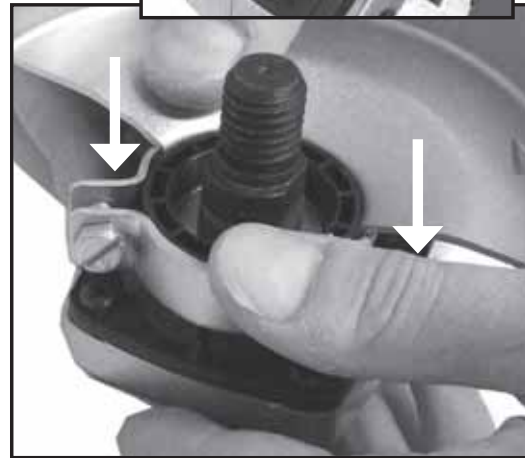

► **GARDEN HOSE
ADAPTER INSTALLATION**

1. Take the open end of the water line and place the compression fitting nut on the tube as shown. Push the tube into the connector base.

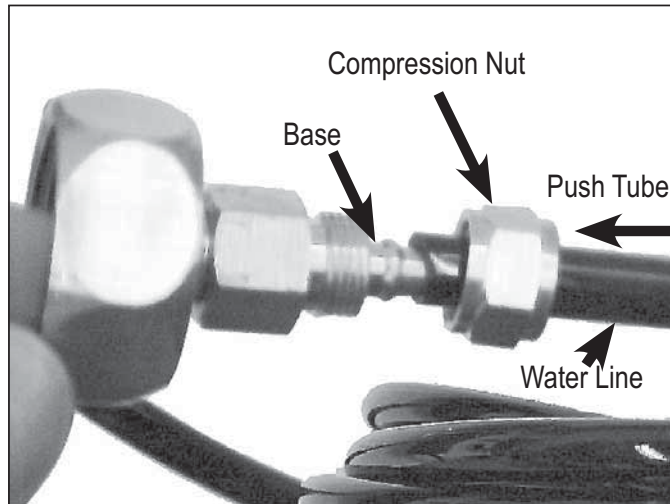

2. Tighten the compression nut with a 14mm wrench to a secure condition.

Note: *Do not overtighten connection.*

If leakage occurs during startup, tighten in small increments until a leak tight connection is made.

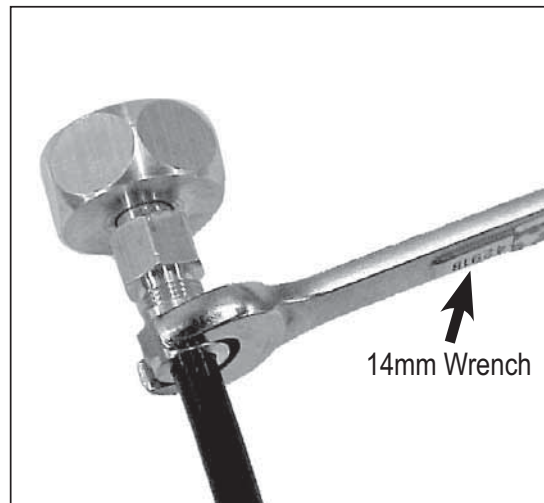

3. Position hook & loop strap around the waterline and grinder body.

Note: *Position the strap away from the vent ports of grinder.*

4. The 90 degree swivel fitting can be moved to give a tight installation to the grinder body.

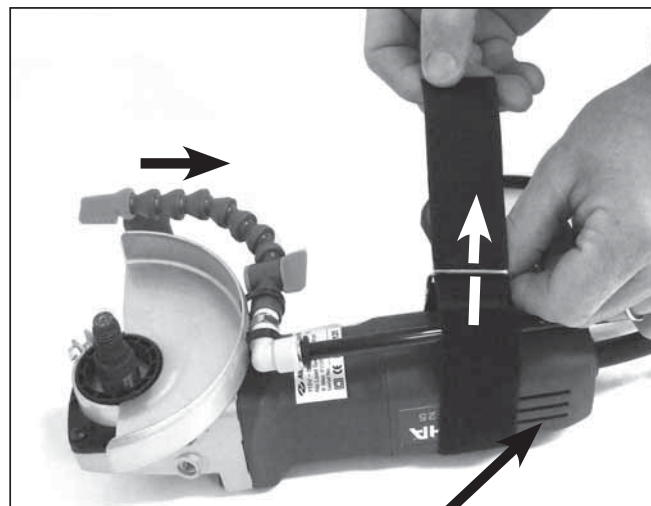

5. Adjust the strap to a tight position.

► **INSTALLATION OF PLASTIC WIRE WRAP**

1. Install the plastic wire wrap around both power cord and water-line as shown.



2. Finish the wrapping procedure until secure.

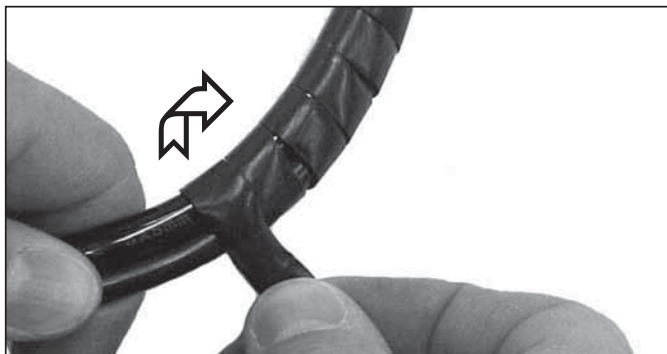

► **INSTALLATION OF GFCI**

1. Install the GFCI to the grinder power cord as shown. Connect to power and check the GFCI for proper function by pressing the test and reset buttons.

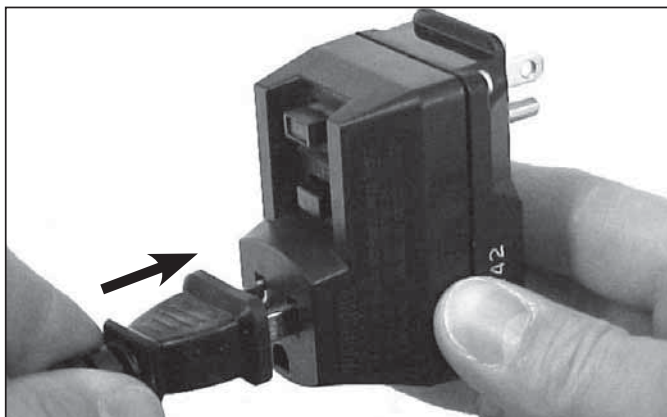

Caution: *Do not operate a grinder with a water-feed system, without a GFCI installed and in proper working condition.*

► **COMPLETED ASSEMBLY**





103 Bauer Drive, Oakland, NJ 07436 • 800-648-7229 • Fax: 800-286-0114
www.alpha-tools.com

Copyright © 2009 Alpha Professional Tools. All rights reserved.

Free Manuals Download Website

<http://myh66.com>

<http://usermanuals.us>

<http://www.somanuals.com>

<http://www.4manuals.cc>

<http://www.manual-lib.com>

<http://www.404manual.com>

<http://www.luxmanual.com>

<http://aubethermostatmanual.com>

Golf course search by state

<http://golfingnear.com>

Email search by domain

<http://emailbydomain.com>

Auto manuals search

<http://auto.somanuals.com>

TV manuals search

<http://tv.somanuals.com>