

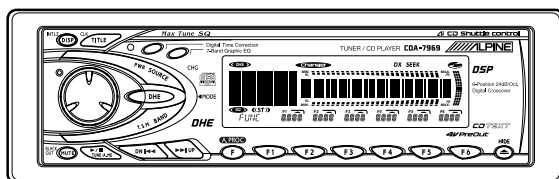

CDA-7969 CDA-7867

FM/AM CD Player
FM/AM CD Receiver

- OWNER'S MANUAL
Please read before using this equipment.
- MODE D'EMPLOI
Veuillez lire avant d'utiliser cet appareil.
- MANUAL DE OPERACIÓN
Léalo antes de utilizar este equipo.



(CDA-7969)

ALPINE ELECTRONICS, INC.
Tokyo office: 1-1-8 Nishi Gotanda,
Shinagawa-ku,
Tokyo 141-8501, Japan
Tel.: (03) 3494-1101

ALPINE ELECTRONICS OF AMERICA, INC.
19145 Gramercy Place, Torrance,
California 90501, U.S.A.
Tel.: 1-800-ALPINE-1 (1-800-257-4631)

ALPINE ELECTRONICS OF CANADA, INC.
Suite 203, 7300 Warden Ave. Markham,
Ontario L3R 9Z6, Canada
Tel.: 1-800-ALPINE-1 (1-800-257-4631)

ALPINE ELECTRONICS OF AUSTRALIA PTY. LTD.
6-8 Fiveways Boulevard Keysborough,
Victoria 3173, Australia
Tel.: (03) 9769-0000

ALPINE ELECTRONICS GmbH
Kreuzerkamp 7-11 40878 Ratingen, Germany
Tel.: 02102-45 50

ALPINE ITALIA S.p.A.
Via C. Colombo 8, 20090 Trezzano Sul Naviglio
MI, Italy
Tel.: 02-48 47 81

ALPINE ELECTRONICS FRANCE S.A.R.L.
(RCS PONTOISE B 338 101 280)
98, Rue De La Belle Etoile, Z.I. Paris Nord II
B.P. 50016 F-95945, Roissy, Charles De Gaulle
Cedex, France
Tel.: 01-48 63 89 89

ALPINE ELECTRONICS OF U.K., LTD.
13 Tanners Drive, Blakelands, Milton Keynes
MK14 5BU, U.K.
Tel.: 01908-61 15 56

ALPINE ELECTRONICS DE ESPAÑA, S.A.
Portal De Gamarra 36, Pabellón 32
01013 Vitoria (Alava)-Apdo. 133, Spain
Tel.: 34-45-283588

EN

FR

ES

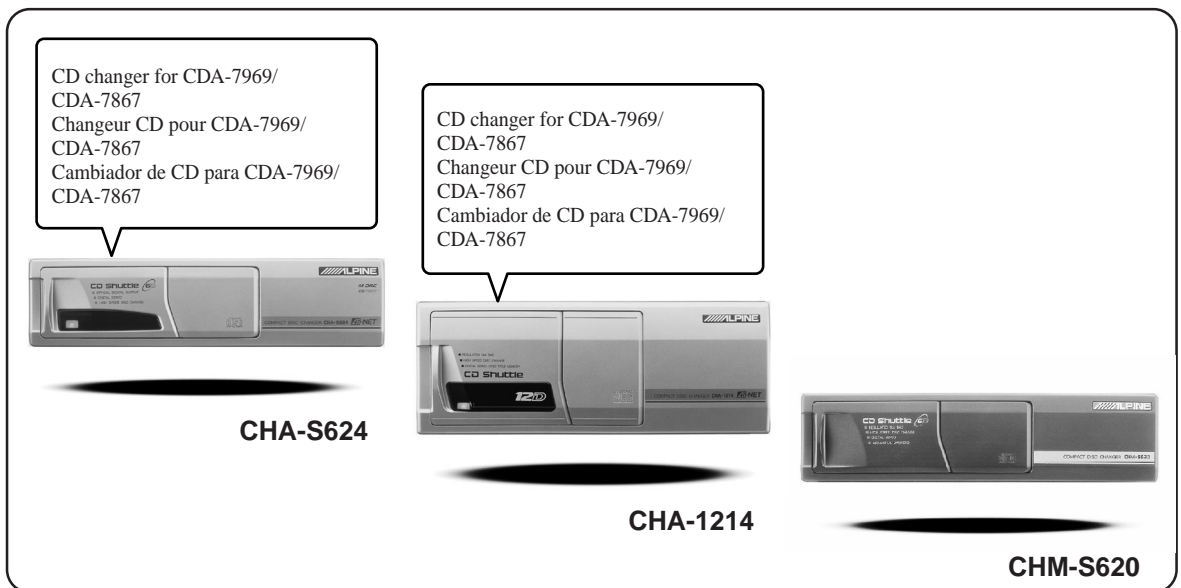

Alpine CD Changers Give You More!

More musical selections, more versatility, more convenience.

An Alpine CD Changer adds more musical choices to your sound system. All models can be controlled from Alpine head units and deliver excellent sound quality. The CHA-S624 is a high-performance 6-disc changer with a new M DAC, Ai-NET compatibility, Optical Digital Output, 150 Disc Title Memory and CD TEXT. The CHA-1214 Ai-NET model holds 12 discs, and the CHM-S620 M-Bus model is a super-compact 6-disc changer.

Changeurs de CD Alpine : vous avez le choix!

Plus de sélections musicales, plus de souplesse, plus de confort.

Un changeur de CD Alpine permet d'augmenter la plage des sélections musicales de votre système embarqué. Tous les modèles peuvent être contrôlés à partir des autoradios Alpine et offrent une excellente qualité audio. Le modèle CHA-S624 est un changeur 6 disques ultra performant compatible Ai-NET et équipé d'un convertisseur N/A standard, d'une sortie optique numérique, d'une mémoire d'une capacité de 150 titres et de la fonction CD TEXT. Le modèle CHA-1214 Ai-NET peut contenir 12 disques. Le modèle CHM-S620 M-Bus est un changeur 6 disques super compact.

¡Los cambiadores Alpine de CD le ofrecen más!

Más selecciones musicales, más versatilidad y más ventajas.

Un cambiador Alpine de CD añade más opciones musicales a su equipo de sonido. Todos los modelos pueden controlarse desde las unidades principales de Alpine y proporcionar un sonido de calidad excepcional. El modelo CHA-S624 es un cambiador de 6 discos de alto rendimiento con el nuevo DAC "M" y compatibilidad con Ai-NET, salida digital óptica, memoria de títulos de 150 discos y TEXTO CD. El modelo CHA-1214 Ai-NET admite 12 discos y el modelo CHM-S620 Bus-M es un cambiador de 6 discos y tamaño reducido.

Contents

Operating Instructions

WARNING

WARNING	2
CAUTION	2
PRECAUTIONS	2

Basic Operation

Opening the Front Panel	4
Hiding the Front Panel	4
Initial System Start-Up	4
Turning Power On and Off	4
Display Angle Adjustment	4
Setting the Front Panel closing mode	5
Adjusting Volume/Balance (Between Left and Right)/Fader (Between Front and Rear)	5
Audio Mute Function	5
Displaying Time	5
Setting Time	5
Changing Lighting Color	6
Dimmer Control	6
Subwoofer On and Off	6
Sound (Beep) Guide Function	7
Turning Mute Mode On/Off	7
CD Text Scroll Setting	7
Digital Output On and Off (CDA-7969 only) ...	7
Setting the AUX Mode	8
Demonstration	8
Adjusting the built -in Audio Processor	9
Blackout Mode On and Off	9
Switching the Display Modes	9
Displaying the Title/Text	10
Titling Discs/Stations	11
Searching for Titled Discs/Titled Stations/ CD Text Discs	11
Erasing Disc Title (CD/CD Changer only)	11
Selecting DHE Mode	12
Equalizer Presets	12
Adjusting the Equalizer Settings	13
Memorizing the Equalizer Settings	13
Recalling the Memorized Equalizer	13
Memorizing the Time Correction Setting	13

Recalling the Memorized Time Correction Setting	13
Adjusting the Time Correction	14

Radio Operation

Manual Tuning	15
Automatic Seek Tuning	15
Manual Storing of Station Presets	16
Automatic Memory of Station Presets	16
Storing into Direct Access Preset (D.A.P.) Band	17
Tuning to Preset Stations	17
Mono/Stereo Switching	17

CD Player Operation

Opening and Closing the Movable display	18
Playback	18
Music Sensor (Skip)	19
Fast Forward and Backward	19
Repeat Play	19
M.I.X. (Random Play)	19
Scanning Programs	19
Controlling CD Changer (Optional)	20
Multi-Changer Selection	21

Remote Control Operation

Controls on Remote Control	22
Battery Replacement	23

Information

In Case of Difficulty	24
Specifications	25

Installation and Connections

Warning	26
Caution	26
Precautions	26
Installation	27
Connections	28

LIMITED WARRANTY

WARNING

WARNING

This symbol means important instructions. Failure to heed them can result in serious injury or death.

DO NOT OPERATE ANY FUNCTION THAT TAKES YOUR ATTENTION AWAY FROM SAFELY DRIVING YOUR VEHICLE.

Any function that requires your prolonged attention should only be performed after coming to a complete stop. Always stop the vehicle in a safe location before performing these functions. Failure to do so may result in an accident.

KEEP THE VOLUME AT A LEVEL WHERE YOU CAN STILL HEAR OUTSIDE NOISE WHILE DRIVING.

Failure to do so may result in an accident.

MINIMIZE DISPLAY VIEWING WHILE DRIVING.

Viewing the display may distract the driver from looking ahead of the vehicle and cause an accident.

DO NOT DISASSEMBLE OR ALTER.

Doing so may result in an accident, fire or electric shock.

USE ONLY IN CARS WITH A 12 VOLT NEGATIVE GROUND.

(Check with your dealer if you are not sure.) Failure to do so may result in fire, etc.

KEEP SMALL OBJECTS SUCH AS BATTERY OUT OF THE REACH OF CHILDREN.

Swallowing them may result in serious injury. If swallowed, consult a physician immediately.

USE THE CORRECT AMPERE RATING WHEN REPLACING FUSES.

Failure to do so may result in fire or electric shock.

DO NOT BLOCK VENTS OR RADIATOR PANELS.

Doing so may cause heat to build up inside and may result in fire.

USE THIS PRODUCT FOR MOBILE 12V APPLICATIONS.

Use for other than its designed application may result in fire, electric shock or other injury.

DO NOT PLACE HANDS, FINGERS OR FOREIGN OBJECTS IN INSERTION SLOTS OR GAPS.

Doing so may result in personal injury or damage to the product.

CAUTION

This symbol means important instructions. Failure to heed them can result in injury or material property damage.

HALT USE IMMEDIATELY IF A PROBLEM APPEARS.

Failure to do so may cause personal injury or damage to the product. Return it to your authorized Alpine dealer or the nearest Alpine Service Center for repairing.

DO NOT MIX NEW BATTERIES WITH OLD BATTERIES. INSERT WITH THE CORRECT BATTERY POLARITY.

When inserting the batteries, be sure to observe proper polarity (+ and -) as instructed. Rupture or chemical leakage from the battery may cause fire or personal injury.

PRECAUTIONS

Temperature

Be sure the temperature inside the vehicle is between +60°C (+140°F) and -10°C (+14°F) before turning your unit on.

Moisture Condensation

You may notice the CD playback sound wavering due to condensation. If this happens, remove the disc from the player and wait about an hour for the moisture to evaporate.

Damaged Disc

Do not attempt to play cracked, warped, or damaged discs. Playing a bad disc could severely damage the playback mechanism.

Maintenance

If you have problems, do not attempt to repair the unit yourself. Return it to your Alpine dealer or the nearest Alpine Service Station for servicing.

Never Attempt the Following

Do not grip or pull out the disc while it is being pulled back into the player by the automatic reloading mechanism.

Do not attempt to insert a disc into the unit when the unit power is off.

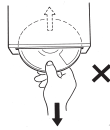

Inserting Discs

Your player accepts only one disc at a time for playback.

Do not attempt to load more than one disc.

Make sure the label side is facing up when you insert the disc. Your player will automatically eject any disc that is inserted incorrectly. If the player continues to eject a correctly inserted disc, push the RESET switch with a pointed object such as a ball-point pen.

Playing a disc while driving on a very bumpy road may result in skips, but this will not scratch the disc or damage the player.

New Discs

As a protective measure to prevent the CD from jamming, the CD player will automatically eject discs with irregular surfaces or inserted incorrectly. When a new disc is inserted into the player and ejected after initial loading, using your finger, feel around the inside of the centre hole and outside edge of the disc. If you feel any small bumps or irregularities, this could inhibit proper loading of the disc. To remove the bumps, rub the inside edge of the hole and outside edge of the disc with a ball-point pen or other such instrument, then insert the disc again.

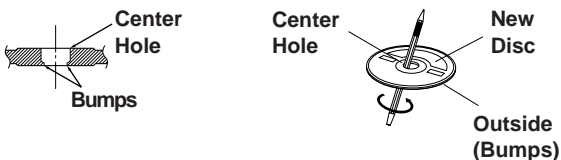

Irregular Shaped Discs

Be sure to use round shape discs only for this unit and never use any special shape discs.

Use of special shape discs may cause damage to the mechanism.



Installation Location

Make sure the CDA-7969/CDA-7867 will not be installed in a location subjected to:

- Direct sun and heat
- High humidity and water
- Excessive dust
- Excessive vibrations

Correct Handling

Do not drop the disc while handling. Hold the disc so you will not leave fingerprints on the surface. Do not affix tape, paper, or gummed labels to the disc. Do not write on the disc.

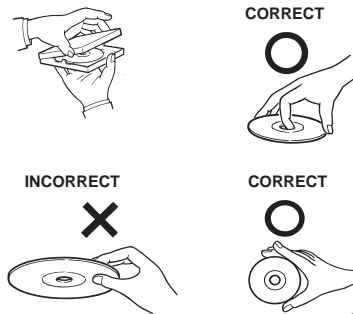

Disc Cleaning

Fingerprints, dust, or soil on the surface of the disc could cause the CD player to skip. For routine cleaning, wipe the playing surface with a clean, soft cloth from the centre of the disc to the outer edge. If the surface is heavily soiled, dampen a clean, soft cloth in a solution of mild neutral detergent before cleaning the disc.



Disc Accessories

There are various accessories available on the market for protecting the disc surface and improving sound quality. However, most of them will influence the thickness and/or diameter of the disc. Using such accessories can cause the disc to be out of standard specifications and may create operational problems. We recommend not using these accessories on discs played in Alpine CD players.



Basic Operation

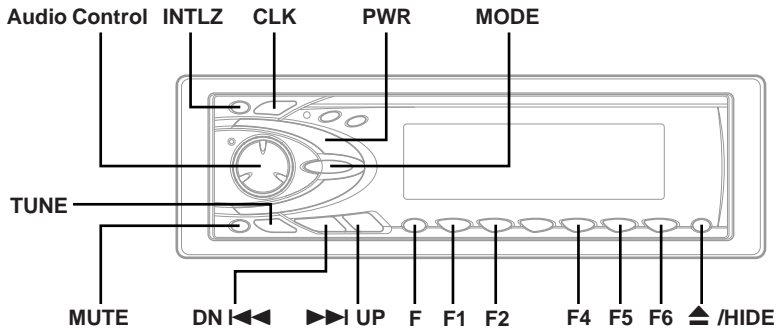

Opening the Front Panel

- 1 Press the **Open** button on the Front Panel.



Open Button

NOTE

Hide the Front Panel if it does not come out within 6 seconds after the Open button has been pressed. The power will turn off after the Front panel hiding.

Turning Power On and Off

- 1 Press the **PWR** (Power) button to turn on the unit.

NOTE

The unit can be turned on by pressing any other button except the eject  button.

The volume level gradually increases to the previous level you were listening to before the unit was turned off. Press and hold the **PWR** button for at least 3 seconds to turn off the unit.

NOTE

The very first time the power is turned on, the volume will start from level 12, in the tuner mode.

Hiding the Front Panel

- 1 Press the **HIDE** button on the Front Panel for at least 3 seconds.

NOTES

- The Front Panel will stop moving if there is an obstacle inside the compartment. In that case, remove the obstacle and press the HIDE button again for at least 3 seconds.
- The power will turn off after the Front panel hiding.

Display Angle Adjustment

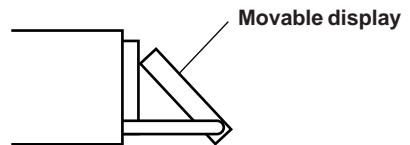

The movable display may be adjusted to 3 different angles depending upon user preference.

Initial System Start-Up

- 1 Immediately after installing or applying power to the unit, it should be initialized. Press the **RESET** switch with a ballpoint pen or any other pointed object.

NOTE

This should be operated when the front panel is hidden.



RESET switch

NOTE

The **RESET** switch is also on the front panel (to the right of the **TITLE** button).



- 1 Press the **F** button, and when the **FUNC** indicator blinks, adjust the movable display angle by pressing button **F1** (DOWN) or **F2** (UP).

NOTES

- The display will close a half minute after the ignition key is turned to the OFF position.
- The adjusted angle of the display is stored in memory. There is no need to re-adjust the angle when the power is turned back on.

CAUTION

Keep hands (or any other object) away from the display while it is opening or closing to avoid damage or injury. The back of the movable display will get very warm under normal operating conditions. This is not a malfunction. Do not touch.

Setting the Front Panel closing mode

- 1 Press and hold the **INTLZ** button for at least 2 seconds.
- 2 Press the **▶▶I UP** button repeatedly to select "CLOSE".
Each press of the **▶▶I UP** button changes the modes as shown:

→ AMBER → DIM → SUB-W → BEEP → MUTE
← D-OUT* ← CLOSE ← DEMO ← AUX ← SCR ←

* CDA-7969 Only

NOTE

If you press the **DN◀◀** button the display scrolls in reverse sequence.

- 3 Press the **TUNE** button to toggle mode between CLOSE AUTO and MANU.
 - CLOSE AUTO: The Front Panel automatically closes when ACC is on OFF.
 - CLOSE MANU: The Front Panel remains open until closed manually.
- 4 When the setting is completed, press the **INTLZ** button for at least 2 seconds to return to the normal mode.

Adjusting Volume/Balance (Between Left and Right)/Fader (Between Front and Rear)

- 1 Press the **MODE** button repeatedly to choose the desired mode.
Each press changes the modes as follows:

→ VOLUME → BALANCE → FADER →

NOTES

- If the **MODE** button is not pressed in 5 seconds after selecting the **BALANCE** or **FADER** mode, the unit automatically returns to the **VOLUME** mode.
- When the subwoofer mode is ON, its level may also be adjusted.

- 2 Rotate the **Audio Control** knob until the desired sound is obtained in each mode.

NOTE

Depending on the connected devices, some functions and display indications do not work.

Audio Mute Function

Activating this function will instantly lower the volume level by 20 dB.

- 1 Press the **MUTE** button to activate the MUTE mode. The audio level will decrease by about 20 dB.
Pressing the **MUTE** button again will bring the audio back to its previous level

Displaying Time

- 1 Press the **CLK** (clock) button repeatedly until the time is displayed.
Each press changes the modes as follows:

Radio mode

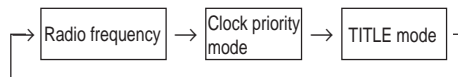

CD Player/Changer modes

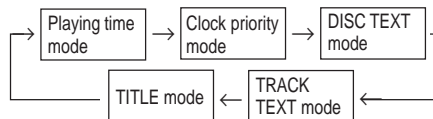

NOTE

Selecting any tuner or CD function while in the clock priority mode will interrupt the time display momentarily. The function selected will be displayed for about 5 seconds before the time returns to the display.

Setting Time

- 1 While the clock time is displayed, press and hold the **CLK** (clock) button for at least 3 seconds.
The time indication will begin to blink.
- 2 Press the **F4** button while the time indication is blinking to set seconds to "0".
- 3 Press the **F5** button to adjust the hours while the time indication is blinking.
- 4 Press the **F6** button to adjust the minutes while the time indication is blinking.
The time indication will stop blinking 5 seconds after the last adjustment. The time will automatically be set.

Basic Operation

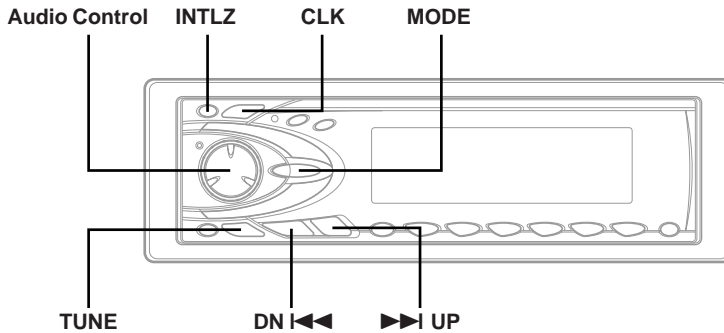

Changing Lighting Color

- 1 Press and hold the **INTLZ** button for at least 2 seconds.
- 2 Press the **▶▶ UP** button repeatedly to select "AMBER".
Each press of the **▶▶ UP** button changes the modes as shown:
NOTE
*If you press the **DN ◀◀** button the display scrolls in reverse sequence.*
 - AMBER → DIM → SUB-W → BEEP → MUTE
 - ← D-OUT* ← CLOSE ← DEMO ← AUX ← SCR ←
- 3 Press the **TUNE** button to toggle the mode between AMBER ON (amber) and AMBER OFF (green).
- 4 Press and hold the **INTLZ** button for at least 2 seconds to set the selected mode.

Dimmer Control

Set the DIMMER control to AUTO to decrease the illumination brightness of the unit with the head lights of the vehicle ON. This mode is useful if you feel the unit's backlighting is too bright at night.

- 1 Press and hold the **INTLZ** button for at least 2 seconds.
- 2 Press the **▶▶ UP** button repeatedly to select "DIM"(DIMMER).
Each press of the **▶▶ UP** button scrolls the modes as shown:
 - AMBER → DIM → SUB-W → BEEP → MUTE
 - ← D-OUT* ← CLOSE ← DEMO ← AUX ← SCR ←
- 3 Press the **TUNE** button to select the Dimmer mode.
Each press toggles between DIMMER AUTO and DIMMER MANU.
- 4 Press and hold the **INTLZ** button for at least 2 seconds to activate the normal mode.

6-EN

Subwoofer On and Off

- 1 Press and hold the **INTLZ** button for at least 2 seconds.
- 2 Press the **▶▶ UP** button repeatedly to select "SUB-W."
Each press of the **▶▶ UP** button changes the modes as shown:
 - AMBER → DIM → SUB-W → BEEP → MUTE
 - ← D-OUT* ← CLOSE ← DEMO ← AUX ← SCR ←
- 3 Press the **TUNE** button to toggle mode between SUB-W ON and SUB-W OFF.

If an Ai-NET compatible processor with Subwoofer output is connected:

Press the **TUNE** button after selecting the SUB-W ON mode, and the subwoofer output phase is toggled NORMAL (0°) or REVERS (180°).

- 4 Press and hold the **INTLZ** button for at least 2 seconds after setting the SUB-W ON.
- 5 Press the **MODE** button repeatedly to select the SUB-W mode.
 - SUB-W → BALANCE
 - ← VOLUME ← FADER ←
- 6 Rotate **Audio Control** knob until the desired sound is obtained in each mode.

Sound (Beep) Guide Function

This function will give audible feedback with varying tones depending upon the button pressed.

- 1 Press and hold the **INTLZ** button for at least 2 seconds.
- 2 Press the **▶▶I UP** button repeatedly to select "BEEP."
Each press of the **▶▶I UP** button changes the modes as shown:
NOTE
If you press the DN ◀◀ button the display scrolls in reverse sequence.
→ AMBER → DIM → SUB-W → BEEP → MUTE
← D-OUT* ← CLOSE ← DEMO ← AUX ← SCR ←
* CDA-7969 Only
- 3 Press the **TUNE** button to toggle the mode between BEEP ON and BEEP OFF.
NOTE
The initial setting at the factory is BEEP ON.
- 4 Press and hold the **INTLZ** button for at least 2 seconds to set the selected mode.

Turning Mute Mode On/Off

If a device having the interrupt feature is connected, audio will be automatically muted whenever the interrupt signal is received from the device. This function can be turned ON or OFF from the head unit by following procedure below.

- 1 Press and hold the **INTLZ** button for at least 2 seconds.
- 2 Press the **▶▶I UP** button to select the MUTE mode. Each press changes the modes as shown:
→ AMBER → DIM → SUB-W → BEEP → MUTE
← D-OUT* ← CLOSE ← DEMO ← AUX ← SCR ←
* CDA-7969 Only
NOTE
If you press the DN ◀◀ button the display scrolls in reverse sequence.
- 3 Press the **TUNE** button to turn on or off the MUTE mode.
Each press toggles between the MUTE ON and OFF modes.
NOTE
The initial setting at the factory is "MUTE ON."
- 4 Press and hold the **INTLZ** button for at least 2 seconds again to return to normal operation.

CD Text Scroll Setting

This CD player has the ability to scroll the disc and track name recorded on CD-Text discs. The scrolling feature will work with names greater than 12 characters. This feature will not work for the 12 character titles that were input manually.

- 1 Press and hold the **INTLZ** button for at least 2 seconds.
- 2 Press the **▶▶I UP** button repeatedly to select "SCR"(SCROLL).
Each press of the **▶▶I UP** button changes the modes as shown:
→ AMBER → DIM → SUB-W → BEEP → MUTE
← D-OUT* ← CLOSE ← DEMO ← AUX ← SCR ←
* CDA-7969 Only
NOTE
If you press the DN ◀◀ button the display scrolls in reverse sequence.
- 3 Press the **TUNE** button to toggle mode between SCROLL AUTO and MANU.
 - SCROLL AUTO: the display of CD text is scrolled continuously.
 - SCROLL MANU: the display is scrolled only when a disc is loaded or when a track is changed and the text information exceeds 12 digits.
- 4 When the setting is completed, press and hold the **INTLZ** button for at least 2 seconds to return to the normal mode.

NOTES

- Initial mode is "SCROLL MANU".
- The unit scrolls only CD text names. The disc titles input manually (refer to page 11) cannot be scrolled.
- The display of CD text will scroll even for text less than 12 characters.

Digital Output On and Off (CDA-7969 Only)

If an optional Digital Phase Processor with the optic digital connector is Ai-NET connected, turn the digital output on or off as described below.

- 1 Press and hold the **INTLZ** button for at least 2 seconds.
- 2 Press the **▶▶I UP** button repeatedly to select "D-OUT".
Each press of the **▶▶I UP** button scrolls the modes as shown:
→ AMBER → DIM → SUB-W → BEEP → MUTE
← D-OUT* ← CLOSE ← DEMO ← AUX ← SCR ←
* CDA-7969 Only
NOTE
If you press the DN ◀◀ button the display scrolls in reverse sequence.
- 3 Press the **TUNE** button to select the D-OUT mode.
Each press toggles between the D-OUT ON and D-OUT OFF.
- 4 Press and hold the **INTLZ** button for at least 2 seconds to activate the normal mode.

Basic Operation

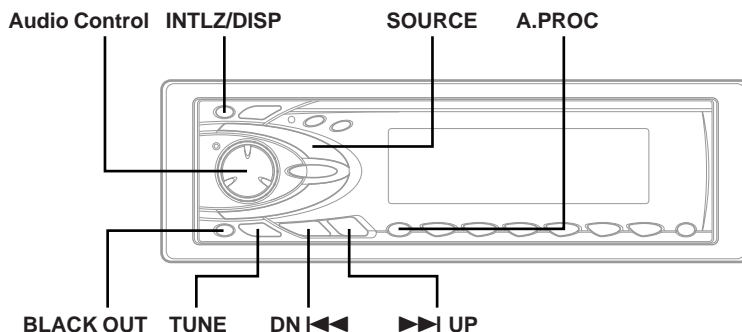

Setting the AUX Mode

You can input TV/video sound by connecting an optional Ai-NET/RCA Interface cable (KCA-121B) to this component.

- 1 Press and hold the **INTLZ** button for at least 2 seconds.
- 2 Press the **▶▶I UP** button repeatedly to select "AUX". Each press of the **▶▶I UP** button changes the modes as shown:

NOTE

If you press the **DN I◀◀** button the display scrolls in reverse sequence.

→ AMBER → DIM → SUB-W → BEEP → MUTE → SCR
 [D-OUT* ← CLOSE ← DEMO ← AUX (AUX Mode Display Setting**)]

* CDA-7969 Only

** Displayed after AUX-IN ON is set.

- 3 Press the **TUNE** button to toggle the mode between AUX-IN ON and AUX-IN OFF.

NOTES

- The initial setting at the factory is **AUX-IN OFF**.
- You can set the **AUX mode display** by pressing the **DN I◀◀** or **▶▶I UP** button after **AUX-IN ON** is set, select the **AUX mode display setting**, and then press the **TUNE** button.

- 4 Press and hold the **INTLZ** button for at least 2 seconds to return to normal mode.

- 5 To adjust the volume, etc., first press the **SOURCE** button and select the **AUX** mode, then make the necessary adjustment.

→ TUNER → CD → AUX]

NOTE

When **AUX-IN ON** is selected, a **CD Changer** cannot be used.

Demonstration

This unit has a Demonstration feature which simulates the display functions.

- 1 Press and hold the **INTLZ** button for at least 2 seconds.
- 2 Press the **▶▶I UP** button to select the **DEMO** mode. Each press changes the modes as shown:

→ AMBER → DIM → SUB-W → BEEP → MUTE
 [D-OUT* ← CLOSE ← DEMO ← AUX ← SCR ←]

* CDA-7969 Only

NOTE

If you press the **DN I◀◀** button the display scrolls in reverse sequence.

- 3 Press the **TUNE** button to turn on or off the **DEMO** mode. Each press toggles between **DEMO ON** and **DEMO OFF**.

If no button is pressed 30 seconds after the **DEMO** mode is turned ON, "DEMO" blinks 3 times in the display. The **DEMO** mode then begins.

NOTE

The initial setting at the factory is "DEMO OFF."

- 4 Press and hold the **INTLZ** button for at least 2 seconds again to return to normal operation.

Adjusting the built-in Audio Processor

You can change High Pass Filter, Low Pass Filter, and Sub Woofer Phase on this unit, so that you can create your favorite sound effects.

- 1 Press and hold the **A.PROC** button for at least 3 seconds to enter Adjust Mode.
- 2 Within 5 seconds, press the **DN** ◀◀ or ▶▶ **UP** button repeatedly to select the desired parameter.

◀ → HPF → LPF* → SUB-W* →

* When the subwoofer is turned OFF by using this unit, LPF and phase are deactivated.

- 3 Rotate the **Audio Control** knob to select the desired setting.
 1. HPF (Setting the High Pass Filter):

◀ → OFF ↔ 63Hz ↔ 80Hz ↔ 100Hz ←

◀ → 200Hz ↔ 160Hz ↔ 125Hz ←

Outputs all frequencies higher than that selected according to your preference.
 2. LPF (Setting the Low Pass Filter):

◀ → OFF ↔ 63Hz ↔ 80Hz ↔ 100Hz ←

◀ → 200Hz ↔ 160Hz ↔ 125Hz ←

Outputs all frequencies lower than that selected according to your preference.
(Only available when using the subwoofer output from this unit.)
 3. SUB-W (Change the Subwoofer Phase):
NORMAL ↔ REVERS

You can change the subwoofer phase.
(Only available when using the subwoofer output from this unit.)

NOTES

- If the battery is disconnected, all settings return to factory default.
- If no buttons are pressed within 5 seconds, the setup menu returns to the normal audio display.

Blackout Mode On and Off

When the Blackout mode is turned on, the display will turn off to reduce power consumption. This additional power enhances the sound quality.

- 1 Press and hold the **BLACK OUT** button for at least 2 seconds to start the blackout mode. By doing so the display will be removed.

NOTE

If any button on the unit is pressed during the blackout mode, the function will be displayed for 5 seconds to show the operation before returning to Blackout mode.

To cancel the blackout mode, press and hold the **BLACK OUT** button for at least 2 seconds.

Switching the Display Modes

- 1 Press the **DISP** (DISPLAY) button to select the desired Display pattern mode.

Each press changes the display patterns.

Pattern	Description
1	Normal pattern (Upward)
2	Mode Display (Keeps showing the present operation over and over.)
3	Normal pattern (Rightward)
4	Demonstration Display
5	Scan Display (Repeats from Pattern 1 to Pattern 4 for every 5 seconds endlessly.)
6	Mode Display
7	Display OFF

Basic Operation

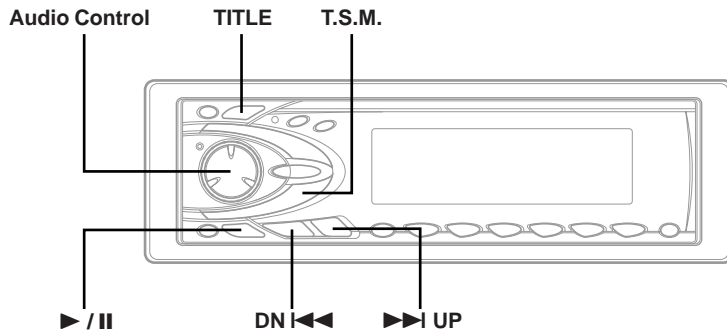

Displaying the Title/Text

It is possible to display the CD/Station title if the title has been previously inputted. For details, see Titling Disc/Station (page 11). Text information, such as the disc name and the track name, will be displayed if playing a CD text compatible disc.

- 1 Press the **TITLE** button.
The mode will change every time the button is pressed.

About "Title" and "Text"

Title: With this device, it is possible to input the CD/Station name (see page 11). This inputted name is referred to as a "title."

Text: Text compatible CDs contain text information such as the disc name and track name. Such text information is referred to as "text."

Radio mode:

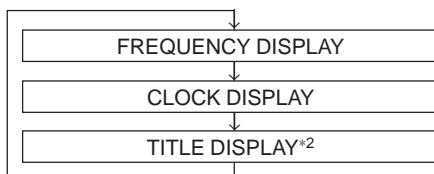

CD/Changer mode:

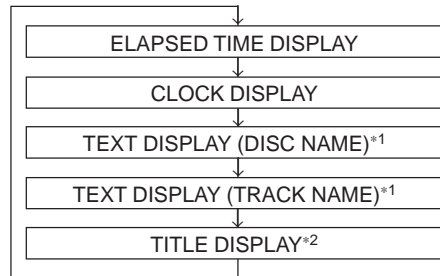

*1 Displayed during playback of a text compatible CD (when using an optional text compatible). "NO TEXT" will be displayed when the CD is not text compatible.

*2 "-----" will be displayed when the title has not been inputted.

Sample display when text compatible CD

NOTES

- Some characters may not be displayed correctly with this device, depending on the character type.
- The CD changer must also be CD Text compatible for the Text information to be displayed.

Titling Discs/Stations

It is possible to title your favorite CD's or radio stations.

- 1 Press the **TITLE** button and select the title display mode.
For details, see Displaying the Title/Text (page 10).
- 2 Press and hold the **TITLE** button for at least 3 seconds. The first character will blink.
- 3 Rotate the **Audio Control** knob to select the desired letter/numeral/symbol available for naming. ("A" for example).
- 4 Press the **▶/||** button to store the first character. The first character will stop blinking and the display will automatically advance to the next character. When that character begins to blink, you may choose the next letter or symbol of your title.
- 5 Repeat the steps 3 and 4 above to complete the titling. Pressing the **▶/||** button after entering the 12th character, automatically stores the title into memory.

When entering a title of less than 12 characters (for example, 3 character title):

After entering 3 characters to complete your title, the 4th character space will be blinking. Go to step 6 to complete the title.

- 6 Press and hold the **TITLE** button for at least 3 seconds to record the title.

NOTES

- The memory can store up to 150 titles for CD, CD Changer and radio stations. If you try to store beyond the limit, the display will show "FULL DATA." At this point, no more titles can be stored.
- To input a new title, one of the previously inputted titles must first be deleted.
- When you want to erase a title, enter the "⏏" symbol into all spaces.
- The operations described in steps 3 to 5 must be made within 10 seconds. The input mode will be cancelled if no action is taken for over 10 seconds.

Searching for Titled Discs/Titled Stations/CD Text Discs

If a CD/Station is titled, you can do a search for it. You can also search for CD TEXT discs by title. (To title CDs, refer to "Titling Discs/Stations" on page 11.)

- 1 Press and hold the **T.S.M.** button for at least 2 seconds. The title blinks in the display.
- 2 Press the **DN ◀◀** or **▶▶ UP** button to select the desired disc title/station title/CD Text disc.
- 3 Press the **T.S.M.** button to play the selected disc or station.
The unit will automatically search for the disc or station and begin play.

NOTES

- This function cannot be performed when using a multi-changer switching device.
- To search for a title from CD TEXT discs, first you need to playback the CD TEXT disc at least once so that it is registered in the unit's memory.

Erasing Disc Title (CD/CD Changer only)

- 1 Press the **TITLE** button to select the disc titling mode. Then, press and hold for at least 3 seconds.
- 2 Press and hold the **▶/||** button for at least 2 seconds to activate the title scanning mode. The title in the display will blink.
- 3 Press the **DN ◀◀** or **▶▶ UP** button repeatedly until the disc title you want to erase is displayed.
- 4 Press and hold the **▶/||** button for at least 2 seconds to erase the disc title displayed.
- 5 Press and hold the **TITLE** button for at least 3 seconds to cancel the disc title erasing mode.

NOTE

You cannot erase a CD-TEXT.

Basic Operation

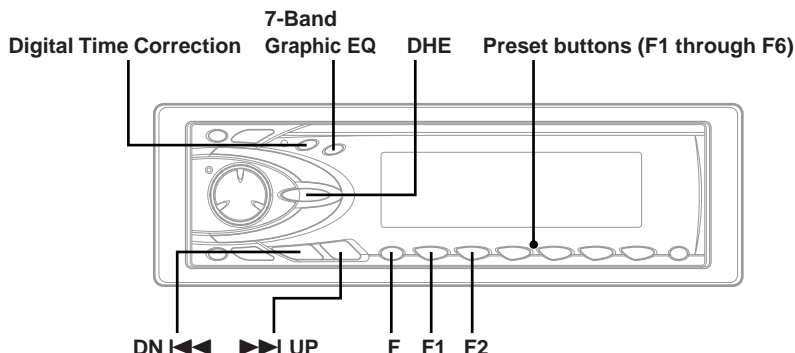

Selecting DHE Mode

Using digital signal processing technology, DHE (Digital Harmonics Enhancer) operates on harmonic components which determine tone and coloration of the musical instruments. The process operates independently on individual frequency bands, so each instrument or vocal will be distinct. Play back clarity is enhanced to compensate for road noises which would normally detract from the listener's enjoyment.

- 1 Press the **DHE** button for at least 2 seconds to switch to the DHE mode.
- 2 Press the **Preset buttons (F1 through F6)** within 10 seconds to select the desired mode.

F1: OFF (NON EFFECT)

F2: Beat MAX (DHE1)

Strong Low Frequency emphasis.

F3: Lyric MAX (DHE2)

Strong vocal emphasis.

F4: Beat MIX (DHE3)

Good balance between bass and vocals.

F5: Lyric MIX (DHE4)

Slight vocal emphasis.

F6: Phase MIX (DHE5)

Enlivens any genre.

- 3 Press the **F** button within 10 seconds to select the desired mode.

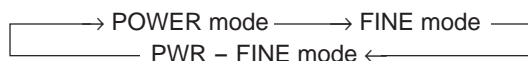

POWER mode:

Any of the DHE effects can be modified using the Power Mode. Enhanced bass and high frequencies will be added to the selected DHE effect.

FINE mode:

Selecting the DHE fine mode will emphasize the vocal/chorus sustain for clear sound reproduction.

PWR - FINE mode:

Both the POWER mode and the FINE mode will be activated simultaneously.

Equalizer Presets

Six typical equalizer settings are preset at the factory for a variety of musical source material.

- 1 Press the **7-Band Graphic EQ** button to switch to the EQ mode.
- 2 Press the **Preset buttons (F1 through F6)** within 10 seconds to select the desired mode.

F1: FLAT

Flat frequency

F2: MALE (VOCAL)

Suppress higher frequencies

F3: FEMA (VOCAL)

Emphasize midrange

F4: POPS

Suppress midrange

F5: ROCK

Emphasize lows and highs

F6: NEWS

Boost midrange and suppress highs and lows

Adjusting the Equalizer Settings

You can modify the Equalizer settings to create a response curve more appealing to your personal taste.

- 1 Select the equalizer characteristic to adjust. See Equalizer Presets (page 12).
- 2 Press and hold the **7-Band Graphic EQ** button for at least 2 seconds within 10 seconds of step 1.
- 3 Press either the **F1** or **F2** button within 10 seconds of step 2, to select the frequency band to adjust.

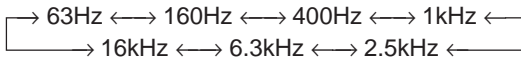

- 4 While the FUNC (Function) indicators is flashing, press either the **DN I◀◀** button or the **▶▶ I UP** button to adjust to the desired level. To adjust another frequency band, repeat the above procedure.

NOTE

All band levels will become flat when the F6 button is pressed.

Memorizing the Equalizer Settings

- 1 Recalls the manufacturer's settings of the equalizer. In addition, allows you to store your own sound preferences for later recall. (see this page)
- 2 Press the **F** button within 10 seconds of step 1.
- 3 Within 10 seconds after operating step 2, press and hold any one of the **Preset buttons (F1 through F6)** for at least 2 seconds.
- 4 Repeat steps 1 to 3 to store other settings.

Recalling the Memorized Equalizer

- 1 Press **7-Band Graphic EQ** button to switch to the EQ mode.
- 2 Press the **F** button.
- 3 To recall your preset, pressing one of the **Preset buttons (F1 through F6)** within 10 seconds after the operation in Section 2. This provides sound characteristics of your own design.

Memorizing the Time Correction Setting

- 1 Adjust the time correction setting. (Refer to page 14)
- 2 Press the **F** button within 10 seconds of step 1.
- 3 Within 10 seconds after operating step 2, press and hold any one of the **Preset buttons (F1 through F6)** for at least 2 seconds. To memorize further, repeat the step 1 to 3.

Recalling the Memorized Time Correction Setting

- 1 Press the **Digital Time Correction** button to switch to the Time Correction mode.
- 2 To recall your preset, pressing one of the **Preset buttons (F1 through F6)** within 10 seconds after the operation in step 1. You can recall the memorized setting.

Basic Operation

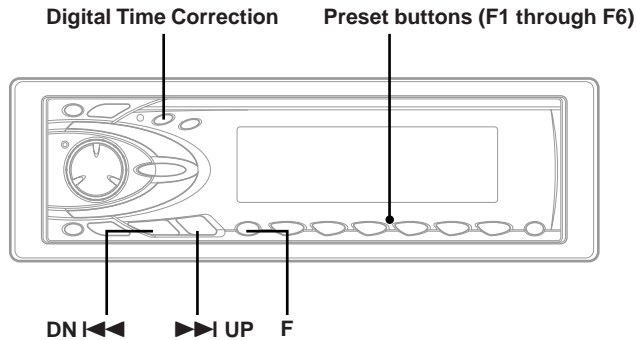

Adjusting the Time Correction

Time Correction:

The distance between the listener and the speakers in a car vary widely due to the special conditions of the mobile environment. This difference in the distances from the speakers to the listener creates a shift in the sounds image and frequency characteristics. This is caused by the time delay between the sound reaching the listener's right versus the left ear.

To correct this, the CDA-7969/CDA-7867 is able to delay the audio signal to the speakers closest to the listener. This effectively creates a perception of increased distance for those speakers. The listener can be placed at an equal distance between the left and right speakers for optimum staging.

The adjustment will be made for each speaker in a step of 0.1 mS.

Example 1. Listening Position: Front Left Seat

Adjust the time correction level of the front left speaker to a high value and the rear right to zero or a low value.

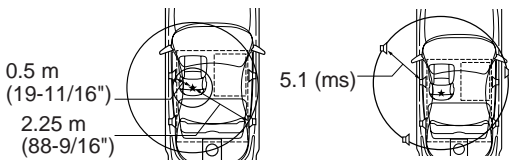

Here we calculate the time correction value for the front right tweeter in the diagram at the left.

Conditions:

Farthest Speaker – listening position: 2.25 m (88-9/16")

Front right tweeter – listening position: 0.5 m (19-11/16")

Calculation: $L = 2.25 \text{ m} - 0.5 \text{ m} = 1.75 \text{ m} (68-7/8")$

Time correction = $1.75 \div 343^* \times 1000 = 5.1 \text{ (ms)}$

*Speed of sound: 343 m/s (765 mph) at 20°C

In other words, giving the front right tweeter a time correction value of 5.1 ms makes it seem as if the distance to the front right tweeter is the same as the distance to the farthest speaker.

The sound is not balanced because the distance between the listening position and the various speakers is different. The difference in distance between the front right speaker and the rear left speaker is 1.75 m (68-7/8").

Time correction eliminates the differences in the time required for the sound to reach the listening position. The time of the front right speaker is corrected by 5.1 ms so that its sound reaches the listening position at the same time as the sound of other speakers.

Example 2. Listening Position: All Seats

Adjust the time correction level of each speaker to almost the same level.

- 1 Sit in the listening position (driver's seat, etc.) and measure the distance (in meters) between your head and the various speakers.
- 2 Calculate the difference between the distance to the farthest speaker and the other speakers.
 $L = (\text{distance to farthest speaker}) - (\text{distance to other speakers})$
- 3 Divide the distances calculated for the speakers by the speed of sound (343 m/s (765 mph) at 20°C).
These values are the time correction values for the different speakers.
- 4 Press the **Digital Time Correction** button for at least 2 seconds to switch to the Time Correction adjusting mode.
- 5 Select a speaker to be adjusted by pressing the **Preset buttons (F1 through F6)** button within 10 seconds of step 1.

F1: F/L (Front Left Speaker)

F2: F/R (Front Right Speaker)

F3: R/L (Rear Left Speaker)

F4: R/R (Rear Right Speaker)

F5: S/L (Subwoofer Left)

F6: S/R (Subwoofer Right)

- 6 Adjust the time correction value by pressing the **DN** button or the **UP** button within 10 seconds of step 5.

To adjust the time correction value for other speaker, repeat the steps 5 and 6.

NOTE

Up to 6 time correction settings can be stored in the available Presets.

Refer to "Memorizing the Time Correction Setting" on page 13.

Radio Operation

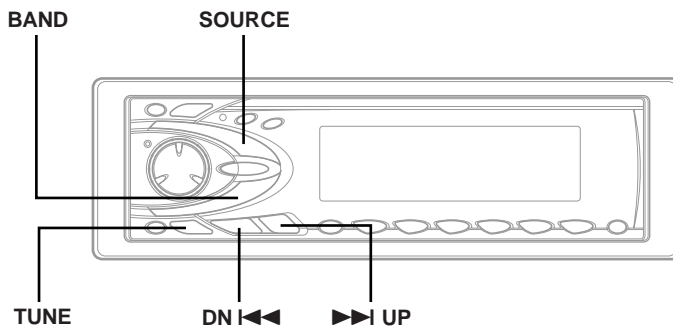

Manual Tuning

- 1 Press the **SOURCE** button until a radio frequency appears in the display.
- 2 Press the **BAND** button repeatedly until the desired radio band is displayed. Each press changes the band:
→ FM1 → FM2 → AM →
- 3 Press the **TUNE** button repeatedly until "DX SEEK" and "SEEK" disappear from the display.

NOTE

The initial mode is DX SEEK.

- 4 Press the **DN I<<<** or **>>> I UP** button to move downward or upward one step respectively until the desired station frequency is displayed.

NOTE

The ST indicator appears on the display when a Stereo FM station is tuned in.

Automatic Seek Tuning

- 1 Press the **SOURCE** button until a radio frequency appears in the display.
- 2 Press the **BAND** button repeatedly until the desired radio band is displayed. Each press changes the band:
→ FM1 → FM2 → AM →
- 3 Press the **TUNE** button to illuminate the DX and SEEK indicators in the display. With the DX (Distance) mode activated, both strong and weak stations will be tuned in the Auto-Seek operation. Press again to return to the local mode. The DX indicator will turn off and the SEEK indicator will remain illuminated. Now, only strong stations will be tuned.
- 4 Press the **DN I<<<** or **>>> I UP** button to automatically seek for a station downward or upward respectively. The unit will stop at the next station it finds. Press the same button again to seek the next station.

Radio Operation

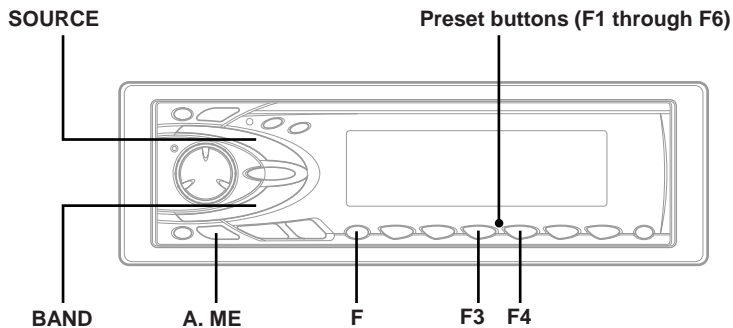

Manual Storing of Station Presets

- 1** Select the radio band and tune in a desired radio station you wish to store in the preset memory.
- 2** Press and hold any one of the **Preset buttons (F1 through F6)** for at least 2 seconds until the station frequency on the display blinks.
- 3** Press the **Preset** button into which you wish to store the station while the frequency display is blinking (within 5 seconds). The display stops blinking once the station has been memorized. The display shows the band, preset No. with a triangle (\triangle) and station frequency memorized.
- 4** Repeat the procedure to store up to 5 other stations onto the same band. To use this procedure for other bands, simply select the band desired and repeat the procedure. A total of 24 stations can be stored in the preset memory (6 stations for each band; FM1, FM2, AM and D.A.P.).

NOTE

If you store a station in a preset memory which already has a station, the current station will be cleared and replaced with the new station.

Automatic Memory of Station Presets

- 1** Press the **SOURCE** button to select the radio mode.
- 2** Press the **BAND** button repeatedly until the desired radio band is displayed.
- 3** Press and hold the **A. ME** button for at least 2 seconds. The frequency on the display continues to change while the automatic memory is in progress. The tuner will automatically seek and store 6 strong stations in the selected band. They will be stored into F1 to F6 buttons in order of signal strength. When the automatic memory has been completed, the tuner goes to the station stored in the preset location No. 1.

NOTE

If no stations are stored, the tuner will return to the original station you were listening to before the auto memory procedure began.

Storing into Direct Access Preset (D.A.P.) Band

A combination of radio stations in any band (up to 6 stations) can be manually preset into the D.A.P. band.

- 1 Press the **F** button to illuminate the FUNC (Function) indicator.
- 2 Press the **F3** (DAP) button until DAP turns on.

Press the **BAND** button to select FM or AM. The selected band will be displayed. To memorize stations onto the D.A.P. band, follow the steps for the automatic or Manual Storing of Station Presets section above.

NOTE

This function can be used together with the Automatic Memory Preset.

To cancel the D.A.P. mode, press the **F3** button.

- 3 Press the **F** button to activate the normal mode. The FUNC indicator will turn off.

NOTE

Setting should be performed within 5 seconds after the "F" button is pressed. The unit will automatically return to the normal mode 5 seconds after pressing the "F" button.

Tuning to Preset Stations

- 1 Press the **SOURCE** button to select the radio mode.
- 2 Press the **BAND** button repeatedly until the desired band is displayed.
- 3 Press the station **Preset** button that has your desired radio station in memory. The display shows the band, preset number with a triangle and frequency of the station selected.

NOTE

You can call up the Preset stations by pressing the F1 or F2 button while the FUNC indicator is lit.

Mono/Stereo Switching

- 1 Press the **F** button to illuminate the FUNC (Function) indicator.
- 2 "ST" indicator appears when a stereo FM station is tuned in.

Press the **F4** (MONO) button to switch from stereo to monaural FM reception. This will help in reducing the noise of weak FM Stereo broadcasts. Press the **F4** button again to return to the stereo mode.
- 3 Press the **F** button to activate the normal mode. The FUNC indicator will turn off.

NOTE

Setting should be performed within 5 seconds after the "F" button is pressed. The unit will automatically return to the normal mode 5 seconds after pressing the "F" button.

CD Player Operation

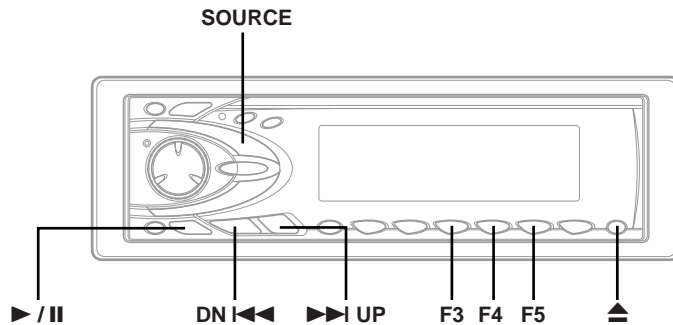

Opening and Closing the Movable display

- 1 Press the ▲ button.
The movable display will open.

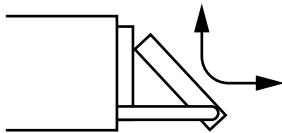

To close the movable display, press the ▲ button again.
The movable display will close.

NOTES

- Do not apply shock to the movable display when it is open as it may result in malfunction of the unit.
- The display may be dim during low temperatures and immediately after turning on the power. The brightness will return to normal as time elapses.
- The display will stop at the set angle when closing.

CAUTION

Keep hands (or any other object) away from the display while it is opening or closing to avoid damage or injury. The back of the movable display will get very warm under normal operating conditions. This is not a malfunction. Do not touch.

Playback

- 1 Press the ▲ button.
The movable display will open.

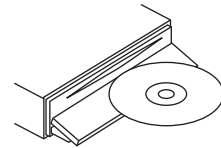

Insert a disc with the label side facing up.

- 2 Insert a disc with the label side facing up.
The disc will be pulled into the unit automatically. The movable display will close and playback will begin.

When a disc is already inserted, press the **SOURCE** button to switch to the CD mode. The mode will change every time the button is pressed.

→ TUNER → CD → CD CHANGER* →

(* Only when the CD changer is connected)

- 3 To pause playback, press the ▶/II button. Pressing the ▶/II button again will resume playback.

- 4 To eject the disc, press the ▲ button.



NOTES

- The digital signal will be output from the Digital Output Connector if the CD mode is on. (CDA-7969 only)
- Three-inch (8cm) CD's can be used.
- If the CD does not eject, press ▲ button again for more than 3 seconds with the movable display open.
- Only compact discs containing the mark shown can be used.



- We cannot fully guarantee the playback of CD-R (CD-Recordable). You cannot playback CD-RW (CD-ReWritable) on this unit.

Music Sensor (Skip)

- 1 Momentarily press the **DN**   button once during CD play to return to the beginning of the current track. If you wish to access the beginning of a track further back, repeatedly press until you reach the desired track.

Press the **▶▶** **UP** button once to advance to the beginning of the next track. If you wish to access the beginning of a track further ahead, press repeatedly until the desired track is reached.

NOTE

The music sensor feature is functional in the play or pause mode.

Fast Forward and Backward

- 1 Press and hold the **DN**   or **▶▶** **UP** button to quickly move backward or forward until you reach the desired section of the track.

Repeat Play

- 1 Press the **F4** (RPT) button to play back repeatedly the track being played. The track will be played repeatedly.

Press the **F4** button again and select OFF to deactivate the repeat play.

NOTES

- *If a CD Changer is connected and the RPT ALL mode is selected, the unit repeatedly plays back all tracks on the disc selected.*

→ REPEAT ONE → REPEAT ALL → (off) →

- *In case a 6-disc CD changer is connected:
In CD changer mode, press the "F" button to illuminate the FUNC indicator and go to step 1 within 5 seconds.*
- *In case a 12-disc CD changer is connected:
In changer mode, press the "F" button twice to illuminate the FUNC indicator and go to step 1 within 5 seconds.*

M.I.X. (Random Play)

- 1 Press the **F3** (MIX) button in the play or pause mode. The tracks on the disc will be played back in a random sequence. After all the tracks on the disc have been played back once, the player will begin a new random sequence play until the M.I.X. mode is cancelled.

To cancel M.I.X. play, press the **F3** button again to turn off the M.I.X.

NOTES

- *If a CD Changer equipped with the MIX ALL function is connected, MIX ALL will also be selectable. In this mode, the tracks on all the CDs in the current magazine will be included in the random playback sequence.*

→ MIX → MIX ALL → (off) →

- *In case a 6-disc CD changer is connected:
In CD changer mode, press the "F" button to illuminate the FUNC indicator and go to step 1 within 5 seconds.*
- *In case a 12-disc CD changer is connected:
In CD changer mode, press the "F" button twice to illuminate the FUNC indicator and go to step 1 within 5 seconds.*

Scanning Programs

- 1 Press the **F5** (SCAN) button to activate the Scan mode. The first 10 seconds of each track will be played back in succession.

To stop scanning, press the **F5** button and deactivate the Scan mode.

NOTES

- *In case a 6-disc CD changer is connected:
In CD changer mode, press the "F" button to illuminate the FUNC indicator and go to step 1 within 5 seconds.*
- *In case a 12-disc CD changer is connected:
In CD changer mode, press the "F" button twice to illuminate the FUNC indicator and go to step 1 within 5 seconds.*

CD Player Operation

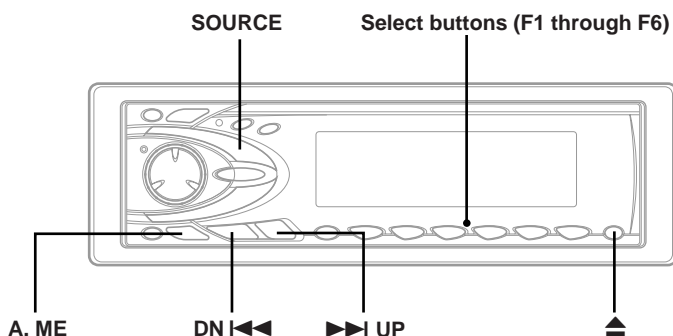

Controlling CD Changer (Optional)

An optional 6-disc or 12-disc CD Changer may be connected to the CDA-7969/CDA-7867 if it is Ai-NET compatible. With a CD Changer connected to the Ai-NET input of the CDA-7969/CDA-7867, the CD Changer will be controllable from the CDA-7969/CDA-7867.

Using the KCA-400C (the Multi-Changer Switching device) multiple changers can be controlled by the CDA-7969/CDA-7867.

See the Multi-Changer Selection section on page 21 for selecting the CD Changers.

NOTES

- The controls on the CDA-7969/CDA-7867 for CD Changer operation are operative only when a CD Changer is connected.
- The "Changer" indicator illuminates in the CD Changer mode.

When a 12-disc CD Changer is connected:

To select discs numbered from 1 to 6, the procedure is the same as for the 6-disc CD Changer. To select discs numbered from 7 to 12, first press the "F" button. This changes the "D" indicator to "d." Then press the desired Preset button. With the "F" button activated, the Preset buttons 1 to 6 will represent discs 7 to 12 respectively.

- 1** Press the **SOURCE** button to activate the CHANGER mode. The display shows the "Changer," disc number and track number.

NOTE

The source indicator varies depending on the connected source.

- 2** Press the Disc **Select buttons (F1 through F6)** corresponding to one of the discs loaded in the CD Changer. The selected disc number appears in the display and CD playback starts.

NOTES

- After selecting the desired disc, you can operate in the same way as for the CDA-7969/CDA-7867 CD player. For details, please see the CD Operation section.
- If the FUNC indicator is illuminated the Disc Select buttons become nonfunctional.

Multi-Changer Selection

Alpine's Ai-NET system will support up to 6 CD Changers. When operating two or more changers, the KCA-400C (Multi-Changer Switching device) must be used. If you use 1 Switching device, you can connect up to 4 CD Changers. If you use 2 Switching devices, you can connect up to 6 CD Changers.

- 1 Press the **SOURCE** button on the CDA-7969/CDA-7867 to activate the CD Changer mode.

Alternatively, press the SOURCE button on the Remote Control (RUE-4185) to activate the CD Changer mode. Proceed to step 3 below to select the desired CD Changer.

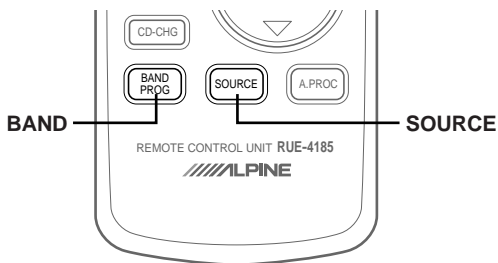

- 2 Press the **BAND** button on the CDA-7969/CDA-7867 or the RUE-4185 to activate the CD Changer Selection mode.
- 3 The CD Changer Selection mode remains active for 3 seconds after step 2 is performed. Press the **BAND** button until the desired CD Changer indicator appears on the display.

NOTE

If the selected CD Changer is not connected, the display will show "NO CHANGER."

Alternatively press the **BAND** button on the Remote Control until the desired changer indicator appears on the display.

- 4 To operate the selected changer, see "CD Player Operation" section.

Remote Control Operation

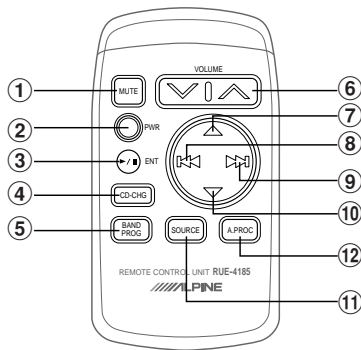

Controls on Remote Control

- ① Mute Button**
Press the button to lower the volume by 20 dB instantly. Press the button again to cancel.
- ② Power Switch**
Press the switch to turn the power on/off.
- ③ ▶/|| Button**
Press the button to switch between the Play and Pause modes for CD.
- ④ CD Changer Button**
Press the button to change to the CD changer operation.
- ⑤ Band/Program Button**
Radio mode: BAND Button
Press the button and the band will change as shown below.

→ FM1 → FM2 → AM →
- ⑥ Volume Adjustment Buttons**
To increase the volume level:
Press the ▲ button
To decrease the volume level:
Press the ▼ button
- ⑦ ▲ Button**
Radio mode: Pressing the button will select, in ascending order, stations programmed into the radio's presets as shown below.

→ 1 → 2 ... 6 →

CD Changer mode: DISC Select (UP) Button
Press the button to select a disc in ascending order.
- ⑧ ◀◀ Button**
Radio mode: SEEK (DN) Button
CD mode: Press the button to go back to the beginning of the current track.
- ⑨ ▶▶ Button**
Radio mode: SEEK (UP) Button
CD mode: Press the button to advance to the beginning of the next track.
- ⑩ ▼ Button**
Radio mode: Pressing the button will select, in descending order, stations programmed into the radio's presets as shown below.

→ 6 → 5 ... 1 →

CD Changer mode: DISC Select (DN) Button
Press the button to select a disc in descending order.
- ⑪ Source Button**
Press to select the audio source.
- ⑫ Audio Processor Button****
Press the button to call the external audio processor mode.*

* For the operation of external audio processor, refer to the Owner's Manual of the external audio processor you purchased.

** This button is used in conjunction with an optional Ai-NET processor.

Battery Replacement

Applicable battery: Use two "AAA" sized dry batteries or equivalent.

- 1** Opening the battery cover
Slide out the battery cover while firmly pressing outward.

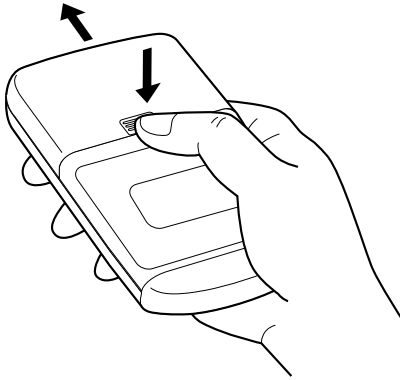

- 2** Replacing the battery
Put the batteries in the case observing the polarities as illustrated.

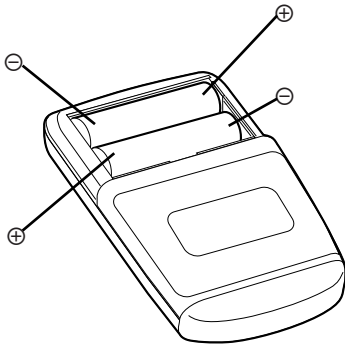

- 3** Closing the cover
Push the cover as illustrated until a click is heard.

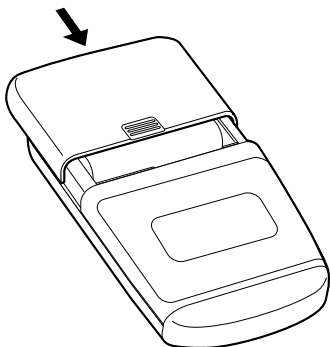

Information

In Case of Difficulty

If you encounter a problem, please review the items in the following checklist. This guide will help you isolate the problem if the unit is at fault. Otherwise, make sure the rest of your system is properly connected or consult your authorized Alpine dealer.

Basic

No function or display.

- Vehicle's ignition is off.
 - If connected following instructions, the unit will not operate with the vehicle's ignition off.
 - Improper power lead connections.
 - Check power lead connections.
 - Blown fuse.
 - Check the fuse on the battery lead of the unit; replace with the proper value if necessary.
 - Internal micro-computer malfunctioned due to interference noise etc.
 - Press the RESET switch with a ball-point pen or other pointed article.
-

Radio

Unable to receive stations.

- No antenna or open connection in cable.
 - Make sure the antenna is properly connected; replace the antenna or cable if necessary.

Unable to tune stations in the seek mode.

- You are in a weak signal area.
 - Make sure the tuner is in the DX mode.
- If the area you are in is a primary signal area, the antenna may not be grounded and connected properly.
 - Check your antenna connections; make sure the antenna is properly grounded at its mounting location.
- The antenna may not be the proper length.
 - Make sure the antenna is fully extended; if broken, replace the antenna with a new one.

Broadcast is noisy.

- The antenna is not the proper length.
 - Extend the antenna fully; replace it if it is broken.
 - The antenna is poorly grounded.
 - Make sure the antenna is grounded properly at its mounting location.
-

CD

CD Player/Changer not functioning.

- Out of operating temperature range +50°C (+120°F) for CD.
 - Allow the vehicle's interior (or trunk) temperature to cool.

CD playback sound is wavering.

- Moisture condensation in the CD Module.
 - Allow enough time for the condensation to evaporate (about 1 hour).

CD insertion not possible.

- A CD is already in the CD player.
 - Eject the CD and remove it.
- The CD is being improperly inserted.
 - Make sure the CD is being inserted following instructions in the CD Player Operation section.

Unable to fast forward or backward the CD.

- The CD has been damaged.
 - Eject the CD and discard it; using a damaged CD in your unit can cause damage to the mechanism.

CD playback sound skips due to vibration.

- Improper mounting of the unit.
 - Securely re-mount the unit.
- Disc is very dirty.
 - Clean the disc.
- Disc has scratches.
 - Change the disc.

CD playback sound skips without vibration.

- Dirty or scratched disc.
 - Clean the disc; damaged disc should be replaced.

Error displays (built-in CD player only)

- Mechanical error
 - Press the ▲ button. After the error indication disappears, insert the disc again. If the above-mentioned solution does not solve the problem, consult your nearest ALPINE dealer.

Indication for CD Changer

HIGH-TEMP

- Protective circuit is activated due to high temperature.
 - The indicator will disappear when the temperature returns to within operation range.
-

ERROR

- Malfunction in the CD Changer.
 - Consult your Alpine dealer. Press the magazine eject button and pull out the magazine. Check the indication. Insert the magazine again. If the magazine cannot be pulled out, consult your Alpine dealer.
 - Magazine ejection not possible.
 - Press the magazine eject button. If the magazine does not eject, consult your Alpine dealer.
 - A disc is left inside the CD Changer.
 - Press the Eject button to activate the eject function. When the CD Changer finishes the eject function, insert an empty CD magazine into the CD Changer to receive the disc left inside the CD Changer.
-

NO MAGAZINE

- No magazine is loaded into the CD Changer.
 - Insert a magazine.
-

NO DISC

- No indicated disc.
 - Choose another disc.
-

Specifications

FM TUNER SECTION

Tuning Range	87.7 – 107.9 MHz
Mono Usable Sensitivity	9.3 dBf (0.8 μ V/75 ohms)
50 dB Quieting Sensitivity	13.5 dBf (1.3 μ V/75 ohms)
Alternate Channel Selectivity	80 dB
Signal-to-Noise Ratio	80 dB
Stereo Separation	45 dB
Capture Ratio	2.0 dB

AM TUNER SECTION

Tuning Range	530 – 1,710 kHz
Sensitivity (IEC Standard)	22.5 μ V/27 dB

CD PLAYER SECTION

Frequency Response	5 – 20,000 Hz (\pm 1 dB)
Wow & Flutter (% WRMS)	Below measurable limits
Total Harmonic Distortion	0.008% (at 1 kHz)
Dynamic Range	95 dB (at 1 kHz)
Signal-to-Noise Ratio	105 dB
Channel Separation	85 dB (at 1 kHz)

REMOTE CONTROL

Battery Type	AAA batteries (2 pcs.)
--------------	------------------------

REMOTE CONTROL SIZE

Width	56 mm (2-1/4")
Height	14 mm (9/16")
Depth	105 mm (4-1/8")
Weight	50 g (1.8 oz)

GENERAL

Power Requirement	14.4 V DC (11–16 V allowable)
Maximum Power Output	45 W \times 4 (CDA-7867 only)
Maximum Pre-Output Voltage	4 V/10 k ohms
Weight	1.5 kg (3 lbs. 5 oz)

CHASSIS SIZE

Width	178 mm (7")
Height	50 mm (2")
Depth	155 mm (6-1/8")

NOSEPIECE SIZE

Width	165 mm (6-1/2")
Height	46 mm (1-13/16")
Depth	18 mm (11/15")

Due to continuous product improvement, specifications and design are subject to change without notice.

Installation and Connections

Before installing or connecting the unit, please read the following and pages 2 and 3 of this manual thoroughly for proper use.

Warning

MAKE THE CORRECT CONNECTIONS.

Failure to make the proper connections may result in fire or product damage.

USE ONLY IN CARS WITH A 12 VOLT NEGATIVE GROUND.

(Check with your dealer if you are not sure.) Failure to do so may result in fire, etc.

BEFORE WIRING, DISCONNECT THE CABLE FROM THE NEGATIVE BATTERY TERMINAL.

Failure to do so may result in electric shock or injury due to electrical shorts.

DO NOT ALLOW CABLES TO BECOME ENTANGLED IN SURROUNDING OBJECTS.

Arrange wiring and cables in compliance with the manual to prevent obstructions when driving. Cables or wiring that obstruct or hang up on places such as the steering wheel, gear lever, brake pedals, etc. can be extremely hazardous.

DO NOT SPLICE INTO ELECTRICAL CABLES.

Never cut away cable insulation to supply power to other equipment. Doing so will exceed the current carrying capacity of the wire and result in fire or electric shock.

DO NOT DAMAGE PIPE OR WIRING WHEN DRILLING HOLES.

When drilling holes in the chassis for installation, take precautions so as not to contact, damage or obstruct pipes, fuel lines, tanks or electrical wiring. Failure to take such precautions may result in fire.

DO NOT USE BOLTS OR NUTS IN THE BRAKE OR STEERING SYSTEMS TO MAKE GROUND CONNECTIONS.

Bolts or nuts used for the brake or steering systems (or any other safety-related system), or tanks should NEVER be used for installations or ground connections. Using such parts could disable control of the vehicle and cause fire etc.

KEEP SMALL OBJECTS SUCH AS BATTERY OUT OF THE REACH OF CHILDREN.

Swallowing them may result in serious injury. If swallowed, consult a physician immediately.

DO NOT INSTALL IN LOCATIONS WHICH MIGHT HINDER VEHICLE OPERATION, SUCH AS THE STEERING WHEEL OR GEARSHIFT.

Doing so may obstruct forward vision or hamper movement etc. and results in serious accident.

Caution

HAVE THE WIRING AND INSTALLATION DONE BY EXPERTS.

The wiring and installation of this unit requires special technical skill and experience. To ensure safety, always contact the dealer where you purchased this product to have the work done.

USE SPECIFIED ACCESSORY PARTS AND INSTALL THEM SECURELY.

Be sure to use only the specified accessory parts. Use of other than designated parts may damage this unit internally or may not securely install the unit in place. This may cause parts to become loose resulting in hazards or product failure.

ARRANGE THE WIRING SO IT IS NOT CRIMPED OR PINCHED BY A SHARP METAL EDGE.

Route the cables and wiring away from moving parts (like the seat rails) or sharp or pointed edges. This will prevent crimping and damage to the wiring. If wiring passes through a hole in metal, use a rubber grommet to prevent the wire's insulation from being cut by the metal edge of the hole.

DO NOT INSTALL IN LOCATIONS WITH HIGH MOISTURE OR DUST.

Avoid installing the unit in locations with high incidence of moisture or dust. Moisture or dust that penetrates into this unit may result in product failure.

Precautions

- Be sure to disconnect the cable from the (-) battery post before installing your CDA-7969/CDA-7867. This will reduce any chance of damage to the unit in case of a short-circuit.
- Be sure to connect the color coded leads according to the diagram. Incorrect connections may cause the unit to malfunction or damage to the vehicle's electrical system.
- When making connections to the vehicle's electrical system, be aware of the factory installed components (e.g. on-board computer). Do not tap into these leads to provide power for this unit. When connecting the CDA-7969/CDA-7867 to the fuse box, make sure the fuse for the intended circuit of the CDA-7969/CDA-7867 has the appropriate amperage. Failure to do so may result in damage to the unit and/or the vehicle. When in doubt, consult your ALPINE dealer.
- The CDA-7969/CDA-7867 uses female RCA-type jacks for connection to other units (e.g. amplifier) having RCA connectors. You may need an adaptor to connect other units. If so, please contact your authorized ALPINE dealer for assistance.
- Be sure to connect the speaker (-) leads to the speaker (-) terminal. Never connect left and right channel speaker cables to each other or to the vehicle body.

IMPORTANT

Please record the serial number of your unit in the space provided below and keep it as a permanent record. The serial number plate is located on the bottom of the unit.

SERIAL NUMBER: _____
INSTALLATION DATE: _____
INSTALLATION TECHNICIAN: _____
PLACE OF PURCHASE: _____

Installation

1

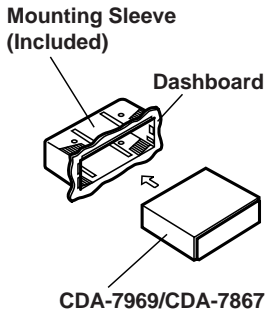

Slide mounting sleeve from main unit (see "Removal" on this page).
Slide the mounting sleeve into the dashboard.

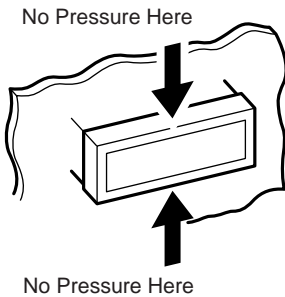

2

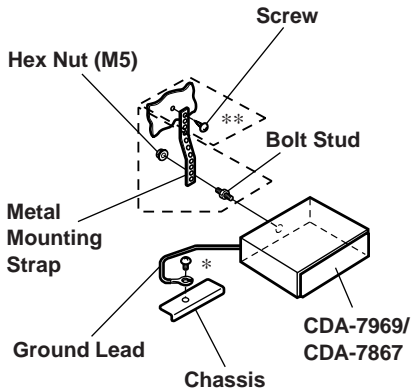

Reinforce the head unit with the metal mounting strap (not supplied). Secure the ground lead of the unit to a clean metal spot using a screw (*) already attached to the vehicle's chassis.

NOTE

For the screw marked **, use an appropriate screw for the chosen mounting location.

Connect each input lead coming from an amplifier or equalizer to the corresponding output lead coming from the left rear of the CDA-7969/CDA-7867. Connect all other leads of the CDA-7969/CDA-7867 according to details described in the CONNECTIONS section.

3

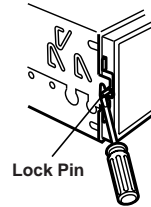

Slide the CDA-7969/CDA-7867 into the dashboard. When the unit is in place, make sure the locking pins are fully seated in the down position. This can be done by pressing firmly in on the unit while pushing the locking pin down with a small screwdriver. This ensures that the unit is properly locked and will not accidentally come out from the dashboard.

Removal

- 1 Use a small screwdriver (or similar tool) to push the locking pins to the "up" position (see above drawing). As each pin is unlocked, gently pull out on the unit to make sure it does not re-lock before unlocking the second pin.
- 2 Pull the unit out, keeping it unlocked as you do so.

<JAPANESE CAR>

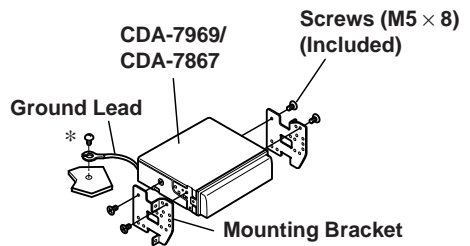
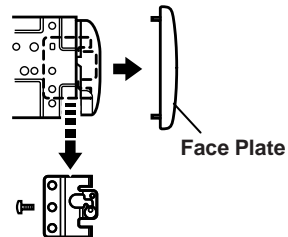

NOTE

Secure the ground lead of the unit to a clean metal spot using a screw (*) already attached to the vehicle's chassis.

Installation and Connections

Connections

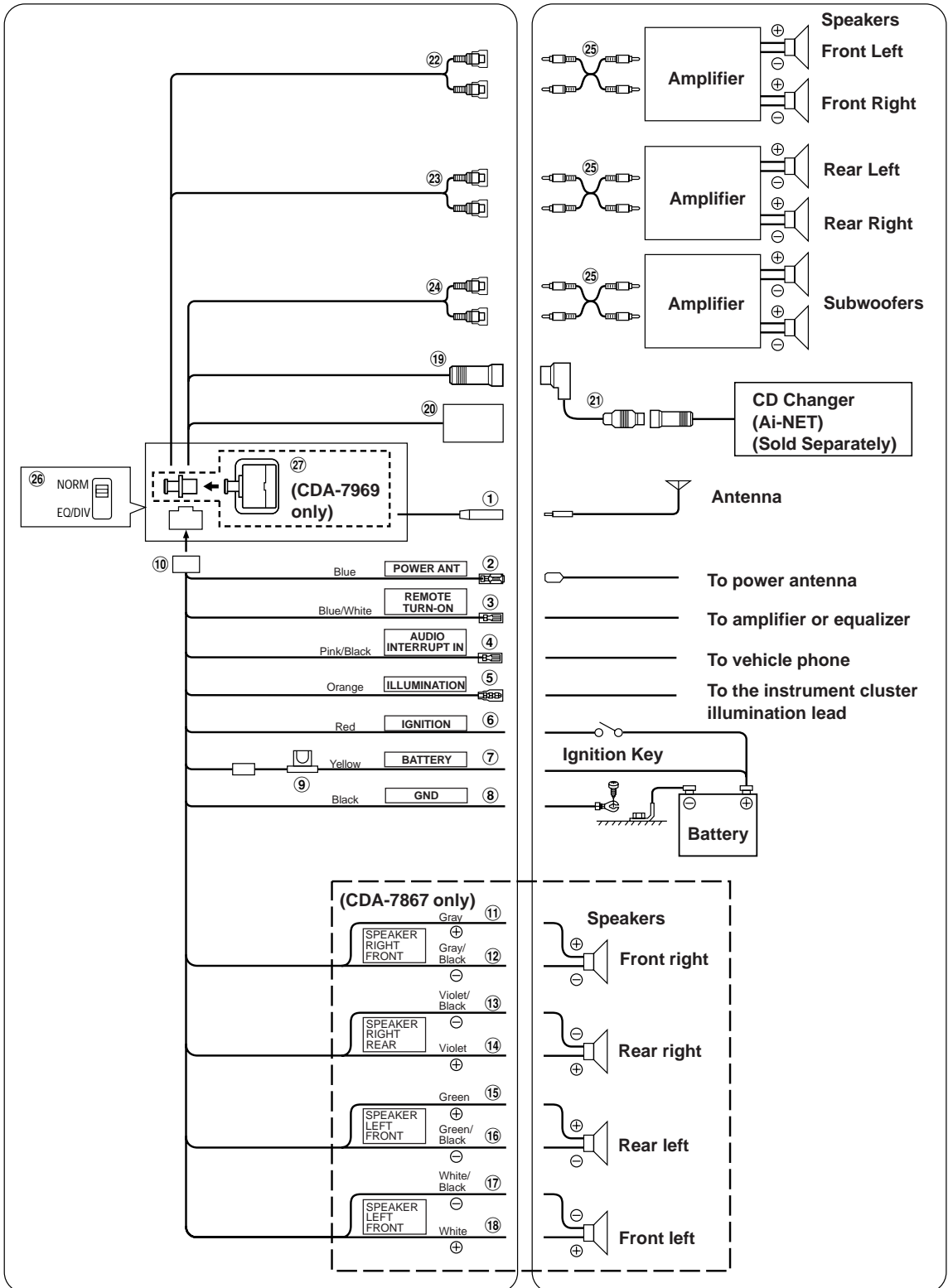

For details on how to set the Subwoofer to ON/OFF, see "Subwoofer On and Off" on page 6.

- ① Antenna Receptacle
- ② Power Antenna Lead (Blue)
Connect this lead to the +B terminal of your power antenna, if applicable.
NOTE
This lead should be used only for controlling the vehicle's power antenna. Do not use this lead to turn on an amplifier or a signal processor, etc.
- ③ Remote Turn-On Lead (Blue/White)
Connect this lead to the remote turn-on lead of your amplifier or signal processor.
- ④ Audio Interrupt In Lead (Pink/Black)
- ⑤ Illumination Lead (Orange)
This lead may be connected to the vehicle's instrument cluster illumination lead. This will allow the backlighting of the CDA-7969/CDA-7867 to dim whenever the vehicle's lights are turned on.
- ⑥ Switched Power Lead (Ignition) (Red)
Connect this lead to an open terminal on the vehicle's fuse box or another unused power source which provides (+)12V only when the ignition is turned on or in the accessory position.
- ⑦ Battery Lead (Yellow)
Connect this lead to the positive (+) post of the vehicle's battery.
- ⑧ Ground Lead (Black)
Connect this lead to a good chassis ground on the vehicle. Make sure the connection is made to bare metal and is securely fastened using the sheet metal screw provided.
- ⑨ Fuse Holder
 - CDA-7969 7.5A
 - CDA-7867 15A
- ⑩ Power Supply Connector
- ⑪ Right Front (+) Speaker Output Lead (Gray) (CDA-7867 only)
- ⑫ Right Front (-) Speaker Output Lead (Gray/Black) (CDA-7867 only)
- ⑬ Right Rear (-) Speaker Output Lead (Violet/Black) (CDA-7867 only)
- ⑭ Right Rear (+) Speaker Output Lead (Violet) (CDA-7867 only)
- ⑮ Left Rear (+) Speaker Output Lead (Green) (CDA-7867 only)
- ⑯ Left Rear (-) Speaker Output Lead (Green/Black) (CDA-7867 only)
- ⑰ Left Front (-) Speaker Output Lead (White/Black) (CDA-7867 only)
- ⑱ Left Front (+) Speaker Output Lead (White) (CDA-7867 only)
- ⑲ Ai-NET Connector
Connect this to the output or input connector of other product (CD Changer, Equalizer, etc.) equipped with Ai-NET.
NOTE
You can input TV/video sound by connecting an optional Ai-NET/RCA Interface cable (KCA-121B) to this component.
- ⑳ DC/DC Converter
NOTES
 - Do not install the converter at a location subjected to water such as under the floor mat or air conditioner. This may cause a malfunction.
 - Do not bundle the DC/DC converter cable with other audio cables. Doing so may induce noise into your system.
- ㉑ Ai-NET Cable (Included with CD Changer)
- ㉒ Front Output RCA Connectors
RED is right and WHITE is left.
- ㉓ Rear Output RCA Connectors
RED is right and WHITE is left.
- ㉔ Subwoofer RCA Connectors
RED is right and WHITE is left.
- ㉕ RCA Extension Cable (Sold Separately)
- ㉖ System Switch
When connecting an equalizer or divider using Ai-NET feature, place this switch in the EQ/DIV position. When no device is connected, leave the switch in the NORM position.
NOTE
Be sure to turn the power off to the unit before changing the switch position.
- ㉗ The Digital Output Connector (CDA-7969 only)
Connect this to any other optical digital products of ALPINE.
The digital signal will be output when the CD mode is on.

To prevent external noise from entering the audio system.

- Locate the unit and route the leads at least 10cm away from the car harness.
- Keep the battery power leads as far away from other leads as possible.
- Connect the ground lead securely to a bare metal spot (remove the coating if necessary) of the car chassis.
- If you add an optional noise suppressor, connect it as far away from the unit as possible. Your Alpine dealer carries various Alpine noise suppressors, contact them for further information.
- Your Alpine dealer knows best about noise prevention measures so consult your dealer for further information.

Free Manuals Download Website

<http://myh66.com>

<http://usermanuals.us>

<http://www.somanuals.com>

<http://www.4manuals.cc>

<http://www.manual-lib.com>

<http://www.404manual.com>

<http://www.luxmanual.com>

<http://aubethermostatmanual.com>

Golf course search by state

<http://golfingnear.com>

Email search by domain

<http://emailbydomain.com>

Auto manuals search

<http://auto.somanuals.com>

TV manuals search

<http://tv.somanuals.com>