



EN

FM/AM CD Receiver CDA-9807

MLX

MP3



FR

FM/AM CD Receiver CDA-9805

MLX



ES

- OWNER'S MANUAL
Please read before using this equipment.
- MODE D'EMPLOI
Veuillez lire avant d'utiliser cet appareil.
- MANUAL DE OPERACIÓN
Léalo antes de utilizar este equipo.

ALPINE ELECTRONICS MARKETING, INC.
1-1-8 Nishi Gotanda,
Shinagawa-ku,
Tokyo 141-0031, Japan
Phone 03-5496-8231

ALPINE ELECTRONICS OF AMERICA, INC.
19145 Gramercy Place, Torrance,
California 90501, U.S.A.
Phone 1-800-ALPINE-1 (1-800-257-4631)

ALPINE ELECTRONICS OF CANADA, INC.
7300 Warden Ave., Suite 203, Markham,
Ontario L3R 9Z6, Canada
Phone 1-800-ALPINE-1 (1-800-257-4631)

ALPINE ELECTRONICS OF AUSTRALIA PTY. LTD.
6-8 Fiveways Boulevard Keysborough,
Victoria 3173, Australia
Phone 03-9769-0000

ALPINE ELECTRONICS GmbH
Kreuzerkamp 7,
40878 Ratingen, Germany
Phone 02102-4550

ALPINE ELECTRONICS OF U.K. LTD.
Alpine House
Fletchamstead Highway, Coventry CV4 9TW, U.K.
Phone 0870-33 33 763

ALPINE ELECTRONICS FRANCE S.A.R.L.
(RCS PONTOISE B 338 101 280)
98, Rue de la Belle Etoile, Z.I. Paris Nord II,
B.P. 50016, 95945 Roissy Charles de Gaulle
Cedex, France
Phone 01-48638989

ALPINE ITALIA S.p.A.
Viale C. Colombo 8, 20090 Trezzano Sul
Naviglio (MI), Italy
Phone 02-484781

ALPINE ELECTRONICS DE ESPAÑA, S.A.
Portal de Gamarra 36, Pabellón, 32
01013 Vitoria (Alava)-APDO 133, Spain
Phone 945-283588

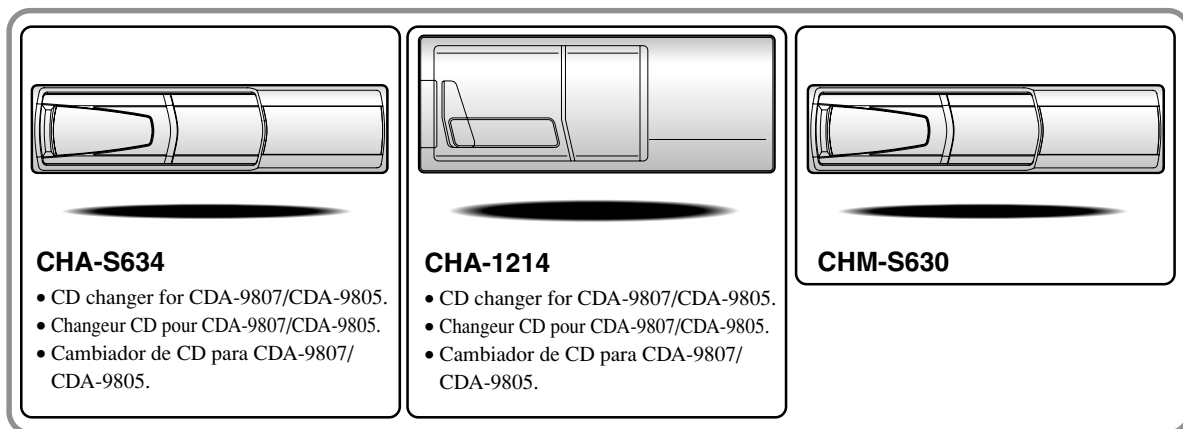

Alpine CD Changers Give You More!

More musical selections, more versatility, more convenience.

The CHA-S634 is a high-performance 6-disc changer with a new M DAC, CD-R/RW PLAY BACK, MP3 PLAY BACK and CD TEXT. The CHA-1214 Ai-NET model holds 12 discs, and the CHM-S630 M-Bus model is a super-compact 6-disc changer with a CD-R/RW PLAY BACK.

Changeurs de CD Alpine : vous avez le choix!

Plus de sélections musicales, plus de souplesse, plus de confort.

Le modèle CHA-S634 est un changeur 6 disques ultra performant équipé des nouvelles fonctions M DAC, CD-R/RW PLAY BACK, MP3 PLAY BACK et CD TEXT. Le modèle CHA-1214 Ai-NET contient 12 disques. Le modèle CHM-S630 M-Bus est un changeur 6 disques super compact doté de la fonction CD-R/RW PLAY BACK.

¡Los cambiadores Alpine de CD le ofrecen más!

Más selecciones musicales, más versatilidad y más ventajas.

CHA-S634 es un cambiador de seis discos de alto rendimiento con nuevo M DAC, CD-R/RW PLAY BACK, MP3 PLAY BACK y CD TEXT. El modelo CHA-1214 Ai-NET alberga 12 discos y el modelo CHM-S630 M-Bus es un cambiador de seis discos de tamaño reducido con un CD-R/RW PLAY BACK.

Contents

Operating Instructions



WARNING

WARNING	3
CAUTION	3
PRECAUTIONS	3



Basic Operation

Detaching the Front Panel	5
Attaching the Front Panel	5
Initial System Start-Up	5
Turning Power On and Off	5
Adjusting Volume/Balance (Between Left and Right)/Fader (Between Front and Rear)/Defeat	6
Audio Mute Function	6
Displaying Time	6
Setting Time	6
Setting the Bass Control	7
Setting the Treble Control	7
Setting the Bass Type	7
Setting the MX Mode	8
Blackout Mode On and Off	8
Displaying the Title/Text	9
Titling Discs/Stations	10
Erasing Disc Title/Station Title	10

SETUP Operation

Subwoofer On and Off	11
Scroll Setting	11
Turning Mute Mode On/Off	12
Setting the External Input Defeat Mode	12
Setting the AUX Mode (V-Link)	12
Connecting to an External Amplifier	13

Radio Operation

Changing the Radio Frequencies for each Country	14
Manual Tuning	14
Automatic Seek Tuning	14
Manual Storing of Station Presets	14
Automatic Memory of Station Presets	15
Tuning to Preset Stations	15
Station Title Search Function	15
Quick Search Function	15

CD Player Operation

Inserting/Ejecting Disc	16
Normal Play and Pause	16
Music Sensor (Skip)	17
Fast Forward and Backward	17
Repeat Play	17
M.I.X. (Random Play)	17
Scanning Programs	18
Track Search Function	18
Quick Search Function	18
Controlling CD Changer (Optional)	18
Multi-Changer Selection	19

MP3/WMA Operation

Playing MP3/WMA Files (CDA-9807 only) ..	20
Playing MP3 Files with the CD Changer (Optional)	20
Music Sensor (Skip)	20
Fast Forward and Backward	20
Repeat Play	20
M.I.X. (Random Play)	21
Scanning files	21
Folder/File Search Function	21
Quick Search Function	21
Playing MP3 Data	21

Windows Media, and the Windows logo are trademarks, or registered trademarks of Microsoft Corporation in the United States and / or other countries.

XM Radio Operation (Optional)

Receiving XM Channels with the XM Receiver (Optional)	22
Checking the XM Radio ID Number	22
Storing XM Channel Presets	22
Receiving Stored XM Channels	22
Channel/Category Search Function	23
Quick Search Function	23
Changing the Display	23
Setting the tuning method	23
Setting the Auxiliary Data Field Display	23

MobileHub™ Link Operation (Optional)

About MobileHub™ Link	24
Telephone Mode ON/OFF	24
Incoming Calls	24
Calling	
Calling by the address book	25
Calling by using the Speed Dial	25
Calling by the outgoing/incoming/absent/ incoming history	25
SMS (Short Message Service) Operation	
Receiving a short message	25

Remote Control Operation

Controls on Remote Control (CDA-9807 only)	26
Battery Replacement (CDA-9807 only)	27

Information

About MP3/WMA	28
In Case of Difficulty	30
Specifications	33

Installation and Connections

Warning	34
Caution	34
Precautions	34
Installation	35
Connections	36

LIMITED WARRANTY

WARNING

WARNING

This symbol means important instructions. Failure to heed them can result in serious injury or death.

DO NOT OPERATE ANY FUNCTION THAT TAKES YOUR ATTENTION AWAY FROM SAFELY DRIVING YOUR VEHICLE.

Any function that requires your prolonged attention should only be performed after coming to a complete stop. Always stop the vehicle in a safe location before performing these functions. Failure to do so may result in an accident.

KEEP THE VOLUME AT A LEVEL WHERE YOU CAN STILL HEAR OUTSIDE NOISE WHILE DRIVING.

Failure to do so may result in an accident.

MINIMIZE DISPLAY VIEWING WHILE DRIVING.

Viewing the display may distract the driver from looking ahead of the vehicle and cause an accident.

DO NOT DISASSEMBLE OR ALTER.

Doing so may result in an accident, fire or electric shock.

USE ONLY IN CARS WITH A 12 VOLT NEGATIVE GROUND.

(Check with your dealer if you are not sure.) Failure to do so may result in fire, etc.

KEEP SMALL OBJECTS SUCH AS BATTERIES OUT OF THE REACH OF CHILDREN.

Swallowing them may result in serious injury. If swallowed, consult a physician immediately.

USE THE CORRECT AMPERE RATING WHEN REPLACING FUSES.

Failure to do so may result in fire or electric shock.

DO NOT BLOCK VENTS OR RADIATOR PANELS.

Doing so may cause heat to build up inside and may result in fire.

USE THIS PRODUCT FOR MOBILE 12V APPLICATIONS.

Use for other than its designed application may result in fire, electric shock or other injury.

DO NOT PLACE HANDS, FINGERS OR FOREIGN OBJECTS IN INSERTION SLOTS OR GAPS.

Doing so may result in personal injury or damage to the product.

CAUTION

This symbol means important instructions. Failure to heed them can result in injury or material property damage.

HALT USE IMMEDIATELY IF A PROBLEM APPEARS.

Failure to do so may cause personal injury or damage to the product. Return it to your authorized Alpine dealer or the nearest Alpine Service Center for repairing.

DO NOT MIX NEW BATTERIES WITH OLD BATTERIES. INSERT WITH THE CORRECT BATTERY POLARITY.

When inserting the batteries, be sure to observe proper polarity (+ and -) as instructed. Rupture or chemical leakage from the battery may cause fire or personal injury.

PRECAUTIONS

Temperature

Be sure the temperature inside the vehicle is between +60°C (+140°F) and -10°C (+14°F) before turning your unit on.

Moisture Condensation

You may notice the CD playback sound wavering due to condensation. If this happens, remove the disc from the player and wait about an hour for the moisture to evaporate.

Damaged Disc

Do not attempt to play cracked, warped, or damaged discs. Playing a bad disc could severely damage the playback mechanism.

Maintenance

If you have problems, do not attempt to repair the unit yourself. Return it to your Alpine dealer or the nearest Alpine Service Station for servicing.

⚠ WARNING

⚠ PRECAUTIONS

Never Attempt the Following

Do not grip or pull out the disc while it is being pulled back into the player by the automatic reloading mechanism.

Do not attempt to insert a disc into the unit when the unit power is off.

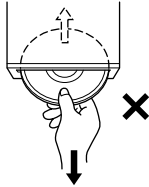

Inserting Discs

Your player accepts only one disc at a time for playback. Do not attempt to load more than one disc.

Make sure the label side is facing up when you insert the disc. Your player will automatically eject any disc that is inserted incorrectly. If the player continues to eject a correctly inserted disc, push the RESET switch with a pointed object such as a ballpoint pen.

Playing a disc while driving on a very bumpy road may result in skips, but this will not scratch the disc or damage the player.

New Discs

As a protective measure to prevent the CD from jamming, the CD player will automatically eject discs with irregular surfaces or inserted incorrectly. When a new disc is inserted into the player and ejected after initial loading, using your finger, feel around the inside of the centre hole and outside edge of the disc. If you feel any small bumps or irregularities, this could inhibit proper loading of the disc. To remove the bumps, rub the inside edge of the hole and outside edge of the disc with a ballpoint pen or other such instrument, then insert the disc again.

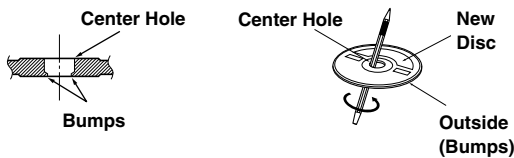

Irregular Shaped Discs

Be sure to use round shape discs only for this unit and never use any special shape discs.

Use of special shape discs may cause damage to the mechanism.

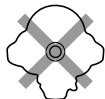

Installation Location

Make sure the CDA-9807/CDA-9805 will not be installed in a location subjected to:

- Direct sun and heat
- High humidity and water
- Excessive dust
- Excessive vibrations

Correct Handling

Do not drop the disc while handling. Hold the disc so you will not leave fingerprints on the surface. Do not affix tape, paper, or gummed labels to the disc. Do not write on the disc.

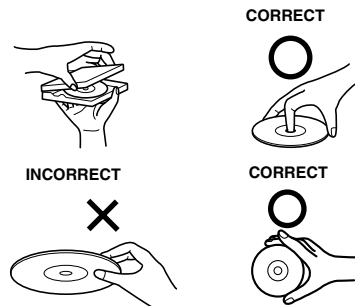

Disc Cleaning

Fingerprints, dust, or soil on the surface of the disc could cause the CD player to skip. For routine cleaning, wipe the playing surface with a clean, soft cloth from the centre of the disc to the outer edge. If the surface is heavily soiled, dampen a clean, soft cloth in a solution of mild neutral detergent before cleaning the disc.



Disc Accessories

There are various accessories available on the market for protecting the disc surface and improving sound quality. However, most of them will influence the thickness and/or diameter of the disc. Using such accessories can cause the disc to be out of standard specifications and may create operational problems. We recommend not using these accessories on discs played in Alpine CD players.

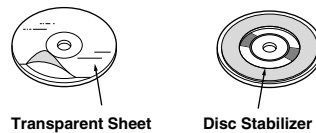

Basic Operation

SOURCE/POWER

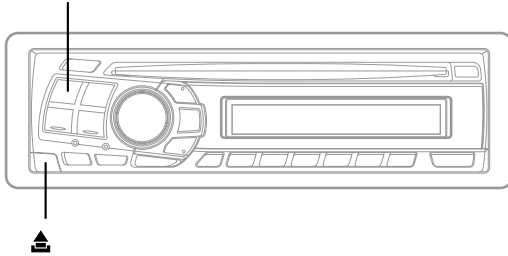

Detaching the Front Panel

- 1 Press and hold the **SOURCE/POWER** button for more than 3 seconds to turn off the power.
- 2 Press the  (Release) button at upper left side until the front panel pops out.
- 3 Grasp the left side of the front panel and pull it out.

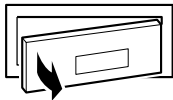

NOTES

- The front panel may become hot in normal usage (especially the connector terminals on the back of the front panel.) This is not a malfunction.
- To protect the front panel, place it in the supplied carrying case.

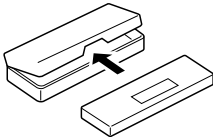

Attaching the Front Panel

- 1 First, insert the right side of the front panel into the main unit. Align the groove on the front panel with the projections on the main unit.
- 2 Push the left side of the front panel until it locks firmly into the main unit.

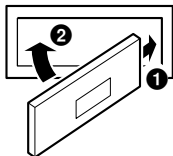

NOTES

- Before attaching the front panel, make sure that there is no dirt or dust on the connector terminals and no foreign object between the front panel and the main unit.
- Attaching the front panel carefully, holding the sides of the front panel to avoid pushing buttons by mistake.

Initial System Start-Up

Be sure to press the RESET switch when using the unit for the first time, after installing the CD changer, etc., or after changing the car battery.

To do this, first, remove the detachable front panel. Behind the front panel, to the right of the connector, there is a small hole. Using a ball-point pen or other pointed object, press the **RESET** switch mounted behind this hole to complete the initialization procedure.





RESET switch

Turning Power On and Off

- 1 Press the **SOURCE/POWER** button to turn on the unit.

NOTE

The unit can be turned on by pressing any other button except the eject  and DISP/TITLE  button.

The volume level gradually increases to the previous level you were listening to before the unit was turned off. Press and hold the **SOURCE/POWER** button for at least 3 seconds to turn off the unit.

NOTE

The first time power is turned on, the volume will start from level 12.

Basic Operation

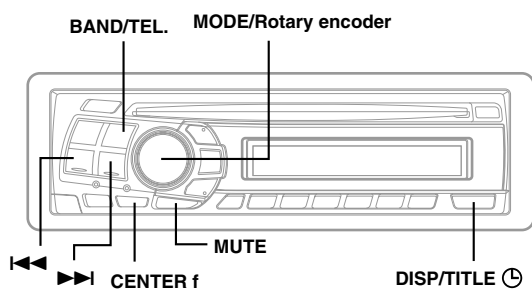

Adjusting Volume/Balance (Between Left and Right)/Fader (Between Front and Rear)/Defeat

- 1 Press the **MODE (Rotary encoder)** repeatedly to choose the desired mode.

Each press changes the modes as follows:

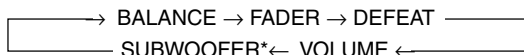

Volume : 0 ~ 35

Balance : L15 ~ R15

Fader: R15 ~ F15

Subwoofer: 0 ~ +15

NOTES

- If the **MODE (Rotary encoder)** is not pressed within 5 seconds after selecting the **BALANCE**, **FADER**, **DEFEAT** or **SUBWOOFER** mode, the unit automatically returns to the **VOLUME** mode.
- *When the subwoofer mode is **OFF**, its level cannot be adjusted.

- 2 Turn the **MODE (Rotary encoder)** until the desired sound is obtained in each mode.
By setting Defeat ON, previously adjusted settings of **BASS**, **TREBLE** will return to the factory defaults, but **MX** will be turned off.

NOTE

Depending on the connected devices, some functions and display indications do not work.

Audio Mute Function

Activating this function will instantly lower the volume level by 20 dB.

- 1 Press the **MUTE** button to activate the **MUTE** mode. The audio level will decrease by about 20 dB. Pressing the **MUTE** button again will bring the audio back to its previous level.

Displaying Time

- 1 Press the **DISP/TITLE** button repeatedly until the time is displayed.

Each press changes the modes as follows:

Radio mode

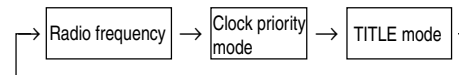

CD Player/Changer modes

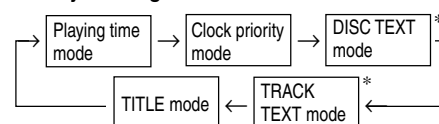

NOTES

- Selecting any tuner or CD function while in the clock priority mode will interrupt the time display momentarily. The function selected will be displayed for about 5 seconds before the time returns to the display.
- When the power is off but the ignition key is on, press the **DISP/TITLE** button to display the time.
- * For CDA-9805 model, the display above is shown with a CD-TEXT compatible changer connected.

Setting Time

- 1 In the Clock priority mode, press and hold the **DISP/TITLE** button for at least 3 seconds while the time is displayed. The time indication will blink.
- 2 Turn the **Rotary encoder** to adjust the hours while the time indication is blinking.
- 3 When the hour has been adjusted, press the **Rotary encoder**.
- 4 Turn the **Rotary encoder** to adjust the minutes while the time indication is blinking. The time is automatically set 5 seconds after the minute adjustment. The time can also be manually set by pressing the **Rotary encoder**.

Setting the Bass Control

You can change the Bass Frequency emphasis to create your own tonal preference.

- 1 Press the **CENTER f** button to select the BASS (bass Center frequency) control mode.

→ BASS → TREBLE → normal mode →

- 2-1 *Setting the Bass Center Frequency:
Press the **◀◀** or **▶▶** button to select the desired bass center frequency.

→ 60Hz ↔ 80Hz ↔ 100Hz ↔ 200Hz ←

Emphasizes the displayed bass frequency ranges.

- 2-2 *Setting the Bass Band width (Q-Factor):
Press the **BAND/TEL.** button to select the desired bass Band Width.

→ B. Width1 → B. Width2 → B. Width3 → B. Width4
(Narrow) ←.....→ (Wide)

Changes the bass boost band width to wide or narrow. A wide setting will boost a wide range of frequencies above and below the center frequency. A narrower setting will boost only frequencies near the center frequency.

- 2-3 Setting the bass Level:
Turn the **Rotary encoder** to select the desired bass level (-7~+7).
You can emphasize or weaken the bass frequency.

NOTES

- If no buttons are pressed within 15 seconds, the bass control setting will be turned off automatically.
 - The Bass Level settings will be individually memorized for each source (FM, AM, XM, CD, etc.) until the setting is changed. The Bass frequency and Bass Band Width settings adjusted for one source are effective for all other sources (FM, AM, XM, CD etc.).
 - Depending on the connected devices, some functions and display indications do not work. However, Bass Level is still adjustable if an audio processor with the Bass function is connected.
 - This function is inoperable when DEFEAT is ON.
- * Selecting any of the "Setting the Bass Types" (TYPE 1 through 3), temporarily replaces the custom settings you have made above.

Setting the Treble Control

You can change the Treble Frequency emphasis to create your own tonal preference.

- 1 Press the **CENTER f** button to select the TREBLE (treble Center frequency) control mode.

→ BASS → TREBLE → normal mode →

- 2-1 Setting the treble Center frequency:
Press **◀◀** or **▶▶** button to select the desired treble Center frequency.

→ 10.0kHz ↔ 12.5kHz ↔ 15.0kHz ↔ 17.5kHz ←

Emphasizes the displayed Treble frequency ranges.

- 2-2 Setting the treble Level:
Turn the **Rotary encoder** to select the desired Treble Level (-7~+7).
You can emphasize the treble frequency.

NOTES

- If no buttons are pressed within 15 seconds, the Treble control setting will be turned off automatically.
- The Treble Level settings will be individually memorized for each source (FM, AM, XM, CD, etc.) until the setting is changed. The Treble frequency settings adjusted for one source are effective for all other sources (FM, AM, XM, CD, etc.).
- Depending on the connected devices, some functions and display indications do not work. However, Treble Level is still adjustable if an audio processor with the Treble function is connected.
- This function is inoperable when DEFEAT is ON.

Setting the Bass Type

This function allows for 3 different Bass Type settings. Select the one that appeals to you the most.

- 1 Press and hold the **CENTER f** button for at least 2 seconds to set the Bass Type.
- 2 Select the desired Type (1 through 3) by pressing the **◀◀** or **▶▶** button within 15 seconds.
Type 1 will sound best if you have a subwoofer in your system. Use Type 2 or 3 if you are using small diameter speakers.
- 3 Press and hold the **CENTER f** button for at least 2 seconds to return to the normal mode.

NOTES

- "Bass Center Frequency" and "Bass Band width" previously set are replaced when selecting TYPE 1 through 3. When Bass Type is OFF, your previous settings are restored.
- Bass Type is not selectable when connected to an external audio processor.

Basic Operation

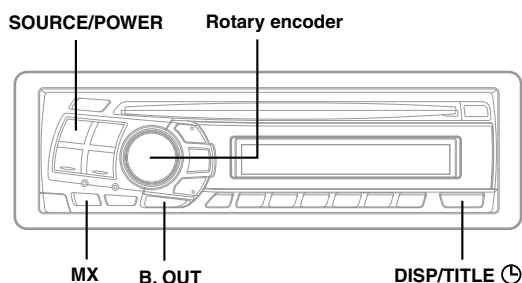

Setting the MX Mode

MX (Media Xpander) makes vocals or instruments sound distinct regardless of the music source. The radio, CD, and MP3, will be able to reproduce the music clearly even in cars with a lot of road noise.

- 1 Press the **MX** button to select MX ON.
- 2 Press the **SOURCE/POWER** button to select the source you want to MX (Media Xpander)-correct.
- 3 Press and hold the **MX** button for at least 2 seconds to select the MX mode.
- 4 Turn the **Rotary encoder** to select your preferred mode or OFF.

FM (MX level 1 to 3):

The medium to high frequencies become more clear, and produces well balanced sound in all the bands.

CD (MX level 1 to 3):

CD mode processes a large quantity of data. This data is used to reproduce the sound cleanly by making use of the data quantity.

MP3/WMA/XM (MX level 1 to 3):

This corrects information that was omitted at the time of compression. This reproduces a well-balanced sound close to the original.

DVD (or Video CD):

- (MOVIE MX level 1 to 2)

The dialog portion of the video is reproduced more clearly.

- (MUSIC MX level 1):

This disk contains a large quantity of data such as music clip. MX uses this data to reproduce the sound accurately.

AUX (MX level 1):

Choose the MX mode (MP3, MUSIC, or MOVIE) that corresponds to the media connected.

If two external devices are connected, the MX mode of each media can be selected.

- 5 After setting, press the **Rotary encoder** to return to the normal mode.

NOTES

- By "Setting the External Input Defeat Mode" (page 12) to ON, operation is bypassed.
- To cancel MX mode for all music sources, press the **MX** button to turn MX off.
- MX mode is automatically canceled if no buttons are pressed within 15 seconds.
- Each music source, such as radio, CD, and MP3 can have its own MX setting.
- On disks with both MP3 and CD-DA, when the source changes from "MP3 to CD-DA" or "CD-DA to MP3", the MX-mode switching process may delay playback slightly.
- Setting to MX OFF makes MX mode of each music source OFF.
- This function is inoperable when DEFEAT is ON.
- MX mode does not function when MX is ON for AM radio.
- If the unit is connected to an audio processor with the MX function, such as PXA-H700, etc., the MX processing can be applied to the audio processor. In this case the audio processor needs to be adjusted. For details, refer to the Owner's Manual of the audio processor.

Blackout Mode On and Off

When the Blackout mode is turned on, the display will turn off to reduce power consumption. This additional power enhances the sound quality.

- 1 Press and hold the **B.OUT** button for at least 3 seconds to start the blackout mode. By doing so the display will turn off.

NOTE

If any button on the unit is pressed during the blackout mode, the function will be displayed for 5 seconds to show the operation before returning to Blackout mode.

To cancel the blackout mode, press and hold the **B.OUT** button for at least 3 seconds.

Displaying the Title/Text

It is possible to display the CD/Station title if the title has been previously inputted. For details, see "Titling Disc/Stations" (page 10). Text information, such as the disc name and the track name, will be displayed if playing a CD text compatible disc. It is also possible to display the folder name, the file name, and the tag, etc. while playing MP3/WMA files.

- 1 Press the **DISP/TITLE**  button.
The mode will change every time the button is pressed.

About "Title" and "Text"

Title: With this device, it is possible to input the CD/Station name (refer to page 10). This inputted name is referred to as a "title."

You cannot input or display titles on MP3/WMA discs.

Text: Text compatible CDs contain text information such as the disc name and track name. Such text information is referred to as "text."

Radio mode:

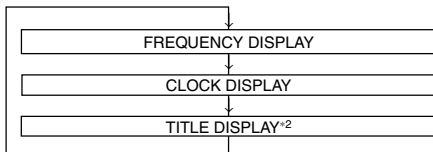

CD mode: (Text is displayed for the CDA-9805 model when a compatible changer with CD text is connected.)

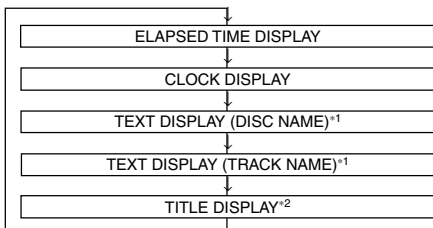

MP3/WMA mode: (MP3 files can be played back with the CDA-9805 model if an MP3 compatible changer is connected.)

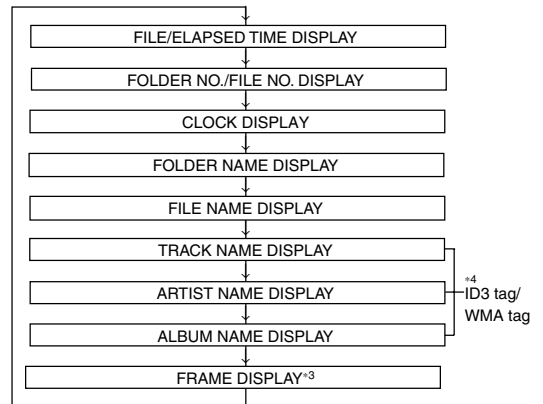

- *1 Displayed during playback of a disc with CD Text. "NO TEXT" will be displayed when the CD contains no Text data.
Text cannot be displayed for the CDA-9805 model.
- *2 If the title was not previously input, "NO TITLE" is displayed.
- *3 The recording sampling rate and bit rate of the MP3/WMA file are displayed.
- *4 If an MP3/WMA file contains ID3 tag/WMA tag information, all the ID3 tag/WMA tag information is displayed. (e.g., track name, artist name, and album name). All other tag data is ignored.
"NO DATA" will be displayed if an MP3/WMA file contains no ID3 tag/WMA tag information.

NOTES

- Some characters may not be displayed correctly with this device, depending on the character type.
- The CD changer must also be CD Text compatible for the Text information to be displayed.
- When the Scroll Setting (refer to page 11) is set to "SCR MANU", press and hold the **DISP/TITLE**  button for at least 3 seconds to scroll the Text information only once (TEXT DISPLAY, FOLDER NAME DISPLAY, FILE NAME DISPLAY or TAG DISPLAY mode).
- "NO SUPRT" is displayed when the desired text information cannot be displayed on this unit.

Basic Operation

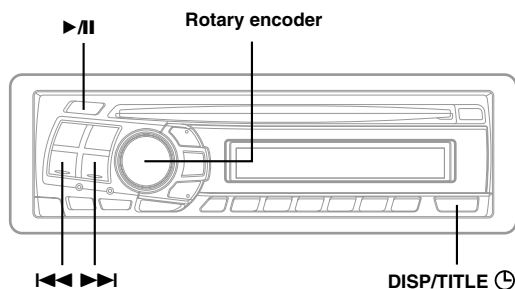

Titling Discs/Stations

It is possible to title your favorite CD's or radio stations. You cannot input titles on MP3/WMA discs.

- 1 Press the **DISP/TITLE** ⌚ button and select the title display mode.
For details, see "Displaying the Title/Text" (page 9).
- 2 Press and hold the **DISP/TITLE** ⌚ button for at least 3 seconds. The first character will blink.
- 3 Turn the **Rotary encoder** to select the desired letter/numeral/symbol available for naming.
- 4 Press the **Rotary encoder** to store the first character. The first character will stop blinking and the display will automatically advance to the next character. When that character begins to blink, you may choose the next letter or symbol of your title.
- 5 Repeat the steps 3 and 4 above to complete the titling. Pressing the **Rotary encoder** after entering the 8th character, automatically stores the title into memory.

When entering a title of less than 8 characters (for example, 3 character title):
After entering 3 characters to complete your title, the 4th character space will be blinking. Go to step 6 to complete the title.

- 6 Press the **DISP/TITLE** ⌚ button to record the title.

NOTES

- If you cancel while entering a title, selected characters are not written.
- You can enter 18 radio station titles and 18 CD titles on this unit. If you try to store beyond the limit, the display will show "FULL DATA." At this point, no more titles can be stored.
- The CD Changer title length or memory capacity varies depending upon the model being used.
- To input a new title, one of the previously inputted titles must first be deleted.
- When you want to erase a title, enter the "⏏" symbol into all spaces.
- The operations described in steps 3 to 5 must be made within 10 seconds. The input mode will be canceled if no action is taken for over 10 seconds.

Erasing Disc Title/Station Title

- 1 Press the **DISP/TITLE** ⌚ button to select the titling mode. Then, press and hold for at least 3 seconds.
- 2 Within 10 seconds press and hold the **▶/||** button for at least 2 seconds to activate the title scanning mode. The title in the display will blink.
- 3 Press the **◀◀** or **▶▶** button repeatedly until the title you want to erase is displayed.
- 4 Press and hold the **▶/||** button for at least 2 seconds to erase the title displayed.
- 5 Press the **DISP/TITLE** ⌚ button to cancel the title erasing mode.

NOTES

- You cannot erase CD-TEXT.
- "NO DATA" is displayed for 2 seconds if the title is not input in step 2, or if the title is erased in step 4.

SETUP Operation

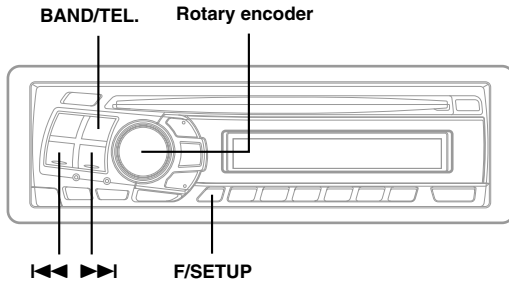

Scroll Setting

This CD player can scroll the disc and track names recorded on CD-TEXT discs, as well as the text information of MP3/WMA files, folder names, and tags. (This function can be used for CDA-9805 model if the changer compatible with CD-Text is connected).

- 1 Press and hold the **F/SETUP** button for at least 3 seconds.
- 2 Press the **▶▶** or **◀◀** button to select "SCR"(SCROLL).
- 3 Press the **BAND/TEL.** button to toggle the mode between SCR AUTO and MANU.
 - SCR AUTO: the CD text information, the text information of folder and file names, and the tags are scrolled automatically.
 - SCR MANU: the display is scrolled only when a disc is loaded or when a track is changed, etc.
- 4 When the setting is completed, press the **F/SETUP** button to return to the normal mode.

NOTES

- Initial mode is "SCR MANU."
- The unit scrolls CD text names, folder names, file names or tag display. The disc titles input manually (refer to page 10) cannot be scrolled.

Subwoofer On and Off

- 1 Press and hold the **F/SETUP** button for at least 3 seconds.
- 2 Press the **▶▶** or **◀◀** button to select "SUBW (Subwoofer)."
- 3 Press the **BAND/TEL.** button to toggle mode between SUBW ON and SUBW OFF.
- 4 Press the **F/SETUP** button after setting the SUBW ON.
- 5 Press the **Rotary encoder** repeatedly to select the SUBW mode.



- 6 Turn **Rotary encoder** until the desired sound is obtained in each mode.

NOTES

- "Playing MP3 data" in the "SETUP" mode section is described in *MP3 Operation* on page 21.
- Switching the incoming calls of the telephone in the *SETUP* mode section is described in "MobileHub™ Link Operation" on page 24.
- "Checking the XM Radio ID Number," "Setting the Tuning Method" and "Setting the Auxiliary Data Field Display" in the *SETUP* mode section are described in "XM Radio Operation" on page 22-23.
- "Changing the Radio Frequencies for each Country" in the *SETUP* mode section is described in "Radio Operation" on page 14.

SETUP Operation

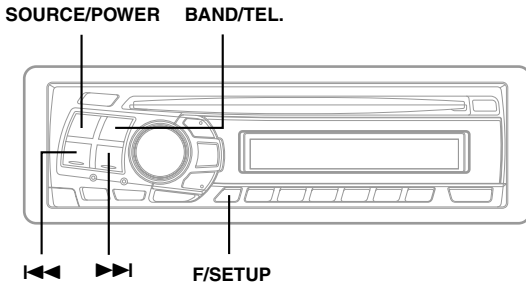

Turning Mute Mode On/Off

If a device having the interrupt feature is connected, audio will be automatically muted whenever the interrupt signal is received from the device. This function can be turned ON or OFF from the head unit by following procedure below.

- 1 Press and hold the **F/SETUP** button for at least 3 seconds.
- 2 Press the **▶▶** or **◀◀** button to select the MUTE mode.
- 3 Press the **BAND/TEL.** button to turn on or off the MUTE mode.
Each press toggles between the MUTE ON and OFF modes.
NOTE
The initial setting at the factory is "MUTE ON."
- 4 Press the **F/SETUP** button again to return to normal operation.

Setting the External Input Defeat Mode

When inputting external devices to this unit, turning DEFEAT ON will bypass BASS, TREBLE and MX, i.e., sound for external devices is output at the default setting.

- 1 Press and hold the **F/SETUP** button for at least 3 seconds.
- 2 Press the **▶▶** or **◀◀** button to select "INT."
- 3 Press the **BAND/TEL.** button to toggle the mode between INT ON and INT OFF.
When using Initial mode, set this to ON.
When the Initial mode is not selected, set this to OFF.
- 4 Press the **F/SETUP** button to return to normal mode.

Setting the AUX Mode (V-Link)

You can input TV/video sound by connecting an optional Ai-NET/RCA Interface cable (KCA-121B) or Versatile Link Terminal (KCA-410C) to this component.

- 1 Press and hold the **F/SETUP** button for at least 3 seconds.
- 2 Press the **▶▶** or **◀◀** button to select "AUX."
- 3 Press the **BAND/TEL.** button to toggle the mode between AUX ON and AUX OFF.
NOTES
 - The initial setting at the factory is AUX OFF.
 - You can set the AUX mode display by pressing the **◀◀** or **▶▶** button after AUX ON is set, select the AUX mode display setting, and then press the BAND button.
 - When connecting the KCA-410C, you can set two AUX mode displays.
- 4 Press the **F/SETUP** button to return to normal mode.
- 5 To adjust the volume, etc., first press the **SOURCE/POWER** button and select the AUX mode, then make the necessary adjustment.

NOTE

When using the Versatile Link Terminal (KCA-410C), you can connect two external inputs. To select the mode, press the **BAND/TEL.** button on the unit.

Connecting to an External Amplifier

When an external amplifier is connected and the built-in amplifier is not used, removing power from the built-in amplifier will improve the sound quality. The power to the internal amplifier is turned OFF by the following procedure.

- 1 Press and hold the **F/SETUP** button for at least 3 seconds.
- 2 Press the **▶▶** or **◀◀** button to select "PWR."
- 3 Press the **BAND/TEL.** button to toggle the mode between PWR ON and PWR OFF.

PWR OFF:

When activating the speakers, this setting can be performed by connecting between the front and rear pre-amplifier of the unit and the external amplifier. In this setting, nothing is output to the speakers.

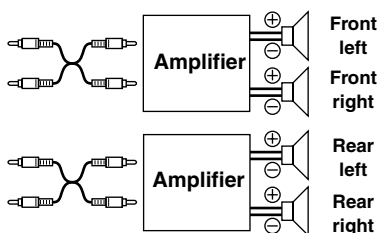

PWR ON:

The speakers are driven by the built-in amplifier.

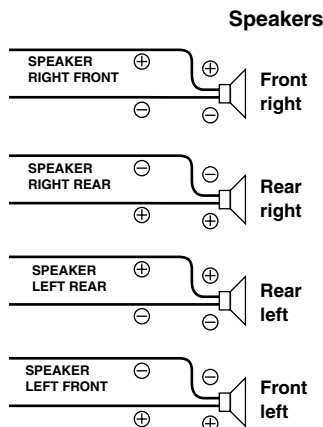

NOTE

No sound is produced by the system when the power output is set to OFF

- 4 Press the **F/SETUP** button to return to normal mode.

Radio Operation

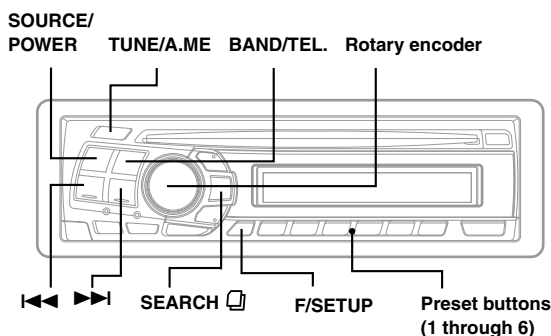

Changing the Radio Frequencies for each Country

For customers not living in North America, change the radio frequencies as follows.

- 1 Press and hold the **F/SETUP** button for at least 3 seconds.
- 2 Select the "AREA" mode by pressing the **◀◀** or **▶▶** button.
- 3 Choose either AREA 1 or AREA 2 by pressing the **BAND/TEL.** button.
 AREA 1: Radio frequencies for North America
 AREA 2: Other Radio frequencies

NOTE

The stored radio stations will be cleared every time you change the setting.

Manual Tuning

- 1 Press the **SOURCE/POWER** button until a radio frequency appears in the display.
- 2 Press the **BAND/TEL.** button repeatedly until the desired radio band is displayed.

Each press changes the band:

→ FM1 → FM2 → AM

- 3 Press the **TUNE/A.ME** button to select the tuning mode.

→ DX SEEK → DX SEEK → DX SEEK
 (Distance mode) (Local mode) (Manual mode)

(Only portions underlined on the display may be lit.)

Distance mode:

Both strong and weak stations will be automatically tuned in (Automatic seek tuning).

Local mode:

Only strong stations will be automatically tuned in (Automatic seek tuning).

Manual mode:

The frequency is manually tuned in steps (Manual tuning).

- 4 Press the **◀◀** or **▶▶** button to move downward or upward one step respectively until the desired station frequency is displayed.

NOTE

The **ST** indicator appears on the display when a Stereo FM station is tuned in.

Automatic Seek Tuning

- 1 Press the **BAND/TEL.** button repeatedly until the desired radio band is displayed.
- 2 Press the **TUNE/A.ME** button to select the tuning mode.
- 3 Press the **◀◀** or **▶▶** button to automatically seek for a station downward or upward respectively. The unit will stop at the next station it finds. Press the same button again to seek the next station.

Manual Storing of Station Presets

- 1 Select the radio band and tune in a desired radio station you wish to store in the preset memory.
- 2 Press and hold any one of the **Preset buttons (1 through 6)** that you want to store the station on for at least 2 seconds. The selected station is stored. The display shows the band, preset No. and station frequency memorized.
- 3 Repeat the procedure to store up to 5 other stations onto the same band. To use this procedure for other bands, simply select the band desired and repeat the procedure. A total of 18 stations can be stored in the preset memory (6 stations for each band; FM1, FM2 and AM).

NOTE

If you store a station in a preset memory which already has a station, the current station will be cleared and replaced with the new station.

Automatic Memory of Station Presets

- 1 Press the **BAND/TEL.** button repeatedly until the desired radio band is displayed.
- 2 Press and hold the **TUNE/A. ME** button for at least 2 seconds.
The frequency on the display continues to change while the automatic memory is in progress. The tuner will automatically seek and store 6 strong stations in the selected band. They will be stored into buttons 1 to 6 in order of signal strength.
When the automatic memory has been completed, the tuner goes to the station stored in the preset location No. 1.

NOTE

If no stations are stored, the tuner will return to the original station you were listening to before the auto memory procedure began.

Tuning to Preset Stations

- 1 Press the **BAND/TEL.** button repeatedly until the desired band is displayed.
- 2 Press the station **Preset** button that has your desired radio station in memory.
The display shows the band, preset number and frequency of the station selected.

Station Title Search Function

If titles for radio stations are entered, you can search for a radio station from its title.

- 1 Press the **SEARCH**  button in Radio mode to switch to Title Search mode.
The first title input blinks in the display.
- 2 Select the desired title by turning the **Rotary encoder** within 10 seconds.
- 3 Press the **Rotary encoder** to receive the frequency of the selected title.

NOTE

*Search mode in Title Search mode is canceled by pressing and holding the **SEARCH**  button for at least 2 seconds.*

Quick Search Function

You can search for radio stations by their frequencies.

- 1 Press and hold the **SEARCH**  button for at least 2 seconds in Radio mode to activate Frequency Search mode.
- 2 Select the desired frequency by turning the **Rotary encoder** within 10 seconds.
- 3 Press the **Rotary encoder** to receive the selected frequency.

NOTE

*Search mode in Quick Search mode is canceled by pressing and holding the **SEARCH**  button for at least 2 seconds.*

CD Player Operation

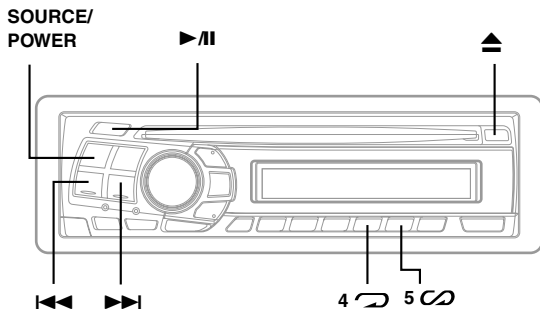

Inserting/Ejecting Disc

- 1 Insert a CD half way into the slot with the label side facing up. The player automatically draws the disc into the disc compartment.

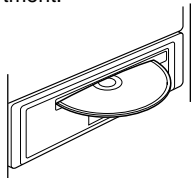

The Disc indicator appears to show that a disc is loaded.

NOTE

Three-inch (8cm) CD's can be used.

- 2 Press the ▲(Eject) button when you want to eject the CD.

NOTES

- If the CD is not removed for several seconds after it has been ejected, the player automatically draws the CD into the compartment to protect the CD.
- Do not insert or remove a CD forcibly when loading or ejecting a CD, as malfunction may result.

Normal Play and Pause

- 1 Insert a CD. The CD player begins playback from the first track on the disc.

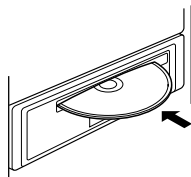

The display shows the track number and elapsed time of the track being played. When the last track is played back the player returns to the first track.

If a CD is already loaded in the CD player, press the **SOURCE/POWER** button to select the CD mode.

- 2 Press the ▶/|| button to temporarily stop CD playback. To resume playback, press the ▶/|| button again.

About discs that can be used with the CDA-9807 model.

Use only compact discs with the label side showing the CD logo marks below.



If you use unspecified compact discs, correct performance cannot be guaranteed.

You can play CD-Rs (CD-Recordable)/CD-RWs (CD-ReWritable) which have been recorded only on audio devices. You can also play CD-Rs/CD-RWs containing MP3/WMA formatted audio files.

- Some of the following CDs may not play on this unit: Flawed CDs, CDs with fingerprints, CDs exposed to extreme temperatures or sunlight (e.g., left in the car or this unit), CDs recorded under unstable conditions, CDs on which a recording failed or a re-recording was attempted, copy-protected CDs which do not conform to the audio CD industry standard.
- Use discs with MP3/WMA files written in a format compatible with this unit. For details, see page 28-29.

About discs that can be used with the CDA-9805 model.

Use only compact discs with the label side showing the CD logo marks below.



If you use unspecified compact discs, correct performance cannot be guaranteed.

You can play CD-Rs (CD-Recordable)/CD-RWs (CD-ReWritable) which have been recorded only on audio devices. You can not play CD-Rs/CD-RWs containing MP3 formatted audio files.

- Some of the following CDs may not play on this unit: Flawed CDs, CDs with fingerprints, CDs exposed to extreme temperatures or sunlight (e.g., left in the car or this unit), CDs recorded under unstable conditions, CDs not designed for audio use, CDs on which a recording failed or a re-recording was attempted.

On handling Compact Discs (CD/CD-R/CD-RW)

- Do not touch the surface.
- Do not expose the disc to direct sunlight.
- Do not affix stickers or labels and do not write on the surface.
- Clean the disc when it is dusty.
- Make sure that there are no bumps around the disc.
- Do not use commercially available disc accessories.

Do not leave the disc in the car or the unit for a long time. Never expose the disc to direct sunlight. Heat and humidity may damage the CD and you may not be able to play it again.

To customers using CD-R/CD-RW

- If a CD-R/CD-RW cannot be played back, make sure close session (finalization) has been performed.
- Finalize the CD-R/CD-RW if necessary, and attempt playback again.

Music Sensor (Skip)

- 1 Momentarily press the **⏮** button once during CD play to return to the beginning of the current track. If you wish to access the beginning of a track further back, repeatedly press until you reach the desired track.

Press the **⏭** button once to advance to the beginning of the next track. If you wish to access the beginning of a track further ahead, press repeatedly until the desired track is reached.

NOTE

The music sensor feature is functional in the play or pause mode.

Fast Forward and Backward

- 1 Press and hold the **⏮** or **⏭** button to quickly move backward or forward until you reach the desired section of the track.

Repeat Play

- 1 Press the **4** (**↺**) button to play back repeatedly the track being played.
The track will be played repeatedly.

Press the **4** (**↺**) button again and select OFF to deactivate the repeat play.

NOTES

- If a CD Changer is connected and the Repeat ALL mode is selected, the unit repeatedly plays back all tracks on the disc selected.
If REPEAT is set to ON during M.I.X. play, M.I.X. will apply to the current disc only.

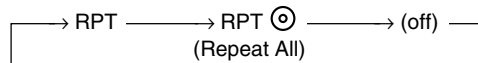

- In case a 6-disc CD changer is connected:
In CD changer mode, press the "F/SETUP" button to illuminate the underlined portion of the FUNC indicator, and go to step 1 within 5 seconds.
- In case a 12-disc CD changer is connected:
In CD changer mode, press the "F/SETUP" button to illuminate the underlined portion of the FUNC indicator, and go to step 1 within 5 seconds.

M.I.X. (Random Play)

- 1 Press the **5** (**∞**) button in the play or pause mode.
The tracks on the disc will be played back in a random sequence.

To cancel M.I.X. play, press the **5** (**∞**) button again to turn off the M.I.X.

NOTES

- If a CD Changer equipped with the All M.I.X. function is connected, All M.I.X. will also be selectable.
In this mode, the tracks on all the CDs in the current magazine will be included in the random playback sequence.
If M.I.X. is set to ON during REPEAT ALL play, M.I.X. will apply to the current disc only.

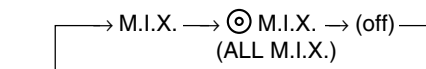

- In case a 6-disc CD changer is connected:
In CD changer mode, press the "F/SETUP" button to illuminate the underlined portion of the FUNC indicator, and go to step 1 within 5 seconds.
- In case a 12-disc CD changer is connected:
In CD changer mode, press the "F/SETUP" button to illuminate the underlined portion of the FUNC indicator, and go to step 1 within 5 seconds.
- A disc that contains more than 40 tracks may not be correctly played back with the M.I.X. function.

CD Player Operation

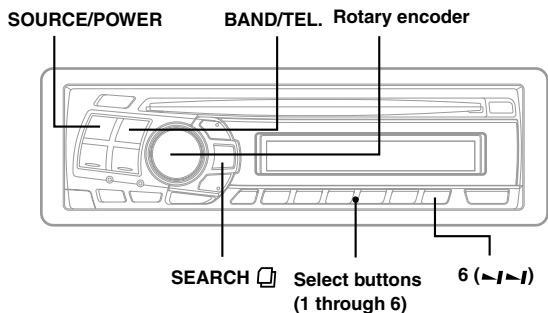

Scanning Programs

- 1 Press the **6** (↔) button to activate the Scan mode. The first 10 seconds of each track will be played back in succession.

To stop scanning, press the **6** (↔) button and deactivate the Scan mode.

NOTES

- In case a 6-disc CD changer is connected:
In CD changer mode, press the "F/SETUP" button to illuminate the underlined portion of the FUNC indicator, and go to step 1 within 5 seconds.
- In case a 12-disc CD changer is connected:
In CD changer mode, press the "F/SETUP" button to illuminate the underlined portion of the FUNC indicator, and go to step 1 within 5 seconds.

Track Search Function

While you are currently playing back and listening to a CD text compatible disc, you can search for tracks from its text to select the next track. For a non-CD text disc, you can search by track.

- 1 Press the **SEARCH** (□) button in the CD/Changer mode to activate Track Search mode.
- 2 Select a desired track by turning the **Rotary encoder** within 10 seconds.
- 3 Press the **Rotary encoder** to play back the selected track.

NOTES

- Search mode in Track Search mode is canceled by pressing and holding the **SEARCH** (□) button for at least 2 seconds.
- In changer mode, a track can be searched from the currently playing disc by CD text or track.

Quick Search Function

You can search for tracks.

- 1 Press and hold the **SEARCH** (□) button for at least 2 seconds in the CD/Changer mode to activate Quick Search mode.
- 2 Select a desired track by turning the **Rotary encoder** within 10 seconds. The selected track is played back.

NOTE

Search mode is canceled by pressing and holding the **SEARCH** (□) button for at least 2 seconds in Quick Search mode.

Controlling CD Changer (Optional)

An optional 6-disc or 12-disc CD Changer may be connected to the CDA-9807/CDA-9805 if it is Ai-NET compatible. With a CD Changer connected to the Ai-NET input of the CDA-9807/CDA-9805, the CD Changer will be controllable from the CDA-9807/CDA-9805. Using the KCA-400C (Multi-Changer Switching device) or the KCA-410C (Versatile Link Terminal) multiple changers can be controlled by the CDA-9807/CDA-9805. See the Multi-Changer Selection section on page 19 for selecting the CD Changers.

NOTES

- The controls on the CDA-9807/CDA-9805 for CD Changer operation are operative only when a CD Changer is connected.
- The DVD changer (optional) is controllable from the CDA-9807/CDA-9805 as well as the CD changer.

- 1 Press the **SOURCE/POWER** button to activate the CHANGER mode. The display shows the disc number and track number.

NOTES

- The source indicator varies depending on the connected source.
- Press the **BAND/TEL.** button to switch the Disc mode in the CD/Changer mode.

- 2 Press the **Disc Select buttons (1 through 6)** corresponding to one of the discs loaded in the CD Changer. The selected disc number appears in the display and CD playback starts.

NOTES

- After selecting the desired disc, you can operate in the same way as for the CDA-9807/CDA-9805 CD player. For details, please see the CD Operation section.
- If the underlined portion of the "FUNC" indicator is illuminated, the Disc Select buttons become nonfunctional.

When a 12-disc CD Changer is connected:

To select discs numbered from 1 to 6, the procedure is the same as for the 6-disc CD Changer. To select discs numbered from 7 to 12, first press the "F" button. This changes the "D" indicator to "d." Then press the desired Preset button. With the "F" button activated, the Preset buttons 1 to 6 will represent discs 7 to 12 respectively.

- 3 The CD Changer Selection mode remains active for 8 seconds after step 2 is performed. Press the **BAND/TEL.** button until the desired CD Changer indicator appears on the display.

NOTE

If the selected CD Changer is not connected, the display will show "NO CHGR."

Alternatively press the **BAND** button on the Remote Control until the desired changer indicator appears on the display.

- 4 To operate the selected changer, see "CD Player Operation" section.

NOTE

For further details about the external input (AUX) when using KCA-410C, see "Setting the AUX Mode (V-Link)" on page 12.

Multi-Changer Selection

Alpine's Ai-NET system will support up to 6 CD Changers. When operating two or more changers, the KCA-400C (Multi-Changer Switching device) must be used. If you use 1 Switching device, you can connect up to 4 CD Changers. If you use 2 Switching devices, you can connect up to 6 CD Changers. When using KCA-410C (Versatile Link Terminal), you can connect two changers and two external outputs (AUX).

- 1 Press the **SOURCE/POWER** button on the CDA-9807/CDA-9805 to activate the CD Changer mode.

Alternatively, press the **SOURCE** button on the Remote Control (CDA-9807 only) to activate the CD Changer mode.

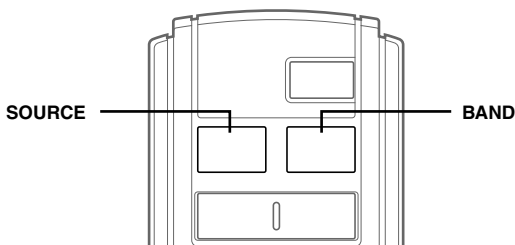

- 2 Press the **BAND** button on the CDA-9807/CDA-9805 or the RUE-4187 to activate the CD Changer Selection mode.

MP3/WMA Operation

Playing MP3 Files with the CD Changer (Optional)

If you connect a changer compatible with MP3, you can play CD-ROMs, CD-Rs, and CD-RWs containing MP3 files on the CDA-9807/CDA-9805.

- 1 Press the **SOURCE/POWER** button to switch to the MP3 Changer mode.
- 2 Press the Disc **Select buttons (1 through 6)** corresponding to one of the discs loaded in the CD Changer.
- 3 To pause playback, press the **▶/||** button. Pressing the **▶/||** button again will resume playback.

NOTE

The unit can play discs containing both audio data and MP3 data.

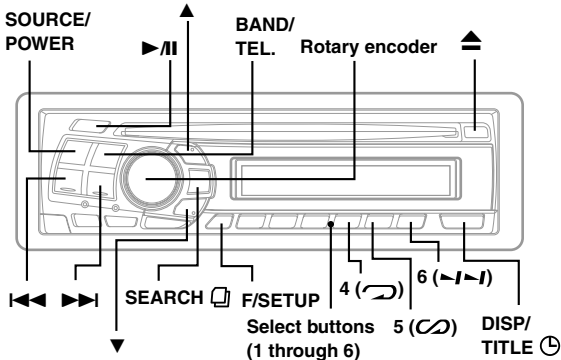

Playing MP3/WMA Files (CDA-9807 only)

The CDA-9807 model includes a built-in MP3/WMA decoder. You can play CD-ROMs, CD-Rs, and CD-RWs containing MP3/WMA files on this decoder. Use a format compatible with this unit.

For further information about playing or storing MP3/WMA files, refer to pages 28-29 before using the decoder.

- 1 Insert a disc containing an MP3 or WMA file with the label side facing up. The disc will be pulled into the unit automatically.

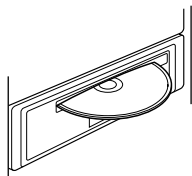

When a disc is already inserted, press the **SOURCE/POWER** button to switch to the CD mode.

The mode will change every time the button is pressed.

→ TUNER → CD → CD CHANGER* →

(* Only when the CD changer is connected)

- 2 To pause playback, press the **▶/||** button. Pressing the **▶/||** button again will resume playback.
- 3 To eject the disc, press the **▲** button.

NOTES

- The unit can play discs containing both audio data and MP3 data.
- The MP3 indicator is lit during MP3 playback.
- The WMA indicator is lit during WMA playback.
- The track display for CD audio data playback is the track numbers recorded on the disc.

Music Sensor (Skip)

- 1 Momentarily press the **◀◀** button once during CD play to return to the beginning of the current file. If you wish to access the beginning of a file further back, repeatedly press until you reach the desired file.

Press the **▶▶** button once to advance to the beginning of the next file. If you wish to access the beginning of a file further ahead, press repeatedly until the desired file is reached.

NOTE

The music sensor feature is functional in the play or pause mode.

Fast Forward and Backward

- 1 Press and hold the **◀◀** or **▶▶** button to quickly move backward or forward until you reach the desired section of the file.

Repeat Play

- 1 Press the **4 (↺)** button to play back repeatedly the file being played.

Press the **4 (↺)** button again and select OFF to deactivate the repeat play.

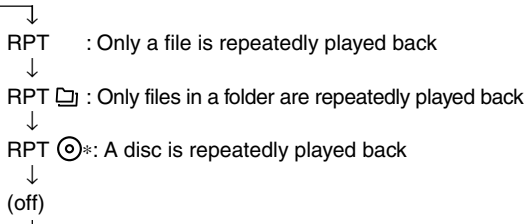

* When an MP3 compatible CD changer with Repeat All function is connected

NOTE

If an MP3 compatible CD changer is connected:
In CD changer mode, press the "F/SETUP" button to illuminate the underlined portion of the FUNC indicator, and go to step 1 within 5 seconds.

M.I.X. (Random Play)

- 1 Press the **5** (∞) button in the play or pause mode. The files on the disc will be played back in a random sequence.

To cancel M.I.X. play, press the **5** (∞) button again to turn off the M.I.X.

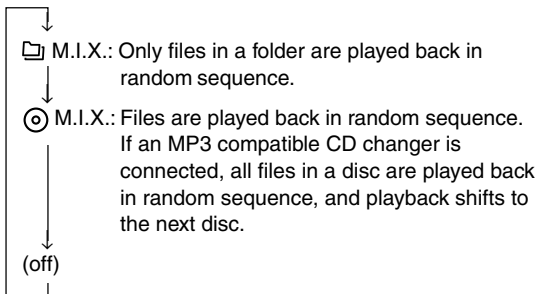

NOTE

In case an MP3 compatible CD changer is connected:
In CD changer mode, press the "F/SETUP" button to illuminate the underlined portion of the FUNC indicator, and go to step 1 within 5 seconds.

Scanning files

- 1 Press the **6** (↔) button to activate the Scan mode. The first 10 seconds of each file will be played back in succession.

To stop scanning, press the **6** (↔) button and deactivate the Scan mode.

NOTE

If an MP3 compatible CD changer is connected:
In CD changer mode, press the "F/SETUP" button to illuminate the underlined portion of the FUNC indicator, and go to step 1 within 5 seconds.

Folder/File Search Function

- 1 When setting MP3/WMA mode, press the **SEARCH** button to select between Folder Search mode or File Search mode.

File Search mode:

- 2 Press the **▲** or **▼** button to select another Folder.
- 3 Select the desired file by turning the **Rotary encoder** within 10 seconds.
- 4 Press the **Rotary encoder** to play back the selected file.

NOTES

- File Search mode is canceled by pressing and holding the **SEARCH** button for at least 2 seconds.
- While in File Search mode, press the **SEARCH** button to change back to Folder Search mode.

Folder Search mode:

(You can search for your desired folder in the disc.)

- 2 Select the desired folder by turning the **Rotary encoder** within 10 seconds.
- 3 Press the **Rotary encoder** to play back the first file in the selected folder.

NOTES

- Search mode is canceled by pressing and holding the **SEARCH** button for at least 2 seconds in Folder Search mode.
- While in Folder Search mode, press the **SEARCH** button to switch to File Search mode.
- "NO FILE" is displayed for 2 seconds if the folder that is selected by the Folder Search mode contains no files.

Quick Search Function

You can search for all Files.

- 1 Press and hold the **SEARCH** button for at least 2 seconds in MP3/WMA mode to activate Quick Search mode.
- 2 Select the desired File by turning the **Rotary encoder** within 10 seconds. The selected file is played back immediately.

Playing MP3 Data

You can select either playback only of CD data, or playback of formatted CD data and MP3 files. When a disc contains CD or the MP3 file data, playback starts from the CD data portion of the disc.

- 1 Press and hold the **F/SETUP** button for at least 3 seconds.
- 2 Press the **▶▶** or **◀◀** button to select "CD-DA/MP3."
- 3 Press the **BAND/TEL.** button to toggle the mode between CD-DA and CD/MP3.
 - CD-DA: Only CD data can be played back.
 - CD/MP3: Both CD data and MP3 file tracks can be played back.

- 4 Press the **F/SETUP** button to return to normal mode.

NOTE

Perform this setting before inserting a disc. If a disc has already been inserted, perform the setting after you remove the disc. (If you use an MP3 changer, you have to change discs)

XM Radio Operation (Optional)

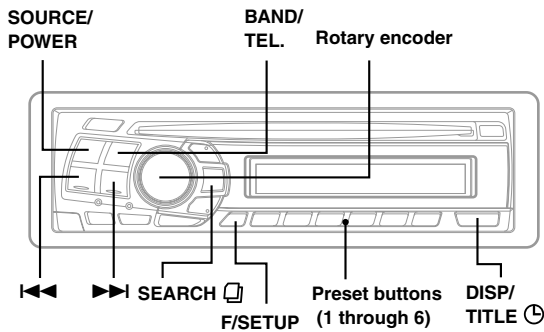

Receiving XM Channels with the XM Receiver (Optional)

XM Satellite Radio* is the next generation of audio entertainment, with up to 100 brand-new digital channels. For a small monthly fee, subscribers can hear crystal-clear music, sports, news and talk, coast-to-coast via satellite. For more information, visit XM's website at www.xmradio.com or call 1-800-852-9696.

An optional XM Satellite Radio Receiver (TUA-T021XM) and an optional XM Antenna may be connected to the CDA-9807/CDA-9805. With an XM Receiver connected to the Ai-NET input of the CDA-9807/CDA-9805, the XM Receiver will be controllable from the CDA-9807/CDA-9805.

* XM and its corresponding logos are trademarks of XM Satellite Radio Inc.

NOTES

- The controls on the CDA-9807/CDA-9805 for XM Receiver operation are operative only when an XM Receiver is connected.
- The XM1, XM2 or XM3 band illuminates when in XM mode.

- 1 Press the **SOURCE/POWER** button to select XM Mode.
- 2 Press the **BAND/TEL.** button to select XM1, XM2 or XM3.
- 3 Press the **◀◀** or **▶▶** button to select the desired channel. Holding the **◀◀** or **▶▶** buttons will change channels continuously.

Checking the XM Radio ID Number

You need to provide XM with the unique XM Radio ID number for your XM Radio Receiver in order to subscribe to XM's programming.

This number is an 8 character alphanumeric number that is printed on a label directly on the XM Receiver. It can also be displayed on the screen of the CDA-9807/CDA-9805 in the following way.

- 1 While receiving XM1/XM2/XM3, press the **◀◀** or **▶▶** button to select channel "0."
- 2 The unit alternately displays "RADIO ID" for 2 seconds, then the ID number for 10 seconds.
- 3 To cancel the ID number display, set the channel to other than "0."

Tips

There is another way to display your ID number.

1. Press and hold the **F/SETUP** button for at least 3 seconds.
2. Press the **▶▶** or **◀◀** button repeatedly to select "ID."
3. Press the **BAND/TEL.** button to display your ID number.
4. After checking your ID number, press the **F/SETUP** button to return to the normal display.

NOTES

- You cannot use "O," "S," "I," or "F" for the ID Number.
- You can check your ID number printed on the label on the package of your XM Satellite Radio Receiver (TUA-T021XM).

Storing XM Channel Presets

- 1 Press the **BAND/TEL.** button to select the desired band (XM1, XM2 or XM3) you want to store.
- 2 After tuning in the desired channel, press and hold any one of the **Preset buttons (1 through 6)** that you want to store the station on for at least 2 seconds. The selected station is stored.
- 3 Repeat the procedure to store up to 5 other channels onto the same band.
To use this procedure for other bands, simply select the band desired and repeat the procedure.
A total of 18 channels can be stored in the preset memory (6 channels for each band; XM1, XM2 and XM3).

NOTE

If you store a channel in a preset memory which already has a station, the current channel will be cleared and replaced with the new one.

Receiving Stored XM Channels



- 1 Press the **BAND/TEL.** button to select the desired band (XM1, XM2 or XM3).
- 2 Press the channel **Preset** button that has your desired satellite channel in memory.

Channel/Category Search Function

You can search for programs by Channel No. or Category.

- 1 Press the **SEARCH**  button in the XM mode to select Channel Search mode or Category Search mode.
- Channel Search mode:**
- 2 Select the desired Channel No.* by turning the **Rotary encoder** within 10 seconds.
* The Channel No. is selected from within the selected Category.
 - 3 Press the **Rotary encoder** to display the selected Channel No.



NOTES

- Search mode is canceled by pressing and holding the **SEARCH**  button for at least 2 seconds in Channel Search mode.
- While in Channel Search mode, press the **SEARCH**  button to change to the Category display. Press the **▲** or **▼** button to select the another Category.

Category Search mode:

- 2 Select the desired Category by turning the **Rotary encoder** within 10 seconds.
- 3 Press the **Rotary encoder** to display the selected Category.

NOTES

- Search mode is canceled by pressing and holding the **SEARCH**  button for at least 2 seconds in Category Search mode.
- When displaying Category, press the **SEARCH**  button to change to Channel Search mode.

Quick Search Function

You can search for all Channels.

- 1 Press and hold the **SEARCH**  button for at least 2 seconds in XM mode to activate Quick Search mode.
- 2 Select the desired Channel by turning the **Rotary encoder** within 10 seconds. The selected Channel is received.

Changing the Display

Text information, such as the channel name, artist name/feature, and song/program title, is available with each XM channel. The unit can display this text information as explained below.

- 1 In XM mode, press the **DISP/TITLE**  button. Each time you press this button, the display changes as shown below.

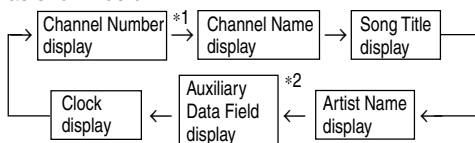

*1 The Channel Name display automatically changes after 5 seconds.

*2 When ADF is turned OFF, this information is not displayed (see "Setting the Auxiliary Data Field Display" section on page 23).

NOTES

- When the "Scroll Setting" (refer to page 11) is set to "SCR AUTO", the display scrolls continuously. When the Scroll Setting is set to "SCR MANU", the display scrolls only once after any function is performed (PRESET, BAND, SEARCH, etc.).
Press and hold the **DISP/TITLE**  button for more than 3 seconds to scroll the display manually.
- "Channel Number" and "Clock" displays do not scroll.
- Depending on the model, the display may differ from the one shown above.

Setting the tuning method

You can set the tuning method. You can select the received stations in Channel No. order or in Channel Name order (alphabetic order).

- 1 Press and hold the **F/SETUP** button for at least 3 seconds.
- 2 Press the **◀◀** or **▶▶** button to choose between "CH NO" or "ALPHABET."
- 3 Press the **BAND/TEL.** button to set the tuning method.
CH NO. : Set in order of channel no.
When the setting is completed, switch the channel UP/DOWN by pressing the **▶▶** or **◀◀** button.
ALPHABET : Set in alphabetic order.
When the setting is completed, switch the channel UP/DOWN by pressing the **▶▶** or **◀◀** button.
- 4 Press the **F/SETUP** button to return to normal mode.

Setting the Auxiliary Data Field Display

The XM Auxiliary Data Field display can be switched ON or OFF.

- 1 Press and hold the **F/SETUP** button for at least 3 seconds.
- 2 Select "ADF" (Auxiliary Data Field) by pressing the **◀◀** or **▶▶** button.
- 3 Select ON/OFF by pressing the **BAND/TEL.** button. When setting to ON, Auxiliary Data Field is displayed by pressing the **DISP/TITLE**  button. (Refer to the "Changing the Display" section on page 23.)
- 4 Press the **F/SETUP** button to return to normal mode.

MobileHub™ Link Operation (Optional)

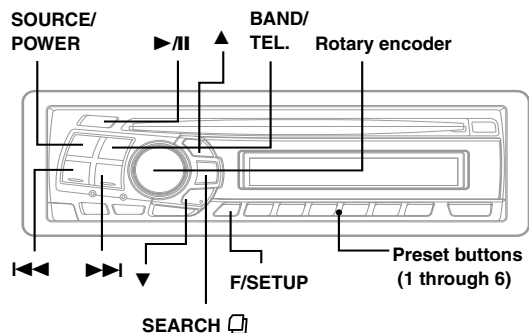

- An outgoing call from a portable telephone is also possible. However, you cannot perform different operations at the same time from a portable telephone and CDA-9807/CDA-9805 as malfunction can result.
- With a Junction BOX connected outgoing, incoming, and sending history will also be recorded in the portable telephone.
- While telephoning, DEFEAT is also set to ON. When the call has finished, the unit returns to the setting which you previously set.
- The telephone volume can be adjusted from the CDA-9807/CDA-9805. The volume you set during the call is memorized, and is automatically applied again on the next call.
- While telephoning or receiving incoming calls, press the DISP/TITLE button to indicate the Network Operator display for 5 seconds.

About MobileHub™ Link

Connect a separately sold Junction Box and a portable telephone (available from Nokia) to control the incoming and outgoing calls of the portable telephone.

CAUTION

- Even with hands-free operation, a driver can be distracted during telephone operation or receiving a call. For the sake of safety, drivers are requested to refrain from operating the telephone while driving.
- For the sake of safety, operations other than incoming calls and Speed-Dial outgoing calls cannot be used.

NOTES

- If a portable telephone is connected, its address book, incoming and outgoing history are downloaded to the Junction Box.
- Please refer to the instruction manual of the Junction BOX.

Telephone Mode ON/OFF

- 1 Press and hold the **BAND/TEL.** button for at least 2 seconds to turn ON Telephone mode.
To turn OFF, press the **BAND/TEL.** button.
See relevant pages for each item.

NOTES

- When a portable telephone is not connected, press and hold the **BAND/TEL.** button for at least 2 seconds. "NO PHONE" is displayed for about 2 seconds, then the mode returns to the original source mode
- When the portable telephone is taken off the Junction BOX during an incoming or outgoing call, or during a hands-free call, the call will be treated as an ordinary one by the portable telephone.
- When there is an incoming call while the power of CDA-9807/CDA-9805 is OFF, the power of CDA-9807/CDA-9805 will turn ON automatically for a hands-free call.
- Even if the power of the portable telephone is OFF, when CDA-9807/CDA-9805 is set to the telephone mode, the power of the portable telephone will be turned ON.
- Even if the ACC power of the vehicle is turned OFF (even if the engine is stopped) during a hands-free call, the call is not disconnected, and an ordinary call by the portable telephone is possible.
- If there is an incoming call during operation (except an outgoing call or talking), operation mode will end and switch to the incoming or talking mode.

Incoming Calls

- 1 Press the **▶/||** button to receive an incoming call.
- 2 Press the **BAND/TEL.** button or press the **SOURCE/POWER** button to finish a call.
The telephone mode will end and return to the original source mode.

NOTES

- When the Automatic Calling mode is on, you can talk after 3 seconds of receiving the incoming call.
- The incoming call can be switched to Automatic Calling or Manual Calling.
 1. Press and hold the F/SETUP button for at least 3 seconds.
 2. Select the TEL mode by pressing the **◀◀** or **▶▶** button.
 3. Press the **BAND/TEL.** button to change to TEL AUTO or TEL MANU.
 4. Press the F/SETUP button to return to normal mode.
- Press the **BAND/TEL.** or **SOURCE/POWER** button during an incoming call to disconnect it.

Calling

■ Calling by the address book

You can call up the address book registered in the portable telephone to call from.

- 1 Press and hold the **BAND/TEL.** button for at least 2 seconds.
- 2 Press the **SEARCH**  button to select the PHONE BK (Phone Book) mode.
A list in alphabetic order is displayed.

(Retrieving an addressee by Alphabetic Sort List to place a call)

- 1 When displaying the Alphabetic Sort List, select the addressee by turning the **Rotary encoder** or pressing the **◀◀** or **▶▶** button, then place a call by pressing the **▶/||** button or **Rotary encoder**.
- 2 Press the **BAND/TEL.** button to end the call.
The telephone mode will end and return to the original source mode.

(Retrieving an addressee by Selecting Search (A-Z search) to place a call).

- 1 Select an initial letter (A to Z) of the addressee by pressing the **▲** or **▼** button.
- 2 Select the addressee by turning the **Rotary encoder** and place a call by pressing the **Rotary encoder**.
- 3 Press the **BAND/TEL.** button to end the call.
The telephone mode will end and return to the original source mode.

■ Calling by using the Speed Dial

You can place a call by retrieving one of the telephone numbers registered in No. 1 to 9 of the address book.

- 1 Press and hold the **BAND/TEL.** button for at least 2 seconds.
- 2 Place a call by pressing within 5 seconds the **preset buttons (1 through 6)** you want to use for at least 2 seconds.
By pressing the **F/SETUP** button, and then pressing the **preset button (1 through 3)** for at least 2 seconds, you can place a call to the number registered in 7 to 9.

NOTES

- You can place a call by pressing the **▶/||** button after momentarily pressing the preset button (1 through 6) of the number you wish to call.
- You can place a call by pressing the **Rotary encoder**, after selecting a number which you wish to call, by pressing the **◀◀** or **▶▶** button or by turning the **Rotary encoder**.

- 3 Press the **BAND/TEL.** button to end the call.
The telephone mode will end and return to the original source mode.

■ Calling by the outgoing/incoming/absent incoming history

You can place a call to any of the last 999 calls by the outgoing/incoming/absent incoming history.

- 1 Set the history mode by pressing the **SEARCH**  button in PHONE BK (Phone Book) mode.
- 2 Select "DIALED" (outgoing history), "RECEIVED" (incoming history) or "MISSED" (absent incoming history) by pressing the **▲** or **▼** button.
- 3 When the addressee has been selected by turning the **Rotary encoder**, or pressing the **◀◀** or **▶▶** button from the outgoing or incoming history, place a call by pressing the **▶/||** button or the **Rotary encoder**.
- 4 Press the **BAND/TEL.** button to end the call. The telephone mode will end and return to the original source mode.

NOTE

"NO MEM" is displayed if there is no incoming history.

SMS (Short Message Service) Operation

You can be informed when you receive a short message.

■ Receiving a short message

- 1 When a text message is received, "NEW MSG" is indicated on the display.
The contents of the received message can only be read from the portable phone's display.
- 2 Press the **BAND/TEL.** button to return to the original source mode.

Remote Control Operation

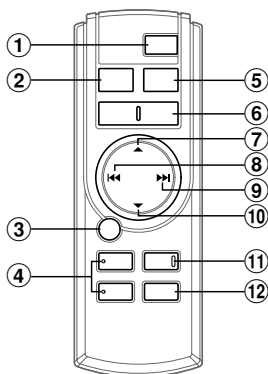

Controls on Remote Control (CDA-9807 only)

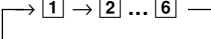
- ① **Power Button**
Press the button to turn the power on/off.
- ② **Source Button**
Press to select the audio source.
- ③ **▶/|| Button**
Press the button to switch between the Play and Pause modes for CD.
- ④ **TILT ▲▼ Buttons**
Not used.
- ⑤ **Band/Program Button**
Radio mode: BAND Button
Press the button and the band will change.
CD/Changer mode: To switch the disc mode.
- ⑥ **Volume Adjustment Buttons**
To increase the volume level:
Press the ▲ button
To decrease the volume level:
Press the ▼ button
- ⑦ **▲ Button**
Radio mode: Pressing the button will select, in ascending order, stations programmed into the radio's presets as shown below.

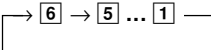
CD Changer mode: DISC Select (UP) Button
Press the button to select a disc in ascending order.
MP3/WMA mode: Press the Folder Select (UP) Button to select the folder.

- ⑧ **◀◀ DN Button**
Radio mode: SEEK (DN) Button
CD mode: Press the button to go back to the beginning of the current track.
- ⑨ **▶▶ UP Button**
Radio mode: SEEK (UP) Button
CD mode: Press the button to advance to the beginning of the next track.
- ⑩ **▼ Button**
Radio mode: Pressing the button will select, in descending order, stations programmed into the radio's presets as shown below.

CD Changer mode: DISC Select (DN) Button
Press the button to select a disc in descending order.
MP3/WMA mode: Press the Folder Select (DN) Button to select the folder.
- ⑪ **Mute Button**
Press the button to lower the volume by 20 dB instantly.
Press the button again to cancel.
- ⑫ **Audio Processor Button****
Press the button to call the external audio processor mode.*

* For the operation of external audio processor, refer to the Owner's Manual of the external audio processor you purchased.
** This button is used in conjunction with an optional Ai-NET processor.

Battery Replacement (CDA-9807 only)

Applicable battery: Use two "AAA" sized dry batteries or equivalent.

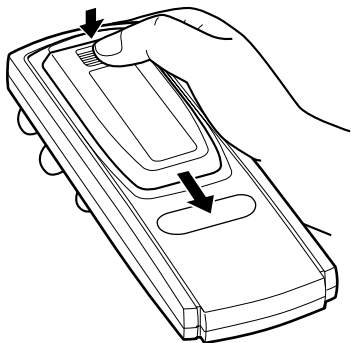
- 1** Opening the battery cover
Slide out the battery cover while firmly pressing the direction of arrow.



- 2** Replacing the battery
Put the batteries in the case observing the polarities as illustrated.

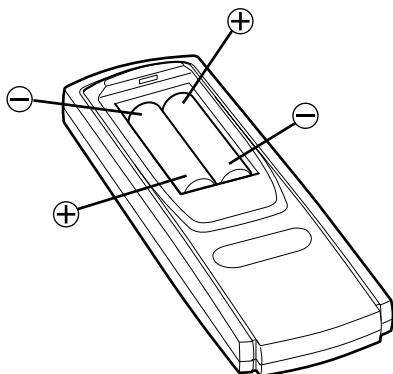

- 3** Closing the cover
Push the cover as illustrated until a click is heard.

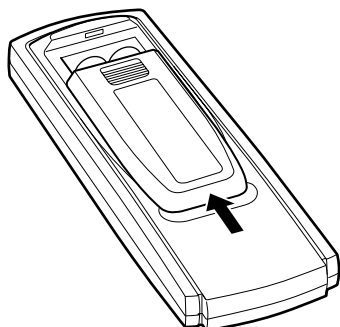

Point the optional remote control transmitter at the remote control sensor.

Remote control sensor

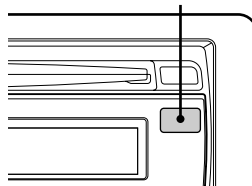

Information

About MP3/WMA

CAUTION

Except for personal enjoyment, duplicating audio data (including MP3/WMA data) or distributing, transferring, or copying it, whether for free or for a fee, without the permission of the copyright holder is strictly prohibited by the Copyright Act and by international treaty.

• What is MP3?

MP3, whose official name is "MPEG Audio Layer 3", is a compression standard prescribed by the ISO, the International Standardization Organization and MPEG which is a joint activity institution of the IEC.

MP3 files contain compressed audio data. MP3 encoding is capable of compressing the audio data at extremely high ratios shrinking music files by as much as one-tenth their original size. This is achieved while still maintaining near CD quality. The MP3 format realizes such high compression ratios by eliminating the sounds that are either inaudible to the human ear or masked by other sounds.

• What is WMA?

WMA, or "Windows Media™ Audio," is compressed audio data.

WMA allows you to create music files and store them at higher ratios of compression than MP3 audio data (approx. half original size). This is achieved while still maintaining CD quality sound.

• Method for creating MP3/WMA files

Audio data is compressed by using MP3/WMA specified software. For details on creating MP3/WMA files, refer to the user's manual for that software.

The MP3 files that can be played back by this device have the file extension "mp3". Files with no extension can not be played back.

WMA files have the "wma" extension. (WMA ver. 7.1 and 8 are supported)

• Supported playback sampling rates and bit rates

MP3

Sampling rates: 48 kHz, 44.1 kHz, 32 kHz, 24 kHz, 22.05 kHz, 16 kHz, 12 kHz, 11.025 kHz, 8 kHz,
Bit rates: 8 - 320 kbps

WMA

Sampling rates: 48 kHz, 44.1 kHz, 32 kHz, 24 kHz,
22.05 kHz
Bit rates: 32 - 192 kbps

Note that for sampling rates, this device's frame display (Page 9) may not display correctly. This device may not play back correctly depending on sampling rates.

• ID3 tags/WMA tags

ID3 tags of this device support ID3 tag v1 and v2. If ID3 tag/WMA tag data is in an MP3/WMA file, this device can display the title (track title), artist name, and album name ID3/WMA tag data.

This device can only display single-byte alphanumeric characters (up to 30) and the underscore. For non-supported characters, "NO SUPRT" is displayed.

• Producing MP3/WMA discs

MP3/WMA files are prepared, then written to a CD-R or CD-RW using CD-R writing software. A disc can hold up to 512 files/folders (including Root Folders).

• Media supported

The media that this device can play back are CD-ROMs, CD-Rs, and CD-RWs.

• Corresponding File Systems

This device supports discs formatted with ISO9660 Level 1 or Level 2.

Under the ISO9660 standard, there are some restrictions to remember.

The maximum nested folder depth is 8 (including the root directory). File/folder names are limited to 31 characters (including the extension), and are limited to 15 characters for WMA.

Valid characters for folder/file names are letters A-Z (all caps), numbers 0-9, and '_' (underscore).

This device also can play back discs in Joliet, Romeo, etc., and other standards that conform to ISO9660. However, sometimes the file names, folder names, etc. are not displayed correctly.

• Formats supported

This device supports CD-ROM XA, Mixed Mode CD, Enhanced CD (CD-Extra) and Multi-Session. This device can not correctly play back discs recorded with Track At Once or packet writing.

• Order of tracks

The unit plays the files in the order that the writing software writes them. Therefore, the playing order may not be the same as the order you input. The playback order of the folders and files is as follows. However, the folder and file playback order differs from the folder no. and file no. indicated on the display.

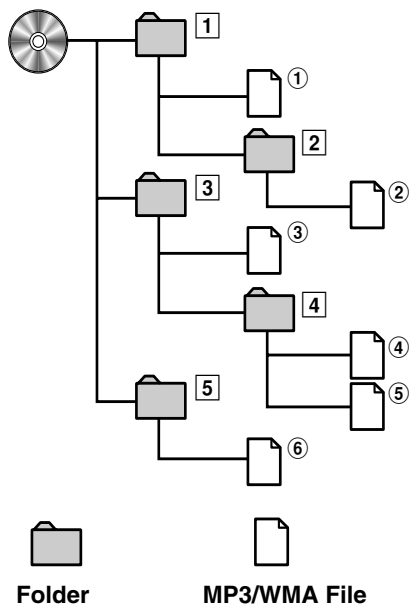

Terminology

Bit rate

This is the “sound” compression rate specified for encoding. The higher the bit rate, the higher the sound quality, but also the larger the files.

Sampling rate

This value shows how many times per second the data is sampled (recorded). For example, music CDs use a sampling rate of 44.1 kHz, so the sound level is sampled (recorded) 44,100 times per second. The higher the sampling rate, the higher the sound quality, but also the larger the volume of data.

Encoding

Converting music CDs, WAVE (AIFF) files, and other sound files into the specified audio compression format.

Tag

Song information such as track titles, artist names, album names, etc., written into MP3/WMA files.

- MP3: ID3 tag
- WMA: WMA tag

Information

In Case of Difficulty

If you encounter a problem, please turn the power off, then on again. If the unit is still not functioning normally, please review the items in the following checklist. This guide will help you isolate the problem if the unit is at fault. Otherwise, make sure the rest of your system is properly connected or consult your authorized Alpine dealer.

Basic

No function or display.

- Vehicle's ignition is off.
 - If connected following instructions, the unit will not operate with the vehicle's ignition off.
 - Improper power lead connections.
 - Check power lead connections.
 - Blown fuse.
 - Check the fuse on the battery lead of the unit; replace with the proper value if necessary.
 - Internal micro-computer malfunctioned due to interference noise etc.
 - Press the RESET switch with a ballpoint pen or other pointed article.
-

Radio

Unable to receive stations.

- No antenna or open connection in cable.
 - Make sure the antenna is properly connected; replace the antenna or cable if necessary.

Unable to tune stations in the seek mode.

- You are in a weak signal area.
 - Make sure the tuner is in the DX mode.
- If the area you are in is a primary signal area, the antenna may not be grounded and connected properly.
 - Check your antenna connections; make sure the antenna is properly grounded at its mounting location.
- The antenna may not be the proper length.
 - Make sure the antenna is fully extended; if broken, replace the antenna with a new one.

Broadcast is noisy.

- The antenna is not the proper length.
 - Extend the antenna fully; replace it if it is broken.
 - The antenna is poorly grounded.
 - Make sure the antenna is grounded properly at its mounting location.
-

CD

CD Player/Changer not functioning.

- Out of operating temperature range +50°C (+120°F) for CD.
 - Allow the vehicle's interior (or trunk) temperature to cool.

CD playback sound is wavering.

- Moisture condensation in the CD Module.
 - Allow enough time for the condensation to evaporate (about 1 hour).

CD insertion not possible.

- A CD is already in the CD player.
 - Eject the CD and remove it.
- The CD is being improperly inserted.
 - Make sure the CD is being inserted following instructions in the CD Player Operation section.

Unable to fast forward or backward the CD.

- The CD has been damaged.
 - Eject the CD and discard it; using a damaged CD in your unit can cause damage to the mechanism.

CD playback sound skips due to vibration.

- Improper mounting of the unit.
 - Securely re-mount the unit.
- Disc is very dirty.
 - Clean the disc.
- Disc has scratches.
 - Change the disc.
- The pick-up lens is dirty.
 - Do not use a commercial available lens cleaner disc. Consult your nearest ALPINE dealer.

CD playback sound skips without vibration.

- Dirty or scratched disc.
 - Clean the disc; damaged disc should be replaced.

Error displays (built-in CD player only)

- Mechanical error
 - Press the ▲ button. After the error indication disappears, insert the disc again. If the above-mentioned solution does not solve the problem, consult your nearest ALPINE dealer.

CD-R/CD-RW playback not possible

- Close session (finalization) has not been performed.
 - Perform finalization and attempt playback again.
-

MP3/WMA

MP3 or WMA is not played back.

- Writing error occurred. The CD format is not compatible.
 - Make sure the CD has been written in a supported format. Refer to "About MP3/WMA" on pages 28-29, then rewrite in the format supported by this device.
-

Indication for CD Player

HI TEMP

- Protective circuit is activated due to high temperature.
 - The indicator will disappear when the temperature returns to within operation range.
-

NO DISC

- No CD is inserted.
 - Insert a CD.
-

ERROR

- Mechanism error.
 - 1) Press the **▲** button and eject the CD.
If not ejecting, consult your Alpine dealer.
 - 2) When the error indication remains after ejecting, press the **▲** button again.
If the error indication still does not turn off after pressing the **▲** button for a few times, consult your Alpine dealer.

NOTE

When the "ERROR" is displayed:

*In case that the disc cannot be ejected by pressing the **▲** button, press the RESET switch (refer to page 5) and press the **▲** button again.*

If not ejecting, consult your Alpine dealer.

PROTECT

- A copy-protected WMA file was played back.
 - You can only play back non-copy-protected files.
-

UN SUPRT

- The disc is not written in a MP3/WMA supported format.
 - Use a disc written at the MP3/WMA supported format.
-

Indication for CD Changer

HI TEMP

- Protective circuit is activated due to high temperature.
 - The indicator will disappear when the temperature returns to within operation range.
-

ERROR - 01

- Malfunction in the CD Changer.
 - Consult your Alpine dealer. Press the magazine eject button and pull out the magazine.
Check the indication. Insert the magazine again.
If the magazine cannot be pulled out, consult your Alpine dealer.
 - Magazine ejection not possible.
 - Press the magazine eject button. If the magazine does not eject, consult your Alpine dealer.
-

ERROR - 02

- A disc is left inside the CD Changer.
 - Press the Eject button to activate the eject function. When the CD Changer finishes the eject function, insert an empty CD magazine into the CD Changer to receive the disc left inside the CD Changer.
-

NO MAGZN

- No magazine is loaded into the CD Changer.
 - Insert a magazine.
-

NO DISC

- No indicated disc.
 - Choose another disc.
-

Information

Indication for XM Radio Mode

ANTENNA

- The XM antenna is not connected to the XM radio module.
 - Check whether the XM antenna cable is attached securely to the XM radio module.
-

UPDATING

- Radio is being updated with latest encryption code.
 - Wait until encryption code is being updated. Channels 0 and 1 should function normally.
-

NO SIGNAL

- XM signal is too weak at the current location.
 - Wait until the car reaches a location with a stronger signal.
-

LOADING

- Radio is acquiring audio or program information.
 - Wait until the radio has received the information.
-

OFF AIR

- The channel currently selected has stopped broadcasting.
 - Select another channel.
-

- The user has selected a Channel Number that does not exist or is not subscribed to.
 - The unit will revert back to the previously selected channel.
 - There is no artist name/feature, song/program title, or additional information associated with the channel at that time.
 - No action needed.
-

Specifications

FM TUNER SECTION

Tuning Range	87.7 – 107.9 MHz
Mono Usable Sensitivity	9.3 dBf (0.8 μ V/75 ohms)
50 dB Quieting Sensitivity	13.5 dBf (1.3 μ V/75 ohms)
Alternate Channel Selectivity	80 dB
Signal-to-Noise Ratio	65 dB
Stereo Separation	35 dB
Capture Ratio	2.0 dB

AM TUNER SECTION

Tuning Range	530 – 1,710 kHz
Sensitivity (IEC Standard)	22.5 μ V/27 dB

CD PLAYER SECTION

Frequency Response	5 – 20,000 Hz (\pm 1 dB)
Wow & Flutter (% WRMS)	Below measurable limits
Total Harmonic Distortion	0.008% (at 1 kHz)
Dynamic Range	95 dB (at 1 kHz)
Signal-to-Noise Ratio	105 dB
Channel Separation	85 dB (at 1 kHz)

PICKUP

Wave length	795 nm
Laser power	CLASS I

REMOTE CONTROL

Battery Type	AAA batteries (2 pcs.)
Width	42 mm (1-21/32")
Height	121 mm (4-25/32")
Depth	23 mm (29/32")
Weight	50 g (1.8 oz)

GENERAL

Power Requirement	14.4 V DC (11–16 V allowable)
Maximum Power Output	50W \times 4
Maximum Pre-Output Voltage	4 V/10k ohms
Maximum Subwoofer Output Voltage	4 V/10 k ohms
Bass	\pm 14 dB at 60 Hz
Treble	\pm 14 dB at 10 kHz
Weight	1.5 kg (3 lbs. 5 oz)

CHASSIS SIZE

Width	178 mm (7")
Height	50 mm (2")
Depth	160 mm (6-1/4")

NOSEPIECE SIZE

Width	170 mm (6-11/16")
Height	46 mm (1-13/16")
Depth	20 mm (25/32")

Due to continuous product improvement, specifications and design are subject to change without notice.

Installation and Connections

Before installing or connecting the unit, please read the following and pages 3 and 4 of this manual thoroughly for proper use.

Warning

MAKE THE CORRECT CONNECTIONS.

Failure to make the proper connections may result in fire or product damage.

USE ONLY IN CARS WITH A 12 VOLT NEGATIVE GROUND.

(Check with your dealer if you are not sure.) Failure to do so may result in fire, etc.

BEFORE WIRING, DISCONNECT THE CABLE FROM THE NEGATIVE BATTERY TERMINAL.

Failure to do so may result in electric shock or injury due to electrical shorts.

DO NOT ALLOW CABLES TO BECOME ENTANGLED IN SURROUNDING OBJECTS.

Arrange wiring and cables in compliance with the manual to prevent obstructions when driving. Cables or wiring that obstruct or hang up on places such as the steering wheel, gear lever, brake pedals, etc. can be extremely hazardous.

DO NOT SPLICE INTO ELECTRICAL CABLES.

Never cut away cable insulation to supply power to other equipment. Doing so will exceed the current carrying capacity of the wire and result in fire or electric shock.

DO NOT DAMAGE PIPE OR WIRING WHEN DRILLING HOLES.

When drilling holes in the chassis for installation, take precautions so as not to contact, damage or obstruct pipes, fuel lines, tanks or electrical wiring. Failure to take such precautions may result in fire.

DO NOT USE BOLTS OR NUTS IN THE BRAKE OR STEERING SYSTEMS TO MAKE GROUND CONNECTIONS.

Bolts or nuts used for the brake or steering systems (or any other safety-related system), or tanks should NEVER be used for installations or ground connections. Using such parts could disable control of the vehicle and cause fire etc.

KEEP SMALL OBJECTS SUCH AS BATTERIES OUT OF THE REACH OF CHILDREN.

Swallowing them may result in serious injury. If swallowed, consult a physician immediately.

DO NOT INSTALL IN LOCATIONS WHICH MIGHT HINDER VEHICLE OPERATION, SUCH AS THE STEERING WHEEL OR GEARSHIFT.

Doing so may obstruct forward vision or hamper movement etc. and results in serious accident.

Caution

HAVE THE WIRING AND INSTALLATION DONE BY EXPERTS.

The wiring and installation of this unit requires special technical skill and experience. To ensure safety, always contact the dealer where you purchased this product to have the work done.

USE SPECIFIED ACCESSORY PARTS AND INSTALL THEM SECURELY.

Be sure to use only the specified accessory parts. Use of other than designated parts may damage this unit internally or may not securely install the unit in place. This may cause parts to become loose resulting in hazards or product failure.

ARRANGE THE WIRING SO IT IS NOT CRIMPED OR PINCHED BY A SHARP METAL EDGE.

Route the cables and wiring away from moving parts (like the seat rails) or sharp or pointed edges. This will prevent crimping and damage to the wiring. If wiring passes through a hole in metal, use a rubber grommet to prevent the wire's insulation from being cut by the metal edge of the hole.

DO NOT INSTALL IN LOCATIONS WITH HIGH MOISTURE OR DUST.

Avoid installing the unit in locations with high incidence of moisture or dust. Moisture or dust that penetrates into this unit may result in product failure.

Precautions

- Be sure to disconnect the cable from the (-) battery post before installing your CDA-9807/CDA-9805. This will reduce any chance of damage to the unit in case of a short-circuit.
- Be sure to connect the color coded leads according to the diagram. Incorrect connections may cause the unit to malfunction or damage to the vehicle's electrical system.
- When making connections to the vehicle's electrical system, be aware of the factory installed components (e.g. on-board computer). Do not tap into these leads to provide power for this unit. When connecting the CDA-9807/CDA-9805 to the fuse box, make sure the fuse for the intended circuit of the CDA-9807/CDA-9805 has the appropriate amperage. Failure to do so may result in damage to the unit and/or the vehicle. When in doubt, consult your ALPINE dealer.
- The CDA-9807/CDA-9805 uses female RCA-type jacks for connection to other units (e.g. amplifier) having RCA connectors. You may need an adaptor to connect other units. If so, please contact your authorized ALPINE dealer for assistance.
- Be sure to connect the speaker (-) leads to the speaker (-) terminal. Never connect left and right channel speaker cables to each other or to the vehicle body.

IMPORTANT

Please record the serial number of your unit in the space provided below and keep it as a permanent record. The serial number plate is located on the bottom of the unit.

SERIAL NUMBER: _____
INSTALLATION DATE: _____
INSTALLATION TECHNICIAN: _____
PLACE OF PURCHASE: _____

Installation

Caution

Do not block the unit's fan or heat sink, thus preventing air circulation. If blocked, heat will accumulate inside the unit and may cause a fire.

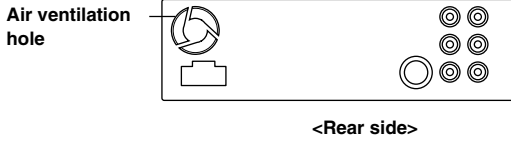

1

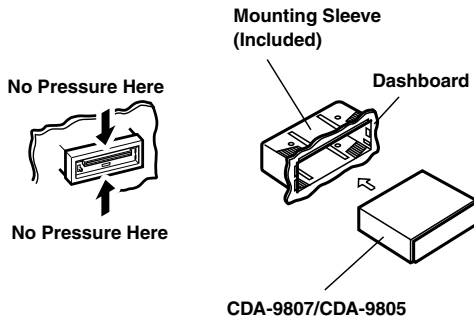

Remove the Detachable Front Panel (refer to page 5). Slide mounting sleeve from main unit. (see "Removal" on this page).

Slide the mounting sleeve into the dashboard.

NOTE

Please examine the installation. Make certain that no external pressure is applied to either the top of the unit or the removable nosepiece.

2

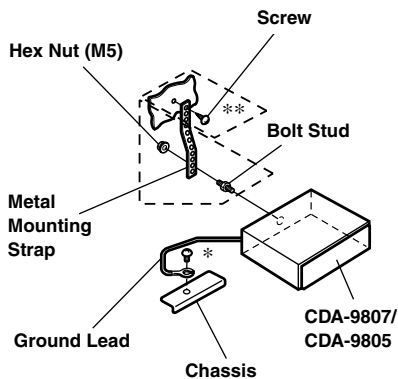

Reinforce the head unit with the metal mounting strap (not supplied). Secure the ground lead of the unit to a clean metal spot using a screw (*) already attached to the vehicle's chassis.

NOTE

For the screw marked **, use an appropriate screw for the chosen mounting location.

Connect each input lead coming from an amplifier or equalizer to the corresponding output lead coming from the left rear of the CDA-9807/CDA-9805. Connect all other leads of the CDA-9807/CDA-9805 according to details described in the CONNECTIONS section.

3

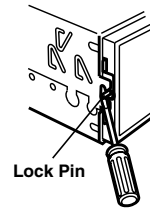

Slide the CDA-9807/CDA-9805 into the dashboard. When the unit is in place, make sure the locking pins are fully seated in the down position. This can be done by pressing firmly in on the unit while pushing the locking pin down with a small screwdriver. This ensures that the unit is properly locked and will not accidentally come out from the dashboard. Install the Detachable Front Panel.

Removal

- 1 Remove the DETACHABLE FRONT PANEL.
- 2 Use a small screwdriver (or similar tool) to push the locking pins to the "up" position (see above drawing). As each pin is unlocked, gently pull out on the unit to make sure it does not re-lock before unlocking the second pin.
- 3 Pull the unit out, keeping it unlocked as you do so.

<JAPANESE CAR>

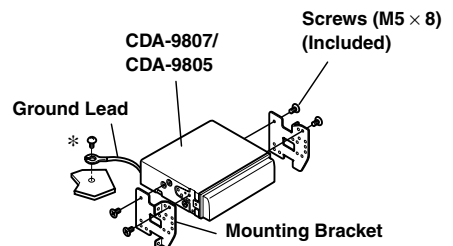
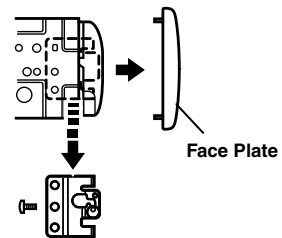

NOTE

Secure the ground lead of the unit to a clean metal spot using a screw (*) already attached to the vehicle's chassis.

Installation and Connections

Connections

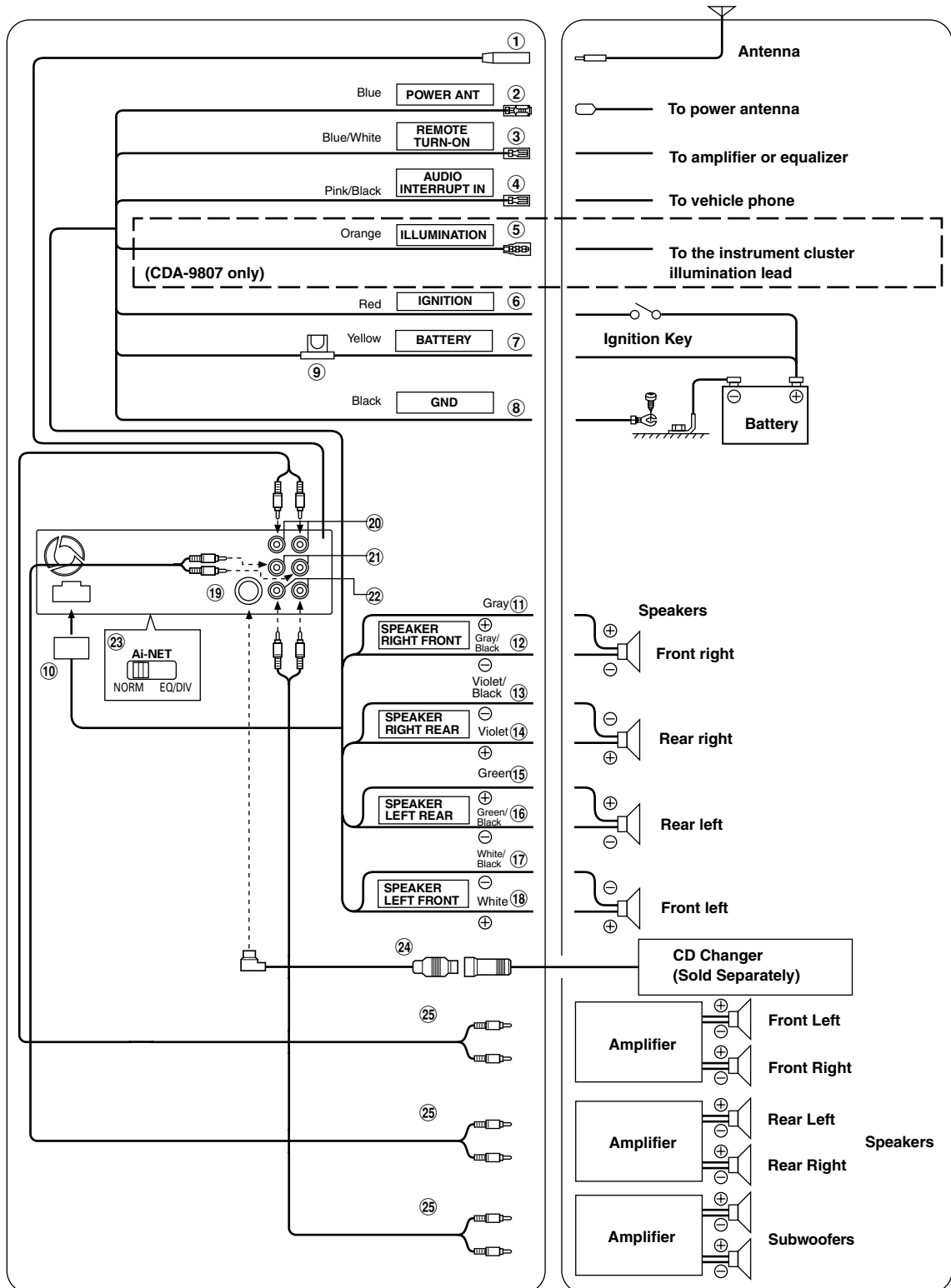

- ① Antenna Receptacle
- ② Power Antenna Lead (Blue)
Connect this lead to the +B terminal of your power antenna, if applicable.

NOTE

This lead should be used only for controlling the vehicle's power antenna. Do not use this lead to turn on an amplifier or a signal processor, etc.

- ③ Remote Turn-On Lead (Blue/White)
Connect this lead to the remote turn-on lead of your amplifier or signal processor.
- ④ Audio Interrupt In Lead (Pink/Black)
- ⑤ Illumination Lead (Orange)
This lead may be connected to the vehicle's instrument cluster illumination lead. This will allow the backlighting of the CDA-9807 to dim whenever the vehicle's lights are turned on.
- ⑥ Switched Power Lead (Ignition) (Red)
Connect this lead to an open terminal on the vehicle's fuse box or another unused power source which provides (+)12V only when the ignition is turned on or in the accessory position.
- ⑦ Battery Lead (Yellow)
Connect this lead to the positive (+) post of the vehicle's battery.
- ⑧ Ground Lead (Black)
Connect this lead to a good chassis ground on the vehicle. Make sure the connection is made to bare metal and is securely fastened using the sheet metal screw provided.
- ⑨ Fuse Holder (15A)
- ⑩ Power Supply Connector
- ⑪ Right Front (+) Speaker Output Lead (Gray)
- ⑫ Right Front (-) Speaker Output Lead (Gray/Black)
- ⑬ Right Rear (-) Speaker Output Lead (Violet/Black)
- ⑭ Right Rear (+) Speaker Output Lead (Violet)

- ⑮ Left Rear (+) Speaker Output Lead (Green)
- ⑯ Left Rear (-) Speaker Output Lead (Green/Black)
- ⑰ Left Front (-) Speaker Output Lead (White/Black)
- ⑱ Left Front (+) Speaker Output Lead (White)

- ⑲ Ai-NET Connector

Connect this to the output or input connector of other product (CD Changer, Equalizer, etc.) equipped with Ai-NET.

NOTE

You can input TV/video sound by connecting an optional Ai-NET/RCA Interface cable (KCA-121B) to this component.

- ⑳ Front Output RCA Connectors
RED is right and WHITE is left.
- ㉑ Rear Output RCA Connectors
RED is right and WHITE is left.
- ㉒ Subwoofer RCA Connectors
RED is right and WHITE is left.
- ㉓ System Switch
When connecting a processor or divider using Ai-NET, place this switch in the EQ/DIV position. When no device is connected, leave the switch in the NORM position.

NOTE

Be sure to turn the power off to the unit before changing the switch position.

- ㉔ Ai-NET Cable (Included with CD Changer)
- ㉕ RCA Extension Cable (Sold Separately)

To prevent external noise from entering the audio system.

- Locate the unit and route the leads at least 10 cm away from the car harness.
- Keep the battery power leads as far away from other leads as possible.
- Connect the ground lead securely to a bare metal spot (remove any paint, dirt or grease if necessary) of the car chassis.
- If you add an optional noise suppressor, connect it as far away from the unit as possible. Your Alpine dealer carries various noise suppressors, contact them for further information.
- Your Alpine dealer knows best about noise prevention measures so consult your dealer for further information.

LIMITED WARRANTY

ALPINE ELECTRONICS OF AMERICA, INC. AND ALPINE OF CANADA INC. ("Alpine"), are dedicated to quality craftsmanship and are pleased to offer this Warranty. We suggest that you read it thoroughly. Should you have any questions, please contact your Dealer or Alpine at one of the telephone numbers listed below.

● PRODUCTS COVERED:

This Warranty covers Car Audio/Visual Products and Related Accessories ("the product"). Products purchased in the Canada are covered only in the Canada. Products purchased in the U.S.A. are covered only in the U.S.A.

● LENGTH OF WARRANTY:

This Warranty is in effect for one year from the date of the first consumer purchase.

● LIFETIME TAPE HEAD WARRANTY:

All Alpine Car Audio analog tape heads excluding Video tape heads are warranted for life against manufacturing defects causing failure.

● WHO IS COVERED:

This Warranty only covers the original purchaser of the product, who must reside in the United States, Puerto Rico or Canada.

● WHAT IS COVERED:

This Warranty covers defects in materials or workmanship (parts and labor) in the product.

● WHAT IS NOT COVERED:

This Warranty does not cover the following:

- ① Damage occurring during shipment of the product to Alpine for repair (claims must be presented to the carrier).
- ② Damage caused by accident, abuse, negligence, misuse, improper connections, improper operation or failure to follow instructions contained in the Owner's manual.
- ③ Damage caused by act of God, including without limitation, earthquake, fire, flood, storms or other acts of nature.
- ④ Any cost or expense related to the removal or reinstallation of the product.
- ⑤ Service performed by an unauthorized person, company or association.
- ⑥ Any product which has the serial number defaced, altered or removed.
- ⑦ Any product which has been adjusted, altered or modified without Alpine's consent.
- ⑧ Any product not distributed by Alpine within the United States, Puerto Rico or Canada.
- ⑨ Any product not purchased from an Authorized Alpine Dealer.
- ⑩ Any product that has been determined to contain an excessive amount of dust or dirt and any product that contains other contaminants including liquid or foreign objects.

● HOW TO OBTAIN WARRANTY SERVICE:

- ① You are responsible for delivery of the product to an Authorized Alpine Service Center or Alpine for repair and for payment of any initial shipping charges. Alpine will, at its option, repair or replace the product with a new or reconditioned product without charge. If the repairs are covered by the warranty, and if the product was shipped to an Authorized Alpine Service Center or Alpine, Alpine will pay the return shipping charges.

- ② You should provide a detailed description of the problem(s) for which service is required.
- ③ You must supply proof of your purchase of the product.
- ④ You must package the product securely to avoid damage during shipment.

● HOW WE LIMIT IMPLIED WARRANTIES:

ANY IMPLIED WARRANTIES INCLUDING FITNESS FOR USE AND MERCHANTABILITY ARE LIMITED IN DURATION TO THE PERIOD OF THE EXPRESS WARRANTY SET FORTH ABOVE AND NO PERSON IS AUTHORIZED TO ASSUME FOR ALPINE ANY OTHER LIABILITY IN CONNECTION WITH THE SALE OF THE PRODUCT.

● HOW WE EXCLUDE CERTAIN DAMAGES:

ALPINE EXPRESSLY DISCLAIMS LIABILITY FOR INCIDENTAL AND CONSEQUENTIAL DAMAGES CAUSED BY THE PRODUCT. THE TERM "INCIDENTAL DAMAGES" REFERS TO EXPENSES OF TRANSPORTING THE PRODUCT TO THE ALPINE SERVICE CENTER, LOSS OF THE ORIGINAL PURCHASER'S TIME, LOSS OF THE USE OF THE PRODUCT, BUS FARES, CAR RENTALS OR OTHERS COSTS RELATING TO THE CARE AND CUSTODY OF THE PRODUCT. THE TERM "CONSEQUENTIAL DAMAGES" REFERS TO THE COST OF REPAIRING OR REPLACING OTHER PROPERTY WHICH IS DAMAGED WHEN THIS PRODUCT DOES NOT WORK PROPERLY. THE REMEDIES PROVIDED UNDER THIS WARRANTY ARE EXCLUSIVE AND IN LIEU OF ALL OTHERS.

● HOW STATE/PROVINCIAL LAW RELATES TO THE WARRANTY:

This Warranty gives you specific legal rights, and you may also have other rights which vary from state to state and province to province. In addition, some states/provinces do not allow limitations on how long an implied warranty lasts, and some do not allow the exclusion or limitation of incidental or consequential damages. Accordingly, limitations as to these matters contained herein may not apply to you.

● IN CANADA ONLY:

This Warranty is not valid unless your Alpine car audio product has been installed in your vehicle by an Authorized Installation Center, and this warranty stamped upon installation by the installation center.

● HOW TO CONTACT CUSTOMER SERVICE:

Should the product require service, please call the following number for your nearest Authorized Alpine Service Center.

U.S.A.	1-800-ALPINE-1 (1-800-257-4631)
CANADA	1-800-ALPINE-1 (1-800-257-4631)

Free Manuals Download Website

<http://myh66.com>

<http://usermanuals.us>

<http://www.somanuals.com>

<http://www.4manuals.cc>

<http://www.manual-lib.com>

<http://www.404manual.com>

<http://www.luxmanual.com>

<http://aubethermostatmanual.com>

Golf course search by state

<http://golfingnear.com>

Email search by domain

<http://emailbydomain.com>

Auto manuals search

<http://auto.somanuals.com>

TV manuals search

<http://tv.somanuals.com>