

# ALTO SHAAM® Cook, Hold, Smoke Oven Electronic Control



**Model:**

**767-SK/III**

**1767-SK/III**

**2800-SK/III**

- **INSTALLATION**
- **OPERATION**
- **MAINTENANCE**

**HALO**  
**HEAT**

**24•7**  
Your Service Hotline  
1-800-558-8744

W164 N9221 Water Street • P.O. Box 450 • Menomonee Falls, Wisconsin 53052-0450 USA  
PHONE: 262.251.3800 • 800.558.8744 USA/CANADA FAX: 262.251.7067 • 800.329.8744 U.S.A. ONLY  
[www.alto-shaam.com](http://www.alto-shaam.com)

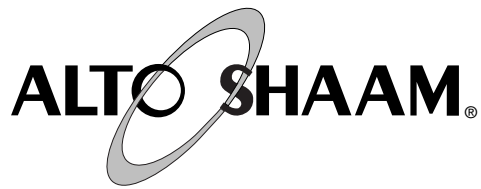

## DELIVERY

This Alto-Shaam appliance has been thoroughly tested and inspected to insure only the highest quality unit is provided. Upon receipt, check for any possible shipping damage and report it at once to the delivering carrier. *See Transportation Damage and Claims section located in this manual.*

This appliance, complete with unattached items and accessories, may have been delivered in one or more packages. Check to ensure that all standard items and options have been received with each model as ordered.

Save all the information and instructions packed with the appliance. Complete and return the warranty card to the factory as soon as possible to assure prompt service in the event of a warranty parts and labor claim.

This manual must be read and understood by all people using or installing the equipment model. Contact the Alto-Shaam service department if you have any questions concerning installation, operation, or maintenance.

**NOTE:** All claims for warranty must include the full model number and serial number of the unit.

## UNPACKING

1. Carefully remove the appliance from the carton or crate.

**NOTE:** Do not discard the carton and other packaging material until you have inspected the unit for hidden damage and tested it for proper operation.

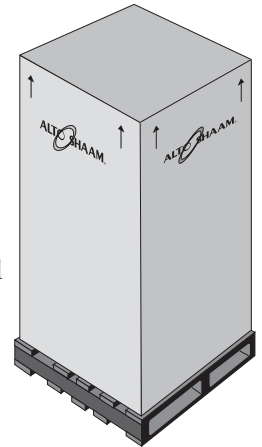

2. Read all instructions in this manual carefully before initiating the installation of this appliance.

**DO NOT DISCARD THIS MANUAL.**

This manual is considered to be part of the appliance and is to be provided to the owner or manager of the business or to the person responsible for training operators. *Additional manuals are available from the Alto-Shaam service department.*

3. Remove all protective plastic film, packaging materials, and accessories from the appliance before connecting electrical power. Store any accessories in a convenient place for future use.

## SAFETY PROCEDURES AND PRECAUTIONS

Knowledge of proper procedures is essential to the safe operation of electrically and/or gas energized equipment. In accordance with generally accepted product safety labeling guidelines for potential hazards, the following signal words and symbols may be used throughout this manual.

### DANGER



Used to indicate the presence of a hazard that **WILL** cause severe personal injury, death, or substantial property damage if the warning included with this symbol is ignored.

### WARNING



Used to indicate the presence of a hazard that **CAN** cause personal injury, possible death, or major property damage if the warning included with this symbol is ignored.

### CAUTION



Used to indicate the presence of a hazard that can or will cause minor or moderate personal injury or property damage if the warning included with this symbol is ignored.

### CAUTION

Used to indicate the presence of a hazard that can or will cause minor personal injury, property damage, or a potential unsafe practice if the warning included with this symbol is ignored.

**NOTE:** Used to notify personnel of installation, operation, or maintenance information that is important but not hazard related.

1. This appliance is intended to cook, hold or process foods for the purpose of human consumption. No other use for this appliance is authorized or recommended.
2. This appliance is intended for use in commercial establishments where all operators are familiar with the purpose, limitations, and associated hazards of this appliance. Operating instructions and warnings must be read and understood by all operators and users.
3. Any troubleshooting guides, component views, and parts lists included in this manual are for general reference only and are intended for use by qualified technical personnel.
4. This manual should be considered a permanent part of this appliance. This manual and all supplied instructions, diagrams, schematics, parts lists, notices, and labels must remain with the appliance if the item is sold or moved to another location.

### NOTE



For equipment delivered for use in any location regulated by the following directive:

**DO NOT DISPOSE OF ELECTRICAL OR ELECTRONIC EQUIPMENT WITH OTHER MUNICIPAL WASTE.**

## INSTALLATION

### DANGER



IMPROPER INSTALLATION, ALTERATION, ADJUSTMENT, SERVICE, OR MAINTENANCE COULD RESULT IN SEVERE INJURY, DEATH OR CAUSE PROPERTY DAMAGE.

READ THE INSTALLATION, OPERATING AND MAINTENANCE INSTRUCTIONS THOROUGHLY BEFORE INSTALLING OR SERVICING THIS EQUIPMENT.

### CAUTION



METAL PARTS OF THIS EQUIPMENT BECOME EXTREMELY HOT WHEN IN OPERATION. TO AVOID BURNS, ALWAYS USE HAND PROTECTION WHEN OPERATING THIS APPLIANCE.

### CAUTION



TO PREVENT PERSONAL INJURY, USE CAUTION WHEN MOVING OR LEVELING THIS APPLIANCE.



### DANGER



DO NOT store or use gasoline or other flammable vapors or liquids in the vicinity of this or any other appliance.

## SITE INSTALLATION

The Alto-Shaam cook and hold oven must be installed in a location that will permit the oven to function for its intended purpose and to allow adequate clearance for ventilation, proper cleaning, and maintenance access.

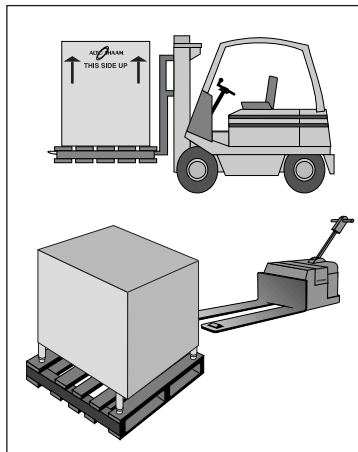

### CLEARANCE REQUIREMENTS

18" (457mm) minimum clearance at the back from heat producing equipment. To protect the electronic control, maintain sufficient side clearance to prevent the control area from reaching any temperature at or above 140°F (60°C).

### NOTE

If the appliance has been unplugged for an extended period of time, the Real Time Clock may require recharging. Plug the unit into the proper receptacle for a minimum of 24 hours.

1. The oven must be installed on a stable and level surface.
2. **DO NOT** install this appliance in any area where it may be affected by any adverse conditions such as steam, grease, dripping water, high temperatures, or any other severely adverse conditions.
3. **DO NOT** store or use any flammable liquids or allow flammable vapors in the vicinity of this oven or any other appliance.
4. This appliance must be kept free and clear of any combustible materials.
5. This appliance must be kept free and clear of any obstructions blocking access for maintenance or service.

# INSTALLATION

## SITE INSTALLATION

### 767-SK/III

### 1767-SK/III

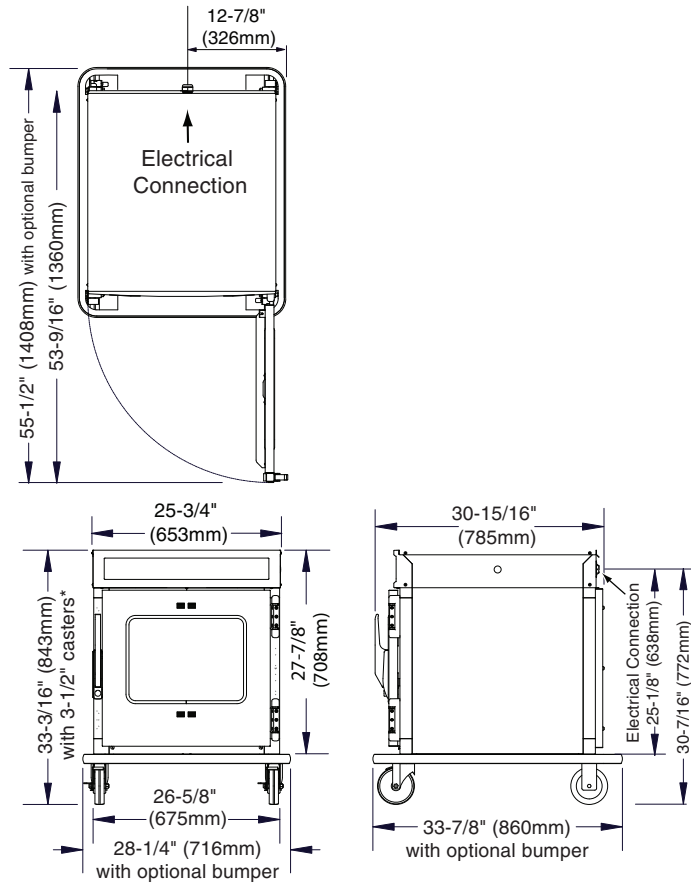

\*32-3/16" (817mm) - with optional 2-1/2" casters  
 \*34-5/8" (878mm) - with optional 5" casters  
 \*34-13/16" (884mm) - with optional 6" legs

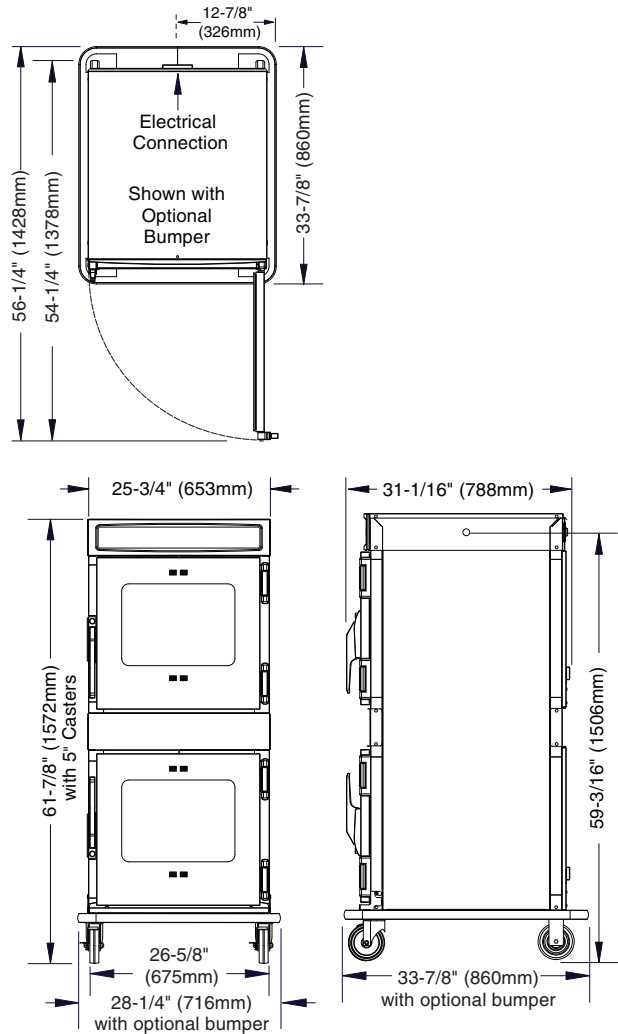

\*61-15/16" (1572mm) - with optional 3-1/2" (89mm) casters  
 \*63-1/2" (1613mm) - with optional 6" (152mm) legs

| WEIGHT      |                      |                      | CAPACITY PER COMPARTMENT  |
|-------------|----------------------|----------------------|---|
| MODEL       | NET WEIGHT           | SHIP WEIGHT          |   |
| 767-SK/III  | 196 lb (89 kg)       | 216 lb (98 kg) EST.  | 100 lb (45 kg) MAXIMUM<br>VOLUME MAXIMUM: 53 QUARTS (67 LITERS) |
| 1767-SK/III | 359 lb (163 kg) EST. | 399 lb (181 kg) EST. |   |

## SITE INSTALLATION

### 2800-SK/III

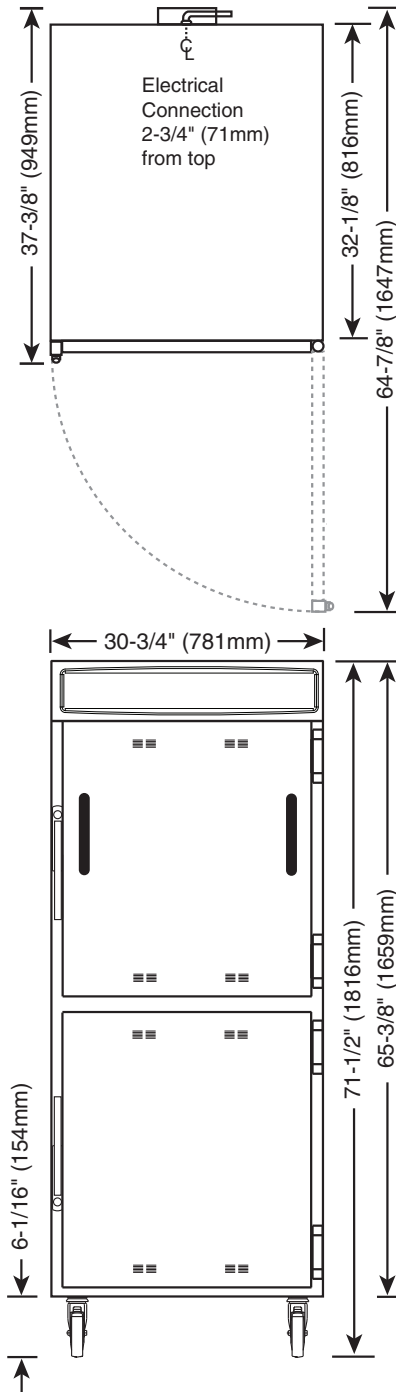

| WEIGHT      |                 |                 | CAPACITY   |
|-------------|-----------------|-----------------|--|
| MODEL       | NET WEIGHT      | SHIP WEIGHT     |  |
| 2800-SK/III | 410 lb (186 kg) | 575 lb (261 kg) | 360 lb (163 kg) MAXIMUM<br>VOLUME MAXIMUM: 225 QUARTS (285 LITERS) |

# INSTALLATION

## SITE INSTALLATION

| <b>OPTIONS AND ACCESSORIES</b>   | <b>767-SK/III</b>                           | <b>1767-SK/III</b>                          | <b>2800-SK/III</b>                          |
|--|---|---|---|
| Bumper, Full Perimeter   | 5004861                                     | 5004861                                     | 5001159                                     |
| Carving Holder<br>PRIME RIB<br>STEAMSHIP (CAFETERIA) ROUND   | HL-2635<br>4459                             | HL-2635<br>4459                             | HL-2635<br>4459                             |
| Casters - 2 RIGID, 2 SWIVEL W/BRAKE<br>5" (127mm)<br>3-1/2" (89mm)<br>2-1/2" (64mm)  | 5004862<br>STANDARD<br>5008022              | 5004862<br>STANDARD<br>---                  | STANDARD<br>5008017<br>---                  |
| Door Lock with Key   | LK-22567                                    | LK-22567                                    | ---   |
| Drip Pan with Drain  | 14831                                       | 14831                                       | ---   |
| Legs, 6" (152mm), Flanged (SET OF FOUR)  | 5004863                                     | 5004863                                     | 5004863                                     |
| Pan Grid, Wire - 18" X 26" PAN INSERT  | PN-2115                                     | PN-2115                                     | ---   |
| Pan Slides (230V ONLY)   | 5008240                                     | 5008240                                     | ---   |
| Shelf, Stainless Steel<br>FLAT WIRE, REACH-IN<br>RIB RACK  | SH-2324<br>SH-2743                          | SH-2324<br>SH-2743                          | SH-27988<br>---                             |
| Stacking Hardware  | 5004864                                     | ---   | ---   |
| Wood Chips, bulk pack<br>Apple 20 lb (9 kg)<br>Cherry 20 lb (9 kg)<br>Hickory 20 lb (9 kg)<br>Maple 20 lb (9 kg)                                       | WC-22543<br>WC-22541<br>WC-2829<br>WC-22545 | WC-22543<br>WC-22541<br>WC-2829<br>WC-22545 | WC-22543<br>WC-22541<br>WC-2829<br>WC-22545 |
| HACCP Network Options<br>➤ HACCP Documentation<br>➤ HACCP with Kitchen Management<br>* REFER TO HACCP SPECIFICATION #9015 FOR APPLICABLE PART NUMBERS. |   |   |   |

## SITE INSTALLATION

### STACKING INSTRUCTIONS

- 1) If the two appliances were shipped together from the factory, the top unit will have the casters already removed. A stacking kit will be included with the shipment.

If casters need to be removed: lay the unit on its back, and remove the set screw on each caster. Pull the casters out of the unit.

- 2) While appliance is laid on its back, insert one stacking post in each of the four corners of the upper unit. Secure the stacking posts using one screw and two flat washers that come with the stacking kit.

**Note:** The flange on the stacking posts must face the outside of the unit.

- 3) Remove the four top mounting screws from the lower unit. Place the upper appliance, which has the stacking posts installed, on top of the bottom unit. Center the top unit from front to back. Re-install the four screws through the flange of the four stacking posts.

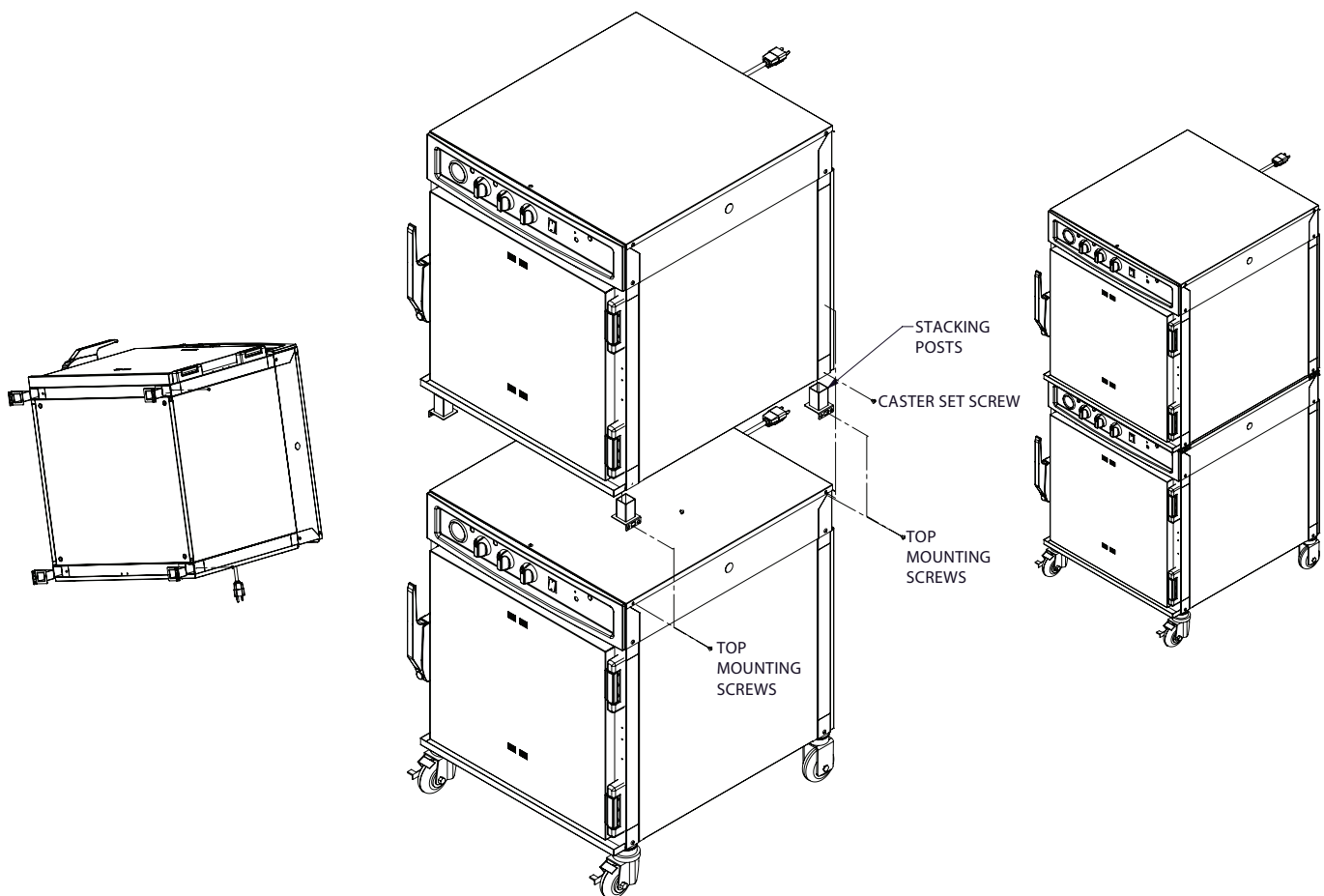

#### Stacking Configurations

767-SK/III with 767-SK/III, 750-TH/III,  
750-TH-II, 767-SK, or 750-S



# INSTALLATION

## SITE INSTALLATION

A number of adjustments are associated with initial installation and start-up. It is important that these adjustments be conducted by a qualified service technician. Installation and start-up adjustments are the responsibility of the dealer or user. These adjustments include but are not limited to thermostat calibration, door adjustment, leveling, electrical hook-up and installation of optional casters or legs.

### LEVELING

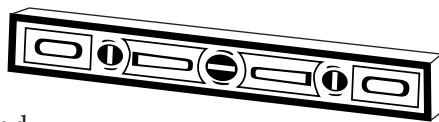

Level the oven from side-to-side and front-to-back with the use of a spirit level. For ovens installed with casters, it is important that the installation surface be level due to the probability of frequent oven repositioning.

We recommend checking the level of the oven periodically to make certain the floor has not shifted nor the oven moved.

**NOTE:** Failure to properly level this oven can cause improper function and will result in the uneven baking with products consisting of semi-liquid batter.

### RESTRAINT REQUIREMENTS —MOBILE EQUIPMENT

|   |   |
|---|---|
|  <b>WARNING</b> |   |
|                 | <b>RISK OF ELECTRIC SHOCK.</b><br><b>Appliance must be secured to building structure.</b> |

Any appliance that is not furnished with a power supply cord but that includes a set of casters must be installed with a tether. Adequate means must be provided to limit the movement of this appliance without depending on or transmitting stress to the electrical conduit. The following requirements apply:

1. Maximum height of casters is 6" (152mm).
2. Two of the casters must be the locking type.
3. Such mobile appliances or appliances on mobile stands must be installed with the use of a flexible connector secured to the building structure.

A mounting connector for a restraining device is located on the lower back flange of the appliance chassis or on an oven stand, approximately 18" (457mm) from the floor. A flexible connector is not supplied by nor is it available from the factory.

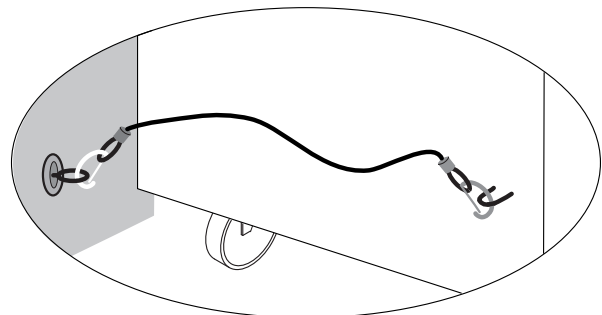

## SITE INSTALLATION

### DRIP TRAY INSTALLATION INSTRUCTIONS

#### 767-SK/III & 1767-SK/III

**Standard Drip Pan**  
14831  
[Bottom of oven interior •  
below side-racks]

**Drip Tray**  
1008772  
Place drip tray into  
drip tray holder

**Drip Tray  
Holder**  
1008771



#### 2800-SK/III

**STANDARD DRIP PAN\***  
[BOTTOM OF OVEN INTERIOR •  
BELOW SIDE-RACKS]

**SLIDE DRIP TRAY  
INTO BRACKETS  
UNDER DRIP TRAY  
PLATFORM**

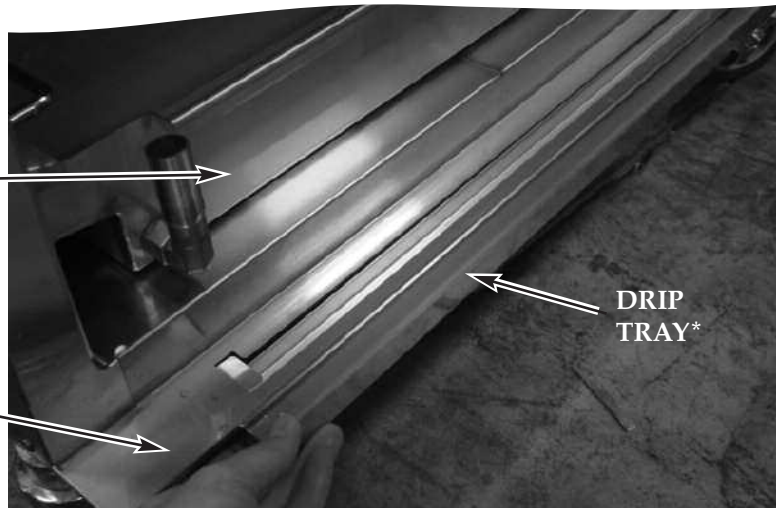

\*SEE ALTO-SHAAM PARTS LIST FOR ALTO-SHAAM PART NUMBERS.



## WARNING



**FAILURE TO PROPERLY INSTALL THE  
DRIP TRAY CAN OR WILL CAUSE  
MAJOR EQUIPMENT DAMAGE AND  
WILL RESULT IN A LEAKAGE  
HAZARD THAT CAN CAUSE  
PERSONAL INJURY.**

# INSTALLATION

## ELECTRICAL CONNECTION

The appliance must be installed by a qualified service technician. The oven must be properly grounded in accordance with the National Electrical Code and applicable local codes.

Plug the unit into a properly grounded receptacle ONLY, positioning the unit so that the plug is easily accessible in case of an emergency. Arcing will occur when connecting or disconnecting the unit unless all controls are in the "OFF" position.

Proper receptacle or outlet configuration or permanent wiring for this unit must be installed by a licensed electrician in accordance with applicable local electrical codes.

| <b>ELECTRICAL - 767-SK/III</b> |       |           |      |      |  |                          |
|--------------------------------|-------|-----------|------|------|--|--------------------------|
| VOLTAGE                        | PHASE | CYCLE/ HZ | AMPS | kW   | CORD & PLUG  |                          |
| 208-240 (UL)                   | 1     | 60        | 16.0 | 3.85 | NO CORD<br>& PLUG  |                          |
| at 208                         | 1     | 60        | 15.5 | 3.21 |  |                          |
| at 240                         | 1     | 60        | 17.8 | 4.27 |  |                          |
| 230                            | 1     | 50        | 16.0 | 3.68 |  | CEE 7/7<br>220-230V PLUG |

| <b>ELECTRICAL - 1767-SK/III</b> |       |           |      |      |                   |  |
|---------------------------------|-------|-----------|------|------|-------------------|--|
| VOLTAGE                         | PHASE | CYCLE/ HZ | AMPS | kW   | CORD & PLUG       |  |
| 208-240 (UL)                    | 1     | 60        | 32.0 | 7.70 | NO CORD<br>& PLUG |  |
| at 208                          | 1     | 60        | 30.9 | 6.43 |                   |  |
| at 240                          | 1     | 60        | 35.6 | 8.55 |                   |  |
| 230                             | 1     | 50        | 34.1 | 7.86 | NO CORD<br>& PLUG |  |

| <b>ELECTRICAL - 2800-SK/III</b> |         |       |           |      |      |                |
|---------------------------------|---------|-------|-----------|------|------|----------------|
|                                 | VOLTAGE | PHASE | CYCLE/ HZ | AMPS | kW   | CORD & PLUG    |
| 1PH                             | 208     | 1     | 60        | 43.1 | 8.96 | CORD, NO PLUG  |
| 3PH                             | 208     | 3     | 60        | 27   | 8.96 | NO CORD & PLUG |
|                                 | 230     | 1     | 50        | 37.1 | 8.54 | NO CORD & PLUG |

### 230V:

To prevent an electrical shock hazard between the appliance and other appliances or metal parts in close vicinity, an equalization-bonding stud is provided. An equalization bonding lead must be connected to this stud and the other appliances / metal parts to provide sufficient protection against potential difference. The terminal is marked with the following symbol.





**NOTE:** The appliance must be connected to an electrical circuit that is protected by an external GFCI outlet.

DANGER



**ELECTRICAL CONNECTIONS MUST BE MADE BY A QUALIFIED SERVICE TECHNICIAN IN ACCORDANCE WITH APPLICABLE ELECTRICAL CODES.**

DANGER



**ENSURE POWER SOURCE MATCHES VOLTAGE STAMPED ON APPLIANCE NAMEPLATE.**

DANGER



**To avoid electrical shock, this appliance MUST be adequately grounded in accordance with local electrical codes or, in the absence of local codes, with the current edition of the National Electrical Code ANSI/NFPA No. 70. In Canada, all electrical connections are to be made in accordance with CSA C22.1, Canadian Electrical Code Part 1 or local codes.**



# OPERATING INSTRUCTIONS

## USER SAFETY INFORMATION

### CAUTION



**METAL PARTS OF THIS EQUIPMENT BECOME EXTREMELY HOT WHEN IN OPERATION. TO AVOID BURNS, ALWAYS USE HAND PROTECTION WHEN OPERATING THIS APPLIANCE.**

The Alto-Shaam cook and hold oven is intended for use in commercial establishments by qualified operating personnel where all operators are familiar with the purpose, limitations, and associated hazards of this appliance. Operating instructions and warnings must be read and understood by all operators and users.

## START-UP OPERATION

### BEFORE INITIAL USE:

Interior oven surfaces must be heated to remove surface oils and the accompanying odor produced during the first use of the oven.

1. Wipe all wire shelves, side racks and the full oven interior with a clean, damp cloth. Install the oven side racks, oven shelves, and external drip tray. Shelves are installed with the curved edge toward the back of the oven. Insert the drip pan on the interior bottom surface of the oven.
2.
  - Close the oven doors
  - Press and release control ON/OFF key.
  - Press the COOK key.
  - Press the up and down arrows to set the cooking temperature to 300°F (149°C).

3.
  - Press the TIME key.
  - Press the up and down arrows to set the cooking time to approximately 2 hours.
  - Allow the oven to cycle for approximately 2 hours or until no odor is detected.

### DANGER



**AT NO TIME SHOULD THE INTERIOR OR EXTERIOR BE STEAM CLEANED, HOSED DOWN, OR FLOODED WITH WATER OR LIQUID SOLUTION OF ANY KIND. DO NOT USE WATER JET TO CLEAN.**



**SEVERE DAMAGE OR ELECTRICAL HAZARD COULD RESULT.**

**WARRANTY BECOMES VOID IF APPLIANCE IS FLOODED**



### DANGER



**DISCONNECT UNIT FROM POWER SOURCE BEFORE CLEANING OR SERVICING.**

# OPERATING INSTRUCTIONS

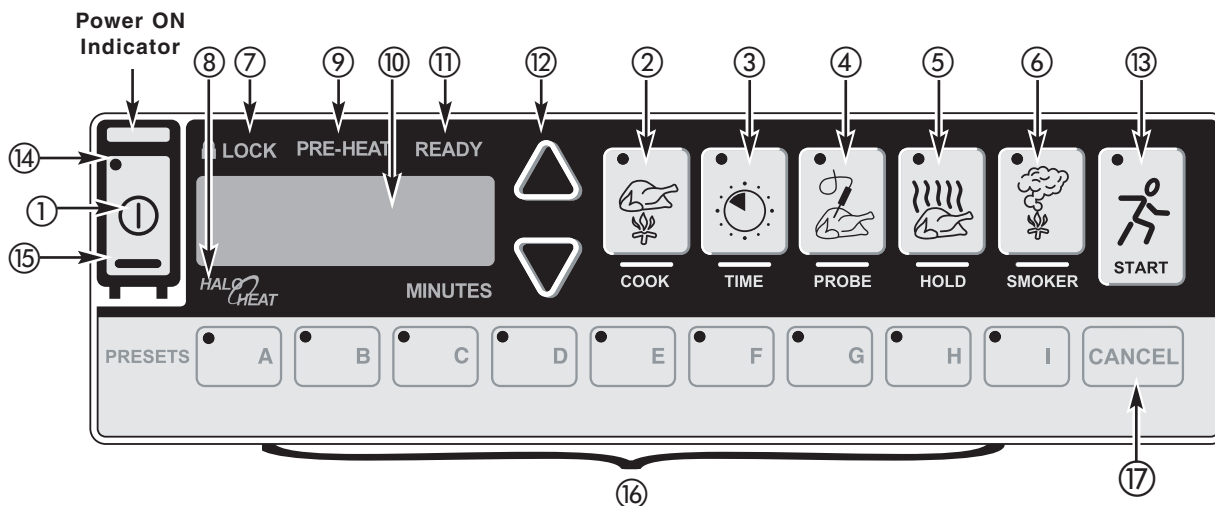

## CONTROL FEATURES

### 1. ON/ OFF Key

The ON/OFF control system key operates the functions of the control panel. If there is any power loss during operation, the ON/OFF indicator light will flash. To clear, push key and release.

### 2. COOK Key — Temperature range 200° to 325°F (93° to 162°C)

Used to select cooking mode and to review the cook temperature setting.

### 3. TIME Key — Maximum time 24 hours

Used to select cook time and to review set time.

### 4. PROBE Key — Temperature range 50° to 195°F (10° to 91°C)

Used to select internal product probe temperature mode and to review probe temperature setting.

### 5. HOLD Key — Temperature range 60° to 205°F (15° to 96°C)

Used to select food holding mode and to review set holding temperature.

### 6. SMOKER Key — Time range 0 to 24 hours

Used to select warm smoke or cold smoke and to review the smoke time remaining.

### 7. Lock Indicator

When illuminated, this symbol indicates settings used in the cooking sequence are locked and cannot be changed.

### 8. Halo Heat Indicator

When the oven is preheating, the Halo Heat indicator will illuminate during preheating and remain steady until the oven reaches the set cooking temperature. When the temperature has stabilized, the indicator will illuminate periodically as the oven calls for heat.

### 9. Oven Preheat Light

Illuminates until the oven is preheated.

### 10. LED Display

Indicates interior oven air temperature, internal product probe temperature, time, or when used in conjunction with other keys, will review original cooking, holding and probe temperature settings. The display will also indicate various programming and diagnostic information.

### 11. Ready Indicator Light

Illuminates when the oven has finished preheating.

### 12. UP and DOWN ARROWS

Used to increase or decrease set time, including cooking, holding and probe temperature settings.

### 13. START Key

Used to initiate a selected mode sequence when *pressed and released*. You may stop any mode of operation by *pressing and holding* the START Key until you hear a beep.

### 14. Green Indicator Lights

Located within each function key, the green light functions as an operator prompt indicating additional operator action is required and also identifies current mode of operation.

### 15. Amber Indicator Lights

Located below the COOK, TIME, PROBE and HOLD Keys, these indicators will illuminate to identify the current mode of operation and allows the operator to identify the information currently shown in the LED display.

### 16. PRESET Program Keys

Provides memory storage and operation of up to eight operator set cooking programs for specific products (A thru H). I enables locking abilities.

### 17. CANCEL Key

Used to erase a program from memory storage.

## IMPORTANT

Do not use the oven if the controls are not properly functioning. Refer to the Trouble Shooting Guide located in this manual or call an authorized service technician.

# OPERATING INSTRUCTIONS

## AUDIBLE SIGNALS



**OVEN BEEPING** is used to indicate a YES or NO response to operator input.

Beeps also indicate mode CHANGES and ERROR conditions.

*One brief beep* indicates a YES (enabled) response to the information entered into the control.

*Two brief beeps* indicate a NO (disabled) response to the information entered into the control.

*A beep that lasts for one second* indicates an oven mode TRANSITION. Example: Preheat to Ready-Start.

*Three brief beeps* indicate the oven is in the READY mode for product loading and START-UP.

*Four brief beeps* indicate an existing FAULT condition. Refer to the Trouble Shooting section of this manual.

Beeper volume can be changed. With the control in the OFF mode, press and hold the DOWN ARROW Key until the display exhibits one of the 4 volume levels (0 being OFF or the lowest, and 3 being the highest). After each change, the button must be released and the display must clear before the procedure can be repeated to select a different volume level.

## OPERATING FEATURES & FUNCTIONS

### Turn the Oven Control Panel Off:

*Press and hold* the ON/OFF Key until the oven beeps. The ON/OFF indicator light will go out.

### Stop an Operation:

*Press and hold* the START Key for several seconds until the control beeps, indicating the operation has been cancelled. The oven will remain in a power-on state.

### Arrow Keys:

**Cook, Hold and Probe Temperature** set points can be adjusted by 1° when pressing the ARROW Keys. To change a set point more rapidly, *press and hold* the ARROW Key along with the key for the temperature function, and the temperature changes in steps of 10°F or 5°C.

The **Time** setting is adjusted in increments of one minute by pressing the ARROW Keys. To make adjustment in steps of ten minutes, *press and hold* the TIME Key and ARROW Key at the same time.

### Probe Usage:

**NOTE:** When cooking by probe, insert the probe into the raw product after the oven has been preheated. **WAIT ONE FULL MINUTE** to allow the probe temperature to decrease to the internal temperature of the product. Press the start button to begin the cooking process after this probe temperature adjustment period. A false probe reading of the internal product temperature will cause the oven to default to a holding temperature.

When the oven probe remains inserted in the probe bracket, the LED temperature display will indicate the ambient air temperature inside the oven. To use the probe for cooking remove it from the bracket and wipe the full length of the metal probe with a disposable alcohol pad to clean and sanitize before using.

Only the tip of the probe senses the internal product temperature; therefore, it is important the tip be placed correctly in the product for internal temperature accuracy. Push the probe tip halfway into the product, positioning the tip at the center of the food mass. When inserting the probe into solid foods such as meat roast or poultry breasts, push the probe in from a straight downward position or in from the side to the center position. If placing into a semi-liquid or liquid product, the probe cable must be secured to keep the probe positioned properly. Do not let the probe tip touch the edges, bottom or side of a container. Tape the probe cable to the lip or edge of the container.

### Display High/ Low Probe Temperatures:

To observe the recorded maximum or minimum probe temperature when cooking by probe, press the following keys while the probe remains in the product:

**Highest Temperature:** Press PROBE Key and UP ARROW Key at same time.

**Lowest Temperature:** Press PROBE Key and DOWN ARROW Key at same time.

### Halo Heat Indicator:

When the oven is preheating the Halo Heat indicator light will remain illuminated until it reaches the set cook temperature. Once the temperature has stabilized, this indicator will illuminate periodically as the oven calls for heat.

### Green and Amber Indicators:

Each program key includes a green light which indicates a requirement for additional programming by the operator or the current operational state of the oven.

The COOK, TIME, PROBE, and HOLD keys include an amber indicator light to identify the information being displayed.

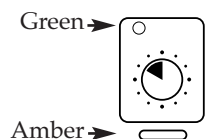

### Power Fail Detect:

If the power were to fail for any reason while heating, the control will retain, in memory, the programmed operating conditions. When power is restored, the control will resume operating from the point where it was interrupted and the ON/OFF indicator light will flash, indicating that such an event did occur. The operator can turn off the flashing light by pressing the ON/OFF key.

**NOTE:** *If such an event has occurred, it is strongly recommended that you ensure the food is safe for consumption according to local health regulations.*

# OPERATING INSTRUCTIONS

## Preparation

Adjust the inside door vents per the individual cooking procedure selected. Always keep door vents closed when cooking with the smoking function. Insert drip pan on the bottom of the oven cavity.



Wood Chip Tray

## Wood Chips

Soak one full tray of wood chips in water for 5 to 10 minutes. Shake off excess water, and place the moistened chips in the wood chip tray of the smoker oven. Replace the container in the oven.

## WARNING



**THE USE OF IMPROPER MATERIALS FOR THE SMOKING FUNCTION COULD RESULT IN DAMAGE, HAZARD, EQUIPMENT FAILURE OR COULD REDUCE THE OVERALL LIFE OF THE OVEN.**

**DO NOT USE SAWDUST FOR SMOKING.**

**DO NOT USE WOOD CHIPS SMALLER THAN THUMBNAIL SIZE.**

## Hot Smoke Procedure



Press and release power switch ON/OFF Control Key.



▲ Press and set COOK thermostat to required cooking temperature.



Press and set TIME or PROBE.



▲ Press and set HOLD thermostat to required holding temperature.



The Oven is automatically programmed to preheat to the set cooking temperature. The oven will produce an audible signal when fully preheated.

Prepare product for cooking.  
Load product on shelves.



### To Set Smoking time

▲ By TIME



▼ Press the SMOKER Key.  
Press the UP and DOWN ARROW KEYS to select the smoke time in minutes.  
Press START.

*Note: The smoking timer activates the heating element located within the wood chip container. A full wood chip container will produce smoke for a period of approximately 1 hour, even though the timer can go past one hour.*

## Cold Smoke Procedure



Press and release power switch ON/OFF Control Key.



Press and hold the SMOKER Key for a period of 5 seconds. Holding the SMOKER Key for 5 seconds will set the oven to a default temperature of 32°F (0°C) to prevent the oven from producing heat.

Prepare product for smoking.  
Place stainless steel tray filled with ice on shelf above the smoker tray.  
Load product on shelves.

### To Set Smoking time



By Time



▲ Press the SMOKER Key.  
▼ Press the UP and DOWN ARROW KEYS to select the smoke time in minutes.  
Press START.

*Holding the SMOKER KEY for 5 seconds will set the oven to a default temperature of 32°F (0°C) to prevent the oven from producing heat. To increase this default temperature, press the HOLD KEY and press the UP ARROW to set a higher default temperature.*

| Taste preference         | Minimum Smoking time |
|--------------------------|----------------------|
| Light Smoke Flavor       | 10 min.              |
| Medium Smoke Flavor      | 30 min.              |
| Heavy Smoke Flavor       | 40 min.              |
| Very Heavy Smoke Flavor  | 60 min.              |
| Extra Heavy Smoke Flavor | 80 min.              |

*For maximum product tenderizing and to reduce labor during peak preparation hours, products can be cooked and held overnight.*

*These instructions are basic operational guidelines only. For complete instructions, see the HALO HEAT Guide to Low Temperature Cooking and Holding provided with the oven.*

# OPERATING INSTRUCTIONS

## Preset Menu Keys:

This Alto-Shaam oven allows the operator to set up to eight cook/smoke programs. Each program can be preset in any program mode to cook/smoke by time or internal product temperature. Programs are recalled and stored using the PRESET Keys labeled "A through H." These keys, along with the key labeled "I", share additional functions described in the "User Options" section of this manual.

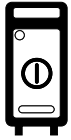

### Programming a Cook/Smoke Program

Select the product to be programmed and begin programming with the oven control power OFF. Press and release control ON/OFF key. The oven will beep for one second and power to the unit will be indicated by an illuminated green indicator light located in the upper left corner of the ON/OFF key. The oven will begin operating in the hold mode. The amber HOLD indicator will be illuminated and the last set hold temperature will be displayed.



**Press HOLD Key.** To change the hold temperature, press the UP or DOWN ARROW Key.



**Press COOK Key.** Oven preheat indicator will illuminate and the last set cooking temperature is displayed. To change the cook temperature, press the UP or DOWN ARROW Keys.



**To cook by time** — press the TIME Key. Last set cooking time is displayed. To change the set time, press the UP or DOWN ARROW Key. The green TIME indicator will illuminate.



**To cook by probe** — press the PROBE Key. Last set internal product temperature is displayed. To change the set temperature, press the UP or DOWN ARROW Key. The green PROBE indicator will illuminate.



**Press SMOKER Key.** To set the smoke time desired, use UP or DOWN ARROW key. The last set time will be displayed.

— or —

---

The oven preheat indicator will illuminate. Oven is now in the preheat mode and is automatically programmed to preheat to the cook temperature.

---



---

Select a letter code for the product programmed by the previous steps. Press and hold the selected PRESET key until you hear a brief, four second beep. The letter key program indicator light will illuminate and the product programmed is now stored in memory for the specific letter key pressed. Additional programs can be stored in the remaining PRESET Keys if not previously programmed.

---



---

**Note:** The last PRESET Key used will be the oven cooking run sequence for the next product to be programmed. Settings can be manually changed for the next product and an alternate pre-programmed letter key selected.

---

### Erasing a Cook/Smoke Program

To erase a program, the oven must be in either the power-up hold mode or in the preheat mode. The oven cannot be running a PRESET Menu program.

When the oven is in the power-up hold mode or in the preheat mode, press and hold both the CANCEL Key and the appropriate letter PRESET Key to be erased. The oven will beep in approximately four seconds and the program's indicator light will go out to indicate the program has been erased.

**IMPORTANT - After programming a specific product into memory in a programmable preset key, it is very important to make a written permanent record of the product and the program letter assigned. Menu card (PE-23384) is provided for this purpose.**



# OPERATING INSTRUCTIONS

## Cook/Smoke Using Preset Menu Keys:



Press and release control ON/ OFF key.

- The green indicator light on the ON/OFF Key will illuminate.
- The oven will beep for one second.
- The oven will begin operating in the hold mode.
- The amber hold indicator will illuminate.
- The previously set hold temperature will be displayed.
- PRESET Keys with stored cooking programs will have green indicator illuminated.

### CAUTION

TO MAINTAIN SAFE TEMPERATURE LEVELS, COLD FOOD FOR RETHERMALIZATION OR REHEATING MUST NEVER BE ADDED TO THE OVEN WHILE HOT FOODS ARE BEING HELD.



Press Desired PRESET Key (A through H)

- Halo Heat and Pre-Heat indicator will illuminate.
  - ➔ The oven is automatically programmed to preheat to the cook temperature programmed.
- The oven will beep when preheated and the preheat indicator will go out.
- Both the Ready and Start indicator lights will flash.
  - ➔ The set cook temperature will be maintained by the oven and appear in the display while in the ready/start mode.

*Load the food inside oven. If cooking by probe, remove probe from its bracket, wipe the probe tip with a disposable alcohol pad and insert probe properly into product. Close the oven door.*



**Note:** The oven will beep 3 times every 25 seconds until the oven is loaded and the START Key pressed.



Press and release START Key.

### COOK

- The oven will beep.
- The green indicators for power, cook, smoke, probe or time, and start will illuminate.
- If programmed to cook by time, the display will alternate between showing the set cook temperature and the time remaining.
- If programmed to cook by probe, the display will alternate between showing the set cook temperature and the elapsed time.

### HOLD

- The oven will beep when the set probe temperature has been reached or set time has elapsed.
- The green indicator for cook will remain illuminated.
- The display will alternate between showing the set hold temperature and the amount of time the product has remained in the holding mode.
- The Ready indicator light will illuminate after 2 hours in the hold mode.

**Note:** The ready indicator does not necessary indicate a product-ready state. For best results, the product must remain in the oven at the set holding temperature for the minimum number of hours indicated in the individual cooking instructions.

- The oven will remain operating in the hold mode until the control ON/OFF Key is pressed.

# OPERATING INSTRUCTIONS

## USER OPTIONS

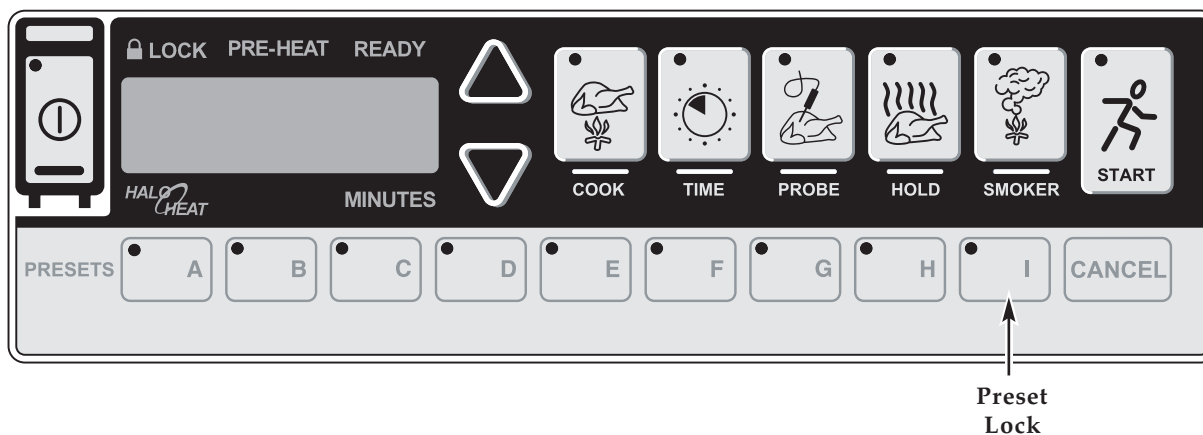

### PRESET Keys Lock and Unlock

PRESET Keys A through H can be locked in order to prevent storing, altering or erasing a program.

To lock the PRESET Keys, press and hold the "I" Key until the oven beeps. Release the "I" key. The green indicator on the "I" key will illuminate. Oven PRESET Keys A through H are now locked.

*Note:* Only the oven PRESET keys A through H are affected by this lock-out in order to also allow the oven to be used with the unprogrammed Cook, Probe, or Hold modes.

To unlock the PRESET Keys, press and hold the CANCEL Key along with the "I" Key until you hear a brief beep. Release all keys. The green indicator on the "I" key will extinguish. The oven preset keys are now unlocked.

### Fahrenheit or Celsius Selection

With the control in the *off mode*, **press and hold** the UP ARROW Key until the display toggles between Fahrenheit and Celsius. After each change the button must be released. The display must clear before the procedure can be repeated.

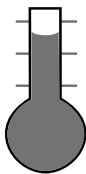

### Control Panel Lock and Unlock

The control panel can be locked at any time in order to prevent inadvertent or accidental setting changes.

To lock the control panel, **press and hold** the UP ARROW Key and then press the ON/OFF Key.

You will hear a brief beep and the panel lock indicator will illuminate. Release all keys. The oven's control panel is now locked.



*Note:* The control panel is now fully locked with the exception of the ON/OFF Key and ARROW keys. You will be unable to turn the oven control off at this point.

To unlock the control panel, **press and hold** the DOWN ARROW Key and then press the ON/OFF Key. You will hear two brief beeps and the panel lock indicator will extinguish. Release all keys. The panel is now unlocked and ready for normal use.

### Beeper Volume Selection

With the control in the *off mode*, **press and hold** the DOWN ARROW Key until the display shows one of the 4 volume levels (0 being OFF or the lowest, and 3 being the highest). After each change, the button must be released and the display must clear before the procedure can be repeated to select a different volume level.



# OPERATING INSTRUCTIONS

## General Holding Guideline

Chefs, cooks and other specialized food service personnel employ varied methods of cooking. Proper holding temperatures for a specific food product must be based on the moisture content of the product, product density, volume, and proper serving temperatures. Safe holding temperatures must also be correlated with palatability in determining the length of holding time for a specific product.

Halo Heat maintains the maximum amount of product moisture content without the addition of water, water vapor, or steam. Maintaining maximum natural product moisture preserves the natural flavor of the product and provides a more genuine taste. In addition to product moisture retention, the gentle properties of Halo Heat maintain a consistent temperature throughout the cabinet without the necessity of a heat distribution fan, thereby preventing further moisture loss due to evaporation or dehydration.

When product is removed from a high temperature cooking environment for immediate transfer into equipment with the lower temperature required for hot food holding, condensation can form on the outside of the product and on the inside of plastic containers used in self-service applications. Allowing the product to release the initial steam and heat produced by high temperature cooking can alleviate this condition. To preserve the safety and quality of freshly cooked foods, however, a maximum of 1 to 2 minutes must be the only time period allowed for the initial heat to be released from the product.

Most Halo Heat Holding Equipment is provided with a thermostat control between 60° and 200°F (16° to 93°C). If the unit is equipped with vents, close the vents for moist holding and open the vents for crisp holding.

| HOLDING TEMPERATURE RANGE  |              |            |
|--|--------------|------------|
| MEAT   | FAHRENHEIT   | CELSIUS    |
| BEEF ROAST — Rare  | 130°F        | 54°C       |
| BEEF ROAST — Med/Well Done   | 155°F        | 68°C       |
| BEEF BRISKET   | 160° — 175°F | 71° — 79°C |
| CORN BEEF  | 160° — 175°F | 71° — 79°C |
| PASTRAMI   | 160° — 175°F | 71° — 79°C |
| PRIME RIB — Rare   | 130°F        | 54°C       |
| STEAKS — Broiled/Fried   | 140° — 160°F | 60° — 71°C |
| RIBS — Beef or Pork  | 160°F        | 71°C       |
| VEAL   | 160° — 175°F | 71° — 79°C |
| HAM  | 160° — 175°F | 71° — 79°C |
| PORK   | 160° — 175°F | 71° — 79°C |
| LAMB   | 160° — 175°F | 71° — 79°C |
| POULTRY  |              |            |
| CHICKEN — Fried/Baked  | 160° — 175°F | 71° — 79°C |
| DUCK   | 160° — 175°F | 71° — 79°C |
| TURKEY   | 160° — 175°F | 71° — 79°C |
| GENERAL  | 160° — 175°F | 71° — 79°C |
| FISH/SEAFOOD   |              |            |
| FISH — Baked/Fried   | 160° — 175°F | 71° — 79°C |
| LOBSTER  | 160° — 175°F | 71° — 79°C |
| SHRIMP — Fried   | 160° — 175°F | 71° — 79°C |
| BAKED GOODS  |              |            |
| BREADS/ROLLS   | 120° — 140°F | 49° — 60°C |
| MISCELLANEOUS  |              |            |
| CASSEROLES   | 160° — 175°F | 71° — 79°C |
| DOUGH — Proofing   | 80° — 100°F  | 27° — 38°C |
| EGGS — Fried   | 150° — 160°F | 66° — 71°C |
| FROZEN ENTREES   | 160° — 175°F | 71° — 79°C |
| HORS D'OEUVRES   | 160° — 180°F | 71° — 82°C |
| PASTA  | 160° — 180°F | 71° — 82°C |
| PIZZA  | 160° — 180°F | 71° — 82°C |
| POTATOES   | 180°F        | 82°C       |
| PLATED MEALS   | 140° — 165°F | 60° — 74°C |
| SAUCES   | 140° — 200°F | 60° — 93°C |
| SOUP   | 140° — 200°F | 60° — 93°C |
| VEGETABLES   | 160° — 175°F | 71° — 79°C |
| <b>THE HOLDING TEMPERATURES LISTED ARE SUGGESTED GUIDELINES ONLY. ALL FOOD HOLDING SHOULD BE BASED ON INTERNAL PRODUCT TEMPERATURES. ALWAYS FOLLOW LOCAL HELATH (HYGIENE) REGULATIONS FOR ALL INTERNAL TEMPERATURE REQUIREMENTS.</b> |              |            |

# CARE AND CLEANING

## CLEANING AND PREVENTIVE MAINTENANCE

### PROTECTING STAINLESS STEEL SURFACES



It is important to guard against corrosion in the care of stainless steel surfaces. Harsh, corrosive, or inappropriate chemicals can completely destroy the protective surface layer of stainless steel.

Abrasive pads, steel wool, or metal implements will abrade surfaces causing damage to this protective coating and will eventually result in areas of corrosion. Even water, particularly hard water that contains high to moderate concentrations of chloride, will cause oxidation and pitting that result in rust and corrosion. In addition, many acidic foods spilled and left to remain on metal surfaces are contributing factors that will corrode surfaces.

Proper cleaning agents, materials, and methods are vital to maintaining the appearance and life of this appliance. Spilled foods should be removed and the area wiped as soon as possible but at the very least, a minimum of once a day. Always thoroughly rinse surfaces after using a cleaning agent and wipe standing water as quickly as possible after rinsing.

### CLEANING AGENTS

Use non-abrasive cleaning products designed for use on stainless steel surfaces. Cleaning agents must be chloride-free compounds and must not contain quaternary salts. Never use hydrochloric acid (muriatic acid) on stainless steel surfaces. Always use the proper cleaning agent at the manufacturer's recommended strength. Contact your local cleaning supplier for product recommendations.

### CLEANING MATERIALS

The cleaning function can usually be accomplished with the proper cleaning agent and a soft, clean cloth. When more aggressive methods must be employed, use a non-abrasive scouring pad on difficult areas and make certain to scrub with the visible grain of surface metal to avoid surface scratches. Never use wire brushes, metal scouring pads, or scrapers to remove food residue.

|  <b>CAUTION</b>            |   |
|---|---|
| <br><b>NO SCRAPERS</b>     | <b>TO PROTECT STAINLESS STEEL SURFACES, COMPLETELY AVOID THE USE OF ABRASIVE CLEANING COMPOUNDS, CHLORIDE BASED CLEANERS, OR CLEANERS CONTAINING QUATERNARY SALTS. NEVER USE HYDROCHLORIC ACID (MURIATIC ACID) ON STAINLESS STEEL. NEVER USE WIRE BRUSHES, METAL SCOURING PADS OR SCRAPERS.</b> |
| <br><b>NO WIRE BRUSHES</b> |   |
| <br><b>NO STEEL PADS</b>   |   |

# CARE AND CLEANING

## EQUIPMENT CARE

Under normal circumstances, this oven should provide you with long and trouble free service. There is no preventative maintenance required, however, the following Equipment Care Guide will maximize the potential life and trouble free operation of this oven.



The cleanliness and appearance of this equipment will contribute considerably to operating efficiency and savory, appetizing food. Good equipment that is kept clean works better and lasts longer.

### CLEAN DAILY

1. Disconnect unit from power source, and let cool.
2. Remove all detachable items such as wire shelves, side racks, and drip pans. Clean these items separately.
3. Wipe the interior metal surfaces of the oven with a paper towel to remove loose food debris.
4. Clean the interior metal surfaces of the cabinet with a damp clean cloth or sponge and any good commercial detergent.



**NOTE:** Avoid the use of abrasive cleaning compounds, chloride based cleaners, or cleaners containing quaternary salts. Never use hydrochloric acid (muriatic acid) on stainless steel.

5. Spray heavily soiled areas with a water soluble degreaser and let stand for 10 minutes, then remove soil with a plastic scouring pad.
6. Wipe control panel, door vents, door handles, and door gaskets thoroughly since these areas harbor food debris.
7. Rinse surfaces by wiping with sponge and clean warm water.
8. Remove excess water with sponge and wipe dry with a clean cloth or air dry. Leave doors open until interior is completely dry. Replace side racks and shelves.
9. Wipe door gaskets and control panel dry with a clean, soft cloth.
10. Interior can be wiped with a sanitizing solution after cleaning and rinsing. This solution must be approved for use on stainless steel food contact surfaces.

11. To help maintain the protective film coating on polished stainless steel, clean the exterior of the cabinet with a cleaner recommended for stainless steel surfaces. Spray the cleaning agent on a clean cloth and wipe with the grain of the stainless steel.
12. Clean any glass with a window cleaner. Always follow appropriate state or local health (hygiene) regulations regarding all applicable cleaning and sanitation requirements for equipment.

### CLEAN THE DOOR VENTS

Door vents need to be inspected and cleaned as required.

### CLEAN THE PROBES DAILY

Remove all food soil from probes. Wipe entire probe and cable assembly with warm detergent solution and a clean cloth. Remove detergent by wiping each probe and cable with clean rinse water and a cloth. Wipe probes and probe brackets with disposable alcohol pad or sanitizing solution recommended for food contact surfaces. Allow probe and cable to air dry in probe holding bracket.

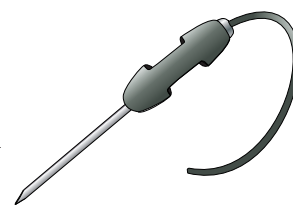

### CHECK THE COOLING FAN IN THE OVEN CONTROL AREA

While the oven is warm, check that the cooling fan in the oven control area is functioning. The fan is located at the back of the unit, toward the top.

### CHECK OVERALL CONDITION OF OVEN ONCE A MONTH

Check the oven once a month for physical damage and loose screws. Correct any problems before they begin to interfere with the operation of the oven.

## DANGER



**AT NO TIME SHOULD THE INTERIOR OR EXTERIOR BE STEAM CLEANED, HOSED DOWN, OR FLOODED WITH WATER OR LIQUID SOLUTION OF ANY KIND. DO NOT USE WATER JET TO CLEAN.**



**SEVERE DAMAGE OR ELECTRICAL HAZARD COULD RESULT.**

**WARRANTY BECOMES VOID IF APPLIANCE IS FLOODED**



## DANGER



**DISCONNECT UNIT FROM POWER SOURCE BEFORE CLEANING OR SERVICING.**

**DO NOT USE OVEN IF CONTROLS ARE NOT PROPERLY FUNCTIONING**

Refer to the Trouble Shooting Guide located in this manual or call an authorized service technician.

Food flavor and aroma are usually so closely related that it is difficult, if not impossible, to separate them. There is also an important, inseparable relationship between cleanliness and food flavor. Cleanliness, top operating efficiency, and appearance of equipment contribute considerably to savory, appetizing foods. Good equipment that is kept clean, works better and lasts longer.

Most food imparts its own particular aroma and many foods also absorb existing odors. Unfortunately, during this absorption, there is no distinction between GOOD and BAD odors. The majority of objectionable flavors and odors troubling food service operations are caused by bacteria growth. Sourness, rancidity, mustiness, stale or other OFF flavors are usually the result of germ activity.

The easiest way to insure full, natural food flavor is through comprehensive cleanliness. This means good control of both visible soil (dirt) and invisible soil (germs). A thorough approach to sanitation will provide essential cleanliness. It will assure an attractive appearance of equipment, along with maximum efficiency and utility. More importantly, a good sanitation program provides one of the key elements in the prevention of food-borne illnesses.

A controlled holding environment for prepared foods is just one of the important factors involved in the prevention of food-borne illnesses. Temperature monitoring and control during receiving, storage, preparation, and the service of foods are of equal importance.

The most accurate method of measuring safe temperatures of both hot and cold foods is by internal product temperature. A quality thermometer is an effective tool for this purpose, and should be routinely used on all products that require holding at a specific temperature.

A comprehensive sanitation program should focus on the training of staff in basic sanitation procedures. This includes personal hygiene, proper handling of raw foods, cooking to a safe internal product temperature, and the routine monitoring of internal temperatures from receiving through service.

Most food-borne illnesses can be prevented through proper temperature control and a comprehensive program of sanitation. Both these factors are important to build quality service as the foundation of customer satisfaction. Safe food handling practices to prevent food-borne illness is of critical importance to the health and safety of your customers.

HACCP, an acronym for Hazard Analysis (at) Critical Control Points, is a quality control program of operating procedures to assure food integrity, quality, and safety. Taking steps necessary to augment food safety practices are both cost effective and relatively simple. While HACCP guidelines go far beyond the scope of this manual, additional information is available by contacting:

**CENTER FOR FOOD SAFETY AND APPLIED  
NUTRITION FOOD AND DRUG ADMINISTRATION  
1-888-SAFEFOOD**

| INTERNAL FOOD PRODUCT TEMPERATURES |               |                  |
|------------------------------------|---------------|------------------|
| <b>HOT FOODS</b>                   |               |                  |
| DANGER ZONE                        | 40° TO 140°F  | (4° TO 60°C)     |
| CRITICAL ZONE                      | 70° TO 120°F  | (21° TO 49°C)    |
| SAFE ZONE                          | 140° TO 165°F | (60° TO 74°C)    |
| <b>COLD FOODS</b>                  |               |                  |
| DANGER ZONE                        | ABOVE 40°F    | (ABOVE 4°C)      |
| SAFE ZONE                          | 36°F TO 40°F  | (2°C TO 4°C)     |
| <b>FROZEN FOODS</b>                |               |                  |
| DANGER ZONE                        | ABOVE 32°F    | (ABOVE 0°C)      |
| CRITICAL ZONE                      | 0° TO 32°F    | (-18° TO 0°C)    |
| SAFE ZONE                          | 0°F or below  | (-18°C or below) |

# SERVICE

## TROUBLE SHOOTING

| Error Code | Description/Results  | Possible Cause<br>Service Required   |
|------------|--|--|
| E-10       | <b>Air Sensor Fault (shorted)</b><br><i>Inoperative Oven</i>               | Air sensor is shorted.<br>Air sensor defective? See following page for air sensor test.  |
| E-11       | <b>Air Sensor Fault (open)</b><br><i>Inoperative Oven</i>                  | Air sensor is open or connection failure.<br>Air sensor defective? See following page for air sensor test.   |
| E-20       | <b>Product Probe Fault (shorted)</b><br><i>Oven will cook in time only</i> | Product probe is shorted<br>Probe defective? See following page for probe sensor test.   |
| E-21       | <b>Product Probe Fault (open)</b><br><i>Oven will cook in time only</i>    | Product Probe is open or connection failure.<br>Probe defective? See following page for probe sensor test.   |
| E-30       | <b>Under temperature</b><br><i>Oven will not reach set temperature</i>     | Oven door closed? Door gasket need replacement? Preheat skipped?<br>Oven overloaded or has frozen product? Defective air sensor or probe?<br>Defective solid state relay? Bad wire connections or open heating cable?<br>Is the high limit switch tripped? If none of the above, call service.   |
| E-31       | <b>Over temperature</b><br><i>Oven will shut down</i>                      | Shorted cable? Defective solid state relay? Defective air sensor?<br>If none of the above, call service.   |
| E-60       | <b>Real time clock error</b><br><i>Inoperative Oven</i>                    | Control must be replaced.<br>This error also is displayed if the unit has been unplugged for more than 30 days. If this is the case the unit should be plugged in with the circuit breaker on and the unit displaying the E-60 on the front panel for more than 30 minutes. Once this has been accomplished the circuit breaker should be turned to off or the unit unplugged for about 10 seconds after which the unit should be turned on again. This may have to be repeated. |
| E-70       | <b>Configuration connector error</b><br><i>Inoperative Oven</i>            | Check control connections for loose wires. If none, control must be replaced.  |
| E-78       | <b>Voltage low</b><br><i>Inoperative Oven</i>                              | If 125 VAC unit, voltage is below 90 VAC. Correct.<br>If 208-240 VAC voltage is below 190 VAC. Correct.  |
| E-79       | <b>Voltage high</b><br><i>Inoperative Oven</i>                             | If 125 VAC unit, voltage is over 130 VAC. Correct.<br>If 208-240 VAC, voltage is over 250 VAC. Correct.  |
| E-80       | <b>EEPROM - Function data error</b><br><i>Inoperative Oven</i>             | Contact Service.   |
| E-82       | <b>EEPROM - Calibration data error</b><br><i>Inoperative Oven</i>          | Contact Service.   |
| E-84       | <b>EEPROM - Unit ID error</b><br><i>Inoperative Oven</i>                   | Contact Service.   |
| E-86       | <b>EEPROM - Preset data error</b><br><i>Inoperative Oven</i>               | Contact Service.   |

### CAUTION

THIS SECTION IS PROVIDED FOR THE ASSISTANCE OF QUALIFIED SERVICE TECHNICIANS ONLY AND IS NOT INTENDED FOR USE BY UNTRAINED OR UNAUTHORIZED SERVICE PERSONNEL.



### DANGER



**DISCONNECT UNIT FROM POWER SOURCE BEFORE CLEANING OR SERVICING.**

*This section is provided for the assistance of qualified technicians only and is not intended for use by untrained or unauthorized service personnel. If your Alto-Shaam® unit is not operating properly, check the following before calling your Authorized Alto-Shaam® Service Agent:*

- Check the power flow to the unit. Plug in outlet? Circuit breaker switch at back of unit turned on? *Do not attempt to repair or service the Cook and Hold unit beyond this point. Contact Alto-Shaam® for the nearest authorized service agent. Repairs made by any other service agents without prior authorization by Alto-Shaam® will void the warranty on the unit.*

## TROUBLE SHOOTING INTERNAL ELECTRICAL COMPONENTS

### A. No power. Display will not light.

1. Verify that power is available at the outlet or junction box.
2. Verify that the circuit breaker switch on the back of the unit is turned on.
3. Verify that the power cord is not open. Check continuity with a VOM meter.
4. If none of the above steps help, call a qualified service technician or refer to the Service Manual for this particular oven.

### B. Display is lit and unit calls for heat, but unit is not heating; Error Code E30

Check to verify that the high limit switch located at the rear of the unit top has not been tripped. If it has been tripped, reset by pressing in the hit limit reset button at the rear of the oven.

After resetting, the cause of the high limit trip must be corrected. If the high limit switch will not reset, the high limit switch is defective and must be replaced. *This is a safety device and must not be jumped out or removed from the circuit.*



### C. To test air sensor:

Test air sensor by placing sensor in ice water bath and using an ohmmeter set on the ohm scale. The reading should be 100 ohms resistance. If it is more than 2 ohms higher or lower, sensor needs to be replaced.

### D. To test probe sensor:

Test food probe by placing in ice water bath and using an ohmmeter set on the ohm scale. The reading should be 100 ohms resistance.

## DANGER

**DISCONNECT UNIT FROM  
POWER SOURCE BEFORE  
CLEANING OR SERVICING.**

## CAUTION

**THIS SECTION IS PROVIDED FOR THE ASSISTANCE  
OF QUALIFIED SERVICE TECHNICIANS ONLY AND  
IS NOT INTENDED FOR USE BY UNTRAINED OR  
UNAUTHORIZED SERVICE PERSONNEL.**

## NOTE

**If the appliance has been unplugged for an  
extended period of time, the Real Time  
Clock may require recharging. Plug the unit  
into the proper receptacle for a minimum of  
24 hours.**



# SERVICE

## EXTERIOR SERVICE VIEW 767-SK/III & 1767-SK/III

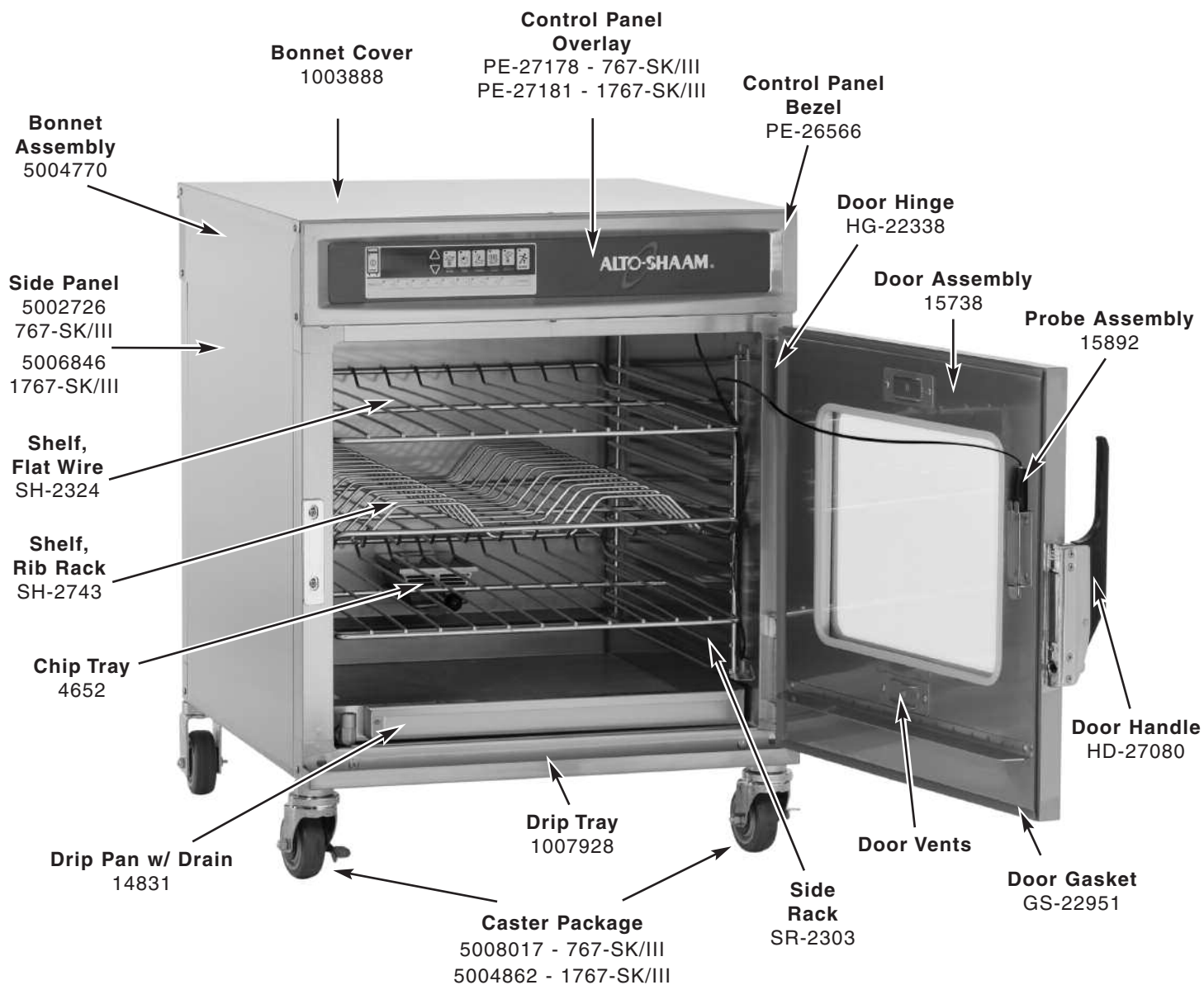

## EXTERIOR SERVICE PARTS LIST 767-SK/III & 1767-SK/III

| Part Description  | Qty.<br>767-SK/III | Qty.<br>1767-SK/III | Part<br>Number |
|---|--------------------|---------------------|----------------|
| 1. Bonnet Assembly  | 1                  | 1                   | .5004770       |
| 2. Bonnet Cover   | 1                  | 1                   | .1003888       |
| 3. Caster Package, 3-1/2" (89mm) 2 RIGID, 2 SWIVEL W/ BRAKE | 1                  | —                   | .5008017       |
| Caster Package, 5" (127mm) 2 RIGID, 2 SWIVEL W/ BRAKE       | —                  | 1                   | .5004862       |
| 4. Chip Tray  | 1                  | 2                   | .4652          |
| Chip Tray Cover   | 1                  | 2                   | .1021          |
| Chip Tray Handle  | 1                  | 2                   | .HD-2724       |
| Chip Tray Insert  | 1                  | 2                   | .1243          |
| 5. Control Panel Bezel                                      | 1                  | 1                   | .PE-26566      |
| 6. Control Panel Overlay                                    | 1                  | —                   | .PE-27178      |
| Control Panel Overlay                                       | —                  | 1                   | .PE-27181      |
| 7. Door Assembly, Left-Hand with Window                     | 1                  | 2                   | .15741         |
| Door Assembly, Right-Hand with Window                       | 1                  | 2                   | .15738         |
| 8. Drip Pan with drain                                      | 1                  | 2                   | .14831         |
| 9. Drip Tray (not shown)                                    | 1                  | 1                   | .1008772       |
| Drip Tray Holder  | 1                  | 1                   | .1008771       |
| 10. Gasket, Door  | 1                  | 2                   | .GS-22951      |
| 11. Handle, Door  | 1                  | 2                   | .HD-27080      |
| 12. Hinge, Door   | 1 pair             | 2 pair              | .HG-22338      |
| 13. Panel, Back   | 1                  | 2                   | .1006710       |
| 14. Panel, Sides  | 2                  | —                   | .5002726       |
| Panel, Sides  | —                  | 2                   | .5006846       |
| 15. Probe Assembly  | 1                  | 2                   | .15892         |
| 16. Probe Holder  | 1                  | 2                   | .13239         |
| 17. Shelf, S/S Wire   | 2                  | 4                   | .SH-2324       |
| 18. Shelf, Rib Rack   | 1                  | 2                   | .SH-2743       |
| 19. Side Rack, S/S  | 2                  | 4                   | .SR-2303       |
| Pan Slide, S/S (230V)                                       | 2                  | 4                   | .5008240       |
| 20. Smoker Element Repair Kit                               | 1                  | 2                   | .5003782       |
| 21. Switch Cover, Hi-Limit                                  | 1                  | 1                   | .1003936       |



# SERVICE

## ELECTRONIC COMPONENTS

### Unit Front

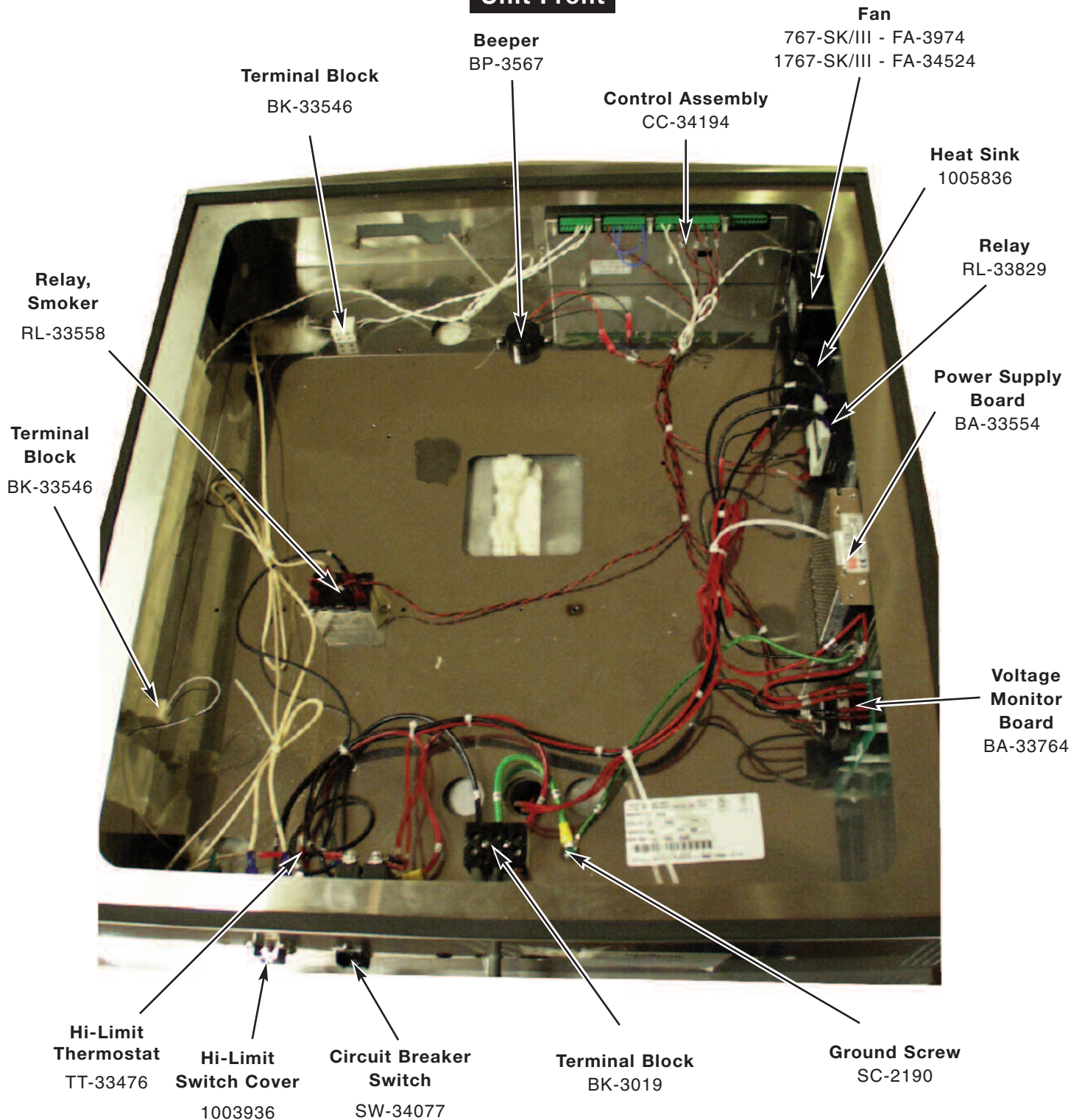

767-SK/III, 208-240V Unit Shown\*  
\*see following page for 230V part numbers

## ELECTRONIC COMPONENTS PARTS LIST

| Part Description                            | Qty.<br>767-SK/III | Qty.<br>1767-SK/III | Part Number |
|---|--------------------|---------------------|-------------|
| 1. Beeper .....                             | .1                 | .1                  | .BP-3567    |
| 2. Circuit Board .....                      | .1                 | .1                  | .BA-33991   |
| 3. Circuit Breaker Switch, 767-SK/III ..... | .1                 | —                   | .SW-34077   |
| Circuit Breaker Switch, 1767-SK/III .....   | —                  | .1                  | .SW-34076   |
| 4. Control Assembly .....                   | .1                 | .1                  | .CC-34194   |
| 5. Cordset, 230V .....                      | .1                 | —                   | .CD-3922    |
| 6. Fan, Box, 767-SK/III .....               | .1                 | —                   | .FA-3974    |
| Fan, Box, 1767-SK/III .....                 | —                  | .2                  | .FA-34524   |
| 7. Ground Screw (not shown) .....           | .1                 | .1                  | .SC-2190    |
| 8. Heat Sink .....                          | .1                 | .1                  | .1005836    |
| Heat Sink Pad .....                         | .1                 | .2                  | .HE-33926   |
| 9. Power Supply Board .....                 | .1                 | .1                  | .BA-33554   |
| 10. Reed Switch (not shown) .....           | .1                 | .2                  | .SW-33559   |
| 11. Relay .....                             | .1                 | .2                  | .RL-33829   |
| Relay, Smoker .....                         | .1                 | .2                  | .RL-33558   |
| 12. Sensor .....                            | .1                 | .2                  | .SN-33541   |
| Sensor Mounting Block .....                 | .1                 | .2                  | .BK-24427   |
| 13. Terminal Block, Power .....             | .1                 | .1                  | .BK-3019    |
| 14. Terminal Block .....                    | .2                 | .4                  | .BK-33546   |
| 15. Thermostat, Fan .....                   | .1                 | .2                  | .TT-33255   |
| 16. Thermostat, Hi-Limit .....              | .1                 | .2                  | .TT-33476   |
| 17. Voltage Monitor Board .....             | .1                 | .1                  | .BA-33764   |

### CABLE HEATING SERVICE KIT

**No. 4881**

**MODEL 767-SK/III & 1767-SK/III**  
(PER COMPARTMENT)

**includes:**

|         |                                 |          |
|---------|---------------------------------|----------|
| CB-3045 | Cable Heating Element . . . . . | 210 feet |
| CR-3226 | Ring Connector. . . . .         | 12       |
| IN-3488 | Insulation Corner . . . . .     | 1 foot   |
| BU-3105 | Shoulder Bushing. . . . .       | 12       |
| BU-3106 | Cup Bushing. . . . .            | 12       |
| ST-2439 | Stud. . . . .                   | 12       |
| NU-2215 | Hex Nut . . . . .               | 24       |
| SL-3063 | Insulating Sleeve . . . . .     | 12       |
| TA-3540 | Electrical Tape . . . . .       | 1 roll   |

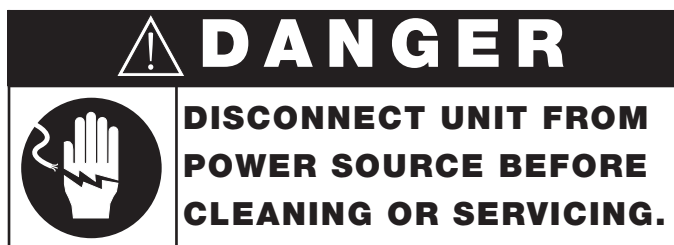

# SERVICE

## SERVICE VIEW - 2800-SK/III

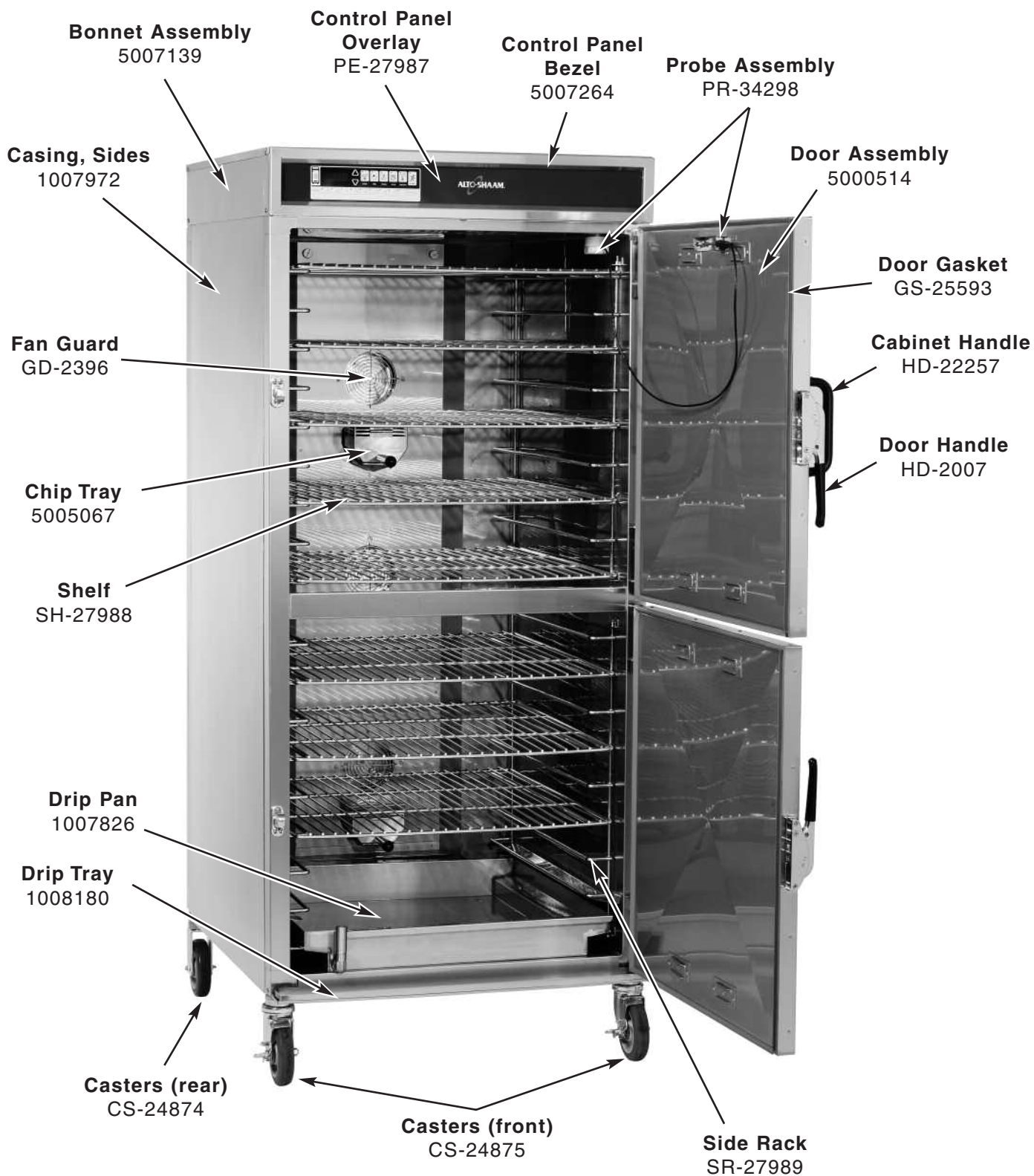

## SERVICE PARTS LIST - 2800-SK/III

| Part Description                             | Qty.    | Part Number |
|--|---------|-------------|
| 1. Bonnet Assembly                           | 1       | .5007139    |
| 2. Casing, Back                              | 1       | .1007968    |
| 3. Casing, Bottom                            | 1       | .1007967    |
| 4. Casing, Sides                             | 2       | .1007972    |
| 5. Casters, 5" (127mm), RIGID (REAR)         | .2 each | .CS-24874   |
| Casters, 5" (127mm), SWIVEL W/ BRAKE (FRONT) | .2 each | .CS-24875   |
| 6. Chip Tray                                 | 2       | .5005067    |
| 7. Control Panel Overlay                     | 1       | .PE-27987   |
| 8. Control Panel Bezel                       | 1       | .5007264    |
| 9. Door Assembly                             | 2       | .5000514    |
| 10. Drip Pan with drain                      | 1       | .1007826    |
| 11. Drip Tray                                | 1       | .1008180    |
| 12. Fan Guard                                | 3       | .GD-2396    |
| 13. Gasket, Door                             | 2       | .GS-25593   |
| 14. Handle, Cabinet                          | 2       | .HD-22257   |
| 15. Handle, Door                             | 2       | .HD-2007    |
| 16. Hinge, Door                              | .2 pair | .HG-22338   |
| 17. Probe Assembly                           | 1       | .PR-34298   |
| 18. Probe Receptacle                         | 1       | .PR-34299   |
| 19. Shelf, S/S Wire                          | .8      | .SH-27988   |
| 20. Side Rack, S/S                           | .4      | .SR-27989   |
| <b>Electrical</b>                            |         |             |
| 1. Beeper                                    | 1       | .BP-3567    |
| 2. Circuit Board                             | 1       | .BA-33991   |
| 3. Contactor                                 | 1       | .CN-3052    |
| 4. Control Assembly                          | 1       | .CC-34194   |
| 5. Cord, 208V, 1PH ONLY                      | 1       | .CD-33847   |
| 6. Fan, Box                                  | 1       | .FA-34524   |
| 7. Fan, Motor                                | 3       | .FA-33221   |
| 8. Heat Sink                                 | 1       | .HE-33926   |
| 9. Power Supply Board                        | 1       | .BA-33554   |
| 10. Relay                                    | 4       | .RL-33829   |
| 11. Relay, Smoker                            | 2       | .RL-33558   |
| 12. Sensor                                   | 1       | .SN-33541   |
| 13. Smoker Element Repair Kit                | 2       | .5003782    |
| 14. Smoke Element                            | 2       | .CB-3538    |
| 15. Terminal Block, Power                    | 3       | .BK-3597    |
| 16. Terminal Block                           | 4       | .BK-33546   |
| 17. Thermostat, Over Temp.                   | 1       | .TT-3750    |
| 18. Voltage Monitor Board                    | 1       | .BA-33764   |



### DANGER



**LOCK-OUT OR POST  
BREAKER PANEL UNTIL  
SERVICE WORK HAS BEEN  
COMPLETED.**



### DANGER



**DISCONNECT UNIT FROM  
POWER SOURCE BEFORE  
CLEANING OR SERVICING.**

## Cable Replacement Kits

Model 2800-SK/III

REQUIRES

Two (2) No. 14228

One (1) No. 4878



### Cable Replacement Kit No. 14228

includes:

|         |                       |          |
|---------|-----------------------|----------|
| CB-3045 | Cable Heating Element | 280 feet |
| CR-3226 | Ring Connector        | 16       |
| IN-3488 | Insulation Corner     | 1 foot   |
| BU-3105 | Shoulder Bushing      | 16       |
| BU-3106 | Cup Bushing           | 16       |
| ST-2439 | Stud                  | 16       |
| NU-2215 | Hex Nut               | 32       |
| SL-3063 | Insulating Sleeve     | 16       |
| TA-3540 | Electrical Tape       | 1 roll   |

### Cable Replacement Kit No. 4878

includes:

|         |                       |         |
|---------|-----------------------|---------|
| CB-3045 | Cable Heating Element | 85 feet |
| CR-3226 | Ring Connector        | 4       |
| IN-3488 | Insulation Corner     | 1 foot  |
| BU-3105 | Shoulder Bushing      | 4       |
| BU-3106 | Cup Bushing           | 4       |
| ST-2439 | Stud                  | 4       |
| NU-2215 | Hex Nut               | 8       |
| SL-3063 | Insulating Sleeve     | 4       |
| TA-3540 | Electrical Tape       | 1 roll  |

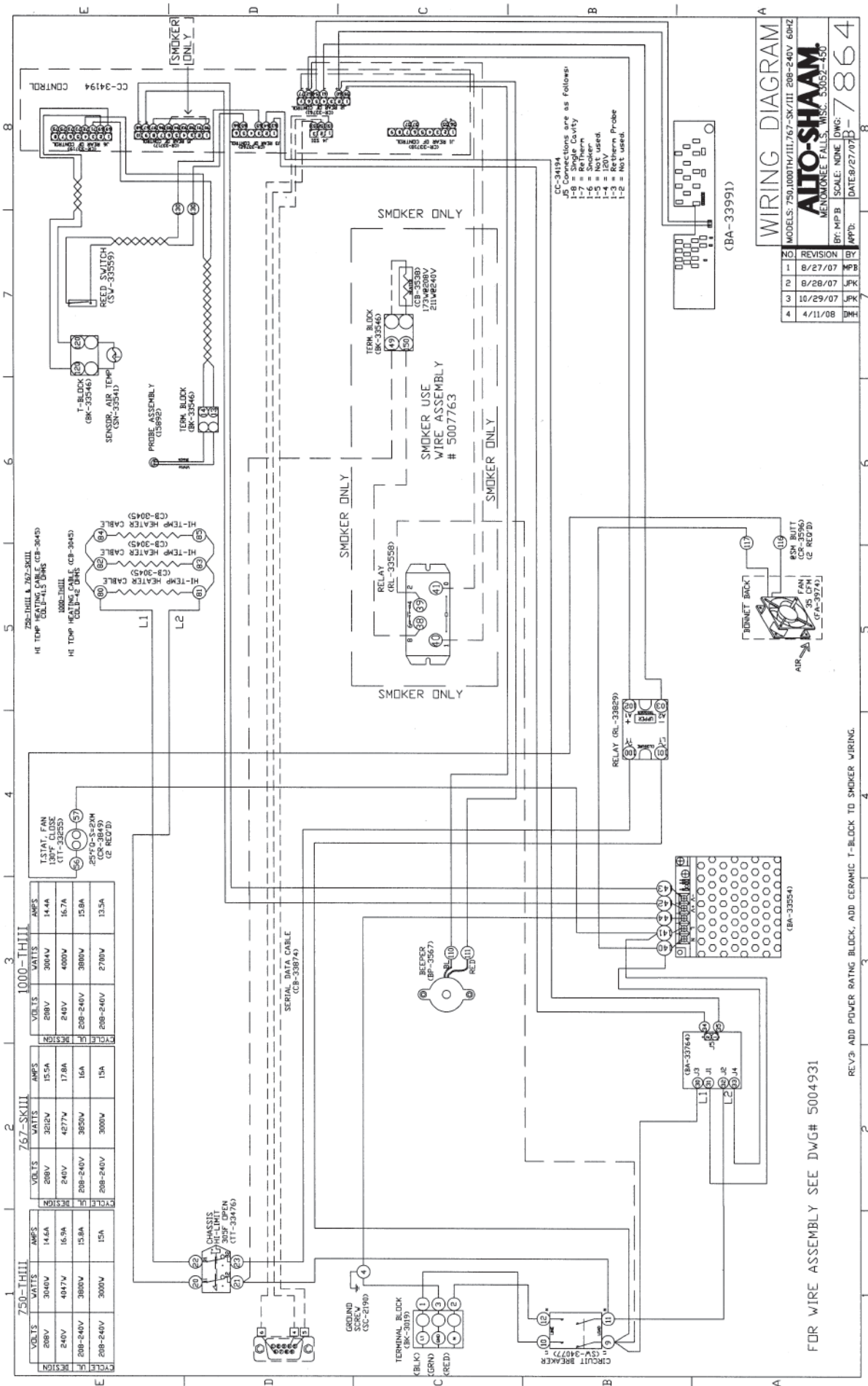

| 750-THIII |       |       | 767-SKIII |       |       | 1000-THIII |       |       |
|-----------|-------|-------|-----------|-------|-------|------------|-------|-------|
| VOLTS     | WATTS | AMPS  | VOLTS     | WATTS | AMPS  | VOLTS      | WATTS | AMPS  |
| 208V      | 3040V | 14.6A | 208V      | 3215V | 15.5A | 208V       | 3040V | 14.4A |
| 240V      | 4047W | 16.9A | 240V      | 4277W | 17.8A | 240V       | 4000V | 16.7A |
| 208-240V  | 3800V | 15.8A | 208-240V  | 3850V | 16A   | 208-240V   | 3800V | 15.8A |
| 208-240V  | 3000V | 15A   | 208-240V  | 3000V | 15A   | 208-240V   | 2780V | 13.5A |

**WIRING DIAGRAM**

MODELS: 750, 1000TH/III, 1767-SK/III, 208-240V, 60HZ  
**ALTO-SHAAM**  
 MENDOTA, ILL. U.S.A. 3155-150

| NO | REVISION | BY  |
|----|----------|-----|
| 1  | 8/27/07  | MPB |
| 2  | 8/28/07  | JPK |
| 3  | 10/29/07 | JPK |
| 4  | 4/11/08  | DH  |

BT: MPB SCALE: NONE DWG: 7864  
 APPD: DATE: 8/27/07

FOR WIRE ASSEMBLY SEE DWG# 5004931

REV3: ADD POWER RATING BLOCK, ADD CERAMIC T-BLOCK TO SMOKER WIRING.

CS-34124  
 JS Connections are as follows:  
 1-8 = Single Cavity  
 1-5 = Not used  
 1-3 = Not used  
 1-2 = Not used

(BA-33991)

SMOKER USE WIRE ASSEMBLY # 5007763

SMOKER ONLY

SMOKER ONLY

SMOKER ONLY

SMOKER ONLY





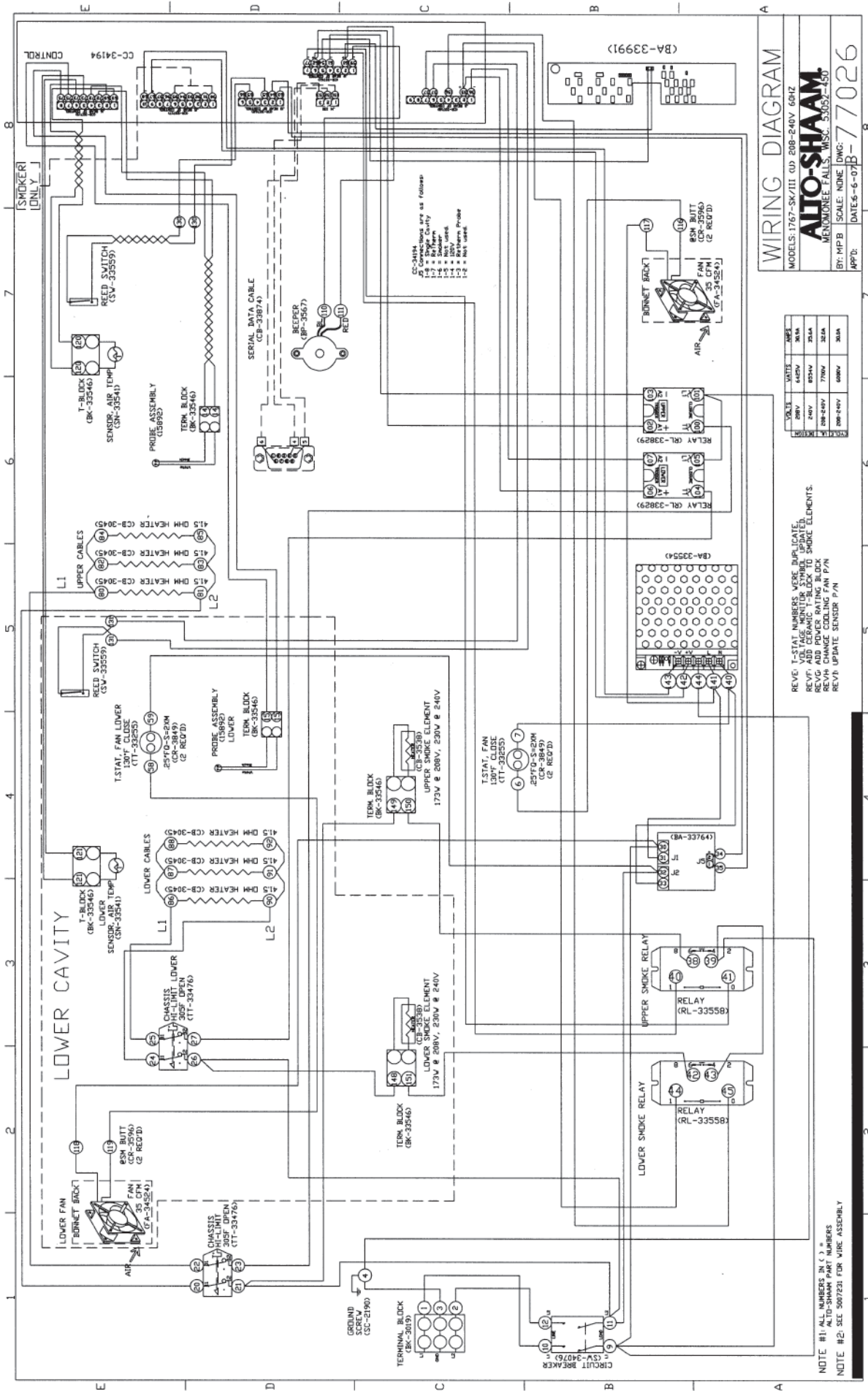



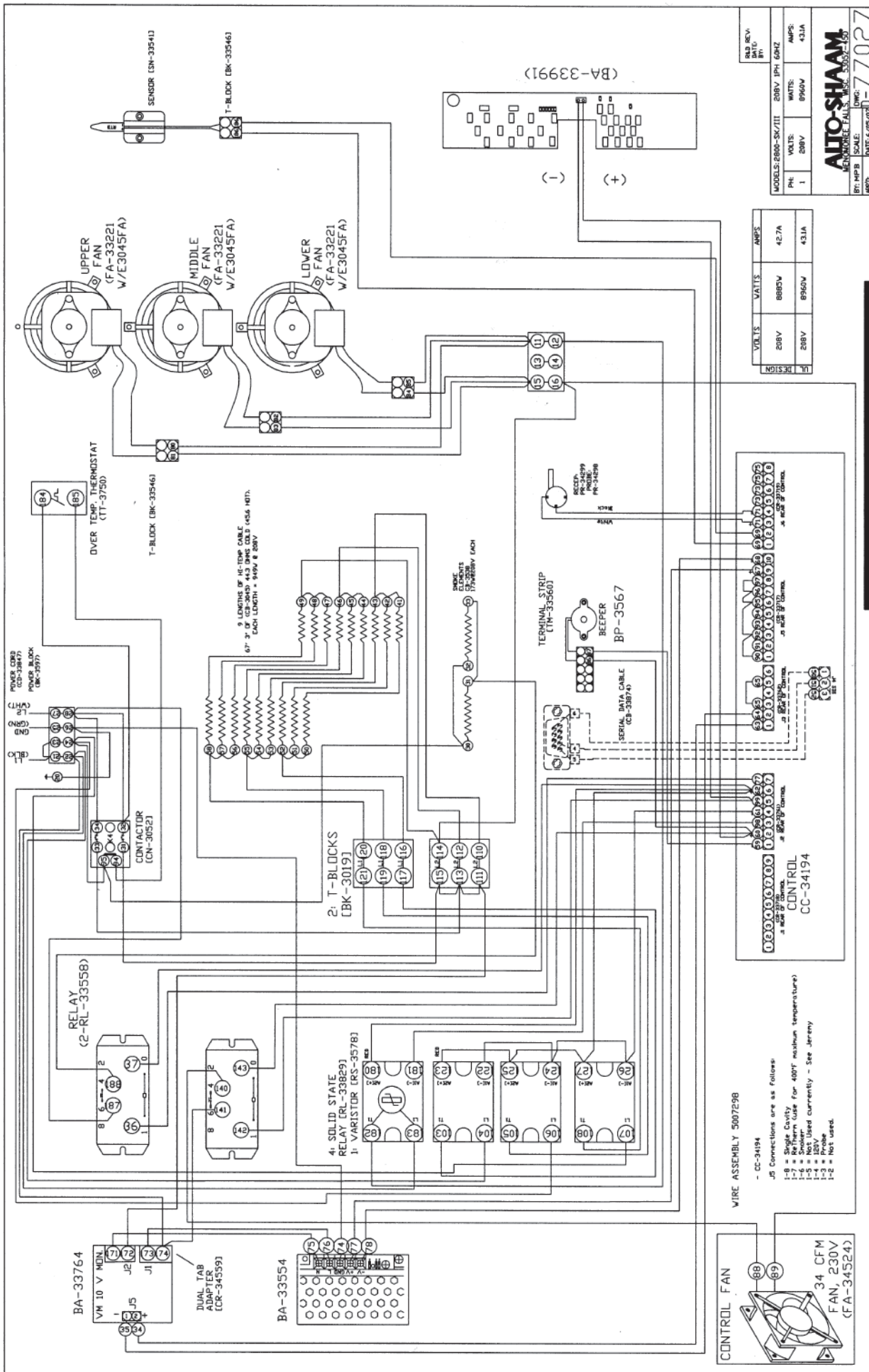





# TRANSPORTATION DAMAGE and CLAIMS

# ALTO SHAAM. LIMITED WARRANTY



All Alto-Shaam equipment is sold F.O.B. shipping point, and when accepted by the carrier, such shipments become the property of the consignee.

Should damage occur in shipment, it is a matter between the carrier and the consignee. In such cases, the carrier is assumed to be responsible for the safe delivery of the merchandise, unless negligence can be established on the part of the shipper.

1. Make an immediate inspection while the equipment is still in the truck or immediately after it is moved to the receiving area. Do not wait until after the material is moved to a storage area.
2. Do not sign a delivery receipt or a freight bill until you have made a proper count and inspection of all merchandise received.
3. Note all damage to packages directly on the carrier's delivery receipt.
4. Make certain the driver signs this receipt. If he refuses to sign, make a notation of this refusal on the receipt.
5. If the driver refuses to allow inspection, write the following on the delivery receipt:  
*Driver refuses to allow inspection of containers for visible damage.*
6. Telephone the carrier's office immediately upon finding damage, and request an inspection. Mail a written confirmation of the time, date, and the person called.
7. Save any packages and packing material for further inspection by the carrier.
8. Promptly file a written claim with the carrier and attach copies of all supporting paperwork.

We will continue our policy of assisting our customers in collecting claims which have been properly filed and actively pursued. We cannot, however, file any damage claims for you, assume the responsibility of any claims, or accept deductions in payment for such claims.

Alto-Shaam, Inc. warrants to the original purchaser that any original part that is found to be defective in material or workmanship will, at Alto-Shaam's option, subject to provisions hereinafter stated, be replaced with a new or rebuilt part.

The labor warranty remains in effect one (1) year from installation or fifteen (15) months from the shipping date, whichever occurs first. Alto-Shaam will bear normal labor charges performed during standard business hours, and excluding overtime, holiday rates or any additional fees.

The parts warranty remains in effect for one (1) year from installation or fifteen (15) months from the shipping date, whichever occurs first.

However, the heating element on Halo Heat® cook/hold ovens and the refrigeration compressor on Alto-Shaam Quickchillers™ are warranted for a period of five (5) years from installation. The labor warranty is the same as stated above; namely, for one (1) year from installation or fifteen (15) months from the shipping date, whichever occurs first.

#### THIS WARRANTY DOES NOT APPLY TO:

1. Calibration.
2. Replacement of light bulbs and/or the replacement of display case glass due to damage of any kind.
3. Equipment damage caused by accident, shipping, improper installation or alteration.
4. Equipment used under conditions of abuse, misuse, carelessness or abnormal conditions including, but not limited to, equipment subjected to harsh or inappropriate chemicals including, but not limited to, compounds containing chloride or quaternary salts, poor water quality, or equipment with missing or altered serial numbers.
5. Damage incurred as a direct result of poor water quality, inadequate maintenance of steam generators and/or surfaces affected by water quality. Water quality and required maintenance of steam generating equipment is the responsibility of the owner/operator.
6. Damage caused by use of any cleaning agent other than Alto-Shaam's Combitherm® Cleaner including, but not limited to, damage due to chlorine or other harmful chemicals. Use of Alto-Shaam's Combitherm® Cleaner on Combitherm® ovens is highly recommended.
7. Any losses or damage resulting from malfunction, including loss of product or consequential or incidental damages of any kind.
8. Equipment modified in any manner from original model, substitution of parts other than factory authorized parts, removal of any parts including legs, or addition of any parts.

This warranty is exclusive and is in lieu of all other warranties, expressed or implied, including the implied warranties of merchantability and fitness for a particular purpose. In no event shall Alto-Shaam be liable for loss of use, loss of revenue or profit, or loss of product, or for any indirect or consequential damages. No person except an officer of Alto-Shaam, Inc. is authorized to modify this warranty or to incur on behalf of Alto-Shaam any other obligation or liability in connection with Alto-Shaam equipment.

**ALTO-SHAAM, INC.**

RECORD THE MODEL AND SERIAL NUMBER OF THE APPLIANCE FOR EASY REFERENCE.  
ALWAYS REFER TO BOTH MODEL AND SERIAL NUMBER IN ANY CONTACT WITH ALTO-SHAAM REGARDING THIS APPLIANCE.

Model: \_\_\_\_\_ Date Installed: \_\_\_\_\_  
Voltage: \_\_\_\_\_ Purchased From: \_\_\_\_\_  
Serial Number: \_\_\_\_\_

**W164 N9221 Water Street • P.O. Box 450 • Menomonee Falls, Wisconsin 53052-0450 • U.S.A.**  
PHONE: 262.251.3800 • 800.558-8744 USA/CANADA FAX: 262.251.7067 • 800.329.8744 U.S.A. ONLY  
WEBSITE: [www.alto-shaam.com](http://www.alto-shaam.com)

PRINTED IN U.S.A.

## Free Manuals Download Website

<http://myh66.com>

<http://usermanuals.us>

<http://www.somanuals.com>

<http://www.4manuals.cc>

<http://www.manual-lib.com>

<http://www.404manual.com>

<http://www.luxmanual.com>

<http://aubethermostatmanual.com>

Golf course search by state

<http://golfingnear.com>

Email search by domain

<http://emailbydomain.com>

Auto manuals search

<http://auto.somanuals.com>

TV manuals search

<http://tv.somanuals.com>