

ALTO-SHAAM®

Cooking & Holding Oven
Electric Manual Control



Model:

AS-250



- **INSTALLATION**
- **OPERATION**
- **MAINTENANCE**

HALO HEAT®

24•7
Your Service Hotline
1-800-558-8744

W164 N9221 Water Street • P.O. Box 450 • Menomonee Falls, Wisconsin 53052-0450 USA
PHONE: 262.251.3800 • 800.558.8744 USA/CANADA FAX: 262.251.7067 • 800.329.8744 U.S.A. ONLY
www.alto-shaam.com

ALTO-SHAAM®

Delivery	1	Sanitation	
Unpacking	1	Sanitation/Food Safety	15
Safety Procedures and Precautions	2	Internal Food Product Temperatures	15
Installation		Service	
Installation Requirements	3	Trouble Shooting - Error Codes	16
Clearance Requirements	3	Trouble Shooting Electrical Components	17
Dimension Drawings, weights & capacities	4	Service View	18
Options and Accessories	4	Service View Parts List	19
Leveling	4	Cable Heating Kits	19
Leg Installation Instructions	5	Wire Diagrams	
Electrical Specifications	6	120V	20
Operating Instructions		230V	21
User Safety Information	7	Warranty	
Start-up Operation	7	Transportation Damage and Claims	Back Cover
Audible Signals	7	Limited Warranty	Back Cover
Control Features	8		
Operating Features & Functions	9		
Cook/Hold Instructions	10		
Cook/Hold using Preset Menu Keys	10		
Programming a Preset	11		
Erasing a Preset	11		
General Holding Guidelines	12		
Care and Cleaning			
Cleaning and Preventative Maintenance	13		
Protecting Stainless Steel Surfaces	13		
Cleaning Agents	13		
Cleaning Materials	13		
Equipment Care	14		
Clean Daily	14		
Clean the Door Vents	14		
Clean the Probes Daily	14		
Check the Cooling Fan	14		
Check Overall Condition of Oven	14		

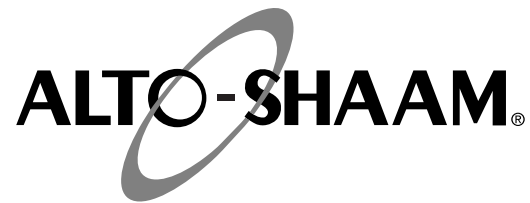

DELIVERY

This Alto-Shaam appliance has been thoroughly tested and inspected to ensure only the highest quality unit is provided. Upon receipt, check for any possible shipping damage and report it at once to the delivering carrier. *See Transportation Damage and Claims section located in this manual.*

This appliance, complete with unattached items and accessories, may have been delivered in one or more packages. Check to ensure that all standard items and options have been received with each model as ordered.

Save all the information and instructions packed with the appliance. Complete and return the warranty card to the factory as soon as possible to ensure prompt service in the event of a warranty parts and labor claim.

This manual must be read and understood by all people using or installing the equipment model. Contact the Alto-Shaam Tech Team Service Department if you have any questions concerning installation, operation, or maintenance.

NOTE: All claims for warranty must include the full model number and serial number of the unit.

UNPACKING

1. Carefully remove the appliance from the carton or crate.

NOTE: Do not discard the carton and other packaging material until you have inspected the unit for hidden damage and tested it for proper operation.

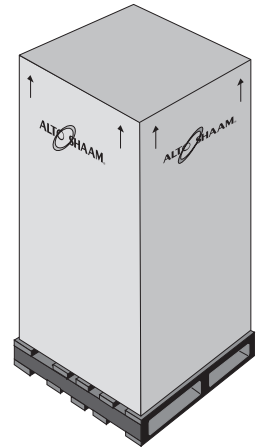

2. Read all instructions in this manual carefully before initiating the installation of this appliance.

DO NOT DISCARD THIS MANUAL.

This manual is considered to be part of the appliance and is to be provided to the owner or manager of the business or to the person responsible for training operators. *Additional manuals are available from the Alto-Shaam Tech Team Service Department.*

3. Remove all protective plastic film, packaging materials, and accessories from the appliance before connecting electrical power. Store any accessories in a convenient place for future use.

SAFETY PROCEDURES AND PRECAUTIONS

Knowledge of proper procedures is essential to the safe operation of electrically and/or gas energized equipment. In accordance with generally accepted product safety labeling guidelines for potential hazards, the following signal words and symbols may be used throughout this manual.

DANGER



Used to indicate the presence of a hazard that **WILL** cause severe personal injury, death, or substantial property damage if the warning included with this symbol is ignored.

WARNING



Used to indicate the presence of a hazard that **CAN** cause personal injury, possible death, or major property damage if the warning included with this symbol is ignored.

CAUTION



Used to indicate the presence of a hazard that can or will cause minor or moderate personal injury or property damage if the warning included with this symbol is ignored.

CAUTION

Used to indicate the presence of a hazard that can or will cause minor personal injury, property damage, or a potential unsafe practice if the warning included with this symbol is ignored.

NOTE: Used to notify personnel of installation, operation, or maintenance information that is important but not hazard related.

1. This appliance is intended to cook, hold or process foods for the purpose of human consumption. No other use for this appliance is authorized or recommended.
2. This appliance is intended for use in commercial establishments where all operators are familiar with the purpose, limitations, and associated hazards of this appliance. Operating instructions and warnings must be read and understood by all operators and users.
3. Any troubleshooting guides, component views, and parts lists included in this manual are for general reference only and are intended for use by qualified technical personnel.
4. This manual should be considered a permanent part of this appliance. This manual and all supplied instructions, diagrams, schematics, parts lists, notices, and labels must remain with the appliance if the item is sold or moved to another location.

NOTE

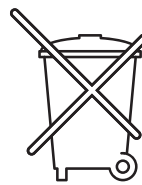

For equipment delivered for use in any location regulated by the following directive:

DO NOT DISPOSE OF ELECTRICAL OR ELECTRONIC EQUIPMENT WITH OTHER MUNICIPAL WASTE.

INSTALLATION

DANGER



IMPROPER INSTALLATION, ALTERATION, ADJUSTMENT, SERVICE, OR MAINTENANCE COULD RESULT IN SEVERE INJURY, DEATH, OR CAUSE PROPERTY DAMAGE.

READ THE INSTALLATION, OPERATING AND MAINTENANCE INSTRUCTIONS THOROUGHLY BEFORE INSTALLING OR SERVICING THIS EQUIPMENT.

CAUTION



TO PREVENT PERSONAL INJURY, USE CAUTION WHEN MOVING OR LEVELING THIS APPLIANCE.

CAUTION



METAL PARTS OF THIS EQUIPMENT BECOME EXTREMELY HOT WHEN IN OPERATION. TO AVOID BURNS, ALWAYS USE HAND PROTECTION WHEN OPERATING THIS APPLIANCE.



DANGER



DO NOT store or use gasoline or other flammable vapors or liquids in the vicinity of this or any other appliance.

SITE INSTALLATION

The Alto-Shaam cook and hold oven must be installed in a location that will permit the oven to function for its intended purpose and to allow adequate clearance for ventilation, proper cleaning, and maintenance access.

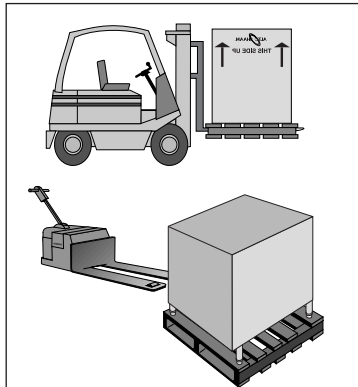

1. The oven must be installed on a stable and level surface.
2. **DO NOT** install this appliance in any area where it may be affected by any adverse conditions such as steam, grease, dripping water, high temperatures, or any other severely adverse conditions.
3. **DO NOT** store or use any flammable liquids or allow flammable vapors in the vicinity of this oven or any other appliance.
4. This appliance must be kept free and clear of any combustible materials.
5. This appliance must be kept free and clear of any obstructions blocking access for maintenance or service.

Emissions testing conducted by Underwriters Laboratories, Inc.® was found to be in compliance with the applicable requirements of NFPA96: 2004 Edition, Par. 4.1.1.2. U.L emissions sampling of grease laden vapor resulted in a total of 0.55 milligrams per cubic meter with no visible smoke and is considered representative of all oven models in the line. Based on these results, hood installation and/or outside venting should not be a requirement in most areas. Verify local codes for locations where more restrictive codes are applicable.

MINIMUM CLEARANCE REQUIREMENTS

18" (457mm) minimum clearance at the back from heat producing equipment. To protect the electronic control, maintain sufficient side clearance to prevent the control area from reaching any temperature at or above 140°F (60°C). The oven must not be installed in any area where it may be affected by steam, grease, dripping water, extreme temperatures, or any other severely adverse conditions.

INSTALLATION

SITE INSTALLATION

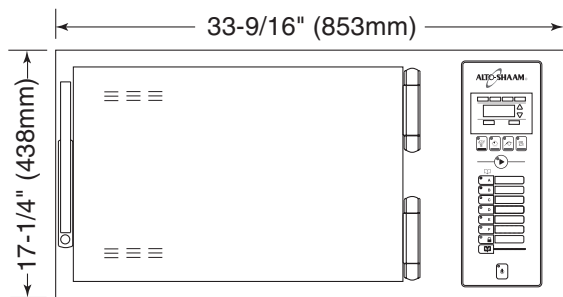
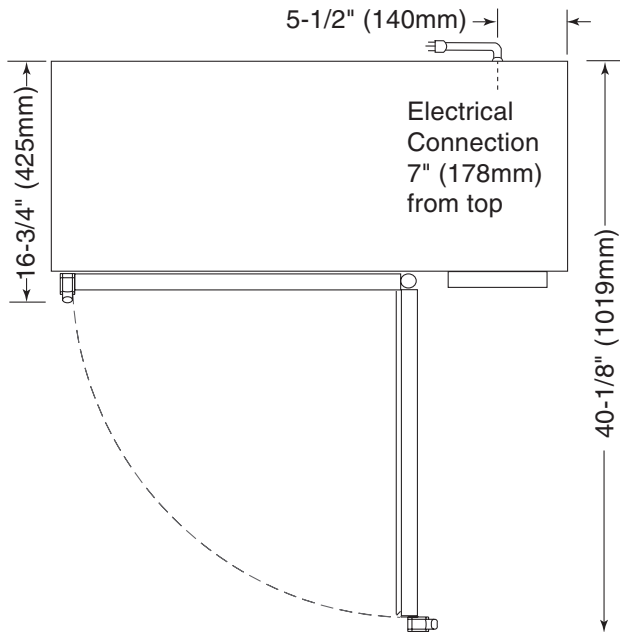

OPTIONS & ACCESSORIES

Carving Holder, Prime Rib	HL-2635
Shelf, Stainless Steel Wire	SH-2786
Stacking Hardware	4928

WEIGHT

NET	86 lb (39 kg)
SHIP	100 lb (45 kg)
CARTON	36" x 20" x 21"
DIMENSIONS:	(914mm x 508mm x 533mm)

DOMESTIC SHIPMENTS ONLY

INSTALLATION AND START-UP

A number of adjustments are associated with initial installation and start-up. It is important that these adjustments be conducted by a qualified service technician. Installation and start-up adjustments are the responsibility of the dealer or user. These adjustments include but are not limited to thermostat calibration, door adjustment, leveling, electrical hook-up and installation of optional casters or legs.

LEVELING

Level the oven from side-to-side and front-to-back with the use of a spirit level. For ovens installed with casters, it is important that the installation surface be level due to the probability of frequent oven repositioning.

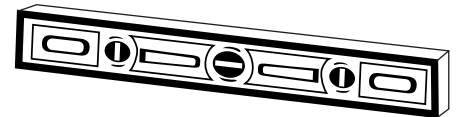

We recommend checking the level of the oven periodically to make certain the floor has not shifted nor the oven moved.

NOTE: Failure to properly level this oven can cause improper function and will result in the uneven baking with products consisting of semi-liquid batter.

CAUTION



**TO PREVENT PERSONAL INJURY,
USE CAUTION WHEN MOVING OR
LEVELING THIS APPLIANCE.**

INSTALLATION

SITE INSTALLATION

LEG INSTALLATION INSTRUCTIONS

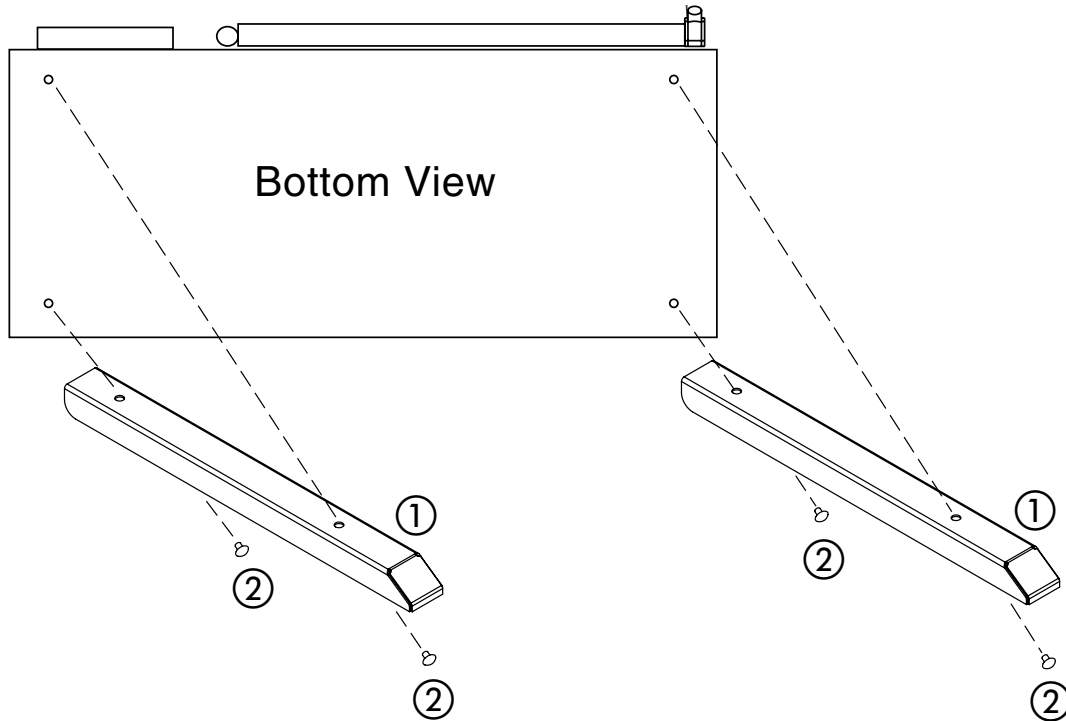

Item	Description	Part No.	Qty
1	Legs	11547	2
2	Nylon Screws	SC-2464	4

1. Attach legs ① to bottom of unit using four (4) nylon screws ② .

Failure to properly install the legs can cause unit to tip when the door is opened resulting in possible equipment damage or personal injury.

INSTALLATION

ELECTRICAL CONNECTION

The appliance must be installed by a qualified service technician. The oven must be properly grounded in accordance with the National Electrical Code and applicable local codes.

Plug the unit into a properly grounded receptacle **ONLY**, positioning the unit so that the plug is easily accessible in case of an emergency. Arcing will occur when connecting or disconnecting the unit unless all controls are in the "OFF" position.

Proper receptacle or outlet configuration or permanent wiring for this unit must be installed by a licensed electrician in accordance with applicable local electrical codes.

230V:

To prevent an electrical shock hazard between the appliance and other appliances or metal parts in close vicinity, an equalization-bonding stud is provided. An equalization bonding lead must be connected to this stud and the other appliances / metal parts to provide sufficient protection against potential difference. The terminal is marked with the following symbol.



NOTE: 230V appliances must be connected to an electrical circuit that is protected by an external GFCI outlet.

CAUTION

THIS SECTION IS PROVIDED FOR THE ASSISTANCE OF QUALIFIED SERVICE TECHNICIANS ONLY AND IS NOT INTENDED FOR USE BY UNTRAINED OR UNAUTHORIZED SERVICE PERSONNEL.



DANGER





ENSURE POWER SOURCE MATCHES VOLTAGE STAMPED ON APPLIANCE NAMEPLATE.

DANGER



To avoid electrical shock, this appliance MUST be adequately grounded in accordance with local electrical codes or, in the absence of local codes, with the current edition of the National Electrical Code ANSI/NFPA No. 70. In Canada, all electrical connections are to be made in accordance with CSA C22.1, Canadian Electrical Code Part 1 or local codes.

ELECTRICAL					
VOLTAGE	PHASE	CYCLE/HZ	AMPS	kW	
125	1	60	10.4	1.3	 NEMA 5-15P 15A, 125V PLUG
230	1	50/60	5.5	1.2	 CEE 7/7 220-230V Plug

OPERATING INSTRUCTIONS

USER SAFETY INFORMATION

CAUTION



METAL PARTS OF THIS EQUIPMENT BECOME EXTREMELY HOT WHEN IN OPERATION. TO AVOID BURNS, ALWAYS USE HAND PROTECTION WHEN OPERATING THIS APPLIANCE.

The Alto-Shaam cook and hold oven is intended for use in commercial establishments by qualified operating personnel where all operators are familiar with the purpose, limitations, and associated hazards of this appliance. Operating instructions and warnings must be read and understood by all operators and users.

START-UP OPERATION

BEFORE INITIAL USE:

Interior oven surfaces must be heated to remove surface oils and the accompanying odor produced during the first use of the oven.

1. Wipe all wire shelves, side racks and the full oven interior with a clean, damp cloth. Install the oven side racks, oven shelves, and external drip tray. Shelves are installed with the curved edge toward the back of the oven. Insert the drip pan on the interior bottom surface of the oven.
2. • Close the oven doors
• Press and release control ON/OFF key.
• Press the COOK key.
• Press the up and down arrows to set the cooking temperature to 300°F (149°C).
3. • Press the TIME key.
• Press the up and down arrows to set the cooking time to approximately 2 hours.
• Allow the oven to cycle for approximately 2 hours or until no odor is detected.

DANGER



AT NO TIME SHOULD THE INTERIOR OR EXTERIOR BE STEAM CLEANED, HOSED DOWN, OR FLOODED WITH WATER OR LIQUID SOLUTION OF ANY KIND. DO NOT USE WATER JET TO CLEAN.



SEVERE DAMAGE OR ELECTRICAL HAZARD COULD RESULT.

WARRANTY BECOMES VOID IF APPLIANCE IS FLOODED



DANGER



DISCONNECT UNIT FROM POWER SOURCE BEFORE CLEANING OR SERVICING.

AUDIBLE SIGNALS

OVEN BEEPING indicates a response, mode changes, and error conditions.

One brief beep - response to a key being pressed.

Two brief beeps - informative beep that indicates that something has been changed, such as the user entering a volume change, entering a temperature scale change, etc.

Three brief beeps - indicates the oven is done preheating, the probe has exceeded set-point in cold smoking, the door has been open too long, or the control is unlocked.

Four brief beeps - indicates an error. Refer to the Trouble Shooting section of this manual.

Beeper Volume Selection - With the control in *the off mode*, *press and hold* the DOWN ARROW Key until the display shows one of the 4 volume levels (0 being OFF or the lowest, and 3 being the highest). After each change, the button must be released and the display must clear before the procedure can be repeated to select a different volume level. Turn the unit ON and then OFF again to store the desired set point.



OPERATING INSTRUCTIONS

CONTROL FEATURES

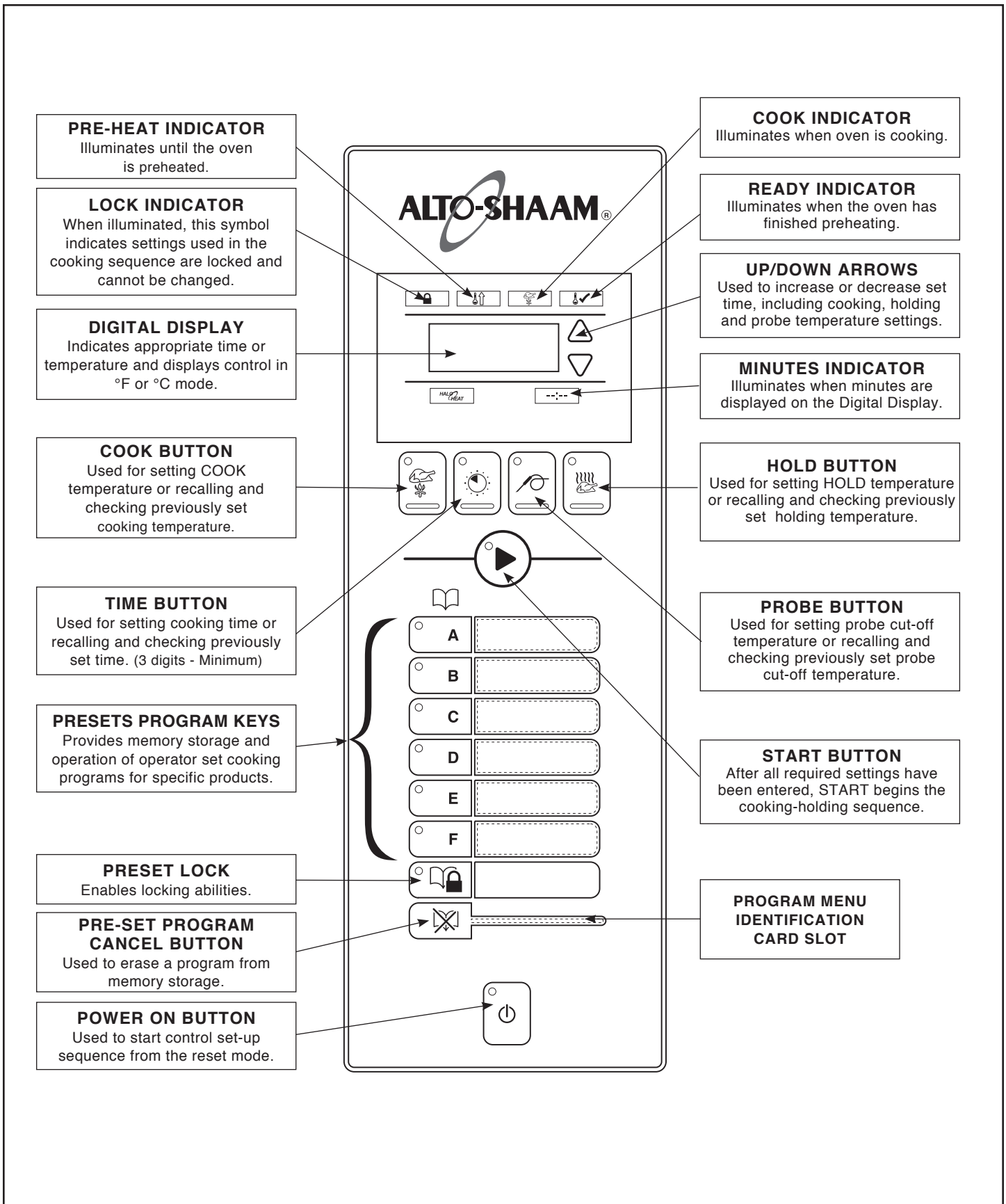

OPERATING INSTRUCTIONS

OPERATING FEATURES & FUNCTIONS

To stop an operation at any time — Press and hold the START Key until the control beeps for two seconds, indicating the operation has been cancelled. The oven will remain in a power-on state.

To turn oven control panel off — Press and hold the ON/OFF Key until the oven beeps. The ON/OFF indicator light will go out.

Door open indicator — Display will flash “door” and a triple beep will alert the user. Press ON/OFF key to acknowledge error and disable triple beep.

Arrow Keys:

Cook, Hold and Probe Temperature set points can be adjusted by 1° when pressing the ARROW Keys. To adjust in steps of 10°, *press and hold* the TEMPERATURE Key and ARROW Key at the same time.

The **Time** setting is adjusted in increments of 1 minute by pressing the ARROW Keys. To make adjustment in steps of 10 minutes, *press and hold* the TIME Key and ARROW Key at the same time.

Green and Amber Indicators:

Each program key includes a green light which indicates a requirement for additional programming by the operator or the current operational state of the oven.

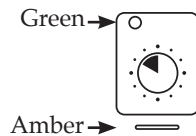

The COOK, TIME, PROBE, and HOLD keys include an amber indicator light to identify the information being displayed.

Power Fail Detect:

If the power were to fail for any reason while heating, the control will retain, in memory, the programmed operating conditions. When power is restored, the control will resume operating from the point where it was interrupted and the ON/OFF indicator light will flash, indicating that such an event did occur. The operator can acknowledge the power failure by pressing the ON/OFF key. Pressing the key will display the amount of time that the power has been off. The control will stop counting the amount of time the power has been off when it has been off for more than 24 hours.

NOTE: *If such an event has occurred, it is strongly recommended that you ensure the food is safe for consumption according to local health regulations.*

Display High/Low Probe Temperatures:

To observe the recorded maximum or minimum probe temperature when cooking by probe, press the following keys while the probe remains in the product:

Highest Temperature: Press PROBE Key and UP ARROW Key at same time.

Lowest Temperature: Press PROBE Key and DOWN ARROW Key at same time.

Probe Usage:

When the oven probe remains inserted in the probe bracket, the LED temperature display will indicate the ambient air temperature inside the oven. To use the probe for cooking remove it from the bracket and wipe the full length of the metal probe with a disposable alcohol pad to clean and sanitize before using.

Only the tip of the probe senses the internal product temperature; therefore, it is important the tip be placed correctly in the product for internal temperature accuracy. Push the probe tip halfway into the product, positioning the tip at the center of the food mass. When inserting the probe into solid foods such as meat roast or poultry breasts, push the probe in from a straight downward position or in from the side to the center position. If placing into a semi-liquid or liquid product, the probe cable must be secured to keep the probe positioned properly. Do not let the probe tip touch the edges, bottom or side of a container. Tape the probe cable to the lip or edge of the container.

NOTE: When cooking by probe, insert the probe into the raw product after the oven has been preheated.

WAIT ONE FULL MINUTE to allow the probe temperature to decrease to the internal temperature of the product. Press the start button to begin the cooking process after this probe temperature adjustment period. A false probe reading of the internal product temperature will cause the oven to default to a holding temperature.

Probe Calibration:

1. To verify product probe calibration, place the probe in a warm glass of water along with a quality independent digital thermometer and press the probe key for two (2) seconds to display the probes actual temperature. Compare readings.
2. If calibration is required, press the probe key for eight (8) seconds until the unit beeps twice and the probe offset is displayed. Adjust the probe offset to match the difference between the independent probe temperature and the control probe temperature by pressing the up or down arrows to increase or decrease the offset.
3. Repeat steps 1 and 2 to verify the probe calibration as necessary.

OPERATING INSTRUCTIONS

Cook/Hold Instructions



Press and release control ON/OFF key. The oven will beep for one second and power to the unit will be indicated by an illuminated green indicator light located in the upper left corner of the ON/OFF key. The oven will begin operating in the hold mode. The amber HOLD indicator will be illuminated and the last set hold temperature will be displayed.

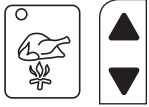

To set Cook temperature — Press COOK Key. Oven preheat indicator will illuminate and the last set cooking temperature is displayed. To change the cook temperature, press the UP or DOWN ARROW Keys.

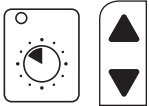

If cooking by time — press the TIME Key. The green TIME indicator will illuminate and the last set cooking time will be displayed. To change the set time, press the UP or DOWN ARROW Key. The display will alternate between the set temperature and the elapsed time.

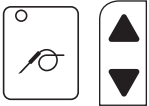

If cooking by probe — press the PROBE Key. The green PROBE indicator will illuminate and the last set internal product temperature will be displayed. To change the set temperature, press the UP or DOWN ARROW Key. The display will alternate between the set temperature, the elapsed time, and the probe temperature.



To set Hold temperature — Press the HOLD Key. The green cook indicator light will remain illuminated. To change the hold temperature, press the UP or DOWN ARROW Key. The display will alternate between the set hold temperature and the amount of time the product has been in the hold mode. Oven will remain in the HOLD mode until the ON/OFF key is pressed.



Press START key to begin cooking cycle.

To Cook/Hold using Preset Menu Keys

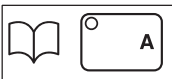

Press Desired PRESET Key (A through F). PRESET Keys with stored cooking programs will have green indicator illuminated. The oven will automatically enter preheat mode. Oven will beep periodically when it has reached a preheat ready state, and both the Ready and Start indicator lights will flash. To program a preset menu key, see **Programming a Preset** in this manual.



Press START key to begin cooking cycle.

CAUTION

TO MAINTAIN SAFE TEMPERATURE LEVELS, COLD FOOD FOR RETHERMALIZATION OR REHEATING MUST NEVER BE ADDED TO THE OVEN WHILE HOT FOODS ARE BEING HELD.

OPERATING INSTRUCTIONS

Programming a Preset

Select the product to be programmed and begin programming with the oven control power OFF.



Press and release control ON/OFF key. The oven will beep for one second and power to the unit will be indicated by an illuminated green indicator light located in the upper left corner of the ON/OFF key. The oven will begin operating in the hold mode. The amber HOLD indicator will be illuminated and the last set hold temperature will be displayed.

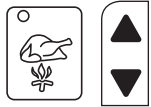

To set Cook temperature — Press COOK Key. Oven preheat indicator will illuminate and the last set cooking temperature is displayed. To change the cook temperature, press the UP or DOWN ARROW Keys.

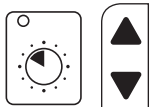

If cooking by time — press the TIME Key. The green TIME indicator will illuminate and the last set cooking time will be displayed. To change the set time, press the UP or DOWN ARROW Key. The display will alternate between the set temperature and the elapsed time.

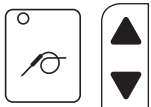

If cooking by probe — press the PROBE Key. The green PROBE indicator will illuminate and the last set internal product temperature will be displayed. To change the set temperature, press the UP or DOWN ARROW Key. The display will alternate between the set temperature, the elapsed time, and the probe temperature.



To set Hold temperature — Press the HOLD Key. The green cook indicator light will remain illuminated. To change the hold temperature, press the UP or DOWN ARROW Key. The display will alternate between the set hold temperature and the amount of time the product has been in the hold mode. Oven will remain in the HOLD mode until the ON/OFF key is pressed.

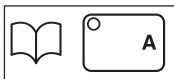

Select a letter code for the product programmed by the previous steps. Press and hold the selected PRESET key for two seconds. When the preset has been saved, you will hear a one second beep and the preset light will illuminate.

Note: Only one preset can be programmed at a time. If programming an additional preset is desired, the unit must be started and stopped either by cycling the power to the cavity or by pressing the START/STOP key. The last PRESET Key used will be the oven cooking run sequence for the next product to be programmed. Settings can be manually changed for the next product and an alternate pre-programmed letter key selected.

Erasing a Preset

To erase a program, the oven must be in either the power-up hold mode or in the preheat mode. The oven cannot be running a PRESET Menu program.

When the oven is in the power-up hold mode or in the preheat mode, press and hold the CANCEL Key and then the appropriate letter PRESET Key to be erased for two seconds. When the preset has been erased the oven will beep for one second.

IMPORTANT - After programming a specific product into memory in a programmable preset key, it is very important to make a written permanent record of the product and the program letter assigned. Menu card (PE-23384) is provided for this purpose.

OPERATING INSTRUCTIONS

General Holding Guideline

Chefs, cooks and other specialized food service personnel employ varied methods of cooking. Proper holding temperatures for a specific food product must be based on the moisture content of the product, product density, volume, and proper serving temperatures. Safe holding temperatures must also be correlated with palatability in determining the length of holding time for a specific product.

Halo Heat maintains the maximum amount of product moisture content without the addition of water, water vapor, or steam. Maintaining maximum natural product moisture preserves the natural flavor of the product and provides a more genuine taste. In addition to product moisture retention, the gentle properties of Halo Heat maintain a consistent temperature throughout the cabinet without the necessity of a heat distribution fan, thereby preventing further moisture loss due to evaporation or dehydration.

When product is removed from a high temperature cooking environment for immediate transfer into equipment with the lower temperature required for hot food holding, condensation can form on the outside of the product and on the inside of plastic containers used in self-service applications. Allowing the product to release the initial steam and heat produced by high temperature cooking can alleviate this condition. To preserve the safety and quality of freshly cooked foods, however, a maximum of 1 to 2 minutes must be the only time period allowed for the initial heat to be released from the product.

Most Halo Heat Holding Equipment is provided with a thermostat control between 60° and 200°F (16° to 93°C). If the unit is equipped with vents, close the vents for moist holding and open the vents for crisp holding.

HOLDING TEMPERATURE RANGE		
MEAT	FAHRENHEIT	CELSIUS
BEEF ROAST — Rare	130°F	54°C
BEEF ROAST — Med/Well Done	155°F	68°C
BEEF BRISKET	160° — 175°F	71° — 79°C
CORN BEEF	160° — 175°F	71° — 79°C
PASTRAMI	160° — 175°F	71° — 79°C
PRIME RIB — Rare	130°F	54°C
STEAKS — Broiled/Fried	140° — 160°F	60° — 71°C
RIBS — Beef or Pork	160°F	71°C
VEAL	160° — 175°F	71° — 79°C
HAM	160° — 175°F	71° — 79°C
PORK	160° — 175°F	71° — 79°C
LAMB	160° — 175°F	71° — 79°C
POULTRY		
CHICKEN — Fried/Baked	160° — 175°F	71° — 79°C
DUCK	160° — 175°F	71° — 79°C
TURKEY	160° — 175°F	71° — 79°C
GENERAL	160° — 175°F	71° — 79°C
FISH/SEAFOOD		
FISH — Baked/Fried	160° — 175°F	71° — 79°C
LOBSTER	160° — 175°F	71° — 79°C
SHRIMP — Fried	160° — 175°F	71° — 79°C
BAKED GOODS		
BREADS/ROLLS	120° — 140°F	49° — 60°C
MISCELLANEOUS		
CASSEROLES	160° — 175°F	71° — 79°C
DOUGH — Proofing	80° — 100°F	27° — 38°C
EGGS — Fried	150° — 160°F	66° — 71°C
FROZEN ENTREES	160° — 175°F	71° — 79°C
HORS D'OEUVRES	160° — 180°F	71° — 82°C
PASTA	160° — 180°F	71° — 82°C
PIZZA	160° — 180°F	71° — 82°C
POTATOES	180°F	82°C
PLATED MEALS	140° — 165°F	60° — 74°C
SAUCES	140° — 200°F	60° — 93°C
SOUP	140° — 200°F	60° — 93°C
VEGETABLES	160° — 175°F	71° — 79°C
THE HOLDING TEMPERATURES LISTED ARE SUGGESTED GUIDELINES ONLY. ALL FOOD HOLDING SHOULD BE BASED ON INTERNAL PRODUCT TEMPERATURES. ALWAYS FOLLOW LOCAL HEALTH (HYGIENE) REGULATIONS FOR ALL INTERNAL TEMPERATURE REQUIREMENTS.		

CARE AND CLEANING

CLEANING AND PREVENTIVE MAINTENANCE

PROTECTING STAINLESS STEEL SURFACES



It is important to guard against corrosion in the care of stainless steel surfaces. Harsh, corrosive, or inappropriate chemicals can completely destroy the protective surface layer of stainless steel. Abrasive

pads, steel wool, or metal implements will abrade surfaces causing damage to this protective coating and will eventually result in areas of corrosion. Even water, particularly hard water that contains high to moderate concentrations of chloride, will cause oxidation and pitting that result in rust and corrosion. In addition, many acidic foods spilled and left to remain on metal surfaces are contributing factors that will corrode surfaces.



Proper cleaning agents, materials, and methods are vital to maintaining the appearance and life of this appliance. Spilled foods should be removed and the area wiped as soon as possible but at the very least, a minimum of once a day. Always thoroughly rinse surfaces after using a cleaning agent and wipe standing water as quickly as possible after rinsing.

CLEANING AGENTS

Use non-abrasive cleaning products designed for use on stainless steel surfaces. Cleaning agents must be chloride-free compounds and must not contain quaternary salts. Never use hydrochloric acid (muriatic acid) on stainless steel surfaces. Always use the proper cleaning agent at the manufacturer's recommended strength. Contact your local cleaning supplier for product recommendations.

CLEANING MATERIALS

The cleaning function can usually be accomplished with the proper cleaning agent and a soft, clean cloth. When more aggressive methods must be employed, use a non-abrasive scouring pad on difficult areas and make certain to scrub with the visible grain of surface metal to avoid surface scratches. Never use wire brushes, metal scouring pads, or scrapers to remove food residue.

 CAUTION	
	TO PROTECT STAINLESS STEEL SURFACES, COMPLETELY AVOID THE USE OF ABRASIVE CLEANING COMPOUNDS, CHLORIDE BASED CLEANERS, OR CLEANERS CONTAINING QUATERNARY SALTS. NEVER USE HYDROCHLORIC ACID (MURIATIC ACID) ON STAINLESS STEEL. NEVER USE WIRE BRUSHES, METAL SCOURING PADS OR SCRAPERS.
	
	

CARE AND CLEANING

EQUIPMENT CARE

Under normal circumstances, this oven should provide you with long and trouble free service. There is no preventative maintenance required, however, the following Equipment Care Guide will maximize the potential life and trouble free operation of this oven.



The cleanliness and appearance of this equipment will contribute considerably to operating efficiency and savory, appetizing food. Good equipment that is kept clean works better and lasts longer.

CLEAN DAILY

1. Disconnect unit from power source, and let cool.
2. Remove all detachable items such as wire shelves, side racks, and drip pans. Clean these items separately.
3. Wipe the interior metal surfaces of the oven with a paper towel to remove loose food debris.
4. Clean the interior metal surfaces of the cabinet with a damp clean cloth or sponge and any good commercial detergent.



NOTE: Avoid the use of abrasive cleaning compounds, chloride based cleaners, or cleaners containing quaternary salts. Never use hydrochloric acid (muriatic acid) on stainless steel.

5. Spray heavily soiled areas with a water soluble degreaser and let stand for 10 minutes, then remove soil with a plastic scouring pad.
6. Wipe control panel, door vents, door handles, and door gaskets thoroughly since these areas harbor food debris.
7. Rinse surfaces by wiping with sponge and clean warm water.
8. Remove excess water with sponge and wipe dry with a clean cloth or air dry. Leave doors open until interior is completely dry. Replace side racks and shelves.
9. Wipe door gaskets and control panel dry with a clean, soft cloth.
10. Interior can be wiped with a sanitizing solution after cleaning and rinsing. This solution must be approved for use on stainless steel food contact surfaces.

11. To help maintain the protective film coating on polished stainless steel, clean the exterior of the cabinet with a cleaner recommended for stainless steel surfaces. Spray the cleaning agent on a clean cloth and wipe with the grain of the stainless steel.

12. Clean any glass with a window cleaner.

Always follow appropriate state or local health (hygiene) regulations regarding all applicable cleaning and sanitation requirements for equipment.

CLEAN THE DOOR VENTS

Door vents need to be inspected and cleaned as required.

CLEAN THE PROBES DAILY

Remove all food soil from probes. Wipe entire probe and cable assembly with warm detergent solution and a clean cloth. Remove detergent by wiping each probe and cable with clean rinse water and a cloth. Wipe probes and probe brackets with disposable alcohol pad or sanitizing solution recommended for food contact surfaces. Allow probe and cable to air dry in probe holding bracket.

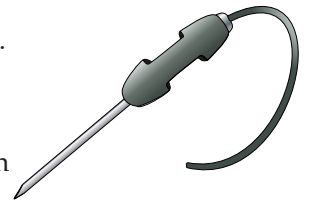

CHECK THE COOLING FAN IN THE OVEN CONTROL AREA

While the oven is warm, check that the cooling fan in the oven control area is functioning. The fan is located at the back of the unit, toward the top.

CHECK OVERALL CONDITION OF OVEN ONCE A MONTH

Check the oven once a month for physical damage and loose screws. Correct any problems before they begin to interfere with the operation of the oven.



DANGER



DISCONNECT UNIT FROM POWER SOURCE BEFORE CLEANING OR SERVICING.

DANGER



AT NO TIME SHOULD THE INTERIOR OR EXTERIOR BE STEAM CLEANED, HOSED DOWN, OR FLOODED WITH WATER OR LIQUID SOLUTION OF ANY KIND. DO NOT USE WATER JET TO CLEAN.



SEVERE DAMAGE OR ELECTRICAL HAZARD COULD RESULT.

WARRANTY BECOMES VOID IF APPLIANCE IS FLOODED

DO NOT USE OVEN IF CONTROLS ARE NOT PROPERLY FUNCTIONING

Refer to the Trouble Shooting Guide located in this manual or call an authorized service technician.

SANITATION

Food flavor and aroma are usually so closely related that it is difficult, if not impossible, to separate them. There is also an important, inseparable relationship between cleanliness and food flavor. Cleanliness, top operating efficiency, and appearance of equipment contribute considerably to savory, appetizing foods. Good equipment that is kept clean, works better and lasts longer.

Most food imparts its own particular aroma and many foods also absorb existing odors. Unfortunately, during this absorption there is no distinction between GOOD and BAD odors. The majority of objectionable flavors and odors troubling food service operations are caused by bacteria growth. Sourness, rancidity, mustiness, stale or other OFF flavors are usually the result of germ activity.

The easiest way to insure full, natural food flavor is through comprehensive cleanliness. This means good control of both visible soil (dirt) and invisible soil (germs). A thorough approach to sanitation will provide essential cleanliness. It will assure an attractive appearance of equipment, along with maximum efficiency and utility. More importantly, a good sanitation program provides one of the key elements in the prevention of food-borne illnesses.

A controlled holding environment for prepared foods is just one of the important factors involved in the prevention of food-borne illnesses. Temperature monitoring and control during receiving, storage, preparation, and the service of foods are of equal importance.

The most accurate method of measuring safe temperatures of both hot and cold foods is by internal product temperature. A quality thermometer is an effective tool for this purpose, and should be routinely used on all products that require holding at a specific temperature.

A comprehensive sanitation program should focus on the training of staff in basic sanitation procedures. This includes personal hygiene, proper handling of raw foods, cooking to a safe internal product temperature, and the routine monitoring of internal temperatures from receiving through service.

Most food-borne illnesses can be prevented through proper temperature control and a comprehensive program of sanitation. Both these factors are important to build quality service as the foundation of customer satisfaction. Safe food handling practices to prevent food-borne illness is of critical importance to the health and safety of your customers.

HACCP, an acronym for Hazard Analysis (at) Critical Control Points, is a quality control program of operating procedures to assure food integrity, quality, and safety. Taking steps necessary to augment food safety practices is both cost effective and relatively simple. While HACCP guidelines go far beyond the scope of this manual, additional information is available by contacting:

**CENTER FOR FOOD SAFETY AND APPLIED
NUTRITION FOOD AND DRUG ADMINISTRATION
1-888-SAFEFOOD**

INTERNAL FOOD PRODUCT TEMPERATURES		
HOT FOODS		
DANGER ZONE	40° TO 140°F	(4° TO 60°C)
CRITICAL ZONE	70° TO 120°F	(21° TO 49°C)
SAFE ZONE	140° TO 165°F	(60° TO 74°C)
COLD FOODS		
DANGER ZONE	ABOVE 40°F	(ABOVE 4°C)
SAFE ZONE	36° TO 40°F	(2° TO 4°C)
FROZEN FOODS		
DANGER ZONE	ABOVE 32°F	(ABOVE 0°C)
CRITICAL ZONE	0° TO 32°F	(-18° TO 0°C)
SAFE ZONE	0°F or below	(-18°C or below)

SERVICE

TROUBLE SHOOTING

Error Code	Description	Possible Cause
E-10	Cavity air sensor shorted	Cavity air sensor reading < 5°F. Verify sensor integrity. See sensor test instructions below.
E-11	Cavity air sensor open	Cavity air sensor reading > 517°F. Verify sensor integrity. See sensor test instructions below.
E-20	Product probe is shorted <i>Oven will cook in time only</i>	Product probe reading < 5°F. Verify sensor integrity. See sensor test instructions below.
E-21	Product probe is open <i>Oven will cook in time only</i>	Product Probe reading > 517°F. Verify sensor integrity. See sensor test instructions below.
E-30	Under temperature	Unit has not reached set-point for more than 90 minutes.
E-31	Over temperature	Unit has been higher than 25°F above the maximum cavity set-point for more than 2 minutes. Note: Holding Cabinets with this error code are more than 145°F higher than the maximum set-point.
E-50	Temp. measurement error	Contact factory.
E-51	Temp. measurement error	Contact factory.
E-60	Real time clock error	Data set to factory default. Ensure that date and time are correct if applicable.
E-61	Real time clock error	Contact factory.
E-78	Voltage low	Voltage below 90 VAC on a 125 VAC unit, or below 190 VAC on a 208-240 VAC unit. Correct voltage.
E-79	Voltage high	Voltage over 130 VAC on a 125 VAC unit, or over 250 VAC on a 208-240 VAC unit. Correct voltage.
E-80	EEPROM Error	Ensure that all temperatures and times are properly set. Contact factory if problem persists.
E-81	EEPROM Error	Contact factory.
E-82	EEPROM Error	Contact factory.
E-83	EEPROM Error	Contact factory.
E-85	EEPROM Error	All timers, if previously on, are now off. Possible bad EEPROM.
E-86	EEPROM Error	Stored HACCP memory corrupted. HACCP Address reset to 1. Possible bad EEPROM. Contact factory if problem persists.
E-87	EEPROM Error	Stored offsets corrupted. Offsets reset to 0. Control may need a recalibration. Possible bad EEPROM. Contact factory if problem persists.
E-88	EEPROM Error	All timer set-points are reset to 1 minute. Timers, if previously on, are now off. Possible bad EEPROM.
E-90	Button stuck	A button has been held down for >60 seconds. Adjust control. Error will reset when the problem has been resolved.
E-dS	Datakey error	Datakey digital signature incompatible. Cycle power, and install compatible Datakey if error persists.
E-dT	Datakey error	Datakey incompatible with control. Install compatible Datakey.
E-dU	Datakey unplugged	Install Datakey and cycle power to control to clear error.

Note: If in doubt, always cycle the power to the control and contact factory if the problem persists.

To test probe and air sensor:

Test probe and air sensor by placing sensor in ice water bath and using an ohmmeter set on the ohm scale. The reading should be 100 ohms resistance. If it is more than 2 ohms higher or lower, sensor needs to be replaced.

SERVICE

TROUBLE SHOOTING INTERNAL ELECTRICAL COMPONENTS

A. No power. Display will not light.

1. Verify that power is available at the outlet or junction box.
2. Verify that the circuit breaker switch on the back of the unit is turned on.
3. Verify that the power cord is not open. Check continuity with a VOM meter.
4. If none of the above steps help, call a qualified service technician or refer to the Service Manual for this particular oven.

B. Display is lit and unit calls for heat, but unit is not heating; Error Code E-30

Check to verify that the high limit switch located at the rear of the unit top has not been tripped. If it has been tripped, reset by pressing in the hit limit reset button at the rear of the oven.

After resetting, the cause of the high limit trip must be corrected. If the high limit switch will not reset, the high limit switch is defective and must be replaced. *This is a safety device and must not be jumped out or removed from the circuit.*



C. To test air sensor:

Test air sensor by placing sensor in ice water bath and using an ohmmeter set on the ohm scale. The reading should be 100 ohms resistance. If it is more than 2 ohms higher or lower, sensor needs to be replaced.

D. To test probe sensor:

Test food probe by placing in ice water bath and using an ohmmeter set on the ohm scale. The reading should be 100 ohms resistance.

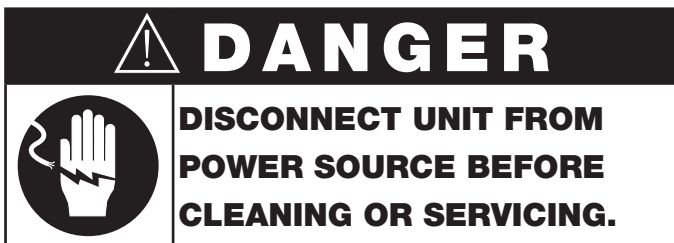

This section is provided for the assistance of qualified technicians only and is not intended for use by untrained or unauthorized service personnel. If your Alto-Shaam® unit is not operating properly, check the following before calling your Authorized Alto-Shaam® Service Agent:

- Check the power flow to the unit. Plug in outlet? Circuit breaker switch at back of unit turned on? *Do not attempt to repair or service the Cook and Hold unit beyond this point. Contact Alto-Shaam® for the nearest authorized service agent. Repairs made by any other service agents without prior authorization by Alto-Shaam® will void the warranty on the unit.*

SERVICE

AS-250 - EXTERIOR SERVICE VIEW

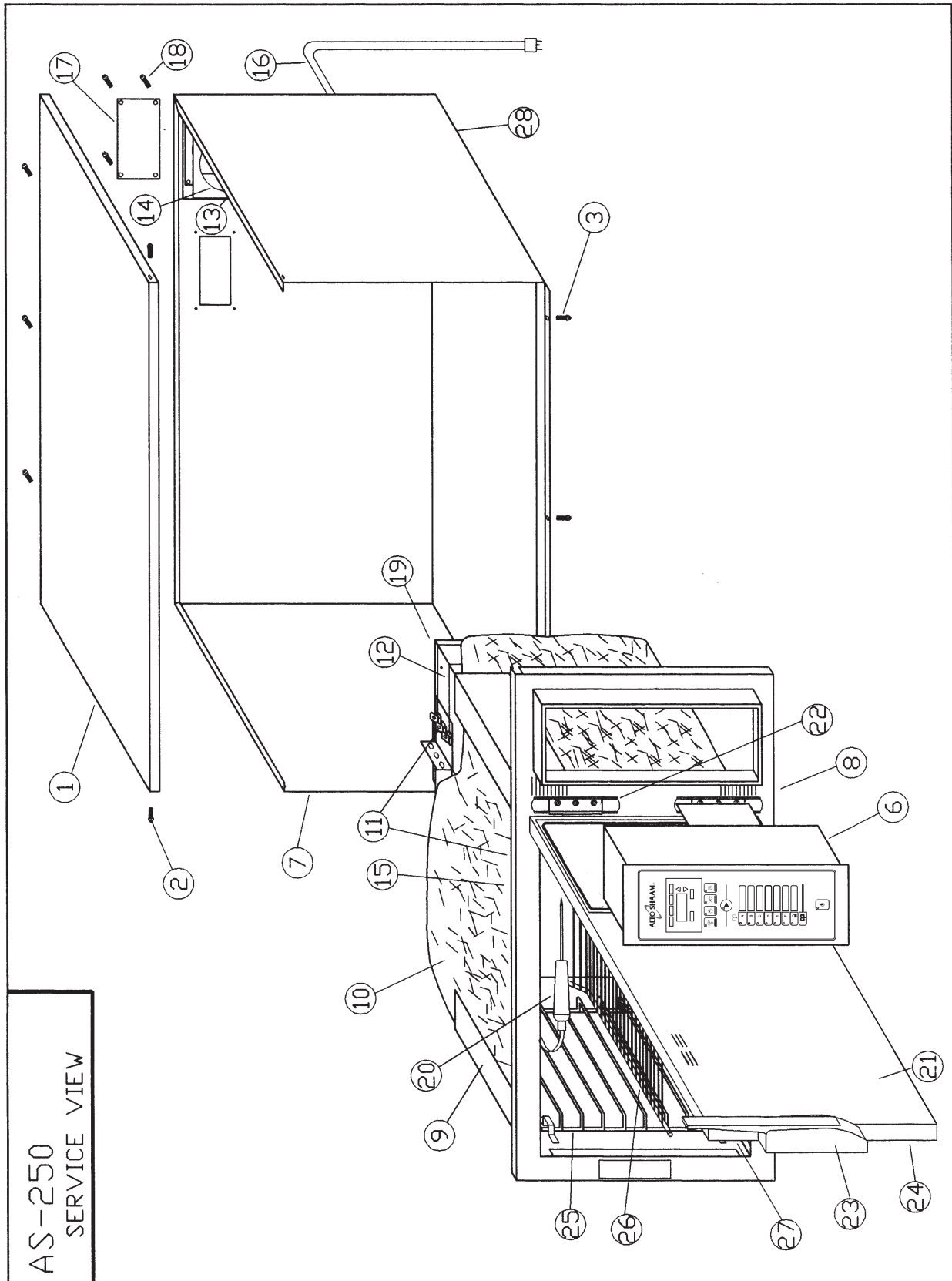

SERVICE

SERVICE VIEW - PARTS LIST

MODEL >				AS-250			
ITEM	DESCRIPTION	PART NO.	QTY	ITEM	DESCRIPTION	PART NO.	QTY
1	TOP	1820	1		SENSOR SUPPORT BRACKET	BK-2758	1
2	TOP MOUNTING SCREWS	SC-2425	5		MOUNTING SCREWS	SC-2064	1
3	TUBE ASSB. MTG. SCREWS	SC-2425	3		SENSOR GUARD	GD-2751	1
4	N/A	—	—	20	PROBE ASSEMBLY	5081	1
5	N/A	—	—		MOUNTING SCREWS	SC-2254	2
6	CONTROL ASSEMBLY	5003880	1		PROBE CABLE HOLDER	HL-2771	1
7	CASING ASSEMBLY	4812	1	21	DOOR, RIGHT-HAND	5542	1
8	INSULATION BOTTOM	1827	1	22	HINGE SET (1 Pair of 2 Hinges)	HG-2014	1
9	INSULATION CORNER	1837	2		HINGE TO DOOR MTG. SCREWS	SC-2072	6
10	INSULATION	IN-2381	1		HINGE TO UNIT MTG. SCREWS	SC-2073	6
	INSULATION	IN-22364	.5	23	DOOR HANDLE	HD-2566	1
11	CABLE CONNECTION HARDWARE	—	—		DOOR HANDLE MTG. SCREWS	SC-2073	4
12	HEATING CABLE: Length 70' (21336mm)	4878	1		DOOR CATCH MTG. SCREWS	SC-2162	2
13	POWER SWITCH	SW-3563	1	24	DOOR GASKET: Length 6.1' (1859mm)	GS-2398	1
14	FAN (125V)	FA-3599	1	25	SIDE RACK	SR-2781	2
	FAN (230V)	FA-3568	1	26	SHELF	SH-2786	1
	FAN GUARD	GD-2396	1	27	PAN	PN-2122	1
	FAN GUARD MTG. SCREWS	SC-2661	4	28	LEGS	11547	2
15	FAN BI-METAL THERMOSTAT	TT-3562	1		LEG MOUNTING SCREWS	SC-2464	4
	MOUNTING SCREWS	SC-2459	2	29	N/A	—	—
	THERMOSTAT, MANUAL RESET	TT-3859	2	30	RELAY (NOT SHOWN)	RL-33829	1
16	CORD SET, 125V, 9'	CD-3232	1	31	T-BLOCK (NOT SHOWN)	BK-33546	1
	CORD SET, 230V, 9'	CD-3922	1	32	POWER SUPPLY BOARD (NOT SHOWN)	BA-33554	1
17	SENSOR PLATE	11324	1	33	N/A	—	—
18	SENSOR PLATE MOUNTING SCREWS	SC-2459	4	34	BEEPER (NOT SHOWN)	BP-3567	1
19	OVEN SENSOR (NOT SHOWN)	SN-3560	1	35	CONTROL PANEL OVERLAY	PE-26344	1
	MOUNTING SCREWS	SC-2472	2				

CABLE HEATING KIT #4878

DESCRIPTION	PART NO.	QTY
CABLE HEATING ELEMENT	CB-3045	85 FT
RING CONNECTOR	CR-3226	4
INSULATION CORNER	IN-3488	1 FT
SHOULDER BUSHING	BU-3105	4
CUP BUSHING	BU-3106	4
STUD	ST-2439	4
HEX NUT	NU-2215	8
INSULATING SLEEVE	SL-3063	4
ELECTRICAL TAPE	TA-3540	1 ROLL

DANGER



DISCONNECT UNIT FROM
POWER SOURCE BEFORE
CLEANING OR SERVICING.

DANGER



LOCK-OUT OR POST
BREAKER PANEL UNTIL
SERVICE WORK HAS
BEEN COMPLETED.

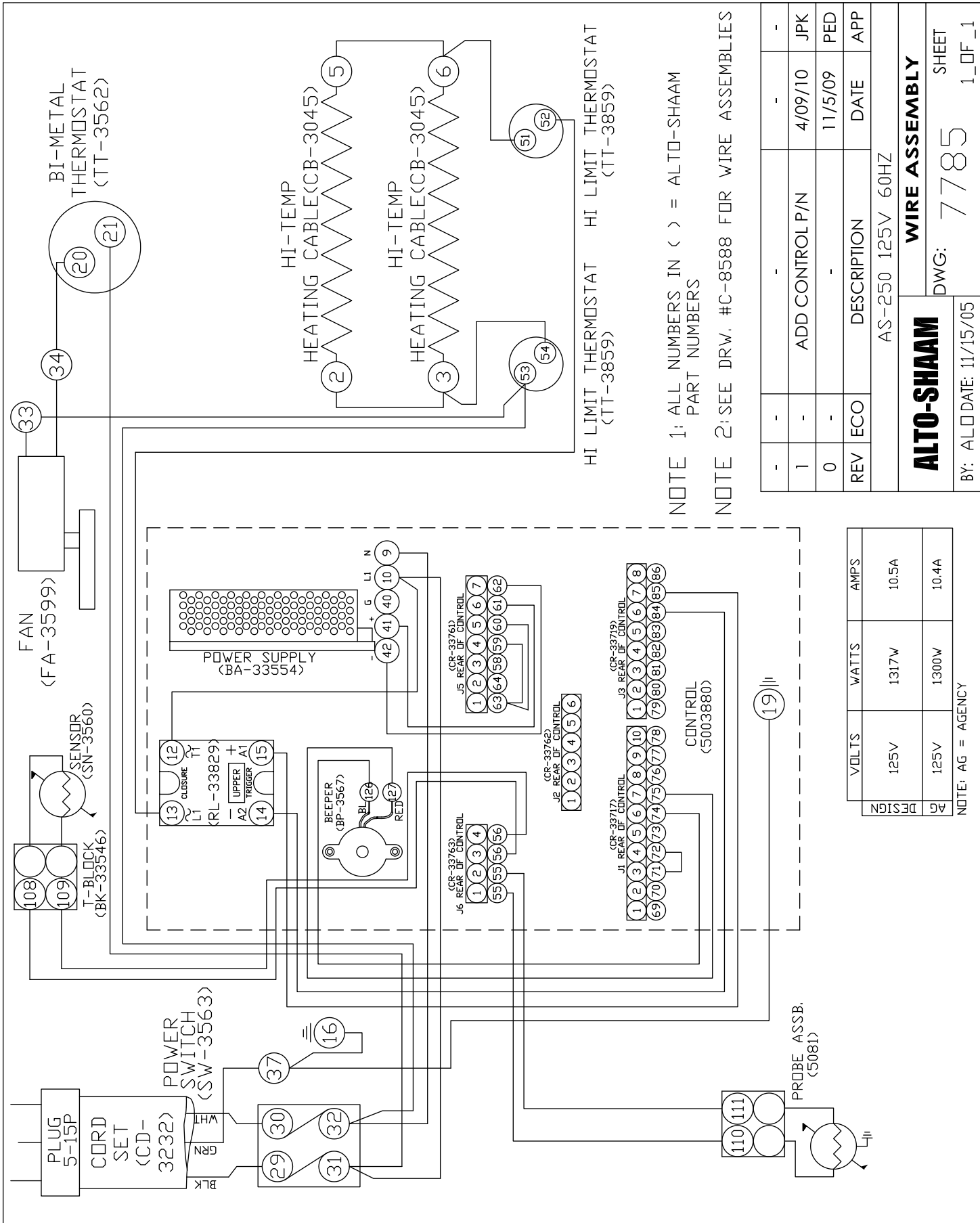

HI LIMIT THERMOSTAT HI LIMIT THERMOSTAT
 (TT-3859) (TT-3859)

NOTE 1: ALL NUMBERS IN () = ALTO-SHAAM PART NUMBERS

NOTE 2: SEE DRW. #C-8588 FOR WIRE ASSEMBLIES

REV	ECO	DESCRIPTION	DATE	APP
1	-	ADD CONTROL P/N	4/09/10	JPK
0	-	-	11/5/09	PED

AS-250 125V 60HZ				
ALTO-SHAAM				
WIRE ASSEMBLY				
BY: ALTO	DATE: 11/15/05	DWG: 7785	SHEET	1_OF_1

DESIGN	VOLTS	WATTS	AMPS
A1	125V	1317W	10.5A
A2	125V	1300W	10.4A

NOTE: AG = AGENCY

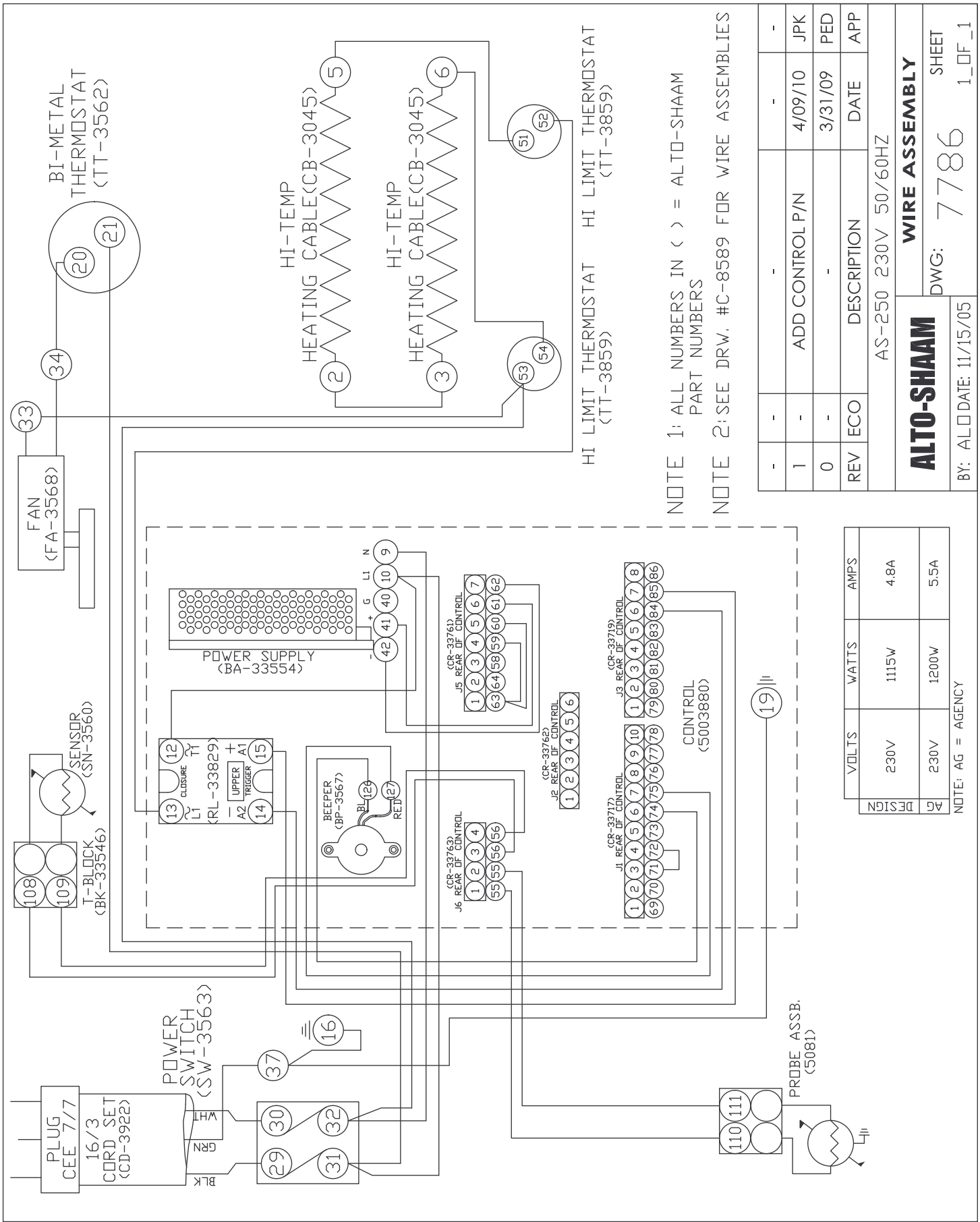

NOTE 1: ALL NUMBERS IN () = ALTO-SHAAM PART NUMBERS

NOTE 2: SEE DRW. #C-8589 FOR WIRE ASSEMBLIES

REV	ECO	DESCRIPTION	DATE	APP
1	-	ADD CONTROL P/N	4/09/10	JPK
0	-	-	3/31/09	PED

AS-250 230V 50/60HZ	
ALTO-SHAAM	WIRE ASSEMBLY
DWG: 7786	SHEET 1_OF_1
BY: ALD	DATE: 11/15/05

VOLTS	WATTS	AMPS
230V	1115W	4.8A
230V	1200W	5.5A

NOTE: AG = AGENCY

TRANSPORTATION DAMAGE and CLAIMS



All Alto-Shaam equipment is sold F.O.B. shipping point, and when accepted by the carrier, such shipments become the property of the consignee.

Should damage occur in shipment, it is a matter between the carrier and the consignee. In such cases, the carrier is assumed to be responsible for the safe delivery of the merchandise, unless negligence can be established on the part of the shipper.

1. Make an immediate inspection while the equipment is still in the truck or immediately after it is moved to the receiving area. Do not wait until after the material is moved to a storage area.
2. Do not sign a delivery receipt or a freight bill until you have made a proper count and inspection of all merchandise received.
3. Note all damage to packages directly on the carrier's delivery receipt.
4. Make certain the driver signs this receipt. If he refuses to sign, make a notation of this refusal on the receipt.
5. If the driver refuses to allow inspection, write the following on the delivery receipt:
Driver refuses to allow inspection of containers for visible damage.
6. Telephone the carrier's office immediately upon finding damage, and request an inspection. Mail a written confirmation of the time, date, and the person called.
7. Save any packages and packing material for further inspection by the carrier.
8. Promptly file a written claim with the carrier and attach copies of all supporting paperwork.

We will continue our policy of assisting our customers in collecting claims which have been properly filed and actively pursued. We cannot, however, file any damage claims for you, assume the responsibility of any claims, or accept deductions in payment for such claims.

LIMITED WARRANTY

Alto-Shaam, Inc. warrants to the original purchaser only that any original part that is found to be defective in material or workmanship will, at Alto-Shaam's option, subject to provisions hereinafter stated, be replaced with a new or rebuilt part.

The parts warranty period is as follows:

For the refrigeration compressor on Alto-Shaam Quickchillers™, five (5) years from the date of installation.

For the heating element on Halo Heat® cook/hold ovens, as long as the original purchaser owns the oven.

For all other parts, one (1) year from the date of installation or fifteen (15) months from the shipping date, whichever occurs first.

The labor warranty period is one (1) year from the date of installation or fifteen (15) months from the shipping date, whichever occurs first.

Alto-Shaam will bear normal labor charges performed during standard business hours, excluding overtime, holiday rates or any additional fees.

To be valid, a warranty claim must be asserted during the applicable warranty period. This warranty is not transferable.

THIS WARRANTY DOES NOT APPLY TO:

1. Calibration.
2. Replacement of light bulbs, door gaskets, and/or the replacement of glass due to damage of any kind.
3. Equipment damage caused by accident, shipping, improper installation or alteration.
4. Equipment used under conditions of abuse, misuse, carelessness or abnormal conditions, including but not limited to, equipment subjected to harsh or inappropriate chemicals, including but not limited to, compounds containing chloride or quaternary salts, poor water quality, or equipment with missing or altered serial numbers.
5. Damage incurred as a direct result of poor water quality, inadequate maintenance of steam generators and/or surfaces affected by water quality. Water quality and required maintenance of steam generating equipment is the responsibility of the owner/operator.
6. Damage caused by use of any cleaning agent other than Alto-Shaam's Combitherm® Cleaner, including but not limited to damage due to chlorine or other harmful chemicals. **Use of Alto-Shaam's Combitherm® Cleaner on Combitherm® ovens is highly recommended.**
7. Any losses or damage resulting from malfunction, including loss of product or consequential or incidental damages of any kind.
8. Equipment modified in any manner from original model, substitution of parts other than factory authorized parts, removal of any parts including legs, or addition of any parts.

This warranty is exclusive and is in lieu of all other warranties, express or implied, including the implied warranties of merchantability and fitness for a particular purpose. In no event shall Alto-Shaam be liable for loss of use, loss of revenue or profit, or loss of product, or for any indirect, special, incidental, or consequential damages. No person except an officer of Alto-Shaam, Inc. is authorized to modify this warranty or to incur on behalf of Alto-Shaam any other obligation or liability in connection with Alto-Shaam equipment.

Effective 09/10



RECORD THE MODEL AND SERIAL NUMBER OF THE APPLIANCE FOR EASY REFERENCE.

ALWAYS REFER TO BOTH MODEL AND SERIAL NUMBER IN ANY CONTACT WITH ALTO-SHAAM REGARDING THIS APPLIANCE.

Model: _____ Date Installed: _____
Voltage: _____ Purchased From: _____
Serial Number: _____

W164 N9221 Water Street • P.O. Box 450 • Menomonee Falls, Wisconsin 53052-0450 • U.S.A.

PHONE: 262.251.3800 • 800.558-8744 USA/CANADA FAX: 262.251.7067 • 800.329.8744 U.S.A. ONLY

www.alto-shaam.com

PRINTED IN U.S.A.

Free Manuals Download Website

<http://myh66.com>

<http://usermanuals.us>

<http://www.somanuals.com>

<http://www.4manuals.cc>

<http://www.manual-lib.com>

<http://www.404manual.com>

<http://www.luxmanual.com>

<http://aubethermostatmanual.com>

Golf course search by state

<http://golfingnear.com>

Email search by domain

<http://emailbydomain.com>

Auto manuals search

<http://auto.somanuals.com>

TV manuals search

<http://tv.somanuals.com>