

# ***Amana***<sup>®</sup>

## **Double Electric Self-Cleaning EvenAir<sup>™</sup> Convection *Plus* Wall Oven Owner's Manual**

### **AOCD2770\***

\* Additional alphanumeric characters representing other models in series may follow each model number.

**Please Read Manual Before Operating Oven**

#### **Important**

Save for local electrical inspector's use.

#### **Installer**

Leave this manual and other literature with consumer for future use.

#### **Customer**

Keep these instructions for future reference. If appliance changes ownership, be sure this manual accompanies oven.

Para recibir un manual en español gratis, envíe por correo o por fax su nombre, dirección, y número de modelo a:

Amana Appliances  
Consumer Communications/Spanish Manual  
2800 220th Trail  
PO Box 8901  
Amana, Iowa 52204-0001  
USA

# Contents

---

Model Identification .....	2
Parts and Accessories .....	2
Service .....	2
Asure™ Extended Service Plan .....	2
Important Safety Information .....	3
ALL APPLIANCES .....	3
SELF-CLEANING OVEN .....	3
OVEN .....	3
Delayed Ignition .....	4
In Case of Fire .....	4
Precautions .....	4
Installation	
Packing Material .....	4
Oven Location .....	4
Cabinet Opening .....	4
Electrical Supply Location .....	4
Electrical Connection Requirements .....	4
Electrical Connection .....	5
Place Oven in Wall .....	5
Removal and Replacement of Oven .....	5
Operation	
Oven Elements and Convection Fan Location .....	6
Cooking Methods .....	7
Oven Control .....	8
Flashing Display .....	11
Setting Electronic Clock .....	11
Setting Electronic Timer .....	11
Prepare to Bake .....	11
Baking, Convection, or Convection Baking .....	13
Timed Baking, Convection, or Convection Baking .....	13
Delayed Baking, Convection, or Convection Baking .....	14
Prepare for Broiling .....	14
Broiling or Convection Broiling .....	14
Hold .....	14
Prepare for Slo-Cook™ .....	15
Slo-Cook™ .....	15
Timed Slo-Cook™ .....	15
Delayed Slo-Cook™ .....	16
Defrost .....	16
Dehydration .....	16
Prepare for Self-clean and .....	17
Delayed Self-clean Cycle .....	17
Self-cleaning .....	17
Delayed Self-clean Cycle .....	17
Care and Cleaning	
Removing Oven Door .....	18
Replacing Oven Light .....	18
Cleaning .....	19
Before Calling for Service .....	20
Warranty .....	21

Cooking Guide .....	22
Baking Guide .....	22
Broiling Guide .....	22
Poultry Roasting Guide .....	23
Beef and Pork Roasting Guide .....	23
Convection Baking Guide .....	24
Convection Broiling Guide .....	24
Convection Poultry Roasting Guide .....	25
Convection Beef and Pork Roasting Guide .....	25
Slo-Cook™ Recipes .....	26
Menu Dish Recipes .....	26
Slo-Cook™ Menu Meals .....	29
Quick Reference Instructions .....	32

## Model Identification

Complete enclosed registration card and promptly return. If registration card is missing, call Consumer Affairs Department at 1-800-843-0304 inside U.S.A. 319-622-5511 outside U.S.A. When contacting Amana, provide product information located on rating plate. Rating plate is located on the oven frame. Record the following:

Model Number: \_\_\_\_\_  
Manufacturing Number: \_\_\_\_\_  
Serial or S/N Number: \_\_\_\_\_  
Date of purchase: \_\_\_\_\_  
Dealer's name and address: \_\_\_\_\_  
\_\_\_\_\_  
\_\_\_\_\_

## Parts and Accessories

Purchase replacement parts and additional accessories (e.g., refrigerator shelves, dryer racks, or cooktop modules) over the phone. To order accessories for your Amana product, call 1-800-843-0304 inside U.S.A. or 319-622-5511 outside U.S.A.

## Service

Keep a copy of sales receipt for future reference or in case warranty service is required. Any questions or to locate an authorized servicer, call 1-800-NAT-LSVC (1-800-628-5782) inside U.S.A. 319-622-5511 outside U.S.A. Warranty service must be performed by an authorized servicer. Amana, also recommends contacting an authorized servicer if service is required after warranty expires.

## Asure™ Extended Service Plan

Amana offers long-term service protection for this new oven. Asure™ Extended Service Plan is specially designed to supplement Amana's strong warranty. This plan covers parts, labor, and travel charges. Call 1-800-528-2682 for information.

# IMPORTANT SAFETY INFORMATION

---



## WARNING

To avoid personal injury, do not sit, stand or lean on oven door.



## WARNING

To avoid risk of electrical shock, personal injury, or death, make sure your oven has been properly grounded and always disconnect it from main power supply before any servicing.



## CAUTION

This appliance contains or produces a chemical or chemicals which can cause death or serious illness and which are known to the state of California to cause cancer, birth defects or other reproductive harm. To reduce the risk from substances in the fuel or from fuel combustion make sure this appliance is installed, operated, and maintained according to the instructions in this booklet.

### ALL APPLIANCES

1. Proper Installation—Be sure your appliance is properly installed and grounded by a qualified technician.
2. Never Use Appliance for Warming or Heating the Room.
3. Do Not Leave Children Alone—Children should not be alone or unattended in the area where the appliance is in use. They should never be allowed to sit or stand on any part of the appliance.
4. Wear Proper Apparel—Loose fitting or hanging garments should never be worn while using appliance.
5. User Servicing—Do not repair or replace any part of the appliance unless specifically recommended in the manual. All other servicing should be referred to a qualified technician.
6. Storage in or on Appliance—Flammable materials should not be stored in oven.
7. Do Not Use Water on Grease Fires—Smother fire or flame, or use dry chemical or foam-type extinguisher.
8. Use Only Dry Potholders—Moist or damp potholders on hot surfaces may result in burns from steam. Do not let potholder touch burners. Do not use a towel or other bulky cloth.

### SELF-CLEANING OVEN

1. Do Not Clean Door Gasket—The door gasket is essential for a good seal. Care should be taken not to rub, damage, or move the gasket.
2. Do Not Use Oven Cleaners—No commercial oven cleaner or oven liner protective coating of any kind should be used in or around any part of the liner.
3. Clean Only Parts Listed in Manual. See *Cleaning* section.
4. Before Self-Cleaning the Oven—Remove broiler pan, oven racks, and other utensils.

### OVEN

1. Use Care When Opening Door—Let hot air or steam escape before removing or replacing food.
2. Do Not Heat Unopened Food Containers—Build-up of pressure may cause container to burst and result in injury.
3. Keep Oven Vents Ducts Unobstructed.
4. Placement of Oven Racks—Always place oven racks in desired location while oven is cool. If rack is removed while oven is hot, do not let potholder contact hot oven.

### In Case of Fire

Fires can occur as a result of over cooking or excessive grease. Though a fire is unlikely, if one occurs, proceed as follows:

#### Oven Fires

1. If you see smoke from oven, do not open oven door.
2. Turn oven control to *OFF*.
3. As an added precaution, turn off power at main circuit breaker or fuse box.
4. Turn on vent to remove smoke.
5. Allow food or grease to burn itself out in oven.
6. If smoke and fire persist, call fire department.
7. If there is any damage to components, call repair service before using oven.

### Precautions

- Do not mix household cleaning products. Chemical mixtures may interact with objectionable or even hazardous results.
- Do not put plastic items on warm cooking areas. They may stick and melt.
- Do not use damp sponge or dishcloth to clean oven when oven is hot. Steam from sponge or dishcloth can burn.
- Do not leave fat heating unless you remain nearby. Fat can ignite if overheated by spilling onto hot surfaces.

# Installation

## Packing Material

Remove protective packing material from oven. Tape residue can be cleaned with a soft cloth and alcohol. Lean oven to each side and remove shipping base.

## Oven Location

Choose a location based on following factors.

- Make sure there is adequate space for proper installation.
- Carefully read all instructions before beginning installation.
- Make sure cabinet base is level.

## Cabinet Opening

Prepare the cabinet for wall oven.

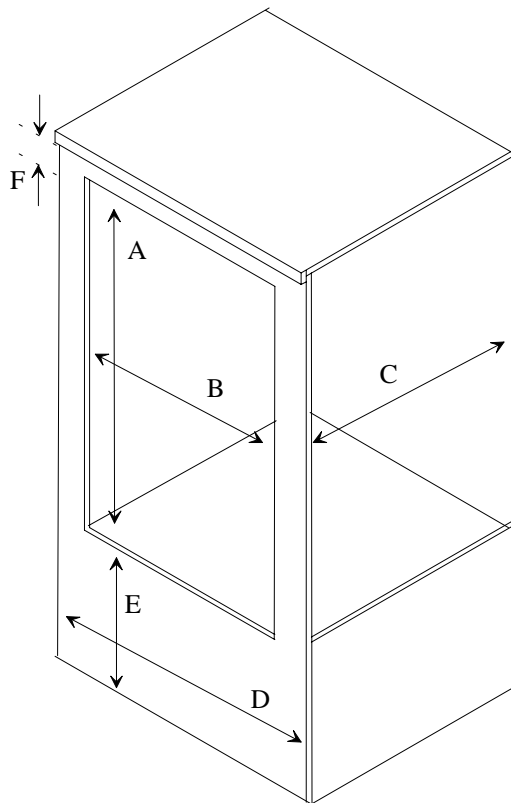

- A—52<sup>3</sup>/<sub>8</sub> inches
- B—25 inches
- C—24 inches minimum
- D—27 inches minimum
- E—12<sup>1</sup>/<sub>2</sub> inches minimum
- F—3 inches minimum

Cabinet Opening

## Electrical Supply Location

Electrical supply must be located in the area shown.

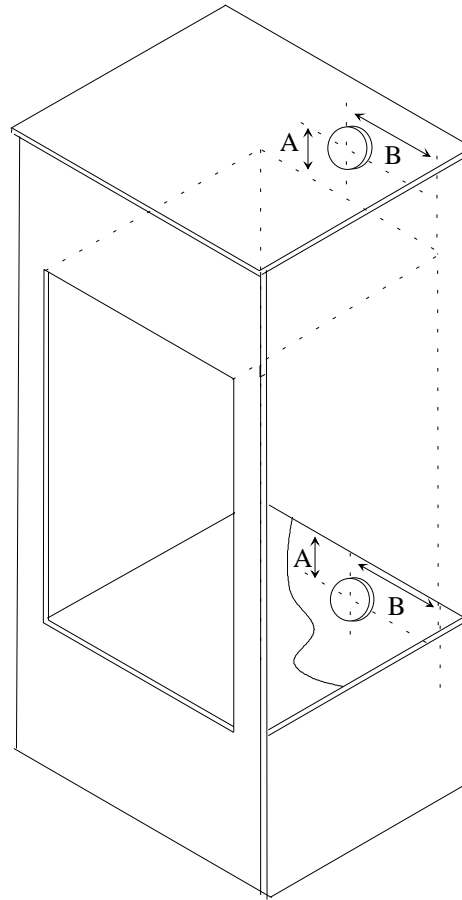

- A—5 inches
- B—16 inches

Electrical Supply Location

## Electrical Connection Requirements

Line voltage must not exceed rated voltage. Line voltage less than rated voltage will result in slow heating. Wiring system must conform to U.L. Standards and National Electrical Code. Installation must conform to all local, municipal and state building codes, and local utility regulations. Oven must be connected only to a supplied circuit as specified on rating plate.

This oven requires 3 wires, 115/230-120/240 volts, 60 Hertz A.C. Unit is equipped with a No. 10 ground wire in conduit. Oven should be fused separately from other appliances on a 40 amp circuit minimum. Verify electric power is off from fuse box to junction box until oven is installed and ready to operate.

## Electrical Connection



### WARNING

To avoid risk of personal injury or electrical shock, do not ground through neutral wire if installation is in a mobile home or if local codes do not permit grounding through a neutral.

Improper connections of aluminum house wiring to copper lead can result in property damage, personal injury or fire. Use only connectors designed for joining copper to aluminum and follow manufacturers' recommended procedure closely.

1. With oven positioned in front of cabinet opening, connect wire leads extending from conduit to junction box. Verify neutral (white) wire is connected to appropriate terminal. Check local code to see which option should be used in grounding unit.

#### Option 1

Attach oven ground wire (green or bare) to junction box (if grounded) or a suitable ground.

#### Option 2

Connect oven ground wire (green or bare) to house ground feed wire (green, bare, or white). If grounding through white wire, observe above warning.

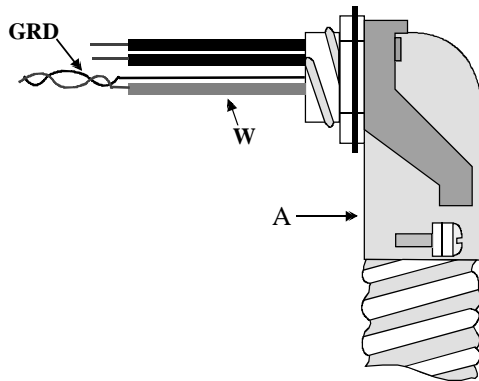

A—Conduit  
W—White neutral wire  
GRD—Bare ground wire

#### Electrical Conduit and Wires

If oven is used in a mobile home or if local codes do not permit grounding through neutral, open connection and use grounding lead to ground unit in accordance with local codes. Connect neutral lead to branch circuit neutral conductor in usual manner.

2. Connect red and black wires to appropriate house electrical wiring.
3. Verify wiring by connecting electrical power at fuse box and checking for proper operation of unit.
  - Some interior parts are finished with a protective coating of oil. When heated for first time oil will burn off and there will be some odor and smoke.

#### Place Oven in Wall

This procedure should be performed by 2 people.

1. Seal Openings in wall behind the oven or on floor under oven. Holes must be sealed before sliding oven into position.
2. Lift wall oven and slide into cutout.
3. Secure wall oven to cabinet with 4 screws.

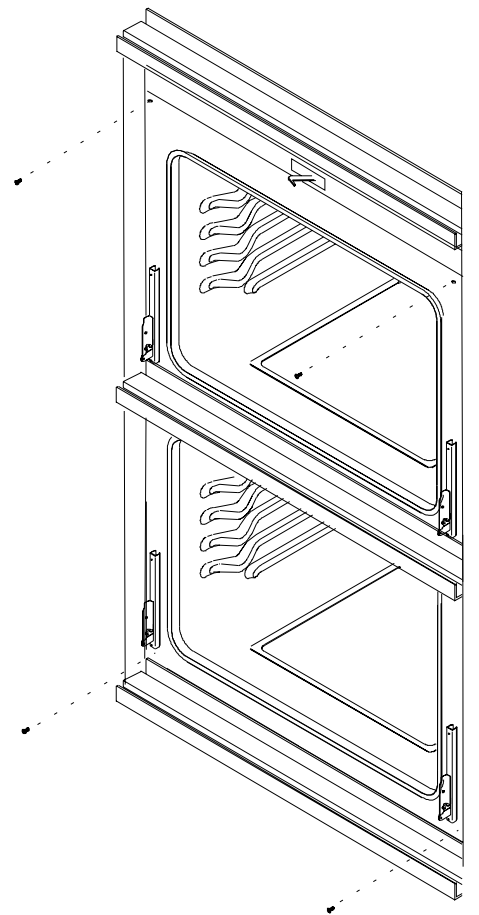

#### Place Oven in Wall

#### Removal and Replacement of Oven

1. Disconnect power to oven at circuit breaker or fuse panel.
2. Remove screws securing oven to wall.
3. Remove oven and place oven aside.
4. Disconnect electrical conduit.
5. To reinstall oven, follow instructions in *Installation* section of this manual.

# Operation

---

## Oven Elements and Convection Fan Location

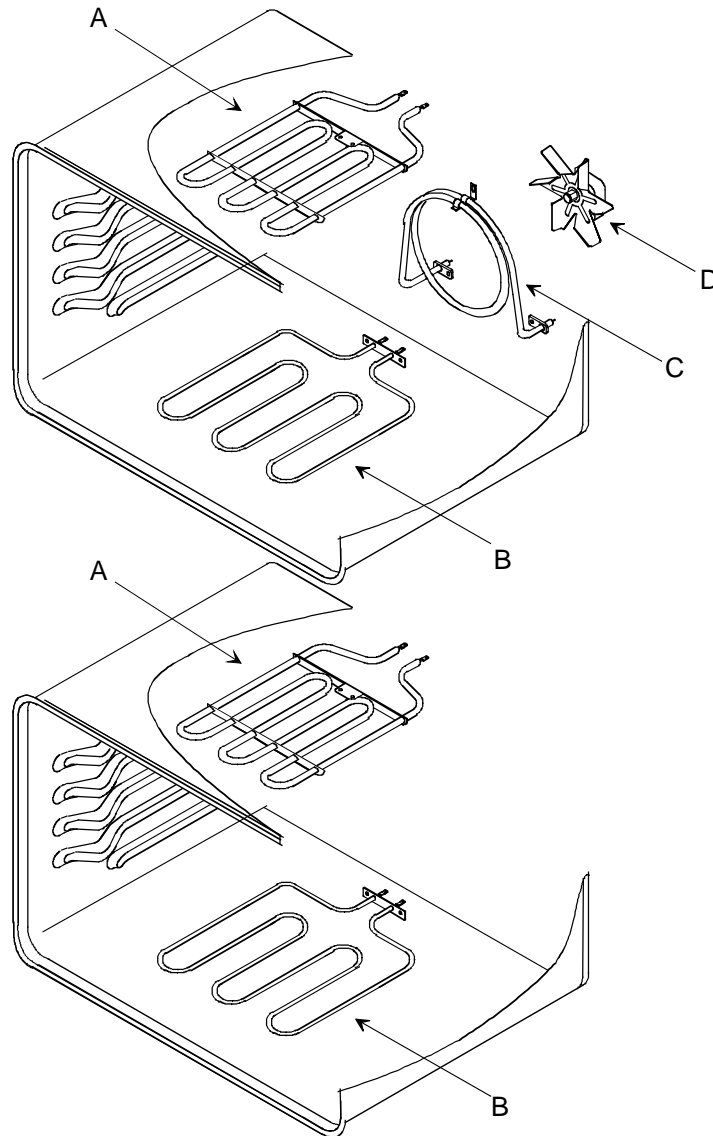



- A—Upper Element (Broil)
- B—Lower Element (Bake)
- C—Rear Element (Convection; Upper oven only)
- D—Convection Fan (Upper oven only)

---

Upper and Lower Oven Element and Fan Location

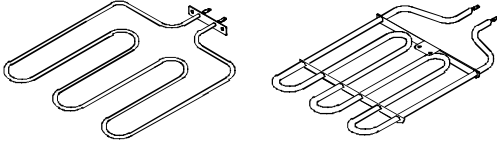
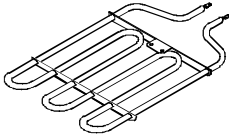
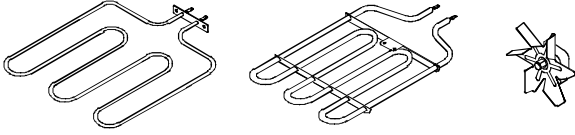
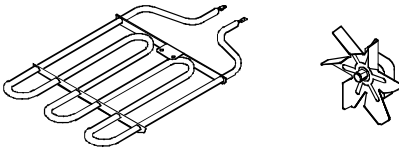
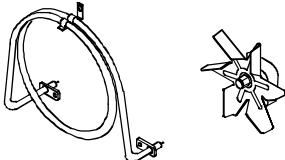
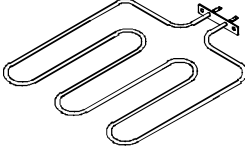
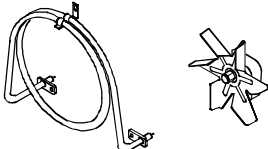
## Cooking Methods

<p><b>Bake</b> Upper and lower elements operate during bake. Upper element is only used to heat oven quickly and brown top of food. Bake can be used to cook foods which are normally baked. Oven must be preheated.</p>	
<p><b>Broil</b> Upper element operates during broil. Broil can be used to cook foods which are normally broiled. Preheating is not required when using broil. All foods should be turned at least once except fish, which does not need to be turned.</p>	
<p><b>Convection Bake</b> Upper element, lower element, and fan operate during convection bake. Upper element is only used to heat oven quickly and brown top of food. Convection bake should be used for cooking casseroles and roasting meats. Oven should be preheated for best results when using convection bake. Pans do not need to be staggered. Cooks approximately 25% quicker than bake.</p>	
<p><b>Convection Broil</b> Upper element and fan operate when using convection broil. Convection broil can be used to cook foods that are normally broiled. Oven does not require preheating when using convection broil. Food does not need to be turned during cooking when using convection roasting rack. Cooks approximately 25% quicker than broil.</p>	
<p><b>EvenAir™ Convection Plus</b> Rear element and fan operate during convection. Convection should be used for cooking pastries, souffles, yeast bread, cakes and cookies. Oven should be preheated for best results when using convection. Upper and lower elements operate during preheat. Pans do not need to be staggered. Cooks approximately 25% quicker than bake.</p>	
<p><b>Slo-Cook™, Hold</b> Uses lower element. Slo-Cook™ feature sets oven temperature to cook like a crock pot (approx. 225°F) for up to 12 hours.  The hold feature holds the oven at a low temperature (approx. 170°F) for 1 hour to keep food warm.</p>	
<p><b>Dehydrate</b> Uses rear element and convection fan at low oven temperature (approx. 170°F). Dehydration is an excellent way to preserve fresh foods.</p>	
<p><b>Defrost</b> Uses convection fan only. Defrost feature is an excellent way to thaw large food items like a turkey.</p>	

## Oven Control

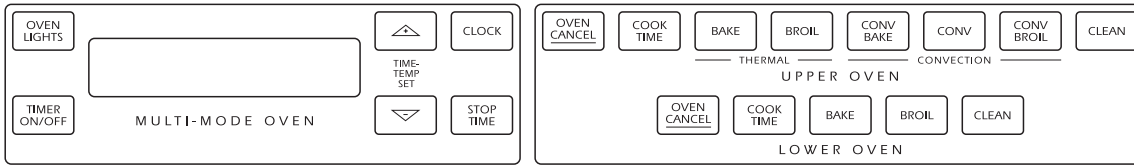

*Amana*  
CONVECTION

### Double Oven Control

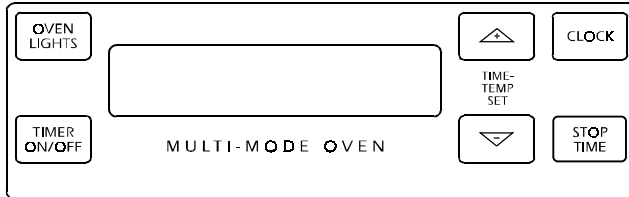

Controls clock, timer, and interior oven lights for both ovens. STOP TIME pad is used to program delayed bake and delayed clean features for both upper and lower ovens.

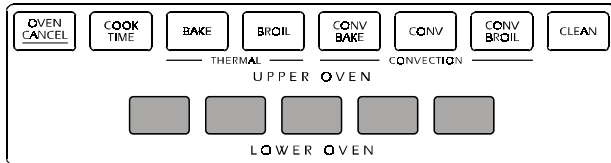

Controls upper oven settings. Any, time or temperature settings entered only effect upper oven.

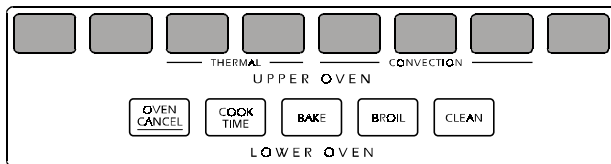

Controls lower oven settings. Any, time or temperature settings entered only effect lower oven. Convection, Convection Bake, Convection Broil, Defrost, and Dehydrate are upper oven features only.

Pad	Description
OVEN LIGHTS	Turns light on and off in both upper and lower ovens.
TIMER ON/OFF	Use to time any kitchen function or cancel timer. Does not control bake, broil, or clean function.
CLOCK	Use to set time of day.
STOP TIME	Use to set delayed bake and delayed self-clean.
OVEN <u>CANCEL</u>	Cancels any cooking or cleaning function except timer and clock.
COOK TIME	Use to set timed baking.
CLEAN	Use to select self-clean cycle.
BROIL	Use to select broil.
BAKE	Use to select bake.
CONV BAKE	Used to set upper oven to Convection Bake.
CONV	Used to set upper oven to Convection.
CONV BROIL	Used to set upper oven to Convection Broil.
▲ ▼	Use to set temperature or time.



## Display

Some items in display can be seen but will not glow.

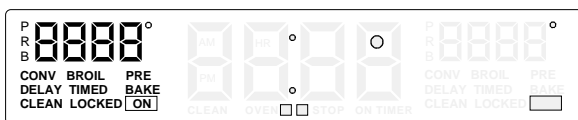

Displays temperature and cooking method or function for upper oven.



Displays time-of-day, timer and timed or delayed settings.

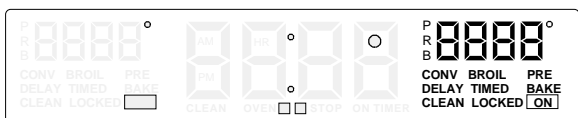

Displays temperature and cooking method or function for lower oven.

## Display Glossary

TIME AM, PM or HR	TIME AM or PM flashes in display while time-of-day is entered. TIME HR flashes when time is entered for timed or delayed baking or delayed self-cleaning.
TIMER	Flashes in display while timer is set. TIMER stops flashing and displays while time counts down.
PRE-BAKE, BAKE	BAKE flashes while bake oven temperature is entered. While oven preheats PRE-BAKE displays. After oven has reached temperature, BAKE displays.
ON	Displays when oven is heating.
OVEN 1 or 2	Flashes while time is entered for timed or delayed cooking. 1 displays when upper oven is set. 2 displays when lower oven is set.
TIMED BAKE	Flashes, then displays when a timed baking cycle is set.
DELAYED TIMED BAKE or CLEAN	Displays when delayed bake or clean self-cycle is set.
CONV	Displays when a feature using convection is set.
STOP	Displays when setting the stop time for a delayed baking or self-clean cycle.
BROIL	Flashes, then displays when a broil is set.
CLEAN	Displays when self-clean cycle is entered and set.
LOCK	LOCK flashes while oven door is locking and remains in display while door is locked. After cycle is complete and oven has cooled to a safe temperature, LOCK no longer displays and door can be opened.
HLD	Displays when oven is holding oven temperature at 170°F for 1 hour.
SLO	Displays when oven is set to Slo-Cook™ temperature. Oven cooks like crock pot for up to 12 hours.
DEF	Displays when upper oven is set to defrost mode.
DEH	Displays when upper oven is set to dehydration mode.

## Oven Signals

Preheat signal	After setting oven to bake and selecting a temperature, oven preheats. When oven reaches set temperature, 1-second signal sounds.
Timer and End-of-Cycle signal	When a timed cooking cycle is complete or time elapses on timer, three long signals sound, then once approximately every 6-8 seconds. End of cycle signal continues to sound until OVEN CANCEL pad is pushed.  If minute timer end of cycle signal is sounding, push TIMER ON/OFF pad.

## Other Features

12-hour automatic cancel	This safety feature prevents oven from continuing to operate if it has been left on for over 12 hours. If a cooking function continues longer than 12 hours without any options on oven control being touched, this feature turns oven off. Any time an option is touched, 12-hour automatic cancel is reset.
Child lockout	This safety feature is used to prevent children from accidentally programming oven by disabling electronic oven control. On the upper oven control, press and hold BAKE and COOK TIME for 5 seconds. "OFF" displays where the temperature normally appears. To reactivate control, press and hold BAKE and COOK TIME pads for 5 seconds on the upper oven control. Child lockout must be reset after a power failure.
Service codes and tones	Electronic oven control is equipped with a self diagnostic system. Self diagnostic system alerts you if there is a error or problem in the control. If electronic range control sounds a series of short, rapid beeps for over 16 seconds and display shows a F-code, record the F-code shown. Some F-codes can be cleared by touching OVEN CANCEL or disconnecting power to the range. If the code continues to reoccur call an authorized servicer. Disconnect electrical supply to range and contact an authorized servicer.  F1—Control malfunction F2—High oven temperature F3—Temperature sensor malfunction F4—Temperature sensor malfunction F7—Touch pad malfunction F9—Door lock malfunction (Door unlocked) FF—Door lock malfunction (Door locked)

## Sounds

Oven Fan	Oven cooling fan can turn on while oven is heating to cool oven control.
----------	--

## Flashing Display

When power is connected to oven display flashes. Press OVEN CANCEL to clear display.

## Setting Electronic Clock

When power is connected or restored, display flashes until pad is pressed.

1. Press CLOCK pad.
2. Press  $\Delta$  or  $\nabla$  pad until correct time-of-day displays.
  - Time increases in larger increments the longer  $\Delta$  or  $\nabla$  pad is held.
  - Clock saves time-of-day approximately 5-10 seconds after time is entered.

## Setting Electronic Timer

The timer is a timer only. Electronic timer does not control bake, broil, or self-clean function. Timer can be set up to 11 hours and 50 minutes. Up to 1 hour, timer displays minutes and seconds. After 1 hour, timer displays hours and minutes.

1. Press TIMER ON/OFF pad.
2. Press  $\Delta$  or  $\nabla$  pad until correct time displays.
  - Time increases in larger increments the longer  $\Delta$  or  $\nabla$  pad is held.
  - Timer begins counting down automatically after time is entered.
3. Press TIMER ON/OFF pad to cancel timer signal.
  - After time elapses, timer beeps 3 times, and then approximately once every 6-8 seconds until TIMER ON/OFF pad is pressed.

## Resetting and Canceling Timer

To reset the time when remaining time is displayed, press TIMER ON/OFF pad, then  $\Delta$  or  $\nabla$  pad until new time displays.

To cancel timer, press and hold TIMER ON/OFF pad for approximately 5 seconds.

Also, to cancel timer, press TIMER ON/OFF pad, then press  $\Delta$  or  $\nabla$  pad until timer displays "00".

## Prepare to Bake



## CAUTION

To reduce risk of food poisoning due to bacterial growth and production of toxins, never hold meat, milk, fish or eggs for more than 2 hours before cooking.

## Remove Items Stored in Oven

Remove any pans and other cooking utensils stored in oven.

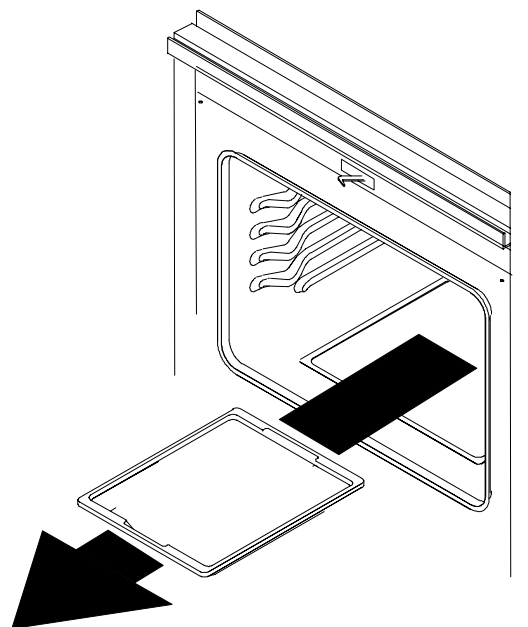

Remove Items Stored in Oven

## Oven Racks

Use Standard rack for normal baking and broiling. Spacesaver™ rack sets 1/2" off the oven floor when in lowest rack position to allow air to circulate around food and cook evenly. This rack provides more usable oven space for cooking large items or several food items at once.

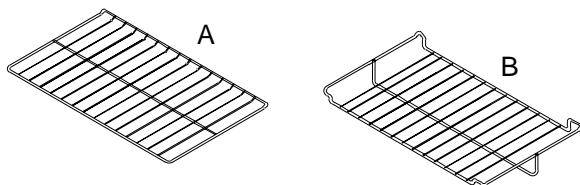

A—Standard Rack  
B—Spacesaver™ Rack

### Standard and Spacesaver™ Rack

Oven includes Slo-Cook™ trivet. This trivet should be placed in pan or roaster. Slo-Cook™ trivet elevates food keeping it out of food liquids.

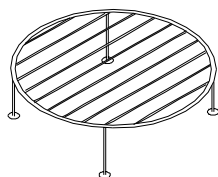

Slo-Cook™ Trivet

Oven includes a special convection roasting rack. This rack should be placed on top of broiler pan and grid. This allows air to circulate around food and cook evenly without turning. If convection roasting rack is not used, foods must be turned at least once during cooking.

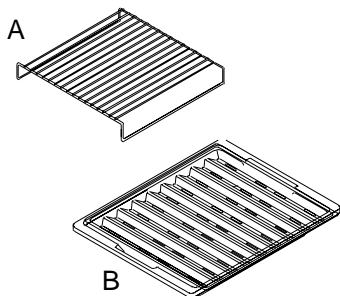

A—Convection Roasting Rack  
B—Broiling Pan and Grid

### Convection Roasting Rack, and Broiling Pan and Grid

## Oven Rack Placement

Position oven rack before turning oven on.



## WARNING

To avoid damaging oven liner or creating fire, do not line oven bottom or oven racks with foil.

1. Pull rack forward to stop position.
2. Raise front edge of rack and pull until rack is out of oven.
3. Place rack in new rack position.
  - Curved edge of rack must be toward rear of oven.

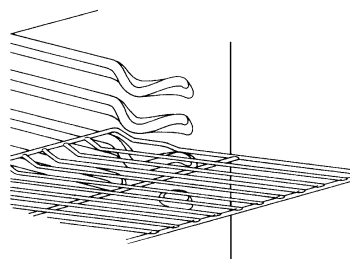

Oven Rack Placement

## Bake Pan Placement

- Keep pans and baking sheets 2 inches from oven walls.
- Stagger pans placed on different racks so one is not directly over the other.

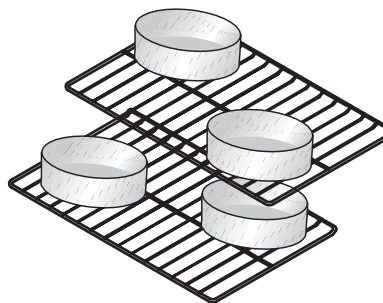

Pan Placement

### Convection Pan Placement

Baking pans and cookie sheets should not touch side or rear walls of oven. If pans are placed on different racks, they can be placed directly over each other. Convection cooking circulates air around oven providing even browning on all rack positions. When using convection, oven can be loaded on all racks with excellent cooking results.

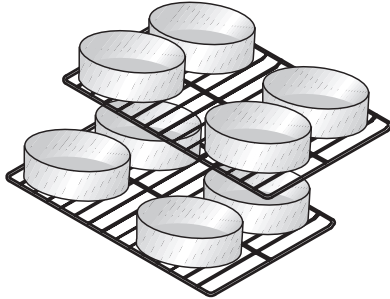

Convection Pan Placement

### Baking, Convection, or Convection Baking

Open oven door to confirm nothing is stored in oven cavity and set racks to proper height before baking. For delicate baking, preheat approximately 15–20 minutes before placing food inside oven.

1. Press BAKE, CONV, or CONV BAKE pad.
2. Press  $\Delta$  or  $\nabla$  pad until desired temperature is displayed.
  - Temperature can be set from 170°F to 550°F in 5 degree increments.
  - Temperature starts at 170°F and increases in 5° increments until reaching set temperature. Some minor smoking is normal when using oven for first time.
  - When cook temperature is reached oven signal sounds for approximately 1 second.
3. Press OVEN CANCEL pad when finished.
  - Remove food from oven when cooking time has elapsed. Food left in oven can overcook.

### Timed Baking, Convection, or Convection Baking

Set oven to cook for desired amount of time. Oven automatically stops heating after time elapses.

1. Place food in oven.
2. Press COOK TIME pad.
3. Press  $\Delta$  or  $\nabla$  pad until cooking time is displayed.
  - Cook time can be set up to 11 hours and 50 minutes.
  - 10 minutes minimum cooking time.
4. Press BAKE, CONV, or CONV BAKE pad.
5. Press  $\Delta$  or  $\nabla$  pad until desired temperature is displayed.
  - Temperature can be set from 170°F to 550°F in 5° increments.
  - Temperature display increases in 5°F increments starting at 100°F until reaching set temperature. Some minor smoking is normal when using oven for first time. When cook temperature is reached oven signals.
  - To view cook time, press and hold COOK TIME pad.
  - When cooking time has elapsed, an end of cycle signal sounds, oven automatically turns off and display returns to time of day. Oven signal sounds 3 times, then once every 3 seconds for 5 minutes or until OVEN CANCEL pad is pressed.
6. Press OVEN CANCEL pad when finished.
  - Remove food from oven when cooking time has elapsed. Food left in oven can overcook.

### To Cancel Remaining Cooking Time

Press OVEN CANCEL pad.

## Delayed Baking, Convection, or Convection Baking

Set oven to begin and end baking at later time. Oven control automatically calculates starting time.

1. Place food in oven.
2. Press STOP TIME pad.
  - Current time of day appears in display.
3. Press  $\Delta$  or  $\nabla$  pad until desired stop time displays.
  - Stop time can be set 11 hours 50 minutes ahead of current time of day.
4. Press COOK TIME pad.
5. Press  $\Delta$  or  $\nabla$  pad until desired cooking time displays.
  - 10 minutes minimum cooking time.
6. Press BAKE, CONV, or CONV BAKE pad.
7. Press  $\Delta$  or  $\nabla$  pad until desired temperature is displayed.
  - Temperature can be set from 170°F to 550°F in 5° increments.
  - Electronic oven control calculates start time.
  - When start time is reached "DELAY" no longer displays and "ON" displays.
  - To view cook time, press and hold COOK TIME pad.
  - To view stop time, press and hold STOP TIME pad.
  - When cooking time has elapsed, end of cycle signal sounds, oven automatically turns off and display returns to time of day. Oven signal sounds 3 times, then once every 3 seconds for 5 minutes or until OVEN CANCEL pad is pressed.

### To Cancel Remaining Cooking Time

Press OVEN CANCEL pad.

## Prepare for Broiling



### WARNING

To avoid risk of fire, do not line the broiler grid with foil.

- Foil may trap grease on top of grid close to burner causing a fire.
- Never leave oven unattended while broiling. Overcooking may result in a fire.

### Broiling Tips

- Remove excess fat from meat before broiling. Cut edges of meat to prevent curling.
- Place food on a cold ungreased broiling pan. If pan is hot, food sticks.
- All food except fish should be turned at least one time. Begin broiling with skin side down.
- Season meat after it has browned.
- Broiling does not require preheating.
- Begin cooking using suggested rack levels in *Broiling Guide* section to test broiler results. If food is not brown enough, cook on a higher rack position. If food is too brown, cook on a lower rack position.

## Broiling or Convection Broiling

Broiling system generates immediate, intense heat using a special reflector. This reflector focuses heat directly on the food; searing in natural juices and providing restaurant quality, charbroiled flavor.

1. Center food on broiling grid and pan, and place on rack in oven.
  - Oven door should be closed.

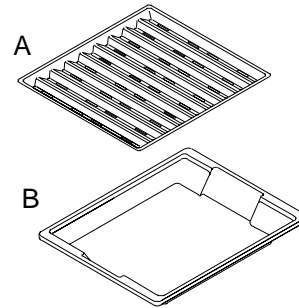

A—Broiler Grid  
B—Broiler Pan

### Broiler Pan and Grid

2. Push BROIL or CONV BROIL pad.
3. Press  $\Delta$  pad to set HI broil or  $\nabla$  pad to set lower broil temperature.
  - Temperature sets to HI or from 170°F to 545°F.

### Broiler Setting Use

Broiler Setting	Use
HI	Cooking red meats
545	Cooking pork
525	Cooking poultry
475	Cooking seafood
425	Cooking fruits and vegetables
400 and below	Toasting and warming breads

4. Press OVEN CANCEL pad when finished.

### Hold

The hold feature holds the oven at a low temperature (approx. 170°F) for 1 hour to keep food warm.

1. Press BAKE pad.
2. Press  $\nabla$  pad until 170°, then HLD is displayed.
  - If  $\nabla$  pad is held after HLD displays, SLO for Slo-Cook™ displays.
3. Press OVEN CANCEL pad when finished.
  - Remove food from oven when cooking time has elapsed. Food left in oven can overcook.

---

## Prepare for Slo-Cook™

### Facts and Hints to Remember

- **Amana's Slo-Cook™** feature simulates a traditional **crock pot** by cooking food slowly at a low temperature.
- Slo-Cook™ provides **enhanced** flavor and tenderness, since food is cooked slowly at low temperature.
- **Meats** cooked at low temperature shrink less and are more tender, thus allowing less expensive cuts of meat to be used.
- Slo-Cook™ time for **meat** varies depending on distribution and amount of fat, bone, weight, and shape.
- **Meats** may be placed on Slo-Cook™ **trivet** to avoid saturation of juices and to brown.
- **Dairy products** such as milk, cheese, sour cream, and condensed cream soups have a tendency to separate, break down, and mix with other ingredients during Slo-Cook™.
- **Fresh vegetables** tend to discolor or turn dark during Slo-Cook™. Discoloration can be avoided by using frozen or blanched vegetables.
- **Spices** are enhanced and **liquids** do not boil away when cooked slowly at low temperature.
- Food **flavors** are not mixed when cooked in the oven in separate, **covered dishes**. Covered dishes generally cook more evenly and retain moisture.
- Mixing, cooking, and serving an **entire meal** in the same oven-proof glass or stoneware can be accomplished with the Slo-Cook™ feature.
- A standard oven cavity allows **four rack positions** for placing dishes in oven for Slo-Cook™.
- **No preheating** of oven is necessary before using the Slo-Cook™ feature.
- Valuable heat loss is prevented since **stirring is not necessary** during Slo-Cook™. It is important not to open oven door during Slo-Cook™, as **heat loss** will occur resulting in extended cooking time.

### Suggested Dish Arrangements

- Determine rack level by dish size and amount of food.
- Covered dishes retain moisture better than uncovered dishes.
- Casserole items with bread or cracker topping should be left uncovered so toppings stay crisp.
- Roast should not be covered so a rich brownness can be obtained.
- Wrap food items like baking potatoes and corn on the cob in foil.
- While using Slo-cook™ feature, one-dish items such as casseroles require adding a separate dish with water. This is important as it prevents overcooking of food.

### Slo-Cook™ Trivet

Oven includes Slo-Cook™ trivet. This trivet should be placed in pan or roaster. Slo-Cook™ trivet elevates food keeping it out of food liquids.

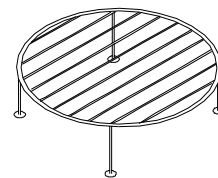

---

Slo-Cook™ Trivet

### Slo-Cook™

Slo-Cook™ feature sets oven temperature to cook like a crock pot (approx. 225°F) for up to 12 hours. Open oven door to confirm nothing is stored in oven cavity and set racks to proper height before using Slo-Cook™ feature. See "Slo-Cook™ Recipes" and "Slo-Cook™ Menu Meals" sections for recipes.

1. Press BAKE pad.
2. Press ▽ pad until 170°, then HLD, and then SLO is displayed.
3. Press OVEN CANCEL pad when finished.
  - Remove food from oven when cooking time has elapsed. Food left in oven can overcook.

### Timed Slo-Cook™

Set oven to cook for desired amount of time at crock pot temperature. Oven automatically stops heating after time elapses. See "Slo-Cook™ Recipes" and "Slo-Cook™ Menu Meals" sections for recipes.

1. Place food in oven.
2. Press COOK TIME pad.
3. Press ▲ or ▽ pad until cooking time is displayed.
  - Cook time can be set up to 11 hours and 55 minutes.
  - 10 minutes minimum cooking time.
4. Press BAKE pad.
5. Press ▽ pad until 170°, then HLD, and then SLO is displayed.
  - To view cook time, press and hold COOK TIME pad.
  - When cooking time has elapsed, an end of cycle signal sounds, oven automatically turns off and display returns to time of day. Oven signal sounds 3 times, then once every 3 seconds for 5 minutes or until OVEN CANCEL pad is pressed.
6. Press OVEN CANCEL pad when finished.
  - Remove food from oven when cooking time has elapsed. Food left in oven can overcook.

### To Cancel Remaining Cooking Time

Press OVEN CANCEL pad.

## Delayed Slo-Cook™

Set oven to begin and end cooking at later time using crock pot temperature. Oven control calculates back from end time to determine starting time. See “Slo-Cook Recipes” and “Slo-Cook Menu Meals” sections for recipes.



### CAUTION

To reduce risk of food poisoning due to bacterial growth and production of toxins, never hold meat, milk, fish or eggs for more than 2 hours before cooking.

1. Place food in oven.
2. Press STOP TIME pad.
  - Current time of day appears in display.
3. Press  $\Delta$  or  $\nabla$  pad until desired stop time displays.
  - Stop time can be set 11 hours 50 minutes ahead of current time of day.
4. Press COOK TIME pad.
5. Press  $\Delta$  or  $\nabla$  pad until desired cooking time displays.
  - 10 minutes minimum cooking time.
6. Press BAKE pad.
7. Press  $\nabla$  pad until 170°, then HLD, and then SLO is displayed.
  - Electronic oven control calculates start time.
  - When start time is reached “DELAY” no longer displays and “ON” displays.
  - To view cook time, press and hold COOK TIME pad.
  - To view stop time, press and hold STOP TIME pad.
  - When cooking time has elapsed, end of cycle signal sounds, oven automatically turns off and display returns to time of day. Oven signal sounds 3 times, then once every 3 seconds for 5 minutes or until OVEN CANCEL pad is pressed.

### To Cancel Remaining Cooking Time

Press OVEN CANCEL pad.

## Defrost

The defrost feature is an excellent way to thaw large food items like a turkey or ham. Oven does not heat during defrost.

1. Place food on dish or cookie sheet in middle of oven.
2. Open door to first stop position.
3. Press CONV BAKE pad.
4. Press  $\nabla$  until 170°, then dEF appears in display.
  - Oven is equipped with a 12 hour automatic cancel feature. If defrost time is longer than 12 hours, control will need to be reset.
5. When finished press OVEN CANCEL pad.

## Dehydration

Dehydration is an excellent way to preserve fresh foods. The best way to become familiar with dehydration is using fruits, vegetables, herbs and spices.

1. Place food on dehydration rack or cookie sheet in middle of oven.
2. Open door to first stop position.
3. Press CONV BAKE pad.
4. Press  $\nabla$  until 170°, then dEF and dEH appears in display.
  - Oven is equipped with a 12 hour automatic cancel feature. If dehydration time is longer than 12 hours, control will need to be reset.
5. When finished press OVEN CANCEL pad.

### Dehydration Tips

#### Fruits

- Always start with fresh fruit.
- Cut fruit in equal pieces approximately 1/8" thick. Thinner pieces will dry quicker.
- Fruits need to be dipped into an antioxidant, a color-keeping preservative, or two parts water and one part lemon juice. Treating fruit with an antioxidant will help it retain vitamins, color and flavor.

#### Vegetables

Most vegetables require blanching to inactivate enzymes.

#### Herbs and Spices

- Herbs and spices dry quickly.
- Check every 30 minutes to avoid over drying.
- When drying herbs, leaf clusters should be separated from stems.

Food	Drying Time	Results
Fruits		
Apples	4–6 hours	Leathery, Soft
Bananas	16–20 hours	Leathery
Vegetables		
Mushrooms (No blanching)	3–4 hours	Leathery, Soft
Carrots	3–7 hours	Dry, Brittle
Herbs and Spices		
Parsley	45–90 minutes	Dry, Crumbly
Orange/ Lemon Peel	3–7 hours	Hard, Tough



## Prepare for Self-clean and Delayed Self-clean Cycle

### **WARNING**



To avoid risk of personal injury, do not touch oven vents or areas around vents during self-cleaning. These areas can become hot enough to cause burns.

To avoid risk of smoke damage or fire, clean excess spills from oven interior.

- A small amount of smoke is normal when cleaning. Excess smoke may indicate a faulty gasket or too much food residue has been left in oven. Move birds and small animals susceptible to fumes or smoke to another room.
- Do not use cleaning cycle if oven light cover is not properly in place.
- Remove oven racks and all cooking utensils from oven.





### **Self-cleaning**

Self-clean feature uses high oven temperature to clean oven interior. Only one oven can be cleaned at a time.

1. Prepare oven for self-cleaning.
2. Press CLEAN pad.
3. Press  or  pad to adjust desired amount of cleaning time.
  - Increase or decrease cleaning time by 5 minute increments.
  - Clean can be set from 2 to 4 hours. Minimum recommended cleaning time is 3 hours.
  - "LOCK" flashes while oven door is locking and remains in display while door is locked.
  - Oven begins to clean automatically.
  - After oven has cooled to a safe temperature, "LOCK" no longer displays and door is unlocked.

### **Delayed Self-clean Cycle**

Self-clean feature uses high oven temperature to clean oven interior. Set oven to begin and end cleaning at later time using. Control calculates back from end time to determine starting time. Only one oven can be clean at a time.

1. Prepare oven for self-cleaning.
2. Press CLEAN pad.
3. Press  or  pad to adjust desired amount of cleaning time.
  - Increase or decrease cleaning time by 5 minute increments.
  - Clean can be set from 2 to 4 hours. Minimum recommended cleaning time is 3 hours.
4. Press STOP TIME pad.
5. Press  or  pad until desired stopping time appears in display.
  - Starting time is automatically calculated back based on amount of cleaning time and stop time. Oven begins to clean automatically.
  - "LOCK" flashes while oven door is locking and remains in display while door is locked.
  - To view remaining cleaning time, press and hold CLEAN pad.
  - To view calculated stop time, press and hold STOP TIME pad.
  - After oven has cooled to a safe temperature, "LOCK" no longer displays and door is unlocked.

### **Interrupt Self-Clean Cycle**

1. Press OVEN CANCEL pad.
2. After oven has cooled to a safe temperature, door can be opened.

# Care and Cleaning

---

## Removing Oven Door

### CAUTION

To avoid personal injury or property damage, handle oven door with care.

- Door is heavy and can be damaged if dropped.
  - Avoid placing hands in hinge area when door is removed. Hinge can snap closed and pinch hands.
  - Do not scratch or chip glass, or twist door. Glass may break suddenly.
  - Replace door glass if damaged.
  - Do not lift door by handle.
1. Open door fully.
  2. Remove screws.
    - Oven doors are attached with a screw on each side of oven door.
  3. Close door to first stop, grasp door firmly on each side, and lift upward until door is off hinges.
    - Do not lift door by handle. Glass or handle can break.
    - Only push hinges closed once oven door is removed if necessary. Use both hands when closing hinge. Hinge snaps closed.

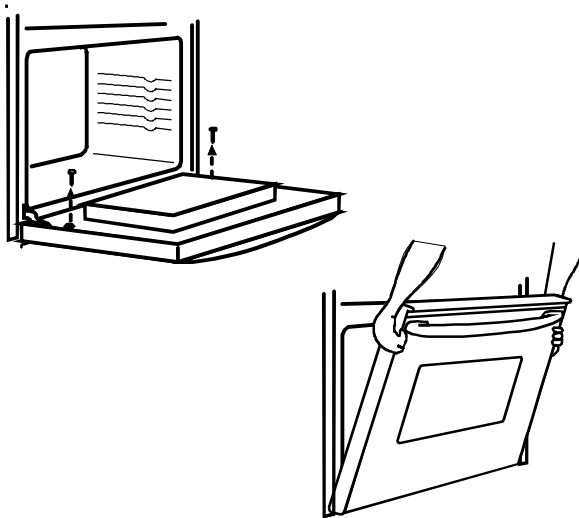

---

Removing Oven Door

## Replacing Oven Light

### WARNING

To avoid risk of burns or electrical shock, disconnect electrical supply to oven before changing light bulb.

- Before replacing light bulb make sure bulb and lens are cool.
  - Wear protective gloves.
  - Do not operate oven without bulb and lens cover in place.
1. Disconnect electrical supply.
  2. Remove oven door if desired.
  3. Unscrew light bulb cover (counterclockwise) located in rear of oven cavity. Then turn light bulb counterclockwise to remove.
  4. Replace light bulb with 120-volt, 40-watt appliance bulb.
    - Do not overtighten bulb or cover. They may be difficult to remove later.
  5. Replace light bulb cover and oven door before use.
  6. Reconnect power supply.

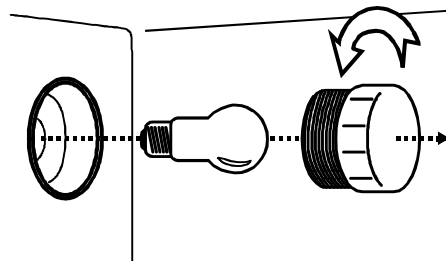

---

Replacing Oven Light

## Cleaning

Part	Materials to Use	General Directions
Heating elements		Do not clean. Any food on element will burn off.
Broiler pan and grid	Soap and a non-abrasive plastic scouring pad	Drain fat, cool pan and grid slightly. (Do not let soiled pan and grid stand in oven to cool.) Sprinkle with soap. Fill the pan with warm water. Let pan and grid stand for a few minutes. Wash or scour if necessary. Rinse and dry. The broiler pan and grid may also be cleaned in the dishwasher.
Inside oven door	Soap and water	Clean the outside of the door and the window area with warm soapy water.  <u>Oven Door Gasket</u> Do not clean the braided oven door gasket. Gasket should not be moved while cleaning. Avoid getting any cleaning materials on gasket.
Outside finish	Soap and water	Wash all glass with cloth dampened in soapy water. Rinse and polish with a dry cloth.
Oven interior surfaces	Soap and water	Cool before cleaning. Frequent wiping with mild soap and water prolongs time between self-cleanings. Be sure to rinse thoroughly.
Control panel	Soap and water	Wash with cloth dampened in soapy water. Rinse and polish with a dry cloth.
Oven racks	Soap and water	For heavy soil, clean by hand and rinse thoroughly racks for ease in cleaning. Be sure racks are dry before replacing.

# Before Calling for Service

Problem	Check
Oven light does not work.	Check for loose bulb. Check for burned out bulb; replace with 40-watt appliance bulb.
Oven does not heat.	Check circuit breaker. Check control for proper setting.
Oven door will not open.	Wait for oven to cool. Door latch will release automatically after oven cools. Do not force door.
Oven temperature is not accurate.	<p>Store purchased oven thermometers do not measure oven temperature accurately. An accurate digital thermometer is necessary to calibrate oven.</p> <p>Check for blocked heat vents.</p> <p>Aluminum foil alters oven temperature.</p> <p><b>Adjusting Oven Temperature</b></p> <p>Oven temperature has been factory calibrated and tested. If oven consistently over or under cooks food, adjust thermostat. Oven temperature can be increased or decreased 35°F. To avoid over adjusting oven, move temperature 5°F each time.</p> <ol style="list-style-type: none"> <li>1. Push BAKE pad.</li> <li>2. Press + pad until an oven temperature greater than 500°F shows in display.</li> <li>3. Immediately push and hold, approximately 5 seconds, BAKE button until "00" appears.</li> <li>4. Press + or - arrow pad to adjust oven temperature. <ul style="list-style-type: none"> <li>• To increase oven temperature (for a hotter oven), Press pad until a positive number appears in display.</li> <li>• To decrease oven temperature (for a cooler oven), Press pad until a negative number appears in display.</li> </ul> </li> <li>5. Press OVEN CANCEL pad to save adjustment. <ul style="list-style-type: none"> <li>• Setting is saved if power fails or is disconnected.</li> </ul> </li> </ol>
Oven cycles on and off.	This condition is normal when baking or roasting. To maintain a temperature for baking, oven cycles on and off. The temperature may vary up to 25°F higher or lower than the oven temperature set on the control.
The oven smokes the first few times it is turned on.	Minor smoking is normal first few times oven is used.
Fan runs while cooking.	This sound is normal. The fan cools the oven control.
Odor or smoke while self-cleaning the oven.	There may be some smoke and odor during the first few cleaning cycles. If there is excessive smoke or odor, too much soil remains in the bottom of the oven. If the oven smokes excessively, turn off the oven, wait for the oven to cool and wipe away the excess soil. Reset the self-clean cycle.

# Warranty

**Amana® WALL OVEN WARRANTY**  
**FULL ONE YEAR WARRANTY**  
**LIMITED SECOND YEAR WARRANTY ON ALL PARTS**

**FIRST YEAR**

Amana Appliances will repair or replace, including related labor and travel, any part (f.o.b. Amana, Iowa) which proves to be defective as to workmanship or materials.

**SECOND YEAR**

Amana Appliances will provide replacement part, part only (f.o.b. Amana, Iowa), which proves defective as to workmanship or materials.

**OWNER'S RESPONSIBILITIES:**

- Provide any defective part to an authorized Amana® servicer.
- Provide proof of purchase.
- Provide normal care and maintenance, including cleaning as instructed in owner's manual.
- Replace owner replaceable items where directions appear in the owner's manual.
- Make product accessible for service.
- Pay for premium service costs for service outside servicer's normal business hours.
- Pay for service calls related to product installation and customer education.
- Pay for servicer's labor and travel expenses under limited warranty provisions.

**ITEMS NOT COVERED:**

- Normal product maintenance and cleaning.
- Light bulbs.
- Damages which occur in shipment or installation.
- General rebuilding or refurbishing that is not a legitimate warranty repair.
- Failures caused by:
  - Unauthorized service.
  - Grease or other material buildup due to improper cleaning or maintenance.
  - Accidental or intentional damage.
  - Connection to an improper gas or power supply.
  - Acts of God.
  - Use of improper pans, containers, or accessories that cause damage to the product.

**WARRANTY LIMITATIONS:**

- Begins at date of original purchase.
- Product used on a commercial, rental, or leased basis are not covered by this warranty.
- Applies to product used within the United States or in Canada if product has appropriate agency listing when shipped from the factory.
- Service must be performed by an authorized Amana® servicer.
- Adjustments covered during first year only.

**WARRANTY IS VOID IF:**

- Serial plate is defaced.
- Product is altered by user.
- Product is not installed or used according to manufacturer's instructions.

**IN NO EVENT SHALL AMANA APPLIANCES BE LIABLE FOR INCIDENTAL OR CONSEQUENTIAL DAMAGES\***

\*This warranty gives you specific legal rights and you may have others which vary from state to state. For example, some states do not allow the exclusion or limitation of incidental or consequential damages so this exclusion may not apply to you.

For answers to questions regarding the above or to locate an authorized Amana® servicer, contact:

Amana Appliances  
2800 220th Trail  
PO Box 8901  
Amana, Iowa 52204-0001  
USA  
1-800-843-0304 inside U.S.A.  
1-319-622-5511 outside U.S.A.

# Cooking Guide

---

## Baking Guide

Follow these recommendations only as a guide for times and temperatures. Times, rack position, and temperatures may vary depending on conditions and food type. For best results, always check food at minimum time.

Food	Oven Temperature (°Fahrenheit)	Cooking Time (Minutes)
Angel Food Cake	350	28–50
Biscuits	350–375	8–16
Muffins	375–400	17–23
Cookies	325–350	7–18
Cupcakes	325–375	15–20
Brownies	325–350	25–35
Layer Cakes	325–350	20–30
Pound Cake	325	40–60
Fresh Pies	375–425	35–50
Nut Bread	350	45–55

## Broiling Guide

Follow these recommendations only as a guide for times and temperatures. Times, rack position, and temperatures may vary depending on conditions and food type. For best results close oven door and always check food at minimum time.

Food	Thickness (Doneness)	Rack position (1=Highest 4=Lowest)	Cooking time (Minutes)
Beef Steak	1" (med.)	3	14–16
Beef Steak	1" (well)	3	23
Beef Steak	1½" (med.)	3	23–28
Beef Steak	1½" (well)	3	33
Beef ground	(¾"–1")	4	12–17
Fish Fillets and Steaks		4	15–20
Pork Chops or Steak	1"	3	15–16
Pork Chops or Steak	1½"	3	23–28
Bacon		4	12–17
Ham Slice (pre-cooked)	½"	3	20–25
Ham Slice (pre-cooked)	1"	3	25–30

---

## Poultry Roasting Guide

Follow these recommendations only as a guide for times and temperatures. Times, rack position, and temperatures may vary depending on conditions and food type. For best results, always check food at minimum time.

Food	Oven temperature (°Fahrenheit)	Cooking time (Hours)
Whole Chicken (4 lbs to 5 lbs)	375	1½–1¾
Whole Chicken (Over 5 lbs)	375	1¾–2
Turkey (6 lbs to 8 lbs)	325	3½–4
Turkey (8 lbs to 12 lbs)	325	4–4½
Turkey (12 lbs to 16 lbs)	325	5½
Turkey (16 lbs to 20 lbs)	325	5½–7
Turkey (20 lbs to 22 lbs)	325	7–8½
Duck (3 lbs to 5 lbs)	325	1½–2

## Beef and Pork Roasting Guide

Follow these recommendations only as a guide for times and temperatures. Times, rack position, and temperatures may vary depending on conditions and food type. For best results, always check food at minimum time.

Food	Oven Temperature (°Fahrenheit)	Cooking time (Minutes per pound)
Beef Roast (Rare)	325	20–25
Beef Roast (Medium)	325	26–30
Beef Roast (Well)	325	33–35
Rolled Roast (Rare)	325	32–36
Rolled Roast (Medium)	325	36–40
Rolled Roast (Well)	325	43–45
Fresh Whole Ham	325	22–28
Pork Loin	325	35–40
Pork Shoulder, Butt	325	40–45
Pork Picnic Shoulder	325	35–40
Mild Cured Ham Picnic, Shoulder	350	30–35

---

## Convection Baking Guide

Follow these recommendations only as a guide for times and temperatures. Times, rack position, and temperatures may vary depending on conditions and food type. For best results, always check food at minimum time.

Food	Oven Temperature	Cooking Time
	(° Fahrenheit)	(Minutes)
Angel food cake	325	28–40
Biscuits	350–375	8–16
Muffins	375–400	15–23
Cookies	325–350	7–18
Cupcakes	325–375	15–20
Brownies	325–350	25–35
Layer cakes	325–350	20–30
Pound cake	325	40–60
Fresh pies	375–425	35–50
Nut Bread	350	45–55

## Convection Broiling Guide

Follow these recommendations only as a guide for times and temperatures. Times, rack position, and temperatures may vary depending on conditions and food type. For best results, always check food at minimum time.

Food	Thickness (doneness)	Rack position (1=highest 4=lowest)	Cooking time (Minutes)
Beef ground	¾"–1"	3	9–15
Beef steaks	1" (med)	2	9–15
Beef steaks	1" (well)	2	16–18
Beef steaks	1½" (med)	2	18–20
Beef steaks	1½" (well)	2	20–25
Fish fillets and steaks		3	10–16
Pork chops or steaks	1"	2	12–14
Pork chops or steaks	1½"	2	15–20
Bacon		3	7–9
Ham slices (precooked)	½"	2	10–15
Ham slices (precooked)	1"	2	15–18



---

## Convection Poultry Roasting Guide

Follow these recommendations only as a guide for times and temperatures. Times, rack position, and temperatures may vary depending on conditions and food type. For best results, always check food at minimum time.

Food	Oven temperature (°Fahrenheit)	Cooking time (Hours)
Whole chicken (4 lbs to 5 lbs)	325	1½– 2
Whole chicken (Over 5 lbs)	325	2–2½
Turkey (6 lbs to 8 lbs)	275	3–3½
Turkey (8 lbs to 12 lbs)	275	3½–4½
Turkey (12 lbs to 16 lbs)	275	4½–5½
Turkey (16 lbs to 20 lbs)	275	5–7
Turkey (20 lbs to 22 lbs)	275	7–8
Duck (3 lbs to 5 lbs)	275	1–1½
Goose (6 lbs to 8 lbs)	275	1–1½

## Convection Beef and Pork Roasting Guide

Follow these recommendations only as a guide for times and temperatures. Times, rack position, and temperatures may vary depending on conditions and food type. For best results, always check food at minimum time.

Food	Oven temperature (°Fahrenheit)	Cooking time (Minutes per pound)
Beef roast (rare)	275	15–20
Beef roast (medium)	275	25–30
Beef roast (well)	275	35–45
Rolled roast (rare)	275	20–25
Rolled roast (medium)	275	25–35
Rolled roast (well)	275	35–45
Fresh whole ham	275	20–25
Pork loin	275	30–35
Pork shoulder, butt	275	35–40
Pork picnic shoulder	275	30–35
Mild cured ham picnic shoulder	275	20–35

# Slo-Cook™ Recipes

---

## Menu Dish Recipes

### Beef Stew

8 to 10 hours

2 lbs. Beef (cut into 1-½" cubes)

3 Potatoes large

4 Carrots medium

2 Onions medium

12 oz. V-8 Juice

1 teaspoon Worcestershire sauce

1 Clove garlic

1 Bay leaf

1-½ teaspoon salt

1 teaspoon sugar

½ teaspoon pepper

2 tablespoons Tapioca

Cut beef in 1-½" cubes; peel and quarter potatoes; scrap or peel carrots and cut in thick slices or chunks; peel onions and quarter.

Put all ingredients in a deep cooking container or 3 qt. ovenproof casserole dish in order listed.

Mix seasonings with V-8 juice and pour over main ingredients. Stir just enough to mix. Cover and Slo-Cook™ 8 to 10 hours in center of rack at the lowest rack level.

Slo-Cook™ in center of rack at the lowest rack level.

### Chili Con Carne

8 to 10 hours

2 lbs. Ground Beef

2 cans (15-½ oz.) Red Kidney Beans

1 can (32 oz.) Tomato Juice

1 large onion chopped

1 Clove garlic crushed

1 oz. Chili Powder or season to taste

1 tablespoon Vinegar

In a large skillet add ground beef and brown over medium heat. Separate into small pieces with a fork or spoon.

Drain. Put browned ground beef in large ovenproof container for Slo-Cooking. Add other ingredients and mix well. Cover and Slo-Cook™ 8 to 10 hours in center of rack at the lowest rack level.

### Beef Pot Roast With Vegetables

8 to 10 hours

3 lbs. Beef Chuck Roast

6 Carrots

4 Potatoes

3 Medium Onions

2-6 oz. cans V-8 Juice

1 teaspoon Worcestershire sauce

1 Clove garlic crushed

1 Bay leaf

1-½ teaspoon salt

1 teaspoon sugar

½ teaspoon pepper

2 tablespoons Tapioca

Prepare carrots, potatoes, and onions by peeling and cutting into chunks. Put these ingredients in large ovenproof dish.

Add seasonings to the V-8 juice and mix or shake thoroughly (a shaker can be made by using a small jar with a lid). Pour over meat and vegetables. Cover and Slo-Cook™ 8 to 10 hours in center of oven rack at the lowest rack level.

### Sausage and Rice Casserole

4 to 5 hours

1 lb. mild Sausage

1 Onion chopped

1 Bell Pepper chopped

1 cup Rice (pre-cooked or quick cooking)

1 jar (4 oz.) Pimento

1 cup grated sharp Cheese

1 can Cream of Chicken Soup

1 can Cream of Mushroom Soup

Break or cut sausage into small pieces and brown in skillet. Drain. Put drained sausage and the other ingredients listed into a large bowl for stirring. After stirring put into a 2 qt. ovenproof casserole dish. Cover and place in center of rack in third rack level from the bottom. Put 5 cups cold faucet water in an ovenproof dish and place in center of rack at the lowest rack level. **Do not** cover water load. Slo-Cook™ 4 to 5 hours.

Cover casserole and place in center of rack in third rack level from the bottom. **Add** additional water load.

---

## Chicken and Dressing

8 to 10 hours

### Chicken

3 to 3-½ lbs. Chicken

Salt

Pepper

Vegetable Oil

Paprika

Salt and pepper to taste cavity of chicken. Rub chicken with vegetable oil on the outside and sprinkle with paprika. Place on meat rack breast up in 3 qt. casserole dish. Cover and Slo-Cook™ on second rack level position from the bottom.

### Dressing

1 pkg. 8 oz. Herb stuffing mix

½ cup water

¼ lb. oleo or butter

1 egg beaten

¼ cup chopped celery

¼ cup chopped onion

1 jar 2-½ oz. chopped mushrooms

Heat water and melt butter in hot water. Add herb stuffing mix and the other ingredients. Mix ingredients just enough to blend. Spread evenly in an 8 x 8 x 2 ovenproof dish. Cover with aluminum foil and place beside chicken on the oven rack in second rack level position from the bottom.

**Do not** add additional food to oven. **Do not** stuff cavity of chicken.

## Sherried Chicken and Wild Rice

4 to 5 hours

### Sherried Chicken

6 Chicken breast skinned

1 package Onion soup mix

Salt and pepper to taste

1 can 4 oz. sliced mushrooms retain half the liquid

¾ cup Cooking Sherry

Butter or margarine

Line an ovenproof dish with aluminum foil. (Use enough foil so that you will be able to fold foil for making a sealed package). Sprinkle onion soup mix on foil. Place chicken breast on top of the onion soup. Salt and pepper to taste and dot chicken with butter. Pour sherry and sliced mushrooms with liquid over the chicken breast.

Fold foil to make a tightly sealed package so that steam will not escape.

Slo-Cook™ 4 to 5 hours on lowest oven rack level.

Serve with wild rice saving the juices from the chicken to pour over the rice.

## Baked Wild Rice

1 cup long grain and wild rice mixed

2-½ cups water

3 tablespoons butter

½ teaspoon salt

Put all ingredients in buttered 1-½ quart ovenproof dish. Stir. Cover dish with aluminum foil. Slo-Cook™ beside the sherried chicken on the lowest oven rack level.

## Chicken Cacciatore

6 to 7 hours

3 lbs. Chicken, cut in pieces

1 Onion, slice thin

1 can 8 oz. Tomato Sauce

1 teaspoon Oregano

1 teaspoon Celery Salt

¼ cup White Cooking Wine

2 cloves Garlic, minced

½ teaspoon Basil

½ teaspoon Pepper

1 can 28 oz. Tomatoes

3 tablespoons Vegetable Oil

Heat vegetable oil in skillet, lightly brown chicken pieces. After browning, place chicken pieces in a deep ovenproof dish and arrange onion slices on top. Combine the other ingredients and pour over the chicken and onion slices. Cover and Slo-Cook™ 6 to 7 hours on the lowest oven rack level.

Serve over hot buttered spaghetti or noodles.

## Italian Spaghetti Sauce

7 to 9 hours

2 lbs. Ground Beef

1 large Onion chopped

4 cloves Garlic, minced

2 cans (4 oz.) sliced Mushrooms with liquid

¼ cup chopped Parsley

2 cans (28 oz.) Tomatoes

4 cans (8 oz.) seasoned Tomato Sauce

2 cans (6 oz.) Tomato Paste

1 tablespoon Oregano

2 teaspoons Salt

½ teaspoon Thyme

½ teaspoon Pepper

2 Bay leaves, crumbled

2 cups Water

1 tablespoon sugar added to sauce after cooking.

In a large skillet lightly brown ground beef, onion and garlic. Drain. In a large deep ovenproof casserole dish add mushrooms including liquid and all other ingredients except the sugar. Add sugar after cooking has been completed. Cover and Slo-Cook™ 7 to 9 hours on lowest oven rack level. Serve over spaghetti.

---

## Braised Short Ribs

7 to 9 hours  
3 lbs. Beef Short Ribs  
½ cup Flour  
1 teaspoon Salt  
½ teaspoon Pepper  
2 tablespoons Vegetable Oil  
½ teaspoon Ground Allspice  
2 Onions, sliced thin  
1 Bay leaf

Mix flour, salt and pepper and coat beef ribs. Heat vegetable oil in skillet and brown flour coated ribs. Place ribs on meat rack in ovenproof dish. Sprinkle ground allspice over short ribs, place sliced onion on ribs and crumble bay leaf over top. Cover and Slo-Cook™ 7 to 9 hours on second oven rack level from the bottom.

## Chuck Roast Stroganoff

7 to 8 hours  
3 lbs. Chuck Roast  
1 tablespoon Vegetable Oil  
1 cup hot Water  
1 Beef Bouillon cube  
½ cup Catsup  
1 tablespoon Worcestershire Sauce  
4 oz. sliced Mushrooms, drained  
1 medium Onion, chopped  
1-½ teaspoons Salt  
¼ teaspoon Caraway Seed  
2 tablespoons Butter or Margarine  
2 tablespoons Flour  
1 carton 8 oz. Sour Cream

Heat vegetable oil in skillet and brown chuck roast. Dissolve bouillon cube in 1 cup hot water and pour into a deep ovenproof dish. Add other ingredients except butter, flour, and sour cream. Place browned chuck roast in dish with combined ingredients. Cover and Slo-Cook™ on lowest oven rack level 7 to 8 hours. After cooking, remove roast from the juices. Keep roast warm.

In a saucepan, melt butter, add flour, and ½ cup juices from the cooked roast. Mix these ingredients until blended. Stir in sour cream. Put these blended ingredients into the remaining juices of the roast. Stir well. Pour this sauce over the cooked chuck roast.

## Swedish Meat Balls

3-½ to 4 hours  
1 cup Milk  
1-½ cups Bread crumbs  
2 lbs. lean Ground Beef  
2 eggs, beaten  
1 Onion, medium, finely chopped  
1-½ teaspoon Salt  
1 ⅛ teaspoon Allspice  
1 ⅛ teaspoon Nutmeg  
1 ⅛ teaspoon Pepper  
2 tablespoons Vegetable Oil  
¾ teaspoon Dill Seed  
1 can - 10-¾ oz. Beef Broth

If desired add ¼ cup chopped mushrooms to broth

Add bread crumbs to milk and let stand 4 minutes. Combine crumb mixture with meat, eggs, onions, salt, pepper, allspice, and nutmeg. Shape into meat balls.

Heat vegetable oil in skillet and brown meat balls. After browning, place meat balls into an ovenproof dish. Sprinkle with dill seed. Add beef broth and mushrooms. Cover and Slo-Cook™ 3-½ to 4 hours on lowest oven rack level.

## Brown Bagged Barbecue Chicken

3-½ to 4 hours  
3 lbs. Chicken, cut into pieces  
1 brown medium size grocery sack or bag  
1 tablespoon Vegetable Oil or Shortening

### Barbecue Sauce

2 teaspoons Catsup  
2 teaspoons White Vinegar  
2 teaspoons Butter or Margarine, melted  
2 teaspoons Worcestershire sauce  
4 teaspoons Water  
2 teaspoons Lemon Juice  
1 teaspoon prepared Mustard  
1 teaspoon Paprika  
1 teaspoon Chili Powder  
Salt  
Pepper To Taste

Salt and pepper chicken pieces to taste. Combine barbecue sauce ingredients for making a sauce. Grease inside of brown grocery bag with vegetable oil or shortening. Dip each chicken piece in the barbecue sauce. Put chicken pieces in bag and squeeze or fold top of bag so ingredients can be held in bag. Place bag of chicken in flat ovenproof dish. Slo-Cook™ 3-½ to 4 hours on third oven rack level position from the bottom.

# Slo-Cook™ Menu Meals

---

## Chuck Roast, Green Beans, Baked Potatoes

8 to 10 hours

### Chuck Roast

3 lb. Beef-Chuck Roast

Vegetable Oil small amount cover bottom of skillet

Flour

Salt Season to taste

Pepper

¼ cup Water

1 Onion, medium

Coat chuck roast with flour that has been seasoned with salt and pepper to taste. Add small amount of cooking oil to skillet. When oil is hot sear each side of roast until desired browning is obtained. Place roast in 13-½ x 9-½ x 2-½-inch dish, add ¼ cup water. Slice onion over top of roast. Cover. Cook on lowest oven rack level.

### Green Beans

1-½ to 2 lbs. Green Beans

\*Frozen or blanched Green Beans retain better color when Slo-Cooked

1 slice Bacon - uncooked

½ teaspoon salt

½ cup liquid - water

Put beans in 2 qt. casserole dish. Add ½ teaspoon salt. Place uncooked bacon slice on top of beans. Add ½ cup water. Cover and Slo-Cook™ on lowest oven rack level.

### Baked Potatoes

4 to 6 medium baking potatoes. Pierce each potato one time with knife and wrap each potato tightly in foil. Slo-Cook™ on lowest oven rack level.

## Swiss Steak, New Potatoes, Chocolate Chip Brownies

7 to 9 hours

### Swiss Steak

2 lbs. Round Steak ¾" thick

1 Onion, large, sliced thin

1 can 15-½ oz. Tomatoes

¼ teaspoon Salt

1/8 teaspoon Pepper

Trim fat on steak. Cut into serving pieces. Place flat in ovenproof dish. Salt and pepper. Arrange thin slices over steak. Pour tomatoes over top. Cover and Slo-Cook™ 7 to 9 hours on lowest oven rack level.

### \*New Potatoes

1 pkg. 1 lb. 4 oz. New Frozen Potatoes

\*Fresh potatoes Slo-Cooked have a tendency to turn dark.

½ teaspoon Salt

4 tablespoons or ½ stick Butter or Oleo

1 cup Water

Put new frozen potatoes in a 1-½ qt. dish. Add salt, oleo, and water. Cover and Slo-Cook™ on lowest oven rack level. After cooking, garnish with parsley flakes.

## Chocolate Chip Brownies

1 Double Fudge Brownie Mix 15-½ oz.

¼ cup Cooking Oil

1 Egg

2 tablespoons Water

½ cup Chocolate Chips

½ cup chopped Walnuts

Mix first 4 ingredients in small bowl for 2 minutes. Add chocolate chips and nuts. Mix. Pour into buttered and floured 8" x 8" baking dish. Cover with aluminum foil. Slo-Cook™ on top oven rack level.

## Barbecued Country Ribs, Baked Beans, Peanut Delight Bars

8 to 10 hours

### Barbecued Country Ribs

3 to 4 lbs. Country style or thick cut Spareribs

¼ teaspoon Salt

¼ teaspoon Pepper

¾ cup Barbecue Sauce

Place ribs on slo-cook roasting rack in 3 quart baking dish. Add salt and pepper. Pour barbecue sauce over meat. Cover. Slo-Cook™ on lowest oven rack level.

### Baked Beans

1 can 31 oz. Pork and Beans

1 Onion - medium - grated

3 tablespoons Brown Sugar

1 tablespoon prepared Mustard

1 tablespoon Molasses

3 slices Bacon - uncooked

Cut bacon slices in 1- inch pieces. Add all ingredients and stir together well. Slo-Cook™ uncovered on lowest oven rack level.

### Peanut Delight Bars

1 jar (12 oz.) crunchy Peanut Butter

1 can (15 oz.) sweetened Condensed Milk

2 Eggs

1-½ teaspoons Vanilla Extract

1 pkg. (13-½ oz.) Graham Cracker Crumbs

1 cup dry roasted or other type whole Peanuts

Combine crunchy peanut butter, condensed milk, eggs, and vanilla. Stir these ingredients with a spoon until smooth.

Blend graham cracker crumbs. Mixture will be stiff. Pat evenly into a greased dish.

Sprinkle peanuts evenly over top. Pat down firmly into dough. Leave uncovered.

Slo-Cook™ on top oven rack level.

After cooking the top may be glazed. Make glaze by mixing together 1 cup confectioners sugar, 2 tablespoons hot water, and ½ teaspoon vanilla extract.

---

## Stuffed Bell Peppers, Squash Supreme Casserole, French Apple Pie

6 to 7 hours

### Stuffed Bell Peppers

4 Bell Peppers - medium  
1 lb. Ground Beef  
1 Egg  
½ cup pre-cooked Rice or (quick cooking rice)  
1 can 7 oz. whole kernel Corn  
1 can 8 oz. Tomato Sauce  
1 teaspoon Salt  
⅛ teaspoon Pepper

Cut bell peppers in half (lengthwise) remove core and seeds. Mix other ingredients together well. Fill each bell pepper half with stuffing and place on slo-cook roasting rack placed inside a dish. Cover and Slo-Cook™ on second oven rack level from the bottom.

### Squash Supreme Casserole

2 cups Herb Stuffing  
4 cups Yellow Squash (cooked and mashed)  
½ cup Carrots (cook whole, cool and grate)  
1 carton Sour Cream  
2 tablespoons Sautéed Onions in 3 tablespoons Butter or Oleo  
1 can Condensed Cream of Chicken Soup

Place 1 cup herb stuffing in a long flat ovenproof dish. Mix squash, carrots, sour cream, onions, and soup. Pour over herb stuffing. Put another cup of herb stuffing on top as a dressing. Slo-Cook™ uncovered on second oven rack level from the bottom.

### French Apple Pie

1 9" frozen Pie Crust  
1 can 20 oz. sliced Apples  
¾ cup Sugar  
¼ cup All-Purpose Flour  
¾ teaspoon Cinnamon  
1 tablespoon Lemon Juice

#### Topping:

¾ cup unsifted All-Purpose Flour  
⅓ cup packed Brown Sugar  
⅓ cup Butter or Oleo

Combine apples, sugar, flour, cinnamon, and lemon juice. Pile into uncooked pastry lined pan.

Combine flour and brown sugar in mixing bowl; cut in butter until crumbly - spoon over apples making sure all apples are covered. Slo-Cook™ on top oven rack position.

## Meat Loaf, Corn on the Cob, Green Bean Casserole

6 to 7 hours

### Meat Loaf

2 lbs. Hamburger  
1 cup Bread Crumbs  
1 Egg  
¼ cup Catsup  
¼ cup Milk  
1 pkg. Onion Soup Mix  
1 teaspoon Salt  
¼ teaspoon Pepper

Combine all ingredients and mix well. Place into an ovenproof oblong loaf pan and Slo-Cook™ uncovered in the center of rack at the lowest oven rack level.

### Corn on the Cob

- Fresh corn on the cob has a tendency to turn dark when Slo-Cooked.
- Frozen corn on the cob retains color because of previous blanching process.

Wrap 4 to 6 ears of corn on the cob individually in aluminum foil and place on second oven rack level from the top.

### Green Bean Casserole

1 can (16 oz.) French Style Green Beans  
1 can (16 oz.) French Style Seasoned Green Beans  
1 teaspoon Salt  
⅛ teaspoon Pepper  
1 can 10-¾ oz. Condensed Cream of Mushroom Soup  
1 can 3 oz. French Fried Onion Rings

Combine all ingredients except onion rings - Stir lightly to mix. Place in 2 quart casserole dish and sprinkle onion rings evenly over the top. Slo-Cook™ uncovered on second oven rack level from the top.

---

## **Pork Chops, Mixed Vegetables, Cheese Potatoes**

6 to 7 hours

### **Pork Chops**

6 Pork Chops - cut 1" thick

Salt to Taste

Pepper

1 package Shake and Bake

or

¼ cup Milk

1 cup fine Cracker Crumbs

Salt and pepper pork chops to taste. Coat with Shake and Bake and place on slo-cook roasting rack in ovenproof dish. Cover and Slo-Cook™ 6 to 7 hours.

**or**

If you choose to coat with cracker crumbs, dip pork chops individually in milk, salt and pepper, and coat with fine cracker crumbs. Place on Slo-cook™ trivet in ovenproof dish. Cover and Slo-Cook™ 6 to 7 hours on second oven rack position from the bottom.

### **Mixed Vegetables**

Fresh vegetables Slo-Cooked have a tendency to slightly discolor. Frozen pre-packaged vegetables produce more desirable results.

Place 12 to 16 oz. mixed frozen vegetables in small ovenproof dish, add ½ cup water and 1 teaspoon salt. Cover and Slo-Cook™ with other oven load items on third oven rack position from the bottom.

### **Cheese Potatoes**

Frozen new potatoes produce more desirable results.

20 oz. New Frozen Potatoes

½ cup Frozen Chopped Onion

4 oz. Cheese Whiz

Combine ingredients in small ovenproof dish. Cover and Slo-Cook™ with other oven load items on third oven rack position from the bottom.

# Quick Reference Instructions

---

Read "Important Safety Instructions" before using "Quick Reference Instructions". If there are unanswered questions, see detailed sections of this manual.

## Setting Electronic Clock

1. Press CLOCK pad.
2. Press  $\Delta$  or  $\nabla$  pad until correct time-of-day displays.
  - Clock saves time-of-day approximately 5-10 seconds after time is entered.

## Setting Electronic Timer

1. Press TIMER pad.
2. Press  $\Delta$  or  $\nabla$  pad until correct time displays.
3. Press TIMER pad again to cancel.

## Resetting and Canceling Timer

To reset the time when remaining time is displayed, press  $\Delta$  or  $\nabla$  pad until new time displays. To cancel timer, press and hold TIMER pad for approximately 5 seconds.

## Baking, Convection, or Convection Baking

1. Press BAKE, CONV, or CONV BAKE pad.
2. Press  $\Delta$  or  $\nabla$  pad until desired temperature is displayed.
3. Press OVEN CANCEL pad when finished.

## Timed Baking, Convection, Convection Baking, or Slo-Cook™

1. Place food in oven.
2. Press COOK TIME pad.
3. Press  $\Delta$  or  $\nabla$  pad until cooking time is displayed.
4. Press BAKE (Slo-Cook™), CONV, or CONV BAKE pad.
5. Press  $\Delta$  or  $\nabla$  pad until desired temperature is displayed. For Slo-Cook™, press  $\nabla$  pad until 170°, then HLD, and then SLO is displayed.

## Delayed Baking, Convection, Convection Baking or Slo-Cook™

1. Place food in oven.
2. Press BAKE (Slo-Cook™), CONV, or CONV BAKE pad.
3. Press  $\Delta$  or  $\nabla$  pad until desired temperature is displayed. For Slo-Cook™, press  $\nabla$  pad until 170°, then HLD, and then SLO is displayed.
4. Press STOP TIME pad.
5. Press  $\Delta$  or  $\nabla$  pad until desired stop time displays.
6. Press COOK TIME pad.
7. Press  $\Delta$  or  $\nabla$  pad until desired cooking time displays.

## To Cancel Remaining Cooking Time

Press OVEN CANCEL pad.

## Broil or Convection Broil

1. Center food on broiling grid and pan, and place on rack in oven.
2. Push BROIL or CONV BROIL pad.
3. Press  $\Delta$  pad to set HI  $\nabla$  pad to set lower broil temperature.
4. Press OVEN CANCEL pad when finished.

## Self-cleaning

1. Prepare oven for self-cleaning.
2. Press CLEAN pad.
3. Press  $\Delta$  or  $\nabla$  pad to adjust desired amount of cleaning time.

## Delayed Self-clean Cycle

1. Prepare oven for self-cleaning.
2. Press CLEAN pad.
3. Press  $\Delta$  or  $\nabla$  pad to adjust desired amount of cleaning time.
4. Press STOP TIME pad.
5. Press  $\Delta$  or  $\nabla$  pad until desired stopping time appears in display.

## Interrupt Self-Clean Cycle

1. Press OVEN CANCEL pad.
2. After oven has cooled to a safe temperature, door can be opened.

## Hold

1. Press BAKE pad.
2. Press  $\nabla$  pad until 170°, then HLD is displayed.
3. Press OVEN CANCEL pad when finished.

## Slo-Cook™

1. Press BAKE pad.
2. Press  $\nabla$  pad until 170°, then HLD, and then SLO is displayed.
3. Press OVEN CANCEL pad when finished.

## Defrost

1. Press CONV BAKE pad.
2. Press  $\nabla$  until 170°, then dEF appears in display.

## Dehydration

1. Press CONV BAKE pad.
2. Press  $\nabla$  until 170°, then dEF and dEH appears in display.



## Free Manuals Download Website

<http://myh66.com>

<http://usermanuals.us>

<http://www.somanuals.com>

<http://www.4manuals.cc>

<http://www.manual-lib.com>

<http://www.404manual.com>

<http://www.luxmanual.com>

<http://aubethermostatmanual.com>

Golf course search by state

<http://golfingnear.com>

Email search by domain

<http://emailbydomain.com>

Auto manuals search

<http://auto.somanuals.com>

TV manuals search

<http://tv.somanuals.com>