

Amana®

Built better than it has to be™

Owner's Manual

Covering model ACM1580A

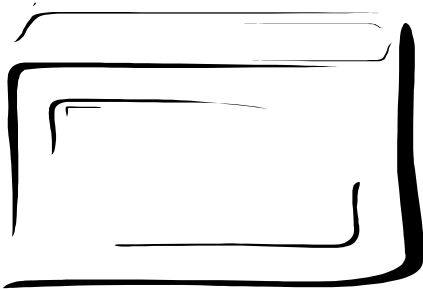

Combination Oven

Keep instructions for future reference.

Be sure manual stays with oven.

Contents

Important Safety Instructions	3
PRECAUTIONS TO AVOID POSSIBLE EXPOSURE TO EXCESSIVE MICROWAVE ENERGY	3
Display & Features	6
Cooking Methods	8
Cookware Suggestions	9
Microwave Cooking	10
Convection Cooking	14
Combination Cooking	15
Care and Cleaning	17
Cooking	
Roasting	19
Baking	20
Troubleshooting	22
Amana Warranty	24



Part No.3828W5A2110

Thank you for buying an Amana Oven!

Please take the time to complete the registration card and return promptly. If the registration card is missing, call Amana Consumer Affairs Department. When contacting Amana, provide product information from serial plate:

Model Number _____
Manufacturing (P) Number _____
Serial Number (S/N) _____
Purchase Date _____
Dealer Name _____
Dealer Address _____
Dealer Phone _____

Keep this manual and your sales receipt together in a safe place for future reference or if warranty service is required.

To locate an authorized servicer, call **1-800-843-0304** inside USA or **319-622-5511** outside USA. **Warranty service must be performed by an authorized servicer.** Amana Appliances also recommends contacting an authorized servicer if service is required after warranty expires.

Asure™ Extended Service Plan

Amana Appliances offers long-term service protection for this new range. Asure™ Extended Service Plan, covering functional parts, labor, and travel charges, is specially designed to supplement a strong warranty. Call 1-800-528-2682 or visit www.amana.com for information.

Parts and Accessories

Purchase replacement parts and additional accessories by phone. To order accessories for your Amana product, call 1-800-843-0304 inside USA or 319-622-5511 outside USA.

Save Time and Money

If something seems unusual, please check “Troubleshooting” section, which is designed to help you solve problems before calling service. If you have a question, call us at **(800) 843-0304** or write us at:

Consumer Affairs Department
Amana Appliances
2800 - 220th Trail
Amana, Iowa 52204

Remember to include model number of your appliance and your daytime phone number.

Questions on cooking, cleaning or usage?

Refer to

Product Assistance at **www.amana.com**

OR

call Consumer Affairs at **1-800-843-0304**

What You Need to Know About Safety Instructions

Warning and Important Safety Instructions appearing in this manual are not meant to cover all possible conditions and situations that may occur. Common sense, caution, and care must be exercised when installing, maintaining, or operating oven.

Always contact your dealer, distributor, service agent, or manufacturer about problems or conditions you do not understand.

Recognize Safety Symbols, Words, Labels



DANGER

DANGER—Immediate hazards which **WILL** result in severe personal injury or death.



WARNING

WARNING—Hazards or unsafe practices which **COULD** result in severe personal injury or death.



CAUTION

CAUTION—Hazards or unsafe practices which **COULD** result in minor personal injury or product or property damage.



Recognize this symbol as a **HOT SURFACE WARNING**

IMPORTANT SAFETY INSTRUCTIONS



Recognize this symbol as a **SAFETY** message



WARNING

When using electrical oven, basic safety precautions should be followed to reduce risk of burns, electric shock, fire, or injury to persons or exposure to excessive microwave energy.

1. **READ** all instructions before using equipment.
2. **READ AND FOLLOW** the specific **PRECAUTIONS TO AVOID POSSIBLE EXPOSURE TO EXCESSIVE MICROWAVE ENERGY** in **IMPORTANT SAFETY INSTRUCTIONS**.
3. This equipment **MUST BE GROUNDED**. Connect only to properly grounded outlet. See **GROUNding INSTRUCTIONS** in *Installation* section of this manual.
4. Install or locate this equipment **ONLY** in accordance with the installation instructions in this manual.
5. Some products such as whole eggs and sealed containers—for example, closed glass jars—are able to explode and **SHOULD NOT** be **HEATED** in this oven.
6. Use this equipment **ONLY** for its intended use as described in this manual. Do not use corrosive chemicals or vapors in this equipment. This type of oven is specifically designed to heat, cook or dry food. It is not designed for industrial or laboratory use.
7. As with any appliance, **CLOSE SUPERVISION** is necessary when used by **CHILDREN**.
8. **DO NOT** operate this equipment if it has a damaged cord or plug, if it is not working properly, or if it has been damaged or dropped.
9. This appliance, including power cord, must be serviced **ONLY** by qualified service personnel. Special tools are required to service equipment. Contact nearest authorized service facility for examination, repair, or adjustment.
10. **DO NOT** cover or block any openings on this appliance.
11. **DO NOT** heat baby bottles in oven.
12. Baby food jars shall be open when heated and contents stirred or shaken before consumption, in order to avoid burns.
13. **DO NOT** store this appliance outdoors. **DO NOT** use this product near water – for example, near a kitchen sink, in a wet basement, or near a swimming pool, or similar locations.
14. **DO NOT** immerse cord or plug in water.
15. Keep cord **AWAY** from **HEATED** surfaces.
16. **DO NOT** let cord hang over edge of table or counter.
17. See door cleaning instructions in *Care and Cleaning* section of this manual.
18. **DO NOT** insert oversized foods or oversized utensils in a microwave/convection oven as they may create a fire, an electrical arc, or risk of electrical shock.
19. **DO NOT** clean with metal scouring pads. Pieces can break off the pad and touch electrical parts involving risk of electrical shock.
20. **DO NOT** use paper products not intended for cooking when equipment is operated in convection or combination mode.
21. **DO NOT** store any materials, other than manufacturer's recommended accessories, in this equipment when not in use.
22. **DO NOT** cover racks or any other part of the oven with metal foil. Airflow restriction will cause overheating of the oven.
23. **DO NOT** spray oven cleaning solutions toward the rear inner cavity surface. This will contaminate and damage the convection heating assembly.

PRECAUTIONS TO AVOID POSSIBLE EXPOSURE TO EXCESSIVE MICROWAVE ENERGY

- A. **DO NOT** attempt to operate this oven with the door open since open door operation can result in harmful exposure to microwave energy. It is important not to defeat or tamper with the safety interlocks.
- B. **DO NOT** place any object between the oven front face and the door to allow soil or cleaner residue to accumulate on sealing surfaces.
- C. **DO NOT** operate the oven if it is damaged. It is particularly important that oven door close properly and that there is no damage to: 1. door (bent), 2. hinges and latches (broken or loosened), 3. door seals and sealing surfaces.
- D. Oven should not be adjusted or repaired by anyone except properly qualified service personnel.

SAVE THESE INSTRUCTIONS

IMPORTANT SAFETY INSTRUCTIONS



WARNING

To avoid risk of fire in the oven cavity:

- a. DO NOT overcook food. Carefully attend oven when paper, plastic, or other combustible materials are placed inside the oven to facilitate cooking.
- b. Remove wire twist-ties from paper or plastic bags before placing bag in oven.
- c. If materials inside the oven ignite, keep oven door CLOSED, turn oven off and disconnect the power cord, or shut off power at the fuse or circuit breaker panel.
- d. DO NOT use the cavity for storage. DO NOT leave paper products, cooking utensils, or food in the cavity when not in use.



WARNING

Liquids such as water, coffee, or tea are able to be overheated beyond the boiling point without appearing to be boiling due to surface tension of the liquid. Visible bubbling or boiling when the container is removed from the microwave oven is not always present. THIS COULD RESULT IN VERY HOT LIQUIDS SUDDENLY BOILING OVER WHEN A SPOON OR OTHER UTENSIL IS INSERTED INTO THE LIQUID. To reduce the risk of injury to persons:

- i) Do not overheat the liquid.
- ii) Stir the liquid both before and halfway through heating it.
- iii) Do not use straight-sided containers with narrow necks.
- iv) After heating, allow the container to stand in the microwave oven for a short time before removing the container.
- v) Use extreme care when inserting a spoon or other utensil into the container.



CAUTION

To avoid risk of personal injury or property damage, observe the following:

1. **Do not** deep fat fry in oven. Fat could overheat and be hazardous to handle.
2. **Do not** cook or reheat eggs in shell or with an unbroken yolk using microwave energy. Pressure may build up and erupt. Pierce yolk with fork or knife before cooking.
3. Pierce skin of potatoes, tomatoes, and similar foods before cooking with microwave energy. When skin is pierced, steam escapes evenly.
4. **Do not leave oven unattended.**
5. **Do not** use regular cooking thermometers in oven when cooking in microwave or combination mode. Most cooking thermometers contain mercury and may cause an electrical arc, malfunction, or damage to oven.
6. **Do not** use metal utensils in oven except when recommended by microwave food manufacturers or recipe requires metal utensils in convection or combination mode. Heat food in containers made of glass or china if possible.
7. Never use paper, plastic, or other combustible materials that are not intended for cooking. If oven temperature is high, material may ignite.
8. Oven temperature is at least 100°F in convection mode. Verify plastic, paper or other combustible materials are recommended by the manufacturer to withstand the minimum oven temperature.
9. When cooking with paper, plastic, or other combustible materials, follow manufacturer's recommendations on product use.
10. **Do not** use paper towels which contain nylon or other synthetic fibers. Heated synthetics could melt and cause paper to ignite.
11. **Do not** heat sealed containers or plastic bags in oven. Food or liquid could expand quickly and cause container or bag to break. Pierce or open container or bag before heating.
12. Racks, utensils, rack guides, and oven surfaces may become hot during or after use. Use utensils or protective clothing, like pan grips or dry oven mitts, when necessary to avoid burns.
13. **Do not** unplug oven immediately after use. Internal fan must cool oven to avoid damage of electrical components.
14. To avoid pacemaker malfunction, consult physician or pacemaker manufacture about effects of microwave energy on pacemaker.

SAVE THESE INSTRUCTIONS

Unpacking Oven

- Inspect oven for damage such as dents in door or inside oven cavity.
- Report any dents or breakage to source of purchase immediately.
Do not attempt to use oven if damaged.
- Remove all materials from oven interior.
- If oven has been stored in extremely cold area, wait a few hours before connecting power.

Radio Interference

Microwave operation may cause interference to radio, television, or a similar oven. Reduce or eliminate interference by doing the following:

- Clean door and sealing surfaces of oven according to instructions in *Care and Cleaning* section.
- Place radio, television, etc. as far as possible from oven.
- Use a properly installed antenna on radio, television, etc. to obtain stronger signal reception.

Oven Placement

- Do not install oven next to or above source of heat, such as pizza oven or deep fat fryer. This could cause microwave oven to operate improperly and could shorten life of electrical parts.
- Allow enough room for air movement around oven.
- Install oven on level countertop surface.
- Outlet should be located so that plug is accessible when oven is in place.

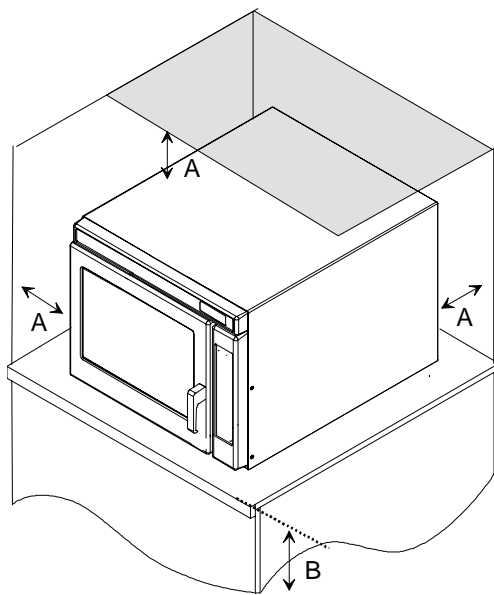

A—Allow at least 4" of clearance around top and sides of oven. Proper air flow around oven cools electrical components. With restricted air flow, oven may not operate properly and life of electrical parts is reduced.

B—Install combination oven so oven bottom is at least 3 feet (36 inches) above floor.

Oven Clearances



WARNING

To avoid risk of electrical shock or death, this oven must be grounded and plug must not be altered.



Grounding Instructions Oven **MUST** be grounded.

Grounding reduces risk of electric shock by providing an escape wire for the electric current if an electrical short occurs. This oven is equipped with a cord having a grounding wire with a grounding plug. The plug must be plugged into an outlet that is properly installed and grounded.

Consult a qualified electrician or servicer if grounding instructions are not completely understood, or if doubt exists as to whether the oven is properly grounded.

Do not use an extension cord.

If the product power cord is too short, have a qualified electrician install a three-slot receptacle. This oven should be plugged into a separate 60 hertz circuit with the electrical rating as shown in specifications table. When the combination oven is on a circuit with other equipment, an increase in cooking times may be required and fuses can be blown.

Microwave operates on standard household current, 110-120V.

Display and Features



User Option

This oven is designed for individual preferences

such as language and volume control. To change an option:

1. Press the CONTROL SET UP pad
2. Press the pad for the option you want to change.
3. Oven display scrolls selections for that option.
4. Press pad for the desired selection for that option.
5. Oven makes change and leaves option mode.



12-hour clock and timer

Oven is equipped with a 12-hour clock and a timer that can be set up to 99 minutes and 99 seconds. Clock does not display AM, PM or military time.

To set clock:

1. Touch CANCEL/STOP pad.
2. Touch CLOCK pad.
 - **ENTER TIME OF DAY** scrolls through display.
3. Enter desired time by using digit touchpads.
 - **TOUCH START** scrolls through display.
4. Touch START/PAUSE.

To set timer:

1. Touch CANCEL/STOP pad.
2. Touch TIMER pad.
 - **ENTER TIME IN MIN AND SEC.** scrolls through display.
3. Enter desired time by using digit touchpads.
 - Maximum amount of time is 99 minutes and 99 seconds.
 - **TOUCH TIMER** scrolls through display.
4. Touch TIMER.
 - To cancel timer at any time, press TIMER pad.

Function	Pad	Option
Volume	1	Mute, low, medium, loud
Clock	2	On or off
Scroll Speed	3	Slow, normal or fast
Units	4	Lbs. and °F or Kg °C
Demo	5	On or off
Language	6	English or Spanish



Child Lock

This is a unique feature that prevents accidental programming by children or when cleaning the oven control. To set the child lock, press and hold the 0 pad until **LOCKED** appears in the display and tones are heard. During Child Lock mode, **LOCKED** displays when a touchpad is pressed. To cancel child lock, touch and hold 0 until **LOCKED** disappears from display. After child lock is turned off, the time of day displays and cooking functions return to normal.



EASY COOK

Electronic oven control is equipped with this time saving feature. Press the Easy Cook pad for each minute of microwave cooking time desired. At the end of the cooking cycle, tones will sound.

To use Easy Cook:

1. Touch CANCEL/STOP pad.
2. Touch EASY COOK pad for each minute of microwave time desired.
3. At the end of the cooking cycle, oven stops and tones sound.



HELP

HELP displays feature information and helpful hints. To use the HELP feature, simply press the HELP pad, and then the feature pad you would like information about. Descriptive information about that feature will be scrolled through the display. After the help information is displayed, oven leaves help mode.

REMINDER REMINDER

The reminder feature may be used as an alarm clock without starting the oven. The reminder time can be set to activate up to 12 hours after current time of day.

To program a reminder:

1. Press CANCEL/STOP pad.
2. Press REMINDER pad.
 - **ENTER REMIND TIME** scrolls through display.
3. Enter desired time using the digit touchpads.
 - **TOUCH REMINDER** scrolls through display.
4. Touch REMINDER pad.
 - **REMINDER SET** scrolls through display once.
 - To cancel reminder program press REMINDER followed by the CANCEL/STOP pad.
5. Reminder sounds and displays **REMINDER** at selected time. Oven then leaves reminder mode.



WARM HOLD WARM/HOLD

This feature safely keeps cooked food warm in your oven for up to 99 minutes using microwave energy. You can use WARM/HOLD by itself or to automatically follow a timed cooking cycle. Do not use more than one complete WARM/HOLD cycle on food.

To use WARM/HOLD:

1. Put hot cooked food in the oven and close the door.
 - Food that is covered during cooking should be covered during WARM/HOLD.
 - Pastry items (pies, turnovers, etc.) should be uncovered during WARM/HOLD.
 - Complete meals kept warm on a dinner plate should be covered during WARM/HOLD.
2. Press CANCEL/STOP pad.
3. Press WARM/HOLD pad.
 - **TOUCH START** scrolls through display.
4. Press START/PAUSE pad.
 - **WARM** displays.
 - To cancel WARM/HOLD open oven door at any time or press the CANCEL/STOP pad.

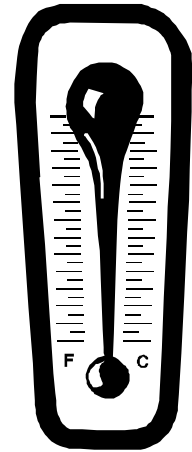

To use WARM/HOLD after another cooking cycle.

1. After entering the timed cooking cycle instruction, press WARM/HOLD before touching START/PAUSE pad.
2. When the last cooking cycle is over, tones sound and WARM displays. Oven will continue to run.

MORE

LESS

MORE and LESS

The MORE and LESS functions of this oven adjusts the cooking cycle's cook time. MORE adds 10 seconds to the cook time, LESS subtracts 10 seconds.

- MORE and LESS do not adjust cook time for the DEFROST and WARM/HOLD cooking cycles.
- Press MORE or LESS pads during active cooking cycle.
- For convection cooking, MORE or LESS are used as temperature selection pads.

Cooking Methods

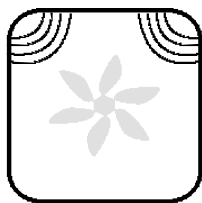

Microwave Cooking

Microwave cooking uses high frequency energy waves to heat the food. When cooking, microwave energy causes food molecules to move rapidly. This rapid movement between the food molecules creates heat, which cooks the food. Microwaves cook moist food and foods of varying fat content more quickly.

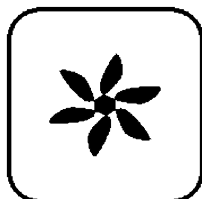

Convection Cooking

Convection cooking utilizes both a convection element and fan to evenly distribute heated air throughout the oven cavity. By circulating air, no hot or cold spots occur, creating a consistent temperature envelope around the food. These consistent temperatures cook food evenly and reduces cooking time.

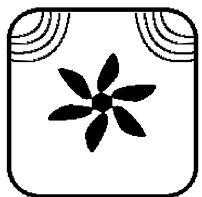

Combination Cooking

The combination mode uses both the speed of **microwave energy** and browning of **convection** cooking to yield fast, high quality food.

- Microwave cooking uses high frequency energy waves to heat the food. When cooking, microwave energy causes food molecules to move rapidly. This rapid movement between the food molecules creates heat, which cooks the food.
- Convection cooking uses the selected oven temperature to bake and brown foods. The circulating air surrounds food in an envelope of evenly heated air.

	Microwave	Convection	Combination
Heat source	Microwave energy.	Heated air, circulated in oven cavity.	Microwave energy and circulated heated air.
Heat Conduction	Heat produced within food by energy penetration	Heat conducted from outside of food to inside.	Food heats both through conduction from outside and within from energy.
Primary Benefit	Fast, high efficiency heating.	Browns foods and seals in flavors.	Shortened heating time from microwave energy, browning and crisping from convection.

Cookware Suggestions

What Should You Consider in Cookware?

Cooking method used determines the cookware that can be used. To simplify choices, use cookware that is approved for all three cooking methods: microwave, convection and combination.

Select	Avoid
Heat resistant glass	Non-heat resistant glass
Ceramics or china	Metal trimmed ceramics or china
Pyrex	Metal cookware
Heat resistant Teflon utensils, such as spatulas.	Metal cooking utensils.
Microwave cookware that is safe to 450°F	Paper products, straw, wicker and wood.
. Handles that are secure.	Cookware with loose or broken handles.

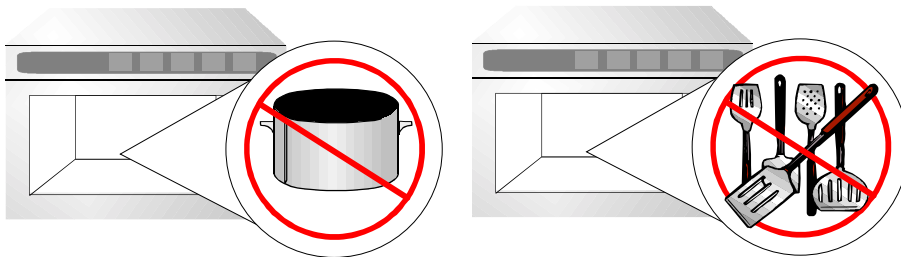

Do not use metal utensils or pots in the oven.

Can I can?

Canning is not allowed in microwave or combination ovens.

When heating liquids in the microwave oven, especially for extended periods of time, superheating can occur. This condition may result in boil over or possible eruption when the liquid is disturbed or a jar is sealed.

Damage incurred by canning, or attempting to can, using the oven is not covered under warranty.

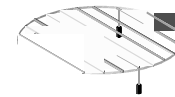

What a neat rack!

A metal rack is provided with the oven for use in **convection oven mode**. Metal racks should not be used in the oven during microwave or combination mode. Metal in a microwave energy environment will cause arcing, which could result in damage to the oven.

Cooking hints for your oven

Covering	A cover will trap heat and steam, causing food to heat more quickly. Always use a lid approved for both convection and microwave cooking.
Stirring	Redistributes heat in foods. Always stir from the outside toward the center of the dish.
Piercing	Pierce the shell, skin or membrane of foods before heating to prevent bursting.
Turning	Large foods should be turned so that the top and bottom heat evenly.
Arrangement	Do not stack food. Arrange in a single layer on a dish safe for combination heating. .
Standing Time	Foods often need to stand from 2 to 15 minutes after being removed from the oven. This finishes cooking. Normally an internal temperature will continue to rise approximately 5 to 10°F during standing time.
Spacing	Arrange individual foods, such as potatoes, in a circle and at least 1 inch apart. This helps food heat more evenly.



Should I use a popcorn popper?

Popcorn should only be cooked in a specially designed microwave popcorn popper or in the commercially prepared microwave-safe popcorn bag it was sold in. Do not use a popper designed to focus or concentrate energy or heat. Popcorn should also be popped only while oven is in **microwave mode**. If convection heat is present, popcorn may scorch, burn or catch fire.

Microwave Cooking

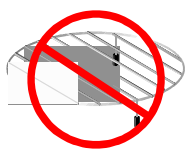

Do not use the convection rack in any microwave cooking cycles.

RECALL

Recall

This feature enables you to repeat the previous cooking cycle without having to reprogram the oven. To use simply press CANCEL/STOP and then RECALL.



What is stage cooking?

Stage cooking enables different cooking cycles, or stages, to be used consecutively without repeated input from the user. Stage cooking can be set to defrost food initially, then cook it, and then keep the food warm until serving time.

Example of Stage Cooking Conditions

	Stage 1	Stage 2
Power	H (high)	3
Time	2:30	1:30

DEFROST AUTO/TIME

Can I use auto-defrost?

The auto-defrost feature can be used as one of the cooking stages, but it must be programmed as the first stage. For instructions on how to use auto-defrost, see the next page.

Manual Programming

To manually set the cooking time and power level.

- Press PROGRAM
 - ENTER COOKING TIME scrolls through display.
- Enter desired cooking time using digit touchpads.
 - TOUCH START OR POWER scrolls through display.
- Press POWER LEVEL pad to change power level, if desired.
 - For a lower microwave power, press pads 1 (for 10%) through 9 (for 90%). 0 turns off microwave power completely.
- Press START/PAUSE pad.
- At end of cooking cycle, tones sound and oven turns off.



Stage Cooking

Stage cooking allows consecutive cooking cycles without interruption. Two different cooking cycles can be used.

To use stage cooking:

- Press PROGRAM
 - ENTER COOKING TIME scrolls through display.
- Enter desired cooking time using digit touchpads.
 - TOUCH START OR POWER scrolls through display.
- Press POWER LEVEL
 - ENTER POWER LEVEL 1 - 10 scrolls through display.
- Press digit touchpad to adjust microwave energy.
 - For a lower microwave power, press pads 1 (for 10%) through 9 (for 90%). 0 turns off the microwave power completely.
- Touch PROGRAM.
 - ENTER COOKING TIME scrolls through display.
- Enter desired cooking time using digit touchpads.
 - TOUCH START OR POWER scrolls through display.
- Press POWER LEVEL
 - ENTER POWER LEVEL 1 - 10 scrolls through display.
- Press digit touchpad to adjust microwave energy for second stage.
 - For a lower microwave power, press pads 1 (for 10%) through 9 (for 90%). 0 turns off the microwave power completely.
- Press START/PAUSE pad.
 - Oven begins to cook.
 - At end of first stage, oven beeps once to signal the transition.
- At the end of the cooking cycle, oven signals and turns off.



Auto Defrost

Four different preset defrost settings are available depending on food being defrosted. For added convenience, a built-in tone reminds you to check, turn over, separate or rearrange food during the defrost cycle.

1. Press CANCEL/STOP
2. Press DEFROST AUTO/TIME **once**.
 - **MEAT TOUCH 1 POULTRY TOUCH 2 FISH TOUCH 3 BREAD TOUCH 4** scrolls through display.
3. Press appropriate digit pad.
 - **ENTER WEIGHT** scrolls through display.
4. Enter weight using digit touchpads.
 - Weight ranges for meat, poultry and fish are 0.1 to 6.0 lbs.
 - Weight range for bread is 0.1 to 1.0 lbs.
5. Press START/PAUSE pad.
6. At end of cooking cycle, tones sound and oven turns off.



Defrosting Tips

- Remove fish, shellfish, meat and poultry from its original closed paper or plastic package.
- Form the meat into a shape of a doughnut before freezing.
- Scrape off thawed meat during defrost and then continue defrosting.
- Place foods in a shallow glass baking dish.

The oven beeped!

The oven beeps approximately midway through a defrost cycle to remind you to check the food. Pause the oven by pressing START/PAUSE and open door. Once food has been checked or rearranged, close door and press START/PAUSE to resume the defrost cycle.

Time Defrost

Defrost for a desired length of time.

1. Press CANCEL/STOP
2. Press DEFROST AUTO/TIME **twice**.
 - **ENTER DEFROST TIME** scrolls through display.
3. Press appropriate digit touchpads.
 - **TOUCH START** scrolls through display.
4. Press START/PAUSE pad.
5. At the end of the defrost time, tones sound and oven turns off.



This pad will start the function you set, or pause the oven temporarily during cooking or defrosting. Press again to restart oven from a pause.

Rapid Defrost

Preset to defrost one pound of frozen food..

1. Press CANCEL/STOP
2. Press RAPID DEFROST.
 - **MEAT TOUCH 1 POULTRY TOUCH 2 FISH TOUCH 3** scrolls through display.
3. Press appropriate digit touchpads.
 - **TOUCH START** scrolls through display.
4. Press START/PAUSE pad.
5. At the end of the defrost time, tones sound and oven turns off.



This pad cancels a currently running program and erases a cooking cycle being programmed.

Microwave Cooking (cont'd)



WARNING

To avoid risk of personal injury or property damage, do not cook popcorn with the metal convection cooking rack.



Do not use the convection cooking rack to pop popcorn

The sensor pad is not working.

If it appears Sensor Touch is not working, check the following:

- Oven door must remain closed.
- Glass turn table must be dry before cooking or using Sensor Touch.
- The oven will beep twice when steam is detected during the cooking cycle. Opening the oven door or pressing CANCEL/STOP before the oven beeps will end the Sensor Touch process.
- Cover food with plastic wrap and provide a slit for venting steam.

Sensor Touch Popcorn

A sensor detects steam from the food and automatically adjusts cook time for best cooking results. Commercially packaged popcorn in 1.75 to 3.5 ounce bags can be used.

1. Put popcorn on a plate in the center of the turntable.
 - DO NOT use the metal convection cooking rack for popcorn cooking.
2. Press CANCEL/STOP.
3. Press SENSOR POPCORN.
 - Oven will cook popcorn automatically using the sensor system.
4. Oven begins Popcorn cycle.
 - To end cycle, open door or press CANCEL/STOP.
5. At end of cooking cycle, tones sound and oven turns off..



CANCEL
STOP



SENSOR
POPCORN

Sensor Reheat

Designed to reheat precooked, room-temperature or refrigerated foods easily and quickly by detecting steam from the food and automatically adjusting cook time for best heating results.

1. Press CANCEL/STOP.
2. Press SENSOR REHEAT.
 - **SELECT MENU 1 - 3** scrolls through display.
3. Select desired category using digit pads.
 - Category 1 is for an average sized dinner plate containing about 1 to 2 cups of food.
 - Category 2 is to reheat 1 to 4 cups of soup or sauce in a bowl or casserole dish.
 - Category 3 is to reheat a 1 to 4 cup portion of a casserole in a casserole dish or small bowl.
4. Oven begins Sensor Reheat cycle.
 - **SENSING** displays.
 - To end cycle, open door or press CANCEL/STOP.
5. At end of cooking cycle, tones sound and oven turns off.



CANCEL
STOP



SENSOR
REHEAT

Microwave Cooking (cont'd)

Sensor Cook

A sensor detects steam from the food and automatically adjusts cook time for best cooking results for most foods.

1. Press CANCEL/STOP.
2. Press SENSOR COOK.
 - **SELECT MENU** \square - \square scrolls through display.
 - See table below for category options.
3. Enter desired category using digit touchpads.
4. Oven begins Sensor Cook cycle.
 - **SENSING** displays.
 - To end cycle, open door or press CANCEL/STOP.
5. At end of cooking cycle, tones sound and oven turns off..

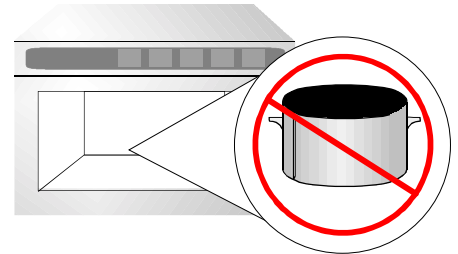

DO NOT use metal pots in this oven.

	Food	Serving amount and recommendations
1	Potatoes	1 to 4 medium potatoes (approx 8 to 10 ounces each)
2	Fresh Vegetables	1 to 4 cups Add 2 to 4 tablespoons water in vented dish. Allow 2 to 3 minutes standing time after cooking.
3	Frozen Vegetables	1 to 4 cups Add 2 to 4 tablespoons water in vented dish. Allow 2 to 3 minutes standing time after cooking.
4	Frozen Entrée	10 to 20 ounce frozen package. Remove from package as directed by frozen food supplier. Most entrées need 2 to 3 minutes standing time after cooking.
5	Rice	Follow package instructions for ingredient amounts. Most rice needs 2 to 3 minutes standing time after cooking.
6	Casserole	1 to 4 cups Combine ingredients as instructed in the recipe. Cover with plastic wrap and vent. Allow 3 minutes standing time after cooking.
7	Ground Meat	4 to 32 ounces (¼ to 2 pounds). Crumble meat into a microwave safe container. Vent cover to ensure well-done meat.
8	Fish Seafood	4 to 32 ounces (¼ to 2 pounds) Add ¼ to ½ liquid (wine, water, salsa) if desired. Vent cover to ensure thoroughly cooked meat.
9	Scrambled Eggs	2 to 5 medium sized eggs Add 1 tablespoon milk or water and beat eggs. Allow 1 to 2 minutes standing time after cooking.
0	Frozen Pizza	Use only frozen pizza intended for microwave use. Do not cover. Follow packaging instructions.

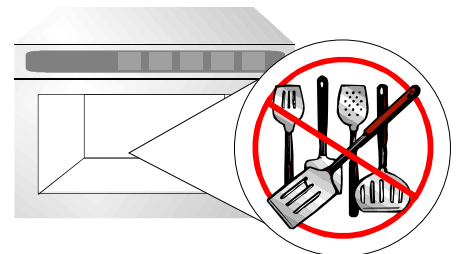

DO NOT use metal utensils in this oven.

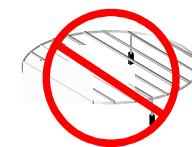

Do not use the convection rack in any microwave cooking cycles.

Convection Cooking



CAUTION

To avoid risk of burns, handle utensils, racks, and door with care. Allow oven, utensils, and racks to cool before cleaning. Oven, utensils, and racks, become hot during operation.

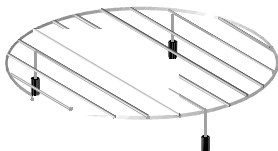

To operate the oven for convection cooking only, you can use only manual time entry. **The following instructions are for convection cooking only.** For combination cooking, see that section.

? Can I use the rack?

Yes. For convection only cooking, to aid in cooking times and quality, a round metal rack is provided with your oven. The rack should only be used when cooking exclusively with convection heat.

CAUTION

To avoid risk of personal injury or property damage, do not use oven without turntable in place.

CAUTION

To avoid risk of personal injury or property damage, do not cover turntable or rack with aluminum foil.

CAUTION

To avoid risk of property damage, do not use lightweight plastic containers, plastic wraps or paper products during a convection cooking cycle.

Manual Programming with Preheat

1. Press CANCEL/STOP
2. Press COOK pad under *Convection*.
 - 350F TOUCH MORE OR LESS FOR TEMP SET OR START OR ENTER COOKING TIME scrolls through display.
3. Adjust temperature setting as desired using MORE or LESS touchpads.
 - Temperature range is 225°F to 450°F
4. Press START/PAUSE pad.
 - PREHEAT displays with selected temperature.
 - PLACE FOOD ON RACK displays when oven is preheated.
5. Open door, place food on convection rack, and close door.
 - ENTER COOKING TIME scrolls through display.
6. Enter desired cooking time using digit touchpads.
 - TOUCH START scrolls through display.
7. Touch START/PAUSE.
 - At the end of cooking time, tones sound, END displays and oven turns off.



Manual Programming without Preheat

To program the amount of time and heat for a direct cooking cycle:

1. Press CANCEL/STOP
2. Press COOK pad under *Convection*.
 - 350F TOUCH MORE OR LESS FOR TEMP SET OR START OR ENTER COOKING TIME scrolls through display.
3. Adjust temperature setting as desired using MORE or LESS touchpads.
 - Temperature range is 225°F to 450°F
4. Enter desired cooking time using digit touchpads.
 - TOUCH START scrolls through display.
5. Touch START/PAUSE.
 - At the end of cooking time, tones sound, END displays and oven turns off.



Combination Cooking (microwave and convection)



CAUTION

To avoid risk of burns, handle utensils, racks, and door with care. Allow oven, utensils, and racks to cool before cleaning. Oven, utensils, and racks, become hot during operation.

The following instructions are for combination cooking only.

For convection only cooking, see that section.

Combination Roast

To program the amount of time and heat for a cooking cycle using both microwave energy and convection energy.

1. Put food on the oven rack and close oven door.
2. Press CANCEL/STOP
3. Press ROAST pad under *Combination*.
 - **350F TOUCH MORE OR LESS FOR TEMP SET OR ENTER COOKING TIME** scrolls through display.
4. Adjust temperature setting as desired using MORE or LESS touchpads.
 - Temperature range is 225°F to 450°F.
 - Microwave energy can not be adjusted and is set at 40%.
5. Touch START/PAUSE.
 - At the end of cooking time, tones sound, **END** displays and oven turns off.

ROAST

START
PAUSE



Do not use the convection rack with **any** metal pan. For roasting and baking, glass pans should be used.



CAUTION

To avoid risk of personal injury or property damage, do not use oven without turntable in place.



CAUTION

To avoid risk of personal injury or property damage, **do not** use aluminum foil.



CAUTION

To avoid risk of property damage, do not use lightweight plastic containers, plastic wraps or paper products during a combination cooking cycle.

Combination Bake

To program the amount of time and heat for a cooking cycle using both microwave energy and convection energy.

1. Put food on the oven rack and close oven door.
2. Press CANCEL/STOP
3. Press BAKE pad under *Combination*.
 - **375F TOUCH MORE OR LESS FOR TEMP SET OR ENTER COOKING TIME** scrolls through display.
4. Adjust temperature setting as desired using MORE or LESS touchpads.
 - Temperature range is 225°F to 450°F.
 - Microwave energy can not be adjusted and is set at 10%.
5. Touch START/PAUSE.
 - At the end of cooking time, tones sound, **END** displays and oven turns off.

BAKE

START
PAUSE

Combination Cooking (cont'd)



CAUTION

To avoid risk of burns, handle utensils, racks, and door with care. Allow oven, utensils, and racks to cool before cleaning. Oven, utensils, and racks, become hot during operation.

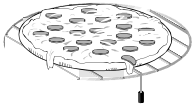

Only use the rack...

...for cooking frozen

pizzas. Do not use any metal pizza pans or tin foil. Place convection rack securely on turntable and away from sides of combination oven.



CAUTION

To avoid risk of personal injury or property damage, do not use oven without turntable in place.



CAUTION

To avoid risk of personal injury or property damage, do not cover turntable or rack with aluminum foil. Make sure that rack sits securely on the turntable.



CAUTION

To avoid risk of property damage, do not use lightweight plastic containers, plastic wraps or paper products during a combination cooking cycle.

The following instructions are for combination cooking only.

For convection cooking, see that section.

Auto Bake

To automatically bake frozen pizza, muffins, biscuits and frozen french fries using both microwave and convection energy alternately:

1. Press CANCEL/STOP
2. Press AUTO BAKE pad under *Convection Combination*.
 - FROZEN PIZZA TOUCH 1 MUFFINS TOUCH 2 BISCUIT / DINNER ROLL / B. STICK TOUCH 3 FROZEN FRENCH FRIES TOUCH 4 scrolls through display.
3. Touch appropriate digit touchpad.
 - Muffins and biscuits require a preheat cycle and should be placed on the rack after the signal sounds.
 - Frozen pizza **MUST** be placed directly on the convection cooking rack. **DO NOT** use a metal pizza tray or tin foil.
 - Muffins, biscuits and dinner rolls can use metal muffin tins *if necessary*.
 - Bread sticks and frozen french fries can be placed on a small shallow metal pan, such as a tray, *if necessary*.
4. Press START/PAUSE pad.
 - If additional information is needed, oven will prompt in display.
5. At the end of cooking time, tones sound, **END** displays and oven turns off.

CANCEL
STOP

AUTO
BAKE

START
PAUSE

Auto Roast

Auto roast automatically roasts beef, chicken, turkey breasts and pork using both microwave and convection energy alternately.

1. Press CANCEL/STOP
2. Press AUTO ROAST pad under *Convection Combination*.
 - BEEF TOUCH 1 WHOLE CHICKEN TOUCH 2 TURKEY BREASTS TOUCH 3 PORK TOUCH 4 scrolls through display.
3. Touch appropriate digit touchpad.
 - ENTER WEIGHT scrolls through display.
4. Use digit touchpads to enter weight.
5. Press START/PAUSE pad.
 - If additional information is needed, oven will prompt in display.
6. At the end of cooking time, tones sound, **END** displays and oven turns off.

CANCEL
STOP

AUTO
ROAST

START
PAUSE

Care and Cleaning

Clean oven frequently to maximize oven life, performance, and efficiency. A dirty oven cooks inefficiently because moisture, spills, and grease absorb convection and microwave energy.



WARNING

To avoid electrical shock which can cause severe personal injury or death, unplug power cord or open circuit breaker to oven before cleaning oven.



CAUTION

To prevent burns, handle utensils, racks, and door with care. Allow oven, utensils, racks to cool before cleaning. Oven, utensils, and racks, become hot during operation.



Recommended Cleaning Schedule

- Schedule daily cleaning and clean after use.
- Clean interior, exterior, and door according to instructions.
- Clean spills immediately.
- Remove oven racks, and clean according to instructions.
- Wipe dry after cleaning.

Cleaning Oven Exterior

Clean the door and other exterior surfaces with a clean cloth, sponge or nylon pad using a mild detergent and warm water solution. Wring cloth well to remove excess water before wiping oven.

- Do not use harsh or abrasive cleaners or cleaners containing ammonia.
- Do not use water pressure type cleaning systems.

Cleaning Oven Cavity

Wipe the oven inside with a soft cloth and a mild detergent solution. Rinse and wipe dry. Never use cleaning powders, abrasives or other rough pads.

Excessive oil splatters on the inside top will be difficult to remove if left to sit. Wipe splatters with a wet paper towel as soon as they occur.

NOTE: A plastic putty knife or equivalent may be used to remove baked on debris.

- Wear protective rubber gloves when cleaning oven.
- Use only a plastic putty knife, nylon scouring pad or equivalent, to aid in removing soil or build-up from the oven interior.
- **Do not use** knife, **metal** utensil, or **steel wool pad** to remove baked on material. This will damage the teflon coating.

Cleaning Oven Door

For best performance and safety, the inner door panel and the oven front frame should be free of food or grease build-up. Wipe often with a mild detergent and then rinse. Wipe dry with a soft cloth. Do NOT use cleaning powders, abrasives or other rough pads.

After cleaning the control panel, touch CANCEL/STOP pad to clear any entries that might have been accidentally made while cleaning. To avoid this problem, child lock may be set prior to cleaning.

Oven Turntable

The turntable and rotating ring are removable. They should be hand-washed in warm (not hot) water and a mild detergent. Dry thoroughly with a soft cloth. DO NOT use cleaning powders, abrasives, steel wool, or other rough pads. DO NOT put in an automatic dishwasher.

- Turntable may be cleaned at the sink. Be careful not to chip or scratch the edges as this could cause the turntable to break during use.
- Rotating ring must be cleaned regularly.
- Turntable must **ALWAYS** be in place when using this oven.

Cooking

Meat Basics

While cooking has always been a talent, it is now becoming a science, also. Amana provides this information as a guide to aid in preparation. For specific questions regarding meat preparation, handling, or storage contact **USDA (United States Department of Agriculture) Meat & Poultry Hotline at (800) 535-4555.**

Handling Hints

- When shopping, put meat in its own separate plastic sack to keep drips off other foods.
- Defrost frozen meats in refrigerator, not at room temperature.
- Keep meat cool and covered until it is time to cook.
- Wash hands with warm soapy water before and after handling meat or raw egg.
- Thoroughly wash any surface or utensil raw meat or egg touched.
- Do not put cooked meat on the same plate that held raw meat.

Cooking Tips

- Marinate meat in the refrigerator. Throw out excess marinade that came into contact with meat.
- Use an oven-proof meat thermometer.
- Cook meat to internal temperature recommended by USDA.
- When reheating foods, heat to an internal temperature of at least 165 °F.
- While cooking meats, turn over at least once.

Storage Safety

- Once carved, refrigerate unused portion immediately.
- Keep hot foods hot and cold foods cold when serving meals.
- Separate cooked foods into small portions for fast cooling.
- Do not store cooked ground meats or meals containing ground meats for longer than 3 to 4 days in the refrigerator.
- Do not allow cooked or uncooked meat juices to come into contact with ready-to-eat foods such as fruits or vegetables.

Tenderizing

Braising is only one way to tenderize less tender cuts. Before cooking, you may pound, cube, marinate, or use commercially prepared meat tenderizers. You may then use a dry method to cook the meat.

- **Marinades** are acidic liquids such as wine, citrus, or vinegar. Marinades soften meat fibers but only penetrate about one-fourth of an inch into the interior of the meat. Do not marinate meat for longer than 24 hours.
- **Pounding** with a heavy meat mallet breaks down the connective tissue to tenderize meat.
- **Cubing** breaks down the structure more than pounding. Cubing is done at the meat counter.
- **Commercial tenderizers** are primarily enzymes that work on the outer fourth inch on a meat cut. Make sure to follow the manufacturer's directions.

Using a Meat Thermometer

When using a meat thermometer, remember to insert it at a slight angle, in the thickest part of the meat, away from fat and bone. The meat should be removed when 5 °F below the desired final temperature. While the meat sits before carving, it will continue to cook internally, raising the last 5 °F by itself.

A meat thermometer can

- Take the guesswork out of cooking to a desired 'doneness'.
- Help reduce the risk of foodborne illness.

Oven-safe Thermometer

- Inserted before the meat is placed in the oven, this thermometer stays with the meat while it cooks.
- The internal temperature will rise slowly as the meat cooks.
- **DO NOT** use a metal thermometer in the oven in COMBINATION mode or MICROWAVE mode.

Instant-read Thermometer

- Not oven safe, these thermometers are placed in the meat when it is removed from the oven.
- While times may vary, an accurate temperature is normally displayed within one to two minutes.
- When using an instant-read, remember to clean the thermometer stem with warm, soapy water between readings.

Roasting Guidelines

Tender cuts such as rib and loin cuts are best cooked by dry heat methods, such as roasting. To roast:

1. Heat oven to desired temperature.
2. Place roast directly from refrigerator fat side up in a shallow, **non-metal** pan.
3. Place roast in combination oven.
4. Remove roast and check internal temperature with a meat thermometer. **DO NOT** place roast inside combination oven with thermometer.
5. Roast is done when 5 °F below desired degree of finished internal temperature.
5. Transfer roast to carving board and tent loosely with aluminum foil for approximately 15 minutes.

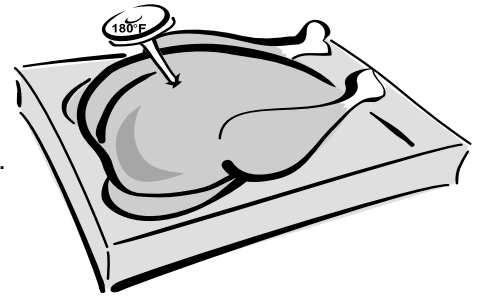

Meat Cut	Recommended Internal Temperature	Oven Temperature	Weight (pounds)	Approximate Cooking Time (minutes)
----------	----------------------------------	------------------	-----------------	------------------------------------

BEEF

Meat Cut	Recommended Internal Temperature	Oven Temperature	Weight (pounds)	Approximate Cooking Time (minutes)
Boneless Rump Roast		325°F	4 to 6	25 to 30
Tip Roast	Very Rare 130°F	325°F	3 ½ to 4	30 to 40
Eye Round Roast	Rare 140°F	325°F	4 to 6	20 to 30
Tenderloin Roast	Medium Rare 145°F	425°F	2 to 3	35 to 45
	Medium 160°F		4 to 6	45 to 60
Rib Roast	Well Done 170°F	325°F	4 to 6	26 to 42
	Very Well Done 180°F		6 to 8	23 to 35
Rib Eye Roast		350°F	4 to 6	18 to 24

PORK

Meat Cut	Recommended Internal Temperature	Oven Temperature	Weight (pounds)	Approximate Cooking Time (minutes)
Loin Roast, bone-in	All pork must be cooked to an internal temperature of at least 160°F to reduce the likelihood of Trichinosis and other food-borne illnesses.	350°F	3 to 5	20 minutes per pound
Rib Roast, boneless		350°F	2 to 4	
Tenderloin		450°F	½ to 1	
Ham bone-in, cook-before-eating		325°F	7 to 8	

LAMB

Meat Cut	Recommended Internal Temperature	Oven Temperature	Weight (pounds)	Approximate Cooking Time (minutes)
Shoulder		325°F	3 ½ to 6	35 to 40
Rib Roast	Medium-Rare 150°F	375°F	1 ½ – 2 ½	30 to 35
Rib Crown Roast, not stuffed	Medium 160°F	375°F	2 to 3	25 to 30
Loin Roast	Well Done 170°F	325°F	1 ¼ to 1 ¾	45 to 55
Leg, Frenched Style or Half Shank		325°F	5 to 7	15 to 20
			7 to 9	20 to 25

POULTRY (unstuffed)

Meat Cut	Recommended Internal Temperature	Oven Temperature	Weight (pounds)	Approximate Cooking Time (minutes)
Capon	To reduce the risk of food-borne illnesses, poultry must be cooked to an internal temperature of 180°F.	325 to 350°F	4 to 8	20 to 30 min/lb.
Cornish Hens, whole		325 to 350°F	1 ¼ to 1 ½	50 to 60 total
Duck, whole		325 to 350°F	—	18-20 min/lb.
Goose, whole		325 to 350°F	—	20 to 25 min/lb.
Pheasant, whole		325 to 350°F	2	30 min/lb.
Quail, whole		325 to 350°F	—	20 minutes total
Turkey		325°F	8 to 16	3 ½ to 5 ½ hours

All times and recommended temperatures are provided by the USDA, the Beef Industry Council, the National Pork Producer's Council, and the American Sheep Industry Council.

Cooking

Baking Guidelines

Remember when baking with a new oven temperatures vary from oven to oven. Store-bought thermometers are generally not accurate and cannot be used to evaluate oven temperatures. Ingredients should be at ambient temperature prior to baking.

Hints for Cookies,

- Shiny, flat cookie sheets should be used. Avoid cookie pans with high sides—this will cause uneven browning on the top.
- Cookie sheet should not touch the sides of the oven or door.

Cakes,

- Determine pan size from recipe directions. Shiny pans work best for cakes.
- Cake baked in too large a pan will be thin and dry. Too small a pan results in undercooked or unevenly cooked cake and batter may spill.

Pies

- Pies should be baked in dark or dull pans to increase browning.
- Frozen pies should be heated on an aluminum cookie sheet.

BAKING TIME GUIDELINES

Cake Pan Type	Pan size	Cups of batter	Oven Temp.	Minutes
Oval	7 ¾" x 5 ¾"	2 ½	350°F	25 to 30
	13" x 9 ¾"	8	350°F	25 to 30
Round, 2" layer	6"	2	350°F	25 to 30
	8 "	3	350°F	30 to 35
	14"	10	350°F	50 to 55
Round, 3" layer	8"	5	325°F	60 to 65
	12"	11	325°F	75 to 80
Half Round, 2" layer	18"	9	325°F	60 to 65
Half Round, 3" layer	18"	12	325°F	60 to 65
Square	6"	2	350°F	25 to 30
	10"	6	350°F	35 to 40
	16"	15 1/2	350°F	45 to 50

BAKEWARE GUIDELINES

Dark or dull pans	Absorb more heat and result in darker browning. Recommended for pies and breads.
Shiny pans (no sides)	Recommended for cookies.
Shiny pans (sides)	Recommended for cakes
Glass pans	Lower recommended oven temperature by 25°F.

Preheating

In most cases, you should preheat the oven before baking. **For delicate baking (such as puff pastries or souffles), preheat approximately 15–20 minutes before placing food inside oven or wait 10 minutes after oven signal beeps before placing food in oven.** The extra time creates a more stable oven temperature.

Common Baking Problems

Adjusting to a new oven can be hard, especially making a change to a convection oven. If you begin to notice consistent problems refer to the chart below for possible solutions. If baking results are still poor, contact **Amana Consumer Affairs at (800) 843-0304**.

Problem	Cause
Lopsided cakes (bake unevenly)	Pans touching each other or oven walls. Batter spread unevenly in pan. Incorrect use of aluminum foil. Oven is not level.
Cakes, cookies, biscuits too brown on bottom or top	Oven not preheated. Pans touching each other or oven walls. Using glass, darkened, warped or dull finish metal pans. Rack position too high or low. Incorrect use of aluminum foil. Oven temperature too high.
Pies don't brown	Incorrect rack position. Using shiny metal pans. Temperature set too low.
Cakes not done in center	Temperature too high. Pan too small. Baking time too short. Pan not centered in oven.
Cakes fall	Too much shortening or sugar. Too much or too little liquid. Temperature too low. Old or too little baking powder. Pan too small. Oven door opened frequently (peeking). Insufficient baking.
Excessive shrinkage	Too little leavening. Mixing batter too long. Pan too large. Oven temperature too high. Baking time too long.
Cakes high in middle or cracked	Temperature set too high. Overmixing. Too much flour. Pans touching each other or oven walls.

Test your cakes for doneness

While they are still in the oven. Because of variances across individual ovens, it is best to test for the proper consistency rather than solely relying on time and visual appearance as an indicator.

It may not be the oven

Cake problems may be in the mixing of the batter. Overbeating can cause cake structure to break down and excessive shrinkage of the cake. Underbeating can result in lumpy cakes that may not be cooked thoroughly. All ingredients should be at room temperature—not out of the refrigerator. Make sure to follow the recipes directions for how long the batter should be mixed and recommended times.

Stuck cake?

Allow cake to cool in cake pan on a rack for 10 minutes before removing. Larger cakes (over 14 inches in diameter) may take 15 minutes. If the cake has cooled too long, reheat in the oven at 250°F for a few minutes.

Better with butter

Make sure to follow recipe directions and use butter or margarine when it is listed. Using a low fat substitute will cause a recipe to fail.

Troubleshooting

WARNING

To avoid risk of electrical shock which can cause severe personal injury or death, do not remove outer case at any time. Only authorized servicer should remove outer case.

Topic	Possible Cause	Solution
-------	----------------	----------

OPERATION

Appliance not working	Power outage	Make sure appliance is plugged in. Verify that circuit breaker is not tripped. Replace household fuse but do not change fuse capacity.
Arcing or sparking	Cookware Metal foil Running oven empty	Verify cookware is safe for microwave use. Do not use metal foil in oven. DO NOT run oven empty.
Oven light not working	Normal Bulb burnt out.	Is oven operating? Oven must be operating for light to come on. Light bulb may need to be replaced. Call Amana.
Clock and timer not working	Power outage	Make sure appliance is plugged in. Verify that circuit breaker is not tripped. Replace household fuse but do not change fuse capacity.
Light reflection around microwave	Normal	Light is reflected from light located between the oven cavity and the outer wall of oven.



Amana Warranty

Limited Warranty

First Year

Amana Appliances will repair or replace, including related labor, any part (f.o.b. Amana Iowa) which proves defective as to workmanship or materials when carried into an authorized Amana servicer.

After one year from the date of original retail purchase, Amana will provide a free part, as listed below, to replace any part that fails due to a defect in materials or workmanship. The owner will be responsible for paying all other costs including mileage and transportation.

Second through Fifth Year

Amana will provide replacement magnetron, part (f.o.b. Amana Iowa) and labor, which proves defective as to workmanship or materials when carried into an authorized Amana servicer.

What is not covered by these warranties

- Replacement of household fuses, resetting of circuit breakers, or correction to household wiring or plumbing.
- Normal product maintenance and cleaning, including light bulbs.
- Products with original serial numbers removed, altered, or not readily determined.
- Products purchased for commercial, industrial, rental, or leased use.
- Products located outside of the United States or Canada.
- Premium service charges, if the servicer is requested to perform service in addition to normal service or outside normal service hours or area.
- Adjustments after the first year.
- Repairs resulting from the following:
 - Improper installation, exhaust system, or maintenance.
 - Any modification, alteration, or adjustment not authorized by Amana.
 - Accident, misuse, abuse, fire, flood, or acts of nature.
 - Connections to improper electrical current, voltage supply, or gas supply.
 - Use of improper pans, containers, or accessories that cause damage to the product.
- Travel.

To Receive Warranty Service

Service must be performed by an authorized Amana service representative. Appliance must be reasonably accessible to servicer. To schedule service, contact the Amana dealer where you purchased your appliance or contact Amana Appliances Factory Service.

Amana Appliances Factory Service

1-800-628-5782 inside USA

For more information, Amana Appliances Consumer Services

Amana Appliances

2800 220th Trail

Amana, Iowa 52204

1-800-843-0304 inside USA

(319) 622-5511 worldwide

When contacting Amana Appliances please include the following information:

- Your name, address, and telephone number.
- Model number and serial number of your appliance.
- The name and address of your dealer and the date of purchase.
- A clear description of the problem.
- Proof of purchase (sales receipt).

IN NO EVENT SHALL AMANA BE LIABLE FOR INCIDENTAL OR CONSEQUENTIAL DAMAGES.

This warranty gives you specific legal rights, and you may have others which vary from state to state. For example, some states do not allow the exclusion or limitation of incidental or consequential damages, so this exclusion may not apply to you.

Amana Appliances Online • <http://www.amana.com>

Free Manuals Download Website

<http://myh66.com>

<http://usermanuals.us>

<http://www.somanuals.com>

<http://www.4manuals.cc>

<http://www.manual-lib.com>

<http://www.404manual.com>

<http://www.luxmanual.com>

<http://aubethermostatmanual.com>

Golf course search by state

<http://golfingnear.com>

Email search by domain

<http://emailbydomain.com>

Auto manuals search

<http://auto.somanuals.com>

TV manuals search

<http://tv.somanuals.com>