



# IMPORTANT SAFETY INSTRUCTIONS

 Recognize this symbol as a SAFETY message

## WARNING

WHEN USING ELECTRICAL APPLIANCES, THESE BASIC SAFETY PRECAUTIONS SHOULD BE FOLLOWED, TO REDUCE THE RISK OF BURNS, ELECTRICAL SHOCK, EXPOSURE TO EXCESSIVE MICROWAVE ENERGY, FIRE, DEATH, INJURY TO PERSONS OR PROPERTY DAMAGE.

1. READ all instructions before using this appliance.
2. READ AND FOLLOW specific "PRECAUTIONS TO AVOID POSSIBLE EXPOSURE TO EXCESSIVE MICROWAVE ENERGY" found on page 4.
3. USE this appliance ONLY for its intended use as described in this manual.
4. Closely SUPERVISE any use by CHILDREN.
5. This appliance MUST BE GROUNDED! Connect only to a properly grounded outlet. See "GROUNDING INSTRUCTIONS" found on page 4.
6. Keep this appliance and cord AWAY from HEATED surfaces.
7. Read and follow "door surface cleaning" instructions, found on page 24.
8. Install or locate this appliance in accordance with the provided installation instructions found on page 4.
9. DO NOT immerse cord or plug in water.
10. DO NOT let cord hang over edge of table or counter.
11. DO NOT cover or block any openings on this appliance.
12. DO NOT use outdoors.
13. DO NOT heat whole eggs or sealed containers — for example closed jars — they may explode.
14. DO NOT use this appliance for canning, deep fat frying, or heating baby bottles.
15. DO NOT OPERATE this appliance if it has a damaged cord or plug, if it is not working properly, or if it has been damaged or dropped.

## TO REDUCE THE RISK OF FIRE IN THE OVEN CAVITY:

- a. DO NOT OVERCOOK FOOD. Carefully attend the appliance if paper, plastic, or other combustible materials are placed inside the oven to facilitate cooking.
- b. REMOVE WIRE TWIST-TIES from paper or plastic bags BEFORE placing the bag in the oven.
- c. If materials inside the oven smoke or ignite, keep the oven door closed, turn the oven off, and disconnect the power cord or shut off power at the fuse or circuit breaker. IF THE DOOR IS OPENED THE FIRE MAY SPREAD!

THIS APPLIANCE *MUST* BE SERVICED ONLY BY QUALIFIED SERVICE PERSONNEL. CONTACT YOUR NEAREST AUTHORIZED SERVICE FACILITY FOR EXAMINATION, REPAIR OR ADJUSTMENT.

## SAVE THESE INSTRUCTIONS

# SAFETY INSTRUCTIONS CONT.

Read and Follow These Rules for Safe Operation.

This microwave oven is designed to be safe and reliable. As with all appliances, there are certain rules to follow. Make sure everyone who cooks with this oven is familiar with this product's operation and with these precautions.

## PRECAUTIONS TO AVOID POSSIBLE EXPOSURE TO EXCESSIVE MICROWAVE ENERGY

- (a) **DO NOT** attempt to operate this oven with the door open since open-door operation can result in harmful exposure to microwave energy. It is important not to defeat or tamper with the safety interlocks.
- (b) **DO NOT** place any object between the oven front face and the door or allow soil or cleaner residue to accumulate on sealing surfaces.
- (c) **DO NOT** operate the oven if it is damaged. It is particularly important that the oven door close properly and that there is no damage to the: (a) Door (bent), (b) hinges and latches (broken or loosened), (c) door seals and sealing surfaces.
- (d) The oven should **NOT** be adjusted or repaired by anyone except properly qualified service personnel.

## UNPACKING THE OVEN

Inspect the oven for any damage such as dents or holes in the screen of the door, or dents inside the oven cavity. Any dents or breakage should be reported to your Amana dealer immediately. You will be told if the unit will operate correctly.

## GROUNDING INSTRUCTIONS

This appliance **MUST** be grounded. In the event of an electrical short circuit, grounding reduces the risk of electric shock by providing an escape wire for the electric current. This appliance is equipped with a cord having a grounding wire with a grounding plug. The plug must be plugged into an outlet that is properly installed and grounded. **DO NOT** use a two-prong adaptor.

**⚠ WARNING** - Improper use of the grounding plug can result in a risk of electric shock or death.

Consult a qualified electrician or serviceman if the grounding instructions are not completely understood, or if doubt exists as to whether the appliance is properly grounded. If it is necessary to use an extension cord, use only a 3-wire extension cord that has a 3-blade grounding plug, and a 3-slot receptacle that will accept the plug on the appliance. The extension cord must be rated at a minimum of 15 amps, 120 volts, and should be no more than six feet in length. This oven should be plugged into a separate 120 volt, 15 amp, 60 hertz circuit. When a microwave oven is on a circuit with other appliances, an increase in cooking times may be required and fuses can be blown.

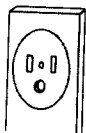
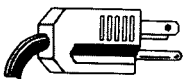

## OVEN PLACEMENT

**DO NOT** build the oven in with the sides, top or bottom airflow restricted. The oven must have sufficient airflow around it. If you wish to build in this microwave oven, use **ONLY** Amana model RMC1TKA trim kit that has a label identifying which Amana microwave oven model series may be used. Trim kits can be purchased from your dealer.

# POWER SUPPLY

1. A short power-supply cord is provided to reduce the risks resulting from becoming entangled in or tripping over a longer cord.
2. Longer cord sets or extension cords are available and may be used if care is exercised in their use.
3. If a long cord or extension cord is used, (1) the marked electrical rating of the cord set or

# SAFETY INSTRUCTIONS CONT.

- (a) **Do not operate the oven when door seal is damaged**, to do so could allow microwave energy to escape.
- (b) **Extreme overcooking** can cause the food to smoke or possibly ignite.
  - DO NOT OPEN THE DOOR
  - TURN THE OVEN OFF
  - DISCONNECT THE POWER CORD
  - SHUT OFF THE POWER AT FUSE OR CIRCUIT BREAKER PANELIf this happens: keep door closed, disconnect the power cord, or shut off power at the fuse or circuit breaker.
- (c) **▲ WARNING To prevent spontaneous boiling (eruption)**, liquids must be briskly stirred or poured (to mix in air) before being heated in a microwave oven. **DO NOT OVERHEAT**. If air is not mixed into a liquid, the liquid can erupt in the oven or after removal from the oven.
- (d) **Eggs** must **NOT** be cooked or reheated in the shell, or with an unbroken yolk, since this may result in a pressure build-up and eruption. Pierce the yolk with a fork or knife before cooking. Do **NOT** reheat previously cooked eggs in the microwave oven unless finely chopped or scrambled.
- (e) **Home canning** must **NOT** be done in a microwave oven. Home canning is generally done with metal lids. Since metal lids reflect microwaves, you cannot be assured that the food product will be heated uniformly to 212°F or above, and there is a probability of deterioration of the food product. USDA extension specialists do not recommend home canning in microwave ovens.
- (f) **Deep fat frying** must **NOT** be done in any microwave oven. The fat could overheat and be hazardous to handle.
- (g) **▲ WARNING: Do not heat sealed containers in any microwave oven.** Containers with restricted openings such as syrup bottles must **NOT** be used for cooking. Food or liquid could expand quickly and cause the container to break.
- (h) **Regular cooking thermometers** must **NOT** be used in a microwave oven. Most cooking thermometers contain mercury and may cause "arcing", malfunction, and/or damage to the oven.
- (i) **Plastic bags (and other air-tight**

extension cord should be at least as great as the electrical rating of the appliance, (2) the extension cord must be a grounding-type 3-wire cord, and (3) the longer cord should be arranged so that it will not drape over the countertop or tabletop where it can be pulled on by children or tripped over accidentally.

**containers)** must always be pierced or opened before heating in a microwave oven. This is needed to allow steam to escape during cooking.

- (j) **Metal or ceramic accessories** which have been specially designed to absorb microwave energy to provide heat ("active" accessories such as browning skillets) may be used with caution. To prevent possible damage to the tray, do **NOT** use the "active" accessory in which the "active area" is less than one inch above the tray. Test any such device before use and carefully read and follow manufacturer's instructions provided with the accessory. Any questions concerning these accessory products should be referred to the accessory manufacturer. Amana Refrigeration, Inc., does **NOT** endorse any brand of accessory. Remember that all microwave accessories are not "top quality"; some may **NOT** be suitable for microwave cooking. Caution must be used when purchasing microwave accessories.
- (k) **Newspapers** must **NEVER** be used in a microwave oven since they may ignite.
- (l) **Paper towels** which contain nylon or other synthetic fibers woven through them must **NOT** be used because the heated synthetics could melt and cause the paper to ignite.
- (m) **Use only popcorn in packages designed and labeled for microwave use.** You may place the package on an inverted microwave-safe glass loaf dish, as needed, to increase popped volume. Pop according to package directions, beginning with the **MINIMUM** amount of time recommended. Pop until bag has expanded and there are one to two seconds between pops. Popcorn yields may vary. Do **NOT** continue to heat after popping has stopped, since popcorn will scorch or burn. Do **NOT** leave oven unattended. Use caution when handling the hot glass loaf dish or hot popcorn bag.
- (n) **If you're using a microwave popcorn popper**, use according to manufacturer's instructions. Do **NOT** continue to heat after popping has stopped, since popcorn will scorch or burn. Do **NOT** leave oven unattended.
- (o) **Pot Holders** may be needed when cooking by microwave. Containers can become hot when heat is transferred from cooked food.

# PRECAUTIONS FOR CONVECTION, COMBINATION, AND BROILING

- Always press **RESET** before programming the oven to cancel any previously programmed instructions.

## **CAUTION:**

**Exterior and Interior Oven Surfaces, Including the Oven Door, Become Hot During Convection, Combination, and Broiling. Use Care When Opening or Closing Door and When Inserting or Removing Food, Accessories, or Temperature Probe.**

- Do **not** leave children alone or unattended in area where hot appliance is in use.
- **Dry padded mitts** or **potholders** must always be used for handling food or oven accessories when oven is hot to prevent possible burn injuries.

## Checking Oven Operation

After unpacking, properly installing and grounding the oven, follow this simple procedure to ensure that the microwave feature is operating correctly. Note that five dashes will appear in the display after you have plugged in the oven. When you see these dashes you will know that the oven has been recently unplugged or there has been a power interruption.

1. Place a glass measuring cup filled with water in the center of the oven floor.
2. Press **RESET**.
3. Program 1 minute by pressing **number pads 1, 0, 0**, in that order.
4. Press **START**. The microwave feature should now be heating on Full Power. (The readout display will count down the remaining time and "PGM1", "MICRO" and "POWER" will also show.) The oven light comes on.
5. After time has elapsed, the oven will turn off automatically and beep to indicate programmed time is over.

If the oven is operating normally, the water in the glass measuring cup will be very warm.

Also check the operation of the door interlock systems.

**START** and **STOP** pads turn the oven on and off. Microwave energy is generated only when the door is closed, cooking time or temperature has been set, and

**START** has been pressed. In addition, the oven has

- **Damp potholders** or **dishtowels** must never be used when touching hot utensils or oven accessories, as steam burns can result.
- Do not store anything, even the cookbook, on top of the oven or inside the oven cavity.
- **Flammable materials** should not be stored on top, inside, or near the oven.
- Liquids or foreign objects that fall into the ventilation openings (on top of the oven) can damage operating parts inside the oven.
- Allow oven to cool after using convection, combination, or broiling before popping microwave popcorn.
- **Plastic-faced microwave thermometers** should not be used during convection, combination or broiling because they are not heat resistant and will melt.
- Do not use utensils or containers that are not heat resistant during convection or combination since they may not withstand the high oven temperatures. Never use plastic when broiling.

interlock switches to assure no microwave energy is generated when the door is open. To check or remove food before the cooking time has elapsed, you may either press **STOP** or open the oven door to turn the oven off. Before the oven door opens, hidden interlock switches sense the motion of the door and automatically turn the oven off.

To check the operation of **START, STOP** and the interlock switches:

1. Place a cup of water in oven and close oven door.
  2. Press **RESET**.
  3. Press **5**, then **0**.
  4. Press **START**. The oven should operate and the oven light should come on.
  5. Press **STOP**. The oven should shut off immediately and the sound of the motor should cease. The oven light should go out.
  6. Press **START**. The oven should now be operating.
  7. **Open the door**. The oven should now shut off and the sound of the motor should cease. The oven light should come on when the door is opened.
  8. Press **RESET**. Remove the cup of water. If under any of the preceding conditions the oven does not operate as stated, do not use it. Call your dealer or authorized service agency.
- Note:** The oven light will come on when the door is opened. It will also come on when the oven is operating.

## Microwave Convection Oven Accessories

### OVEN RACK

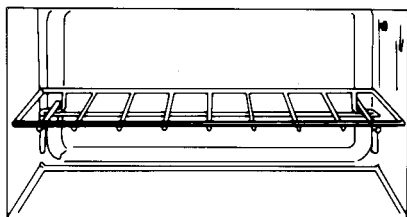

Use in: Convection and Broil

Placement: Set on oven rack guides or oven floor.

Note: Place the oven rack in position when the oven is cool. If you must move the rack while the oven is hot, do so with care and use dry potholders. The oven rack has been designed so that it can be partially pulled out in a lock position to turn food during cooking.

### BROILER PAN SET

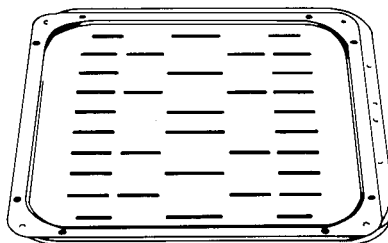

Use in Broiling only.

Placement: Set on oven rack.

Note: Use care when handling hot accessories and hot grease.

### TEMPERATURE PROBE

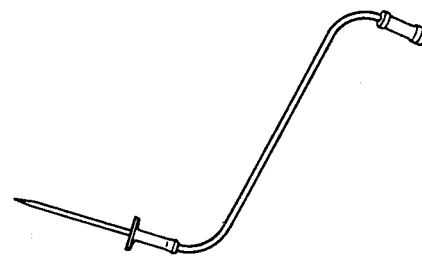

Use in: Microwave, Combination, Auto Combination, Convection.

Placement: Insert probe plug into oven wall receptacle.

See instructions for use on page 15.

# MORE ABOUT YOUR AMANA® RADARANGE PLUS® OVEN

## Oven Features

- ❶ Control Panel
- ❷ Press-to-Open Door Release
- ❸ Temperature Probe Receptacle
- ❹ Temperature Probe
- ❺ Safety Door Locking System
- ❻ Oven Light Bulb Cover (on top)
- ❼ Exterior Oven Air Vents (top and back)
- ❽ Model and Serial Number Plate (between door and control panel)
- ❾ Oven Rack Guides

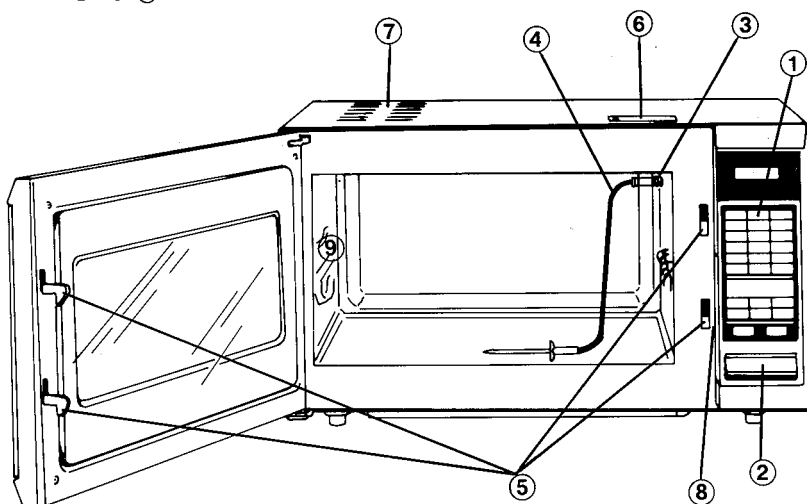

## The Control Panel

**READOUT DISPLAY** — Normally shows time of day.

- Shows remaining time when cooking by time or using the Timer.
- Shows actual or set temperature when cooking to temperature.

**READY TIME**—Use (a) When entering the time you want the oven to have food ready to eat. Set for times up to 12 hours later. For example, if you want to serve dinner at 5:00, this pad will program the oven to start cooking at the proper time so food is cooked by 5:00; (b) To determine when cooking will be completed; (c) time of day alarm clock.

**RESET**—Always press before programming oven to cancel any previously programmed instructions. Can also be pressed during programming to cancel mistakes. If the oven is operating, press **reset** to see what the oven is doing "right now."

**ACCU-THAW**—Programs the oven to defrost food. Press after entering the defrosting time. (See page 12.)

**AUTO COMBO**—Programs oven to cook certain foods automatically with the temperature probe in the combination mode.

**COMBO**—Use to program oven to cook food with combination of microwave and convection energies. Reviews set convection temperature.

**START**—Starts oven operation.

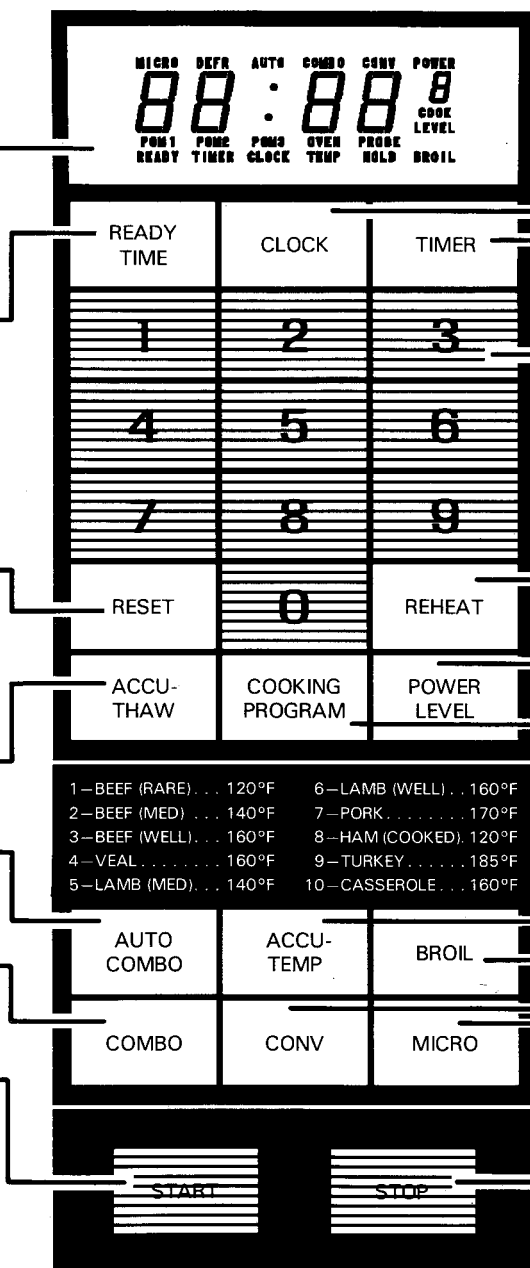

**CLOCK**—Sets time of day. Press twice after pressing numbers to set the current time. (See page 10.)

**TIMER**—Lets you time a separate task, even when the oven is cooking. Press after pressing numbers for time to be measured. (See page 11.)

**NUMBER PADS**—For cooking time, time of day, or temperature, press in the same order as you would write the numbers.

**REHEAT**—Preprogrammed to cook on full power for 2:45. Reheating time can be changed by the user. (See page 13.)

**POWER LEVEL**—Programs cooking power level. Press after pressing number pad corresponding to power level desired.

**COOKING PROGRAM**—Use to "advance" to the second and third program levels. Also used when reviewing programmed instructions.

**ACCU-TEMP**—Use to program oven and food temperatures.

**BROIL**—Programs the oven to broil foods. Be sure to use broiler pan accessories.

**CONV**—Programs the oven to cook food using convection method. Reviews set convection temperature.

**MICRO**—Programs the oven to cook food with microwave energy.

**STOP**—Stops oven. The oven can also be stopped by opening the door.

## Cookware Selection Hints

Refer to the following chart to help you select the proper cookware to use in the oven.

	Cookware	Microwave	Convection	Combination	Broiling
	Heat-Resistant Glass, Glass-Ceramic (Pyrex®, Fire King®, Corning Ware®, etc.)	YES	YES	YES	YES
	Ceramic	YES (Utensils with no metal trim)	YES	YES (Utensils with no metal trim)	NO
	Metal	NO	YES	NO	YES
	Non Heat-Resistant Glass	NO	NO	NO	NO
	Microwave-Safe Plastics	YES	NO	YES*	NO
	Plastic Films & Wraps	YES	NO	NO	NO
	Paper Products	YES	NO	NO	NO
	Straw, Wicker & Wood	YES**	NO	NO	NO
	Browning Dishes	YES	NO	NO	NO

\*Use only microwave cookware that is safe to 500°F.

\*\*These items should not contain metal or meltable plastics. Use for short times only.

Proper selection of cookware is essential for satisfactory cooking results. Your cookbook has more details on cookware to help you become more familiar with proper usage.

### Convection

Metal utensils are recommended for all types of baked products and are necessary when browning or crusting are desired.

### Microwave

Make sure cookware is safe for use in microwave by using the cookware test procedure described in the Introduction chapter of your cookbook. Review precautions on page 5 for proper use of paper products in microwave cooking.

### Combination

Glass or glass-ceramic cookware is recommended for Combination. Do not use any cookware with metal trim in Combination.

### Broiling

Use only metal or heat-resistant glass cookware and the broiler pan set provided for Broiling.

**Note:** Browning dishes can be preheated only on the ceramic oven floor. A browning utensil is designed only for use on Microwave setting. Do not use on Convection or Combination or when using Microwave followed by Convection.

# HOW YOUR AMANA® RADARANGE PLUS® MICROWAVE CONVECTION OVEN WORKS

In addition to **Microwave** cooking, your new oven offers you many other exciting ways to prepare foods including **Convection**, **Combination**, and **Broiling**. Within each of these basic cooking methods you'll find even more features to make cooking easier and more convenient.

## Summary of Cooking Methods

	Microwave	Convection	Combination	Broiling
<b>COOKING METHOD</b>	Microwave energy is distributed evenly throughout the oven for thorough, fast cooking of food.	Hot air circulates around food to produce browned exteriors and seal in juices.	Microwave energy and convection heat combine to cook foods in up to one-half the time of conventional ovens, while browning and sealing in juices.	Very hot air circulates close to food to sear and brown foods.
<b>HEAT SOURCE</b>	Microwave energy.	Circulating heated air.	Combination of microwave energy and circulating heated air.	Circulating heated air.
<b>HEAT CONDUCTION</b>	Heat produced within food by friction of molecules.	Heat conducted from outside of food to inside.	Food heats from friction and heat conducted from outside of food.	Heat conducted from outside of food to inside.
<b>BENEFITS</b>	Fast, high efficiency cooking. Oven and surroundings do not get hot. Easy clean-up.	Aids in browning and seals in flavor. Cooks some foods faster or at lower temperatures than conventional ovens.	Shortened cooking time from microwave energy, plus browning and crisping from convection heat.	Sears and browns meats quickly to seal in juices.

## MICROWAVE METHOD

Microwave cooking uses very short, high frequency radio waves to create movement between the food molecules. As microwaves are attracted to the food, heat is generated by friction between molecules to cook food quickly. Microwave cooking is faster than conventional methods yet allows food to retain natural texture and flavor. Microwave cooking heats the food, not the container or the inside of the oven.

Your oven is rated at 700 watts and has 10 microwave power levels which allow you to prepare foods at the most desirable cooking power for best results. Each microwave power level cooks food with a certain percentage of microwave power. For example, Power Level 7 is 70% microwave power. (Note that Power Level 0 is 100% or Full power). These ten power levels enable you to do such things as simmer and defrost foods (see page 12 for details on Accu-Thaw).

Reheating leftovers is also very convenient on Microwave (see page 13 for Automatic Reheat instructions).

Microwave cooking also allows you to cook to a desired end temperature using the temperature probe (see page 15 for further temperature probe instructions).

## CONVECTION METHOD

Convection cooking is much like cooking in a conventional oven only the convection oven uses a fan to constantly

circulate the hot air around the food. This forced air circulation allows for more even browning of baked foods. Cooking times or oven temperatures can many times be decreased to provide more efficient cooking. Convection temperatures range from 200°F to 450°F.

## COMBINATION METHOD

Combination cooking combines the speed of microwave cooking with the browning capabilities of convection cooking to create an exciting way to prepare foods. Proper cookware selection insures good results. Your oven has 4 Combo Settings for your convenience. Select one of the four preprogrammed oven temperatures and the oven automatically combines the convection temperature with microwave power to cook the food (see pages 17-18).

The oven's Auto Combo feature takes all the guess work out of combination cooking by using the temperature probe to cook food to a desired temperature. Choose from 10 different Auto Combo programs (see page 19 for more details).

## BROILING METHOD

The Broil feature and the broiler pan set allow you to sear and brown chops, steaks, chicken pieces, etc. to suit your taste. One broiling temperature (450°F) and the time charts in the cookbook make broiling easy.



# HOW TO PROGRAM YOUR OVEN

Each time you program cooking instructions into the control panel, you will follow a sequence of steps. As you become familiar with your oven, these sequences will become easier. The recipes and charts in the cookbook will indicate which cooking method you should use. In many cases, you will be able to choose from several described methods. In most cases, the recipes will tell you to place food in the oven, close the door, and then program the oven. In some methods, such as convection, you will place food in the oven after the oven has been preheated. Find the programming sections you need for each recipe in the following pages with indexed edges.

Remember to use your cookbook and this use and care manual together to make programming and cooking safe, easy, and enjoyable.

## First - Set the Optional Entry Signal and the End-of-Cycle Signal

**The optional entry tone.** Your oven is designed to give you the option of a “beep” signal whenever a pad is pressed. This signal lets you know the control panel has “read” and accepted your entry. If pad does not beep when pressed, the entry was not accepted by the control panel. This is the shortest oven signal.

### To set the entry tone:

1. Plug in the oven. Dash lines will appear in the display.
2. Press **0**. The oven will “beep” now and whenever you press any pad.

### To cancel the entry signal:

Unplug the oven and reconnect it. Dash lines will appear in the display. Do not press **0**. Now the oven will not beep when you press the pads.

**The end-of-cycle signal.** This optional signal is set to “beep” to indicate when cooking time has elapsed and when food or oven has reached a set temperature. The signal, which is about two seconds long, is automatically set when you plug in the oven.

### To deactivate the end-of-cycle signal:

Press **TIMER** before setting the clock (while the dash lines are still displayed).

**Note:** Throughout this manual, you will note references to a beep that signals the end of a cooking or timing operation. If you have cancelled the end-of-cycle signal, disregard these references.

The entry and end-of-cycle signals can be programmed independently of each other.

## Second - Set the Clock

### To Set the Clock

1. Press **RESET**.
2. Enter the **time of day** by pressing the **number** pads in sequence. For example, if it is 10:35 (a.m. or p.m.), press number pads **1**, **0**, **3** and **5**, in that order.
3. Press **CLOCK** twice. The clock is now set. If oven power is interrupted (for example, if the supply circuit is disconnected, or if there is a power failure), all programming instructions will be erased, and dashes will appear in the display. To reset the clock, set optional entry tone and end-of-cycle signal as desired and repeat steps 1-3 above to set the clock.

Note that this is an optional feature. If you do not program clock, the display will remain blank. This is a 12 hour clock with no distinction between AM and PM.

## Third - Practice Programming the Oven

The best way to learn how to program your oven is by doing just that — programming! Start off by reading over the following hints which will help you to understand the programming sections in this manual. When you practice, place a cup of water in the oven before beginning. Read through the programming section (the page will have an indexed edge) for the cooking method to make sure you understand what steps you need to program. Then to make practicing easier, you can follow the **program summary** to the left of the detailed steps. The program summary is there to make programming your oven even simpler. Look at the example below.

## Program Summary

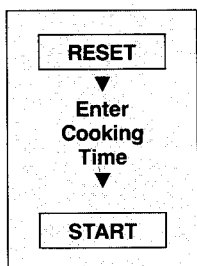

## Example of Programming Instructions:

1. Step one usually tells you to press **RESET** to clear any leftover programs from the oven memory.
2. Some steps give instructions such as “enter cooking time” or “enter temperature.” See hints on page 11.
3. When you have programmed in all the necessary instructions and checked them again, you’ll press **START** and the oven will begin operating.

**Note:** The program summary is not a picture of the control panel but a sequence of steps. The small arrows tell you which pad or group of pads to press next. It’s a good idea to familiarize yourself with the various pads on the control panel. The instruction type pads are depicted by the boxed-in words (such as **RESET** and **START** in example to the left).

## More Practice Hints

- **How to program cooking time:**

**Cooking times** are always programmed by pressing the number pads in sequence. For example, if recipe calls for 12 minutes cooking time, press number pads **1, 2, 0, 0** in that order. Note that you can program up to 99 minutes and 99 seconds in each program.

- **How to program temperature probe temperatures:**

Programming **temperatures** for the temperature probe is accomplished by pressing the number pads in the same order you would write the temperature. For example, if meat is to be cooked to 170°F, press number pads **1, 7, 0** just as you would write the numbers. Remember to insert temperature probe properly.

- When ACCU-TEMP pad is pressed, an “F” will appear with the programmed temperature which represents degrees Fahrenheit (°F).
- When practicing, you’ll want to use short cooking times (30-50 seconds) and low temperatures (such as 140°F) so that your practice sessions can be quick. You might also want to use the Program Summary Guide on the back page for easy reference.
- Throughout the programming instructions you will notice steps to “check” or “review” the oven temperature, actual food temperature, programmed temperatures, or remaining cooking time. These are denoted by \*. Press the pad designated while the oven is operating.
- **PGM1** will appear on the display for most programs. It may flash during programming but stops when **START** is pressed and oven begins operating. This is normal.
- If you press **RESET** while the oven is stopped, the programming instructions will be erased. If you press **RESET** while oven is operating, the display will show what the oven is currently doing.

## How to Stop or Interrupt Cooking:

You can stop or interrupt cooking at any time by pressing **STOP** or by **opening the door** using the push-to-open door release. Either will stop the oven immediately without erasing the programmed instructions.

Press **START** to resume programmed cooking.

Or

Press **RESET** to erase programmed instructions and return display to time of day.

## If You Make a Mistake

At some time while you’re learning to use your Radarange Oven you may make a programming mistake. If you do make a mistake, or are confused about what you’ve done—it’s easy to get back on the right track.

—If the oven isn’t operating — Press **RESET**. This will cancel all the instructions you’ve given the oven and you can start again.

—If the oven is operating — Press **STOP** then press **RESET**. This will erase everything you’ve set the oven to do and you can start again.

## The Error Signal

The oven will sound an Error Signal (a tone slightly longer than the normal entry beep) when you attempt to program something illogical:

- If you attempt to program an invalid clock setting such as 14:00.
- If you attempt to program a temperature lower than 100°F.
- If you attempt to program the oven to cook to temperature without having inserted the temperature probe into the oven wall receptacle first.

(This signal cannot be cancelled.)

## How to Use the Oven as a Timer

Your oven can be used as a kitchen timer to time mixing, steeping, or even phone calls.

To use timer when oven **is not** cooking:

1. Press **RESET** to erase any previous programs.
2. Enter **amount of time** by pressing **number** pads in sequence. For example, for 10 minutes press number pads **1, 0, 0, 0**, in that order.
3. Press **TIMER** pad and time will count down second by second, and display will show “TIMER.” When countdown time has elapsed, the oven will beep and time of day will reappear on the display.

To use timer when oven **is** cooking:

1. Do **NOT** stop the oven. Press **number** pads for the time desired. The numbers will replace the cooking time in the display.
2. Press **TIMER**. The display will countdown and show “Timer.” The oven will continue to cook undisturbed. When timer has elapsed, the oven will beep and the display will return to the remaining cooking time and the oven will finish cooking.
3. To change a timer setting, simply press **new time** desired and press **TIMER** again. Do not stop the oven.
  - To check remaining cooking time, press **RESET**.
  - To return to Timer time, press **TIMER**.
  - To cancel Timer while oven is cooking, press **RESET** twice.

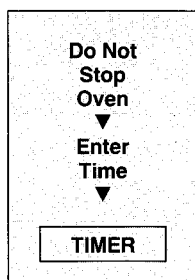
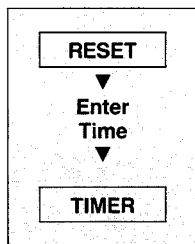

# MICROWAVE

## Full Power Microwave Cooking

Many foods can be cooked or reheated on **Full Power** on **Microwave** and this is the fastest, easiest way to cook. Use the simple procedure below to cook on Full Power. (Full Power is 700 watts.) Remember to start with minimum cooking time and add time as needed to finish cooking.

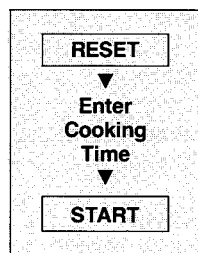

### For Full Power Microwave Cooking:

1. Press **RESET**.
2. Enter **cooking time** by pressing **number** pads in sequence. For example, to program 8 minutes, press number pads **8, 0, 0**, in that order.
3. Press **START**. Cooking time will begin to count down. "POWER," "PGM1," and "MICRO" will also appear in display. (The oven automatically cooks on Full power unless programmed otherwise.)
4. When cooking time has elapsed, the oven will beep to indicate time is finished. Time of day will return to display.

To add more cooking time, repeat steps 2-3 above.

## Other Power Level Microwave Cooking (90-10%)

Some foods will cook better on power levels lower than Full power (100%). Follow cookbook and recipe guidelines to select the proper power level and follow the programming procedure below when microwave cooking on a power level lower than Full power. Remember to start with minimum cooking time and add time as needed to finish cooking.

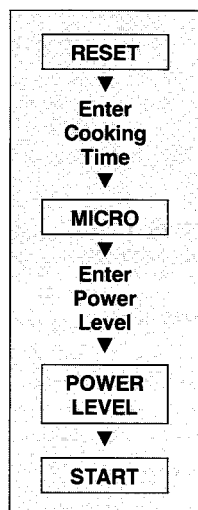

### For Power Level Microwave Cooking:

1. Press **RESET**.
2. Enter **cooking time** by pressing **number** pads in sequence. For example, to program 8 minutes, press number pads **8, 0, 0**, in that order.
3. Press **MICRO**.
4. Enter **power level** desired by pressing corresponding **number** pad. For example, press **7** for Power Level 7 (70%).
5. Press **POWER LEVEL**. Cooking time, power level and "MICRO" will show in display. ("PGM1" will flash.)
6. Press **START**. Cooking time will begin to count down and the "POWER" indicator will pulse off and on as the microwave energy cycles according to the power level program.
7. To change the power level while the oven is cooking, enter **new power level** by pressing corresponding **number** pad, then press **POWER LEVEL**. Oven will automatically begin cooking at the new power level you have selected. You do not need to stop the oven. This is helpful to reduce boiling foods to a simmer.
8. When cooking time has elapsed, the oven will beep to indicate time is finished. Time of day will return to display. Note that you can also program the power level before the cooking time, if desired. If at any time you make a mistake programming the oven, press **RESET** and start again.

## ACCU-THAW (MICROWAVE DEFROSTING)

Defrosting foods in your oven can be a real time saver. Refer to the cookbook for defrosting guidelines and time charts.

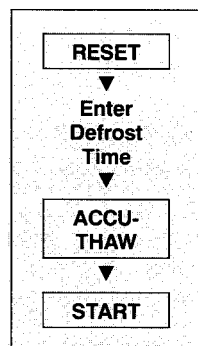

### For ACCU-THAW Defrosting:

1. Press **RESET**.
2. Enter **defrosting time** by pressing **number** pads in sequence. For example, to program 22 minutes of defrost time, press number pads **2, 2, 0, 0**, in that order.
3. Press **ACCU-THAW**.
4. Press **START**. Defrosting time will begin to count down. "DEFR" and "PGM1" will show in display and "POWER" will pulse off and on as microwave energy cycles according to Accu-Thaw program.
5. When defrosting time has elapsed, the oven will beep to indicate the defrosting time is finished.

# AUTOMATIC REHEAT

The **Automatic Reheat** feature of your oven is one of the microwave programs that makes reheating leftovers fast and easy. The **REHEAT** pad is programmed to automatically reheat a plate of food for **2 minutes and 45 seconds on Full power**. Just follow the simple steps below.

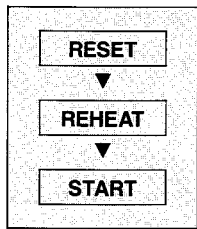

## To Program REHEAT:

1. Press **RESET**.
2. Press **REHEAT**. 2 minutes and 45 seconds appears on display.
3. Press **START**. Cooking time will begin to count down.
4. When cooking time has elapsed, oven will beep to indicate the reheating time is finished. Time of day will return to display.

The preprogrammed reheating time can be changed to fit your individual reheating needs. Follow the steps below to program in your new reheating time. Note that this new time is saved in memory and will appear whenever the Automatic Reheat feature is used. (If there is a power interruption or the unit is unplugged, the Reheat time will return to 2 minutes 45 seconds, but can be changed again if desired.)

## To Change the Automatic Reheat Time:

1. Press **RESET**.
2. Enter new microwave **reheating time**, by pressing the **number** pads in sequence. For example, if 1 minute and 30 seconds is desired, press **1, 3, 0**, in that order.
3. Press **REHEAT**.
4. Press **RESET** and display will return to time of day. The new time entered will now appear when you program oven to Reheat as described above.

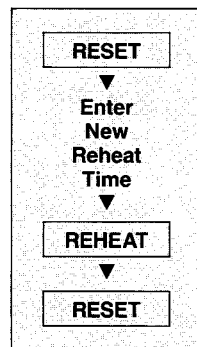

# READY TIME

You can program your oven to have hot food ready for you at a selected time. Be sure to follow the helpful guidelines below.

**CAUTION:**  
**To Avoid the Risk of Food Poisoning, Bacterial Growth and the Production of Toxins: Never hold meat, poultry, milk, eggs or fish products more than two hours.**

The automatic Ready Time feature lets you program the oven to start cooking food up to 12 hours later. Remember:

1. **Do not hold any perishable food longer than two (2) hours.** Highly perishable foods such as milk, eggs, fish, poultry and stuffing should not be cooked using the automatic Ready Time feature.
2. **Use only frozen foods if the food is highly perishable and the food is to be held longer than 1 hour before cooking.**
3. **Use foods that require little or no stirring or turning.** If you are not there to turn or stir food when suggested, cooking results will be less than optimum.
4. **The safest foods to use are frozen casseroles and main dishes, or non-frozen soups or casseroles that do not contain meat, milk or eggs.**
5. **Be sure the correct cooking sequence is programmed.** If the oven is programmed to cook unattended too fast or too long, there is a remote chance a fire could occur. Extreme overcooking can cause food to smoke or char.
6. **Caution children and others not to touch the control panel after the oven is programmed.** If any pads are pressed, cooking instructions could be altered.
7. **Be sure the oven time-of-day clock is correct.** Ready Time will not accept invalid clock times.
8. **Remember to press START** before you leave the oven. Otherwise, the oven will not have the food cooked at the programmed Ready Time.

### Preparing Frozen Main Course For Ready Time

Freeze directly in the cooking dish, or line dish with enough freezer cellophane or paper to finish wrapping after food is frozen. Remove freezer wrap and cover food with plastic wrap or a glass lid before cooking.

**Note:** If you enter a Ready Time that does not allow enough time to cook food and have it done at the programmed Ready Time, the oven will begin cooking the food when you press **START** and will cook the food for the programmed amount of cooking time. Press **READY TIME** to return display to the time the food will be ready. (The food will finish cooking some time after the Ready Time you have selected.)

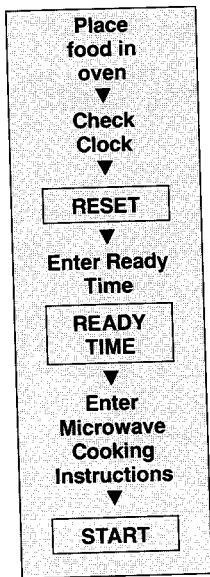

## To Program READY TIME:

1. Place food in oven and close oven door.
2. Check that the oven clock is set at **correct time of day**.
3. Press **RESET**.
4. Enter desired **ready time** by pressing **number** pads in sequence. For example, if you want dinner to be ready at 5:00, press **5, 0, 0**, in that order.
5. Press **READY TIME**. The oven will automatically calculate when the oven will start to cook after you finish programming the cooking instructions. "Ready" will show in display.
6. Enter desired cooking instructions.
  - A. Enter **cooking time** by pressing **number** pads in sequence.
  - B. Press **MICRO**.
  - C. Enter desired **power level** by pressing the corresponding **number** pad.
  - D. Press **POWER LEVEL**.
7. Press **START**. The oven will not start operating until the calculated start time. Note that "PGMI" should not be flashing after you press **START**, this indicates that the oven is programmed to automatically begin cooking at the calculated start time to insure the food is ready when you want it. The display will show cooking time you have selected.
8. When time reaches the calculated start time, the oven starts to cook as programmed. Cooking time will count down. Food will be finished cooking at desired Ready Time.
9. When time reaches Ready Time, oven will beep and stop cooking. Time of day will return to display. You may want to stir food before serving.
10. To cancel programmed Ready Time you must press **STOP** and then **RESET**. Time of day will return to display.

## READY TIME AS AN ALARM CLOCK

You can use the **Ready Time** feature as an **alarm clock** to remind you when to take medicine...or when it's time to leave for an appointment. Note that the oven cannot be used to cook food when you are using this feature.

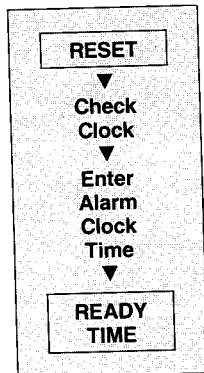

## To Program Ready Time for Alarm Clock:

1. Press **RESET**.
2. Check that oven clock is set at **correct time of day**.
3. Enter desired **alarm clock time** (within the next 12 hours) when you'd like to be reminded to do something. For example, if you need to leave for an appointment at 9:15, press **number** pads **9, 1, 5**, in that order.
4. Press **READY TIME**. Do not press **START**. The oven will beep at the time you have programmed it to remind you.

## READY TIME AS COOKING TIME REVIEW

Your oven has an exciting **Cooking Time Review** feature which allows you to know what time your food will be finished. This feature works when you are using **timed** cooking programs only (not during temperature probe cooking programs). Anytime you are cooking by **time**, you can press the Ready Time pad and the oven will automatically display the time the food will be finished cooking.

## To use Ready Time to see finished cooking time:

1. Press **READY TIME** (after you have pressed **START**). Oven must be operating when you press Ready Time pad. (Remember this feature can't be used when cooking to temperature with the temperature probe because cooking is not done by time.)
2. Display will show time when food will be finished cooking.
3. Press **RESET** to return remaining cooking time to display.

# TEMPERATURE PROBE COOKING GUIDELINES

The **temperature probe** allows you to cook foods to a precise temperature. It can be used for not only cooking foods, but also reheating leftovers, warming soups, and for a variety of other food preparations. You can also hold foods such as casseroles and meats at serving temperature for even the latest of late arrivals or use it to tenderize or simmer foods. Use the temperature probe in **Microwave, Combination, Convection, and Auto Combo**. Read this introductory temperature probe page and then refer to each section for programming instructions.

## Hints to Know Before Using the Temperature Probe

- The temperature probe's sensing range is 100°F to 190°F.
- "Probe" will always show in display when probe plug is properly inserted in the oven wall receptacle.
- The temperature probe can be programmed in 1°F increments. (For example, 141°F can be programmed, if desired).
- If food is hotter than programmed temperature, the End of Cycle Signal will sound.
- Removal of temperature probe during any non-temperature cooking program or during a temporary stop in the middle of non-temperature cooking should not cancel remaining program, if no number pads are pressed. If any number pad is pressed, you must reprogram the oven.
- Do not use the temperature probe to cook candies. The highest temperature sensed by the probe is 190°F, while most candies require temperatures of 230°F or higher.
- Do not use the probe with foil or other metal since arcing could result. If the recipe suggests using foil, do not use the probe.
- Do not use the temperature probe system when cooking several different foods at the same time. Different foods cook at different speeds and the results may be unsatisfactory.
- Do not use probe with any type of browning dish—arcing may occur causing damage to probe or oven.
- **AUTOMATIC HOLD** — In Microwave and Combination, the oven automatically "holds" the food at the programmed temperature if that temperature is 140°F or above, for 60 minutes or until you stop the oven. The "hold" uses microwave energy only. Each time the oven is stopped and restarted, the 60 minute hold time starts over.

## How to Use and Insert the Probe

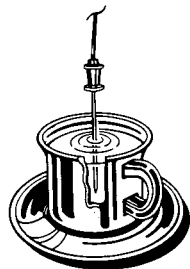
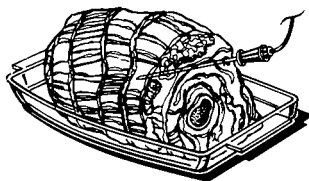

- 1) To program the oven for temperature probe cooking, plug must be connected to oven wall receptacle.
- 2) Insert the temperature probe into food as shown.  
Meats — Insert the probe sensor tip into the thickest lean portion of the meat, but away from any fat or bone. Inaccurate probe readings can occur when the sensor tip is touching fat or bone and the meat will not cook to the desired doneness.  
Casseroles, Leftovers, Beverages — Insert probe sensor tip in center of food. See left. See additional guidelines in cookbook for particular foods.
- 3) Probe should be inserted **at least one inch** into center of food to insure accurate temperature reading. If probe is not inserted securely into the food, it may fall out accidentally and the air temperature will be sensed and food will not cook properly. Arcing (bluish sparks) and damage to the probe can result.
- 4) **Do not force the temperature probe into frozen food.** The sensor tip could be damaged or the probe could break.
- 5) Do not allow temperature probe tip to touch surface of oven wall. Damage to probe and/or oven can result.
- 6) Do not hit or drop probe. Damage may occur causing incorrect temperature readings and inaccurate cooking results.
- 7) **Do not operate the oven if probe is caught in oven door.**
- 8) **Use a hot pad to remove the hot temperature probe.** During cooking, the probe and oven can become hot enough to burn you.
- 9) **Always remove the probe after use.** Do not store it in the oven. Keep it in a place where it won't become lost or damaged. If oven should be turned on accidentally, damage to probe and/or oven can result.
- 10) **Do not immerse probe in water or wash in dishwasher.** Wash the probe by hand with hot, soapy water. Rinse and dry probe thoroughly.
- 11) If wires should ever become exposed on the probe, do not use the temperature probe.

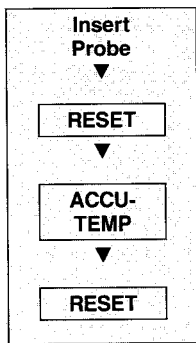

## How to Use Your Temperature Probe as a Thermometer

You can use the temperature probe as a thermometer, even when the oven isn't cooking. For example, you may want to see if tap water is warm enough to soften dry yeast (112°F). Note that the temperature probe will display temperatures below 100°F.

When oven is **not** cooking:

1. Place food or water item in the oven.
2. Insert temperature probe tip into food item and probe plug into oven cavity wall receptacle. (Oven door can be open or closed.)
3. Press **RESET**.
4. Press **ACCU-TEMP**. The actual food temperature will show on the display.
5. Remove probe and food item. Press **RESET** and display will return to time of day.

## How to Use Your Temperature Probe as a Monitor

You can use the temperature probe to **monitor** the temperature of the food when you are cooking by time.

When the oven is cooking by time:

1. Be sure the temperature probe tip is inserted securely in the food and the probe plug is inserted into the oven wall receptacle.
2. Program oven to cook by time according to cooking program you have selected. Note that the probe remains inserted in the food during cooking. The probe must not touch oven walls.
3. Press **ACCU-TEMP** while oven is cooking to monitor the progress of food temperature. The display will show the actual food temperature and oven will continue cooking.
4. Press **RESET** to return display to cooking time. Do not press **RESET** if oven is stopped since all programmed instructions will be erased.

You can monitor the food temperature at anytime during timed cooking by repeating steps 3-4 as long as the oven is operating.

### Preparing Frozen Main Course For Ready Time

Freeze food directly in the cooking dish, or line dish with enough freezer cellophane or paper to finish wrapping after food is frozen. If a temperature probe will be used during cooking, freeze food with a clean, rigid plastic straw inserted slightly off center in the food, without touching the bottom of the dish. Cut top of straw so only 1/4 inch to 1/2 inch is visible above the food. Insert probe through the straw when food is taken out of the freezer. Remove freezer wrap and cover food with plastic wrap or a glass lid before cooking.

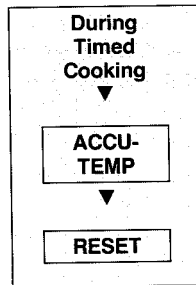

# MICROWAVE WITH TEMPERATURE PROBE

Using the **temperature probe** can simplify your microwave cooking, since the oven will automatically cook the food to the temperature you've selected. See page 15 for instructions on inserting and using the temperature probe.

## For Microwave Temperature Probe Cooking:

1. **Insert probe** tip into food and probe plug into oven wall receptacle. Close oven door.
2. Press **RESET**.
3. Enter **food temperature** desired by pressing **number** pads in sequence. For example, to cook to 140°F, press number pads **1, 4, 0**, in that order.
4. Press **ACCU-TEMP**. The display will show set temperature, "TEMP," and "PROBE." ("PGM1" will flash.)  
NOTE: If the probe is not securely inserted or is damaged, the Error Signal will sound and the display will return to time of day when you press ACCU-TEMP. Reinsert probe and reprogram instructions.
5. Enter **power level** desired by pressing corresponding **number** pad. For example, press **5** for Power Level 5 (50%). Note: If you want Full Power, do not program steps 5 and 6 since the oven will automatically cook on Full Power unless programmed otherwise.
6. Press **POWER LEVEL**.
7. Press **START**. Oven begins cooking. (Notice you don't have to program cooking time because the oven will automatically cook to temperature only.) The display will show actual food temperature, "PGM1," "MICRO," "POWER," "TEMP," and "PROBE." The power level, if less than Full power, will show in corner of display. If the food temperature is lower than 100°F, the display will show "95F" until food temperature rises above 100°F.
  - To review programmed temperature, press **COOKING PROGRAM**.
  - To return to actual food temperature, press **RESET**.
8. To change the programmed temperature during cooking, press **number** pads for new temperature, then press **ACCU-TEMP**. Do not stop the oven.
9. When the food reaches programmed temperature, the oven will beep. If the programmed temperature is 139°F or lower, the oven will automatically stop when the temperature is reached. Remove the food and probe from oven.

**AUTOMATIC HOLD** — If the set temperature is 140°F or higher, the oven will automatically "hold" food at that temperature for 60 minutes or until you press STOP. If you stop and restart the oven during the hold period, the timing of the 60 minutes will begin again. (If you wish to keep track of the remaining time the food is held, enter 60:00 at beginning of hold time and press TIMER.)

10. When holding or cooking time is finished, press **STOP**. Remove food and probe from oven. If food is not thoroughly cooked as desired, reinsert probe and return to oven. You may want to increase the set temperature slightly. If food is cooked as desired, press **RESET** to return display to time of day. Remember to wash probe by hand as described on page 24.

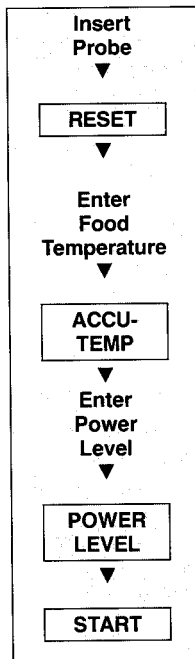

## **CAUTION:**

**Exterior and Interior Oven Surfaces, Including the Oven Door, Become Hot During Convection, Combination, and Broiling. Use Care When Opening or Closing Door and When Inserting or Removing Food, Accessories, or Temperature Probe.**

Your oven's **Combination** feature offers you the combined versatility of both microwave and convection cooking. The four settings in this feature help you cook foods quickly while roasting and evenly browning them. There is usually substantial time savings over conventional cooking methods when you cook on Combination, since the convected heat circulates continually and the microwave energy alternates off and on during cooking time. Refer to the recipes and instructions in the cookbook to select the proper Combination setting.

Combination Code	Convection Oven Temperature
1	275°F
2	300°F
3	325°F
4	375°F

(Note that the Microwave power is 30% for all four combination settings.)

The Combination feature has one automatic **preset** program. This preselected program is the **easiest** way to cook on Combination since the oven automatically programs the microwave power and the oven temperature to 325°F. All you do is program in the cooking time you want. You'll find this combination setting handy for cooking many foods.

### To Program Oven for Combination Preset Program (325°F Convection Temperature):

1. Place food in oven. Close oven door.
2. Press **RESET**.
3. Enter **cooking time** by pressing **number** pads in sequence. For example, if desired cooking time is 12 minutes, press **1, 2, 0, 0**, in that order.
4. Press **COMBO**. Oven automatically programs microwave power and convection temperature (325°F).
5. Press **START**. Oven begins to cook and cooking time begins to count down.
  - To review programmed oven temperature, press **COMBO**.
  - To return to remaining cooking time, press **RESET**.
6. When cooking time has elapsed, the oven will beep to indicate cooking time is finished. Time of day will return to display.

To **preheat** for Preset Combination (325°F) press **COMBO** then **START**. "P" will appear in display. When oven is preheated and beeps, place food in oven and complete steps 3-5 above. Note that this preheat only uses convection heating, although "COMBO" appears in the display.

If your recipe or cooking instructions call for a combination setting other than the one with the 325°F convection temperature, you can easily program the oven to cook at other combination settings using the following steps.

### To Program Combination:

1. Place food in oven. Close oven door.
2. Press **RESET**.
3. Enter **Combination code** by pressing corresponding **number** pad. For example, if the desired convection temperature is 375°F, press number pad **4**.
4. Press **ACCU-TEMP**. Oven convection temperature will appear in display. (NOTE: the microwave power level is automatically programmed when you select the combination code.)
5. Enter the **cooking time** by pressing the **number** pads in sequence. For example, if 12 minutes is desired, press number pads **1, 2, 0, 0**, in that order.
6. Press **COMBO**.
7. Press **START** and cooking time begins to count down. "PGM1" and "COMBO" show in display and "POWER" indicator pulses as microwave power cycles off and on.
  - To check programmed oven temperature, press **COMBO**.
  - To return to remaining cooking time, press **RESET**.
8. When cooking time has elapsed, oven will beep to indicate cooking time is finished. Time of day will return to display.

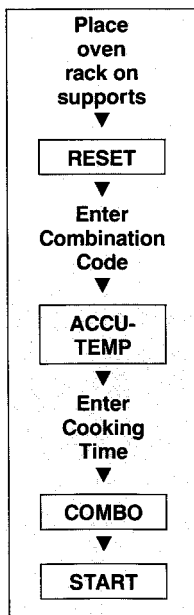
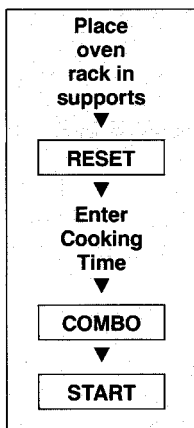



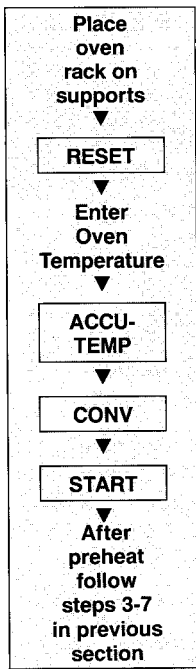

If recipe calls for preheated oven other than 325°F (Combo 3) follow these steps first, then complete steps 3-7 in previous section on bottom of page 17.

### To Program Oven to Preheat:

1. Close oven door.
  2. Press **RESET**.
  3. Enter **oven temperature** for preheat by pressing **number** pads in sequence. For example, if 300°F is desired, press **3, 0, 0**, in that order.
  4. Press **ACCU-TEMP**.
  5. Press **CONV**.
  6. Press **START**. "P" will appear in display to indicate oven is preheating. If actual oven temperature is less than 200°F, the display will show "195F."
  7. When oven has preheated to programmed temperature, oven will beep.  
Proceed by placing food in oven and following steps 3-7 in previous section on bottom of page 17.
- Safety Feature: The oven will automatically shut off after 45 minutes of preheat if no cooking time is entered.

Note: During Combination programs and Auto Combo, you will hear the convection blower and the microwave blower cycle off and on with the microwave power. These oven sounds are normal.

## COMBINATION WITH TEMPERATURE PROBE

**CAUTION:**  
Exterior and Interior Oven Surfaces, Including the Oven Door, Become Hot During Convection, Combination, and Broiling. Use Care When Opening or Closing Door and When Inserting or Removing Food, Accessories, or Temperature Probe.

You can cook foods to temperature by using the temperature probe on Combination. Follow the recipes and instructions in the cookbook and refer to page 15 in this manual for instructions on inserting and using the temperature probe.

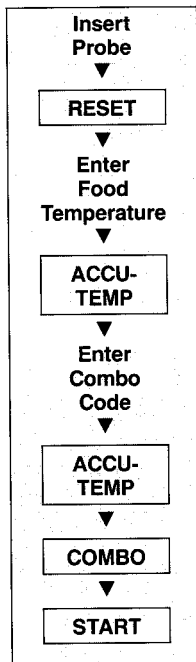

### For Combination Temperature Probe Cooking:

1. **Insert probe** tip into food and probe plug into oven wall receptacle. Close oven door.
2. Press **RESET**.
3. Enter **food temperature** desired by pressing **number** pads in sequence. For example, to cook to 140°F, press number pads **1, 4, 0**, in that order.
4. Press **ACCU-TEMP**. The display will show programmed temperature, "PROBE" and "TEMP." ("PGM1" will flash.)
5. Enter the **Combination code** by pressing the corresponding **number** pad. For example, if the desired oven temperature is 300°F, press number pad **2**.
6. Press **ACCU-TEMP**.
7. Press **COMBO**. (Note that the microwave power level is automatically programmed when you select the combination code.)
8. Press **START**. Oven begins cooking. (Notice you don't have to program cooking time because the oven will automatically cook to temperature only.) The display will show actual food temperature, "PGM1," "COMBO," "TEMP," and "PROBE." "POWER" will pulse off and on as the microwave energy cycles. If the food temperature is lower than 100°F, the display will show "95F" until food temperature rises above 100°F.
  - To review programmed food temperature, press **COOKING PROGRAM**.
  - To review programmed oven temperature, press **COMBO**.
  - To return to actual food temperature, press **RESET**.
9. To change the programmed temperature during cooking, press **number** pads for new temperature, then press **ACCU-TEMP**. Do not stop the oven.

# COMBINATION (con't.)

- When the food reaches programmed temperature, the oven will beep. If the programmed temperature is 139°F or lower, the oven will automatically stop when the temperature is reached. Remove the food and probe from oven.

**AUTOMATIC HOLD** — If the set temperature is 140°F or higher, the oven will automatically “hold” food at that temperature for 60 minutes or until you press STOP. This hold is microwave power only (no convection heat is generated). If you stop and restart the oven during the hold period, the timing of the 60 minutes will begin again. (If you wish to keep track of the remaining time the food is held, enter 60:00 at beginning of hold time and press TIMER pad.)

- When holding or cooking time is finished, press **STOP**. Remove food and probe from oven. If food is not as thoroughly cooked as desired, reinsert probe and return to oven. You may want to increase the set temperature slightly. If food is cooked as desired, press **RESET** to return display to time of day. Remember to wash probe by hand as described on page 24.

## AUTO COMBO



### CAUTION:

Exterior and Interior Oven Surfaces, Including the Oven Door, Become Hot During Convection, Combination, and Broiling. Use Care When Opening or Closing Door and When Inserting or Removing Food, Accessories, or Temperature Probe.

The Combination feature of your oven has a unique **Auto Combo** program. There are 10 preprogrammed settings to choose from as the chart below shows. Using the Auto Combo program and the temperature probe together takes all the guesswork out of cooking meat, roasts, turkey and casseroles. Refer to the guidelines and charts in the cookbook for more details. See page 15 of this manual for instructions on inserting and using the temperature probe.

AUTO COMBO CODE	Food	Temperature	AUTO COMBO CODE	Food	Temperature
1	Beef (Rare)	120°F	6	Lamb (Well)	160°F
2	Beef (Medium)	140°F	7	Pork	170°F
3	Beef (Well)	160°F	8	Ham (Cooked)	120°F
4	Veal	160°F	9	Turkey	185°F
5	Lamb (Medium)	140°F	10	Casserole	160°F

### Special Hints for AUTO COMBO Cooking

- Be sure to read the instructions in the cookbook.
- For bone-in cuts of meat, you may want to turn roasts over and reinsert the probe when the food temperature reaches 100°F. Press START to continue cooking to programmed end temperature.

### To Program Auto Combo:

- Insert probe** tip securely into food and probe plug into oven wall receptacle. Close oven door. “Probe” appears in display.
- Press **RESET**.
- Enter **Auto Combo code** by pressing corresponding **number** pad. For example, if cooking pork, press **7**.
- Press **AUTO COMBO**. Auto Combo code number appears in upper right hand corner of display and program temperature appears.
- Press **START**. (Note that you don’t have to program cooking time because oven will automatically cook to temperature only.) Display shows actual food temperature. If food temperature is lower than 100°F, the display will show “95F” until the food temperature increases above 100°F.
  - To check the program temperature, press **COOKING PROGRAM**.
  - To return to actual food temperature, press **RESET**.
- When the programmed temperature is reached, the oven will beep and stop. Remove the food and probe from oven. If food is not as thoroughly cooked as desired, reinsert probe and program oven to finish cooking on microwave temperature hold at a reduced power level. Wash probe by hand as described on page 24.

After cooking, let roasts and turkey stand 10 to 15 minutes, tented with foil, to allow the meat to finish cooking and make carving easier.

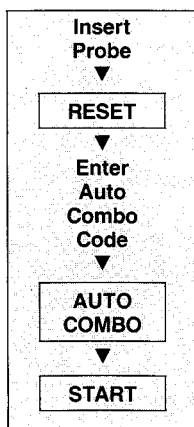



## CAUTION:

**Exterior and Interior Oven Surfaces, Including the Oven Door, Become Hot During Convection, Combination, and Broiling. Use Care When Opening or Closing Door and When Inserting or Removing Food, Accessories, or Temperature Probe.**

Your oven's **Convection** feature uses the circulation of heated air to evenly brown baked goods. You can easily cook your own favorite recipes on convection by following the guidelines in the cookbook. Generally, conventional baking temperatures are decreased by 25°F to 50°F or baking times might be slightly decreased, depending on the particular food. Refer to the cookbook for more recipes and instructions to help you select cooking times and temperatures for foods you wish to cook on convection. The cookbook also has charts for prepackaged items such as cakes, muffins, pizza, etc. Convection oven temperatures range from 200°F to 450°F. You can also cook with or without preheating the oven, depending on the method your recipe recommends.

The **convection** feature has one automatic **preset** program. This is the **easiest** way to program the oven for convection cooking since the oven automatically preheats and cooks at 325°F. All you do is program in the time you want the food to cook once the oven is preheated. You'll find this convection temperature handy for cooking many foods.

### To program oven to preheat and cook at 325°F:

1. Place **oven rack** in oven rack guides, if indicated in recipe. Close oven door.
2. Press **RESET**.
3. Press **CONV**. Oven automatically is programmed to preheat and cook at 325°F. "P" will appear in upper right hand corner of display to indicate oven is ready to preheat.
4. Press **START**. Oven begins to preheat. Display shows actual oven temperature.
5. When oven reaches 325°F, the oven will beep to indicate it is **preheated**. The oven holds preheated oven temperature for 45 minutes until you are ready to place the food in the oven.
6. Continue programming oven by completing **steps 8-11** below.

If your recipe or instructions call for a convection temperature other than 325°F, you can easily program the oven by following the steps below.

### To program Convection with Preheat

1. Place **oven rack** in oven rack guides, if indicated in recipe. Close oven door.
2. Press **RESET**.
3. Enter **convection oven temperature** by pressing **number** pads in sequence. For example, if 300°F is desired, press **3**, **0**, then **0**.
4. Press **ACCU-TEMP**.
5. Press **CONV**. "P" will appear in upper right hand of display to indicate oven is ready to preheat to the programmed oven temperature.
6. Press **START**. "P" remains in display and actual oven temperature is indicated. If the actual oven temperature is lower than 200°F, then "195F" is displayed. The oven temperature will rise as the oven preheats.
  - To review programmed oven temperature, press **CONV**.
  - To return to actual oven temperature, press **RESET**. Do not press any other pads during preheat or program may be altered.
7. When the oven reaches the programmed oven temperature, the oven beeps to indicate the oven is **preheated**. The oven holds the preheated temperature for 45 minutes until you are ready to place the food in the oven.
8. Open the door and place food inside oven. Oven ends preheat mode but retains desired oven temperature.
9. Enter **cooking time** by pressing **number** pads in sequence. For example, if 15 minutes is recommended, press number pads **1**, **5**, **0**, **0**, in that order.
10. Press **START** and cooking time begins to count down.
  - To review programmed oven temperature, press **CONV**.
  - To return to remaining cooking time, press **RESET**.
11. When cooking time has elapsed, the oven will beep to indicate cooking time is finished. The oven will stop and time of day will return to display. If more time is needed to finish cooking, follow steps 2-7 in next Section (page 21), since oven has already been preheated.

Note: If **RESET** is pressed prior to entering the cooking time, it will be necessary to reprogram the convection temperature.

Safety Feature: The oven will automatically shut off after 45 minutes of preheat, if no cooking time is entered.

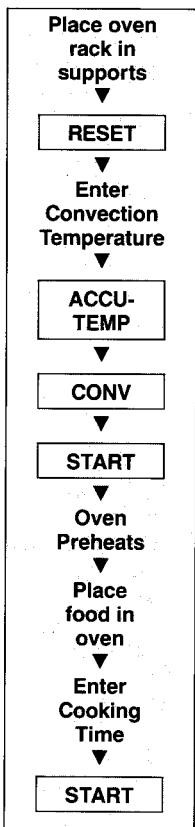
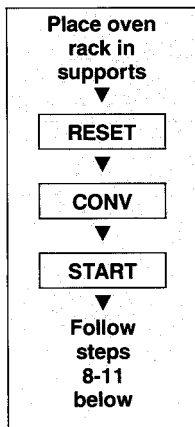

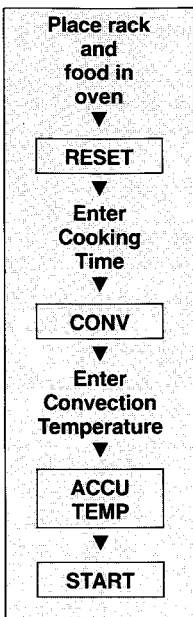

## To Program Convection Without Preheat

1. Place **oven rack** on oven rack guides, if indicated in recipe. Place food in oven. Close oven door.
2. Press **RESET**.
3. Enter **cooking time** by pressing **number** pads in sequence. For example, if 25 minutes is desired, press number pads **2, 5, 0, 0**, in that order.
4. Press **CONV**. Cooking time and "CONV" appear in display. ("PGM1" will flash.)
5. Enter **convection oven temperature** by pressing **number** pads in sequence. For example, if 300°F is desired, press number pads **3, 0, 0**, in that order.
6. Press **ACCU-TEMP**.
7. Press **START**. Cooking time begins to count down.
  - To review programmed oven temperature, press **CONV**.
  - To return to remaining cooking time, press **RESET**.
8. When cooking time has elapsed, the oven will beep to indicate cooking time is finished. The oven will stop and time of day will return to display.

**NOTE:** For repetitive use, such as baking several batches of cookies, program the oven to preheat and bake on convection for the first batch (See Section on page 20 for Convection with Preheat). For the remaining batches, program the oven by following steps 2-7 above, since the oven has already been preheated.

## CONVECTION WITH TEMPERATURE PROBE

### **CAUTION:**

**Exterior and Interior Oven Surfaces, Including the Oven Door, Become Hot During Convection, Combination, and Broiling. Use Care When Opening or Closing Door and When Inserting or Removing Food, Accessories, or Temperature Probe.**

You can prepare foods such as meats and casseroles to a set temperature by using the temperature probe on convection. Refer to the cookbook for temperature settings, recipes and further instructions. See page 15 for more details on inserting and using the temperature probe.

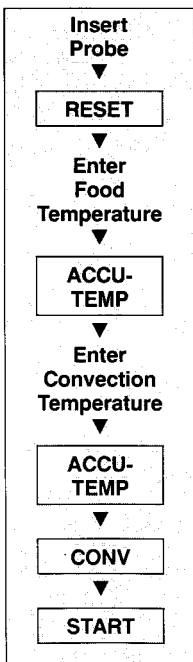

### For Convection Temperature Probe Cooking:

1. **Insert probe** tip into food and probe plug into oven wall receptacle. Close oven door.
2. Press **RESET**.
3. Enter **food temperature** desired by pressing **number** pads in sequence. For example, to cook to 140°F, press number pads **1, 4, 0**, in that order.
4. Press **ACCU-TEMP**. The display will show temperature, "PROBE" and "TEMP". ("PGM 1" will flash.)
5. Enter **convection oven temperature** by pressing **number** pads in sequence. For example, if recipe calls for 350°F, press number pads **3, 5, 0**, in that order.
6. Press **ACCU-TEMP**.
7. Press **CONV**.
8. Press **START** and actual food temperature appears on display. If actual food temperature is less than 100°F, then "95F" will show in display until food temperature rises above 100°F.
  - To review programmed convection oven temperature, press **CONV**.
  - To review programmed food temperature, press **COOKING PROGRAM** once.
  - To return to actual food temperature, press **RESET**.
9. When food reaches programmed temperature, the oven will beep and stop. Time of day will return to display.

# MULTI-STAGE COOKING

Your oven can remember up to three cooking programs to make **multi-stage cooking** easy. You can program the oven to do a variety of cooking combinations by selecting stages from Microwave, Accu-Thaw, Combination, Convection and Temperature Probe cooking programs. Examine the following multi-stage cooking examples and then follow the steps below to program your oven.

## 2 Stage Cooking Example

Program 1 Accu-Thaw (to defrost food)  
Program 2 Micro, Combo or Conv  
(to cook food)

## 3 Stage Cooking Example

Program 1 Accu-Thaw (to defrost food)  
Program 2 Full Power Microwave  
(to cook food)  
Program 3 Lower Power Level Microwave  
(to simmer food)

## To program Multi-Stage Cooking:

1. Place food in the oven. Close oven door.
2. Press **RESET**.
3. Enter one program's cooking instructions (choose one of the following methods).

### For Microwave cooking:

- A. Enter **cooking time** by pressing **number** pads in sequence.
- B. Press **MICRO**.
- C. Enter **power level** by pressing corresponding **number** pad.
- D. Press **POWER LEVEL**.

### For Accu-Thaw defrosting:

- A. Enter **defrosting time** by pressing **number** pads in sequence.
- B. Press **ACCU-THAW**.

### For Combination cooking:

- A. Enter **cooking time** by pressing **number** pads in sequence.
- B. Press **COMBO**.
- C. Enter **Combination Code** by pressing corresponding **number** pad.
- D. Press **ACCU-TEMP**.

### For Convection cooking:

- A. Enter **cooking time** by pressing **number** pads in sequence.
- B. Press **CONV**.
- C. Enter **convection oven temperature** by pressing **number** pads in sequence.
- D. Press **ACCU-TEMP**.

### For Microwave Temperature Probe cooking:

- A. Insert probe.
- B. Enter **food temperature** by pressing corresponding **number** pads in sequence.
- C. Press **ACCU-TEMP**.
- D. Enter **power level** by pressing corresponding **number** pad.
- E. Press **POWER LEVEL**.

(For Combination and Convection temperature probe cooking, refer to similar programming steps described in respective sections of this manual.)

4. Press **COOKING PROGRAM** and oven will advance to next programming stage. "PGM1" will stop flashing. Note that the flashing program is the one for which you are selecting instructions.
5. Repeat steps 3-4 for Program 2 and Program 3, remembering to press **COOKING PROGRAM** pad to advance to next program.

Note: To **review** cooking programs before you start oven, press **COOKING PROGRAM** pad. The program symbol that is flashing is the one being reviewed. For example, press **COOKING PROGRAM** and "PGM1" will flash and display will show instructions for first program. Press **COOKING PROGRAM** again and "PGM2" will flash and display will show the second stage of instructions, etc.

6. Press **START** after all stages of cooking have been programmed. Display will count down cooking time of first stage and when this time has elapsed, the cooking program of the second stage will appear and start, etc.
7. When cooking time of last stage has elapsed, the oven will beep to indicate the cooking time is finished and the display will return to time of day unless the last program is a temperature hold, which will hold the programmed temperature for 60 minutes.

Note: If selected, the temperature probe cooking must occupy the final program in the multi-stage sequence in order for the Automatic Hold feature to work. Programming the hold feature in the first or middle programs will cause the oven not to hold the food to temperature and the oven will automatically begin the next program.

Remember to select appropriate cookware that is suitable for the combination of cooking programs you have selected. Refer to page 8 for cookware selection hints.

The rack may not be used in any microwave or combination setting.

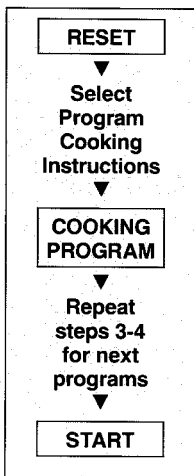

## CAUTION:

Exterior and Interior Oven Surfaces, Including the Oven Door, Become Hot During Convection, Combination, and Broiling. Use Care When Opening or Closing Door and When Inserting or Removing Food, Accessories, or Temperature Probe.

The **Broiling** feature of your oven allows you to broil meats to the doneness you like. For broiling times and procedures refer to the charts and instructions in your cookbook. Follow these procedures and those in your cookbook for best results.

### For Preheated Broiling:

1. Place oven rack on oven rack guides.
2. Press **RESET**.
3. Press **BROIL**. Display will show "450F" and "P" will appear in corner of display to tell you the oven is ready to preheat.
4. Press **START**. Oven will begin preheating and display will show "BROIL" and will read "195F" if the actual oven temperature is below 200°F.  
Note: If you press STOP or open door and then press START during the preheating time, the display will return to time of day. You must then repeat steps 2 - 3 above.
5. When the oven has **preheated**, the oven will beep to indicate preheating is finished. The oven will hold the preheat temperature for 45 minutes, until you are ready to put the food and broiler pan in the oven.
6. When you are ready to put food in oven, make sure food items are spaced evenly on broiler pan. Open oven door and place broiler pan with food inside the oven on top of the oven rack. Use caution during broiling because the oven and broiler pan become HOT.
7. Enter **broiling time** by pressing **number** pads in sequence. For example, to broil chops for 15 minutes, press number pads, **1, 5, 0, 0**, in that order.  
Note: if RESET is pressed before broiling time is entered, the Broil program will be cancelled. Broiling time, BROIL, and START must be pressed again.
8. Press **START**. Oven begins counting down broiling time. If you need to check or turn over food at any time, press **STOP** or open the door. To continue broiling, close door and press **START** and remaining time will count down.
9. When broiling time has elapsed, oven will beep to indicate broiling time is finished. Time of day will return to display. Use care when handling hot broiler pan.

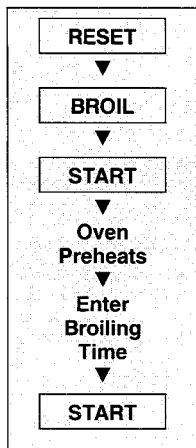

# CARE OF YOUR MICROWAVE CONVECTION OVEN

## How to Clean the Oven and Door Interior

It's important to keep the inside of the oven clean. Food splatters or spilled liquids that adhere to oven walls, door seal and door surface will absorb microwave energy and reduce efficiency of the oven.

1. The **interior surfaces** of the oven are made of stainless steel. After each use, let oven cool and then clean with cloth dampened in warm, soapy water. Make sure the cloth is wrung out well so water does not seep into the ventilation openings and damage operating parts of the oven.
2. To loosen the soil before cleaning, boil 2 cups of water in the oven using microwave energy. For greasy splatters try a non-abrasive, grease-cutting cleaner such as Formula 409®. Be careful not to spray cleansers directly into the vent openings. Always wipe oven surfaces with a clean, damp cloth to rinse off any cleanser residue.
3. To clean **inside of oven door**, wipe any splatters or food soils off the door while they are still warm. Use a cloth dampened with warm, soapy water. Rinse and wipe dry.
4. The **ceiling** of the oven should be cleaned using a cloth dampened with warm, soapy water. Do not spray or apply cleansers to the ceiling since this could damage the internal operating parts of the oven.
5. For more difficult soil, try any of the following non-abrasive cleansers to clean the **metal oven rack, ceramic oven floor, oven walls, or broiler pan**:
  - Non-abrasive, grease-cutting spray cleaner such as Formula 409®.
  - Baking soda as a cleaning powder.
  - A fine-polishing cleansing powder, such as Amana® Stain Remover or Bon Ami®.
  - Non-metal impregnated plastic and nylon pads, or plastic mesh balls.
  - Non-abrasive cleaners, such as Amana ASAP™ Cleaner-Conditioner or Soft Scrub® Cleanser, especially for ceramic oven floor.
  - Other cleaning products recommended for use on stainless steel.
6. Do not use abrasive cleansers which could cause scratching and marring of the stainless steel surface. Do not use commercial type oven cleaners.
7. Always wipe oven surfaces with clean damp cloth to thoroughly rinse off any cleanser residue. Do not leave any cleaner on oven surfaces longer than one hour.
8. If in doubt about using a particular cleanser, try it first on a small area of the top inside wall of the oven. If no staining or scratching occurs, the product should be safe to use.

Be careful not to get cleansers or water into the ventilation openings.

## How to Clean the Oven Exterior

1. The **outside surface** of the oven should be cleaned with mild detergent and water, rinsed and dried with a soft cloth.
2. To clean the **control panel**, open the oven door before cleaning to prevent oven from accidentally starting, wipe with a damp cloth followed immediately by a dry cloth. Touch **RESET** after cleaning.
3. The **oven door window** should be washed with mild detergent and water. Be sure to use a soft cloth. Never use harsh detergents or abrasives.

Note: If moisture accumulates inside or around the outside of the oven door, wipe with a soft cloth to remove. This can occur when the oven is operated under high humidity conditions and in no way indicates microwave leakage.

## How to Care for the Temperature Probe

1. Do not store temperature probe in oven. Damage to probe can occur if oven is accidentally turned on. Also, if metal portion of probe touches oven wall, arcing can occur and oven could be damaged.
2. Do not immerse temperature probe in water or in dishwasher for cleaning. Never place probe in dishwasher. Wash sensor end of probe with hot, soapy water to clean; rinse and dry.
3. If probe is dropped, dirty or severely mishandled, inaccurate temperature readings can occur.
4. Do not use temperature probe with any type of browning dish as arcing can occur and damage to probe could result.

Microwave utensils or accessories should be used only in accordance with manufacturer's instructions.

## How to Replace the Oven Light Bulb

If the oven light bulb burns out you may replace it yourself by carefully following the directions given below.

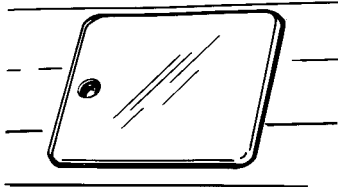

The Oven Light Bulb Cover is located on the upper side of the oven.

Step 1. **CAUTION:**  
**To Avoid the Risk of Electrical Shock, Disconnect Oven Power Cord From Electrical Outlet.**

Step 2. Unscrew and remove oven light bulb cover. Do not remove any other part of the oven cabinet.

Step 3. If light bulb is hot let it cool before removing. Turn bulb **counterclockwise** to remove from socket.

Step 4. Replace bulb with the same type of 20 watt light bulb. Insert bulb into light socket and turn in a **clockwise** direction.

Step 5. Replace oven light bulb cover.

Step 6. Plug oven power cord into electrical outlet. Reset the oven signal options and oven clock. (See page 10.)

## BEFORE YOU CALL FOR SERVICE

Be sure you have read and followed the operating instructions to avoid unnecessary service calls. The electronic control module used in this microwave oven is the finest in versatility, quality and reliability. In many cases, a customer call for module timer service is caused by conditions other than failure of the controls. That's why you should read the following before calling for service.



**NOTE:** A Power Interruption Signal (dash lines) will appear in the display whenever the oven is initially plugged into an electrical outlet. The lines will also appear whenever electrical power to the oven has been interrupted and then restored. When you see these lines, simply set the clock and the optional oven signals.

**NOTE:** Four vertical dash lines in the display indicate a damaged or defective temperature probe or convection oven thermostat.



### IF THE READOUT DISPLAY DOESN'T LIGHT UP:

- Is the oven plugged securely into the proper power outlet?
- Is a fuse blown or circuit breaker open in the house wiring?
- If the condition remains unchanged, perform the steps listed in the box on the next page.

### IF THE READOUT APPEARS WRONG:

- Did you remember to press **RESET** before programming the oven?
- Have you (or someone else) pressed the controls after cooking has started?
- If the condition remains unchanged, perform the steps listed in the box on the next page.

### IF THE CONTROL WILL NOT ACCEPT YOUR INSTRUCTIONS:

- For cooking to temperature, was "PROBE" displayed when you connected the temperature probe? If not, check to see if the probe plug is securely inserted into the oven receptacle. (Review explanation, page 15.)
- For cooking by time, if the condition remains unchanged, perform the steps listed in the box on the next page.

### IF ANOTHER FEATURE DOESN'T APPEAR TO BE OPERATING CORRECTLY:

- Have you followed the use and care instructions exactly? Review them to be sure.
- Did you press **RESET** before programming the oven?
- Is the oven plugged into a properly grounded and polarized outlet as described in the grounding instructions (page 4)? Improper installation can result in erratic operation.
- If the condition remains unchanged, perform the steps listed in the box on the next page.

### IF MICROWAVE POWER WON'T COME ON:

- Did you press **START**?
- Is the oven door securely closed?
- If the condition remains unchanged, perform the steps listed in the box on the next page.

### IF THE OVEN LIGHT PULSES DIMMER, THEN BRIGHTER:

- Is the line voltage to your home low or lower than usual? (The power company in your area should be able to tell you if there is low voltage to your home.)



If condition remains unchanged, please perform the following steps before calling for service:

1. Check to see if a fuse or circuit breaker is open in the house wiring.
  2. Unplug the oven.
  3. Reconnect the oven to the wall outlet. Dash lines will appear in the display.
  4. Press **RESET**. (Dash lines will disappear.)
- YOUR OVEN MUST BE ON A GROUNDED, POLARIZED CIRCUIT.**

IF ROOM LIGHTS DIM OR PULSE DIMMER, THEN BRIGHTER WHEN THE OVEN IS IN USE:

- Is the microwave oven on a separate circuit? (Review grounding instructions on page 4.)

IF THE TEMPERATURE PROBE APPEARS NOT TO FUNCTION CORRECTLY:

- Is the probe plug securely inserted into the receptacle?
- Is the food you're attempting to heat already hotter than the temperature you've programmed?
- Is the food completely defrosted?
- Has the probe been accidentally left in the oven when cooking by a method other than temperature cooking or when not monitoring food temperature? The probe could be damaged if left in oven when not plugged into food and oven wall receptacle.

IF FOOD IS OVERCOOKED:

- Did you remember to program the correct cooking power level? (Review instructions in programming section.)

IF FOOD IS UNDERCOOKED

- Are there other energy-consuming appliances on the same circuit as the microwave oven? (Review grounding instructions, page 4.)
- Is the line voltage to your home low or lower than usual? (The power company in your area should be able to tell you if there is low voltage to your home.)
- Did you remember to program the correct cooking power level? (Review instructions in programming section.)

## WHEN SERVICE IS REQUIRED

Call the nearest authorized service agency. (The dealer from whom you purchased your microwave oven can give you the name of your authorized Amana Service Center.) Help them give you prompt service by providing:

1. An accurate description of the trouble.
2. Complete model and serial numbers. (See front cover.)
3. Date of installation. (We also suggest you retain your sales receipt.)

Remember, repair by an unauthorized service person that results in subsequent failure will void the warranty promise. Amana has a large network of Authorized Service Centers in the U.S. However, if you should have a service problem that is not resolved locally,

Write:

Customer Relations Department  
AMANA REFRIGERATION, INC.  
Amana, Iowa 52204

Or dial: (319) 622-5511 Monday through Friday (8 a.m.-4:30 p.m., Central Time Zone) and ask for Customer Relations.

**Amana™  
Asure**  
EXTENDED SERVICE PLAN

Amana is pleased to offer an important opportunity for long-term service protection on your new Amana appliance. The Amana Asure Extended Service Plan is specially designed to supplement the strong warranty that already accompanies your appliance, and it combines with this standard warranty to provide budget-protecting coverage on your appliance for up to five full years, covering parts, labor and travel charges. Your participating Amana dealer has details. Or contact us!

Amana Refrigeration, Inc.  
Customer Service Department  
Amana, IA 52204  
(319) 622-5511  
Monday through Friday  
(8 a.m.-4:30 p.m., Central Time Zone)

1-800-843-0304

---



TOLL-FREE

*Amana*®

Information on product usage, installation, warranty and dealer/service can be obtained through the toll-free number.

## Free Manuals Download Website

<http://myh66.com>

<http://usermanuals.us>

<http://www.somanuals.com>

<http://www.4manuals.cc>

<http://www.manual-lib.com>

<http://www.404manual.com>

<http://www.luxmanual.com>

<http://aubethermostatmanual.com>

Golf course search by state

<http://golfingnear.com>

Email search by domain

<http://emailbydomain.com>

Auto manuals search

<http://auto.somanuals.com>

TV manuals search

<http://tv.somanuals.com>